



## MEASUREMENT REPORT

---

**FCC ID** : RWO-RZ010466

**APPLICANT** : Razer Inc.

**Product** : Gaming Mouse

**Model No.** : RZ01-0466

**Series Model No.** RZ01-0466XXXX-XXXX(X can be 0-9 or A-Z)

**Brand Name** : RAZER

**Trademark** : RAZER , 

**FCC Classification** : (DTS) Digital Transmission System

**FCC Rule Part(s)** : Part 15.247

**Test Procedure(s)** : ANSI C63.10-2013

**Received Date** : March 28 ,2023

**Test Date** : March 30 ~ April 7,2023

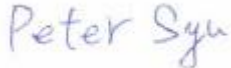
**Tested By** :   
( Peter Syu )

**Reviewed By** :   
( Paddy Chen )

**Approved By** :   
( Chenz Ker )



The test results only relate to the tested sample.

This equipment has been shown to be capable of compliance with the applicable technical standards as indicated in the measurement report and was tested in accordance with the measurement procedures specified in ANSI C63.10-2013. Test results reported herein relate only to the item(s) tested.

The test report shall not be reproduced except in full without the written approval of MRT Technology (Taiwan) Co., Ltd.

---

## Revision History

| Report No.    | Version | Description     | Issue Date | Note |
|---------------|---------|-----------------|------------|------|
| 2303TWE917-U2 | 1.0     | Original Report | 2023-04-17 |      |

## CONTENTS

| Description                                                 | Page      |
|-------------------------------------------------------------|-----------|
| <b>§2.1033 General Information .....</b>                    | <b>5</b>  |
| <b>1. INTRODUCTION .....</b>                                | <b>6</b>  |
| 1.1. Scope.....                                             | 6         |
| 1.2. MRT Test Location.....                                 | 6         |
| <b>2. PRODUCT INFORMATION .....</b>                         | <b>7</b>  |
| 2.1. Equipment Description .....                            | 7         |
| 2.2. Product Specification Subjective to this Standard..... | 8         |
| 2.3. Test Mode.....                                         | 8         |
| 2.4. Operation Frequency / Channel List.....                | 9         |
| 2.5. Test Configuration.....                                | 10        |
| 2.6. Test Software.....                                     | 10        |
| 2.7. EMI Suppression Device(s)/Modifications .....          | 10        |
| 2.8. Labeling Requirements .....                            | 10        |
| <b>3. DESCRIPTION of TEST .....</b>                         | <b>11</b> |
| 3.1. Evaluation Procedure.....                              | 11        |
| 3.2. AC Line Conducted Emissions .....                      | 11        |
| 3.3. Radiated Emissions .....                               | 12        |
| <b>4. ANTENNA REQUIREMENTS.....</b>                         | <b>13</b> |
| <b>5. TEST EQUIPMENT CALIBRATION DATE.....</b>              | <b>14</b> |
| <b>6. MEASUREMENT UNCERTAINTY.....</b>                      | <b>15</b> |
| <b>7. TEST RESULT .....</b>                                 | <b>16</b> |
| 7.1. Summary.....                                           | 16        |
| 7.2. 6dB Bandwidth Measurement .....                        | 17        |
| 7.2.1. Test Limit.....                                      | 17        |
| 7.2.2. Test Procedure used .....                            | 17        |
| 7.2.3. Test Setting .....                                   | 17        |
| 7.2.4. Test Setup .....                                     | 17        |
| 7.2.5. Test Result .....                                    | 18        |
| 7.3. Output Power Measurement.....                          | 19        |
| 7.3.1. Test Limit.....                                      | 19        |
| 7.3.2. Test Procedure Used.....                             | 19        |
| 7.3.3. Test Setting .....                                   | 19        |
| 7.3.4. Test Setup .....                                     | 19        |
| 7.3.5. Test Result of Output Power .....                    | 20        |
| 7.4. Power Spectral Density Measurement .....               | 21        |
| 7.4.1. Test Limit.....                                      | 21        |
| 7.4.2. Test Procedure Used.....                             | 21        |
| 7.4.3. Test Setting .....                                   | 21        |
| 7.4.4. Test Setup .....                                     | 21        |
| 7.4.5. Test Result .....                                    | 22        |

---

|           |                                                            |           |
|-----------|------------------------------------------------------------|-----------|
| 7.5.      | Out-of-Band Spurious Emissions Emissions Measurement ..... | 23        |
| 7.5.1.    | Test Limit .....                                           | 23        |
| 7.5.2.    | Test Procedure Used .....                                  | 23        |
| 7.5.3.    | Test Settiting .....                                       | 23        |
| 7.5.4.    | Test Setup .....                                           | 23        |
| 7.5.5.    | Test Result .....                                          | 24        |
| 7.6.      | Radiated Spurious Emission Measurement.....                | 27        |
| 7.6.1.    | Test Limit .....                                           | 27        |
| 7.6.2.    | Test Procedure Used.....                                   | 27        |
| 7.6.3.    | Test Setting .....                                         | 27        |
| 7.6.4.    | Test Setup .....                                           | 29        |
| 7.6.5.    | Test Result .....                                          | 31        |
| 7.7.      | Radiated Restricted Band Edge Measurement.....             | 45        |
| 7.7.1.    | Test Limit .....                                           | 45        |
| 7.7.2.    | Test Procedure Used.....                                   | 45        |
| 7.7.3.    | Test Setting .....                                         | 45        |
| 7.7.4.    | Test Setup .....                                           | 47        |
| 7.7.5.    | Test Result .....                                          | 48        |
| 7.8.      | AC Conducted Emissions Measurement .....                   | 60        |
| 7.8.1.    | Test Limit .....                                           | 60        |
| 7.8.2.    | Test Setup .....                                           | 60        |
| 7.8.3.    | Test Result .....                                          | 61        |
| <b>8.</b> | <b>CONCLUSION .....</b>                                    | <b>62</b> |
|           | <b>Appendix A : Test Photograph .....</b>                  | <b>63</b> |
|           | <b>Appendix B : External Photograph.....</b>               | <b>63</b> |
|           | <b>Appendix C : Internal Photograph .....</b>              | <b>63</b> |

## §2.1033 General Information

|                                 |                                                                                                                                  |
|---------------------------------|----------------------------------------------------------------------------------------------------------------------------------|
| <b>Applicant</b>                | Razer Inc.                                                                                                                       |
| <b>Applicant Address</b>        | 9 Pasteur, Suite 100, Irvine, CA92618, USA                                                                                       |
| <b>Manufacturer</b>             | Razer (Asia-Pacific) Pte.,Ltd.                                                                                                   |
| <b>Manufacturer Address</b>     | 1 one-north Crescent, #02-01 Singapore 138538                                                                                    |
| <b>Test Site</b>                | MRT Technology (Taiwan) Co., Ltd                                                                                                 |
| <b>Test Site Address</b>        | No. 38, Fuxing Second Rd., Guishan Dist., Taoyuan City 333, Taiwan (R.O.C)                                                       |
| <b>MRT FCC Registration No.</b> | 291082                                                                                                                           |
| <b>FCC Rule Part(s)</b>         | Part 15.247                                                                                                                      |
| <b>Test Device Serial No.</b>   | #1-1 <input type="checkbox"/> Production <input checked="" type="checkbox"/> Pre-Production <input type="checkbox"/> Engineering |

### Test Facility / Accreditations

1. MRT facility is a FCC registered (Reg. No. 291082) test facility with the site description report on file and is designated by the FCC as an Accredited Test Firm.
2. MRT facility is an IC registered (MRT Reg. No. 21723) test laboratory with the site description on file at Industry Canada.
3. MRT Lab is accredited to ISO 17025 by the Taiwan Accreditation Foundation (TAF Cert. No. 3261) in EMC, Telecommunications and Radio testing for FCC (Designation Number: TW3261), Industry Canada, EU and TELEC Rules.

# 1. INTRODUCTION

## 1.1. Scope

Measurement and determination of electromagnetic emissions (EMC) of radio frequency devices including intentional and/or unintentional radiators for compliance with the technical rules and regulations of the Federal Communications Commission and the Industry Canada Certification and Engineering Bureau.

## 1.2. MRT Test Location

The map below shows the location of the MRT LABORATORY, its proximity to the Taoyuan City. These measurement tests were conducted at the MRT Technology (Taiwan) Co., Ltd. Facility located at No.38, Fuxing 2nd Rd., Guishan Dist., Taoyuan City 33377, Taiwan (R.O.C).

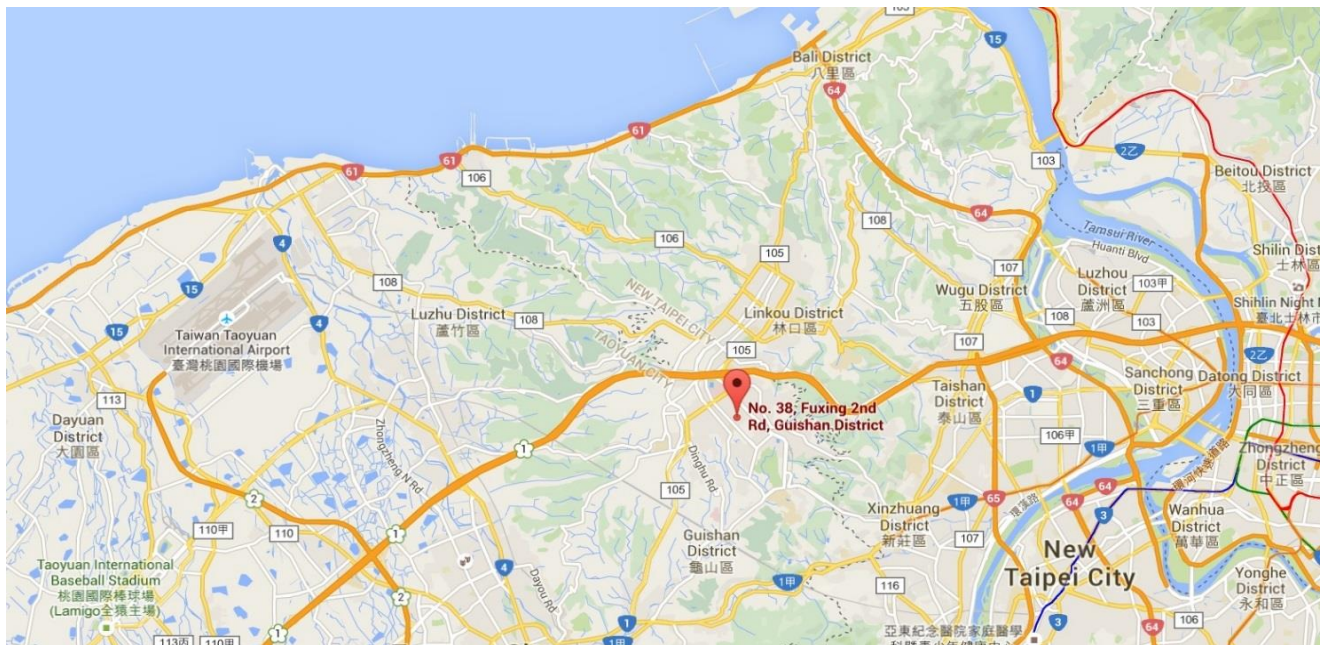

## 2. PRODUCT INFORMATION

### 2.1. Equipment Description

|                                   |                                                         |
|-----------------------------------|---------------------------------------------------------|
| Product Name                      | Gaming Mouse                                            |
| Model No.                         | RZ01-0466                                               |
| Series Model No.                  | RZ01-0466XXXX-XXXX(X can be 0-9 or A-Z)                 |
| Support Specification             | <b>WPAN:</b><br>Bluetooth Single Mode: V5.0<br>SRD 2.4G |
| Accessories                       |                                                         |
| USB-A to USB-C<br>Speedflex cable | Brand: RAZER<br>Model No: RZ01-0466                     |
| USB dongle adapter                | Brand: RAZER<br>Model No: RZ01-0466                     |
| Wireless USB dongle               | Brand: RAZER<br>Model No: DGRFG7                        |

Note:

Model Differences: The system's model name is RZ01-0466XXXX-XXXX (X: Can be 0-9, A-Z), and the system contains a Gaming Mouse (Model name:RZ01-0466) and USB Dongle (Model name: DGRFG7)

## 2.2. Product Specification Subjective to this Standard

|                     |              |
|---------------------|--------------|
| Operating Frequency | 2402~2480MHz |
| Specification       | SRD 2.4GHz   |
| Type of modulation  | GFSK         |
| Data Rate           | 2Mbps        |
| Maximum Power       | 4.58dBm      |

## 2.3. Test Mode

|           |                                 |
|-----------|---------------------------------|
| Test Mode | Mode 1: Transmit – 2Mbps (GFSK) |
|-----------|---------------------------------|

Note: Regarding to the operation frequency, the lowest, middle and highest frequency are selected to perform the test.



## 2.4. Operation Frequency / Channel List

| Channel | Frequency | Channel | Frequency | Channel | Frequency |
|---------|-----------|---------|-----------|---------|-----------|
| 00      | 2402      | 27      | 2429      | 54      | 2456      |
| 01      | 2403      | 28      | 2430      | 55      | 2457      |
| 02      | 2404      | 29      | 2431      | 56      | 2458      |
| 03      | 2405      | 30      | 2432      | 57      | 2459      |
| 04      | 2406      | 31      | 2433      | 58      | 2460      |
| 05      | 2407      | 32      | 2434      | 59      | 2461      |
| 06      | 2408      | 33      | 2435      | 60      | 2462      |
| 07      | 2409      | 34      | 2436      | 61      | 2463      |
| 08      | 2410      | 35      | 2437      | 62      | 2464      |
| 09      | 2411      | 36      | 2438      | 63      | 2465      |
| 10      | 2412      | 37      | 2439      | 64      | 2466      |
| 11      | 2413      | 38      | 2440      | 65      | 2467      |
| 12      | 2414      | 39      | 2441      | 66      | 2468      |
| 13      | 2415      | 40      | 2442      | 67      | 2469      |
| 14      | 2416      | 41      | 2443      | 68      | 2470      |
| 15      | 2417      | 42      | 2444      | 69      | 2471      |
| 16      | 2418      | 43      | 2445      | 70      | 2472      |
| 17      | 2419      | 44      | 2446      | 71      | 2473      |
| 18      | 2420      | 45      | 2447      | 72      | 2474      |
| 19      | 2421      | 46      | 2448      | 73      | 2475      |
| 20      | 2422      | 47      | 2449      | 74      | 2476      |
| 21      | 2423      | 48      | 2450      | 75      | 2477      |
| 22      | 2424      | 49      | 2451      | 76      | 2478      |
| 23      | 2425      | 50      | 2452      | 77      | 2479      |
| 24      | 2426      | 51      | 2453      | 78      | 2480      |
| 25      | 2427      | 52      | 2454      |         |           |
| 26      | 2428      | 53      | 2455      |         |           |

## **2.5. Test Configuration**

This device was tested per the guidance of ANSI C63.10-2013. ANSI C63.10-2013 was used to reference the appropriate EUT setup for radiated spurious emissions testing and AC line conducted testing.

## **2.6. Test Software**

The test utility software used during testing was “Click to execute”.

## **2.7. EMI Suppression Device(s)/Modifications**

No EMI suppression device(s) were added and/or no modifications were made during testing.

## **2.8. Labeling Requirements**

Per 2.1074 & 15.19; Docket 95-19

The label shall be permanently affixed at a conspicuous location on the device; instruction manual or pamphlet supplied to the user and be readily visible to the purchaser at the time of purchase. However, when the device is so small wherein placement of the label with specified statement is not practical, only the FCC ID must be displayed on the device per Section 15.19(a)(5). Please see attachment for FCC ID label and label location.

### 3. DESCRIPTION of TEST

#### 3.1. Evaluation Procedure

The measurement procedures described in the American National Standard for Testing Unlicensed Wireless Devices (ANSI C63.10-2013), and the guidance provided in KDB 558074 D01v05r02 were used in the measurement of the **Gaming Mouse**.

**Deviation from measurement procedure.....None**

#### 3.2. AC Line Conducted Emissions

The line-conducted facility is located inside an 9'x4'x3' shielded enclosure. A 1m x 2m wooden table 80cm high is placed 40cm away from the vertical wall and 80cm away from the sidewall of the shielded room. Two 10kHz-30MHz, 50Ω/50uH Line-Impedance Stabilization Networks (LISNs) are bonded to the shielded room floor. Power to the LISNs is filtered by external high-current high-insertion loss power line filters. These filters attenuate ambient signal noise from entering the measurement lines. These filters are also bonded to the shielded enclosure.

The EUT is powered from one LISN and the support equipment is powered from the second LISN. All interconnecting cables more than 1 meter were shortened to a 1 meter length by non-inductive bundling (serpentine fashion) and draped over the back edge of the test table. All cables were at least 40cm above the horizontal reference ground-plane. Power cables for support equipment were routed down to the second LISN while ensuring that that cables were not draped over the second LISN.

Sufficient time for the EUT, support equipment, and test equipment was allowed in order for them to warm up to their normal operating condition. The RF output of the LISN was connected to the receiver and exploratory measurements were made to determine the frequencies producing the maximum emission from the EUT. The receiver was scanned from 150kHz to 30MHz. The detector function was set to peak mode for exploratory measurements while the bandwidth of the analyzer was set to 9kHz. The EUT, support equipment, and interconnecting cables were arranged and manipulated to maximize each emission. Each emission was also maximized by varying: power lines, the mode of operation or data exchange speed, or support equipment which determined the worst-case emission. Once the worst case emissions have been identified, the one EUT cable configuration/arrangement and mode of operation that produced these emissions are used for final measurements on the same test site. The analyzer is set to CISPR quasi-peak and average detectors with a 9kHz resolution bandwidth for final measurements.

An extension cord was used to connect to a single LISN which powered by EUT. The extension cord was calibrated with LISN, the impedance and insertion loss are compliance with the requirements as stated in ANSI C63.10-2013.

Line conducted emissions test results are shown in Section 7.8.

### 3.3. Radiated Emissions

The radiated test facilities consisted of an indoor 3 meter semi-anechoic chamber used for final measurements and exploratory measurements, when necessary. The measurement area is contained within the semi-anechoic chamber which is shielded from any ambient interference. For measurements above 1GHz absorbers are arranged on the floor between the turn table and the antenna mast in such a way so as to maximize the reduction of reflections. For measurements below 1GHz, the absorbers are removed. A MF Model 210SS turntable is used for radiated measurement. It is a continuously rotatable, remote controlled, metallic turntable and 2 meters (6.56 ft.) in diameter. The turn table is flush with the raised floor of the chamber in order to maintain its function as a ground plane. An 80cm high PVC support structure is placed on top of the turntable.

For all measurements, the spectrum was scanned through all EUT azimuths and from 1 to 4 meter receive antenna height using a broadband antenna from 30MHz up to the upper frequency shown in 15.33(b)(1) depending on the highest frequency generated or used in the device or on which the device operates or tunes. For frequencies above 1GHz, linearly polarized double ridge horn antennas were used. For frequencies below 30MHz, a calibrated loop antenna was used. When exploratory measurements were necessary, they were performed at 1 meter test distance inside the semi-anechoic chamber using broadband antennas, broadband amplifiers, and spectrum analyzers to determine the frequencies and modes producing the maximum emissions. Sufficient time for the EUT, support equipment, and test equipment was allowed in order for them to warm up to their normal operating condition. The test set-up for frequencies below 1GHz was placed on top of the 0.8 meter high, 1 x 1.5 meter table; and test set-up for frequencies 1-40GHz was placed on top of the 1.5 meter high, 1 x 1.5 meter table. The EUT, support equipment, and interconnecting cables were arranged and manipulated to maximize each emission. Appropriate precaution was taken to ensure that all emissions from the EUT were maximized and investigated. The system configuration, clock speed, mode of operation or video resolution, if applicable, turntable azimuth, and receive antenna height was noted for each frequency found.

Final measurements were made in the semi-anechoic chamber using calibrated, linearly polarized broadband and horn antennas. The test setup was configured to the setup that produced the worst case emissions. The spectrum analyzer was set to investigate all frequencies required for testing to compare the highest radiated disturbances with respect to the specified limits. The turntable containing the EUT was rotated through 360 degrees and the height of the receive antenna was varied 1 to 4 meters and stopped at the azimuth and height producing the maximum emission. Each emission was maximized by changing the orientation of the EUT through three orthogonal planes and changing the polarity of the receive antenna, which produced the worst-case emissions. According to 3dB Beam-Width of horn antenna, the horn antenna should be always directed to the EUT when rising height.

Radiated emissions test results are shown in Section 7.6 & 7.7 .

## 4. ANTENNA REQUIREMENTS

### Excerpt from §15.203 of the FCC Rules/Regulations:

“An intentional radiator antenna shall be designed to ensure that no antenna other than that furnished by the responsible party can be used with the device. The use of a permanently attached antenna or of an antenna that uses a unique coupling to the intentional radiator shall be considered sufficient to comply with the provisions of this section.”

- The antenna of the **Gaming Mouse**, is permanently attached.
- There are no provisions for connection to an external antenna.

### **Conclusion:**

The EUT unit complies with the requirement of §15.203.

#### Antenna List

| No. | Manufacturer | Part No.  | Antenna Type   | Peak Gain |
|-----|--------------|-----------|----------------|-----------|
| 1   | Razer        | RZ01-0466 | Metal stamping | 0.36dBi   |

## 5. TEST EQUIPMENT CALIBRATION DATE

### Conducted Emissions – SR2

| Instrument         | Manufacturer | Type No.                    | Asset No.   | Cali. Interval | Cali. Due Date |
|--------------------|--------------|-----------------------------|-------------|----------------|----------------|
| Two-Line V-Network | R&S          | ENV216                      | MRTTWA00020 | 1 year         | 2023/4/20      |
| Cable              | Rosnol       | N1C50-RG400-B<br>1C50-500CM | MRTTWE00013 | 1 year         | 2023/6/19      |
| EMI Test Receiver  | R&S          | ESR3                        | MRTTWA00009 | 1 year         | 2023/3/9       |

### Radiated Emissions – AC1

| Instrument               | Manufacturer | Type No.                  | Asset No.   | Cali. Interval | Cali. Due Date |
|--------------------------|--------------|---------------------------|-------------|----------------|----------------|
| Broadband TRILOG Antenna | SCHWARZBECK  | VULB 9162                 | MRTTWA00001 | 1 year         | 2023/12/21     |
| EMI Test Receiver        | R&S          | ESR3                      | MRTTWA00009 | 1 year         | 2024/3/8       |
| Active Loop Antenna      | Schwarzbeck  | FMZB 1519B                | MRTTWA00002 | 1 year         | 2023/5/24      |
| Broadband Horn antenna   | SCHWARZBECK  | BBHA 9120D                | MRTTWA00003 | 1 year         | 2024/3/24      |
| Breitband Hornantenna    | Schwarzbeck  | BBHA 9170                 | MRTTWA00004 | 1 year         | 2023/3/29      |
| Broadband Amplifier      | Schwarzbeck  | BBV 9721                  | MRTTWA00006 | 1 year         | 2024/3/27      |
| Broadband Preampfier     | SCHWARZBECK  | BBV 9718                  | MRTTWA00005 | 1 year         | 2024/3/20      |
| Signal Analyzer          | R&S          | FSV40                     | MRTTWA00007 | 1 year         | 2024/3/24      |
| Cable                    | HUBERSUHNER  | SF106                     | MRTTWE00010 | 1 year         | 2023/5/23      |
| Cable                    | Rosnol       | K1K50-UP0264-<br>K1K50-4M | MRTTWE00012 | 1 year         | 2023/6/19      |

### Conducted Test Equipment – SR5

| Instrument                | Manufacturer | Type No. | Asset No.   | Cali. Interval | Cali. Due Date |
|---------------------------|--------------|----------|-------------|----------------|----------------|
| EXA Signal Analyzer       | KEYSIGHT     | N9010A   | MRTTWA00012 | 1 year         | 2023/10/5      |
| EXA Signal Analyzer       | KEYSIGHT     | N9010B   | MRTTWA00074 | 1 year         | 2023/7/19      |
| USB Wideband Power Sensor | KEYSIGHT     | U2021XA  | MRTTWA00015 | 1 year         | 2024/3/16      |

### Test Software

| Software | Version   | Function          |
|----------|-----------|-------------------|
| e3       | 9.160520a | EMI Test Software |
| EMI      | V3        | EMI Test Software |

## 6. MEASUREMENT UNCERTAINTY

Where relevant, the following test uncertainty levels have been estimated for tests performed on the EUT as specified in CISPR 16-4-2. This uncertainty represents an expanded uncertainty expressed at approximately the 95% confidence level using a coverage factor of  $k = 2$ .

|                                                                                                                                                                                                                     |
|---------------------------------------------------------------------------------------------------------------------------------------------------------------------------------------------------------------------|
| <b>Conducted Emission- Power Line</b>                                                                                                                                                                               |
| Measuring Uncertainty for a Level of Confidence of 95% ( $U=2Uc(y)$ ):<br>0.15MHz~30MHz: $\pm 2.53\text{dB}$                                                                                                        |
| <b>Radiated Spurious Emission</b>                                                                                                                                                                                   |
| Measuring Uncertainty for a Level of Confidence of 95% ( $U=2Uc(y)$ ):<br>9kHz~30MHz: $\pm 3.92\text{dB}$<br>30MHz~1GHz: $\pm 4.25\text{dB}$<br>1GHz~18GHz: $\pm 4.40\text{dB}$<br>18GHz~40GHz: $\pm 4.45\text{dB}$ |
| <b>Frequency Error</b>                                                                                                                                                                                              |
| Measuring Uncertainty for a Level of Confidence of 95% ( $U=2Uc(y)$ ): $\pm 78.4\text{Hz}$                                                                                                                          |
| <b>Conducted Power</b>                                                                                                                                                                                              |
| Measuring Uncertainty for a Level of Confidence of 95% ( $U=2Uc(y)$ ): $\pm 0.84\text{dB}$                                                                                                                          |
| <b>Conducted Spurious Emission</b>                                                                                                                                                                                  |
| Measuring Uncertainty for a Level of Confidence of 95% ( $U=2Uc(y)$ ): $\pm 2.65\text{ dB}$                                                                                                                         |
| <b>Occupied Bandwidth</b>                                                                                                                                                                                           |
| Measuring Uncertainty for a Level of Confidence of 95% ( $U=2Uc(y)$ ): $\pm 3.3\%$                                                                                                                                  |
| <b>Temp. / Humidity</b>                                                                                                                                                                                             |
| Measuring Uncertainty for a Level of Confidence of 95% ( $U=2Uc(y)$ ): $\pm 0.82^\circ\text{C}/ \pm 3\%$                                                                                                            |
| <b>DC Voltage</b>                                                                                                                                                                                                   |
| Measuring Uncertainty for a Level of Confidence of 95% ( $U=2Uc(y)$ ): $\pm 0.3\%$                                                                                                                                  |

## 7. TEST RESULT

### 7.1. Summary

**Product Name:** Gaming Mouse

**FCC Classification:** (DTS) Digital Transmission System

| FCC Part Section(s) | Test Description                         | Test Limit                                                        | Test Condition    | Test Result | Reference   |
|---------------------|------------------------------------------|-------------------------------------------------------------------|-------------------|-------------|-------------|
| 15.247(a)(2)        | 6dB Bandwidth                            | $\geq 500\text{kHz}$                                              | Conducted         | Pass        | Section 7.2 |
| 15.247(b)(3)        | Output Power                             | $\leq 30.00\text{dBm}$                                            |                   | Pass        | Section 7.3 |
| 15.247(e)           | Power Spectral Density                   | $\leq 8.00\text{dBm}/3\text{kHz}$                                 |                   | Pass        | Section 7.4 |
| 15.247(d)           | Out-of-Band Emissions                    | Conducted $\geq 20\text{dBc}$                                     |                   | Pass        | Section 7.5 |
| 15.205<br>15.209    | Spurious Emission                        | < FCC 15.209 limits                                               | Radiated          | Pass        | Section 7.6 |
| 15.205<br>15.209    | Band Edge Measurement                    | $\cong 74\text{dBuV/m(Peak)}$<br>$\cong 54\text{dBuV/m(Average)}$ |                   | Pass        | Section 7.7 |
| 15.207              | AC Conducted Emissions<br>150kHz - 30MHz | < FCC 15.207 limits                                               | Line<br>Conducted | Pass        | Section 7.8 |

#### Notes:

- Determining compliance is based on the test results met the regulation limits or requirements declared by clients, and the test results don't take into account the value of measurement uncertainty.
- All modes of operation and data rates were investigated. For radiated emission test, every axis (X, Y, Z) was also verified when applicable. The test results shown in the following sections represent the worst case emissions.
- The analyzer plots shown in this section were all taken with a correction table loaded into the analyzer. The correction table was used to account for the losses of the cables and attenuators used as part of the system to connect the EUT to the analyzer at all frequencies of interest.
- All antenna port conducted emissions testing was performed on a test bench with the antenna port of the EUT connected to the spectrum analyzer through calibrated cables and attenuators.



## 7.2. 6dB Bandwidth Measurement

### 7.2.1. Test Limit

The minimum 6dB bandwidth shall be at least 500 kHz.

### 7.2.2. Test Procedure used

ANSI C63.10 - 2013 - Section 11.8

### 7.2.3. Test Setting

1. The Spectrum's automatic bandwidth measurement capability was used to perform the 6dB bandwidth measurement. The "X" dB bandwidth parameter was set to  $X = 6$ . The bandwidth measurement was not influenced by any intermediate power nulls in the fundamental emission.
2. Set RBW = 100 kHz
3.  $VBW \geq 3 \times RBW$
4. Detector = Peak
5. Trace mode = max hold
6. Sweep = auto couple
7. Allow the trace was allowed to stabilize

### 7.2.4. Test Setup

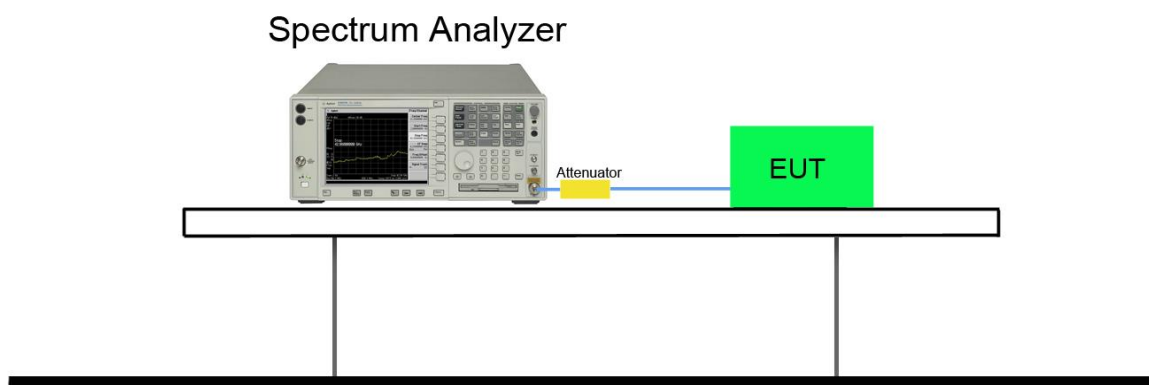

### 7.2.5. Test Result

| Test Mode | Channel No. | Frequency (MHz) | 6dB Bandwidth (MHz) | Limit (MHz) | Result |
|-----------|-------------|-----------------|---------------------|-------------|--------|
| 2.4GHz    | CH00        | 2402            | 1.150               | ≥ 0.5       | Pass   |
|           | CH39        | 2441            | 1.194               | ≥ 0.5       | Pass   |
|           | CH78        | 2480            | 1.029               | ≥ 0.5       | Pass   |

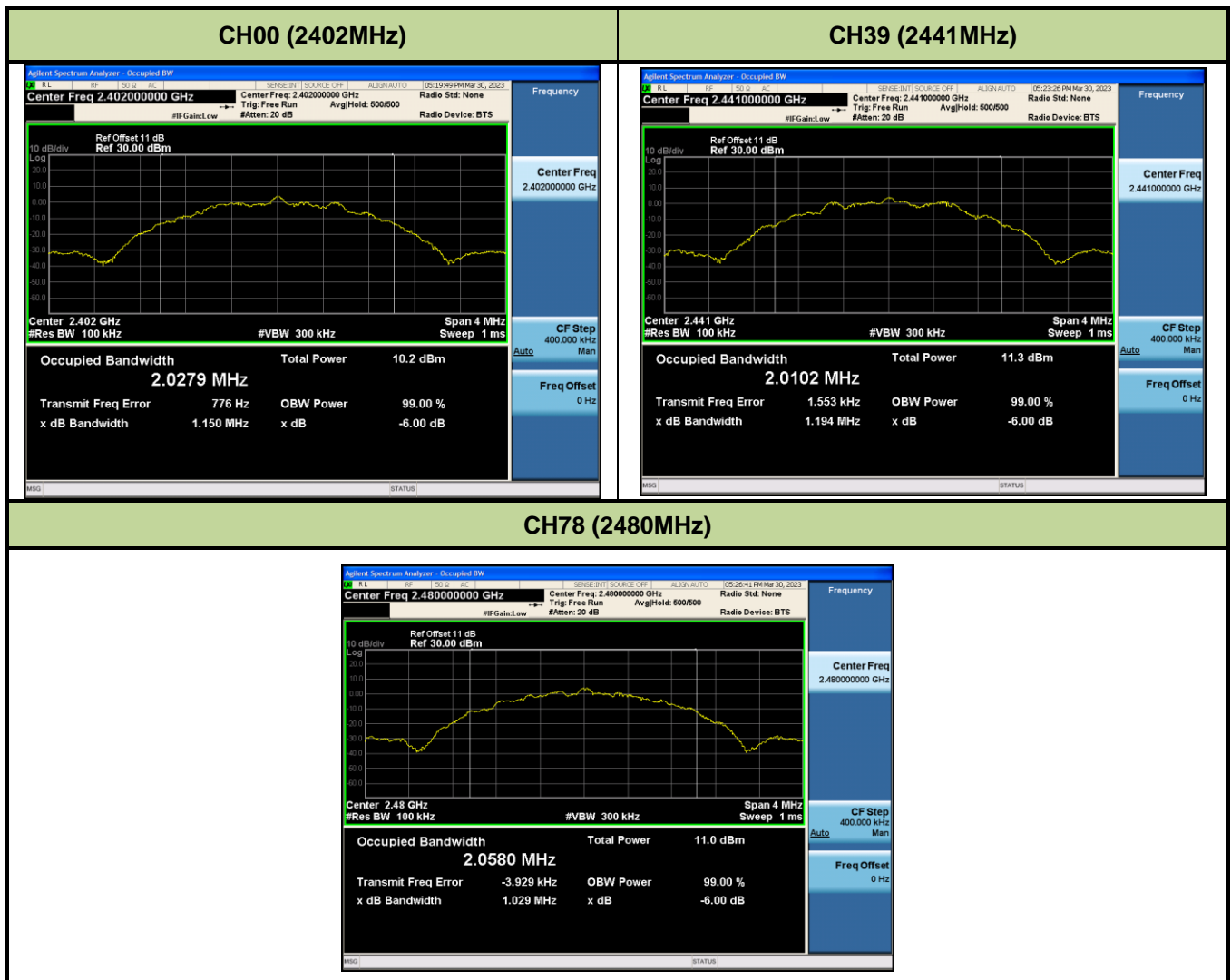

## 7.3. Output Power Measurement

### 7.3.1. Test Limit

The maximum out power shall be less 1 Watt (30dBm).

### 7.3.2. Test Procedure Used

ANSI C63.10 - 2013 - Section 11.9.1.3

ANSI C63.10 - 2013 - Section 11.9.2.3.2

### 7.3.3. Test Setting

#### Peak Power Measurement

The maximum peak conducted output power may be measured using a broadband peak RF power meter. The power meter shall have a video bandwidth that is greater than or equal to the DTS bandwidth and shall utilize a fast-responding diode detector.

#### Average Power Measurement

Average power measurements were performed only when the EUT was transmitting at its maximum power control level using a broadband power meter with a pulse sensor. The power meter implemented triggering and gating capabilities which were set up such that power measurements were recorded only during the ON time of the transmitter. The trace was averaged over 100 traces to obtain the final measured average power.

### 7.3.4. Test Setup

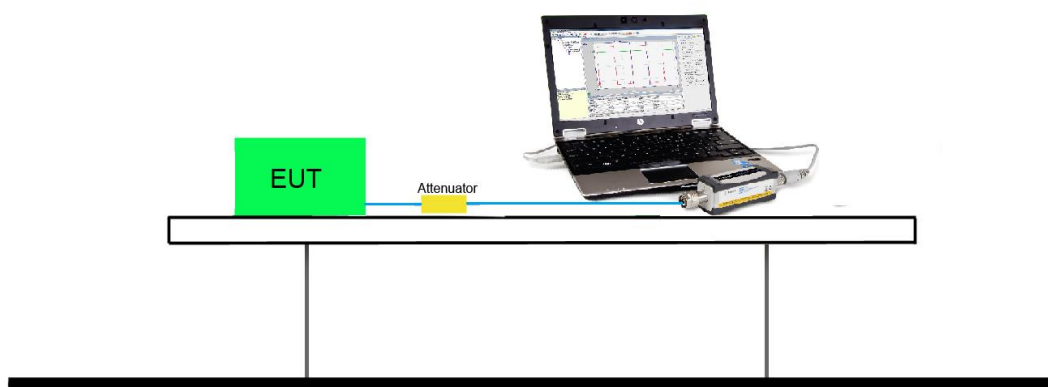

### 7.3.5. Test Result of Output Power

| Test Mode | Channel No. | Frequency (MHz) | Peak Power (dBm) | Peak Power Limit (dBm) |
|-----------|-------------|-----------------|------------------|------------------------|
| 2.4GHz    | CH00        | 2402            | 3.92             | < 30                   |
|           | CH39        | 2441            | 4.24             | < 30                   |
|           | CH78        | 2480            | 4.58             | < 30                   |

Note1: Output power =Reading value on power meter + cable loss.

## 7.4. Power Spectral Density Measurement

### 7.4.1. Test Limit

The maximum permissible power spectral density is 8dBm in any 3 kHz band.

### 7.4.2. Test Procedure Used

ANSI C63.10-2013 Section 11.10.2

### 7.4.3. Test Setting

This procedure shall be used if maximum peak conducted output power was used to demonstrate compliance, and is optional if the maximum conducted (average) output power was used to demonstrate compliance.

- a) Set analyzer center frequency to DTS channel center frequency.
- b) Set the span to 1.5 times the DTS bandwidth.
- c) Set the RBW to: 3 kHz.
- d) Set the VBW  $\geq 3^* \text{ RBW}$ .
- e) Detector = peak.
- f) Sweep time = auto couple.
- g) Trace mode = max hold.
- h) Allow trace to fully stabilize.
- i) Use the peak marker function to determine the maximum amplitude level within the RBW.

### 7.4.4. Test Setup

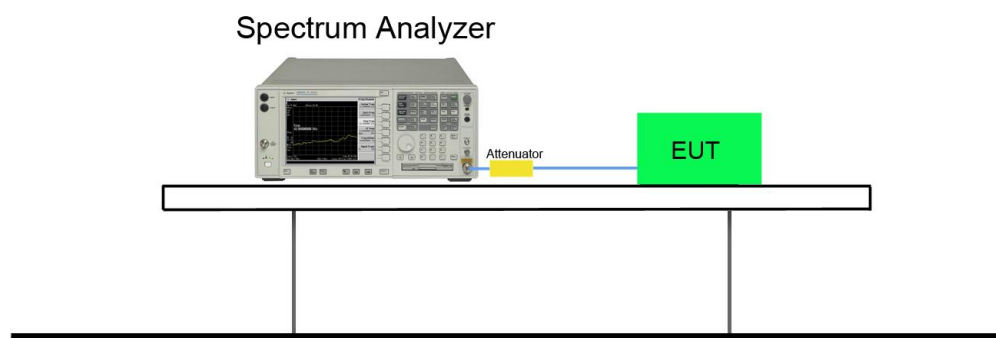

### 7.4.5. Test Result

| Test Mode | Channel No. | Frequency (MHz) | PSD (dBm / 3kHz) | Limit (dBm / 3kHz) | Result |
|-----------|-------------|-----------------|------------------|--------------------|--------|
| 2.4GHz    | CH00        | 2402            | -10.932          | ≤ 8                | Pass   |
|           | CH39        | 2441            | -11.274          | ≤ 8                | Pass   |
|           | CH78        | 2480            | -12.659          | ≤ 8                | Pass   |

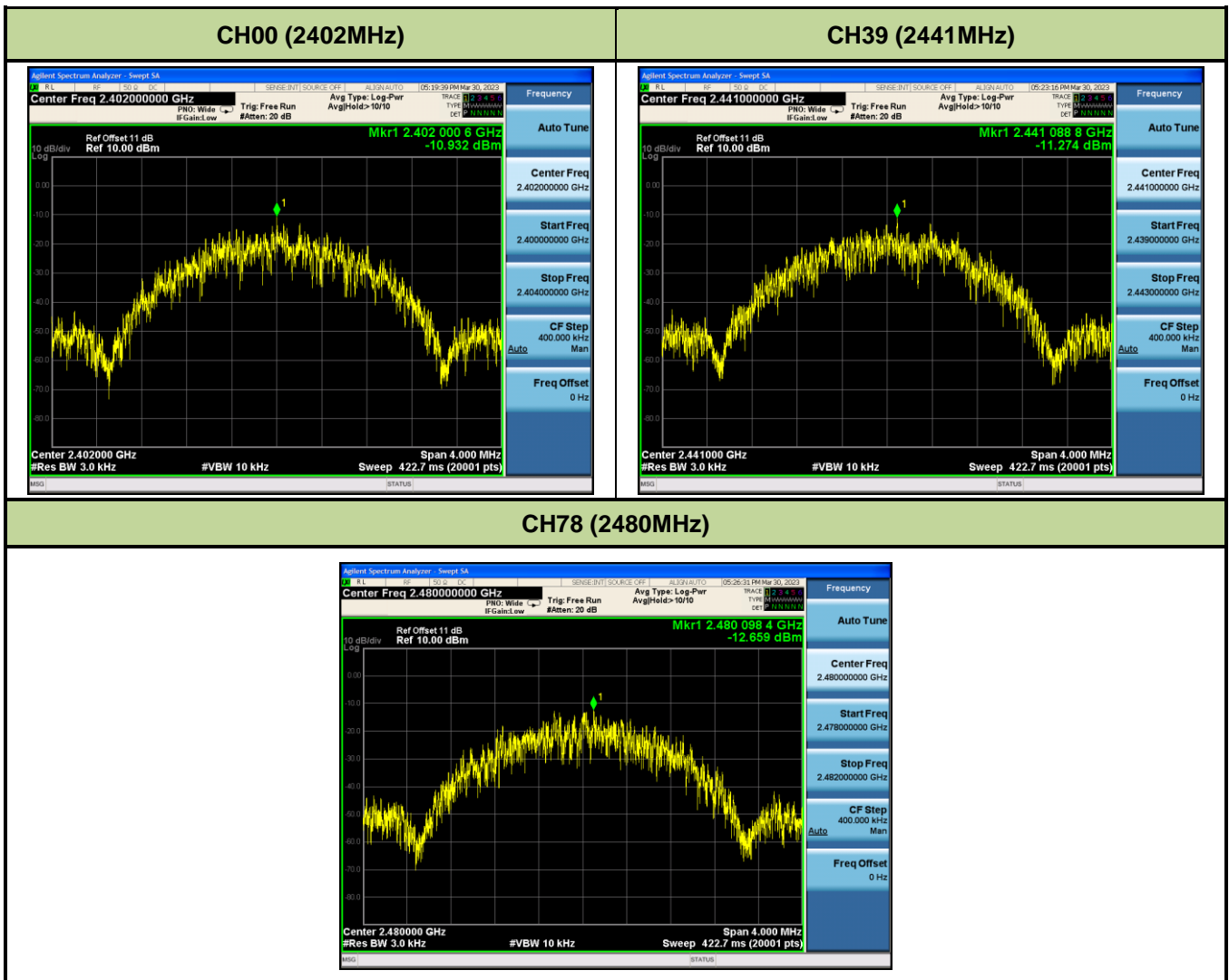

## 7.5. Out-of-Band Spurious Emissions Emissions Measurement

### 7.5.1. Test Limit

In any 100 kHz bandwidth outside the frequency band in which the spread spectrum or digitally modulated intentional radiator is operating, the radio frequency power that is produced by the intentional radiator shall be at least 20 dB below that in the 100 kHz bandwidth within the band that contains the highest level of the desired power, based on RF conducted measurement, provided the transmitter demonstrates compliance with the peak conducted power limits.

### 7.5.2. Test Procedure Used

ANSI C63.10-2013 Section 11.1 & 11.2

### 7.5.3. Test Setting

- (a) Set instrument center frequency to DTS channel center frequency
- (b) Set the span to  $\geq 1.5$  times the DTS bandwidth
- (c) Set the RBW = 100 kHz
- (d) Set the VBW  $\geq 3 \times$  RBW
- (e) Detector = peak
- (f) Sweep time = auto couple
- (g) Trace mode = max hold
- (h) Allow trace to fully stabilize

### 7.5.4. Test Setup

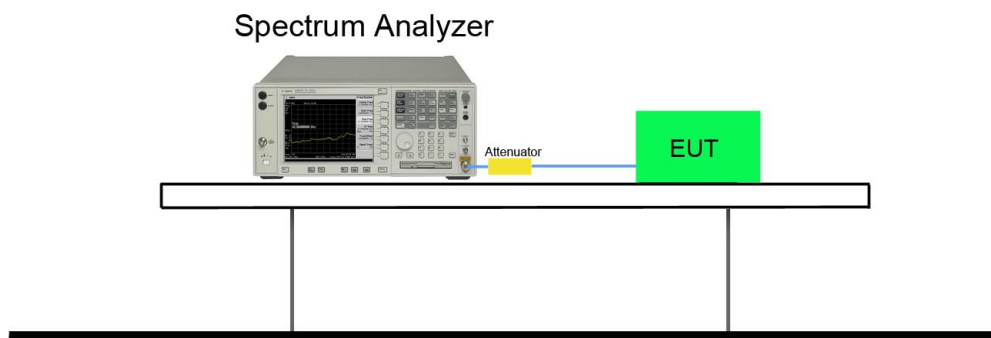

### 7.5.5. Test Result

| Test Mode | Channel No. | Frequency (MHz) | Limit | Result |
|-----------|-------------|-----------------|-------|--------|
| 2.4GHz    | CH00        | 2402            | 20dBc | Pass   |
|           | CH39        | 2441            | 20dBc | Pass   |
|           | CH78        | 2480            | 20dBc | Pass   |



### CH00 (2402MHz)

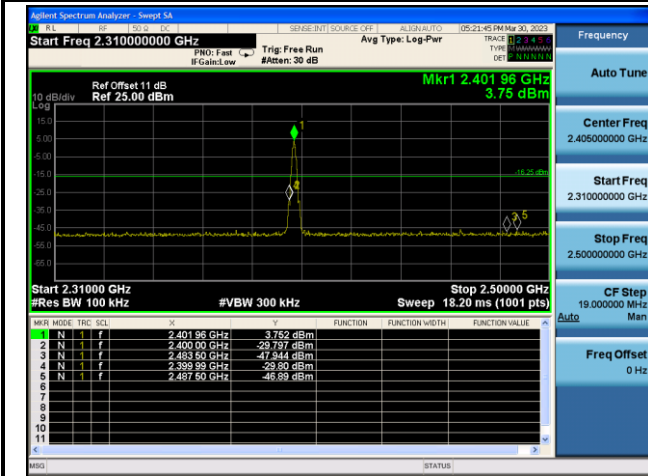

### CH00 (2402MHz)

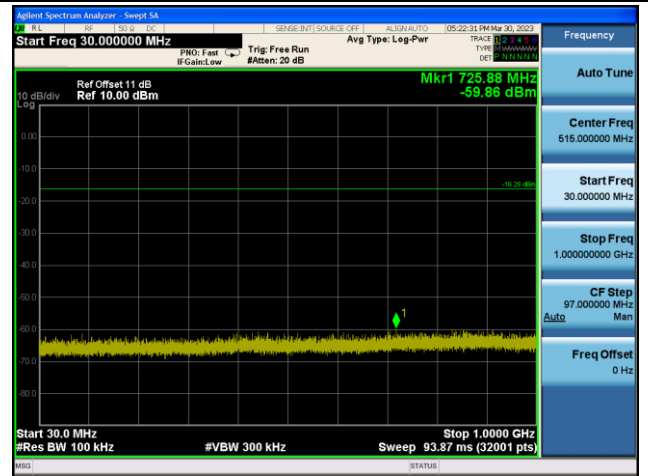

### CH00 (2402MHz)

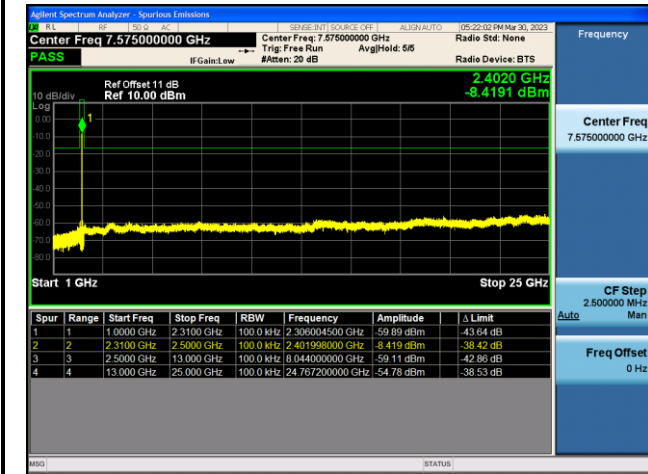

### CH39 (2441MHz)

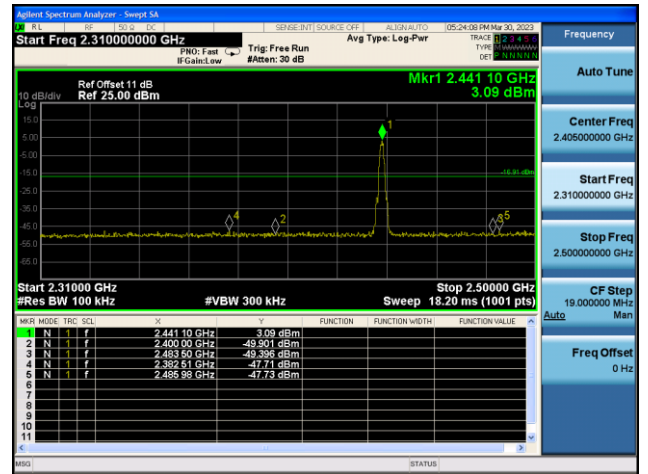

### CH39 (2441MHz)

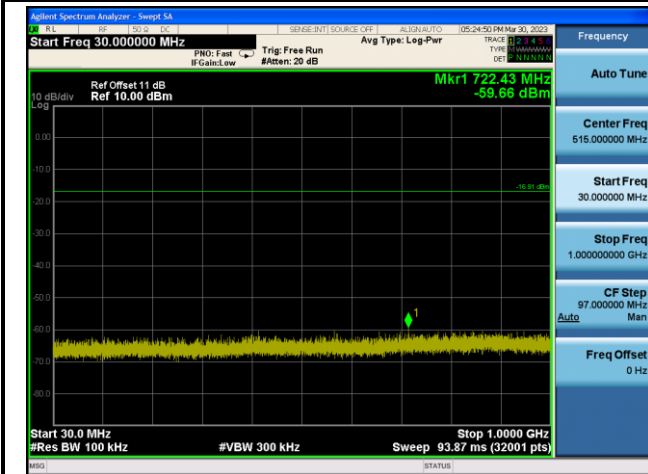

### CH39 (2441MHz)

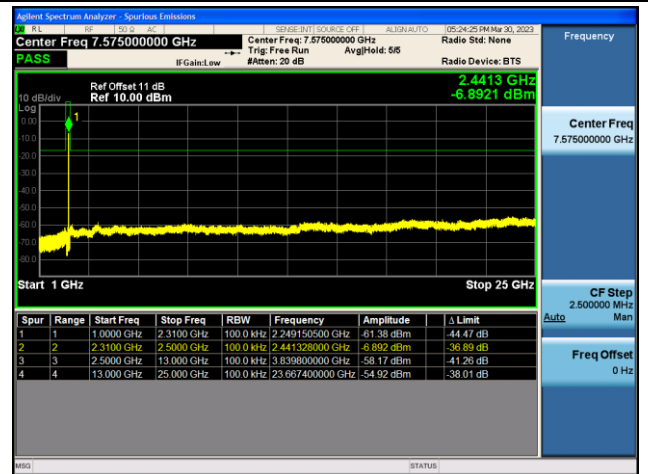

### CH78 (2480MHz)

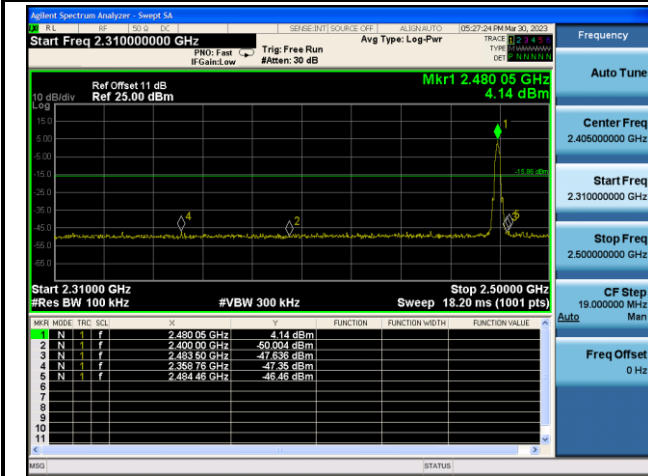

### CH78 (2480MHz)

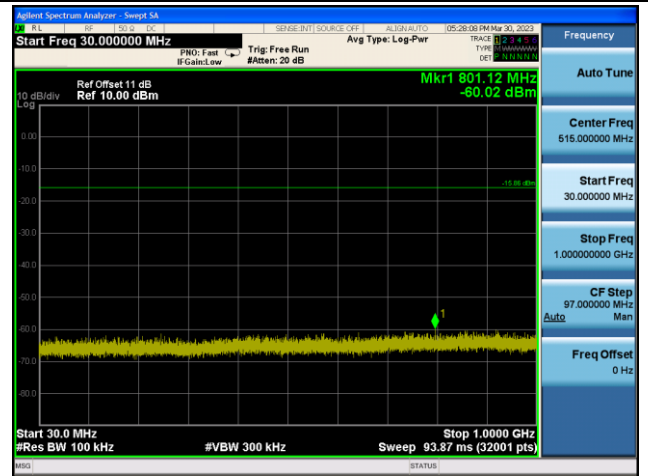

### CH78 (2480MHz)

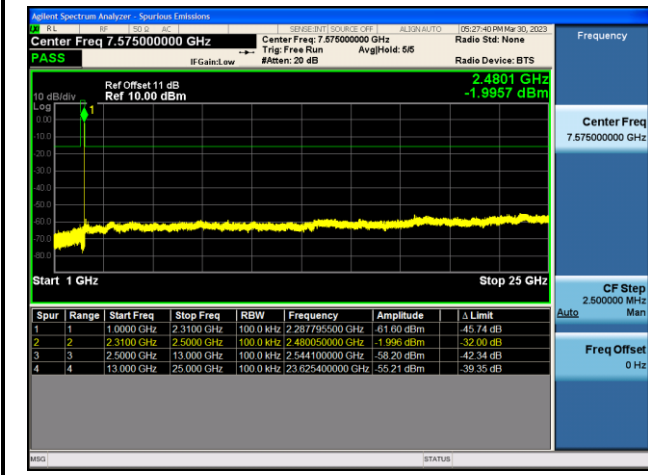

## 7.6. Radiated Spurious Emission Measurement

### 7.6.1. Test Limit

All out of band emissions appearing in a restricted band as specified in Section 15.205 of the Title 47 CFR must not exceed the limits shown in Table per Section 15.209.

| FCC Part 15 Subpart C Paragraph 15.209 |                      |                            |
|----------------------------------------|----------------------|----------------------------|
| Frequency [MHz]                        | Field Strength [V/m] | Measured Distance [Meters] |
| 0.009 - 0.490                          | 2400/F (kHz)         | 300                        |
| 0.490 - 1.705                          | 24000/F (kHz)        | 30                         |
| 1.705 - 30                             | 30                   | 30                         |
| 30 - 88                                | 100                  | 3                          |
| 88 - 216                               | 150                  | 3                          |
| 216 - 960                              | 200                  | 3                          |
| Above 960                              | 500                  | 3                          |

### 7.6.2. Test Procedure Used

ANSI C63.10 - 2013 - Section 11.11 & 11.12

ANSI C63.10 - 2013 - Section 6.3 (General Requirements)

ANSI C63.10 - 2013 - Section 6.4 (Standard test method below 30MHz)

ANSI C63.10 - 2013 - Section 6.5 (Standard test method above 30MHz to 1GHz)

ANSI C63.10 - 2013 - Section 6.6 (Standard test method above 1GHz)

### 7.6.3. Test Setting

#### Peak Field Strength Measurements

1. Analyzer center frequency was set to the frequency of the radiated spurious emission of interest
2. RBW = as specified in Table 1
3. VBW = 3MHz

4. Detector = peak
5. Sweep time = auto couple
6. Trace mode = max hold
7. Trace was allowed to stabilize

**Table 1 - RBW as a function of frequency**

| Frequency     | RBW           |
|---------------|---------------|
| 9 ~ 150 kHz   | 200 ~ 300 Hz  |
| 0.15 ~ 30 MHz | 9 ~ 10 kHz    |
| 30 ~ 1000 MHz | 100 ~ 120 kHz |
| > 1000 MHz    | 1 MHz         |

### **Average Field Strength Measurements**

1. Analyzer center frequency was set to the frequency of the radiated spurious emission of interest
2. RBW = 1MHz
3. VBW  $\geq$  1/T
4. De As an alternative, the instrument may be set to linear detector mode. Ensure that video filtering is applied in linear voltage domain (rather than in a log or dB domain). Some instruments require linear display mode in order to accomplish this. Others have a setting for Average-VBW Type, which can be set to "Voltage" regardless of the display mode
5. Detector = Peak
6. Sweep time = auto
7. Trace mode = max hold
8. Allow max hold to run for at least 50 times (1/duty cycle) traces

### 7.6.4. Test Setup

#### 9kHz ~ 30MHz Test Setup:

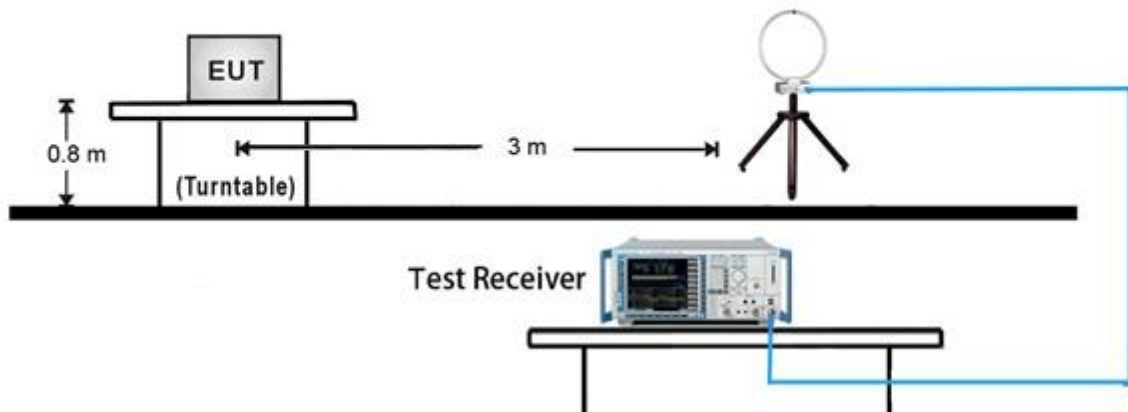

#### 30MHz ~ 1GHz Test Setup:

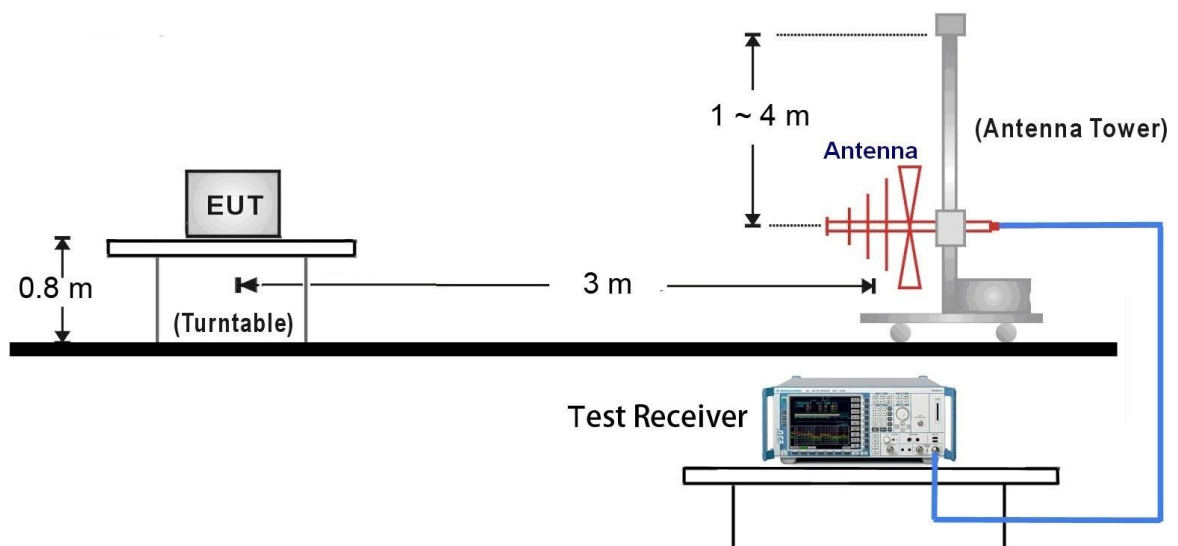

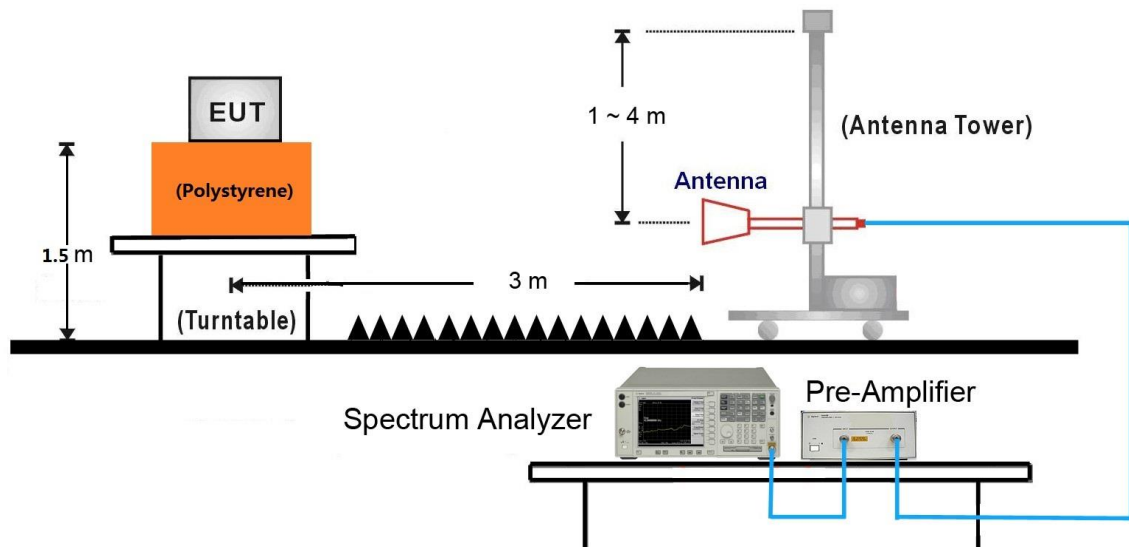
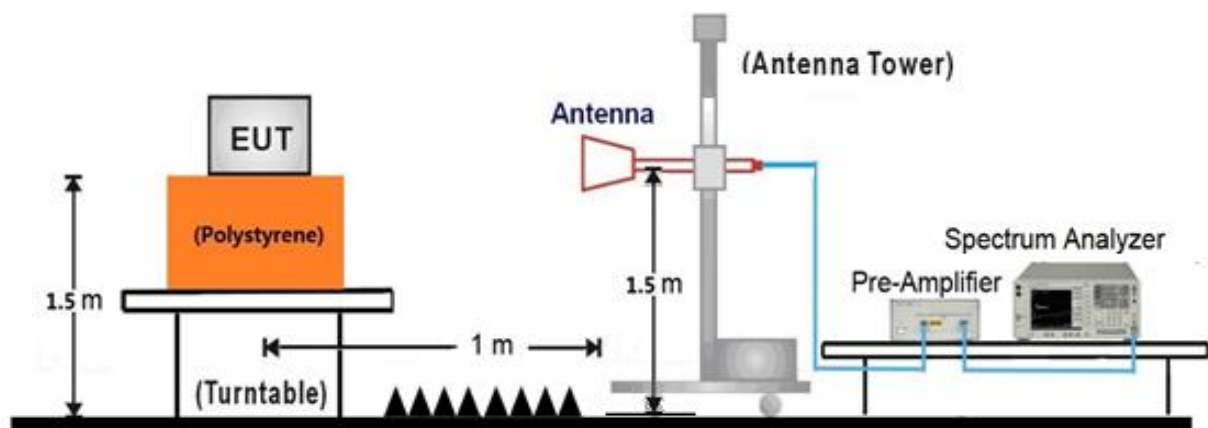
1GHz ~ 18GHz Test Setup:18GHz ~25GHz Test Setup:

### 7.6.5. Test Result

|           |                    |                      |              |
|-----------|--------------------|----------------------|--------------|
| EUT       | Gaming Mouse       | Date of Test         | 2023-03-30   |
| Factor    | VULB 9162          | Temp. / Humidity     | 23°C /65%    |
| Polarity  | Horizontal         | Site / Test Engineer | AC1 / Kaunaz |
| Test Mode | BLE_TX_1Mbps_CH 19 | Test Voltage         | By Battery   |

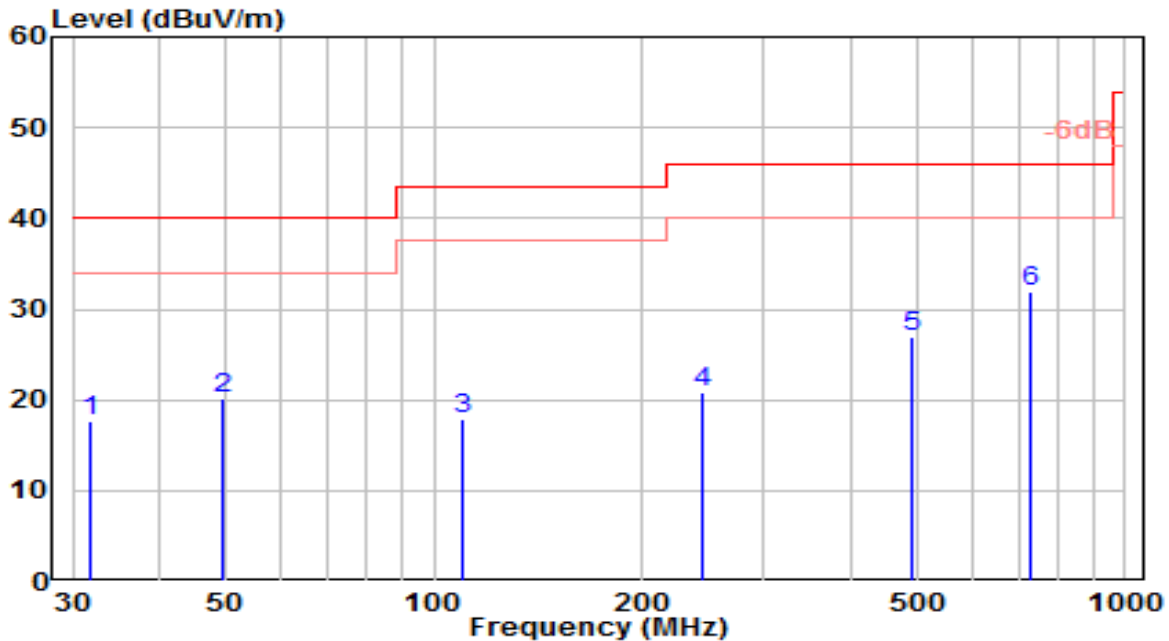

| No | Frequency (MHz) | Reading (dBuV) | C.F (dB/m) | Measurement (dBuV/m) | Margin (dB) | Limit (dBuV/m) | Height (cm) | Angle (deg) | Remark (QP/PK/AV) |
|----|-----------------|----------------|------------|----------------------|-------------|----------------|-------------|-------------|-------------------|
| 1  | 31.940          | 0.52           | 17.10      | 17.61                | -22.39      | 40.00          | 100         | 240         | QP                |
| 2  | 49.400          | -0.74          | 20.91      | 20.17                | -19.83      | 40.00          | 100         | 30          | QP                |
| 3  | 109.540         | -0.44          | 18.43      | 17.99                | -25.51      | 43.50          | 100         | 55          | QP                |
| 4  | 245.340         | 0.78           | 20.14      | 20.92                | -25.08      | 46.00          | 100         | 150         | QP                |
| 5  | 492.690         | 1.62           | 25.33      | 26.95                | -19.05      | 46.00          | 100         | 305         | QP                |
| 6  | * 730.340       | 2.73           | 29.22      | 31.95                | -14.05      | 46.00          | 100         | 20          | QP                |

Note:

1. " \*", means this data is the worst emission level.
2. C.F (Correction Factor) = Antenna Factor (dB/m)+ Cable Loss (dB).
3. Measurement (dBuV/m) = Reading(dBuV) + C.F (Correction Factor).
4. The emission levels of other frequencies are very lower than the limit and not show in test report.
- 5: The amplitude of radiated emissions (frequency range from 9kHz to 30MHz)is that proximity to ambient noise ,which also are attenuated more than 20dB below the permissible value. Therefore, the data is not presented in the report.

|           |                    |                      |              |
|-----------|--------------------|----------------------|--------------|
| EUT       | Gaming Mouse       | Date of Test         | 2023-03-30   |
| Factor    | VULB 9162          | Temp. / Humidity     | 23°C /65%    |
| Polarity  | Vertical           | Site / Test Engineer | AC1 / Kaunaz |
| Test Mode | BLE_TX_1Mbps_CH 19 | Test Voltage         | By Battery   |

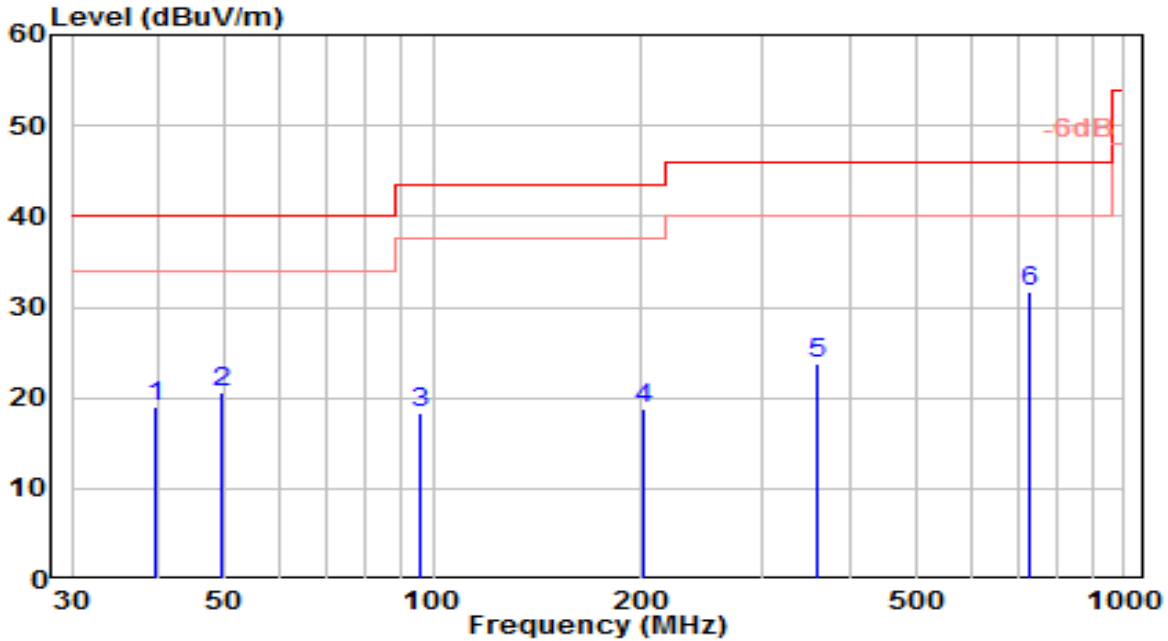

| No | Frequency (MHz) | Reading (dBUV) | C.F (dB/m) | Measurement (dBUV/m) | Margin (dB) | Limit (dBUV/m) | Height (cm) | Angle (deg) | Remark (QP/PK/AV) |
|----|-----------------|----------------|------------|----------------------|-------------|----------------|-------------|-------------|-------------------|
| 1  | 39.700          | -0.27          | 19.36      | 19.08                | -20.92      | 40.00          | 100         | 260         | QP                |
| 2  | 49.400          | -0.31          | 20.91      | 20.60                | -19.40      | 40.00          | 100         | 195         | QP                |
| 3  | 95.960          | 0.37           | 18.06      | 18.42                | -25.08      | 43.50          | 100         | 155         | QP                |
| 4  | 200.720         | 0.37           | 18.33      | 18.70                | -24.80      | 43.50          | 100         | 65          | QP                |
| 5  | 358.830         | 0.63           | 23.08      | 23.70                | -22.30      | 46.00          | 100         | 65          | QP                |
| 6  | * 730.340       | 2.57           | 29.22      | 31.79                | -14.21      | 46.00          | 100         | 230         | QP                |

Note:

- " \*", means this data is the worst emission level.
- C.F (Correction Factor) = Antenna Factor (dB/m)+ Cable Loss (dB).
- Measurement (dBUV/m) = Reading(dBUV) + C.F (Correction Factor).
- The emission levels of other frequencies are very lower than the limit and not show in test report.
- 5: The amplitude of radiated emissions (frequency range from 9kHz to 30MHz)is that proximity to ambient noise ,which also are attenuated more than 20dB below the permissible value. Therefore, the data is not presented in the report.



|           |                        |                      |            |
|-----------|------------------------|----------------------|------------|
| EUT       | Gaming Mouse           | Date of Test         | 2023-03-31 |
| Factor    | BBHA 9120D & BBHA 9170 | Temp. / Humidity     | 23°C /63%  |
| Polarity  | Horizontal             | Site / Test Engineer | AC1 / Todd |
| Test Mode | BLE_TX_1Mbps_CH 0      | Test Voltage         | By Battery |

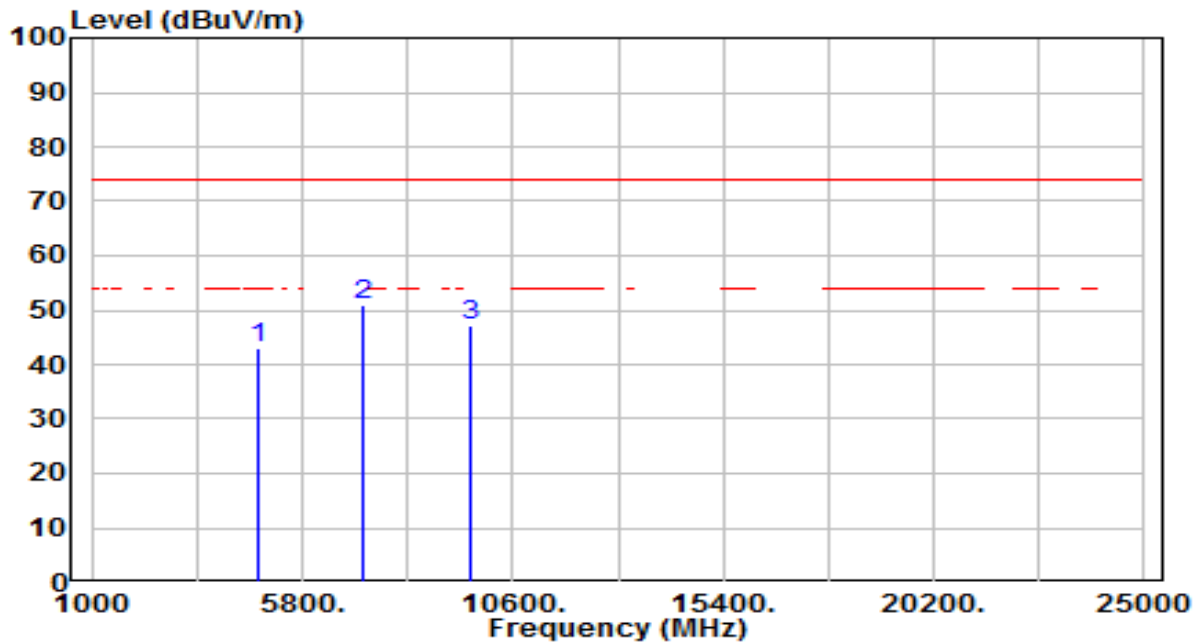

| No | Frequency (MHz) | Reading (dBuV) | C.F (dB/m) | Measurement (dBuV/m) | Margin (dB) | Limit (dBuV/m) | Height (cm) | Angle (deg) | Remark (QP/PK/AV) |
|----|-----------------|----------------|------------|----------------------|-------------|----------------|-------------|-------------|-------------------|
| 1  | 4804.000        | 39.28          | 3.61       | 42.89                | -31.11      | 74.00          | 100         | 360         | Peak              |
| 2  | * 7206.000      | 39.18          | 11.68      | 50.86                | -23.14      | 74.00          | 100         | 360         | Peak              |
| 3  | 9608.000        | 31.54          | 15.69      | 47.23                | -26.77      | 74.00          | 100         | 360         | Peak              |

Note:

1. " \*", means this data is the worst emission level.
2. C.F (Correction Factor) = Antenna Factor (dB/m)+ Cable Loss (dB) – Preamplifier(dB).
3. Measurement (dBuV/m) = Reading(dBuV) + C.F (Correction Factor).
4. The emission levels of other frequencies are very lower than the limit and not show in test report.

|           |                        |                      |            |
|-----------|------------------------|----------------------|------------|
| EUT       | Gaming Mouse           | Date of Test         | 2023-03-31 |
| Factor    | BBHA 9120D & BBHA 9170 | Temp. / Humidity     | 23°C /63%  |
| Polarity  | Vertical               | Site / Test Engineer | AC1 / Todd |
| Test Mode | BLE_TX_1Mbps_CH 0      | Test Voltage         | By Battery |

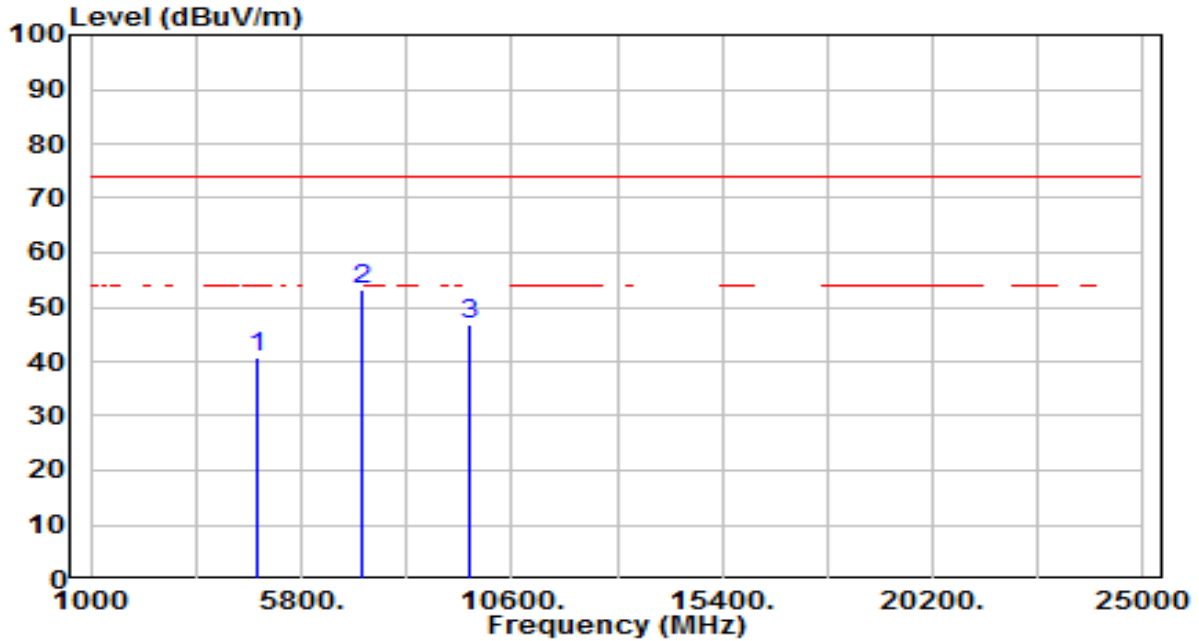

| No | Frequency (MHz) | Reading (dBuV) | C.F (dB/m) | Measurement (dBuV/m) | Margin (dB) | Limit (dBuV/m) | Height (cm) | Angle (deg) | Remark (QP/PK/AV) |
|----|-----------------|----------------|------------|----------------------|-------------|----------------|-------------|-------------|-------------------|
| 1  | 4804.000        | 37.23          | 3.61       | 40.84                | -33.16      | 74.00          | 100         | 360         | Peak              |
| 2  | * 7206.000      | 41.69          | 11.68      | 53.38                | -20.62      | 74.00          | 100         | 360         | Peak              |
| 3  | 9608.000        | 30.97          | 15.69      | 46.66                | -27.34      | 74.00          | 100         | 360         | Peak              |

Note:

1. " \*", means this data is the worst emission level.
2. C.F (Correction Factor) = Antenna Factor (dB/m)+ Cable Loss (dB) – Pre-amplifier(dB).
3. Measurement (dBuV/m) = Reading(dBuV) + C.F (Correction Factor).
4. The emission levels of other frequencies are very lower than the limit and not show in test report.

|           |                        |                      |            |
|-----------|------------------------|----------------------|------------|
| EUT       | Gaming Mouse           | Date of Test         | 2023-03-31 |
| Factor    | BBHA 9120D & BBHA 9170 | Temp. / Humidity     | 23°C /63%  |
| Polarity  | Horizontal             | Site / Test Engineer | AC1 / Todd |
| Test Mode | BLE_TX_1Mbps_CH 19     | Test Voltage         | By Battery |

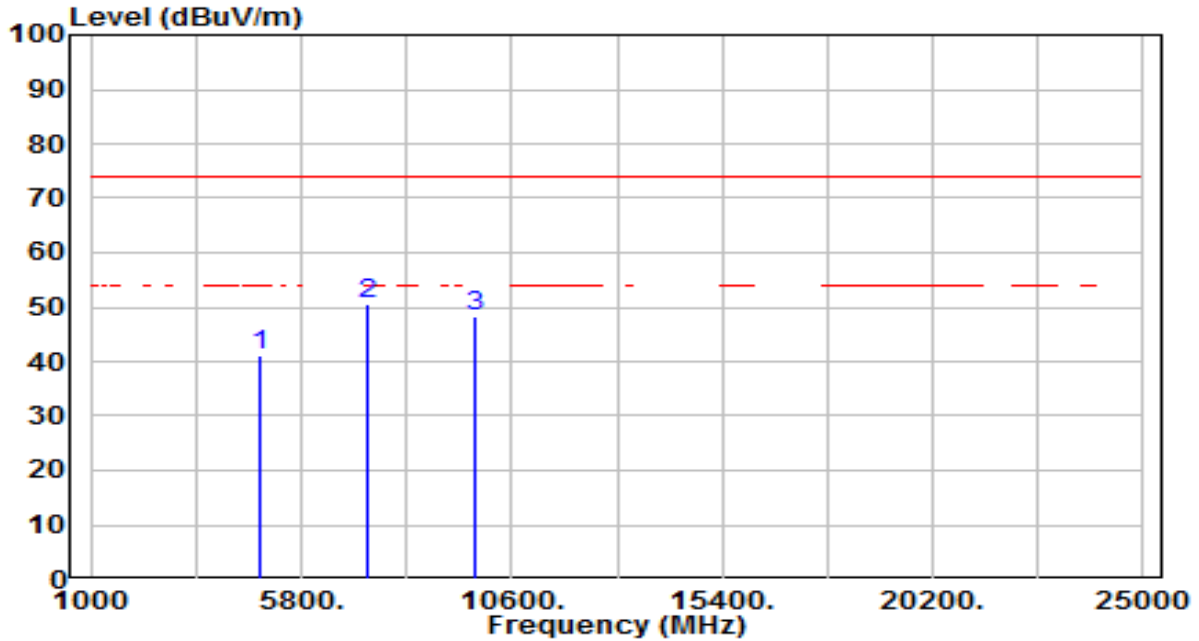

| No | Frequency (MHz) | Reading (dBuV) | C.F (dB/m) | Measurement (dBuV/m) | Margin (dB) | Limit (dBuV/m) | Height (cm) | Angle (deg) | Remark (QP/PK/AV) |
|----|-----------------|----------------|------------|----------------------|-------------|----------------|-------------|-------------|-------------------|
| 1  | 4880.000        | 37.20          | 3.75       | 40.95                | -33.05      | 74.00          | 100         | 360         | Peak              |
| 2  | * 7320.000      | 38.60          | 12.15      | 50.75                | -23.25      | 74.00          | 100         | 360         | Peak              |
| 3  | 9760.000        | 32.31          | 15.97      | 48.28                | -25.72      | 74.00          | 100         | 360         | Peak              |

Note:

1. " \*", means this data is the worst emission level.
2. C.F (Correction Factor) = Antenna Factor (dB/m)+ Cable Loss (dB) – Preamplifier(dB).
3. Measurement (dBuV/m) = Reading(dBuV) + C.F (Correction Factor).
4. The emission levels of other frequencies are very lower than the limit and not show in test report.

|           |                        |                      |            |
|-----------|------------------------|----------------------|------------|
| EUT       | Gaming Mouse           | Date of Test         | 2023-03-31 |
| Factor    | BBHA 9120D & BBHA 9170 | Temp. / Humidity     | 23°C /63%  |
| Polarity  | Vertical               | Site / Test Engineer | AC1 / Todd |
| Test Mode | BLE_TX_1Mbps_CH 19     | Test Voltage         | By Battery |

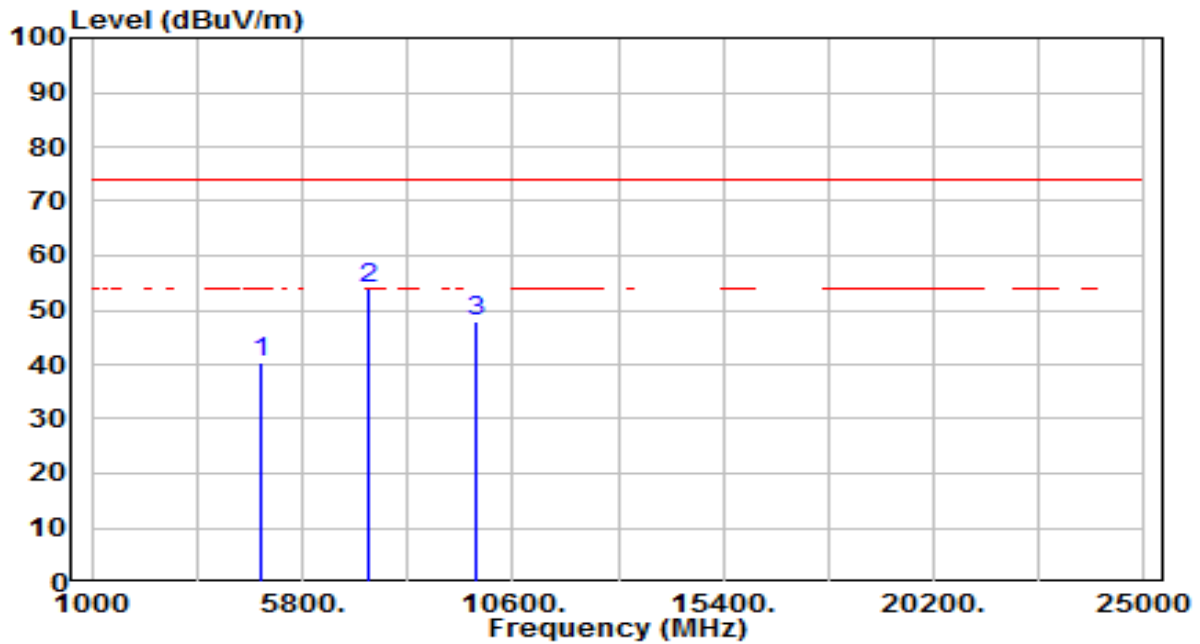

| No | Frequency (MHz) | Reading (dBuV) | C.F (dB/m) | Measurement (dBuV/m) | Margin (dB) | Limit (dBuV/m) | Height (cm) | Angle (deg) | Remark (QP/PK/AV) |
|----|-----------------|----------------|------------|----------------------|-------------|----------------|-------------|-------------|-------------------|
| 1  | 4880.000        | 36.52          | 3.75       | 40.27                | -33.73      | 74.00          | 100         | 360         | Peak              |
| 2  | * 7320.000      | 41.72          | 12.15      | 53.87                | -20.13      | 74.00          | 100         | 360         | Peak              |
| 3  | 9760.000        | 31.80          | 15.97      | 47.77                | -26.23      | 74.00          | 100         | 360         | Peak              |

Note:

1. " \*", means this data is the worst emission level.
2. C.F (Correction Factor) = Antenna Factor (dB/m)+ Cable Loss (dB) – Preamplifier(dB).
3. Measurement (dBuV/m) = Reading(dBuV) + C.F (Correction Factor).
4. The emission levels of other frequencies are very lower than the limit and not show in test report.

|           |                        |                      |            |
|-----------|------------------------|----------------------|------------|
| EUT       | Gaming Mouse           | Date of Test         | 2023-03-31 |
| Factor    | BBHA 9120D & BBHA 9170 | Temp. / Humidity     | 23°C /63%  |
| Polarity  | Horizontal             | Site / Test Engineer | AC1 / Todd |
| Test Mode | BLE_TX_1Mbps_CH 39     | Test Voltage         | By Battery |

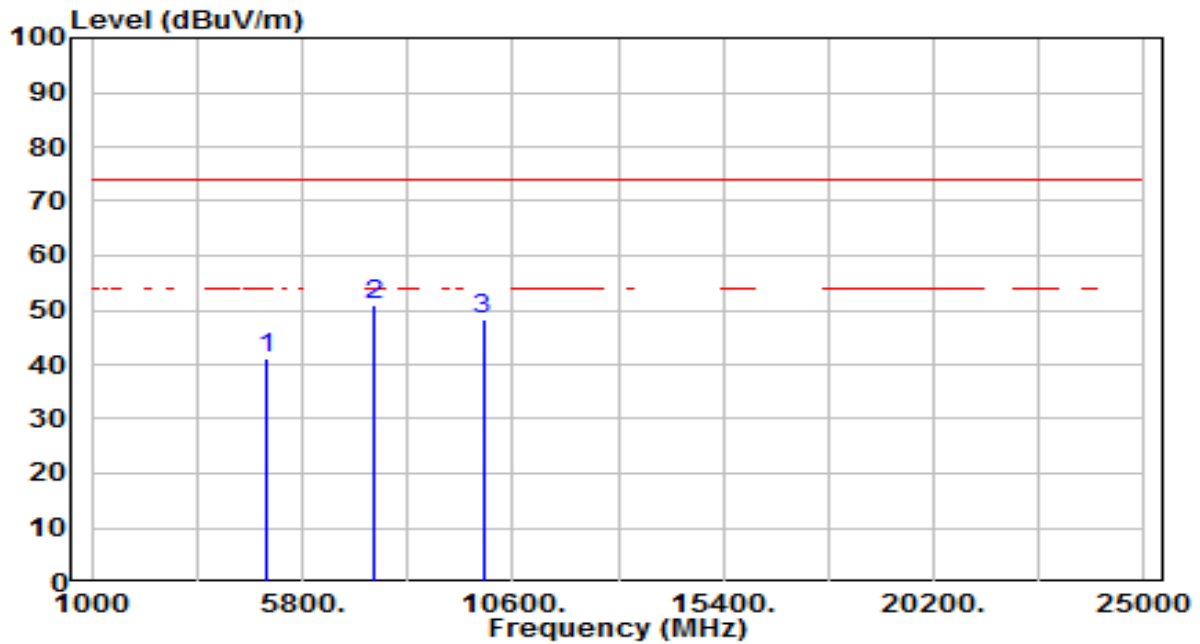

| No | Frequency (MHz) | Reading (dBuV) | C.F (dB/m) | Measurement (dBuV/m) | Margin (dB) | Limit (dBuV/m) | Height (cm) | Angle (deg) | Remark (QP/PK/AV) |
|----|-----------------|----------------|------------|----------------------|-------------|----------------|-------------|-------------|-------------------|
| 1  | 4960.000        | 37.07          | 3.90       | 40.97                | -33.03      | 74.00          | 100         | 360         | Peak              |
| 2  | * 7440.000      | 38.36          | 12.65      | 51.01                | -22.99      | 74.00          | 100         | 360         | Peak              |
| 3  | 9920.000        | 32.16          | 16.27      | 48.43                | -25.57      | 74.00          | 100         | 360         | Peak              |

Note:

1. " \*", means this data is the worst emission level.
2. C.F (Correction Factor) = Antenna Factor (dB/m)+ Cable Loss (dB) – Preamplifier(dB).
3. Measurement (dBuV/m) = Reading(dBuV) + C.F (Correction Factor).
4. The emission levels of other frequencies are very lower than the limit and not show in test report.

|           |                        |                      |            |
|-----------|------------------------|----------------------|------------|
| EUT       | Gaming Mouse           | Date of Test         | 2023-03-31 |
| Factor    | BBHA 9120D & BBHA 9170 | Temp. / Humidity     | 23°C /63%  |
| Polarity  | Vertical               | Site / Test Engineer | AC1 / Todd |
| Test Mode | BLE_TX_1Mbps_CH 39     | Test Voltage         | By Battery |

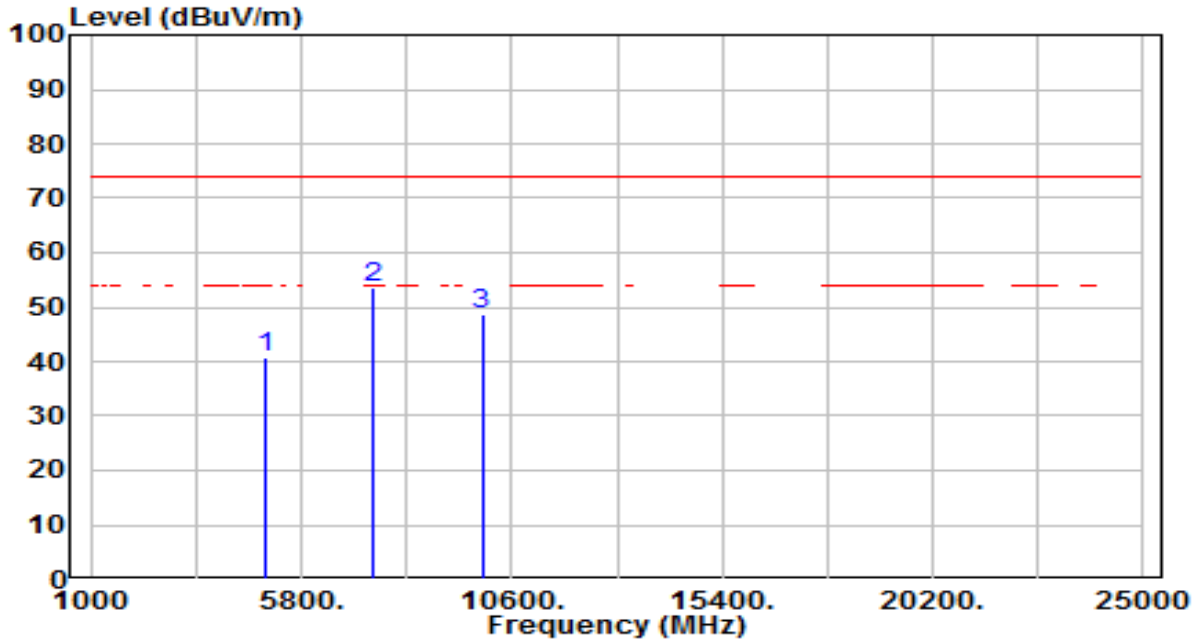

| No | Frequency (MHz) | Reading (dBuV) | C.F (dB/m) | Measurement (dBuV/m) | Margin (dB) | Limit (dBuV/m) | Height (cm) | Angle (deg) | Remark (QP/PK/AV) |
|----|-----------------|----------------|------------|----------------------|-------------|----------------|-------------|-------------|-------------------|
| 1  | 4960.000        | 36.79          | 3.90       | 40.69                | -33.31      | 74.00          | 100         | 360         | Peak              |
| 2  | * 7440.000      | 40.81          | 12.65      | 53.45                | -20.55      | 74.00          | 100         | 360         | Peak              |
| 3  | 9920.000        | 32.46          | 16.27      | 48.73                | -25.27      | 74.00          | 100         | 360         | Peak              |

Note:

1. " \*", means this data is the worst emission level.
2. C.F (Correction Factor) = Antenna Factor (dB/m)+ Cable Loss (dB) – Preamplifier(dB).
3. Measurement (dBuV/m) = Reading(dBuV) + C.F (Correction Factor).
4. The emission levels of other frequencies are very lower than the limit and not show in test report.

|           |                        |                      |            |
|-----------|------------------------|----------------------|------------|
| EUT       | Gaming Mouse           | Date of Test         | 2023-03-31 |
| Factor    | BBHA 9120D & BBHA 9170 | Temp. / Humidity     | 23°C /63%  |
| Polarity  | Horizontal             | Site / Test Engineer | AC1 / Todd |
| Test Mode | BLE_TX_2Mbps_CH 0      | Test Voltage         | By Battery |

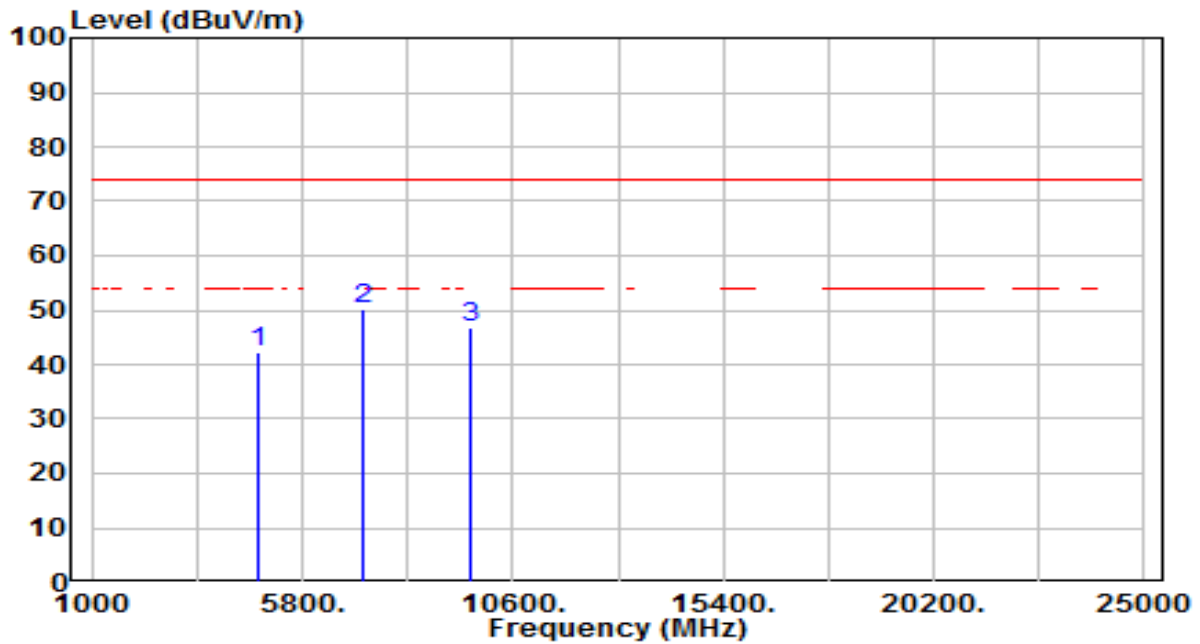

| No | Frequency (MHz) | Reading (dBuV) | C.F (dB/m) | Measurement (dBuV/m) | Margin (dB) | Limit (dBuV/m) | Height (cm) | Angle (deg) | Remark (QP/PK/AV) |
|----|-----------------|----------------|------------|----------------------|-------------|----------------|-------------|-------------|-------------------|
| 1  | 4804.000        | 38.78          | 3.61       | 42.39                | -31.61      | 74.00          | 100         | 360         | Peak              |
| 2  | * 7206.000      | 38.56          | 11.68      | 50.24                | -23.76      | 74.00          | 100         | 360         | Peak              |
| 3  | 9608.000        | 30.95          | 15.69      | 46.64                | -27.36      | 74.00          | 100         | 360         | Peak              |

Note:

1. " \*", means this data is the worst emission level.
2. C.F (Correction Factor) = Antenna Factor (dB/m)+ Cable Loss (dB) – Preamplifier(dB).
3. Measurement (dBuV/m) = Reading(dBuV) + C.F (Correction Factor).
4. The emission levels of other frequencies are very lower than the limit and not show in test report.

|           |                        |                      |            |
|-----------|------------------------|----------------------|------------|
| EUT       | Gaming Mouse           | Date of Test         | 2023-03-31 |
| Factor    | BBHA 9120D & BBHA 9170 | Temp. / Humidity     | 23°C /63%  |
| Polarity  | Vertical               | Site / Test Engineer | AC1 / Todd |
| Test Mode | BLE_TX_2Mbps_CH 0      | Test Voltage         | By Battery |

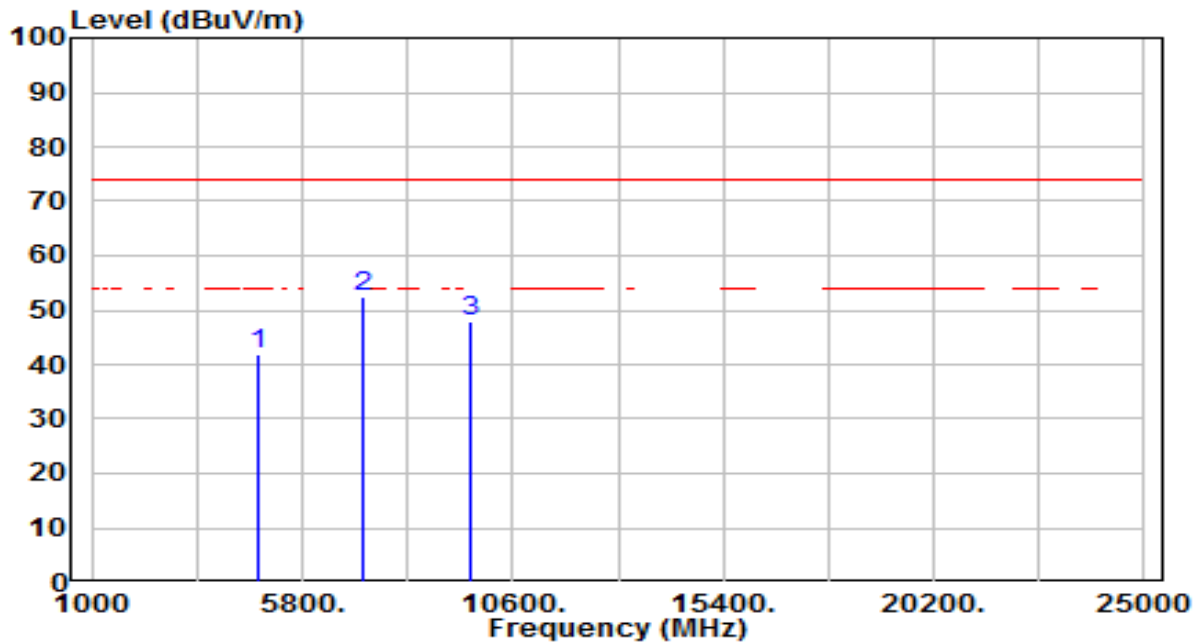

| No | Frequency (MHz) | Reading (dBuV) | C.F (dB/m) | Measurement (dBuV/m) | Margin (dB) | Limit (dBuV/m) | Height (cm) | Angle (deg) | Remark (QP/PK/AV) |
|----|-----------------|----------------|------------|----------------------|-------------|----------------|-------------|-------------|-------------------|
| 1  | 4804.000        | 38.12          | 3.61       | 41.73                | -32.27      | 74.00          | 100         | 360         | Peak              |
| 2  | * 7206.000      | 40.93          | 11.68      | 52.61                | -21.39      | 74.00          | 100         | 360         | Peak              |
| 3  | 9608.000        | 32.36          | 15.69      | 48.05                | -25.95      | 74.00          | 100         | 360         | Peak              |

Note:

- "\*" means this data is the worst emission level.
- C.F (Correction Factor) = Antenna Factor (dB/m)+ Cable Loss (dB) – Preamplifier(dB).
- Measurement (dBuV/m) = Reading(dBuV) + C.F (Correction Factor).
- The emission levels of other frequencies are very lower than the limit and not show in test report.



|           |                        |                      |            |
|-----------|------------------------|----------------------|------------|
| EUT       | Gaming Mouse           | Date of Test         | 2023-03-31 |
| Factor    | BBHA 9120D & BBHA 9170 | Temp. / Humidity     | 23°C /63%  |
| Polarity  | Horizontal             | Site / Test Engineer | AC1 / Todd |
| Test Mode | BLE_TX_2Mbps_CH 19     | Test Voltage         | By Battery |

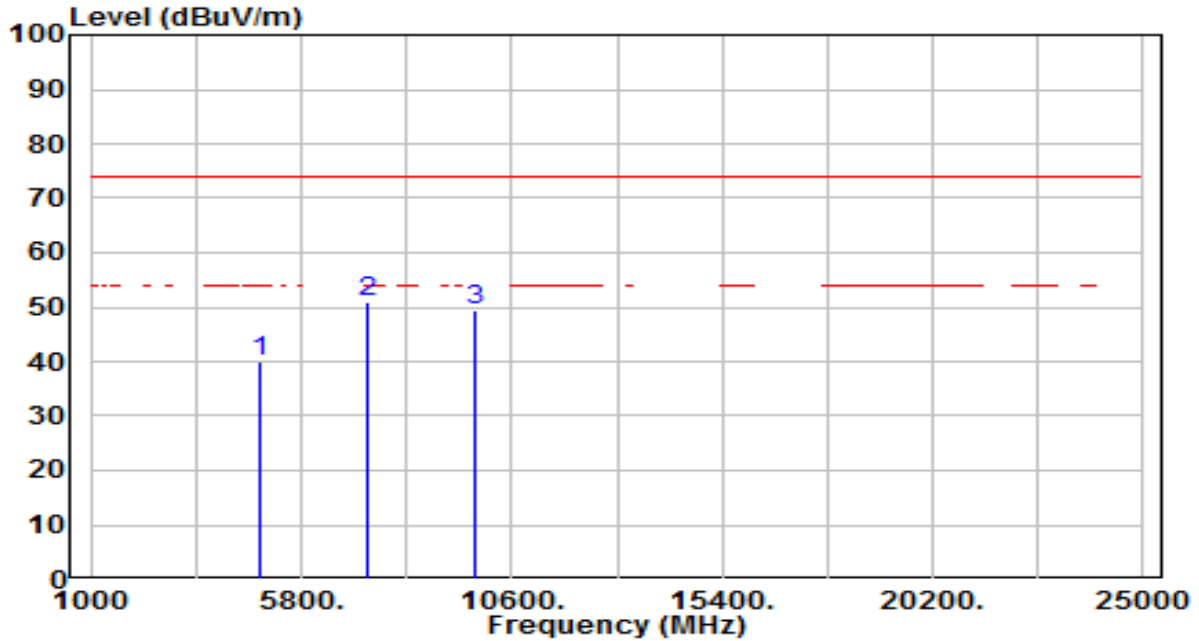

| No | Frequency (MHz) | Reading (dBuV) | C.F (dB/m) | Measurement (dBuV/m) | Margin (dB) | Limit (dBuV/m) | Height (cm) | Angle (deg) | Remark (QP/PK/AV) |
|----|-----------------|----------------|------------|----------------------|-------------|----------------|-------------|-------------|-------------------|
| 1  | 4880.000        | 36.33          | 3.75       | 40.08                | -33.92      | 74.00          | 100         | 360         | Peak              |
| 2  | * 7320.000      | 38.79          | 12.15      | 50.94                | -23.06      | 74.00          | 100         | 360         | Peak              |
| 3  | 9760.000        | 33.37          | 15.97      | 49.34                | -24.66      | 74.00          | 100         | 360         | Peak              |

Note:

1. " \*", means this data is the worst emission level.
2. C.F (Correction Factor) = Antenna Factor (dB/m)+ Cable Loss (dB) – Preamplifier(dB).
3. Measurement (dBuV/m) = Reading(dBuV) + C.F (Correction Factor).
4. The emission levels of other frequencies are very lower than the limit and not show in test report.

|           |                        |                      |            |
|-----------|------------------------|----------------------|------------|
| EUT       | Gaming Mouse           | Date of Test         | 2023-03-31 |
| Factor    | BBHA 9120D & BBHA 9170 | Temp. / Humidity     | 23°C /63%  |
| Polarity  | Vertical               | Site / Test Engineer | AC1 / Todd |
| Test Mode | BLE_TX_2Mbps_CH 19     | Test Voltage         | By Battery |

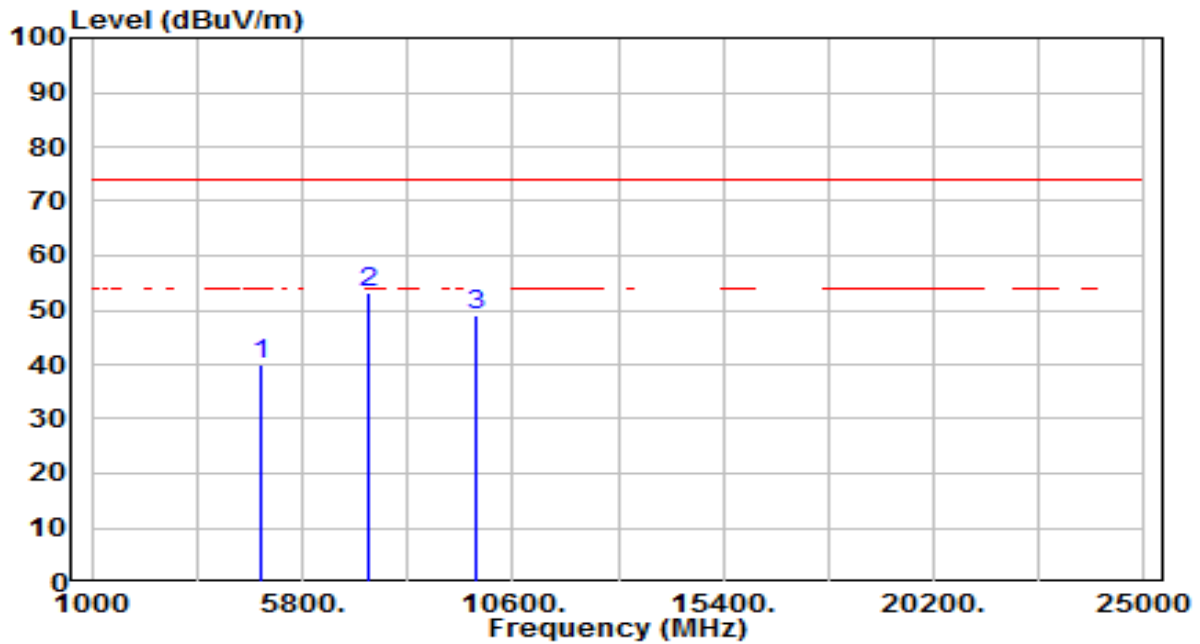

| No | Frequency (MHz) | Reading (dBuV) | C.F (dB/m) | Measurement (dBuV/m) | Margin (dB) | Limit (dBuV/m) | Height (cm) | Angle (deg) | Remark (QP/PK/AV) |
|----|-----------------|----------------|------------|----------------------|-------------|----------------|-------------|-------------|-------------------|
| 1  | 4880.000        | 36.26          | 3.75       | 40.01                | -33.99      | 74.00          | 100         | 360         | Peak              |
| 2  | * 7320.000      | 40.88          | 12.15      | 53.03                | -20.97      | 74.00          | 100         | 360         | Peak              |
| 3  | 9760.000        | 33.01          | 15.97      | 48.99                | -25.01      | 74.00          | 100         | 360         | Peak              |

Note:

1. " \*", means this data is the worst emission level.
2. C.F (Correction Factor) = Antenna Factor (dB/m)+ Cable Loss (dB) – Preamplifier(dB).
3. Measurement (dBuV/m) = Reading(dBuV) + C.F (Correction Factor).
4. The emission levels of other frequencies are very lower than the limit and not show in test report.

|           |                        |                      |            |
|-----------|------------------------|----------------------|------------|
| EUT       | Gaming Mouse           | Date of Test         | 2023-03-31 |
| Factor    | BBHA 9120D & BBHA 9170 | Temp. / Humidity     | 23°C /63%  |
| Polarity  | Horizontal             | Site / Test Engineer | AC1 / Todd |
| Test Mode | BLE_TX_2Mbps_CH 39     | Test Voltage         | By Battery |

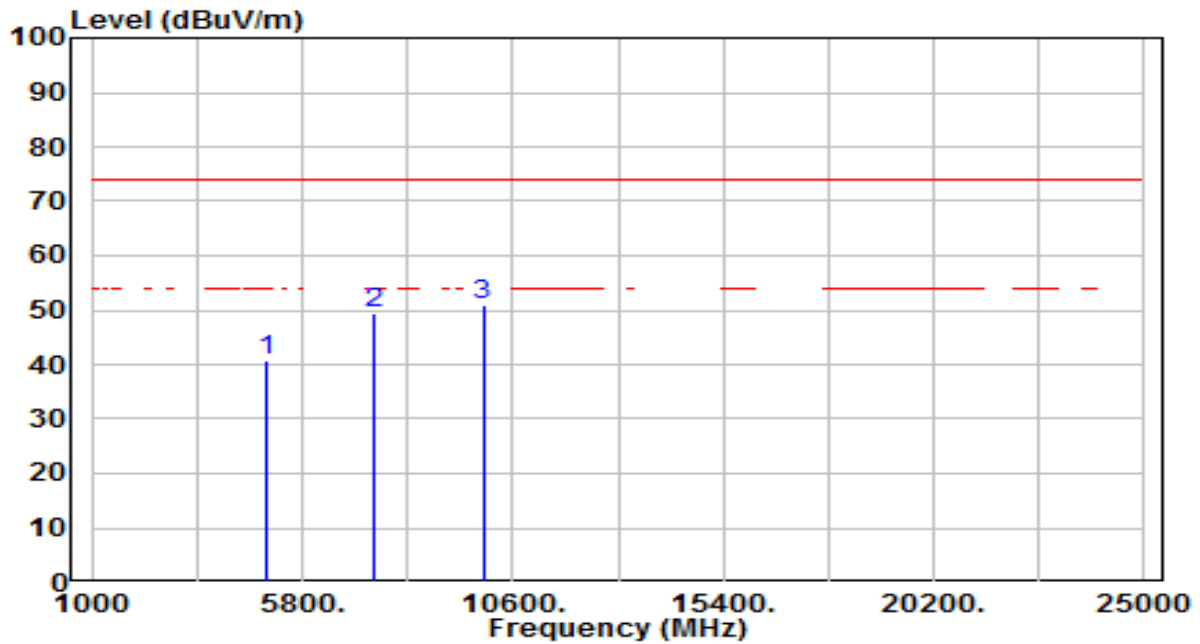

| No | Frequency (MHz) | Reading (dBuV) | C.F (dB/m) | Measurement (dBuV/m) | Margin (dB) | Limit (dBuV/m) | Height (cm) | Angle (deg) | Remark (QP/PK/AV) |
|----|-----------------|----------------|------------|----------------------|-------------|----------------|-------------|-------------|-------------------|
| 1  | 4960.000        | 36.70          | 3.90       | 40.60                | -33.40      | 74.00          | 100         | 360         | Peak              |
| 2  | 7440.000        | 36.92          | 12.65      | 49.57                | -24.43      | 74.00          | 100         | 360         | Peak              |
| 3  | * 9920.000      | 34.80          | 16.27      | 51.07                | -22.93      | 74.00          | 100         | 360         | Peak              |

Note:

1. " \*" , means this data is the worst emission level.
2. C.F (Correction Factor) = Antenna Factor (dB/m)+ Cable Loss (dB) – Preamplifier(dB).
3. Measurement (dBuV/m) = Reading(dBuV) + C.F (Correction Factor).
4. The emission levels of other frequencies are very lower than the limit and not show in test report.

|           |                        |                      |            |
|-----------|------------------------|----------------------|------------|
| EUT       | Gaming Mouse           | Date of Test         | 2023-03-31 |
| Factor    | BBHA 9120D & BBHA 9170 | Temp. / Humidity     | 23°C /63%  |
| Polarity  | Vertical               | Site / Test Engineer | AC1 / Todd |
| Test Mode | BLE_TX_2Mbps_CH 39     | Test Voltage         | By Battery |

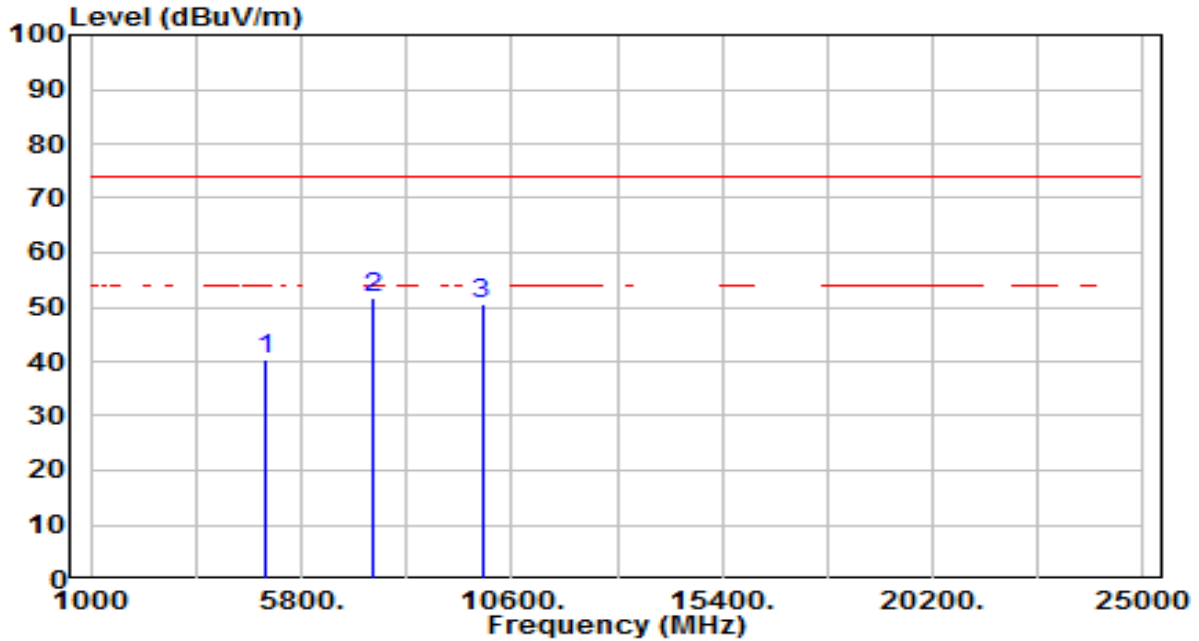

| No | Frequency (MHz) | Reading (dBuV) | C.F (dB/m) | Measurement (dBuV/m) | Margin (dB) | Limit (dBuV/m) | Height (cm) | Angle (deg) | Remark (QP/PK/AV) |
|----|-----------------|----------------|------------|----------------------|-------------|----------------|-------------|-------------|-------------------|
| 1  | 4960.000        | 36.47          | 3.90       | 40.36                | -33.64      | 74.00          | 100         | 360         | Peak              |
| 2  | * 7440.000      | 39.10          | 12.65      | 51.74                | -22.26      | 74.00          | 100         | 360         | Peak              |
| 3  | 9920.000        | 34.37          | 16.27      | 50.64                | -23.36      | 74.00          | 100         | 360         | Peak              |

Note:

- "\*" means this data is the worst emission level.
- C.F (Correction Factor) = Antenna Factor (dB/m)+ Cable Loss (dB) – Pre-amplifier(dB).
- Measurement (dBuV/m) = Reading(dBuV) + C.F (Correction Factor).
- The emission levels of other frequencies are very lower than the limit and not show in test report.

## 7.7. Radiated Restricted Band Edge Measurement

### 7.7.1. Test Limit

All out of band emissions appearing in a restricted band as specified in Section 15.205 of the Title 47 CFR must not exceed the limits shown in Table per Section 15.209.

| FCC Part 15 Subpart C Paragraph 15.209 |                      |                            |
|----------------------------------------|----------------------|----------------------------|
| Frequency [MHz]                        | Field Strength [V/m] | Measured Distance [Meters] |
| 0.009 - 0.490                          | 2400/F (kHz)         | 300                        |
| 0.490 - 1.705                          | 24000/F (kHz)        | 30                         |
| 1.705 – 30                             | 30                   | 30                         |
| 30 – 88                                | 100                  | 3                          |
| 88 – 216                               | 150                  | 3                          |
| 216 – 960                              | 200                  | 3                          |
| Above 960                              | 500                  | 3                          |

### 7.7.2. Test Procedure Used

ANSI C63.10-2013 Section 6.3 & 6.6 & 11.13

### 7.7.3. Test Setting

#### Peak Field Strength Measurements

1. Analyzer center frequency was set to the frequency of the radiated spurious emission of interest
2. RBW = as specified in Table 1
3. VBW = 3 \* RBW
4. Detector = peak
5. Sweep time = auto couple
6. Trace mode = max hold
7. Trace was allowed to stabilize

**Table 1 - RBW as a function of frequency**

| Frequency     | RBW           |
|---------------|---------------|
| 9 ~ 150 kHz   | 200 ~ 300 Hz  |
| 0.15 ~ 30 MHz | 9 ~ 10 kHz    |
| 30 ~ 1000 MHz | 100 ~ 120 kHz |
| > 1000 MHz    | 1 MHz         |

**Average Field Strength Measurements**

1. Analyzer center frequency was set to the frequency of the radiated spurious emission of interest
2. RBW = 1MHz
3. VBW  $\geq 1/T$
4. As an alternative, the instrument may be set to linear detector mode. Ensure that video filtering is applied in linear voltage domain (rather than in a log or dB domain). Some instruments require linear display mode in order to accomplish this. Others have a setting for Average-VBW Type, which can be set to "Voltage" regardless of the display mode
5. Detector = Peak
6. Sweep time = auto
7. Trace mode = max hold
8. Allow max hold to run for at least 50 times (1/duty cycle) traces

#### 7.7.4. Test Setup

##### 1GHz ~ 18GHz Test Setup:

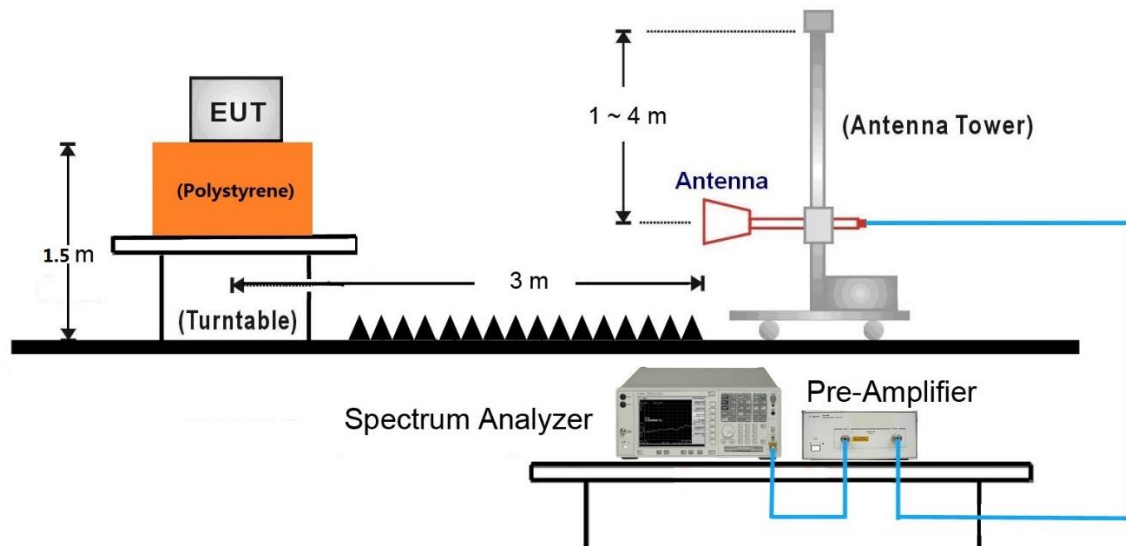

### 7.7.5. Test Result

|           |                   |                      |            |
|-----------|-------------------|----------------------|------------|
| EUT       | Gaming Mouse      | Date of Test         | 2023-03-31 |
| Factor    | BBHA 9120D        | Temp. / Humidity     | 23°C /63%  |
| Polarity  | Horizontal        | Site / Test Engineer | AC1 / Todd |
| Test Mode | BLE_TX_1Mbps_CH 0 | Test Voltage         | By Battery |

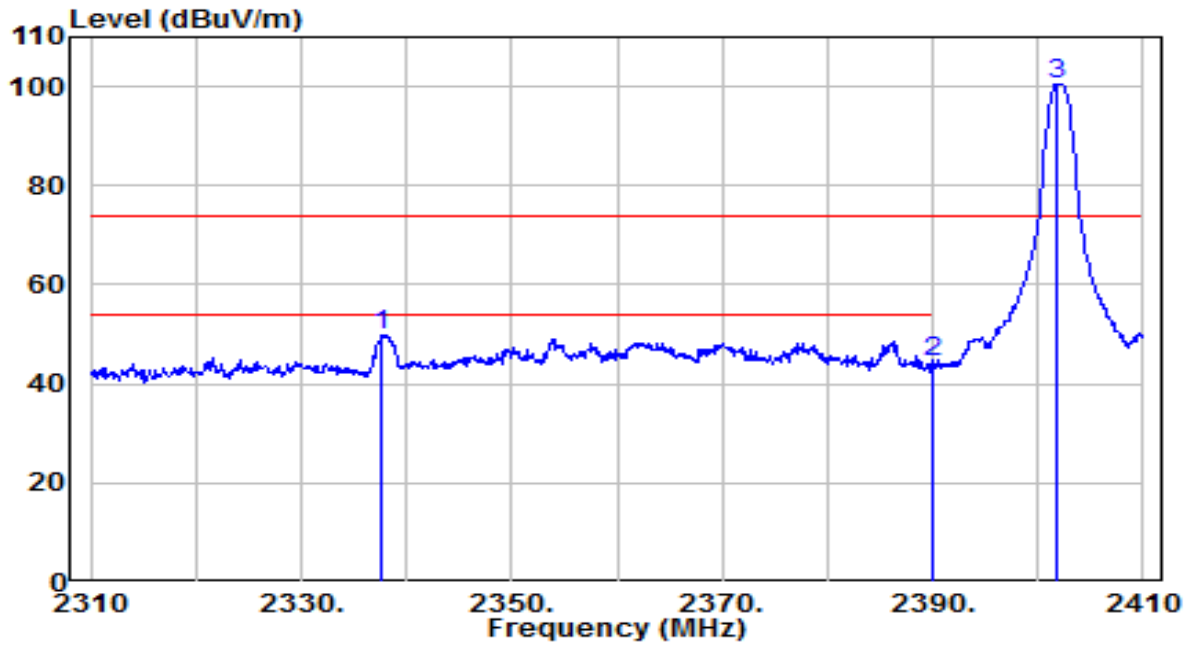

| No | Frequency (MHz) | Reading (dBUV) | C.F (dB/m) | Measurement (dBUV/m) | Margin (dB) | Limit (dBUV/m) | Height (cm) | Angle (deg) | Remark (QP/PK/AV) |      |
|----|-----------------|----------------|------------|----------------------|-------------|----------------|-------------|-------------|-------------------|------|
| 1  | *               | 2337.600       | 52.18      | -2.20                | 49.98       | -24.02         | 74.00       | 195         | 205               | Peak |
| 2  |                 | 2390.000       | 46.26      | -2.04                | 44.22       | -29.78         | 74.00       | 195         | 205               | Peak |
| 3  |                 | 2401.800       | 102.44     | -2.00                | 100.44      | N/A            | N/A         | 195         | 205               | Peak |

Note:

1. " \*", means this data is the worst emission level.
2. C.F (Correction Factor) = Antenna Factor (dB/m)+ Cable Loss (dB) – Preamplifier(dB).
3. Measurement (dBUV/m) = Reading(dBUV) + C.F (Correction Factor).
4. The emission levels of other frequencies are very lower than the limit and not show in test report.



|           |                   |                      |            |
|-----------|-------------------|----------------------|------------|
| EUT       | Gaming Mouse      | Date of Test         | 2023-03-31 |
| Factor    | BBHA 9120D        | Temp. / Humidity     | 23°C /63%  |
| Polarity  | Vertical          | Site / Test Engineer | AC1 / Todd |
| Test Mode | BLE_TX_1Mbps_CH 0 | Test Voltage         | By Battery |

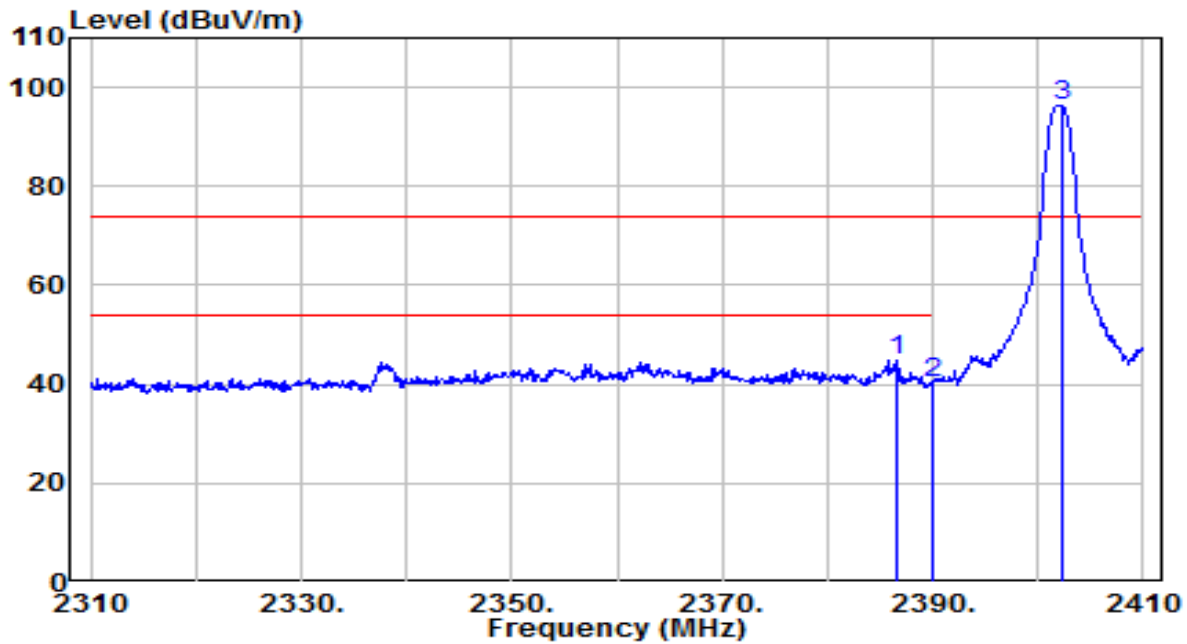

| No | Frequency (MHz) | Reading (dBuV) | C.F (dB/m) | Measurement (dBuV/m) | Margin (dB) | Limit (dBuV/m) | Height (cm) | Angle (deg) | Remark (QP/PK/AV) |
|----|-----------------|----------------|------------|----------------------|-------------|----------------|-------------|-------------|-------------------|
| 1  | * 2386.700      | 46.91          | -2.05      | 44.86                | -29.14      | 74.00          | 275         | 325         | Peak              |
| 2  | 2390.000        | 42.38          | -2.04      | 40.34                | -33.66      | 74.00          | 275         | 325         | Peak              |
| 3  | 2402.300        | 98.22          | -2.00      | 96.23                | N/A         | N/A            | 275         | 325         | Peak              |

Note:

1. " \*", means this data is the worst emission level.
2. C.F (Correction Factor) = Antenna Factor (dB/m)+ Cable Loss (dB) – Preamplifier(dB).
3. Measurement (dBuV/m) = Reading(dBuV) + C.F (Correction Factor).
4. The emission levels of other frequencies are very lower than the limit and not show in test report.

|           |                    |                      |            |
|-----------|--------------------|----------------------|------------|
| EUT       | Gaming Mouse       | Date of Test         | 2023-03-31 |
| Factor    | BBHA 9120D         | Temp. / Humidity     | 23°C /63%  |
| Polarity  | Horizontal         | Site / Test Engineer | AC1 / Todd |
| Test Mode | BLE_TX_1Mbps_CH 39 | Test Voltage         | By Battery |

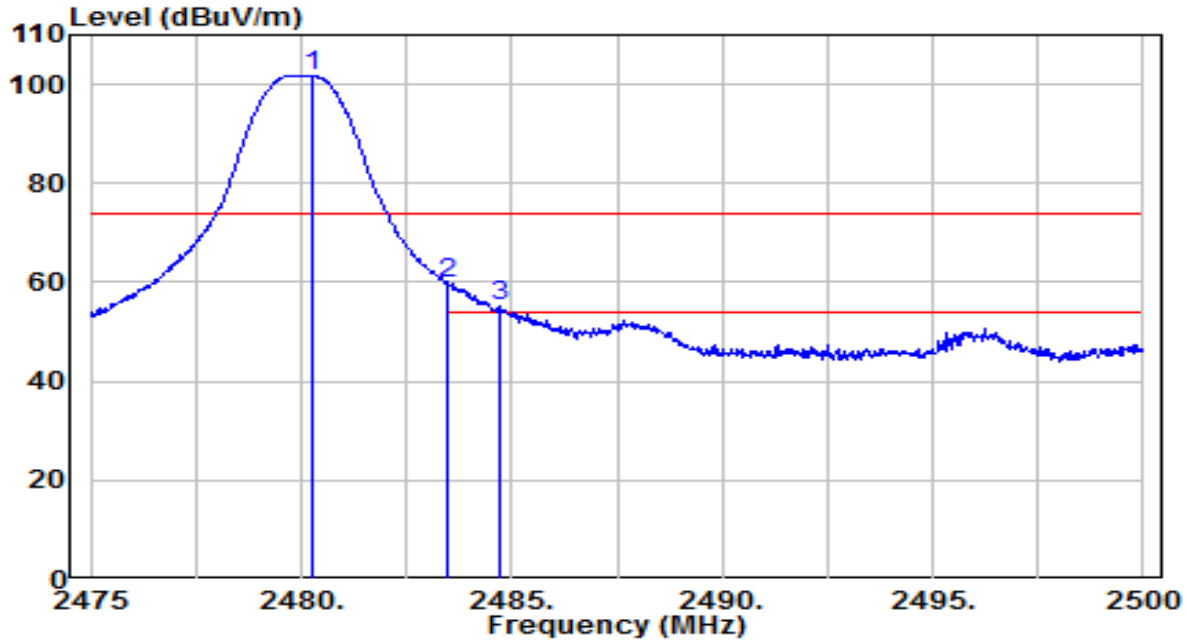

| No | Frequency (MHz) | Reading (dBuV) | C.F (dB/m) | Measurement (dBuV/m) | Margin (dB) | Limit (dBuV/m) | Height (cm) | Angle (deg) | Remark (QP/PK/AV) |
|----|-----------------|----------------|------------|----------------------|-------------|----------------|-------------|-------------|-------------------|
| 1  | 2480.250        | 103.46         | -1.75      | 101.71               | N/A         | N/A            | 200         | 205         | Peak              |
| 2  | * 2483.500      | 61.55          | -1.74      | 59.81                | -14.19      | 74.00          | 200         | 205         | Peak              |
| 3  | 2484.725        | 56.75          | -1.74      | 55.01                | -18.99      | 74.00          | 200         | 205         | Peak              |

Note:

1. " \*", means this data is the worst emission level.
2. C.F (Correction Factor) = Antenna Factor (dB/m)+ Cable Loss (dB) – Preamplifier(dB).
3. Measurement (dBuV/m) = Reading(dBuV) + C.F (Correction Factor).
4. The emission levels of other frequencies are very lower than the limit and not show in test report.

|           |                    |                      |            |
|-----------|--------------------|----------------------|------------|
| EUT       | Gaming Mouse       | Date of Test         | 2023-03-31 |
| Factor    | BBHA 9120D         | Temp. / Humidity     | 23°C /63%  |
| Polarity  | Horizontal         | Site / Test Engineer | AC1 / Todd |
| Test Mode | BLE_TX_1Mbps_CH 39 | Test Voltage         | By Battery |

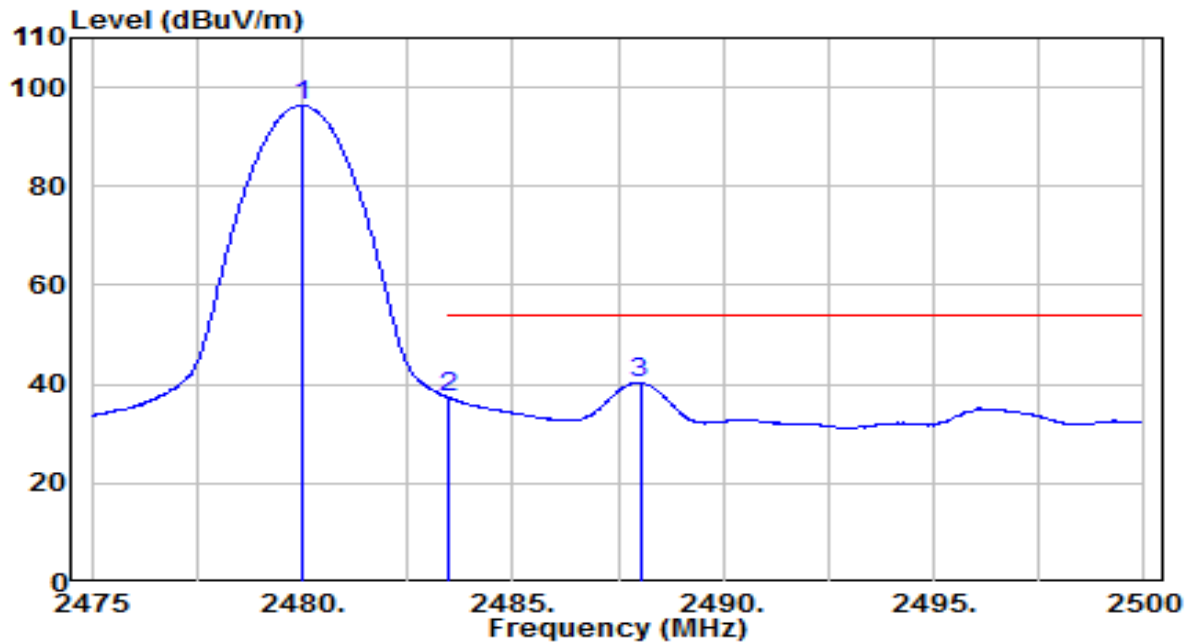

| No | Frequency (MHz) | Reading (dBuV) | C.F (dB/m) | Measurement (dBuV/m) | Margin (dB) | Limit (dBuV/m) | Height (cm) | Angle (deg) | Remark (QP/PK/AV) |
|----|-----------------|----------------|------------|----------------------|-------------|----------------|-------------|-------------|-------------------|
| 1  | 2480.000        | 98.12          | -1.75      | 96.37                | N/A         | N/A            | 200         | 205         | Average           |
| 2  | 2483.500        | 39.00          | -1.74      | 37.26                | -16.74      | 54.00          | 200         | 205         | Average           |
| 3  | * 2488.025      | 42.09          | -1.73      | 40.37                | -13.63      | 54.00          | 200         | 205         | Average           |

Note:

1. " \*", means this data is the worst emission level.
2. C.F (Correction Factor) = Antenna Factor (dB/m)+ Cable Loss (dB) – Preamplifier(dB).
3. Measurement (dBuV/m) = Reading(dBuV) + C.F (Correction Factor).
4. The emission levels of other frequencies are very lower than the limit and not show in test report.

|           |                    |                      |            |
|-----------|--------------------|----------------------|------------|
| EUT       | Gaming Mouse       | Date of Test         | 2023-03-31 |
| Factor    | BBHA 9120D         | Temp. / Humidity     | 23°C /63%  |
| Polarity  | Vertical           | Site / Test Engineer | AC1 / Todd |
| Test Mode | BLE_TX_1Mbps_CH 39 | Test Voltage         | By Battery |

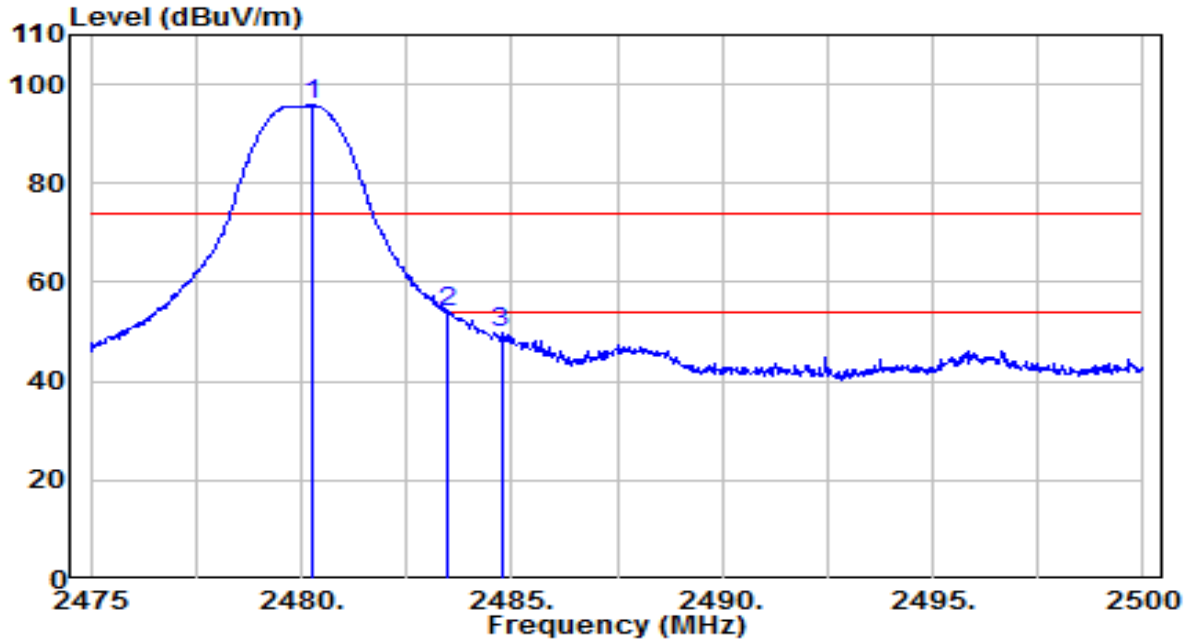

| No | Frequency (MHz) | Reading (dBuV) | C.F (dB/m) | Measurement (dBuV/m) | Margin (dB) | Limit (dBuV/m) | Height (cm) | Angle (deg) | Remark (QP/PK/AV) |
|----|-----------------|----------------|------------|----------------------|-------------|----------------|-------------|-------------|-------------------|
| 1  | 2480.250        | 97.47          | -1.75      | 95.72                | N/A         | N/A            | 260         | 330         | Peak              |
| 2  | * 2483.500      | 55.78          | -1.74      | 54.03                | -19.97      | 74.00          | 260         | 330         | Peak              |
| 3  | 2484.750        | 51.74          | -1.74      | 50.01                | -23.99      | 74.00          | 260         | 330         | Peak              |

Note:

1. " \*", means this data is the worst emission level.
2. C.F (Correction Factor) = Antenna Factor (dB/m)+ Cable Loss (dB) – Preamplifier(dB).
3. Measurement (dBuV/m) = Reading(dBuV) + C.F (Correction Factor).
4. The emission levels of other frequencies are very lower than the limit and not show in test report.

|           |                    |                      |            |
|-----------|--------------------|----------------------|------------|
| EUT       | Gaming Mouse       | Date of Test         | 2023-03-31 |
| Factor    | BBHA 9120D         | Temp. / Humidity     | 23°C /63%  |
| Polarity  | Vertical           | Site / Test Engineer | AC1 / Todd |
| Test Mode | BLE_TX_1Mbps_CH 39 | Test Voltage         | By Battery |

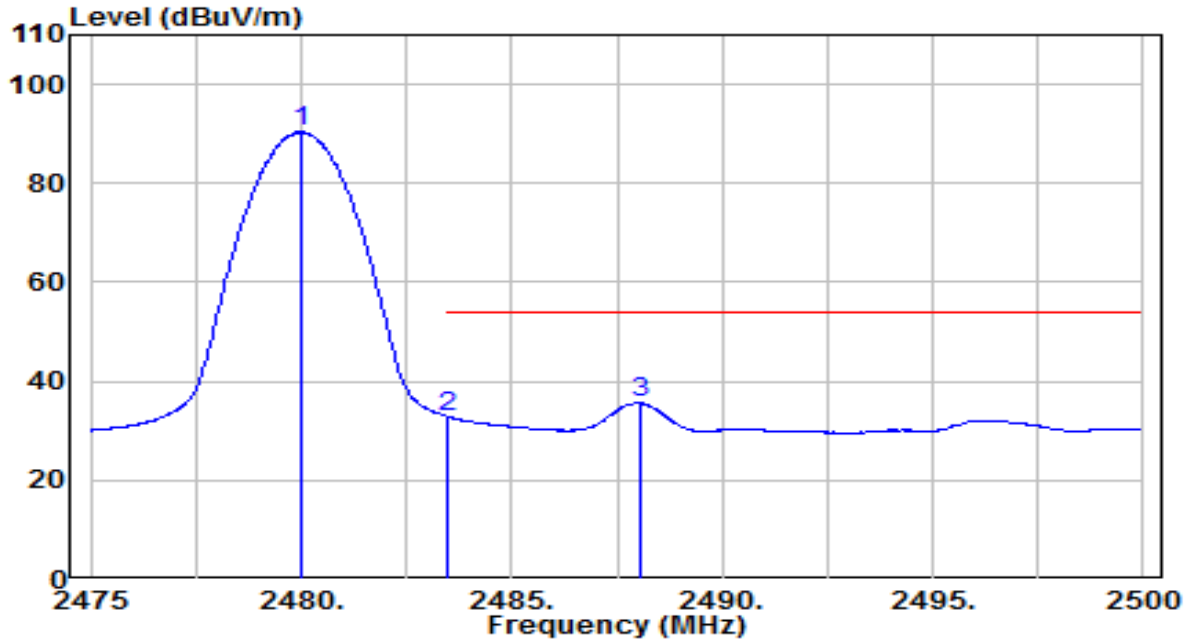

| No | Frequency (MHz) | Reading (dBuV) | C.F (dB/m) | Measurement (dBuV/m) | Margin (dB) | Limit (dBuV/m) | Height (cm) | Angle (deg) | Remark (QP/PK/AV) |
|----|-----------------|----------------|------------|----------------------|-------------|----------------|-------------|-------------|-------------------|
| 1  | 2479.975        | 92.10          | -1.75      | 90.35                | N/A         | N/A            | 260         | 330         | Average           |
| 2  | 2483.500        | 34.52          | -1.74      | 32.78                | -21.22      | 54.00          | 260         | 330         | Average           |
| 3  | * 2488.050      | 37.39          | -1.73      | 35.66                | -18.34      | 54.00          | 260         | 330         | Average           |

Note:

1. " \*", means this data is the worst emission level.
2. C.F (Correction Factor) = Antenna Factor (dB/m)+ Cable Loss (dB) – Preamplifier(dB).
3. Measurement (dBuV/m) = Reading(dBuV) + C.F (Correction Factor).
4. The emission levels of other frequencies are very lower than the limit and not show in test report.

|           |                   |                      |            |
|-----------|-------------------|----------------------|------------|
| EUT       | Gaming Mouse      | Date of Test         | 2023-03-31 |
| Factor    | BBHA 9120D        | Temp. / Humidity     | 23°C /63%  |
| Polarity  | Horizontal        | Site / Test Engineer | AC1 / Todd |
| Test Mode | BLE_TX_2Mbps_CH 0 | Test Voltage         | By Battery |

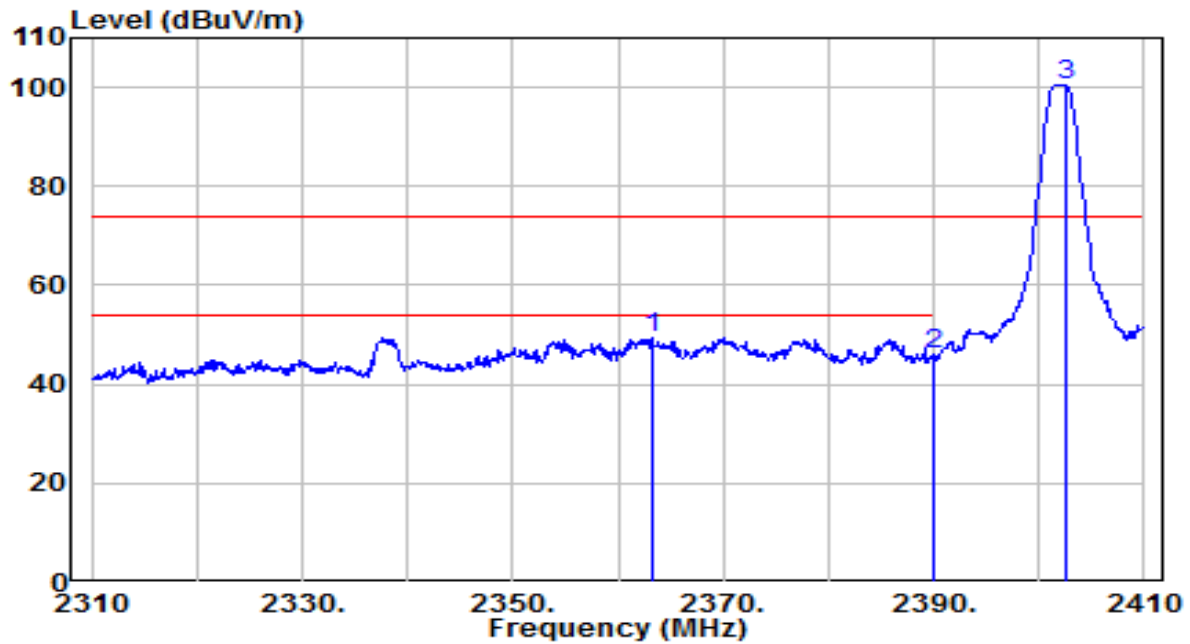

| No | Frequency (MHz) | Reading (dBuV) | C.F (dB/m) | Measurement (dBuV/m) | Margin (dB) | Limit (dBuV/m) | Height (cm) | Angle (deg) | Remark (QP/PK/AV) |
|----|-----------------|----------------|------------|----------------------|-------------|----------------|-------------|-------------|-------------------|
| 1  | 2363.300        | 51.49          | -2.12      | 49.37                | -24.63      | 74.00          | 145         | 215         | Peak              |
| 2  | 2390.000        | 48.01          | -2.04      | 45.97                | -28.03      | 74.00          | 145         | 215         | Peak              |
| 3  | * 2402.500      | 102.63         | -2.00      | 100.63               | N/A         | N/A            | 145         | 215         | Peak              |

Note:

1. " \*", means this data is the worst emission level.
2. C.F (Correction Factor) = Antenna Factor (dB/m)+ Cable Loss (dB) – Preamplifier(dB).
3. Measurement (dBuV/m) = Reading(dBuV) + C.F (Correction Factor).
4. The emission levels of other frequencies are very lower than the limit and not show in test report.

|           |                   |                      |            |
|-----------|-------------------|----------------------|------------|
| EUT       | Gaming Mouse      | Date of Test         | 2023-03-31 |
| Factor    | BBHA 9120D        | Temp. / Humidity     | 23°C /63%  |
| Polarity  | Vertical          | Site / Test Engineer | AC1 / Todd |
| Test Mode | BLE_TX_2Mbps_CH 0 | Test Voltage         | By Battery |

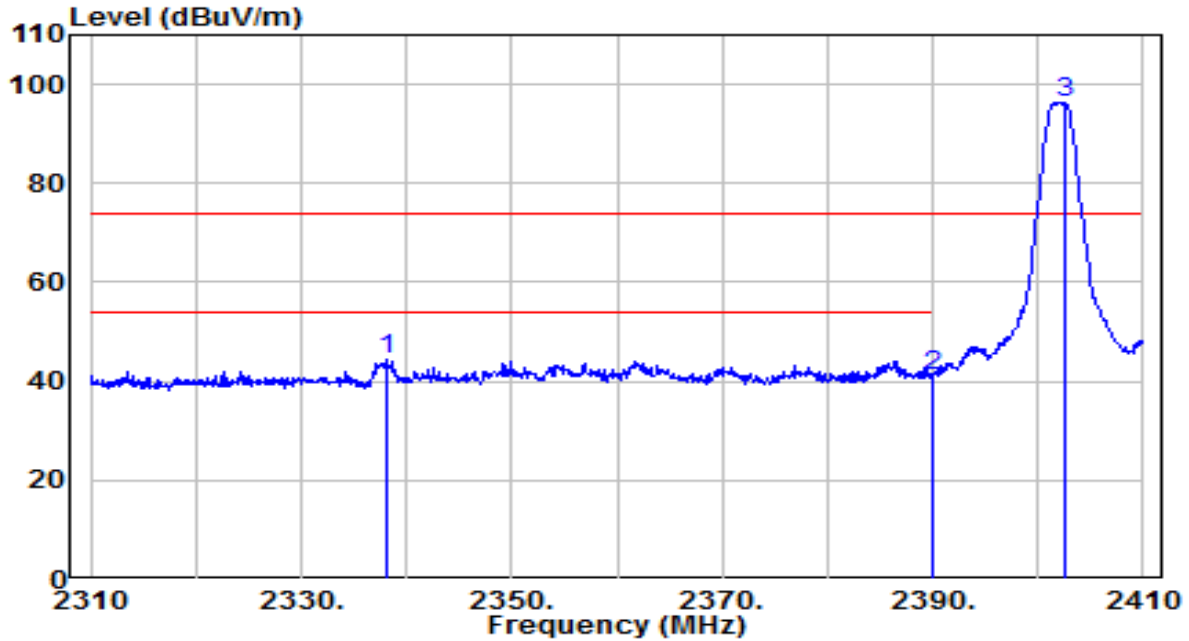

| No | Frequency (MHz) | Reading (dBuV) | C.F (dB/m) | Measurement (dBuV/m) | Margin (dB) | Limit (dBuV/m) | Height (cm) | Angle (deg) | Remark (QP/PK/AV) |
|----|-----------------|----------------|------------|----------------------|-------------|----------------|-------------|-------------|-------------------|
| 1  | 2338.100        | 46.41          | -2.20      | 44.21                | -29.79      | 74.00          | 275         | 330         | Peak              |
| 2  | 2390.000        | 43.31          | -2.04      | 41.28                | -32.72      | 74.00          | 275         | 330         | Peak              |
| 3  | * 2402.500      | 98.29          | -2.00      | 96.29                | N/A         | N/A            | 275         | 330         | Peak              |

Note:

1. " \*", means this data is the worst emission level.
2. C.F (Correction Factor) = Antenna Factor (dB/m)+ Cable Loss (dB) – Preamplifier(dB).
3. Measurement (dBuV/m) = Reading(dBuV) + C.F (Correction Factor).
4. The emission levels of other frequencies are very lower than the limit and not show in test report.

|           |                    |                      |            |
|-----------|--------------------|----------------------|------------|
| EUT       | Gaming Mouse       | Date of Test         | 2023-03-31 |
| Factor    | BBHA 9120D         | Temp. / Humidity     | 23°C /63%  |
| Polarity  | Horizontal         | Site / Test Engineer | AC1 / Todd |
| Test Mode | BLE_TX_2Mbps_CH 39 | Test Voltage         | By Battery |

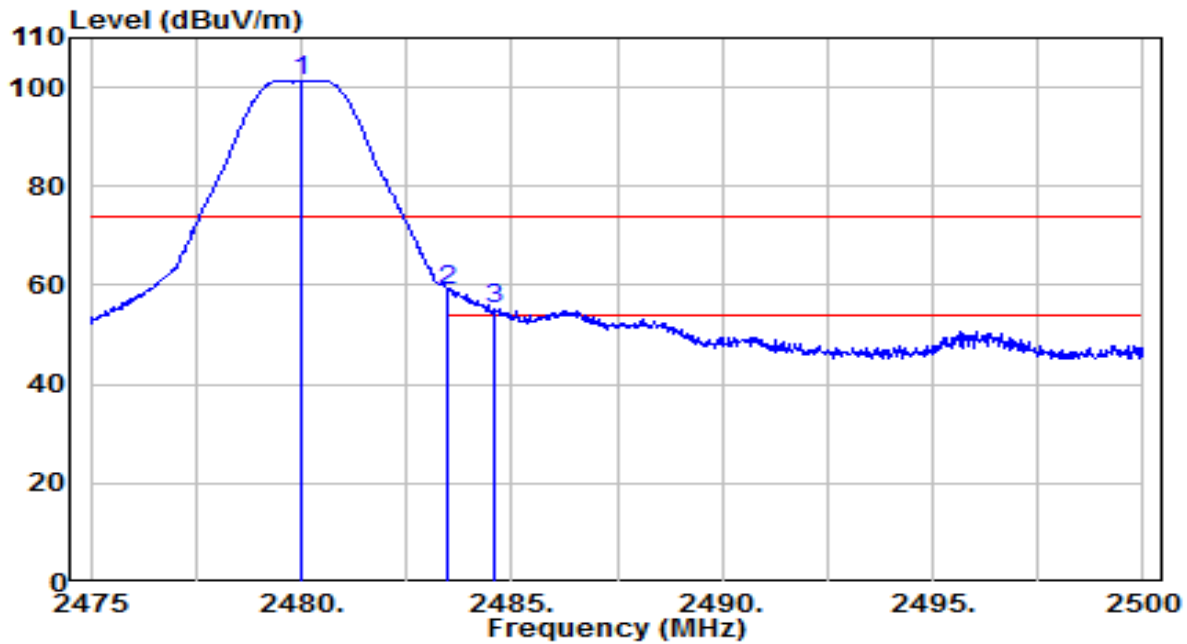

| No | Frequency (MHz) | Reading (dBuV) | C.F (dB/m) | Measurement (dBuV/m) | Margin (dB) | Limit (dBuV/m) | Height (cm) | Angle (deg) | Remark (QP/PK/AV) |
|----|-----------------|----------------|------------|----------------------|-------------|----------------|-------------|-------------|-------------------|
| 1  | 2479.975        | 103.14         | -1.75      | 101.38               | N/A         | N/A            | 255         | 210         | Peak              |
| 2  | * 2483.500      | 60.68          | -1.74      | 58.94                | -15.06      | 74.00          | 255         | 210         | Peak              |
| 3  | 2484.575        | 57.01          | -1.74      | 55.27                | -18.73      | 74.00          | 255         | 210         | Peak              |

Note:

1. " \*", means this data is the worst emission level.
2. C.F (Correction Factor) = Antenna Factor (dB/m)+ Cable Loss (dB) – Preamplifier(dB).
3. Measurement (dBuV/m) = Reading(dBuV) + C.F (Correction Factor).
4. The emission levels of other frequencies are very lower than the limit and not show in test report.



|           |                    |                      |            |
|-----------|--------------------|----------------------|------------|
| EUT       | Gaming Mouse       | Date of Test         | 2023-03-31 |
| Factor    | BBHA 9120D         | Temp. / Humidity     | 23°C /63%  |
| Polarity  | Horizontal         | Site / Test Engineer | AC1 / Todd |
| Test Mode | BLE_TX_2Mbps_CH 39 | Test Voltage         | By Battery |

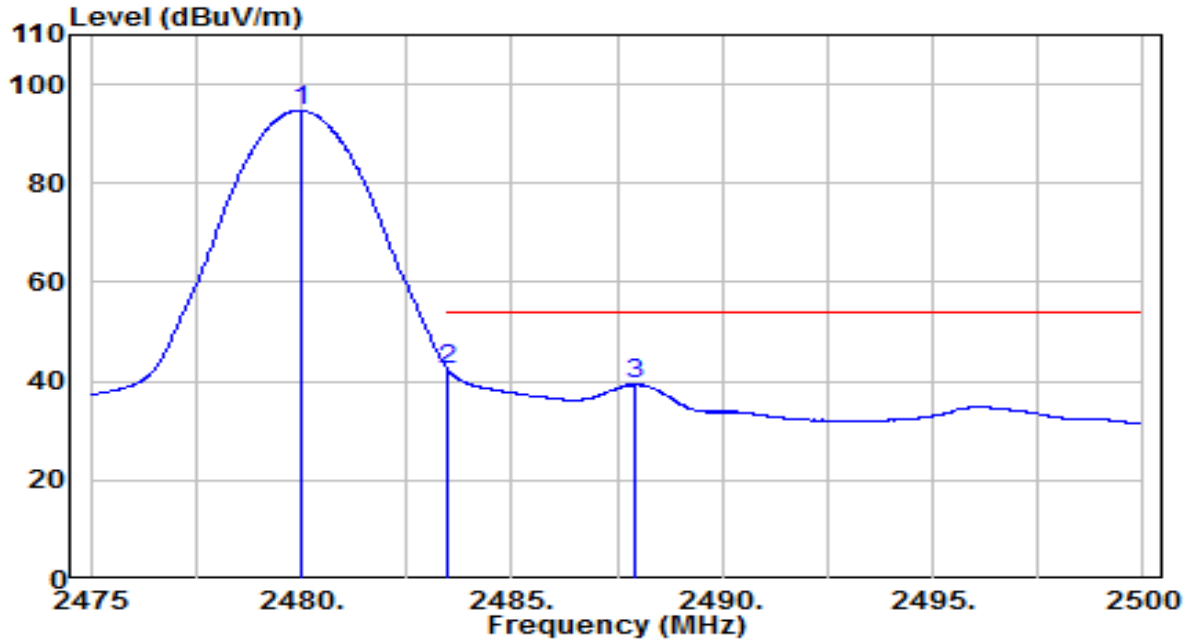

| No | Frequency (MHz) | Reading (dBuV) | C.F (dB/m) | Measurement (dBuV/m) | Margin (dB) | Limit (dBuV/m) | Height (cm) | Angle (deg) | Remark (QP/PK/AV) |
|----|-----------------|----------------|------------|----------------------|-------------|----------------|-------------|-------------|-------------------|
| 1  | 2479.975        | 96.56          | -1.75      | 94.81                | N/A         | N/A            | 255         | 210         | Average           |
| 2  | * 2483.500      | 43.90          | -1.74      | 42.16                | -11.84      | 54.00          | 255         | 210         | Average           |
| 3  | 2487.950        | 41.11          | -1.73      | 39.39                | -14.61      | 54.00          | 255         | 210         | Average           |

Note:

1. " \*", means this data is the worst emission level.
2. C.F (Correction Factor) = Antenna Factor (dB/m)+ Cable Loss (dB) – Preamplifier(dB).
3. Measurement (dBuV/m) = Reading(dBuV) + C.F (Correction Factor).
4. The emission levels of other frequencies are very lower than the limit and not show in test report.

|           |                    |                      |            |
|-----------|--------------------|----------------------|------------|
| EUT       | Gaming Mouse       | Date of Test         | 2023-03-31 |
| Factor    | BBHA 9120D         | Temp. / Humidity     | 23°C /63%  |
| Polarity  | Vertical           | Site / Test Engineer | AC1 / Todd |
| Test Mode | BLE_TX_2Mbps_CH 39 | Test Voltage         | By Battery |

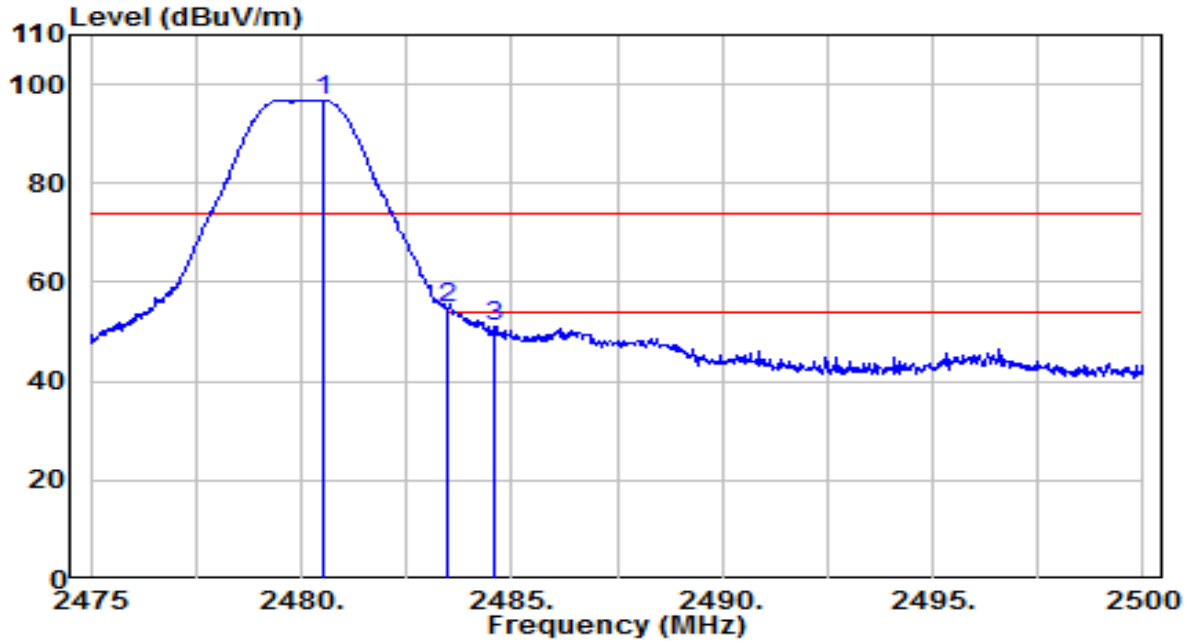

| No | Frequency (MHz) | Reading (dBuV) | C.F (dB/m) | Measurement (dBuV/m) | Margin (dB) | Limit (dBuV/m) | Height (cm) | Angle (deg) | Remark (QP/PK/AV) |
|----|-----------------|----------------|------------|----------------------|-------------|----------------|-------------|-------------|-------------------|
| 1  | 2480.525        | 98.57          | -1.75      | 96.82                | N/A         | N/A            | 260         | 325         | Peak              |
| 2  | * 2483.500      | 56.63          | -1.74      | 54.89                | -19.11      | 74.00          | 260         | 325         | Peak              |
| 3  | 2484.575        | 52.95          | -1.74      | 51.21                | -22.79      | 74.00          | 260         | 325         | Peak              |

Note:

1. " \*", means this data is the worst emission level.
2. C.F (Correction Factor) = Antenna Factor (dB/m)+ Cable Loss (dB) – Preamplifier(dB).
3. Measurement (dBuV/m) = Reading(dBuV) + C.F (Correction Factor).
4. The emission levels of other frequencies are very lower than the limit and not show in test report.

|           |                    |                      |            |
|-----------|--------------------|----------------------|------------|
| EUT       | Gaming Mouse       | Date of Test         | 2023-03-31 |
| Factor    | BBHA 9120D         | Temp. / Humidity     | 23°C /63%  |
| Polarity  | Vertical           | Site / Test Engineer | AC1 / Todd |
| Test Mode | BLE_TX_2Mbps_CH 39 | Test Voltage         | By Battery |

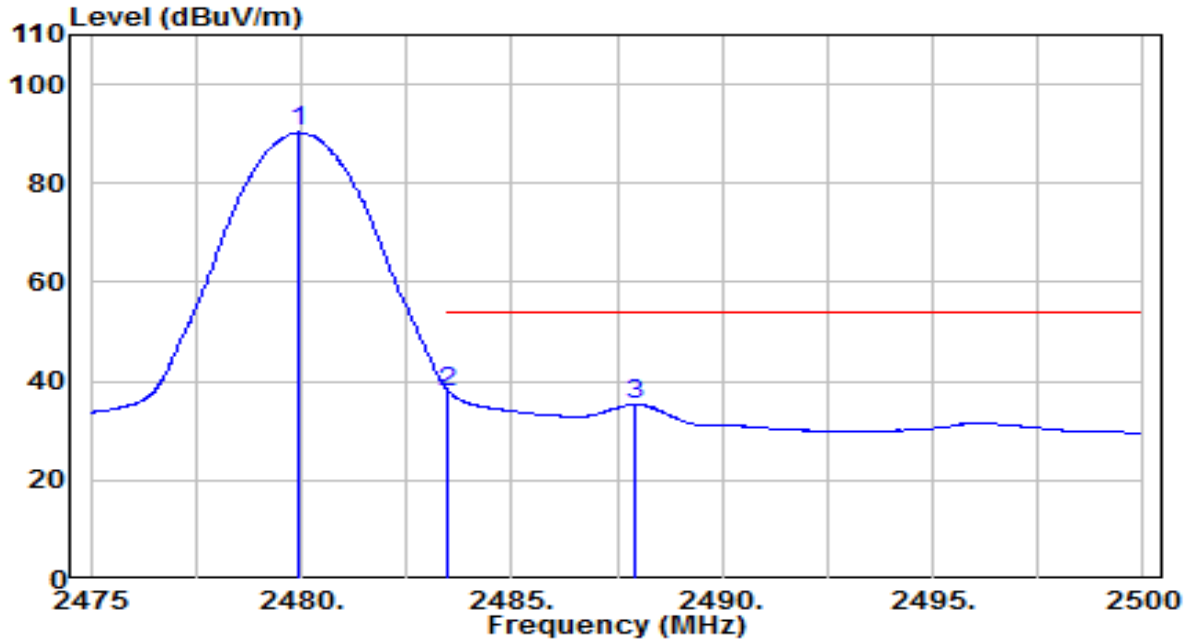

| No | Frequency (MHz) | Reading (dBuV) | C.F (dB/m) | Measurement (dBuV/m) | Margin (dB) | Limit (dBuV/m) | Height (cm) | Angle (deg) | Remark (QP/PK/AV) |
|----|-----------------|----------------|------------|----------------------|-------------|----------------|-------------|-------------|-------------------|
| 1  | 2479.925        | 92.04          | -1.75      | 90.29                | N/A         | N/A            | 260         | 325         | Average           |
| 2  | * 2483.500      | 39.70          | -1.74      | 37.96                | -16.04      | 54.00          | 260         | 325         | Average           |
| 3  | 2487.950        | 37.08          | -1.73      | 35.35                | -18.65      | 54.00          | 260         | 325         | Average           |

Note:

1. " \*", means this data is the worst emission level.
2. C.F (Correction Factor) = Antenna Factor (dB/m)+ Cable Loss (dB) – Preamplifier(dB).
3. Measurement (dBuV/m) = Reading(dBuV) + C.F (Correction Factor).
4. The emission levels of other frequencies are very lower than the limit and not show in test report.

## 7.8. AC Conducted Emissions Measurement

### 7.8.1. Test Limit

| FCC Part 15 Subpart C Paragraph 15.207 / RSS-Gen Limits |                 |                      |
|---------------------------------------------------------|-----------------|----------------------|
| Frequency (MHz)                                         | QP (dB $\mu$ V) | Average (dB $\mu$ V) |
| 0.15 - 0.50                                             | 66 - 56         | 56 - 46              |
| 0.50 - 5.0                                              | 56              | 46                   |
| 5.0 - 30                                                | 60              | 50                   |

Note 1: The lower limit shall apply at the transition frequencies.

Note 2: The limit decreases linearly with the logarithm of the frequency in the range 0.15MHz to 0.5MHz.

### 7.8.2. Test Setup

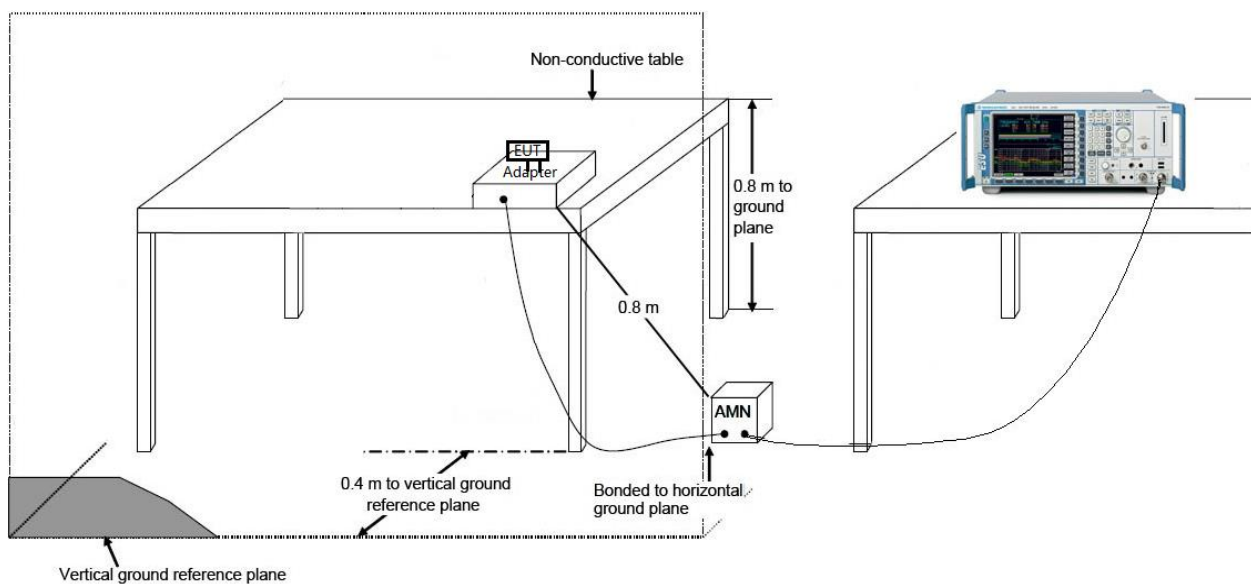

### **7.8.3. Test Result**

The DUT is battery-powered and has no power port, so it is not necessary to test power conduction.

## 8. CONCLUSION

The data collected relate only the item(s) tested and show that the **Gaming Mouse** is in compliance with Part 15C of the FCC Rules.

## **Appendix A : Test Photograph**

Refer to “2303TWE917-UT” file.

## **Appendix B : External Photograph**

Refer to “2303TWE917-UE” file.

## **Appendix C : Internal Photograph**

Refer to “2303TWE917-UI” file.

————— The End —————