

Product Name: Gaming Mouse	Report No: FCC022022-5666RF6
Product Model: RZ01-0440	Security Classification: Open
Version: V1.0	Total Page:65

TIRT Testing Report



Prepared By:	Checked By:	Approved By:	
Stone Tang	Randy Lv	Daniel Chen	
<i>Stone Tang</i>	<i>Randy Lv</i>	<i>Daniel Chen</i>	

FCC Radio Test Report

FCC ID: RWO-RZ010440

This report concerns: Original Grant

Project No. : 022022-5666
Equipment : Gaming Mouse
Brand Name : RAZER
Test Model : RZ01-0440
Series Model : RZ01-0440XXX-XXXX(X can be 0-9 or A-Z)
Applicant : Razer Inc.
Address : 9 Pasteur, Suite 100, Irvine, CA92618, USA
Manufacturer : Razer (Asia-Pacific) Pte.,Ltd.
Address : 1 one-north Crescent, #02-01 Singapore 138538
Factory : RAZER TECHNOLOGY AND DEVELOPMENT (SHENZHEN) CO., LTD
Address : East Wing, 3rd Floor, Block 2, Phase 1 of Vision Shenzhen Business Park Keji South Road, Hi-Tech Industrial Park, Shenzhen 518057, China
Date of Receipt : 2022.10.08
Date of Test : 2022.10.10 ~ 2022.11.02
Issued Date : 2022.11.03
Report Version : V1.0
Test Sample : Engineering Sample No.: 20221008019070
Standard(s) : FCC CFR Title 47, Part 15, Subpart C
FCC KDB 558074 D01 15.247 Meas Guidance v05r02
ANSI C63.10-2013

- The test result referred exclusively to the presented test model /sample.
- Without written approval of TIRT Inc. the test report shall not reproduced except in full.

Add: 101,3 # Factory Building, Gongjin Electronics Shatin Community, Kengzi Street,
Pingshan District, Shenzhen, China

TEL: +86-0755-27087573

Table of Contents

Page

REPORT ISSUED HISTORY	6
1 . SUMMARY OF TEST RESULTS	7
1.1 TEST FACILITY	8
1.2 MEASUREMENT UNCERTAINTY	8
1.3 TEST ENVIRONMENT CONDITIONS	8
2 . GENERAL INFORMATION	9
2.1 GENERAL DESCRIPTION OF EUT	9
2.2 DESCRIPTION OF TEST MODES	11
2.3 PARAMETERS OF TEST SOFTWARE	11
2.4 BLOCK DIAGRAM SHOWING THE CONFIGURATION OF SYSTEM TESTED	12
2.5 SUPPORT UNITS	12
3 . AC POWER LINE CONDUCTED EMISSIONS	13
3.1 LIMIT	13
3.2 TEST PROCEDURE	13
3.3 DEVIATION FROM TEST STANDARD	13
3.4 TEST SETUP	14
3.5 EUT OPERATING CONDITIONS	14
3.6 TEST RESULTS	14
4 . RADIATED EMISSIONS	15
4.1 LIMIT	15
4.2 TEST PROCEDURE	16
4.3 DEVIATION FROM TEST STANDARD	17
4.4 TEST SETUP	17
4.5 EUT OPERATING CONDITIONS	18
4.6 TEST RESULT - 9 KHZ TO 30 MHZ	18
4.7 TEST RESULT - 30 MHZ TO 1000 MHZ	18
4.8 TEST RESULT - ABOVE 1000 MHZ	18
5 . BANDWIDTH	19
5.1 LIMIT	19
5.2 TEST PROCEDURE	19
5.3 DEVIATION FROM STANDARD	19
5.4 TEST SETUP	19

Table of Contents	Page
5.5 EUT OPERATION CONDITIONS	19
5.6 TEST RESULTS	19
6 . MAXIMUM OUTPUT POWER	20
6.1 LIMIT	20
6.2 TEST PROCEDURE	20
6.3 DEVIATION FROM STANDARD	20
6.4 TEST SETUP	20
6.5 EUT OPERATION CONDITIONS	20
6.6 TEST RESULTS	20
7 . CONDUCTED SPURIOUS EMISSION	21
7.1 LIMIT	21
7.2 TEST PROCEDURE	21
7.3 DEVIATION FROM STANDARD	21
7.4 TEST SETUP	21
7.5 EUT OPERATION CONDITIONS	21
7.6 TEST RESULTS	21
8 . POWER SPECTRAL DENSITY	22
8.1 LIMIT	22
8.2 TEST PROCEDURE	22
8.3 DEVIATION FROM STANDARD	22
8.4 TEST SETUP	22
8.5 EUT OPERATION CONDITIONS	22
8.6 TEST RESULTS	22
9 . MEASUREMENT INSTRUMENTS LIST	23
APPENDIX A - AC POWER LINE CONDUCTED EMISSIONS	24
APPENDIX B - RADIATED EMISSION - 9 KHZ TO 30 MHZ	27
APPENDIX C - RADIATED EMISSION - 30 MHZ TO 1000 MHZ	28
APPENDIX D - RADIATED EMISSION - ABOVE 1000 MHZ	31
APPENDIX E - BANDWIDTH	56
APPENDIX F - MAXIMUM OUTPUT POWER	59
APPENDIX G - CONDUCTED SPURIOUS EMISSION	61

Table of Contents

Page

APPENDIX H - POWER SPECTRAL DENSITY

64

REPORT ISSUED HISTORY

Report No.	Version	Description	Issued Date	Note
FCC022022-5666RF6	V1.0	Original Report.	2022.11.03	Valid

1. SUMMARY OF TEST RESULTS

Test procedures according to the technical standard(s):

FCC CFR Title 47, Part 15, Subpart C				
Standard(s) Section	Test Item	Test Result	Judgment	Remark
15.207	AC Power Line Conducted Emissions	APPENDIX A	PASS	-----
15.247(d) 15.205(a) 15.209(a)	Radiated Emissions	APPENDIX B APPENDIX C APPENDIX D	PASS	-----
15.247(a)(2)	Bandwidth	APPENDIX E	PASS	-----
15.247(b)(3)	Maximum Output Power	APPENDIX F	PASS	-----
15.247(d)	Conducted Spurious Emission	APPENDIX G	PASS	-----
15.247(e)	Power Spectral Density	APPENDIX H	PASS	-----
15.203	Antenna Requirement	-----	PASS	Note(2)

NOTE:

- (1) "N/A" denotes test is not applicable to this device.
- (2) The device what use a permanently attached antenna were considered sufficient to comply with the provisions of 15.203.

1.1 TEST FACILITY

Company:	Beijing TIRT Technology Service Co.,Ltd Shenzhen
Address:	101, 3 # Factory Building, Gongjin Electronics Shatin Community, Kengzi Street, Pingshan District, Shenzhen, China
CNAS Registration Number:	CNAS L14158
A2LA Registration Number:	6049.01
FCC Accredited Lab. Designation Number:	CN1309
FCC Test Firm Registration Number:	825524
Telephone:	+86-0755-27087573

1.2 MEASUREMENT UNCERTAINTY

ISO/IEC 17025 requires that an estimate of the measurement uncertainties associated with the emissions test results be included in the report. The measurement uncertainties given below are based on a 95% confidence level (based on a coverage factor (k=2))
 The TIRT measurement uncertainty as below table:

Parameter	Uncertainty
Occupied Channel Bandwidth	±142.12 KHz
RF power conducted	±0.74 dB
RF power radiated	±3.25dB
Spurious emissions, conducted	±1.78dB
Spurious emissions, radiated (30MHz~1GHz)	±4.6dB
Spurious emissions, radiated (1GHz ~ 18GHz)	±4.9dB
Conduction Emissions(150kHz~30MHz)	±3.1 dB
Humidity	±4.6%
Temperature	±0.7°C
Time	±1.25%

Note: Unless specifically mentioned, the uncertainty of measurement has not been taken into account to declare the compliance or non-compliance to the specification.

1.3 TEST ENVIRONMENT CONDITIONS

Test Item	Temperature	Humidity	Test Voltage	Tested By
AC Power Line Conducted Emissions	22.2°C	51%	AC 120V/60Hz	Stone Tang
Radiated Emissions-9 kHz to 30 MHz	23.5°C	55%	DC 5V	Stone Tang
Radiated Emissions-30 MHz to 1000 MHz	23.5°C	52%	DC 5V	Stone Tang
Radiated Emissions-Above 1000 MHz	17°C~21°C	56%~47%	DC 5V	Stone Tang
Bandwidth	20°C~23°C	52%~55%	DC 5V	Stone Tang
Maximum Output Power	20°C~23°C	52%~55%	DC 5V	Stone Tang
Conducted Spurious Emission	20°C~23°C	52%~55%	DC 5V	Stone Tang
Power Spectral Density	20°C~23°C	52%~55%	DC 5V	Stone Tang

2. GENERAL INFORMATION

2.1 GENERAL DESCRIPTION OF EUT

Equipment	Gaming Mouse
Brand Name	RAZER
Test Model	RZ01-0440
Series Model	RZ01-0440XXXX-XXXX(X can be 0-9 or A-Z)
Model Difference(s)	The system's model name is RZ01-0440XXXX-XXXX (X: Can be 0-9, A-Z), and the system contains a Gaming Mouse (Model name: RZ01-0440) and USB Dongle (Model name: DGRFG7).
Power Source	1# Supplied from USB Port. 2# Supplied from battery. Model: PL803040
Power Rating	1# 5V==500mA 2# DC 3.7V, 1000mAh, 3.7Wh
Operation Frequency	2402 MHz ~ 2480 MHz
Modulation Type	GFSK
Bit Rate of Transmitter	1Mbps, 2Mbps
Max. Output Power	2Mbps: 5.62 dBm (0.0036 W)

Note:

1. For a more detailed features description, please refer to the manufacturer's specifications or the user's manual.

2. Channel List:

Channel	Frequency (MHz)	Channel	Frequency (MHz)
00	2402	20	2442
01	2404	21	2444
02	2406	22	2446
03	2408	23	2448
04	2410	24	2450
05	2412	25	2452
06	2414	26	2454
07	2416	27	2456
08	2418	28	2458
09	2420	29	2460
10	2422	30	2462
11	2424	31	2464
12	2426	32	2466
13	2428	33	2468
14	2430	34	2470
15	2432	35	2472
16	2434	36	2474
17	2436	37	2476
18	2438	38	2478
19	2440	39	2480

3. Table for Filed Antenna:

Ant.	Brand	Model Name	Antenna Type	Connector	Gain (dBi)
1	N/A	N/A	PCB	N/A	3.35

Note: The antenna gain is provided by the manufacturer.

2.2 DESCRIPTION OF TEST MODES

The test system was pre-tested based on the consideration of all possible combinations of EUT operation mode.

Pretest Mode	Description
Mode 1	TX Mode_1Mbps Channel 00/19/39
Mode 2	TX Mode_2Mbps Channel 00/19/39
Mode 3	TX Mode_2Mbps Channel 00

Following mode(s) was (were) found to be the worst case(s) and selected for the final test.

AC power line conducted emissions test	
Final Test Mode	Description
Mode 3	TX Mode_2Mbps Channel 00

Radiated emissions test - Below 1GHz	
Final Test Mode	Description
Mode 3	TX Mode_2Mbps Channel 00

Radiated emissions test - Above 1GHz	
Final Test Mode	Description
Mode 1	TX Mode_1Mbps Channel 00/19/39
Mode 2	TX Mode_2Mbps Channel 00/19/39

Conducted test	
Final Test Mode	Description
Mode 1	TX Mode_1Mbps Channel 00/19/39
Mode 2	TX Mode_2Mbps Channel 00/19/39

Note:

- (1) For radiated emission above 1 GHz test, the spurious points of 1GHz~26.5GHz have been pre-tested and in this report only recorded the worst case. The remaining spurious points are all below the limit value of 20dB.
- (2) For AC power line conducted emissions and radiated emissions below 1 GHz test, the 2Mbps Channel 00 is found to be the worst case and recorded.

2.3 PARAMETERS OF TEST SOFTWARE

Setup is implemented with mouse buttons and has no specific parameter values

Test Software Version	N/A		
Frequency (MHz)	2402	2440	2480
1Mbps	N/A	N/A	N/A
2Mbps	N/A	N/A	N/A

2.4 BLOCK DIAGRAM SHOWING THE CONFIGURATION OF SYSTEM TESTED

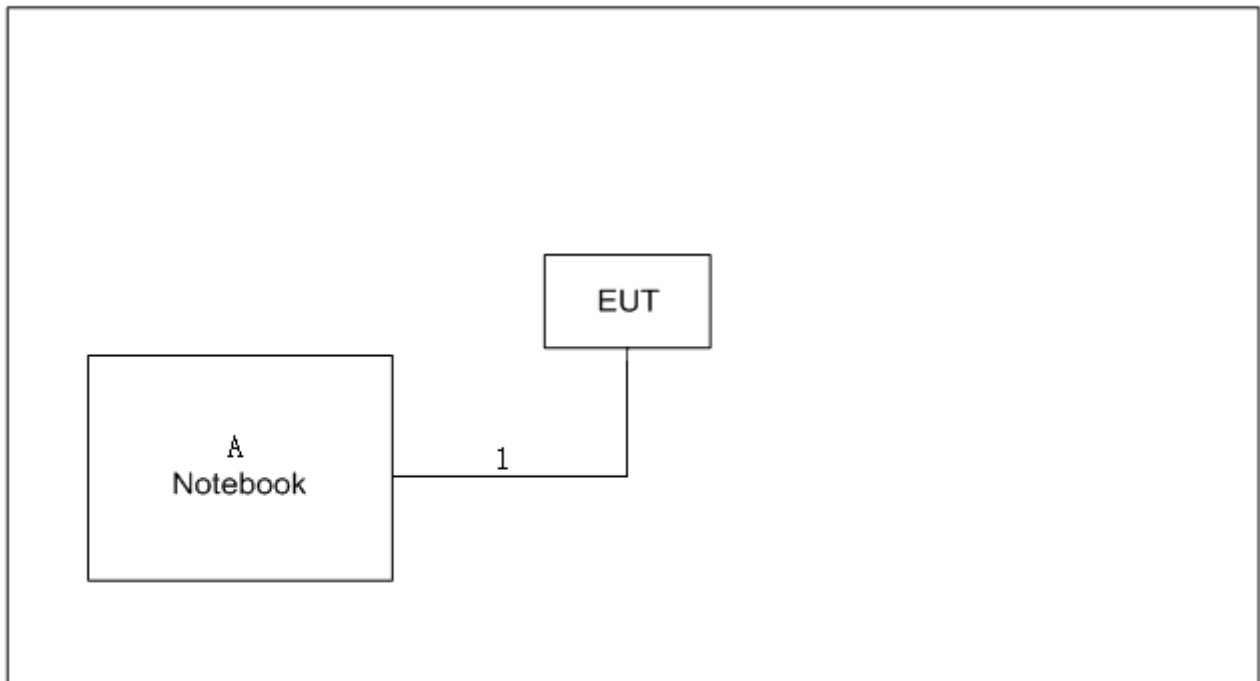

2.5 SUPPORT UNITS

Item	Equipment	Brand	Model No.	Series No.
A	Notebook	Lenovo	L450	N/A

Item	Cable Type	Shielded Type	Ferrite Core	Length
1	USB Cable	NO	NO	1.5m

3. AC POWER LINE CONDUCTED EMISSIONS

3.1 LIMIT

Frequency of Emission (MHz)	Limit (dB μ V)	
	Quasi-peak	Average
0.15 - 0.5	66 to 56*	56 to 46*
0.5 - 5.0	56	46
5.0 - 30.0	60	50

Note:

- (1) The tighter limit applies at the band edges.
- (2) The limit of " * " marked band means the limitation decreases linearly with the logarithm of the frequency in the range.

3.2 TEST PROCEDURE

- a. The EUT was placed 0.8 meters from the horizontal ground plane with EUT being connected to the power mains through a line impedance stabilization network (LISN). All other support equipment powered from additional LISN(s). The LISN provide 50 Ohm/ 50uH of coupling impedance for the measuring instrument.
- b. Interconnecting cables that hang closer than 40 cm to the ground plane shall be folded back and forth in the center forming a bundle 30 to 40 cm long.
- c. I/O cables that are not connected to a peripheral shall be bundled in the center. The end of the cable may be terminated, if required, using the correct terminating impedance. The overall length shall not exceed 1 m.
- d. LISN at least 80 cm from nearest part of EUT chassis.
- e. For the actual test configuration, please refer to the related Item –EUT Test Photos.

The following table is the setting of the receiver:

Receiver Parameters	Setting
Start Frequency	0.15 MHz
Stop Frequency	30 MHz
IF Bandwidth	9 kHz

3.3 DEVIATION FROM TEST STANDARD

No deviation.

3.4 TEST SETUP

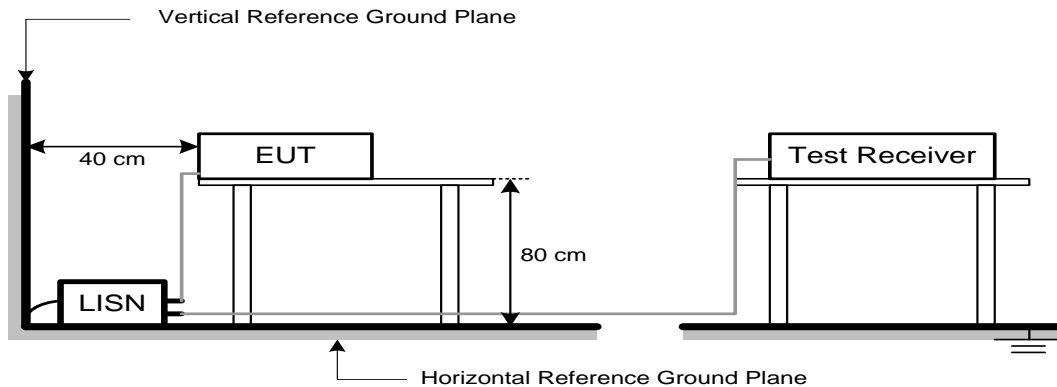

3.5 EUT OPERATING CONDITIONS

The EUT was configured for testing in a typical fashion (as a customer would normally use it). The EUT has been programmed to continuously transmit during test. This operating condition was tested and used to collect the included data.

3.6 TEST RESULTS

Please refer to the APPENDIX A.

Remark:

- (1) All readings are QP Mode value unless otherwise stated AVG in column of 『Note』 . If the QP Mode Measured value compliance with the QP Limits and lower than AVG Limits, the EUT shall be deemed to meet both QP & AVG Limits and then only QP Mode was measured, but AVG Mode didn't perform. In this case, a “ * ” marked in AVG Mode column of Interference Voltage Measured.
- (2) Measuring frequency range from 150 kHz to 30 MHz.

4. RADIATED EMISSIONS

4.1 LIMIT

In case the emission fall within the restricted band specified on 15.205(a), then the 15.209(a) limit in the table below has to be followed.

LIMITS OF RADIATED EMISSION MEASUREMENT (9 kHz-1000 MHz)

Frequency (MHz)	Field Strength (microvolts/meter)	Measurement Distance (meters)
0.009-0.490	2400/F(kHz)	300
0.490-1.705	24000/F(kHz)	30
1.705-30.0	30	30
30-88	100	3
88-216	150	3
216-960	200	3
Above 960	500	3

LIMITS OF RADIATED EMISSION MEASUREMENT (Above 1000 MHz)

Frequency (MHz)	(dBuV/m at 3 m)	
	Peak	Average
Above 1000	74	54

Note:

- (1) The limit for radiated test was performed according to FCC CFR Title 47, Part 15, Subpart C.
- (2) The tighter limit applies at the band edges.
- (3) Emission level (dBuV/m)=20log Emission level (uV/m).

4.2 TEST PROCEDURE

- a. The measuring distance of 3 m shall be used for measurements. The EUT was placed on the top of a rotating table 0.8 meter above the ground at a 3 meter semi-anechoic chamber. The table was rotated 360 degrees to determine the position of the highest radiation.(below 1 GHz)
- b. The measuring distance of 3 m shall be used for measurements. The EUT was placed on the top of a rotating table 1.5 meter above the ground at a 3 meter semi-anechoic chamber. The table was rotated 360 degrees to determine the position of the highest radiation.(above 1 GHz)
- c. The height of the equipment or of the substitution antenna shall be 0.8m or 1.5m; the height of the test antenna shall vary between 1 m to 4 m. Both horizontal and vertical polarizations of the antenna are set to make the measurement.
- d. For each suspected emission, the EUT was arranged to its worst case and then the antenna was tuned to heights find the maximum reading (used Bore sight function).
- e. The receiver system was set to peak and average detect function and specified bandwidth with maximum hold mode when the test frequency is above 1 GHz.
- f. The initial step in collecting radiated emission data is a receiver peak detector mode pre-scanning the measurement frequency range. Significant peaks are then marked and then Quasi Peak detector mode re-measured.
- g. All readings are Peak unless otherwise stated QP in column of Note. Peak denotes that the Peak reading compliance with the QP Limits and then QP Mode measurement didn't perform.
(below 1 GHz)
- h. All readings are Peak Mode value unless otherwise stated AVG in column of Note. If the Peak Mode Measured value compliance with the Peak Limits and lower than AVG Limits, the EUT shall be deemed to meet both Peak & AVG Limits and then only Peak Mode was measured, but AVG Mode didn't perform. (above 1 GHz)
- i. For the actual test configuration, please refer to the related Item –EUT Test Photos.

The following table is the setting of the receiver:

Spectrum Parameters	Setting
Start ~ Stop Frequency	9 kHz~150 kHz for RBW 200 Hz
Start ~ Stop Frequency	0.15 MHz~30 MHz for RBW 9 kHz
Start ~ Stop Frequency	30 MHz~1000 MHz for RBW 100 kHz

Spectrum Parameters	Setting
Start Frequency	1000 MHz
Stop Frequency	10th carrier harmonic
RBW / VBW (Emission in restricted band)	1 MHz / 3 MHz for PK value 1 MHz / 1/T Hz for AVG value

Spectrum Parameters	Setting
Start ~ Stop Frequency	9 kHz~90 kHz for PK/AVG detector
Start ~ Stop Frequency	90 kHz~110 kHz for QP detector
Start ~ Stop Frequency	110 kHz~490 kHz for PK/AVG detector
Start ~ Stop Frequency	490 kHz~30 MHz for QP detector
Start ~ Stop Frequency	30 MHz~1000 MHz for QP detector
Start ~ Stop Frequency	1 GHz~26.5 GHz for PK/AVG detector

4.3 DEVIATION FROM TEST STANDARD

No deviation.

4.4 TEST SETUP

9 kHz to 30 MHz

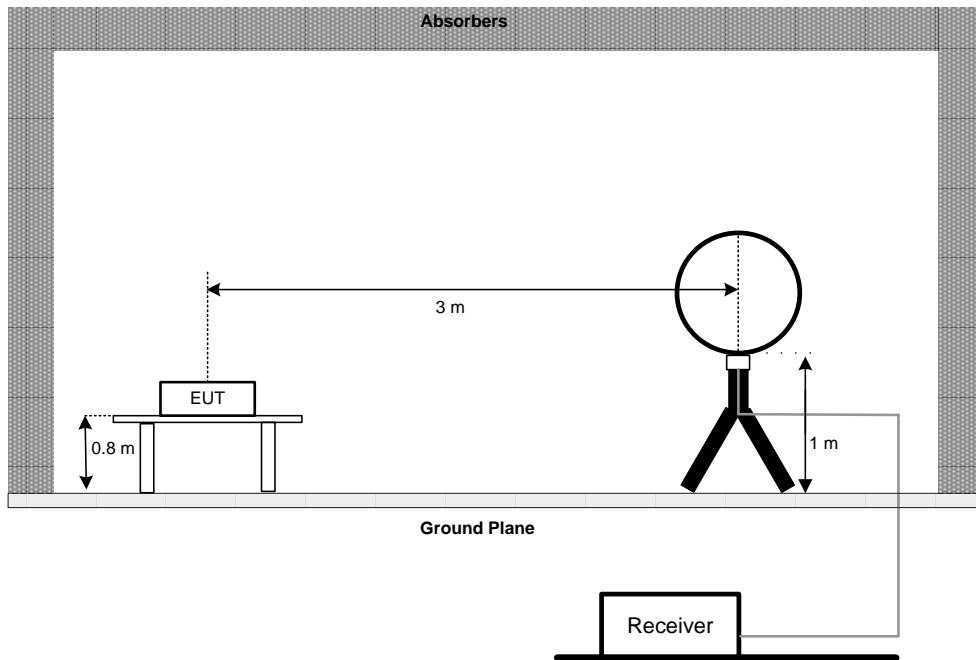

30 MHz to 1 GHz

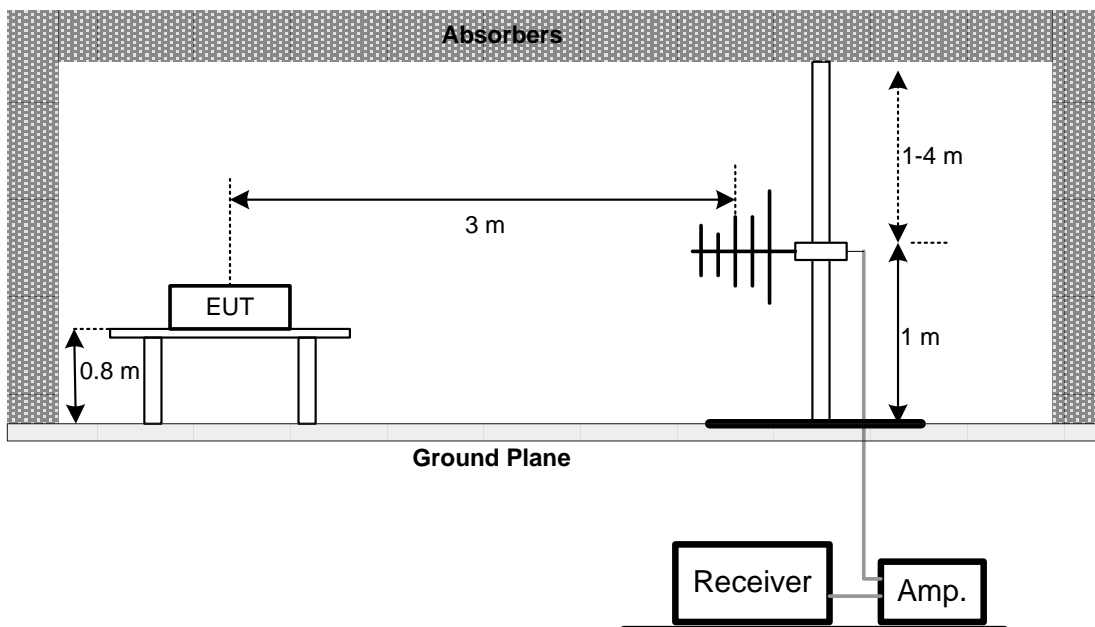

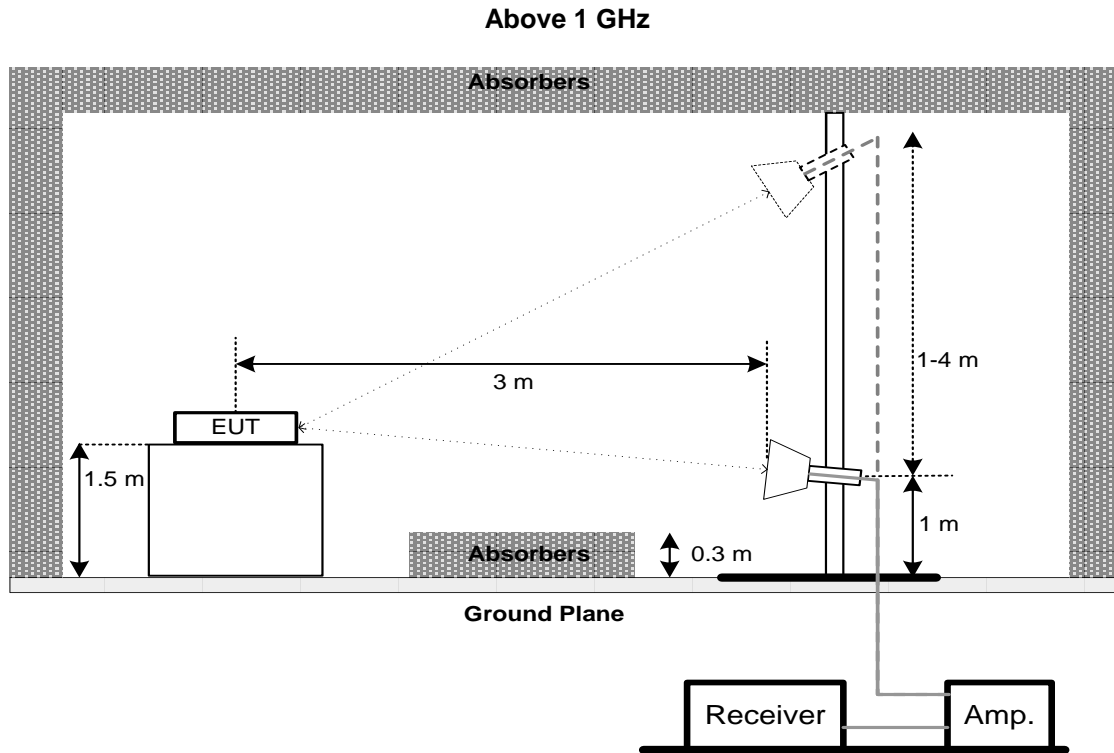

4.5 EUT OPERATING CONDITIONS

The EUT was programmed to be in continuously transmitting mode.

4.6 TEST RESULT - 9 kHz TO 30 MHz

Please refer to the APPENDIX B.

Remark:

- (1) Distance extrapolation factor = $40 \log (\text{specific distance} / \text{test distance})$ (dB).
- (2) Limit line = specific limits (dBuV) + distance extrapolation factor.

4.7 TEST RESULT - 30 MHz TO 1000 MHz

Please refer to the APPENDIX C.

4.8 TEST RESULT - ABOVE 1000 MHz

Please refer to the APPENDIX D.

Remark:

- (1) No limit: This is fundamental signal, the judgment is not applicable.
For fundamental signal judgment was referred to Peak output test.

5. BANDWIDTH

5.1 LIMIT

Section	Test Item	Limit
FCC 15.247(a)(2)	6 dB Bandwidth	≥ 500 kHz
	99% Emission Bandwidth	-

5.2 TEST PROCEDURE

- The EUT was directly connected to the spectrum analyzer and antenna output port as show in the block diagram below.
- The following table is the setting of the spectrum analyzer:

For 6 dB Bandwidth:

Spectrum Parameters	Setting
Span Frequency	$>$ Measurement Bandwidth
RBW	100 kHz
VBW	300 kHz
Detector	Peak
Trace	Max Hold
Sweep Time	Auto

For 99% Emission Bandwidth:

Spectrum Parameters	Setting
Span Frequency	Between 1.5 times and 5.0 times the OBW
RBW	30 kHz
VBW	100 kHz
Detector	Peak
Trace	Max Hold
Sweep Time	Auto

5.3 DEVIATION FROM STANDARD

No deviation.

5.4 TEST SETUP



5.5 EUT OPERATION CONDITIONS

The EUT was programmed to be in continuously transmitting mode.

5.6 TEST RESULTS

Please refer to the APPENDIX E.

6. MAXIMUM OUTPUT POWER

6.1 LIMIT

Section	Test Item	Limit
FCC 15.247(b)(3)	Maximum Output Power	1.0000 watt or 30.00 dBm

6.2 TEST PROCEDURE

- a. The EUT was directly connected to the spectrum analyzer and antenna output port as show in the block diagram below.
- b. The following table is the setting of the spectrum analyzer:

Spectrum Parameters	Setting
Span Frequency	$\geq 3 \times \text{RBW}$
RBW	3 MHz
VBW	3 MHz
Detector	Peak
Trace	Max Hold
Sweep Time	Auto

6.3 DEVIATION FROM STANDARD

No deviation.

6.4 TEST SETUP

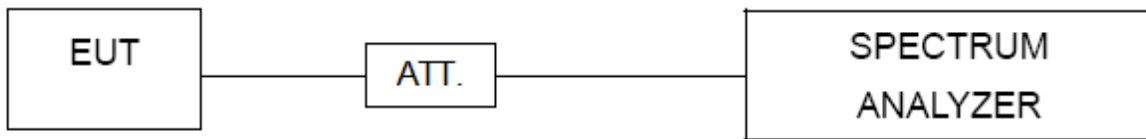

6.5 EUT OPERATION CONDITIONS

The EUT was programmed to be in continuously transmitting mode.

6.6 TEST RESULTS

Please refer to the APPENDIX F.

7. CONDUCTED SPURIOUS EMISSION

7.1 LIMIT

In any 100 kHz bandwidth outside the frequency band in which the spread spectrum or digitally modulated intentional radiator is operating, the radio frequency power that is produced by the intentional radiator shall be at least 20 dB below that in the 100 kHz bandwidth within the band that contains the highest level of the desired power, based on either an RF conducted or a radiated measurement, provided the transmitter demonstrates compliance with the peak Output Power limits. If the transmitter complies with the Output Power limits based on the use of RMS averaging over a time interval, as permitted under paragraph (b)(3) of this section, the attenuation required under this paragraph shall be 30 dB instead of 20 dB. Attenuation below the general limits specified in Section 15.209(a) is not required.

7.2 TEST PROCEDURE

- a. The EUT was directly connected to the spectrum analyzer and antenna output port as show in the block diagram below.
- b. The following table is the setting of the spectrum analyzer:

Spectrum Parameters	Setting
Start Frequency	30 MHz
Stop Frequency	26.5 GHz
RBW	100 kHz
VBW	300 kHz
Detector	Peak
Trace	Max Hold
Sweep Time	Auto

7.3 DEVIATION FROM STANDARD

No deviation.

7.4 TEST SETUP

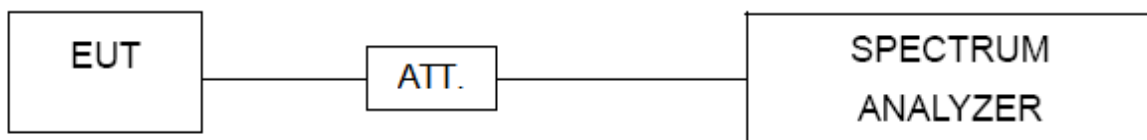

7.5 EUT OPERATION CONDITIONS

The EUT was programmed to be in continuously transmitting mode.

7.6 TEST RESULTS

Please refer to the APPENDIX G.

8. POWER SPECTRAL DENSITY

8.1 LIMIT

Section	Test Item	Limit
FCC 15.247(e)	Power Spectral Density	8 dBm (in any 3 kHz)

8.2 TEST PROCEDURE

- a. The EUT was directly connected to the spectrum analyzer and antenna output port as show in the block diagram below.
- b. The following table is the setting of the spectrum analyzer:

Spectrum Parameters	Setting
Span Frequency	2 MHz (1 Mbps) / 4 MHz (2 Mbps)
RBW	3 kHz
VBW	10 kHz
Detector	Peak
Trace	Max Hold
Sweep Time	Auto

8.3 DEVIATION FROM STANDARD

No deviation.

8.4 TEST SETUP



8.5 EUT OPERATION CONDITIONS

The EUT was programmed to be in continuously transmitting mode.

8.6 TEST RESULTS

Please refer to the APPENDIX H.

9. MEASUREMENT INSTRUMENTS LIST

No.	Equipment	Manufacturer	Type No.	Serial No.	Calibrated until
1	EMI Receiver	Rohde&Schwarz	ESCI	1166.5950.03	2022/11/09
2	AMN	Rohde&Schwarz	ENV216	3560.6550.05	2022/11/09
3	AMN	Schwarzbeck	NSLK8127	#829	2022/11/09
4	ECSI RF IN RF Cable	Rohde&Schwarz	RP-X1	N/A	2022/11/09
5	ECSI RF IN RF Cable	Rohde&Schwarz	Sapre sm	N/A	2022/11/09
6	EMI Receiver	Rohde&Schwarz	ESR7	102013	2022/11/09
7	Spectrum analyzer	Rohde&Schwarz	FSV30	103741	2022/11/09
8	Spectrum analyzer	KEYSIGHT	N9010A-44	MY51440158	2022/11/09
9	Integral Antenna	Schwarzbeck	VULB 9163	VULB 9163-361	2022/11/20
10	Loop Antenna*	Schwarzbeck	FMZB1519B	00029	2025/07/03
11	Integral Antenna	Schwarzbeck	BBHA 9120D	BBHA 9120D 1201	2022/11/20
12	Integral Antenna	Schwarzbeck	BBHA 9170	9170#685	2022/11/20
13	Preamplifier	Schwarzbeck	BBV9745	#78	2022/11/09
14	Preamplifier	Schwarzbeck	BBV9721	9721-019	2022/11/09
15	Preamplifier	RF System/UK	TRLA-01018 0G50B	22062101	2023/07/20
16	ECSI RF IN RF Cable	Rohde&Schwarz	AP-X1	N/A	2022/11/09
17	ECSI RF IN RF Cable	HAOXUN	Z-108	N/A	2022/11/09
18	RF Cable	ZDECL	ZT40-2.92J-2.92J-6M	18124358	2023/07/20
19	Spectrum Analyzer	Agilent	N9010A	MY51440158	2022/11/09
20	Spectrum Analyzer	Agilent	N9010A	MY52221119	2022/11/09
21	Spectrum Analyzer	KEYSIGHT	N9020B	MY57463781	2023/03/15
22	EMI Receiver	Rohde&Schwarz	ESU	100184	2023/07/20
23	Temp&Humidity Recorder	Anymetre	JR900	N/A	2022/11/03
24	Temp&Humidity Chamber	ETOMA	NTH1100-30 A	16080628	2022/11/03
25	Filter	STI	STI15-9845	N/A	N/A
26	Filter	STI	5.1G	N/A	N/A
27	Filter	STI	STI15-9845	N/A	N/A
28	Testing Software	EZ-EMC	TW-03A2	N/A	N/A

Remark "N/A" denotes no model name, serial no. or calibration specified.

"**" calibration period of equipment list is three year.

Except * item, all calibration period of equipment list is one year.

APPENDIX A - AC POWER LINE CONDUCTED EMISSIONS

Test Mode	TX Mode_2Mbps Channel 00	Phase	Line
-----------	--------------------------	-------	------

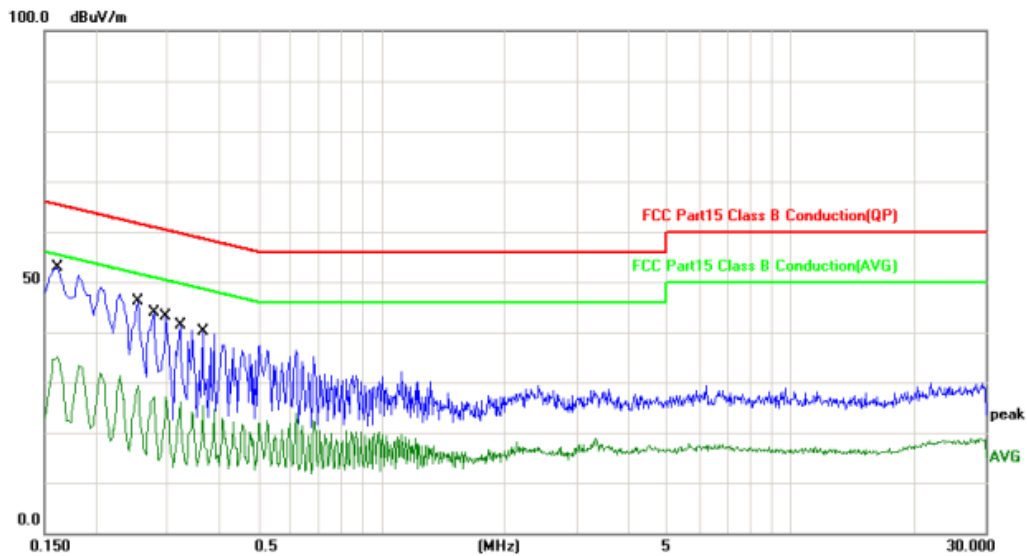

No.	Mk.	Freq.	Reading Level	Correct Factor	Measurement	Limit	Over	Detector	Comment
		MHz	dBuV/m	dB	dBuV/m	dBuV/m	dB		
1	*	0.1620	31.84	19.51	51.35	65.36	-14.01	QP	
2		0.1620	15.19	19.51	34.70	55.36	-20.66	AVG	
3		0.2540	24.24	19.53	43.77	61.63	-17.86	QP	
4		0.2540	8.43	19.53	27.96	51.63	-23.67	AVG	
5		0.2780	21.35	19.52	40.87	60.88	-20.01	QP	
6		0.2780	5.72	19.52	25.24	50.88	-25.64	AVG	
7		0.2980	21.24	19.52	40.76	60.30	-19.54	QP	
8		0.2980	6.37	19.52	25.89	50.30	-24.41	AVG	
9		0.3220	19.65	19.52	39.17	59.66	-20.49	QP	
10		0.3220	4.44	19.52	23.96	49.66	-25.70	AVG	
11		0.3660	18.29	19.52	37.81	58.59	-20.78	QP	
12		0.3660	2.80	19.52	22.32	48.59	-26.27	AVG	

REMARKS:

- (1) Measurement Value = Reading Level + Correct Factor.
 (2) Margin Level = Measurement Value - Limit Value.

Test Mode	TX Mode_2Mbps Channel 00	Phase	Neutral
-----------	--------------------------	-------	---------

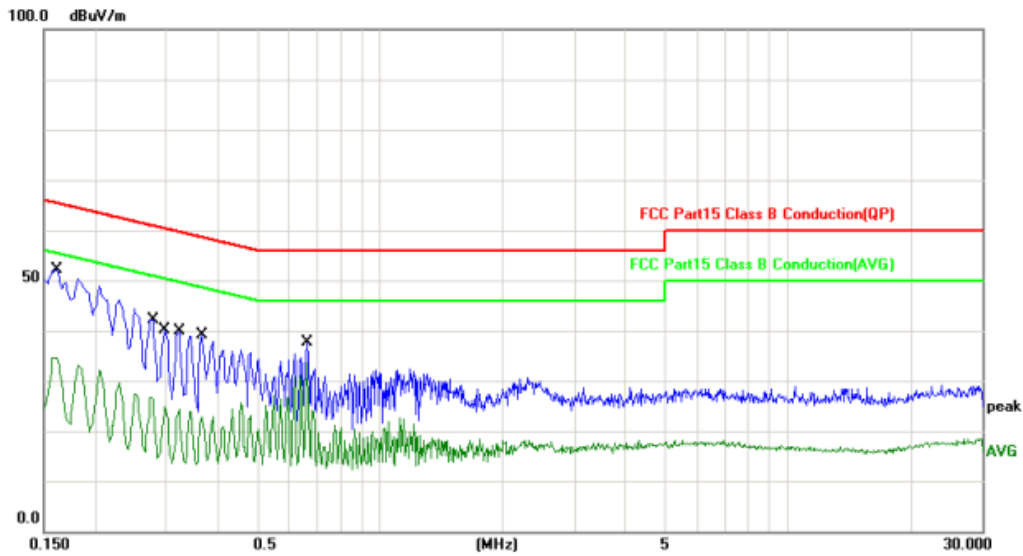

No.	Mk.	Freq.	Reading Level	Correct Factor	Measurement	Limit	Over	Detector	Comment
		MHz	dBuV/m	dB	dBuV/m	dBuV/m	dB		
1	*	0.1620	30.82	19.70	50.52	65.36	-14.84	QP	
2		0.1620	14.48	19.70	34.18	55.36	-21.18	AVG	
3		0.2780	18.86	19.70	38.56	60.88	-22.32	QP	
4		0.2780	4.79	19.70	24.49	50.88	-26.39	AVG	
5		0.2980	19.11	19.70	38.81	60.30	-21.49	QP	
6		0.2980	5.32	19.70	25.02	50.30	-25.28	AVG	
7		0.3220	17.79	19.70	37.49	59.66	-22.17	QP	
8		0.3220	3.08	19.70	22.78	49.66	-26.88	AVG	
9		0.3660	16.91	19.70	36.61	58.59	-21.98	QP	
10		0.3660	2.93	19.70	22.63	48.59	-25.96	AVG	
11		0.6660	14.31	19.78	34.09	56.00	-21.91	QP	
12		0.6660	10.80	19.78	30.58	46.00	-15.42	AVG	

REMARKS:

- (1) Measurement Value = Reading Level + Correct Factor.
- (2) Margin Level = Measurement Value - Limit Value.

APPENDIX B - RADIATED EMISSION - 9 KHZ TO 30 MHZ

Radiated emission: 9KHz-30MHz

The low frequency, which started from 9 kHz to 30MHz, was pre-scanned and the result which was 20dB lower than the limit line was not reported.

There is a comparison data of both open-field test site and semi-Anechoic chamber, and the result came out very similar.

APPENDIX C - RADIATED EMISSION - 30 MHZ TO 1000 MHZ

Test Mode	TX Mode_2Mbps Channel 00	Polarization	Vertical
-----------	--------------------------	--------------	----------

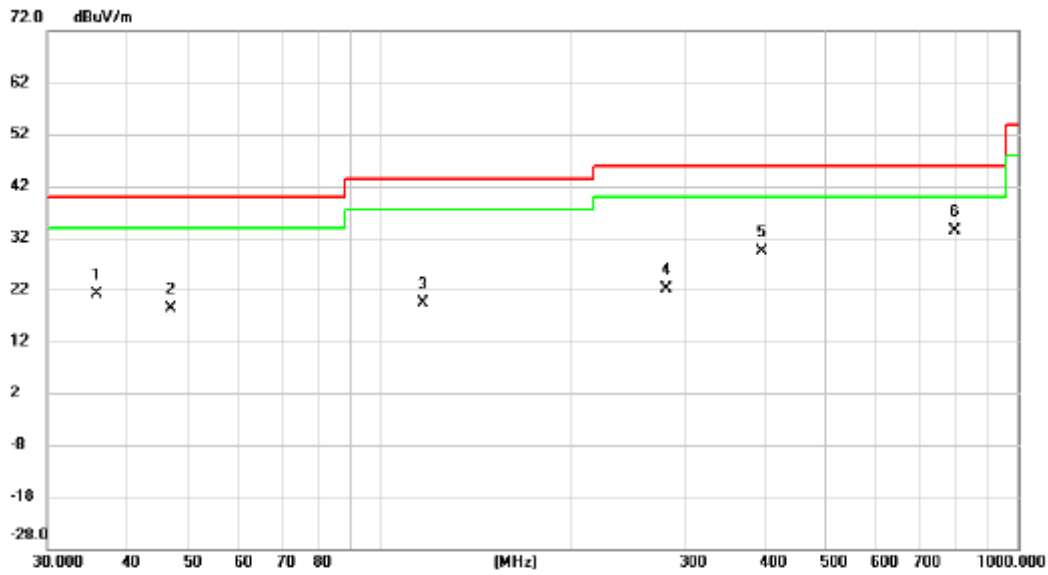

No.	Mk.	Freq. MHz	Reading Level dBuV	Correct Factor dB	Measure- ment dBuV/m	Limit dBuV/m	Margin dB	Detector	Comment
1		35.8746	6.65	14.42	21.07	40.00	-18.93	QP	
2		46.9947	3.77	14.59	18.36	40.00	-21.64	QP	
3		116.9492	4.47	14.84	19.31	43.50	-24.19	QP	
4		281.0074	4.38	17.67	22.05	46.00	-23.95	QP	
5		397.6333	10.10	19.22	29.32	46.00	-16.68	QP	
6	*	796.1830	6.79	26.63	33.42	46.00	-12.58	QP	

REMARKS:

- (1) Measurement Value = Reading Level + Correct Factor.
- (2) Margin Level = Measurement Value - Limit Value.

Test Mode	TX Mode_2Mbps Channel 00	Polarization	Horizontal
-----------	--------------------------	--------------	------------

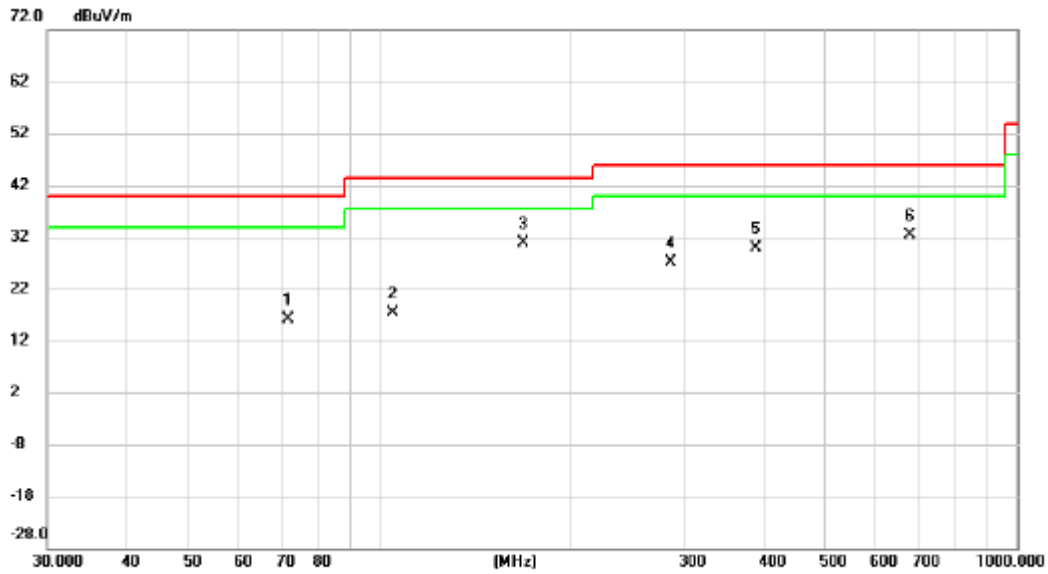

No.	Mk.	Freq. MHz	Reading Level dBuV	Correct Factor dB	Measure- ment dBuV/m	Limit dBuV/m	Margin dB	Detector	Comment
1		71.8320	4.07	12.16	16.23	40.00	-23.77	QP	
2		104.9030	4.73	12.69	17.42	43.50	-26.08	QP	
3	*	167.8240	17.15	13.77	30.92	43.50	-12.58	QP	
4		285.9777	9.56	17.69	27.25	46.00	-18.75	QP	
5		390.7225	10.65	19.18	29.83	46.00	-16.17	QP	
6		679.9600	8.17	24.12	32.29	46.00	-13.71	QP	

REMARKS:

- (1) Measurement Value = Reading Level + Correct Factor.
 (2) Margin Level = Measurement Value - Limit Value.

APPENDIX D - RADIATED EMISSION - ABOVE 1000 MHZ

Test Mode	TX 2402 MHz _CH00_1Mbps	Polarization	Vertical
-----------	-------------------------	--------------	----------

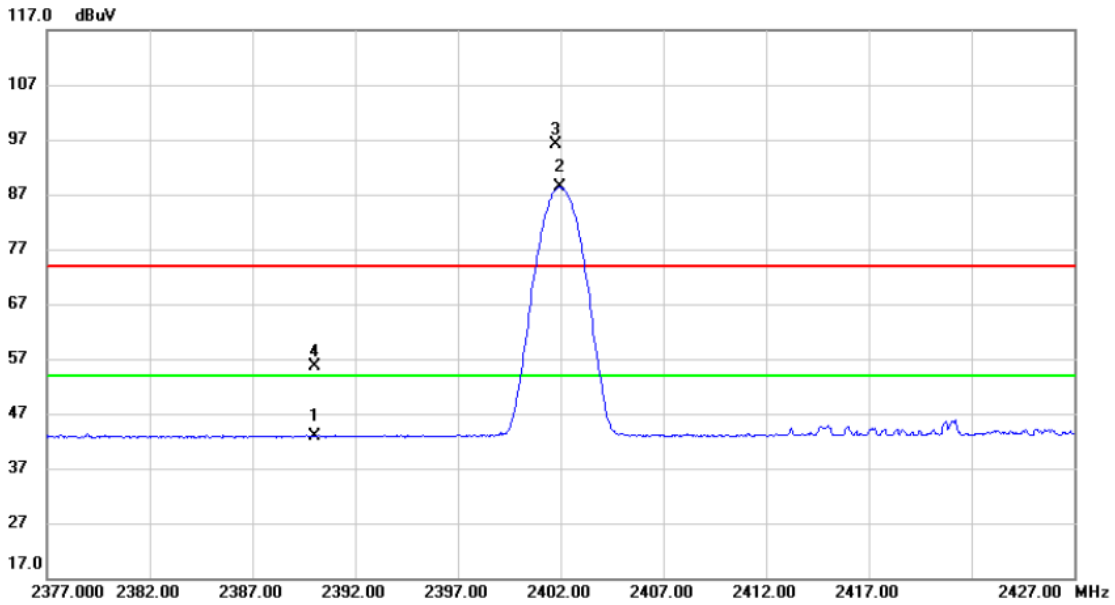

No.	Mk.	Freq. MHz	Reading Level dBuV	Correct Factor dB	Measure- ment dBuV	Limit dBuV	Margin dB	Detector	Comment
1		2390.000	10.30	32.63	42.93	54.00	-11.07	AVG	
2	*	2401.950	55.80	32.67	88.47	54.00	34.47	AVG	
3	X	2401.750	63.49	32.67	96.16	74.00	22.16	peak	
4		2390.000	22.93	32.63	55.56	74.00	-18.44	peak	

REMARKS:

- (1) Measurement Value = Reading Level + Correct Factor.
 (2) Margin Level = Measurement Value - Limit Value.

Test Mode	TX 2402 MHz _CH00_1Mbps	Polarization	Vertical
-----------	-------------------------	--------------	----------

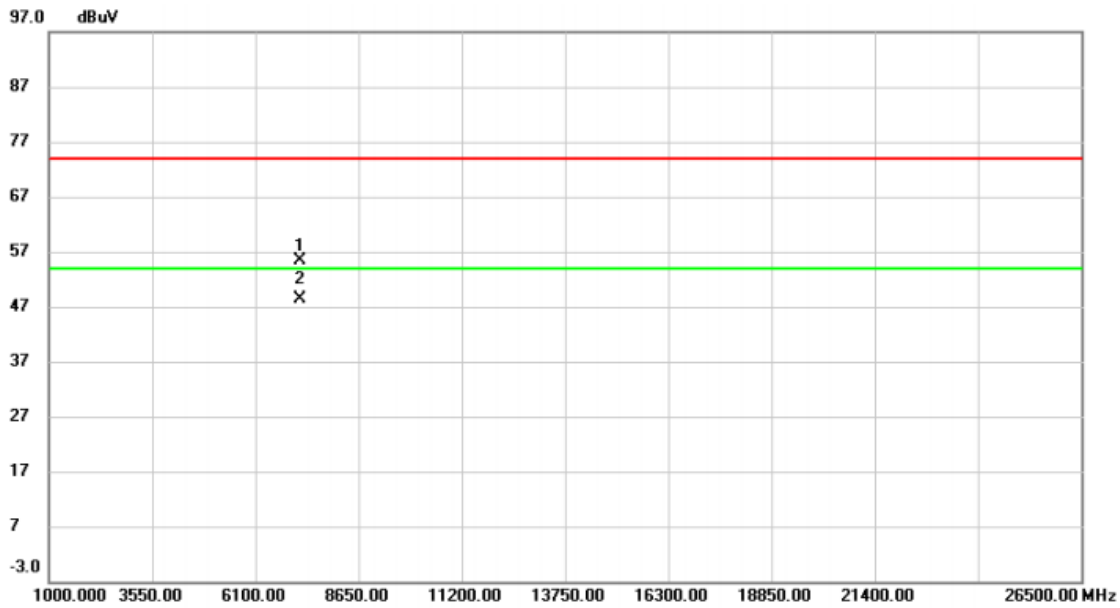

No. Mk.	Freq. MHz	Reading Level dBuV	Correct Factor dB	Measure- ment dBuV	Limit dBuV	Margin dB	Detector	Comment
1	7196.500	64.39	-9.08	55.31	74.00	-18.69	peak	
2 *	7196.500	57.38	-9.08	48.30	54.00	-5.70	AVG	

REMARKS:

- (1) Measurement Value = Reading Level + Correct Factor.
 (2) Margin Level = Measurement Value - Limit Value.

Test Mode	TX 2402 MHz _CH00_1Mbps	Polarization	Horizontal
-----------	-------------------------	--------------	------------

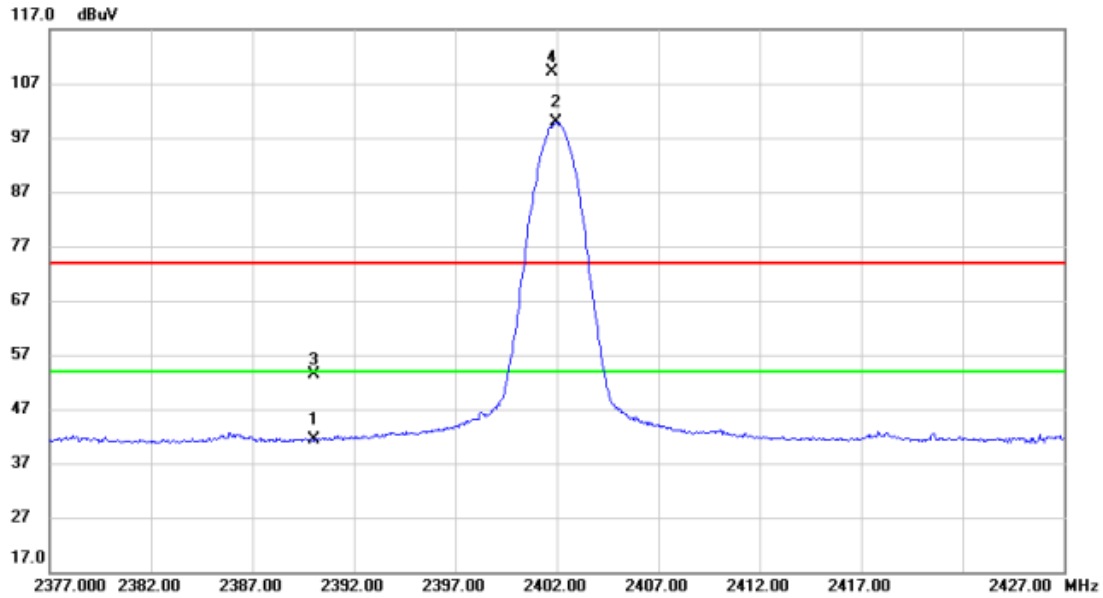

No.	Mk.	Freq. MHz	Reading Level dBuV	Correct Factor dB	Measure- ment dBuV	Limit dBuV	Margin dB	Detector	Comment
1		2390.000	8.66	32.63	41.29	54.00	-12.71	AVG	
2	*	2401.950	67.15	32.67	99.82	54.00	45.82	AVG	
3		2390.000	20.64	32.63	53.27	74.00	-20.73	peak	
4	X	2401.750	76.58	32.67	109.25	74.00	35.25	peak	

REMARKS:

- (1) Measurement Value = Reading Level + Correct Factor.
 (2) Margin Level = Measurement Value - Limit Value.

Test Mode	TX 2402 MHz _CH00_1Mbps	Polarization	Horizontal
-----------	-------------------------	--------------	------------

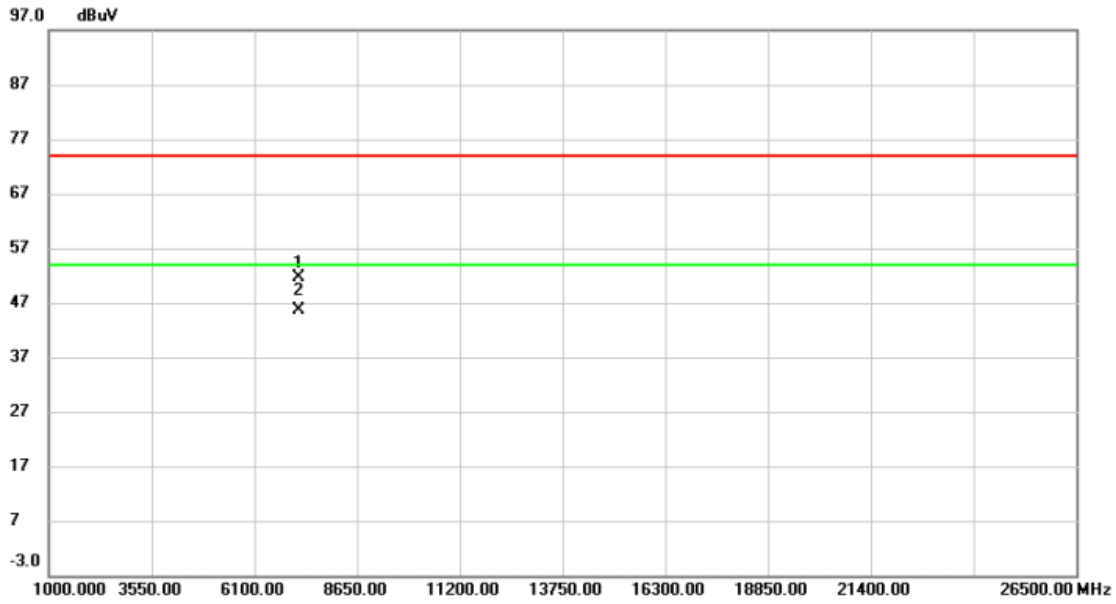

No.	Mk.	Freq.	Reading Level	Correct Factor	Measurement	Limit	Margin	Detector	Comment
		MHz	dBuV	dB	dBuV	dBuV	dB		
1		7196.500	60.80	-9.08	51.72	74.00	-22.28	peak	
2	*	7196.500	54.71	-9.08	45.63	54.00	-8.37	AVG	

REMARKS:

- (1) Measurement Value = Reading Level + Correct Factor.
 (2) Margin Level = Measurement Value - Limit Value.

Test Mode	TX 2440 MHz _CH19_1Mbps	Polarization	Vertical
-----------	-------------------------	--------------	----------

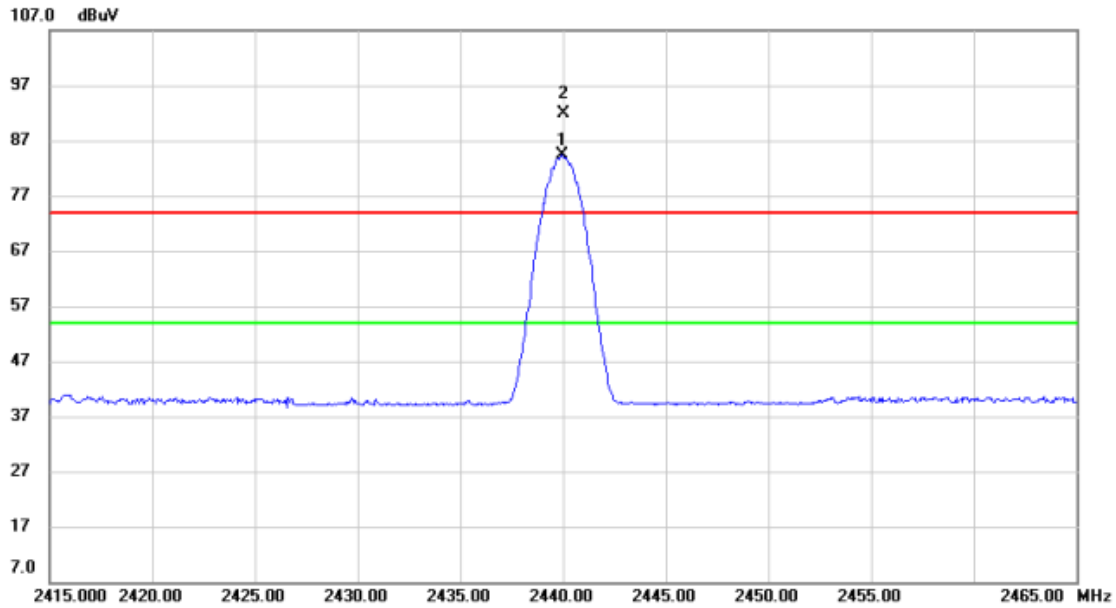

No.	Mk.	Freq. MHz	Reading Level dBuV	Correct Factor dB	Measure- ment dBuV	Limit dBuV	Margin dB	Detector	Comment
1	X	2439.950	51.67	32.81	84.48	74.00	10.48	peak	
2	*	2440.000	59.16	32.81	91.97	54.00	37.97	AVG	

REMARKS:

- (1) Measurement Value = Reading Level + Correct Factor.
 (2) Margin Level = Measurement Value - Limit Value.

Test Mode	TX 2440 MHz _CH19_1Mbps	Polarization	Vertical
-----------	-------------------------	--------------	----------

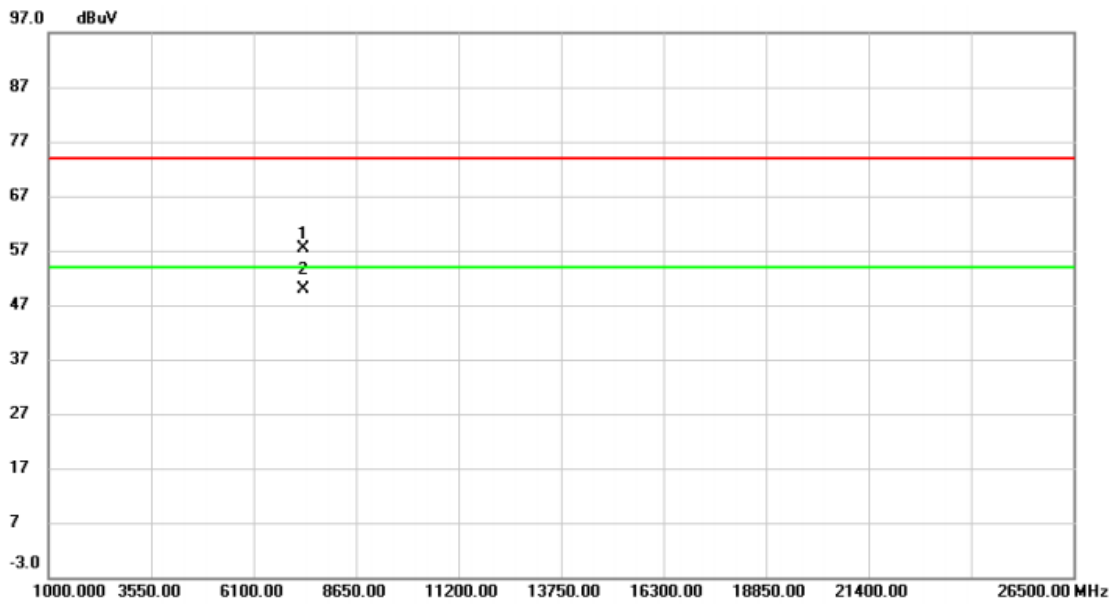

No.	Mk.	Freq.	Reading Level	Correct Factor	Measurement	Limit	Margin	Detector	Comment
		MHz	dBuV	dB	dBuV	dBuV	dB		
1		7324.000	66.18	-8.68	57.50	74.00	-16.50	peak	
2	*	7324.000	58.56	-8.68	49.88	54.00	-4.12	AVG	

REMARKS:

- (1) Measurement Value = Reading Level + Correct Factor.
 (2) Margin Level = Measurement Value - Limit Value.

Test Mode	TX 2440 MHz _CH19_1Mbps	Polarization	Horizontal
-----------	-------------------------	--------------	------------

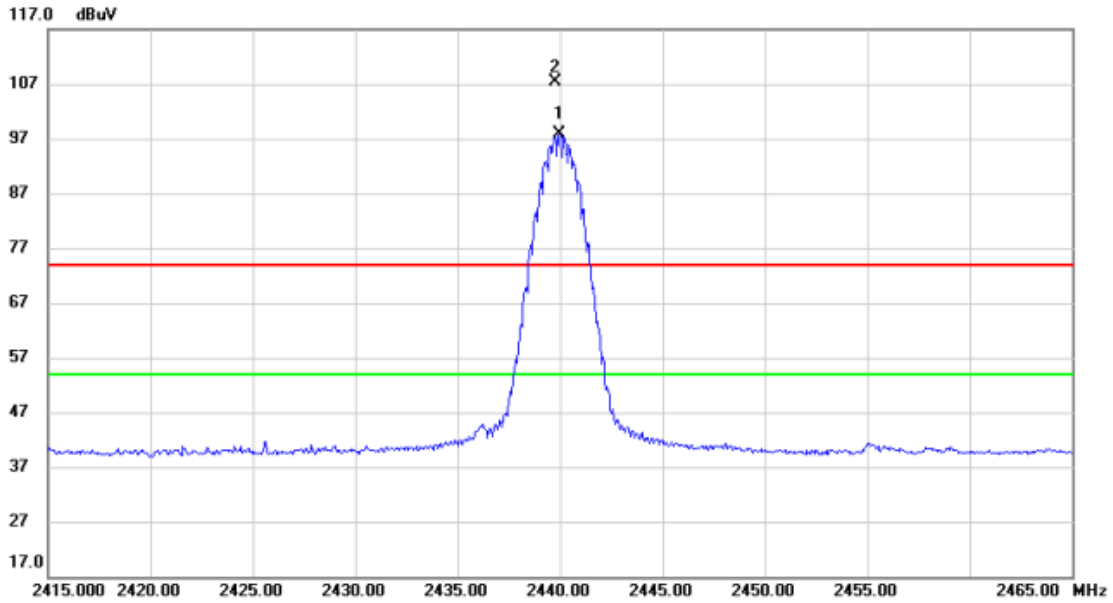

No.	Mk.	Freq.	Reading Level	Correct Factor	Measurement	Limit	Margin	Detector	Comment
		MHz	dBuV	dB	dBuV	dBuV	dB		
1	*	2439.950	65.08	32.81	97.89	54.00	43.89	AVG	
2	X	2439.750	74.45	32.81	107.26	74.00	33.26	peak	

REMARKS:

- (1) Measurement Value = Reading Level + Correct Factor.
 (2) Margin Level = Measurement Value - Limit Value.

Test Mode	TX 2440 MHz _CH19_1Mbps	Polarization	Horizontal
-----------	-------------------------	--------------	------------

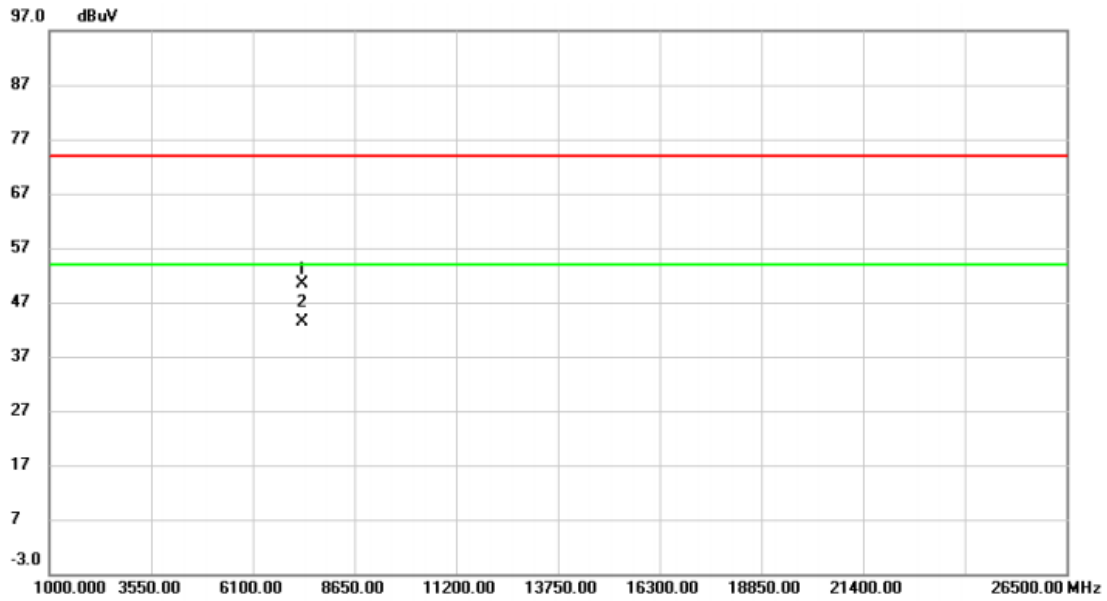

No.	Mk.	Freq. MHz	Reading Level dBuV	Correct Factor dB	Measure- ment dBuV	Limit dBuV	Margin dB	Detector	Comment
1		7324.000	59.18	-8.68	50.50	74.00	-23.50	peak	
2	*	7324.000	51.99	-8.68	43.31	54.00	-10.69	AVG	

REMARKS:

- (1) Measurement Value = Reading Level + Correct Factor.
 (2) Margin Level = Measurement Value - Limit Value.

Test Mode	TX 2480 MHz _CH39_1Mbps	Polarization	Vertical
-----------	-------------------------	--------------	----------

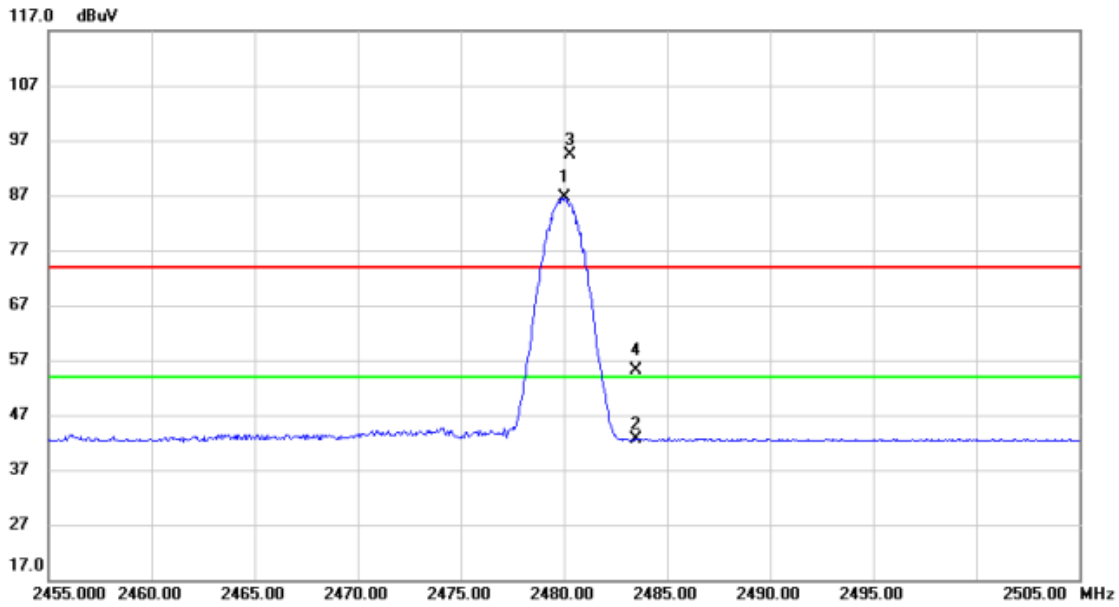

No.	Mk.	Freq. MHz	Reading Level dBuV	Correct Factor dB	Measure- ment dBuV	Limit dBuV	Margin dB	Detector	Comment
1	*	2480.000	53.69	32.96	86.65	54.00	32.65	AVG	
2		2483.500	9.66	32.97	42.63	74.00	-31.37	peak	
3	X	2480.300	61.30	32.96	94.26	74.00	20.26	peak	
4	X	2483.500	22.26	32.97	55.23	54.00	1.23	AVG	

REMARKS:

- (1) Measurement Value = Reading Level + Correct Factor.
 (2) Margin Level = Measurement Value - Limit Value.

Test Mode	TX 2480 MHz _CH39_1Mbps	Polarization	Vertical
-----------	-------------------------	--------------	----------

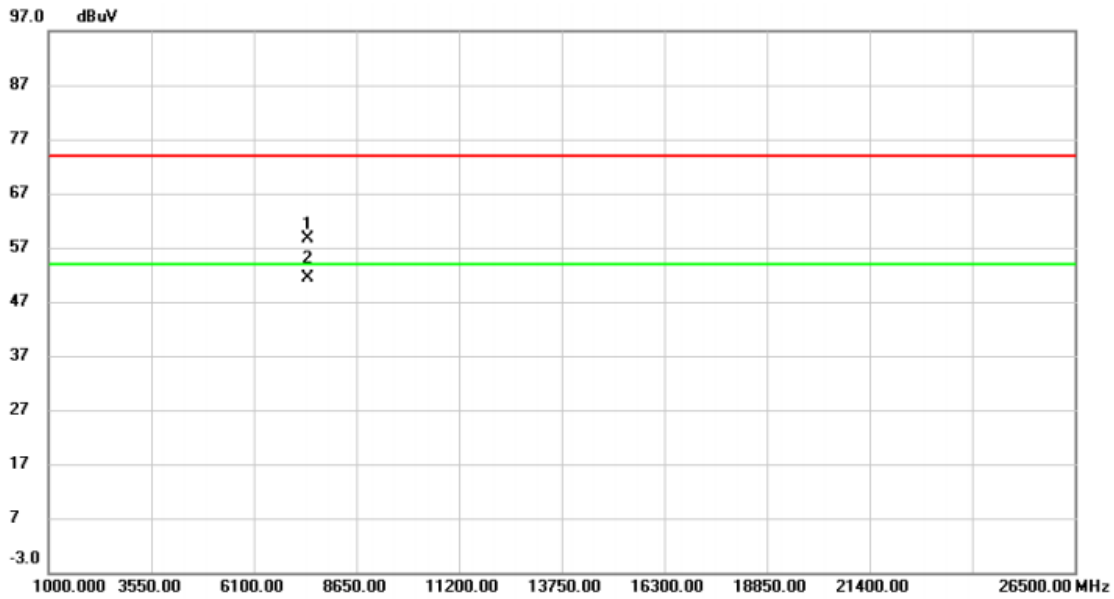

No.	Mk.	Freq.	Reading Level	Correct Factor	Measurement	Limit	Margin	Detector	Comment
		MHz	dBuV	dB	dBuV	dBuV	dB		
1		7426.000	67.06	-8.36	58.70	74.00	-15.30	peak	
2	*	7426.000	59.68	-8.36	51.32	54.00	-2.68	AVG	

REMARKS:

- (1) Measurement Value = Reading Level + Correct Factor.
 (2) Margin Level = Measurement Value - Limit Value.

Test Mode	TX 2480 MHz _CH39_1Mbps	Polarization	Horizontal
-----------	-------------------------	--------------	------------

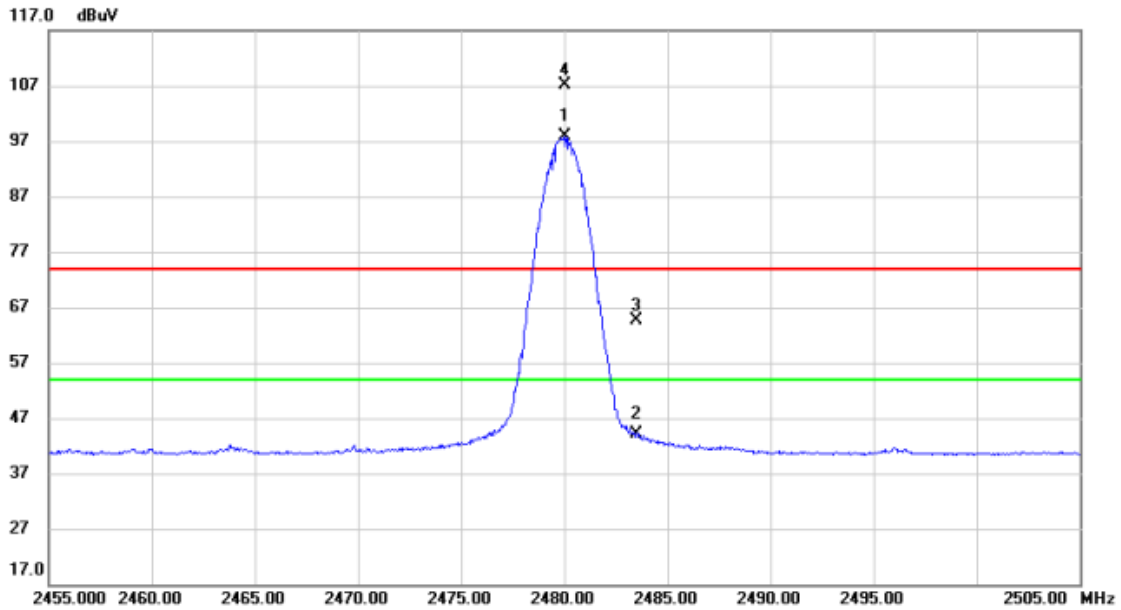

No.	Mk.	Freq. MHz	Reading Level dBuV	Correct Factor dB	Measure- ment dBuV	Limit dBuV	Margin dB	Detector	Comment
1	*	2480.000	64.94	32.96	97.90	54.00	43.90	AVG	
2		2483.500	11.28	32.97	44.25	54.00	-9.75	AVG	
3		2483.500	31.61	32.97	64.58	74.00	-9.42	peak	
4	X	2480.050	74.10	32.96	107.06	74.00	33.06	peak	

REMARKS:

- (1) Measurement Value = Reading Level + Correct Factor.
 (2) Margin Level = Measurement Value - Limit Value.

Test Mode	TX 2480 MHz _CH39_1Mbps	Polarization	Horizontal
-----------	-------------------------	--------------	------------

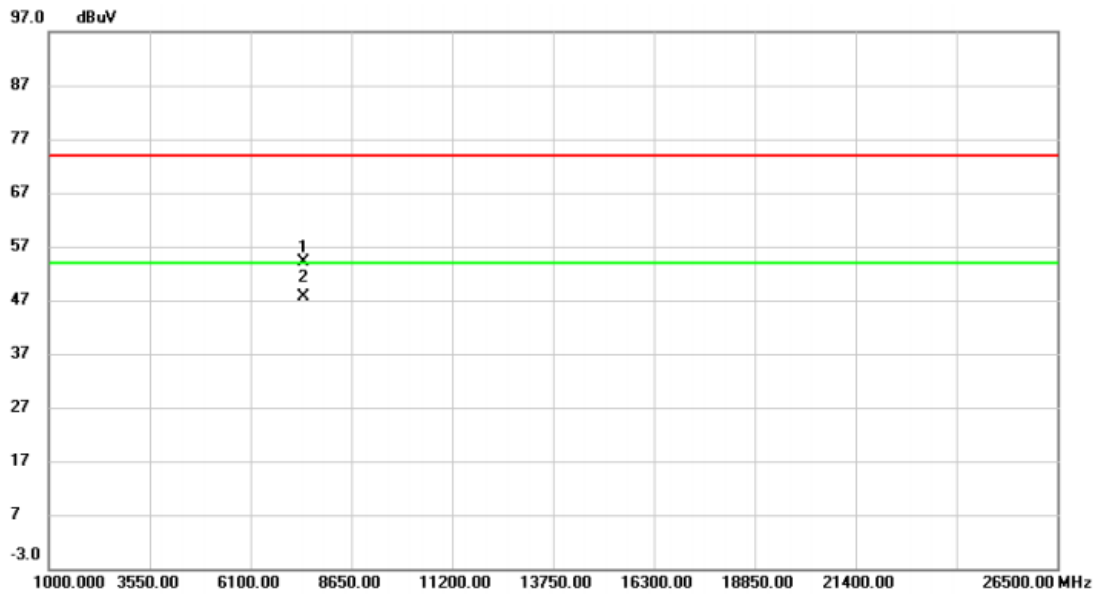

No.	Mk.	Freq.	Reading Level	Correct Factor	Measurement	Limit	Margin	Detector	Comment
		MHz	dBuV	dB	dBuV	dBuV	dB		
1		7426.000	62.58	-8.36	54.22	74.00	-19.78	peak	
2	*	7426.000	55.93	-8.36	47.57	54.00	-6.43	AVG	

REMARKS:

- (1) Measurement Value = Reading Level + Correct Factor.
 (2) Margin Level = Measurement Value - Limit Value.

Test Mode	TX 2402 MHz _CH00_2Mbps	Polarization	Vertical
-----------	-------------------------	--------------	----------

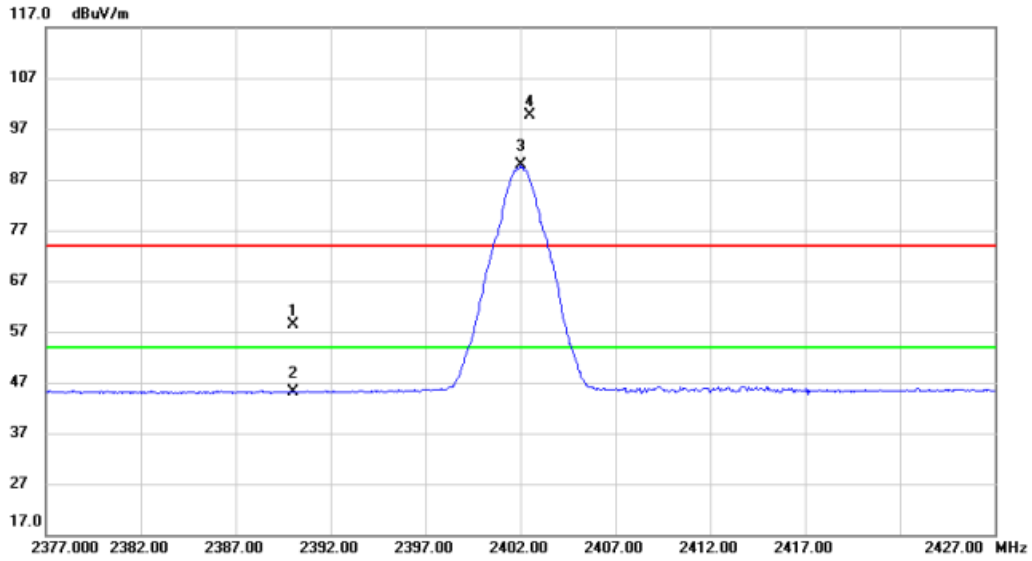

No.	Mk.	Freq. MHz	Reading Level dBuV	Correct Factor dB	Measure- ment dBuV/m	Limit dBuV/m	Margin dB	Detector	Comment
1		2390.000	25.64	32.63	58.27	74.00	-15.73	peak	
2		2390.000	12.53	32.63	45.16	54.00	-8.84	AVG	
3	*	2402.000	57.09	32.67	89.76	54.00	35.76	AVG	
4	X	2402.500	67.05	32.68	99.73	74.00	25.73	peak	

REMARKS:

- (1) Measurement Value = Reading Level + Correct Factor.
 (2) Margin Level = Measurement Value - Limit Value.

Test Mode	TX 2402 MHz _CH00_2Mbps	Polarization	Vertical
-----------	-------------------------	--------------	----------

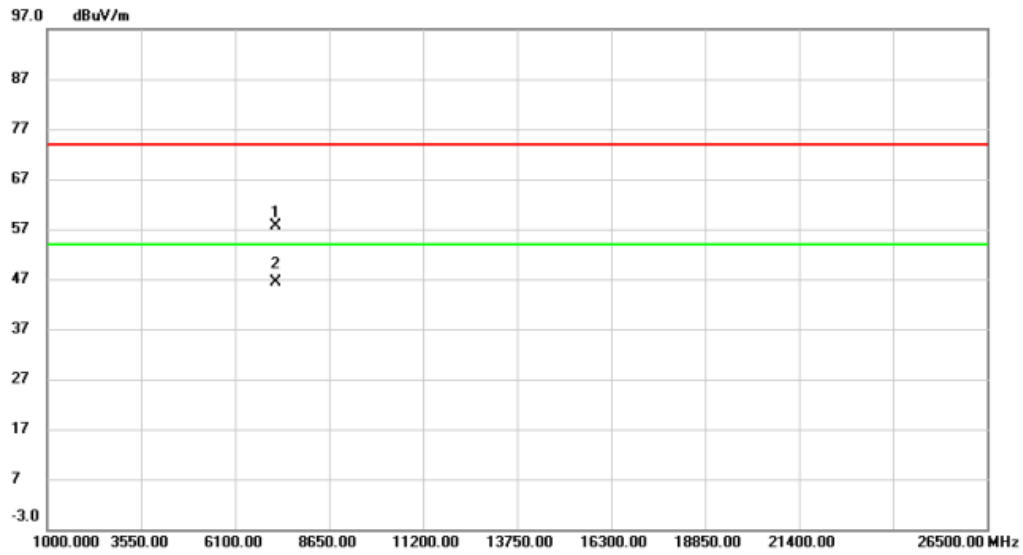

No. Mk.	Freq. MHz	Reading Level dBuV	Correct Factor dB	Measure- ment dBuV/m	Limit dBuV/m	Margin dB	Detector	Comment
1	7196.500	66.74	-9.08	57.66	74.00	-16.34	peak	
2 *	7196.500	55.49	-9.08	46.41	54.00	-7.59	AVG	

REMARKS:

- (1) Measurement Value = Reading Level + Correct Factor.
 (2) Margin Level = Measurement Value - Limit Value.

Test Mode	TX 2402 MHz _CH00_2Mbps	Polarization	Horizontal
-----------	-------------------------	--------------	------------

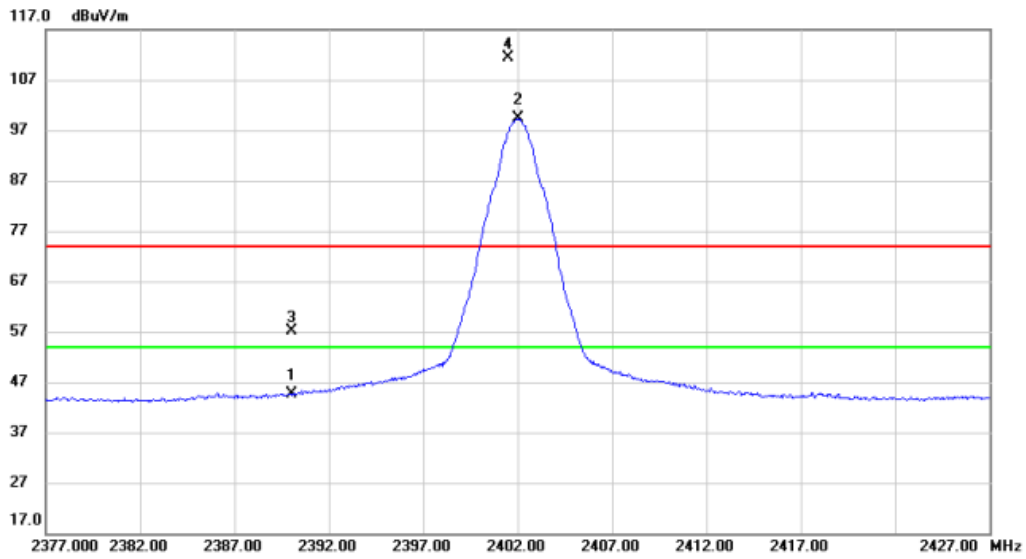

No.	Mk.	Freq. MHz	Reading Level dBuV	Correct Factor dB	Measure- ment dBuV/m	Limit dBuV/m	Margin dB	Detector	Comment
1		2390.000	12.04	32.63	44.67	54.00	-9.33	AVG	
2	*	2402.050	66.66	32.67	99.33	54.00	45.33	AVG	
3		2390.000	24.58	32.63	57.21	74.00	-16.79	peak	
4	X	2401.500	78.68	32.67	111.35	74.00	37.35	peak	

REMARKS:

- (1) Measurement Value = Reading Level + Correct Factor.
 (2) Margin Level = Measurement Value - Limit Value.

Test Mode	TX 2402 MHz _CH00_2Mbps	Polarization	Horizontal
-----------	-------------------------	--------------	------------

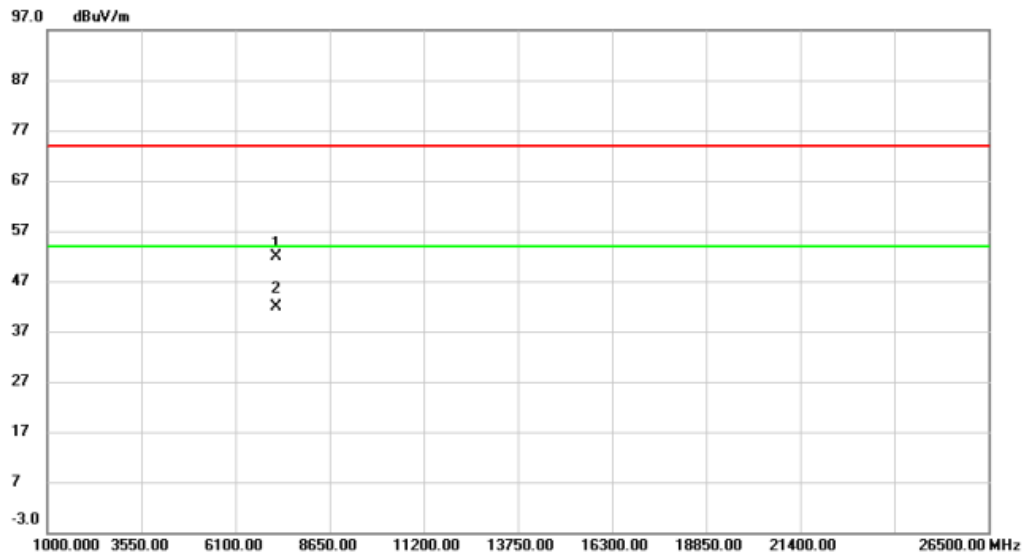

No. Mk.	Freq. MHz	Reading Level dBuV	Correct Factor dB	Measure- ment dBuV/m	Limit dBuV/m	Margin dB	Detector	Comment
1	7196.500	61.02	-9.08	51.94	74.00	-22.06	peak	
2 *	7196.500	50.91	-9.08	41.83	54.00	-12.17	AVG	

REMARKS:

- (1) Measurement Value = Reading Level + Correct Factor.
- (2) Margin Level = Measurement Value - Limit Value.

Test Mode	TX 2440 MHz _CH19_2Mbps	Polarization	Vertical
-----------	-------------------------	--------------	----------

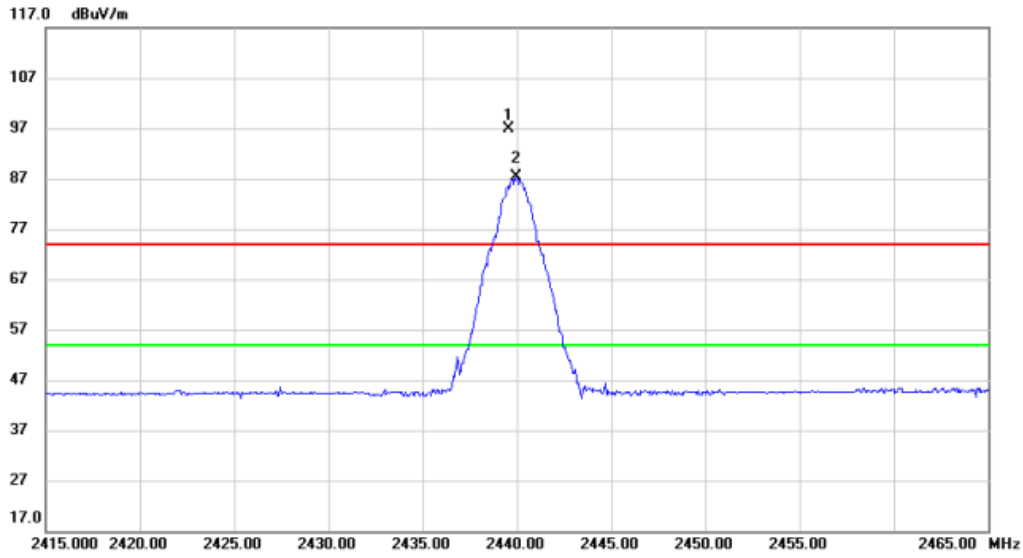

No.	Mk.	Freq. MHz	Reading Level dBuV	Correct Factor dB	Measure- ment dBuV/m	Limit dBuV/m	Margin dB	Detector	Comment
1	X	2439.550	64.08	32.81	96.89	74.00	22.89	peak	
2	*	2439.950	54.58	32.81	87.39	54.00	33.39	AVG	

REMARKS:

- (1) Measurement Value = Reading Level + Correct Factor.
 (2) Margin Level = Measurement Value - Limit Value.

Test Mode	TX 2440 MHz _CH19_2Mbps	Polarization	Vertical
-----------	-------------------------	--------------	----------

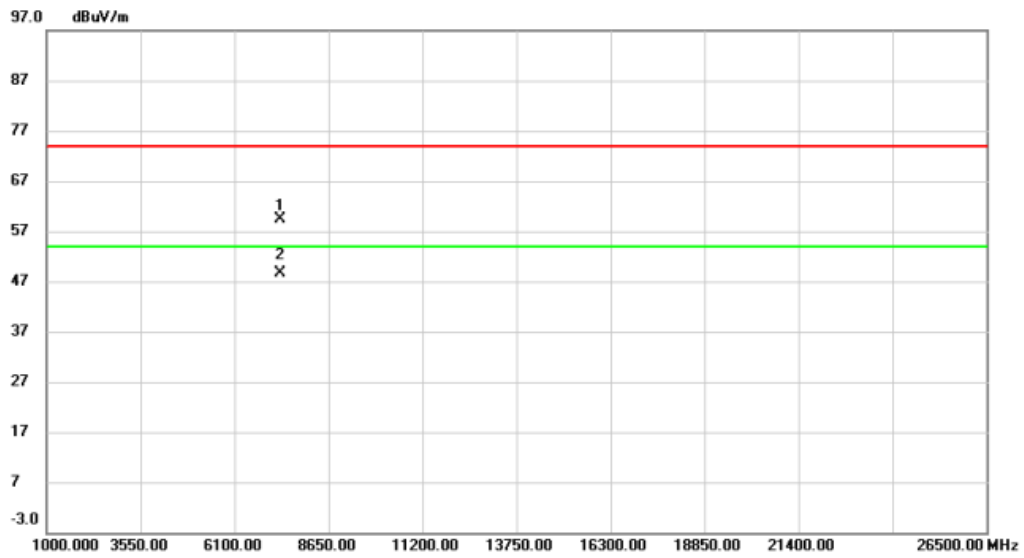

No. Mk.	Freq. MHz	Reading Level dBuV	Correct Factor dB	Measure- ment dBuV/m	Limit dBuV/m	Margin dB	Detector	Comment
1	7324.000	68.01	-8.68	59.33	74.00	-14.67	peak	
2 *	7324.000	57.36	-8.68	48.68	54.00	-5.32	AVG	

REMARKS:

- (1) Measurement Value = Reading Level + Correct Factor.
 (2) Margin Level = Measurement Value - Limit Value.

Test Mode	TX 2440 MHz _CH19_2Mbps	Polarization	Horizontal
-----------	-------------------------	--------------	------------

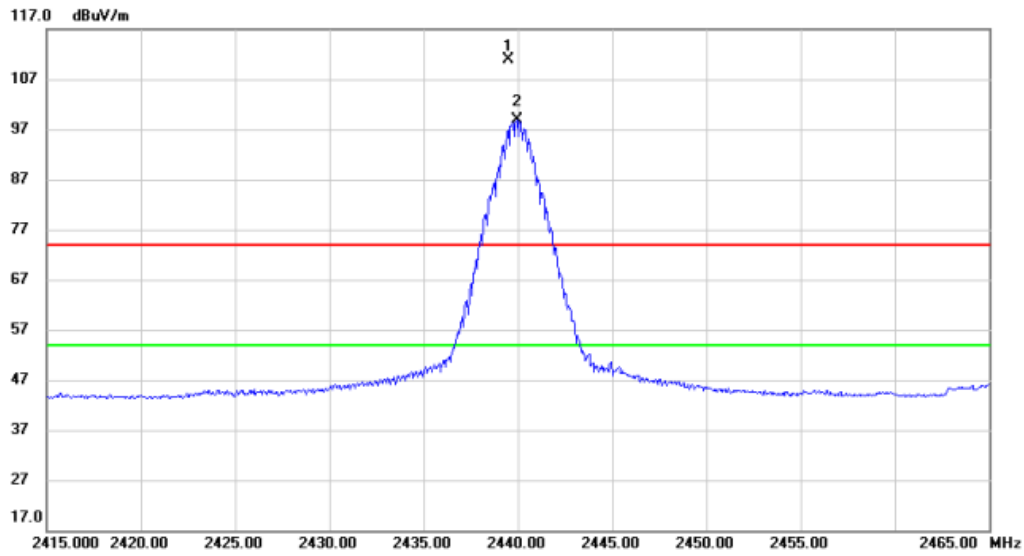

No. Mk.	Freq. MHz	Reading Level dBuV	Correct Factor dB	Measure- ment dBuV/m	Limit dBuV/m	Margin dB	Detector	Comment
1 X	2439.500	78.02	32.81	110.83	74.00	36.83	peak	
2 *	2439.950	66.07	32.81	98.88	54.00	44.88	AVG	

REMARKS:

- (1) Measurement Value = Reading Level + Correct Factor.
 (2) Margin Level = Measurement Value - Limit Value.

Test Mode	TX 2440 MHz _CH19_2Mbps	Polarization	Horizontal
-----------	-------------------------	--------------	------------

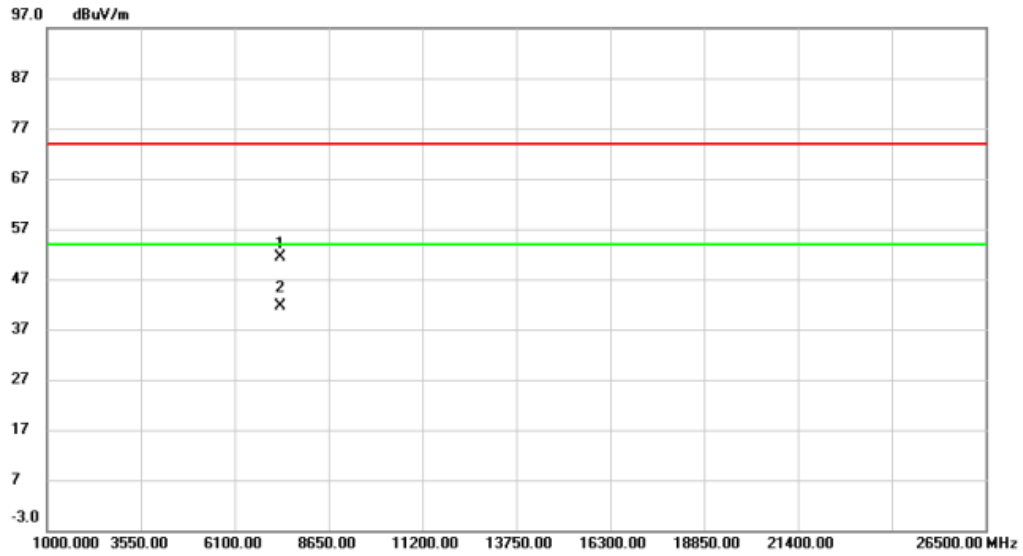

No. Mk.	Freq. MHz	Reading Level dBuV	Correct Factor dB	Measure- ment dBuV/m	Limit dBuV/m	Margin dB	Detector	Comment
1	7324.000	60.05	-8.68	51.37	74.00	-22.63	peak	
2 *	7324.000	50.19	-8.68	41.51	54.00	-12.49	AVG	

REMARKS:

- (1) Measurement Value = Reading Level + Correct Factor.
 (2) Margin Level = Measurement Value - Limit Value.

Test Mode	TX 2480 MHz _CH39_2Mbps	Polarization	Vertical
-----------	-------------------------	--------------	----------

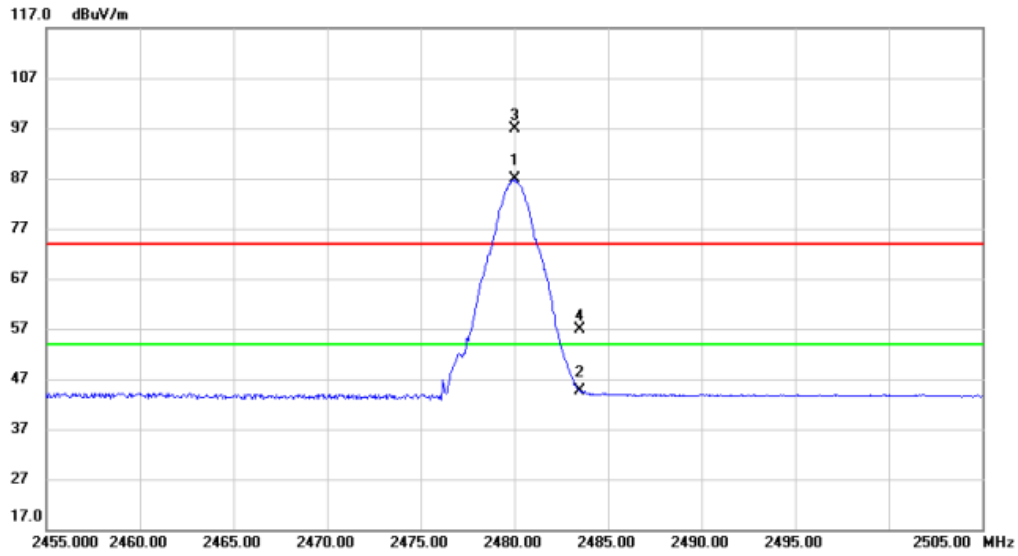

No. Mk.	Freq. MHz	Reading Level dBuV	Correct Factor dB	Measure- ment dBuV/m	Limit dBuV/m	Margin dB	Detector	Comment
1 *	2480.050	53.83	32.96	86.79	54.00	32.79	AVG	
2	2483.500	11.55	32.97	44.52	54.00	-9.48	AVG	
3 X	2480.000	64.04	32.96	97.00	74.00	23.00	peak	
4	2483.500	23.98	32.97	56.95	74.00	-17.05	peak	

REMARKS:

- (1) Measurement Value = Reading Level + Correct Factor.
 (2) Margin Level = Measurement Value - Limit Value.

Test Mode	TX 2480 MHz _CH39_2Mbps	Polarization	Vertical
-----------	-------------------------	--------------	----------

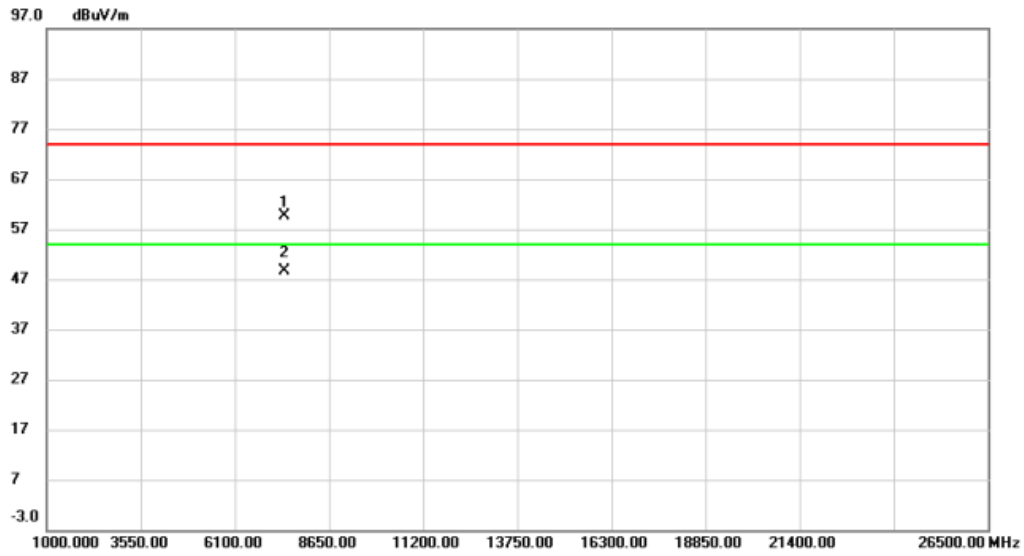

No. Mk.	Freq. MHz	Reading Level dBuV	Correct Factor dB	Measure- ment dBuV/m	Limit dBuV/m	Margin dB	Detector	Comment
1	7426.000	68.06	-8.36	59.70	74.00	-14.30	peak	
2 *	7426.000	57.05	-8.36	48.69	54.00	-5.31	AVG	

REMARKS:

- (1) Measurement Value = Reading Level + Correct Factor.
 (2) Margin Level = Measurement Value - Limit Value.

Test Mode	TX 2480 MHz _CH39_2Mbps	Polarization	Horizontal
-----------	-------------------------	--------------	------------

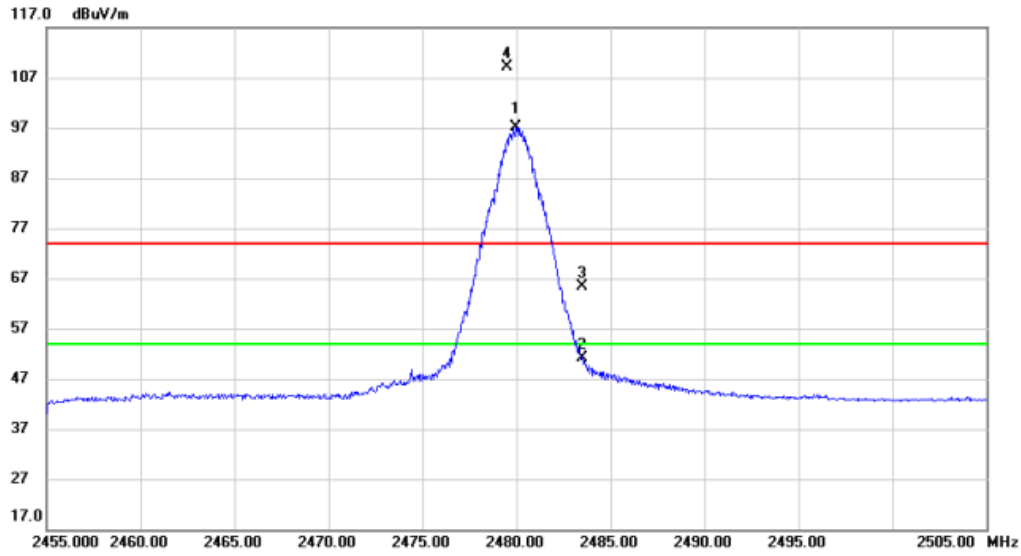

No. Mk.	Freq. MHz	Reading Level dBuV	Correct Factor dB	Measure- ment dBuV/m	Limit dBuV/m	Margin dB	Detector	Comment
1 *	2479.950	64.26	32.96	97.22	54.00	43.22	AVG	
2	2483.500	18.19	32.97	51.16	74.00	-22.84	peak	
3	2483.500	32.32	32.97	65.29	74.00	-8.71	peak	
4 X	2479.500	76.11	32.95	109.06	74.00	35.06	peak	

REMARKS:

- (1) Measurement Value = Reading Level + Correct Factor.
 (2) Margin Level = Measurement Value - Limit Value.

Test Mode	TX 2480 MHz _CH39_2Mbps	Polarization	Horizontal
-----------	-------------------------	--------------	------------

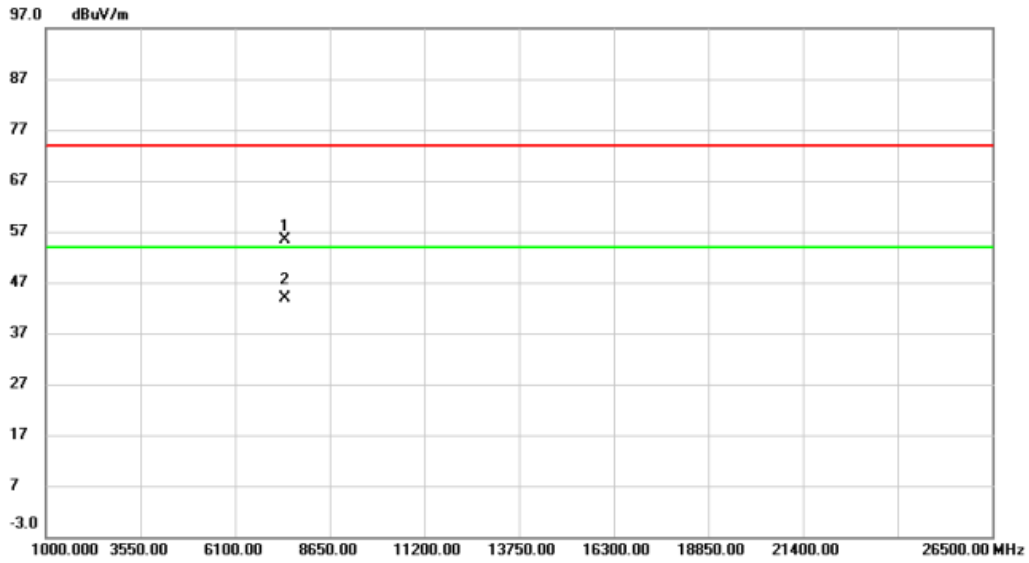

No. Mk.	Freq. MHz	Reading Level dBuV	Correct Factor dB	Measure- ment dBuV/m	Limit dBuV/m	Margin dB	Detector	Comment
1	7426.000	63.68	-8.36	55.32	74.00	-18.68	peak	
2 *	7426.000	52.18	-8.36	43.82	54.00	-10.18	AVG	

REMARKS:

- (1) Measurement Value = Reading Level + Correct Factor.
- (2) Margin Level = Measurement Value - Limit Value.

APPENDIX E - BANDWIDTH

Test Mode TX Mode _1Mbps

Channel	Frequency (MHz)	6 dB Bandwidth (MHz)	99 % Occupied Bandwidth (MHz)	6 dB Bandwidth Min. Limit (MHz)	Test Result
00	2402	0.712	1.046	0.5	Pass
19	2440	0.706	1.066	0.5	Pass
39	2480	0.724	1.049	0.5	Pass

CH00

CH19

CH39

6 dB Bandwidth



99 % Occupied Bandwidth

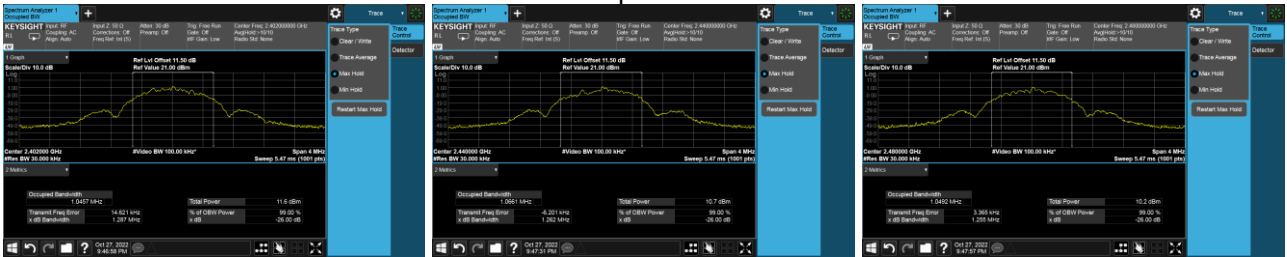

Test Mode	TX Mode _2Mbps
-----------	----------------

Channel	Frequency (MHz)	6 dB Bandwidth (MHz)	99 % Occupied Bandwidth (MHz)	6 dB Bandwidth Min. Limit (MHz)	Test Result
00	2402	1.052	2.036	0.5	Pass
19	2440	1.080	2.060	0.5	Pass
39	2480	1.080	2.081	0.5	Pass

CH00

CH19

CH39

6 dB Bandwidth



99 % Occupied Bandwidth

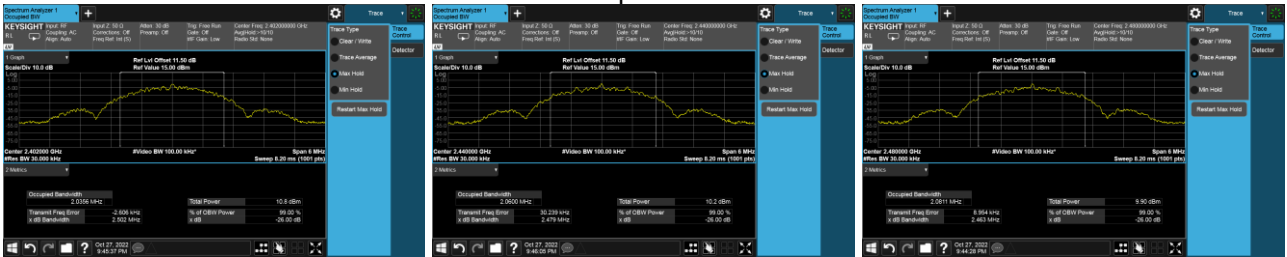

APPENDIX F - MAXIMUM OUTPUT POWER

Test Mode	TX Mode _1Mbps
-----------	----------------

Frequency (MHz)	Output Power (dBm)	Output Power (W)	Max. Limit (dBm)	Max. Limit (W)	Test Result
2402	5.60	0.0036	30.00	1.0000	Pass
2440	5.08	0.0032	30.00	1.0000	Pass
2480	4.87	0.0031	30.00	1.0000	Pass

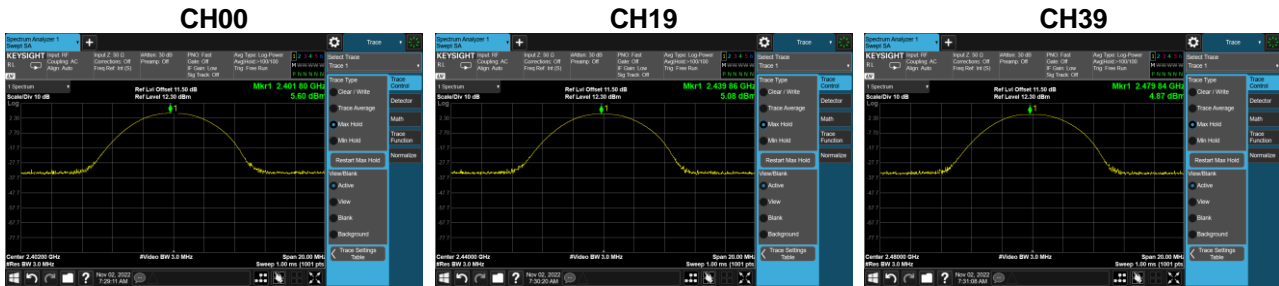

Test Mode	TX Mode _2Mbps
-----------	----------------

Frequency (MHz)	Output Power (dBm)	Output Power (W)	Max. Limit (dBm)	Max. Limit (W)	Test Result
2402	5.62	0.0036	30.00	1.0000	Pass
2440	5.06	0.0032	30.00	1.0000	Pass
2480	4.90	0.0031	30.00	1.0000	Pass



APPENDIX G - CONDUCTED SPURIOUS EMISSION

Test Mode TX Mode_1Mbps

Bandedge CH00 (Lower)

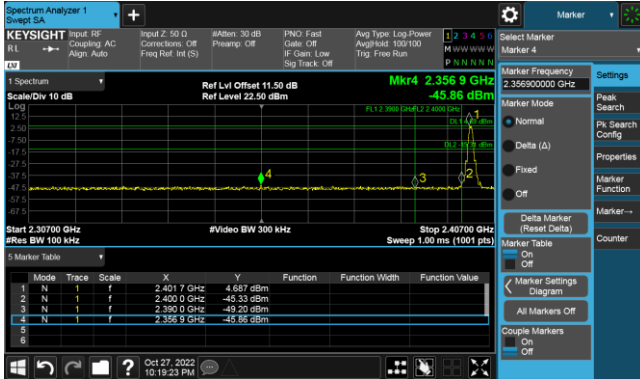

Bandedge CH39 (Upper)

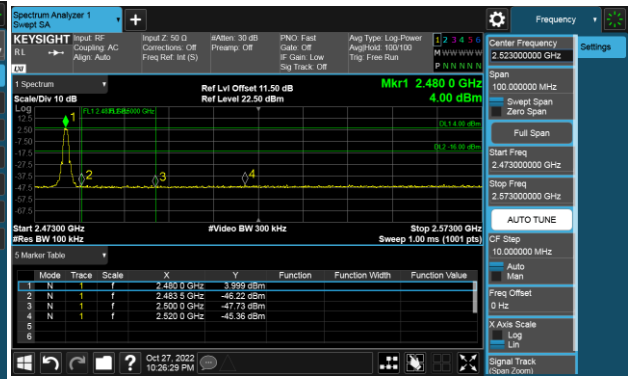

CH00 – 10th Harmonic of the fundamental frequency

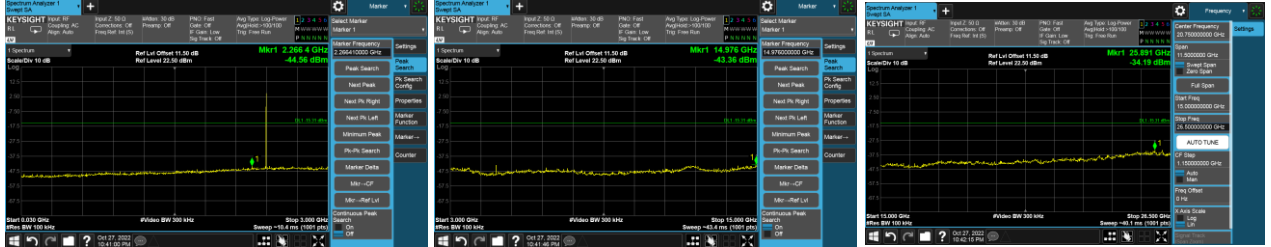

CH19 – 10th Harmonic of the fundamental frequency



CH39 – 10th Harmonic of the fundamental frequency

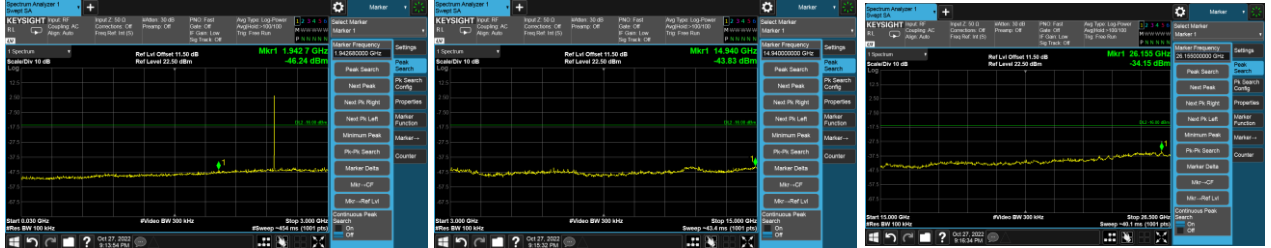

Test Mode TX Mode _2Mbps

Bandedge CH00 (Lower)

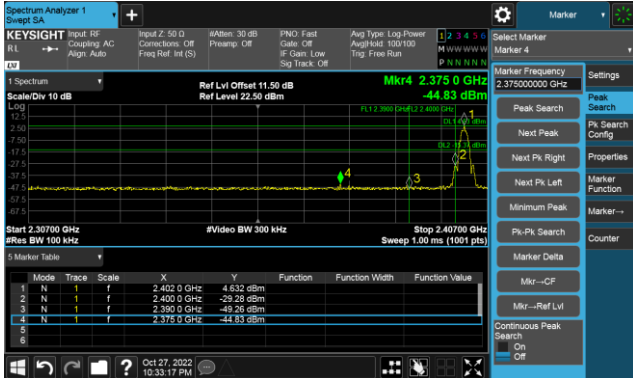

Bandedge CH39 (Upper)

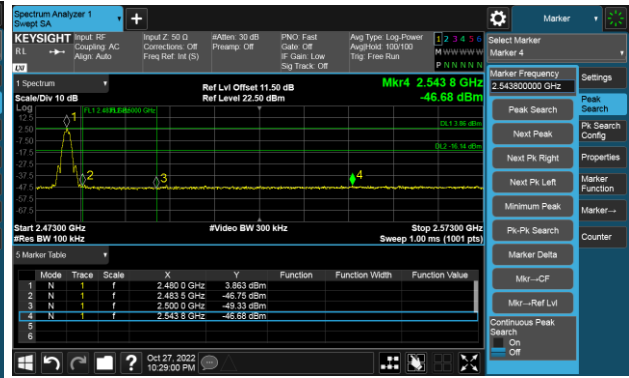

CH00 – 10th Harmonic of the fundamental frequency

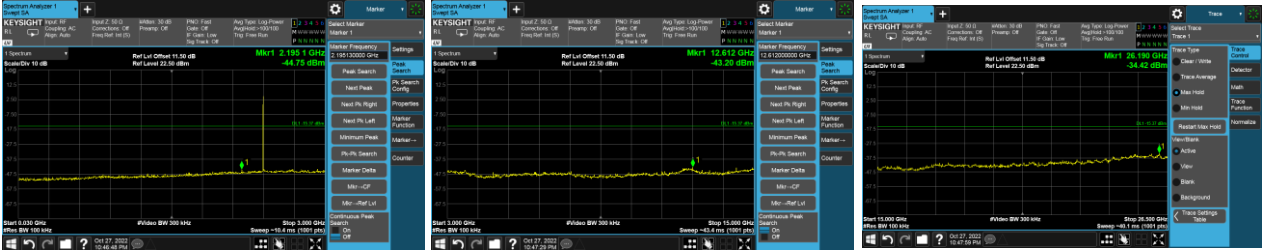

CH19 – 10th Harmonic of the fundamental frequency

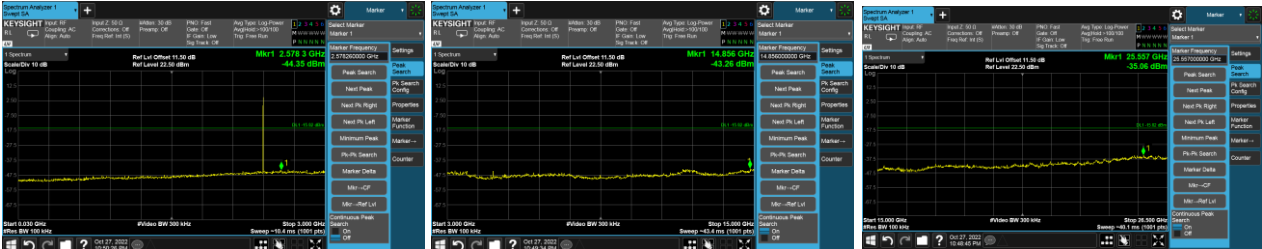

CH39 – 10th Harmonic of the fundamental frequency

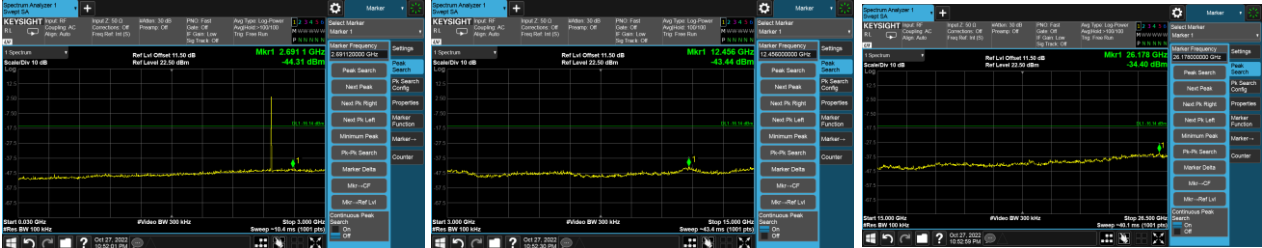

APPENDIX H - POWER SPECTRAL DENSITY

Test Mode	TX Mode _1Mbps
-----------	----------------

Channel	Frequency (MHz)	Power Spectral Density (dBm/3 kHz)	Max. Limit (dBm/3 kHz)	Test Result
00	2402	-9.38	8.00	Pass
19	2440	-11.08	8.00	Pass
39	2480	-9.70	8.00	Pass

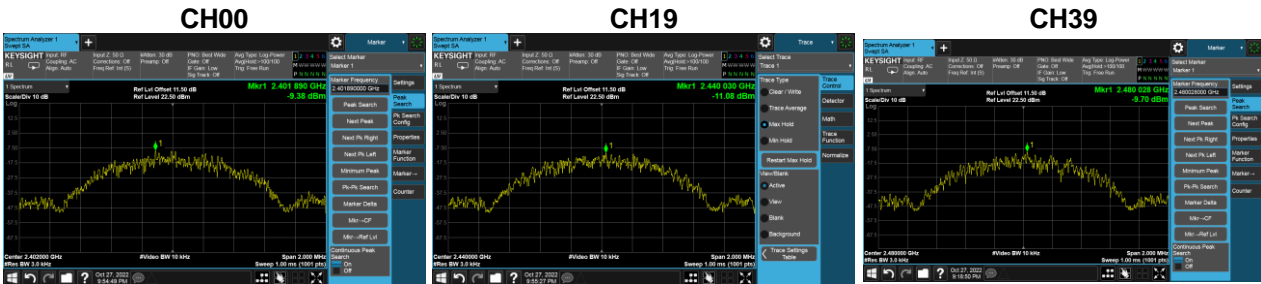

Test Mode	TX Mode _2Mbps
-----------	----------------

Channel	Frequency (MHz)	Power Spectral Density (dBm/3 kHz)	Max. Limit (dBm/3 kHz)	Test Result
00	2402	-12.31	8.00	Pass
19	2440	-12.23	8.00	Pass
39	2480	-11.34	8.00	Pass

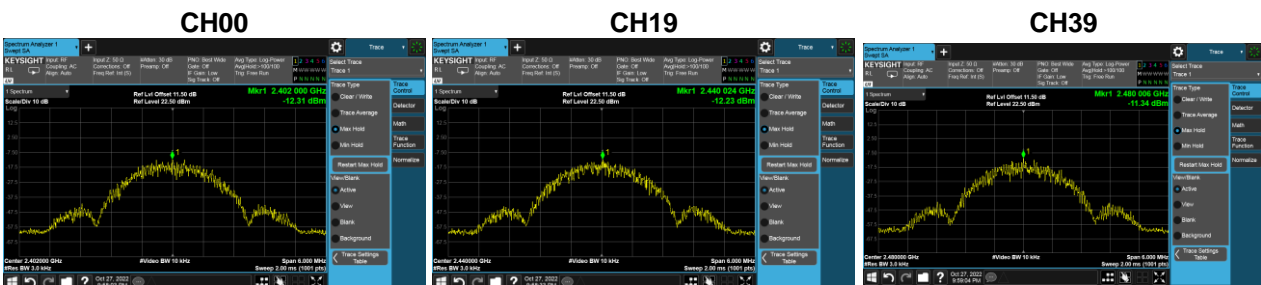

End of Test Report