



MEASUREMENT REPORT

FCC ID : RWO-RZ010360
APPLICANT : Razer Inc.
Application Type : Certification
Product : Gaming Mouse
Model No. : RZ01-0360
Serial Model No. : RZ01-0360XXXX-XXXX(X can be 0-9 or A-Z)
Brand Name : RAZER, 
FCC Classification : (DTS) Digital Transmission System
FCC Rule Part(s) : Part 15.247
Test Procedure(s) : ANSI C63.10-2013
Received Date : 2022/9/27
Test Date : 2022/9/28~2022/10/4
Tested By : *Fran Chen*
 (Fran Chen)
Reviewed By : *Paddy Chen*
 (Paddy Chen)
Approved By : *Chenz Ker*
 (Chenz Ker)



The test results only relate to the tested sample.
 This equipment has been shown to be capable of compliance with the applicable technical standards as indicated in the measurement report and was tested in accordance with the measurement procedures specified in ANSI C63.10. Test results reported herein relate only to the item(s) tested.
 The test report shall not be reproduced except in full without the written approval of MRT Technology (Taiwan) Co., Ltd.

Revision History

Report No.	Version	Description	Issue Date	Note
2210TWE913-U1	1.0	Original Report	2022-10-28	

CONTENTS

Description	Page
§2.1033 General Information	5
1. INTRODUCTION	6
1.1. Scope.....	6
1.2. MRT Test Location.....	6
2. PRODUCT INFORMATION	7
2.1. Equipment Description	7
2.2. Product Specification Subjective to this Standard.....	8
2.3. Test Mode.....	8
2.4. Operation Frequency / Channel List.....	9
2.5. Test Configuration.....	10
2.6. Test Software.....	10
2.7. EMI Suppression Device(s)/Modifications	10
2.8. Labeling Requirements	10
3. DESCRIPTION of TEST	11
3.1. Evaluation Procedure	11
3.2. AC Line Conducted Emissions	11
3.3. Radiated Emissions	12
4. ANTENNA REQUIREMENTS	13
5. TEST EQUIPMENT CALIBRATION DATE	14
6. MEASUREMENT UNCERTAINTY	15
7. TEST RESULT	16
7.1. Summary.....	16
7.2. 6dB Bandwidth Measurement	17
7.2.1. Test Limit.....	17
7.2.2. Test Procedure used	17
7.2.3. Test Setting	17
7.2.4. Test Setup	17
7.2.5. Test Result	18
7.3. Output Power Measurement.....	20
7.3.1. Test Limit.....	20
7.3.2. Test Procedure Used.....	20
7.3.3. Test Setting	20
7.3.4. Test Setup	20
7.3.5. Test Result of Output Power	21
7.4. Power Spectral Density Measurement	22
7.4.1. Test Limit.....	22
7.4.2. Test Procedure Used.....	22
7.4.3. Test Setting	22
7.4.4. Test Setup	22
7.4.5. Test Result	23



7.5.	Out-of-Band Spurious Emissions Emissions Measurement	25
7.5.1.	Test Limit	25
7.5.2.	Test Procedure Used	25
7.5.3.	Test Settiting	25
7.5.4.	Test Setup	25
7.5.5.	Test Result	26
7.6.	Radiated Spurious Emission Measurement.....	30
7.6.1.	Test Limit	30
7.6.2.	Test Procedure Used.....	30
7.6.3.	Test Setting	30
7.6.4.	Test Setup	32
7.6.5.	Test Result	34
7.7.	Radiated Restricted Band Edge Measurement.....	48
7.7.1.	Test Limit	48
7.7.2.	Test Procedure Used.....	48
7.7.3.	Test Setting	48
7.7.4.	Test Setup	50
7.7.5.	Test Result	51
7.8.	AC Conducted Emissions Measurement	61
7.8.1.	Test Limit	61
7.8.2.	Test Setup	61
7.8.3.	Test Result	62
8.	CONCLUSION	63

§2.1033 General Information

Applicant	Razer Inc.
Applicant Address	9 Pasteur, Suite 100, Irvine, CA92618, USA
Manufacturer	Razer (Asia-Pacific) Pte.,Ltd.
Manufacturer Address	1 one-north Crescent, #02-01 Singapore 138538
Test Site	MRT Technology (Taiwan) Co., Ltd
Test Site Address	No. 38, Fuxing Second Rd., Guishan Dist., Taoyuan City 333, Taiwan (R.O.C)
MRT FCC Registration No.	291082
FCC Rule Part(s)	Part 15.247
Test Device Serial No.	#1-1 <input type="checkbox"/> Production <input checked="" type="checkbox"/> Pre-Production <input type="checkbox"/> Engineering

Test Facility / Accreditations

1. MRT facility is a FCC registered (Reg. No. 291082) test facility with the site description report on file and is designated by the FCC as an Accredited Test Firm.
2. MRT facility is an IC registered (MRT Reg. No. 21723) test laboratory with the site description on file at Industry Canada.
3. MRT Lab is accredited to ISO 17025 by the Taiwan Accreditation Foundation (TAF Cert. No. 3261) in EMC, Telecommunications and Radio testing for FCC (Designation Number: TW3261), Industry Taiwan, EU and TELEC Rules.

1. INTRODUCTION

1.1. Scope

Measurement and determination of electromagnetic emissions (EMC) of radio frequency devices including intentional and/or unintentional radiators for compliance with the technical rules and regulations of the Federal Communications Commission and the Industry Canada Certification and Engineering Bureau.

1.2. MRT Test Location

The map below shows the location of the MRT LABORATORY, its proximity to the Taoyuan City. These measurement tests were conducted at the MRT Technology (Taiwan) Co., Ltd. Facility located at No.38, Fuxing 2nd Rd., Guishan Dist., Taoyuan City 33377, Taiwan (R.O.C).

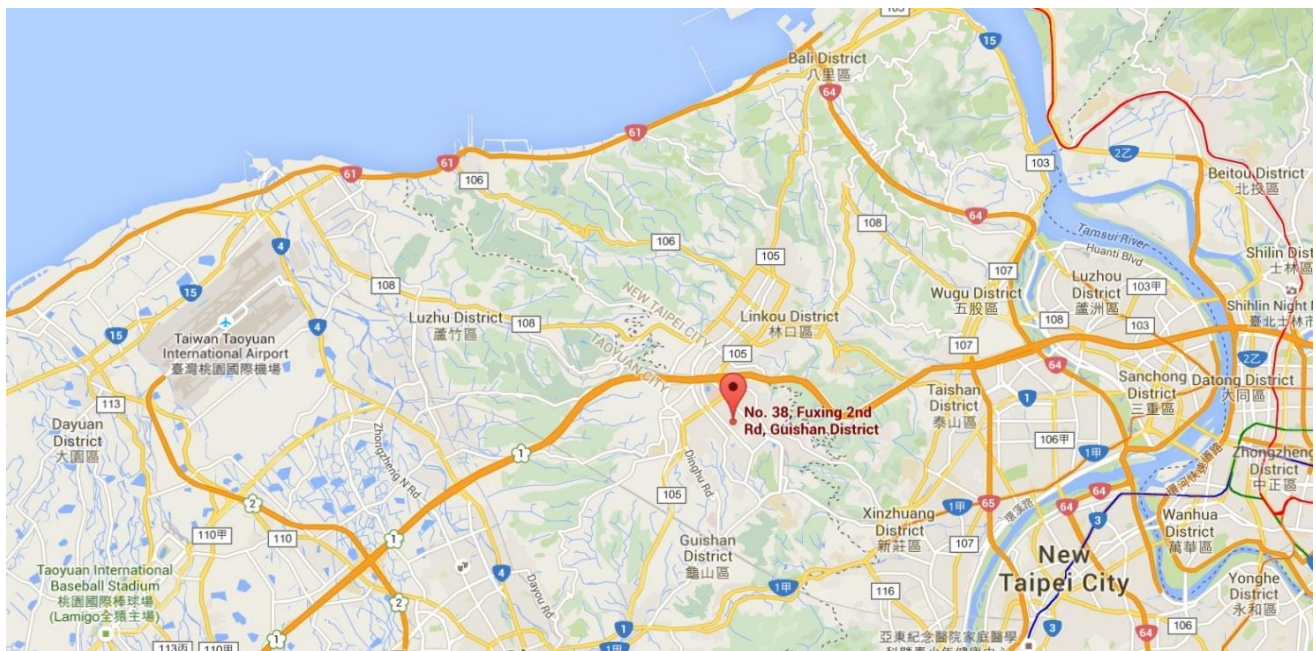

2. PRODUCT INFORMATION

2.1. Equipment Description

Product Name	Gaming Mouse
Model No.	RZ01-0360
Serial No.	RZ01-0360XXXX-XXXX (X can be 0-9 or A-Z)
Bluetooth Specification	Bluetooth Dual Mode
Maximum Power	6.64 dBm
System's Accessories	
USB WIRELESS TRANSCEIVER	Brand: RAZER Model No: DGRFG7
AA battery	Brand: Energizer Model: E91

Note 1: The above EUT information was declared by manufacturer and for more detailed features description, please refer to the manufacture's specifications of the users' manual.

Note 2: The system's model name is RZ01-0360XXXX-XXXX (X can be 0-9 or A-Z), and the system contains a Gaming Mouse (Model name: RZ01-0360) and USB Dongle (Model name: DGRFG7).

2.2. Product Specification Subjective to this Standard

Operating Frequency	2402~2480MHz
Type of modulation	GFSK
Data Rate	1Mbps / 2Mbps

2.3. Test Mode

Test Mode	Mode 1: Transmit – LE_1Mbps (GFSK) Mode 2: Transmit – LE_2Mbps (GFSK)
-----------	--

Note: Regarding to the operation frequency, the lowest, middle and highest frequency are selected to perform the test.

2.4. Operation Frequency / Channel List

Channel	Frequency	Channel	Frequency	Channel	Frequency
00	2402 MHz	01	2404 MHz	02	2406 MHz
03	2408 MHz	04	2410 MHz	05	2412 MHz
06	2414 MHz	07	2416 MHz	08	2418 MHz
09	2420 MHz	10	2422 MHz	11	2424 MHz
12	2426 MHz	13	2428 MHz	14	2430 MHz
15	2432 MHz	16	2434 MHz	17	2436 MHz
18	2438 MHz	19	2440 MHz	20	2442 MHz
21	2444 MHz	22	2446 MHz	23	2448 MHz
24	2450 MHz	25	2452 MHz	26	2454 MHz
27	2456 MHz	28	2458 MHz	29	2460 MHz
30	2462 MHz	31	2464 MHz	32	2466 MHz
33	2468 MHz	34	2470 MHz	35	2472 MHz
36	2474 MHz	37	2476 MHz	38	2478 MHz
39	2480 MHz	N/A	N/A	N/A	N/A

2.5. Test Configuration

This device was tested per the guidance of ANSI C63.10-2013. ANSI C63.10-2013 was used to reference the appropriate EUT setup for radiated spurious emissions testing and AC line conducted testing.

2.6. Test Software

N/A.

2.7. EMI Suppression Device(s)/Modifications

No EMI suppression device(s) were added and/or no modifications were made during testing.

2.8. Labeling Requirements

Per 2.1074 & 15.19; Docket 95-19

The label shall be permanently affixed at a conspicuous location on the device; instruction manual or pamphlet supplied to the user and be readily visible to the purchaser at the time of purchase. However, when the device is so small wherein placement of the label with specified statement is not practical, only the FCC ID must be displayed on the device per Section 15.19(a)(5). Please see attachment for FCC ID label and label location.

3. DESCRIPTION of TEST

3.1. Evaluation Procedure

The measurement procedures described in the American National Standard for Testing Unlicensed Wireless Devices (ANSI C63.10-2013), and the guidance provided in KDB 558074 D01v05 were used in the measurement of the **Gaming Mouse**.

Deviation from measurement procedure.....None

3.2. AC Line Conducted Emissions

The line-conducted facility is located inside an 9'x4'x3' shielded enclosure. A 1m x 2m wooden table 80cm high is placed 40cm away from the vertical wall and 80cm away from the sidewall of the shielded room. Two 10kHz-30MHz, 50Ω/50uH Line-Impedance Stabilization Networks (LISNs) are bonded to the shielded room floor. Power to the LISNs is filtered by external high-current high-insertion loss power line filters. These filters attenuate ambient signal noise from entering the measurement lines. These filters are also bonded to the shielded enclosure.

The EUT is powered from one LISN and the support equipment is powered from the second LISN. All interconnecting cables more than 1 meter were shortened to a 1 meter length by non-inductive bundling (serpentine fashion) and draped over the back edge of the test table. All cables were at least 40cm above the horizontal reference ground-plane. Power cables for support equipment were routed down to the second LISN while ensuring that that cables were not draped over the second LISN.

Sufficient time for the EUT, support equipment, and test equipment was allowed in order for them to warm up to their normal operating condition. The RF output of the LISN was connected to the receiver and exploratory measurements were made to determine the frequencies producing the maximum emission from the EUT. The receiver was scanned from 150kHz to 30MHz. The detector function was set to peak mode for exploratory measurements while the bandwidth of the analyzer was set to 9kHz. The EUT, support equipment, and interconnecting cables were arranged and manipulated to maximize each emission. Each emission was also maximized by varying: power lines, the mode of operation or data exchange speed, or support equipment which determined the worst-case emission. Once the worst case emissions have been identified, the one EUT cable configuration/arrangement and mode of operation that produced these emissions are used for final measurements on the same test site. The analyzer is set to CISPR quasi-peak and average detectors with a 9kHz resolution bandwidth for final measurements.

An extension cord was used to connect to a single LISN which powered by EUT. The extension cord was calibrated with LISN, the impedance and insertion loss are compliance with the requirements as stated in ANSI C63.10-2013.

Line conducted emissions test results are shown in Section 7.8.

3.3. Radiated Emissions

The radiated test facilities consisted of an indoor 3 meter semi-anechoic chamber used for final measurements and exploratory measurements, when necessary. The measurement area is contained within the semi-anechoic chamber which is shielded from any ambient interference. For measurements above 1GHz absorbers are arranged on the floor between the turn table and the antenna mast in such a way so as to maximize the reduction of reflections. For measurements below 1GHz, the absorbers are removed. A MF Model 210SS turntable is used for radiated measurement. It is a continuously rotatable, remote controlled, metallic turntable and 2 meters (6.56 ft.) in diameter. The turn table is flush with the raised floor of the chamber in order to maintain its function as a ground plane. An 80cm high PVC support structure is placed on top of the turntable.

For all measurements, the spectrum was scanned through all EUT azimuths and from 1 to 4 meter receive antenna height using a broadband antenna from 30MHz up to the upper frequency shown in 15.33(b)(1) depending on the highest frequency generated or used in the device or on which the device operates or tunes. For frequencies above 1GHz, linearly polarized double ridge horn antennas were used. For frequencies below 30MHz, a calibrated loop antenna was used. When exploratory measurements were necessary, they were performed at 1 meter test distance inside the semi-anechoic chamber using broadband antennas, broadband amplifiers, and spectrum analyzers to determine the frequencies and modes producing the maximum emissions. Sufficient time for the EUT, support equipment, and test equipment was allowed in order for them to warm up to their normal operating condition. The test set-up for frequencies below 1GHz was placed on top of the 0.8 meter high, 1 x 1.5 meter table; and test set-up for frequencies 1-40GHz was placed on top of the 1.5 meter high, 1 x 1.5 meter table. The EUT, support equipment, and interconnecting cables were arranged and manipulated to maximize each emission. Appropriate precaution was taken to ensure that all emissions from the EUT were maximized and investigated. The system configuration, clock speed, mode of operation or video resolution, if applicable, turntable azimuth, and receive antenna height was noted for each frequency found.

Final measurements were made in the semi-anechoic chamber using calibrated, linearly polarized broadband and horn antennas. The test setup was configured to the setup that produced the worst case emissions. The spectrum analyzer was set to investigate all frequencies required for testing to compare the highest radiated disturbances with respect to the specified limits. The turntable containing the EUT was rotated through 360 degrees and the height of the receive antenna was varied 1 to 4 meters and stopped at the azimuth and height producing the maximum emission. Each emission was maximized by changing the orientation of the EUT through three orthogonal planes and changing the polarity of the receive antenna, which produced the worst-case emissions. According to 3dB Beam-Width of horn antenna, the horn antenna should be always directed to the EUT when rising height.

Radiated emissions test results are shown in Section 7.6 & 7.7 .

4. ANTENNA REQUIREMENTS

Excerpt from §15.203 of the FCC Rules/Regulations:

“An intentional radiator antenna shall be designed to ensure that no antenna other than that furnished by the responsible party can be used with the device. The use of a permanently attached antenna or of an antenna that uses a unique coupling to the intentional radiator shall be considered sufficient to comply with the provisions of this section.”

- The antenna of the **Gaming Mouse**, is permanently attached.
- There are no provisions for connection to an external antenna.

Conclusion:

The EUT unit complies with the requirement of §15.203.

Antenna List

No.	Manufacturer	Part No.	Antenna Type	Peak Gain
1	RAZER	RZ01-0360	PCB	1.72dBi

5. TEST EQUIPMENT CALIBRATION DATE

Conducted Emissions – SR2

Instrument	Manufacturer	Type No.	Asset No.	Cali. Interval	Cali. Due Date
Two-Line V-Network	R&S	ENV216	MRTTWA00020	1 year	2023/4/20
Cable	Rosnol	N1C50-RG400-B 1C50-500CM	MRTTWE00013	1 year	2023/6/19
EMI Test Receiver	R&S	ESR3	MRTTWA00009	1 year	2023/3/9

Radiated Emissions – AC1

Instrument	Manufacturer	Type No.	Asset No.	Cali. Interval	Cali. Due Date
Broadband TRILOG Antenna	SCHWARZBECK	VULB 9162	MRTTWA00001	1 year	2022/10/4
EMI Test Receiver	R&S	ESR3	MRTTWA00009	1 year	2023/3/9
Active Loop Antenna	Schwarzbeck	FMZB 1519B	MRTTWA00002	1 year	2023/5/24
Broadband Horn antenna	SCHWARZBECK	BBHA 9120D	MRTTWA00003	1 year	2023/3/30
Breitband Hornantenna	Schwarzbeck	BBHA 9170	MRTTWA00004	1 year	2023/3/29
Broadband Amplifier	Schwarzbeck	BBV 9721	MRTTWA00006	1 year	2023/3/30
Broadband Preampfier	SCHWARZBECK	BBV 9718	MRTTWA00005	1 year	2023/3/30
Cable	HUBERSUHNER	SF106	MRTTWE00010	1 year	2023/5/23
Cable	Rosnol	K1K50-UP0264- K1K50-4M	MRTTWE00012	1 year	2023/6/19

Conducted Test Equipment – SR5

Instrument	Manufacturer	Type No.	Asset No.	Cali. Interval	Cali. Due Date
EXA Signal Analyzer	KEYSIGHT	N9010A	MRTTWA00012	1 year	2022/10/18
EXA Signal Analyzer	KEYSIGHT	N9010B	MRTTWA00074	1 year	2023/7/19
USB Wideband Power Sensor	KEYSIGHT	U2021XA	MRTTWA00015	1 year	2023/3/16

Test Software

Software	Version	Function
e3	9.160520a	EMI Test Software
EMI	V3	EMI Test Software

6. MEASUREMENT UNCERTAINTY

Where relevant, the following test uncertainty levels have been estimated for tests performed on the EUT as specified in CISPR 16-4-2. This uncertainty represents an expanded uncertainty expressed at approximately the 95% confidence level using a coverage factor of $k = 2$.

Conducted Emission- Power Line
Measuring Uncertainty for a Level of Confidence of 95% ($U=2Uc(y)$): 0.15MHz~30MHz: $\pm 2.53\text{dB}$
Radiated Spurious Emission
Measuring Uncertainty for a Level of Confidence of 95% ($U=2Uc(y)$): 9kHz~30MHz: $\pm 3.92\text{dB}$ 30MHz~1GHz: $\pm 4.25\text{dB}$ 1GHz~18GHz: $\pm 4.40\text{dB}$ 18GHz~40GHz: $\pm 4.45\text{dB}$
Frequency Error
Measuring Uncertainty for a Level of Confidence of 95% ($U=2Uc(y)$): $\pm 78.4\text{Hz}$
Conducted Power
Measuring Uncertainty for a Level of Confidence of 95% ($U=2Uc(y)$): $\pm 0.84\text{dB}$
Conducted Spurious Emission
Measuring Uncertainty for a Level of Confidence of 95% ($U=2Uc(y)$): $\pm 2.65\text{ dB}$
Occupied Bandwidth
Measuring Uncertainty for a Level of Confidence of 95% ($U=2Uc(y)$): $\pm 3.3\%$
Temp. / Humidity
Measuring Uncertainty for a Level of Confidence of 95% ($U=2Uc(y)$): $\pm 0.82^\circ\text{C}/ \pm 3\%$
DC Voltage
Measuring Uncertainty for a Level of Confidence of 95% ($U=2Uc(y)$): $\pm 0.3\%$

7. TEST RESULT

7.1. Summary

Product Name: Gaming Mouse

FCC Classification: (DTS) Digital Transmission System

FCC Part Section(s)	Test Description	Test Limit	Test Condition	Test Result	Reference
15.247(a)(2)	6dB Bandwidth	$\geq 500\text{kHz}$	Conducted	Pass	Section 7.2
15.247(b)(3)	Output Power	$\leq 30.00\text{dBm}$		Pass	Section 7.3
15.247(e)	Power Spectral Density	$\leq 8.00\text{dBm}/3\text{kHz}$		Pass	Section 7.4
15.247(d)	Out-of-Band Emissions	Conducted $\geq 20\text{dBc}$		Pass	Section 7.5
15.205 15.209	Spurious Emission	< FCC 15.209 limits	Radiated	Pass	Section 7.6
15.205 15.209	Band Edge Measurement	$\leq 74\text{dBuV/m(Peak)}$ $\leq 54\text{dBuV/m(Average)}$		Pass	Section 7.7
15.207	AC Conducted Emissions 150kHz - 30MHz	< FCC 15.207 limits	Line Conducted	N/A	Section 7.8

Notes:

- Determining compliance is based on the test results met the regulation limits or requirements declared by clients, and the test results don't take into account the value of measurement uncertainty.
- All modes of operation and data rates were investigated. For radiated emission test, every axis (X, Y, Z) was also verified. The test results shown in the following sections represent the worst case emissions.
- The analyzer plots shown in this section were all taken with a correction table loaded into the analyzer. The correction table was used to account for the losses of the cables and attenuators used as part of the system to connect the EUT to the analyzer at all frequencies of interest.
- All antenna port conducted emissions testing was performed on a test bench with the antenna port of the EUT connected to the spectrum analyzer through calibrated cables and attenuators.

7.2. 6dB Bandwidth Measurement

7.2.1. Test Limit

The minimum 6dB bandwidth shall be at least 500 kHz.

7.2.2. Test Procedure used

KDB 558074 D01v05- Section 8.2 Option 2

7.2.3. Test Setting

1. The Spectrum's automatic bandwidth measurement capability was used to perform the 6dB bandwidth measurement. The "X" dB bandwidth parameter was set to $X = 6$. The bandwidth measurement was not influenced by any intermediate power nulls in the fundamental emission.
2. Set RBW = 100 kHz
3. VBW $\geq 3 \times$ RBW
4. Detector = Peak
5. Trace mode = max hold
6. Sweep = auto couple
7. Allow the trace was allowed to stabilize

7.2.4. Test Setup

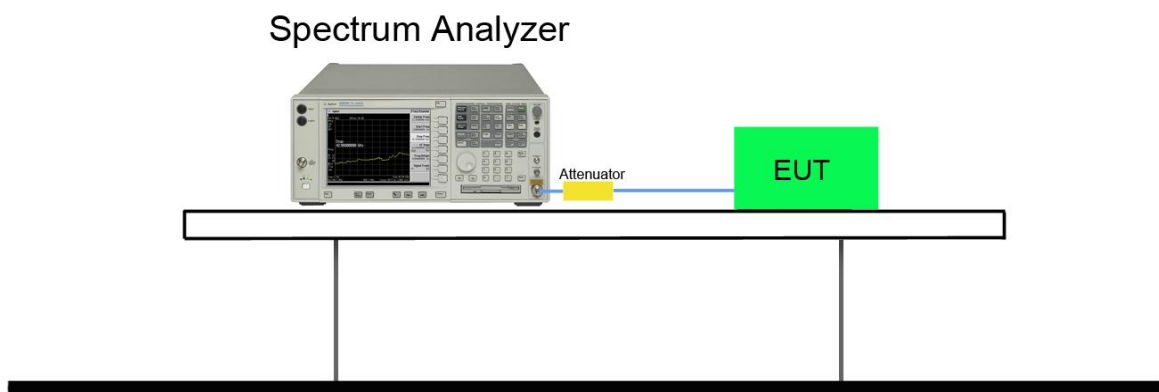

7.2.5. Test Result

Test Mode	Channel No.	Frequency (MHz)	6dB Bandwidth (MHz)	99% Bandwidth (MHz)	Limit (MHz)	Result
LE-1Mbps	00	2402	0.6813	1.0690	≥ 0.5	Pass
	19	2440	0.6957	1.0893	≥ 0.5	Pass
	39	2480	0.6919	1.0815	≥ 0.5	Pass
LE-2Mbps	00	2402	1.1610	2.0215	≥ 0.5	Pass
	19	2440	1.1190	2.0513	≥ 0.5	Pass
	39	2480	1.1150	2.0463	≥ 0.5	Pass

LE-1Mbps CH00 (2402MHz)



LE-1Mbps CH19 (2440MHz)



LE-1Mbps CH39 (2480MHz)

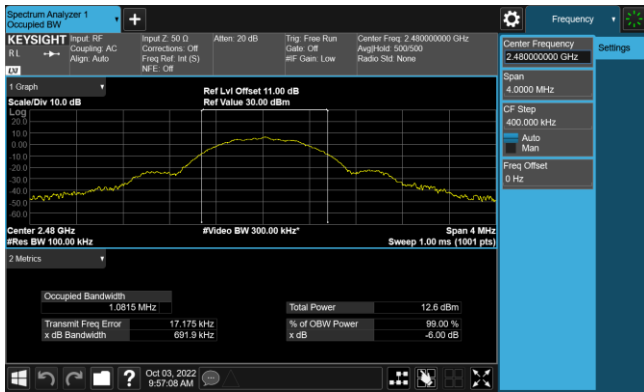

LE-2Mbps CH00 (2402MHz)

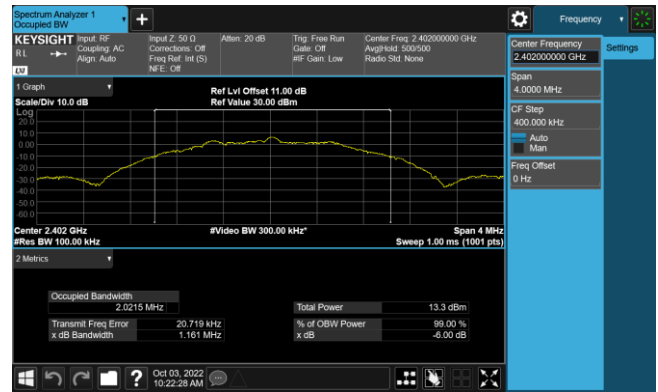

LE-2Mbps CH19 (2440MHz)

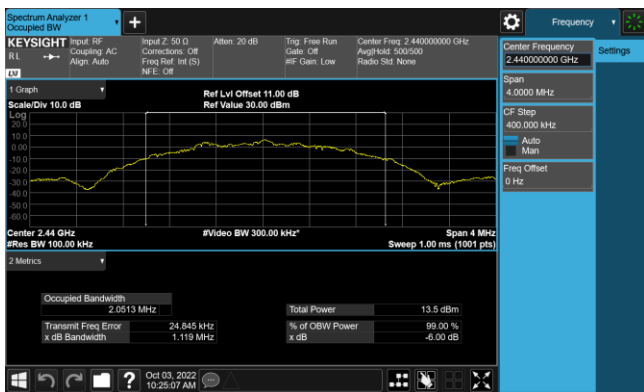

LE-2Mbps CH39 (2480MHz)

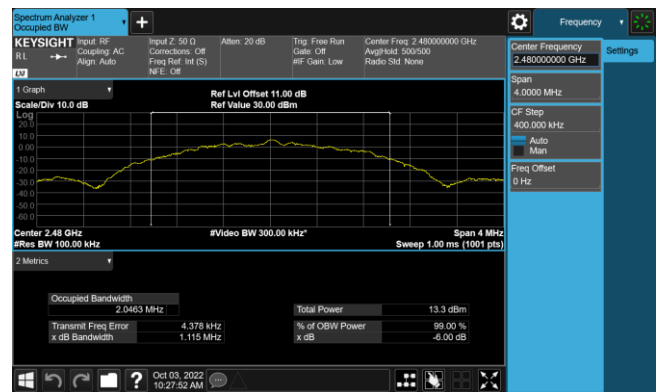

7.3. Output Power Measurement

7.3.1. Test Limit

The maximum out power shall be less 1 Watt (30dBm).

7.3.2. Test Procedure Used

KDB 558074 D01v05 - Section 9.1.2 & 9.2.3.2

7.3.3. Test Setting

Peak Power Measurement

The maximum peak conducted output power may be measured using a broadband peak RF power meter. The power meter shall have a video bandwidth that is greater than or equal to the DTS bandwidth and shall utilize a fast-responding diode detector.

Average Power Measurement

Average power measurements were performed only when the EUT was transmitting at its maximum power control level using a broadband power meter with a pulse sensor. The power meter implemented triggering and gating capabilities which were set up such that power measurements were recorded only during the ON time of the transmitter. The trace was averaged over 100 traces to obtain the final measured average power.

7.3.4. Test Setup

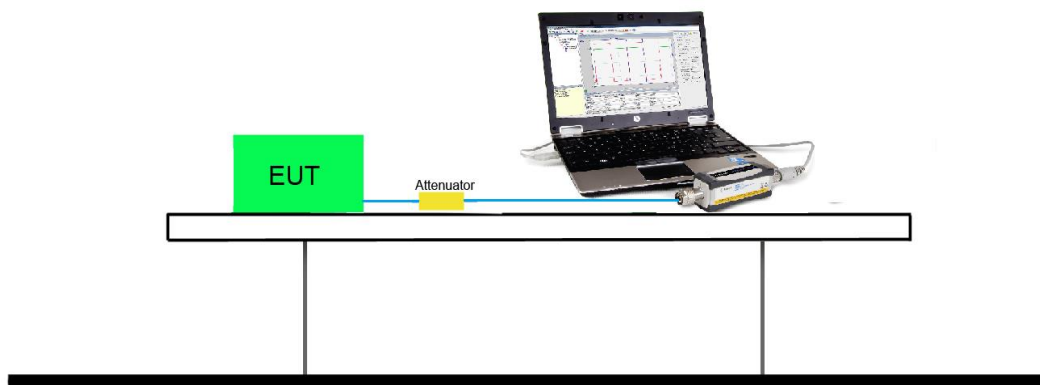

7.3.5. Test Result of Output Power

Test Mode	Channel No.	Frequency (MHz)	Peak Power (dBm)	Peak Power Limit (dBm)
LE-1Mbps	00	2402	6.51	< 30
	19	2440	6.64	< 30
	39	2480	6.64	< 30
LE-2Mbps	00	2402	6.52	< 30
	19	2440	6.63	< 30
	39	2480	6.64	< 30

Note: Output power = Reading value on power meter + cable loss.

7.4. Power Spectral Density Measurement

7.4.1. Test Limit

The maximum permissible power spectral density is 8dBm in any 3 kHz band.

7.4.2. Test Procedure Used

KDB 558074 D01v05 - Section 10.2 Method PKPSD

7.4.3. Test Setting

This procedure shall be used if maximum peak conducted output power was used to demonstrate compliance, and is optional if the maximum conducted (average) output power was used to demonstrate compliance.

- a) Set analyzer center frequency to DTS channel center frequency.
- b) Set the span to 1.5 times the DTS bandwidth.
- c) Set the RBW to: 3 kHz.
- d) Set the VBW $\geq 3^*$ RBW.
- e) Detector = peak.
- f) Sweep time = auto couple.
- g) Trace mode = max hold.
- h) Allow trace to fully stabilize.
- i) Use the peak marker function to determine the maximum amplitude level within the RBW.

7.4.4. Test Setup

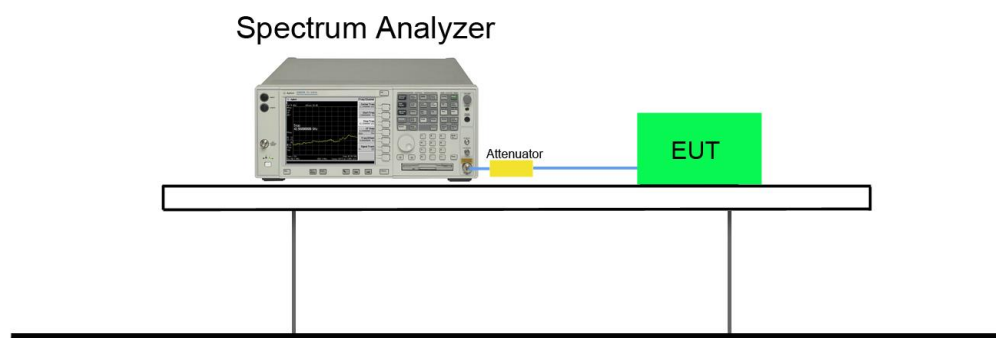

7.4.5. Test Result

Test Mode	Channel No.	Frequency (MHz)	PSD (dBm / 3kHz)	Limit (dBm / 3kHz)	Result
LE-1Mbps	00	2402	-7.54	≤ 8	Pass
	19	2440	-6.60	≤ 8	Pass
	39	2480	-8.09	≤ 8	Pass
LE-2Mbps	00	2402	-9.11	≤ 8	Pass
	19	2440	-8.46	≤ 8	Pass
	39	2480	-8.97	≤ 8	Pass

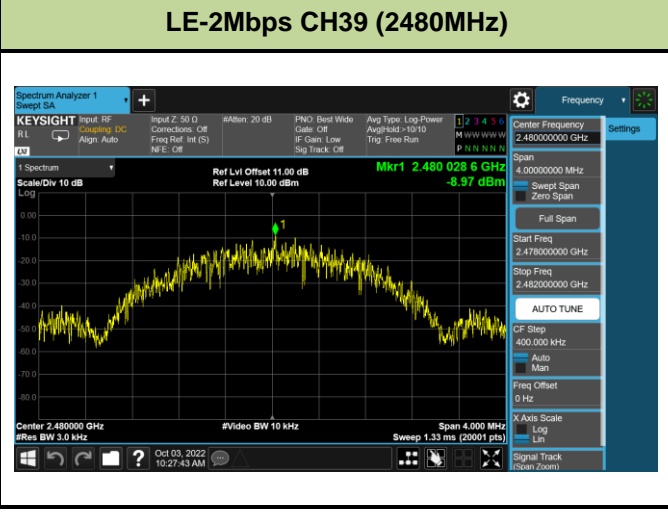
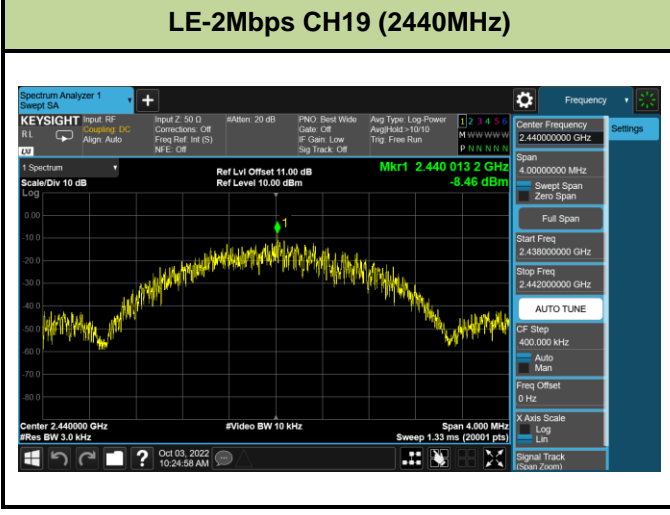
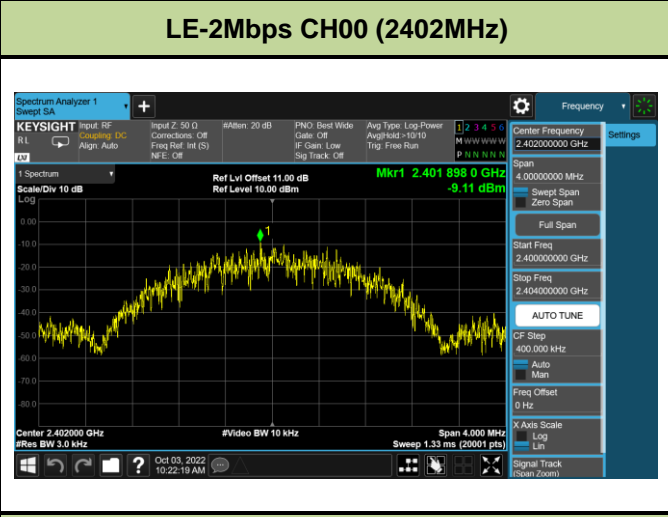
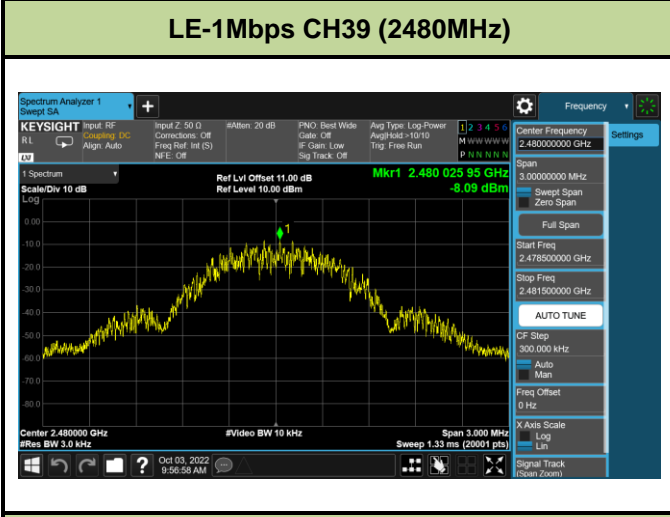
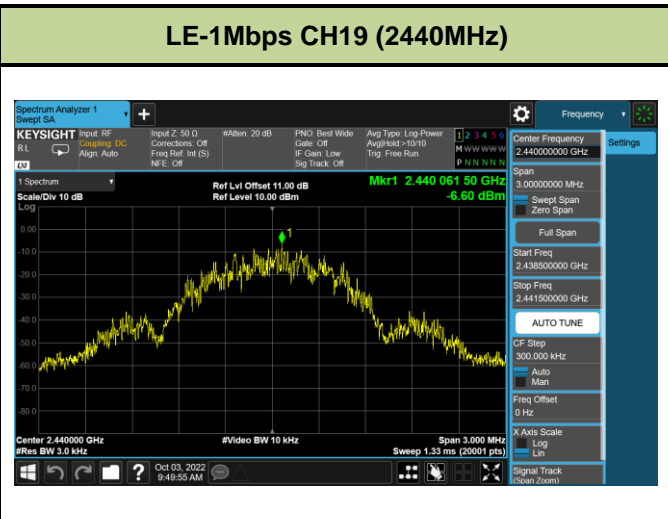
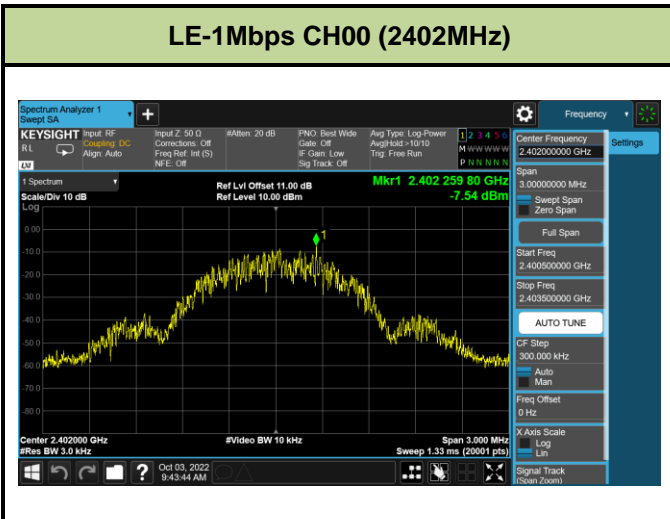

7.5. Out-of-Band Spurious Emissions Emissions Measurement

7.5.1. Test Limit

In any 100 kHz bandwidth outside the frequency band in which the spread spectrum or digitally modulated intentional radiator is operating, the radio frequency power that is produced by the intentional radiator shall be at least 20 dB below that in the 100 kHz bandwidth within the band that contains the highest level of the desired power, based on RF conducted measurement, provided the transmitter demonstrates compliance with the peak conducted power limits.

7.5.2. Test Procedure Used

KDB 558074 D01v05- Section 11.1 & 11.2

7.5.3. Test Setting

- (a) Set instrument center frequency to DTS channel center frequency
- (b) Set the span to ≥ 1.5 times the DTS bandwidth
- (c) Set the RBW = 100 kHz
- (d) Set the VBW $\geq 3 \times$ RBW
- (e) Detector = peak
- (f) Sweep time = auto couple
- (g) Trace mode = max hold
- (h) Allow trace to fully stabilize

7.5.4. Test Setup

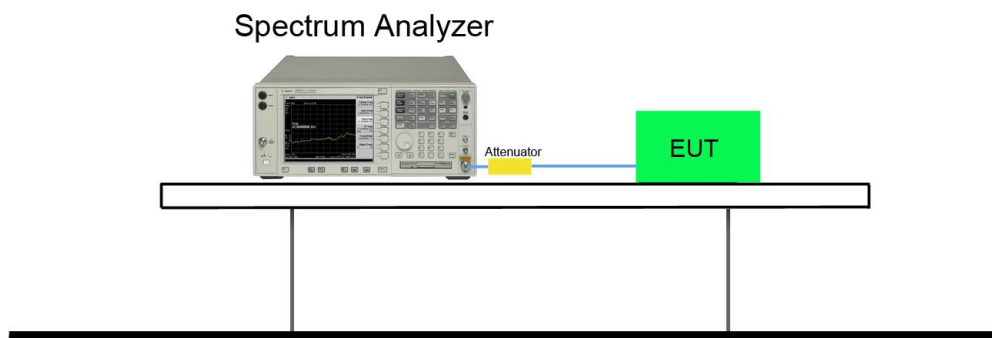

7.5.5. Test Result

Test Mode	Channel No.	Frequency (MHz)	Limit	Result
LE	00	2402	20dBc	Pass
LE	19	2440	20dBc	Pass
LE	39	2480	20dBc	Pass

CH00 (2402MHz) LE(1Mbps)

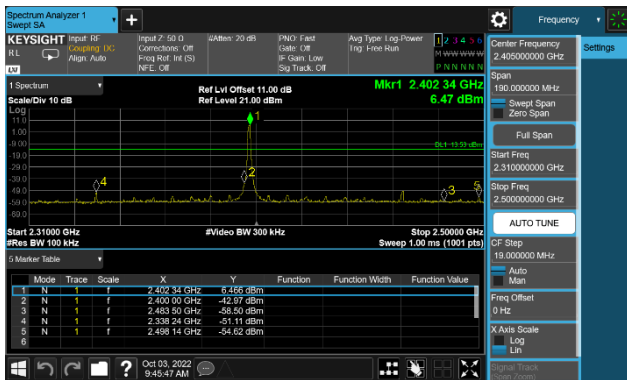

CH00 (2402MHz) LE(1Mbps)

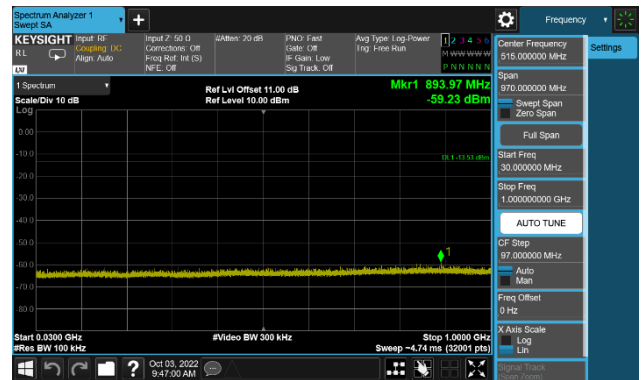

CH00 (2402MHz) LE(1Mbps)

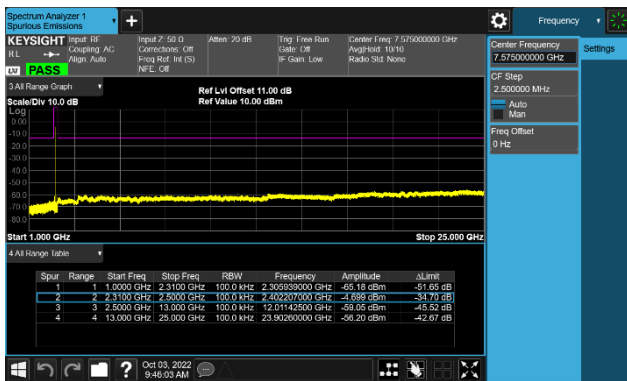

CH19 (2440MHz) LE(1Mbps)

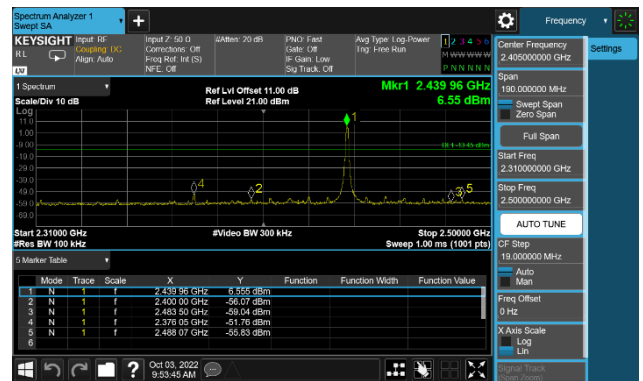

CH19 (2440MHz) LE(1Mbps)

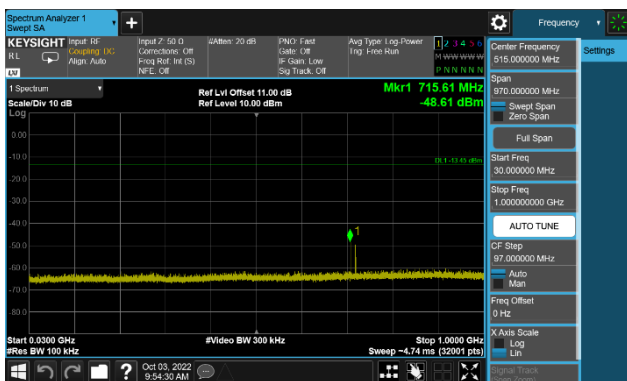

CH19 (2440MHz) LE(1Mbps)

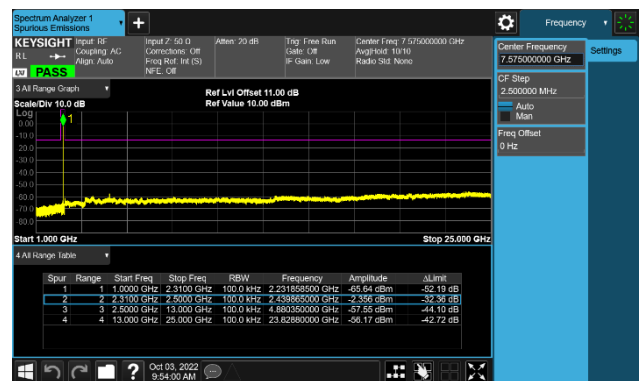

CH39 (2480MHz) LE(1Mbps)

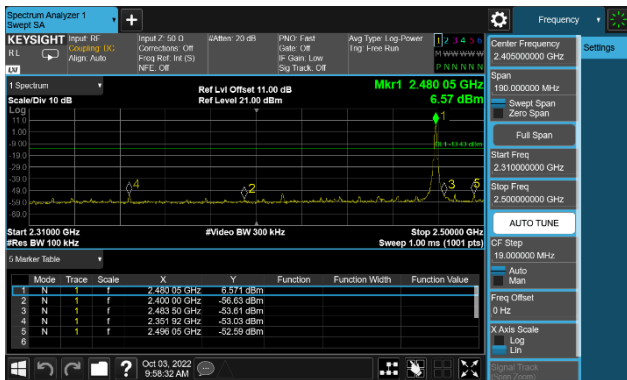

CH39 (2480MHz) LE(1Mbps)

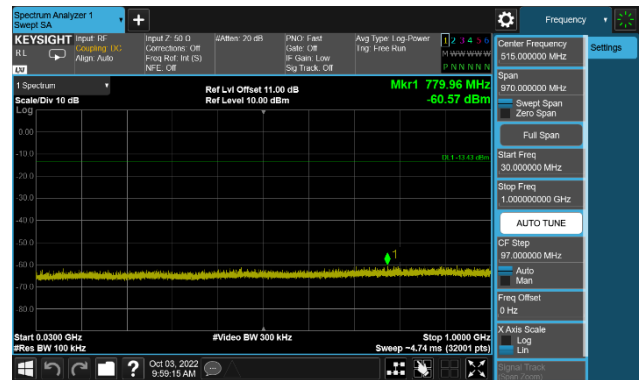

CH39 (2480MHz) LE(1Mbps)

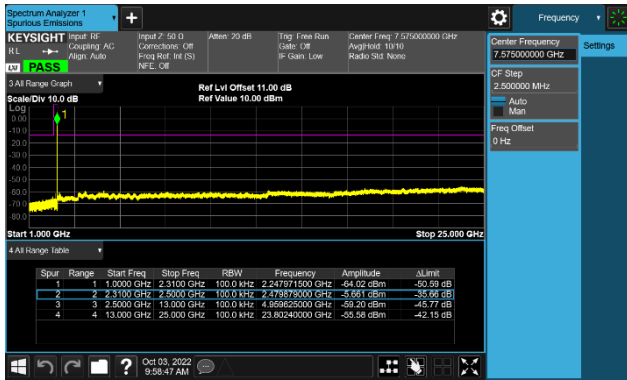

CH00 (2402MHz) LE(2Mbps)

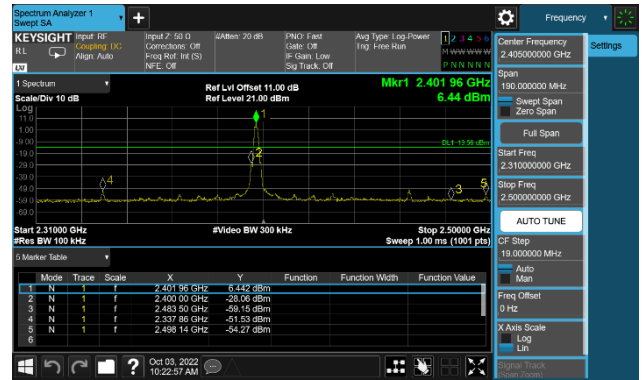

CH00 (2402MHz) LE(2Mbps)

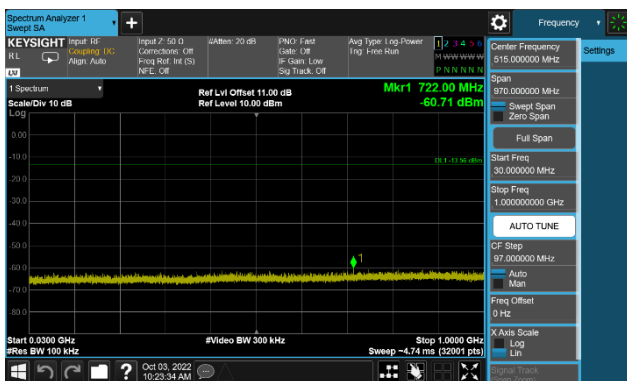

CH00 (2402MHz) LE(2Mbps)

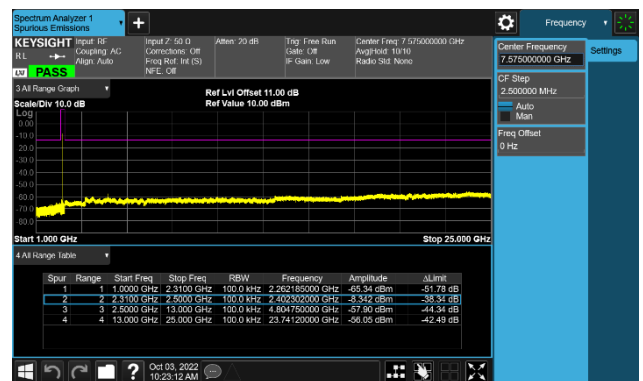

CH19 (2440MHz) LE(2Mbps)

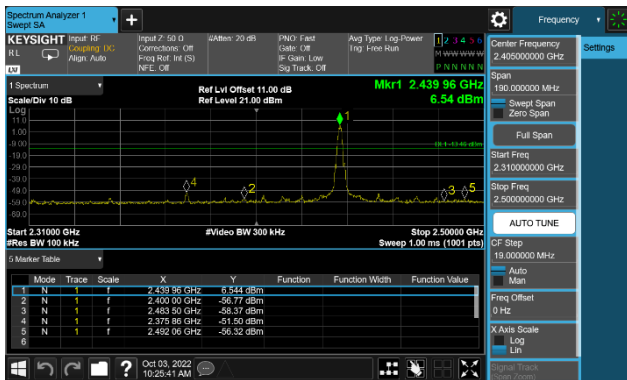

CH19 (2440MHz) LE(2Mbps)

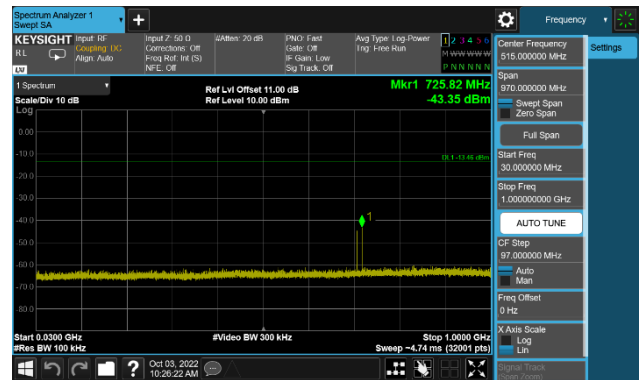

CH19 (2440MHz) LE(2Mbps)

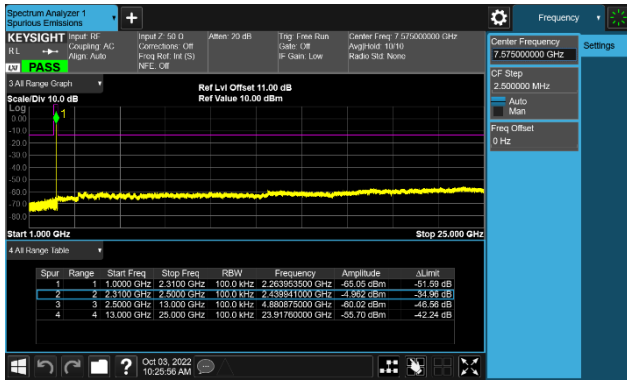

CH39 (2480MHz) LE(2Mbps)

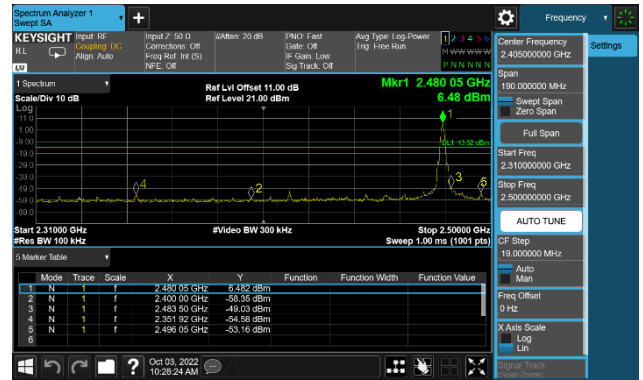

CH39 (2480MHz) LE(2Mbps)

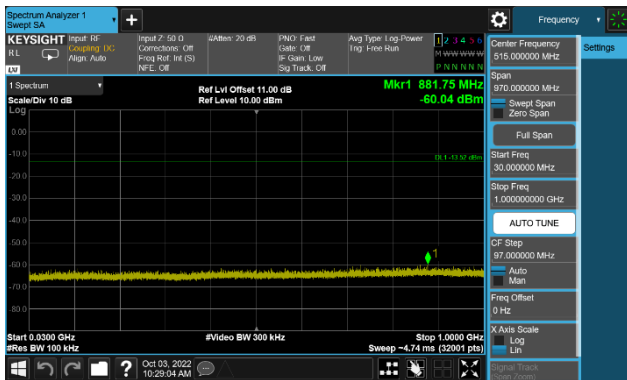

CH39 (2480MHz) LE(2Mbps)

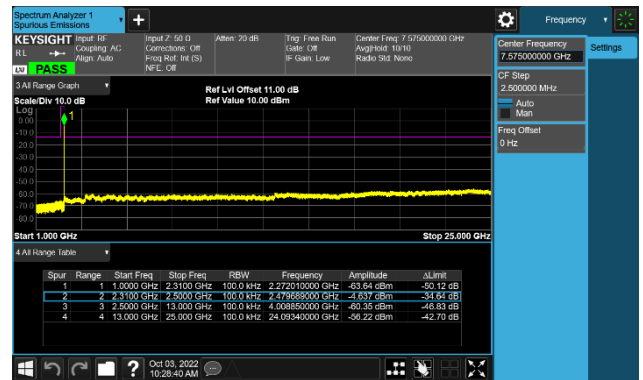

7.6. Radiated Spurious Emission Measurement

7.6.1. Test Limit

All out of band emissions appearing in a restricted band as specified in Section 15.205 of the Title 47 CFR must not exceed the limits shown in Table per Section 15.209.

FCC Part 15 Subpart C Paragraph 15.209		
Frequency [MHz]	Field Strength [V/m]	Measured Distance [Meters]
0.009 - 0.490	2400/F (kHz)	300
0.490 - 1.705	24000/F (kHz)	30
1.705 - 30	30	30
30 - 88	100	3
88 - 216	150	3
216 - 960	200	3
Above 960	500	3

7.6.2. Test Procedure Used

KDB 558074 D01v05- Section 12.2.3 (quasi-peak measurements)

KDB 558074 D01v05- Section 12.2.4 (peak power measurements)

KDB 558074 D01v05- Section 12.2.5 (average power measurements)

7.6.3. Test Setting

Peak Field Strength Measurements

1. Analyzer center frequency was set to the frequency of the radiated spurious emission of interest
2. RBW = as specified in Table 1
3. VBW = 3MHz
4. Detector = peak
5. Sweep time = auto couple

6. Trace mode = max hold

7. Trace was allowed to stabilize

Table 1 - RBW as a function of frequency

Frequency	RBW
9 ~ 150 kHz	200 ~ 300 Hz
0.15 ~ 30 MHz	9 ~ 10 kHz
30 ~ 1000 MHz	100 ~ 120 kHz
> 1000 MHz	1 MHz

Average Field Strength Measurements

1. Analyzer center frequency was set to the frequency of the radiated spurious emission of interest

2. RBW = 1MHz

3. VBW \geq 1/T

4. De As an alternative, the instrument may be set to linear detector mode. Ensure that video filtering is applied in linear voltage domain (rather than in a log or dB domain). Some instruments require linear display mode in order to accomplish this. Others have a setting for Average-VBW Type, which can be set to "Voltage" regardless of the display mode

5. Detector = Peak

6. Sweep time = auto

7. Trace mode = max hold

8. Allow max hold to run for at least 50 times (1/duty cycle) traces

7.6.4. Test Setup

9kHz ~ 30MHz Test Setup:

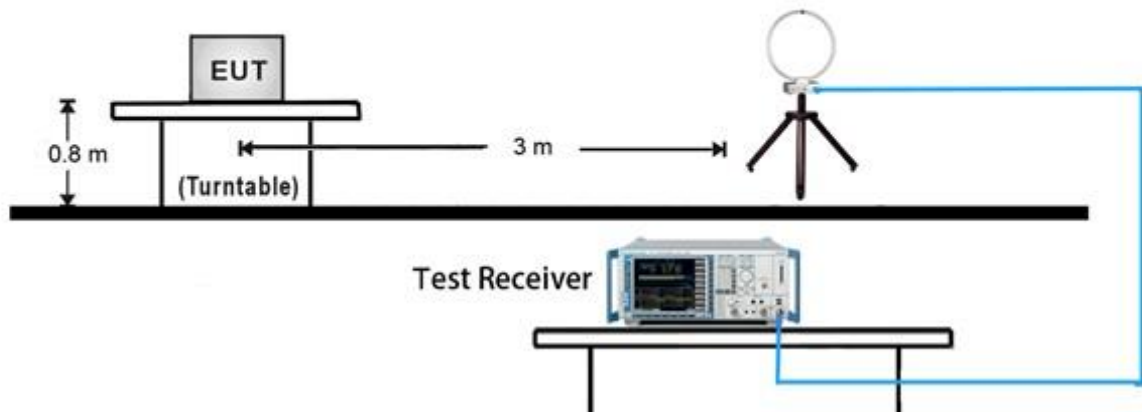

30MHz ~ 1GHz Test Setup:

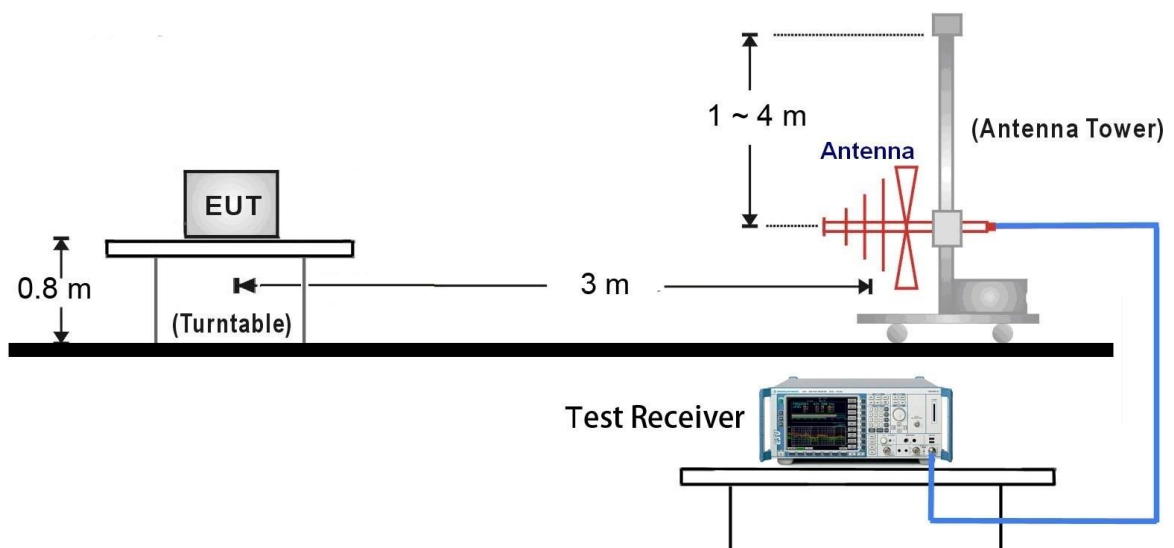

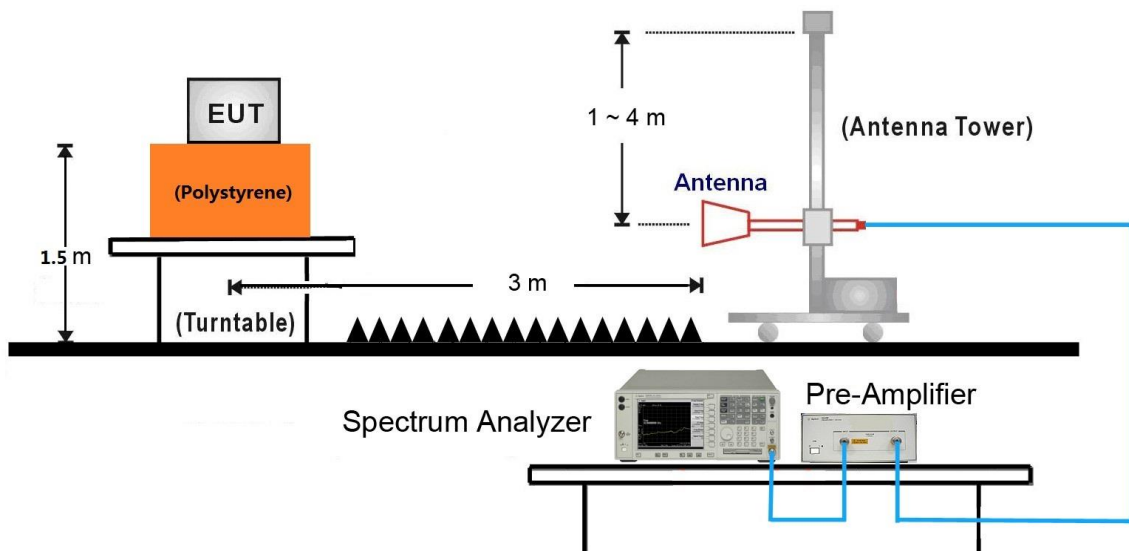
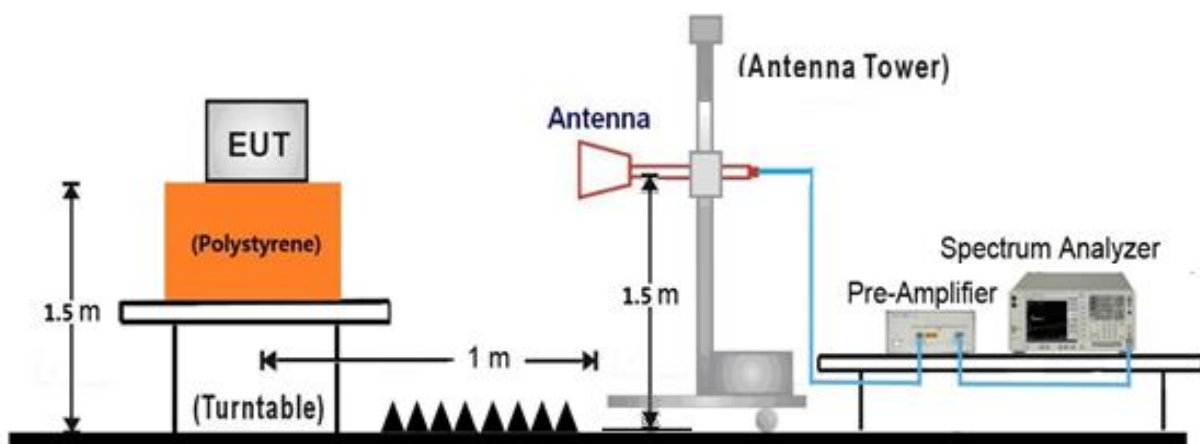
1GHz ~ 18GHz Test Setup:18GHz ~25GHz Test Setup:

7.6.5. Test Result

EUT	Gaming Mouse	Date of Test	2022-09-29
Factor	VULB 9162	Temp. / Humidity	23°C /58%
Polarity	Horizontal	Site / Test Engineer	AC1 / Kaunaz
Test Mode	BLE_TX_1Mbps_CH 19	Test Voltage	By Battery

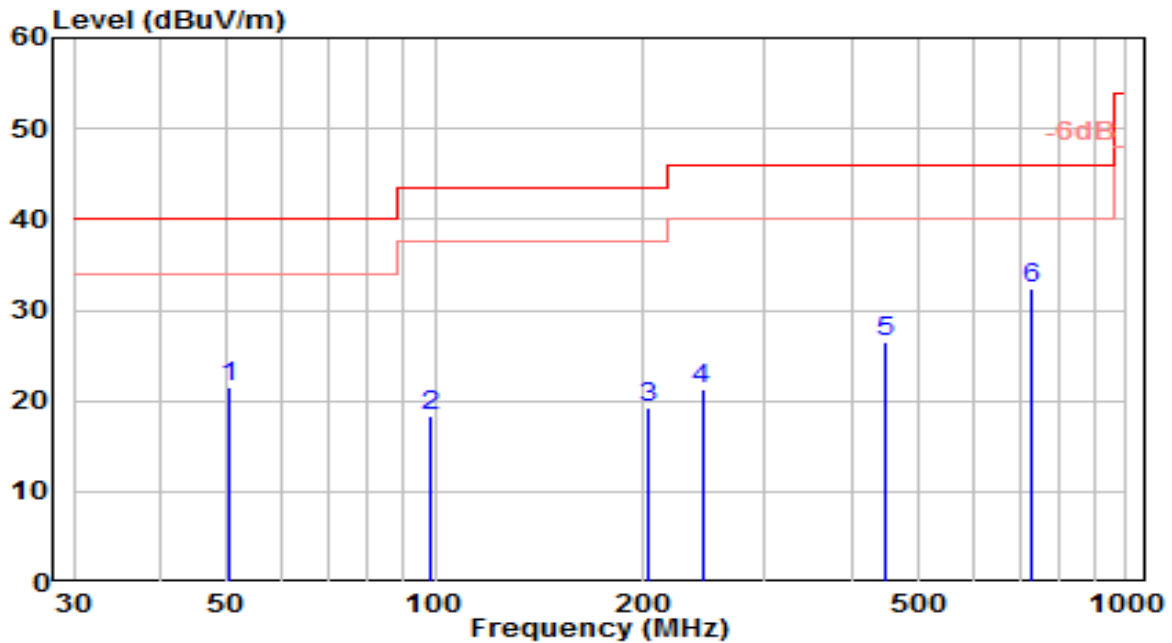

No	Frequency (MHz)	Reading (dBuV)	C.F (dB/m)	Measurement (dBuV/m)	Margin (dB)	Limit (dBuV/m)	Height (cm)	Angle (deg)	Remark (QP/PK/AV)
1	50.370	0.02	21.39	21.41	-18.59	40.00	100	190	QP
2	98.870	-0.74	19.08	18.34	-25.16	43.50	100	290	QP
3	202.660	0.48	18.73	19.21	-24.29	43.50	100	290	QP
4	243.400	0.78	20.58	21.37	-24.63	46.00	100	185	QP
5	448.070	1.87	24.67	26.54	-19.46	46.00	100	305	QP
6	* 731.310	2.73	29.75	32.48	-13.52	46.00	100	310	QP

Note:

1. " *", means this data is the worst emission level.
2. C.F (Correction Factor) = Antenna Factor (dB)+ Cable Loss (dB).
3. Measurement (dBuV/m) = Reading(dBuV) + C.F (Correction Factor).
4. The emission levels of other frequencies are very lower than the limit and not show in test report.

EUT	Gaming Mouse	Date of Test	2022-09-29
Factor	VULB 9162	Temp. / Humidity	23°C /58%
Polarity	Vertical	Site / Test Engineer	AC1 / Kaunaz
Test Mode	BLE_TX_1Mbps_CH 19	Test Voltage	By Battery

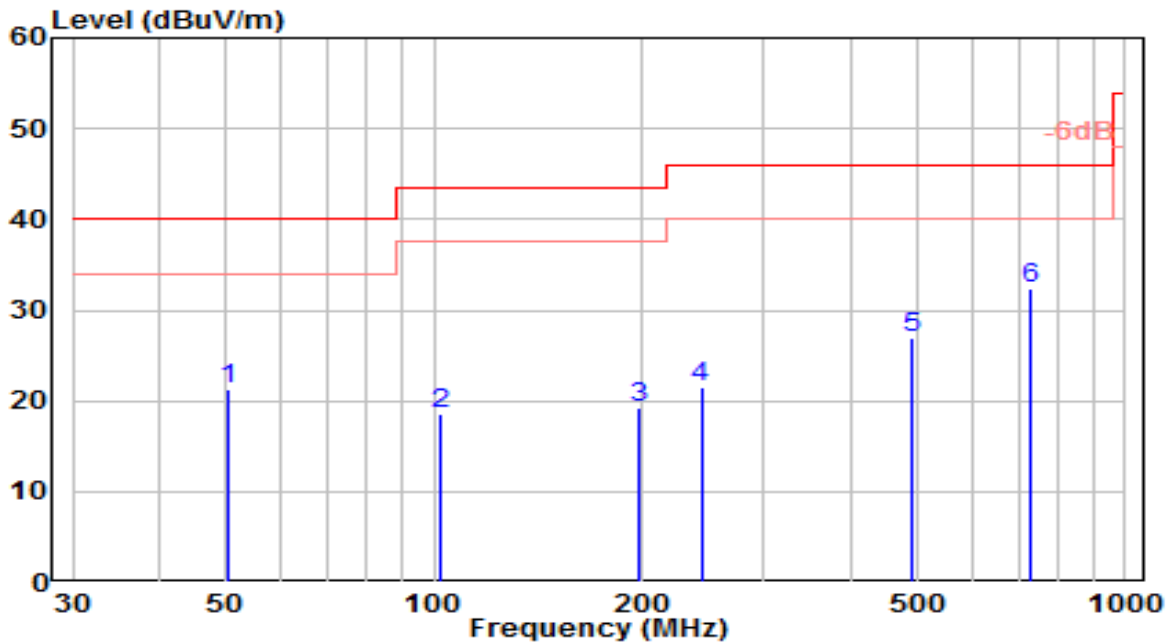

No	Frequency (MHz)	Reading (dBuV)	C.F (dB/m)	Measurement (dBuV/m)	Margin (dB)	Limit (dBuV/m)	Height (cm)	Angle (deg)	Remark (QP/PK/AV)
1	50.370	-0.08	21.39	21.31	-18.69	40.00	100	120	QP
2	101.780	-0.69	19.20	18.51	-24.99	43.50	100	305	QP
3	197.810	0.46	18.68	19.14	-24.36	43.50	100	265	QP
4	243.400	0.99	20.58	21.58	-24.42	46.00	100	360	QP
5	490.750	1.21	25.77	26.98	-19.02	46.00	100	240	QP
6	* 730.340	2.67	29.74	32.41	-13.59	46.00	100	260	QP

Note:

1. " *", means this data is the worst emission level.
2. C.F (Correction Factor) = Antenna Factor (dB)+ Cable Loss (dB).
3. Measurement (dBuV/m) = Reading(dBuV) + C.F (Correction Factor).
4. The emission levels of other frequencies are very lower than the limit and not show in test report.

EUT	Gaming Mouse	Date of Test	2022-09-29
Factor	BBHA 9120D & BBHA 9170	Temp. / Humidity	24°C /68%
Polarity	Horizontal	Site / Test Engineer	AC1 / Kaunaz
Test Mode	BLE_TX_1Mbps_CH 0	Test Voltage	By Battery

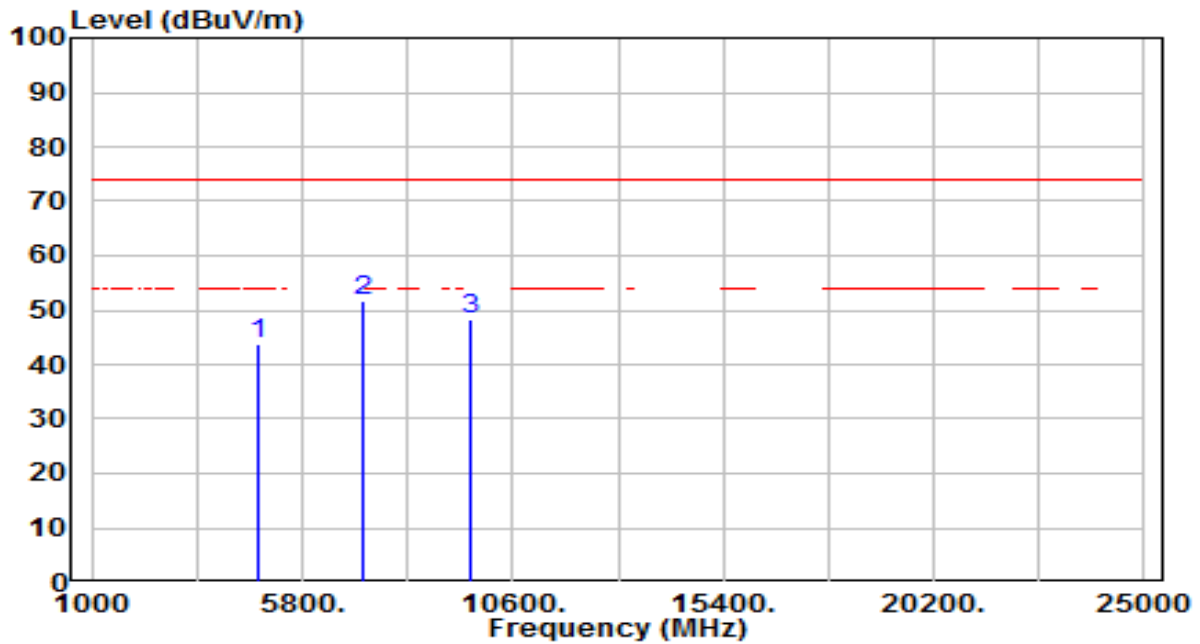

No	Frequency (MHz)	Reading (dBuV)	C.F (dB/m)	Measurement (dBuV/m)	Margin (dB)	Limit (dBuV/m)	Height (cm)	Angle (deg)	Remark (QP/PK/AV)
1	4804.000	40.33	3.61	43.94	-30.06	74.00	150	360	Peak
2	* 7206.000	40.12	11.68	51.80	-22.20	74.00	150	360	Peak
3	9608.000	32.46	15.69	48.16	-25.84	74.00	150	360	Peak

Note:

1. " *" , means this data is the worst emission level.
2. C.F (Correction Factor) = Antenna Factor (dB)+ Cable Loss (dB) – Preamplifier(dB).
3. Measurement (dBuV/m) = Reading(dBuV) + C.F (Correction Factor).
4. The emission levels of other frequencies are very lower than the limit and not show in test report.

EUT	Gaming Mouse	Date of Test	2022-09-29
Factor	BBHA 9120D & BBHA 9170	Temp. / Humidity	24°C /68%
Polarity	Vertical	Site / Test Engineer	AC1 / Kaunaz
Test Mode	BLE_TX_1Mbps_CH 0	Test Voltage	By Battery

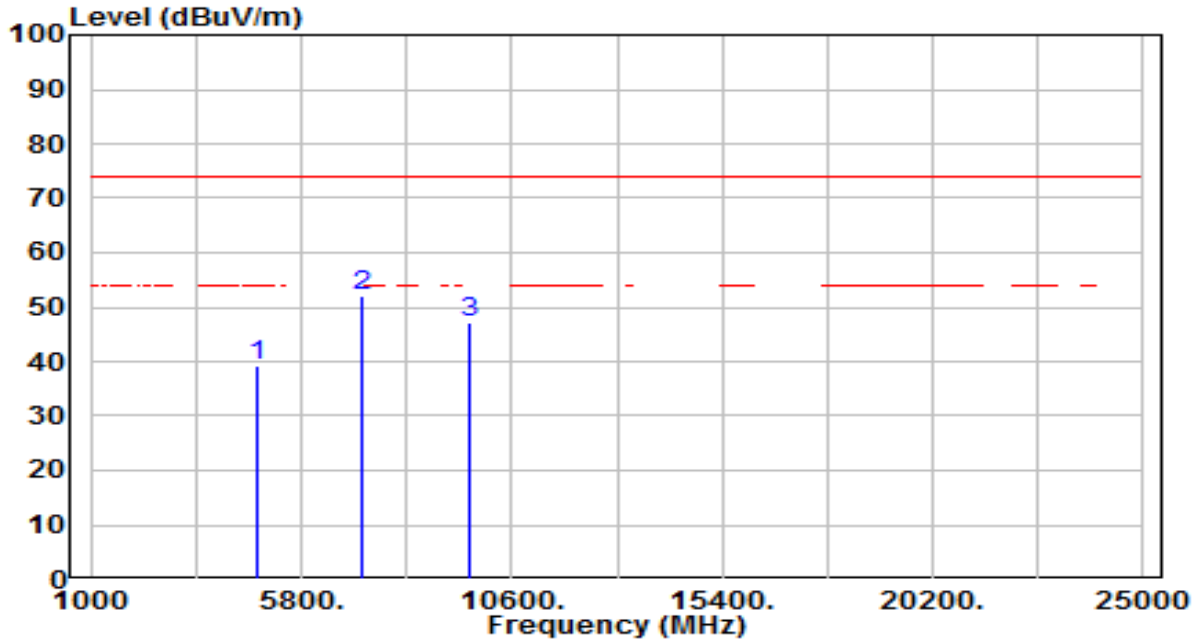

No	Frequency (MHz)	Reading (dBuV)	C.F (dB/m)	Measurement (dBuV/m)	Margin (dB)	Limit (dBuV/m)	Height (cm)	Angle (deg)	Remark (QP/PK/AV)
1	4804.000	35.67	3.61	39.28	-34.72	74.00	150	360	Peak
2	* 7206.000	40.43	11.68	52.11	-21.89	74.00	150	360	Peak
3	9608.000	31.57	15.69	47.26	-26.74	74.00	150	360	Peak

Note:

1. " *" , means this data is the worst emission level.
2. C.F (Correction Factor) = Antenna Factor (dB)+ Cable Loss (dB) – Preamplifier(dB).
3. Measurement (dBuV/m) = Reading(dBuV) + C.F (Correction Factor).
4. The emission levels of other frequencies are very lower than the limit and not show in test report.

EUT	Gaming Mouse	Date of Test	2022-09-29
Factor	BBHA 9120D & BBHA 9170	Temp. / Humidity	24°C /68%
Polarity	Horizontal	Site / Test Engineer	AC1 / Kaunaz
Test Mode	BLE_TX_1Mbps_CH 19	Test Voltage	By Battery

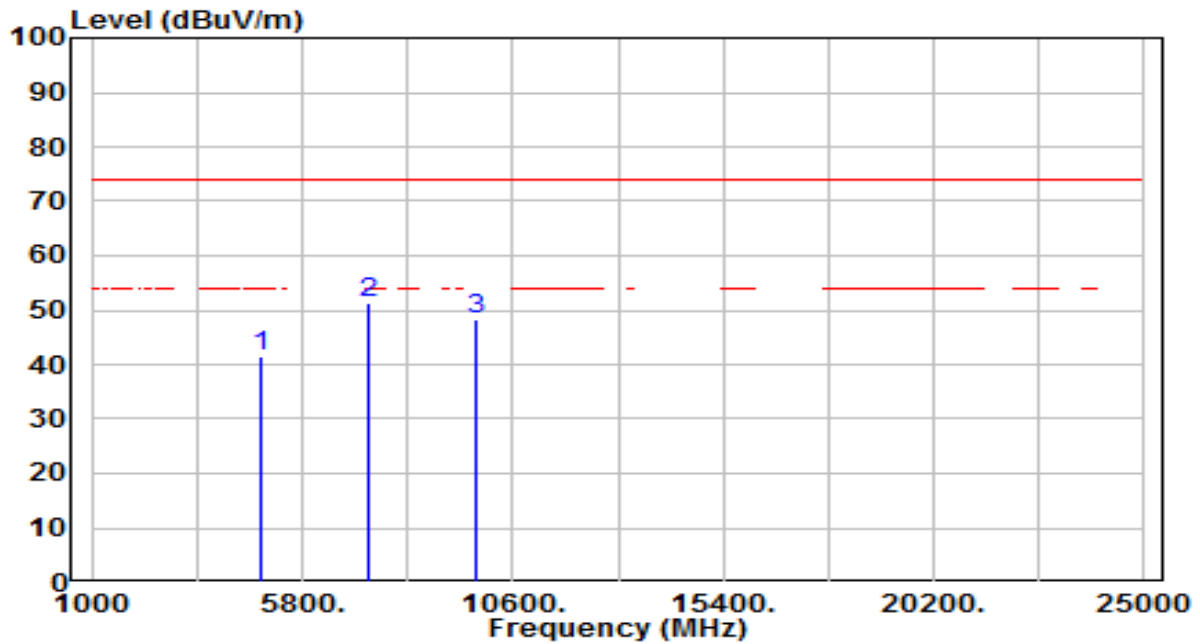

No	Frequency (MHz)	Reading (dBuV)	C.F (dB/m)	Measurement (dBuV/m)	Margin (dB)	Limit (dBuV/m)	Height (cm)	Angle (deg)	Remark (QP/PK/AV)
1	4880.000	37.89	3.75	41.64	-32.36	74.00	150	360	Peak
2	* 7320.000	39.25	12.15	51.40	-22.60	74.00	150	360	Peak
3	9760.000	32.48	15.97	48.45	-25.55	74.00	150	360	Peak

Note:

1. " *", means this data is the worst emission level.
2. C.F (Correction Factor) = Antenna Factor (dB)+ Cable Loss (dB) – Preamplifier(dB).
3. Measurement (dBuV/m) = Reading(dBuV) + C.F (Correction Factor).
4. The emission levels of other frequencies are very lower than the limit and not show in test report.

EUT	Gaming Mouse	Date of Test	2022-09-29
Factor	BBHA 9120D & BBHA 9170	Temp. / Humidity	24°C /68%
Polarity	Vertical	Site / Test Engineer	AC1 / Kaunaz
Test Mode	BLE_TX_1Mbps_CH 19	Test Voltage	By Battery

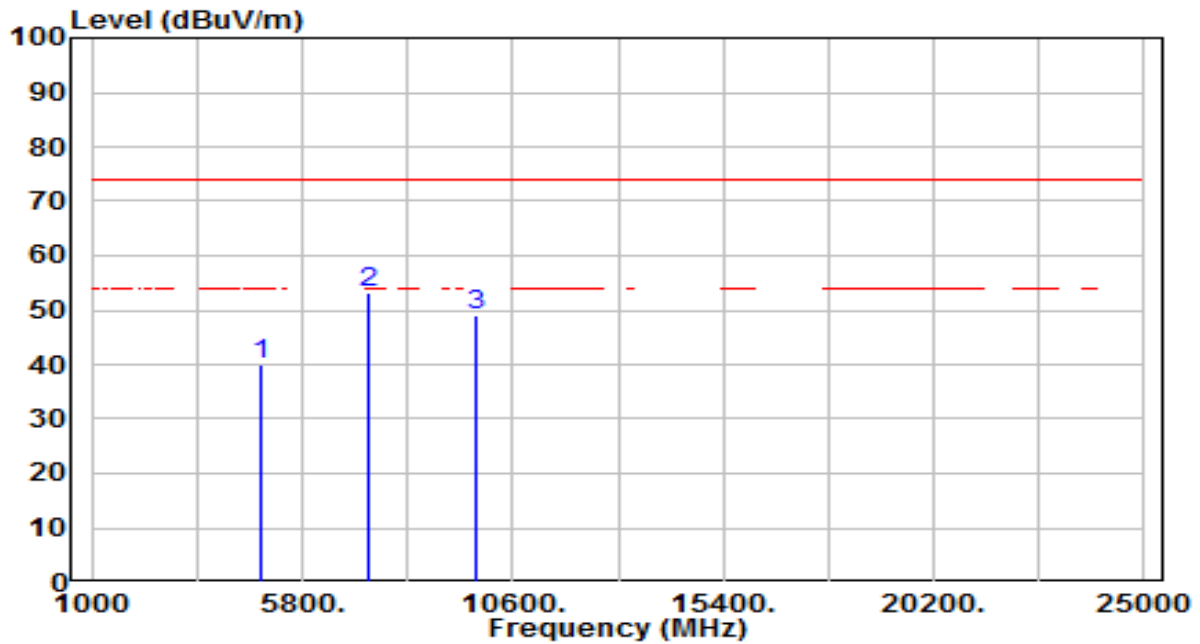

No	Frequency (MHz)	Reading (dBuV)	C.F (dB/m)	Measurement (dBuV/m)	Margin (dB)	Limit (dBuV/m)	Height (cm)	Angle (deg)	Remark (QP/PK/AV)
1	4880.000	36.36	3.75	40.10	-33.90	74.00	150	360	Peak
2	* 7320.000	40.96	12.15	53.11	-20.89	74.00	150	360	Peak
3	9760.000	33.20	15.97	49.17	-24.83	74.00	150	360	Peak

Note:

1. " *", means this data is the worst emission level.
2. C.F (Correction Factor) = Antenna Factor (dB)+ Cable Loss (dB) – Preamplifier(dB).
3. Measurement (dBuV/m) = Reading(dBuV) + C.F (Correction Factor).
4. The emission levels of other frequencies are very lower than the limit and not show in test report.

EUT	Gaming Mouse	Date of Test	2022-09-29
Factor	BBHA 9120D & BBHA 9170	Temp. / Humidity	24°C /68%
Polarity	Horizontal	Site / Test Engineer	AC1 / Kaunaz
Test Mode	BLE_TX_1Mbps_CH 39	Test Voltage	By Battery

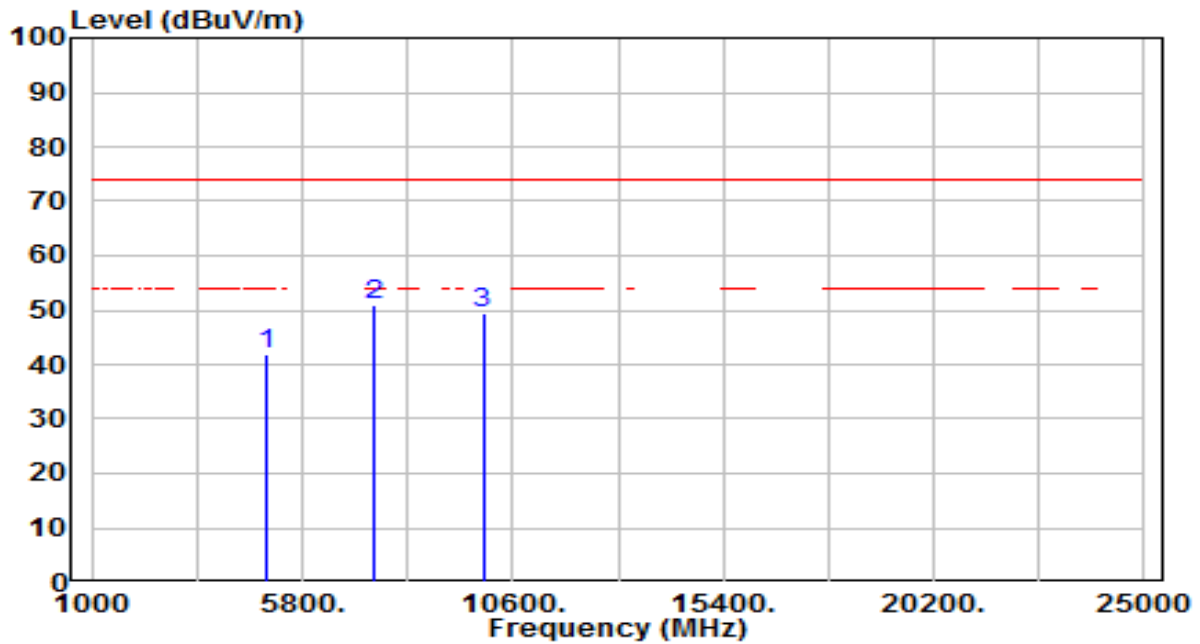

No	Frequency (MHz)	Reading (dBuV)	C.F (dB/m)	Measurement (dBuV/m)	Margin (dB)	Limit (dBuV/m)	Height (cm)	Angle (deg)	Remark (QP/PK/AV)
1	4960.000	37.88	3.90	41.78	-32.22	74.00	150	360	Peak
2	* 7440.000	38.33	12.65	50.98	-23.02	74.00	150	360	Peak
3	9920.000	33.28	16.27	49.55	-24.45	74.00	150	360	Peak

Note:

1. " *", means this data is the worst emission level.
2. C.F (Correction Factor) = Antenna Factor (dB)+ Cable Loss (dB) – Preamplifier(dB).
3. Measurement (dBuV/m) = Reading(dBuV) + C.F (Correction Factor).
4. The emission levels of other frequencies are very lower than the limit and not show in test report.

EUT	Gaming Mouse	Date of Test	2022-09-29
Factor	BBHA 9120D & BBHA 9170	Temp. / Humidity	24°C /68%
Polarity	Vertical	Site / Test Engineer	AC1 / Kaunaz
Test Mode	BLE_TX_1Mbps_CH 39	Test Voltage	By Battery

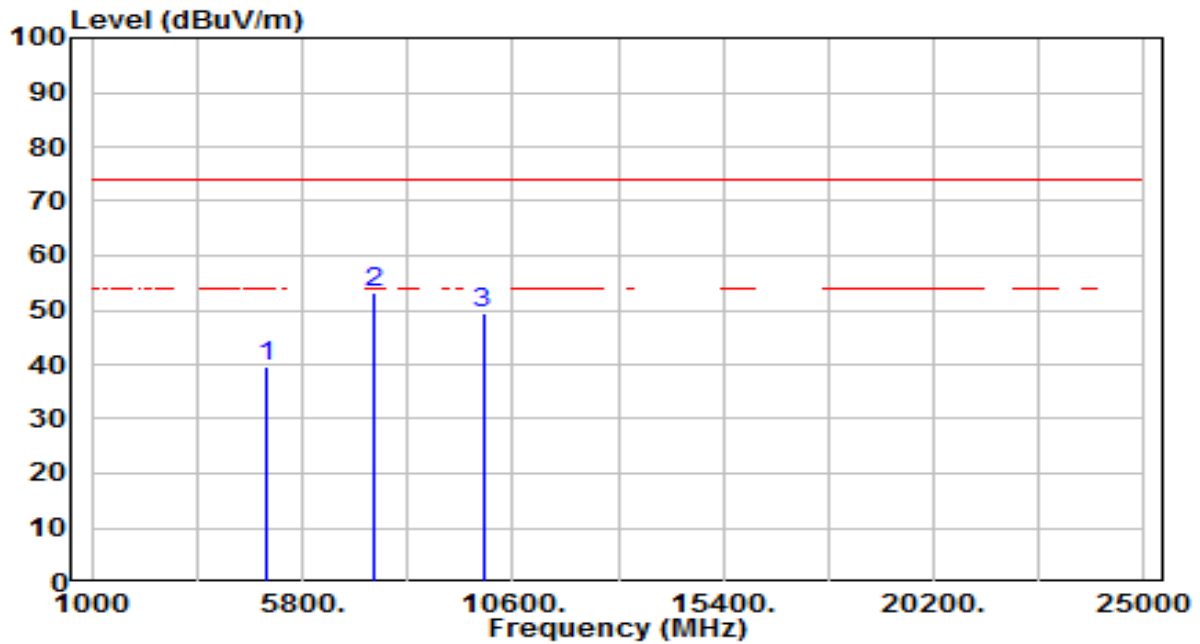

No	Frequency (MHz)	Reading (dBuV)	C.F (dB/m)	Measurement (dBuV/m)	Margin (dB)	Limit (dBuV/m)	Height (cm)	Angle (deg)	Remark (QP/PK/AV)
1	4960.000	35.58	3.90	39.47	-34.53	74.00	150	360	Peak
2	* 7440.000	40.63	12.65	53.27	-20.73	74.00	150	360	Peak
3	9920.000	33.03	16.27	49.30	-24.70	74.00	150	360	Peak

Note:

1. " *", means this data is the worst emission level.
2. C.F (Correction Factor) = Antenna Factor (dB)+ Cable Loss (dB) – Preamplifier(dB).
3. Measurement (dBuV/m) = Reading(dBuV) + C.F (Correction Factor).
4. The emission levels of other frequencies are very lower than the limit and not show in test report.

EUT	Gaming Mouse	Date of Test	2022-09-29
Factor	BBHA 9120D & BBHA 9170	Temp. / Humidity	24°C /68%
Polarity	Horizontal	Site / Test Engineer	AC1 / Kaunaz
Test Mode	BLE_TX_2Mbps_CH 0	Test Voltage	By Battery

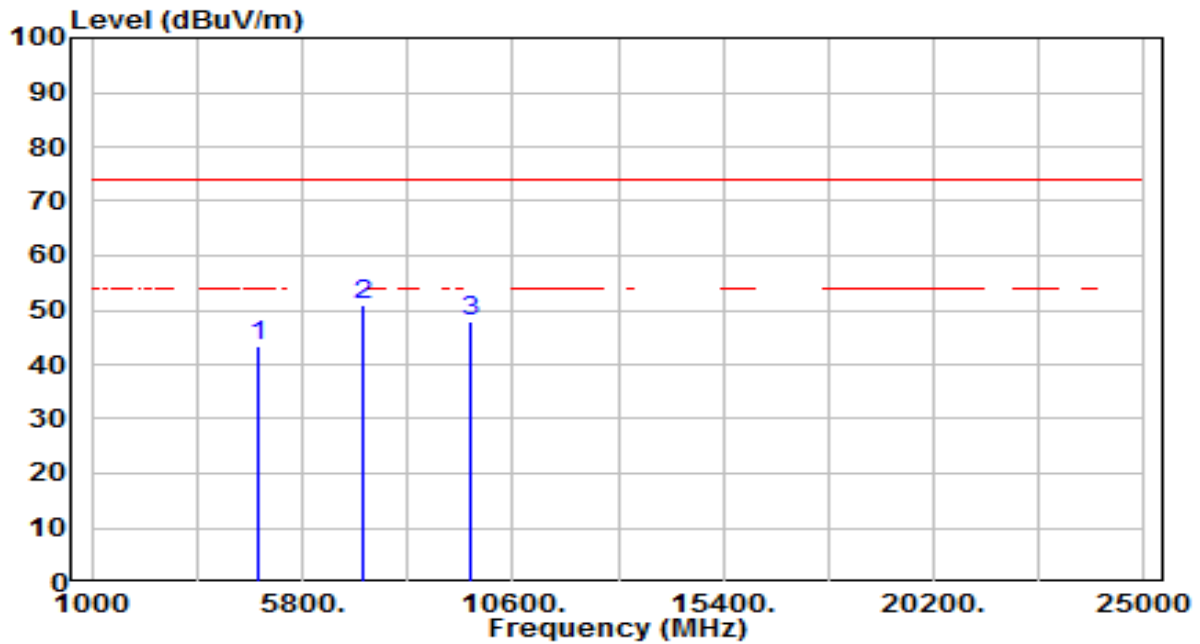

No	Frequency (MHz)	Reading (dBuV)	C.F (dB/m)	Measurement (dBuV/m)	Margin (dB)	Limit (dBuV/m)	Height (cm)	Angle (deg)	Remark (QP/PK/AV)
1	4804.000	39.76	3.61	43.37	-30.63	74.00	150	360	Peak
2	* 7206.000	39.34	11.68	51.02	-22.98	74.00	150	360	Peak
3	9608.000	32.35	15.69	48.05	-25.95	74.00	150	360	Peak

Note:

1. " *" , means this data is the worst emission level.
2. C.F (Correction Factor) = Antenna Factor (dB)+ Cable Loss (dB) – Preamplifier(dB).
3. Measurement (dBuV/m) = Reading(dBuV) + C.F (Correction Factor).
4. The emission levels of other frequencies are very lower than the limit and not show in test report.

EUT	Gaming Mouse	Date of Test	2022-09-29
Factor	BBHA 9120D & BBHA 9170	Temp. / Humidity	24°C /68%
Polarity	Vertical	Site / Test Engineer	AC1 / Kaunaz
Test Mode	BLE_TX_2Mbps_CH 0	Test Voltage	By Battery

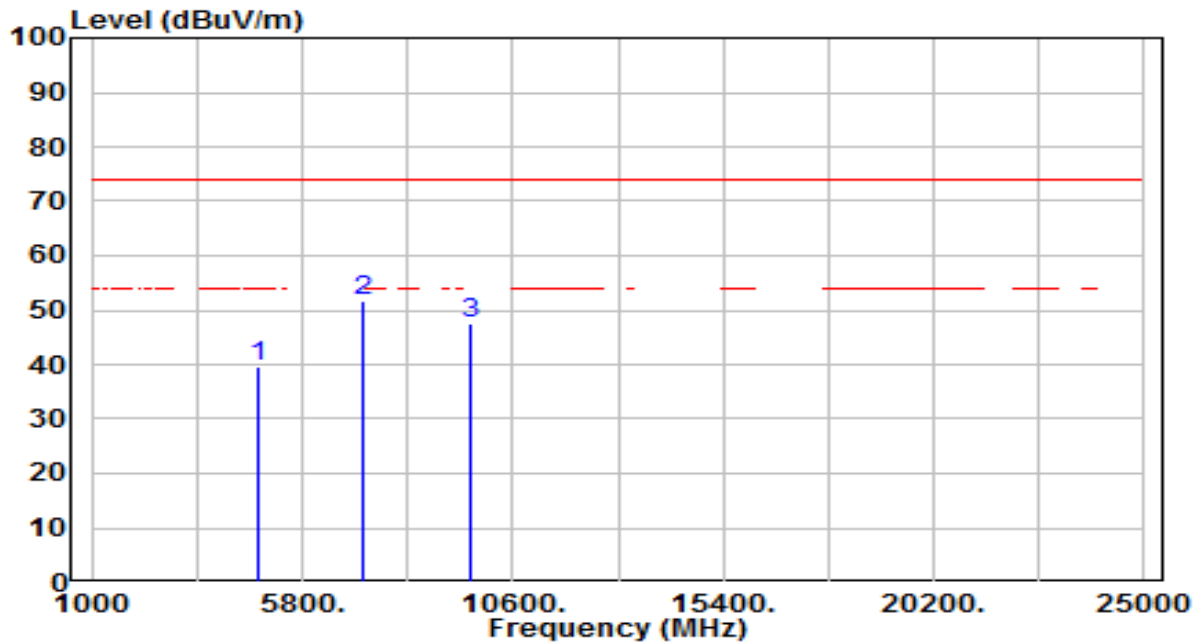

No	Frequency (MHz)	Reading (dBuV)	C.F (dB/m)	Measurement (dBuV/m)	Margin (dB)	Limit (dBuV/m)	Height (cm)	Angle (deg)	Remark (QP/PK/AV)
1	4804.000	36.13	3.61	39.74	-34.26	74.00	150	360	Peak
2	* 7206.000	40.09	11.68	51.77	-22.23	74.00	150	360	Peak
3	9608.000	32.02	15.69	47.71	-26.29	74.00	150	360	Peak

Note:

1. " *", means this data is the worst emission level.
2. C.F (Correction Factor) = Antenna Factor (dB)+ Cable Loss (dB) – Preamplifier(dB).
3. Measurement (dBuV/m) = Reading(dBuV) + C.F (Correction Factor).
4. The emission levels of other frequencies are very lower than the limit and not show in test report.

EUT	Gaming Mouse	Date of Test	2022-09-29
Factor	BBHA 9120D & BBHA 9170	Temp. / Humidity	24°C /68%
Polarity	Horizontal	Site / Test Engineer	AC1 / Kaunaz
Test Mode	BLE_TX_2Mbps_CH 19	Test Voltage	By Battery

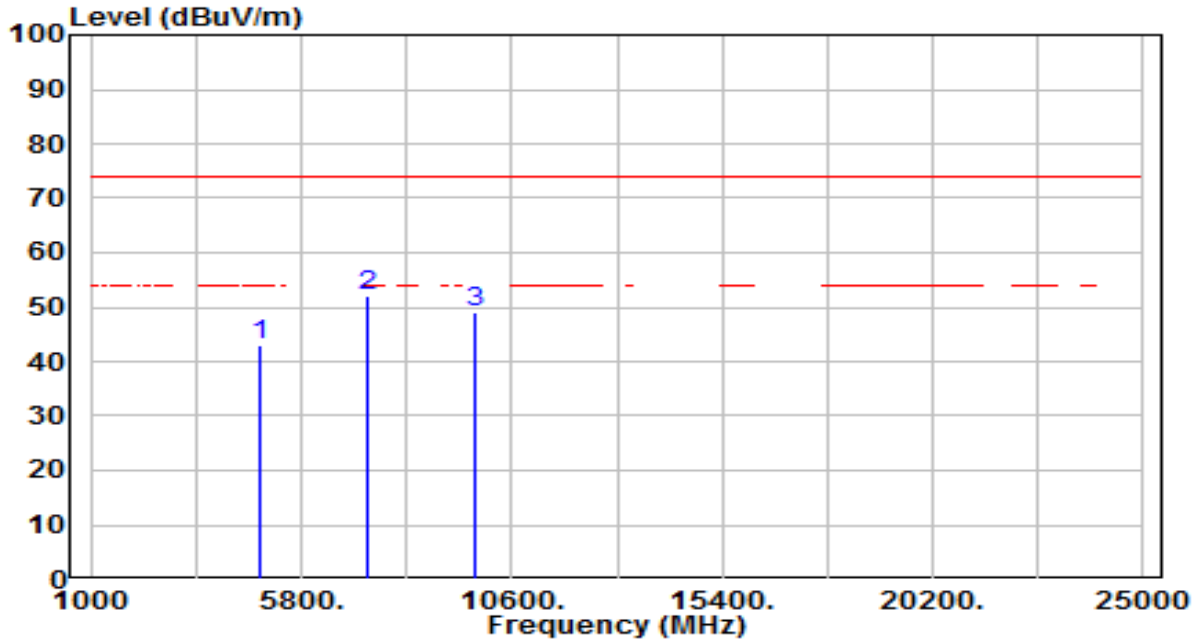

No	Frequency (MHz)	Reading (dBuV)	C.F (dB/m)	Measurement (dBuV/m)	Margin (dB)	Limit (dBuV/m)	Height (cm)	Angle (deg)	Remark (QP/PK/AV)
1	4880.000	39.31	3.75	43.06	-30.94	74.00	150	360	Peak
2	* 7320.000	39.82	12.15	51.97	-22.03	74.00	150	360	Peak
3	9760.000	32.96	15.97	48.94	-25.06	74.00	150	360	Peak

Note:

1. " *", means this data is the worst emission level.
2. C.F (Correction Factor) = Antenna Factor (dB)+ Cable Loss (dB) – Preamplifier(dB).
3. Measurement (dBuV/m) = Reading(dBuV) + C.F (Correction Factor).
4. The emission levels of other frequencies are very lower than the limit and not show in test report.

EUT	Gaming Mouse	Date of Test	2022-09-29
Factor	BBHA 9120D & BBHA 9170	Temp. / Humidity	24°C /68%
Polarity	Vertical	Site / Test Engineer	AC1 / Kaunaz
Test Mode	BLE_TX_2Mbps_CH 19	Test Voltage	By Battery

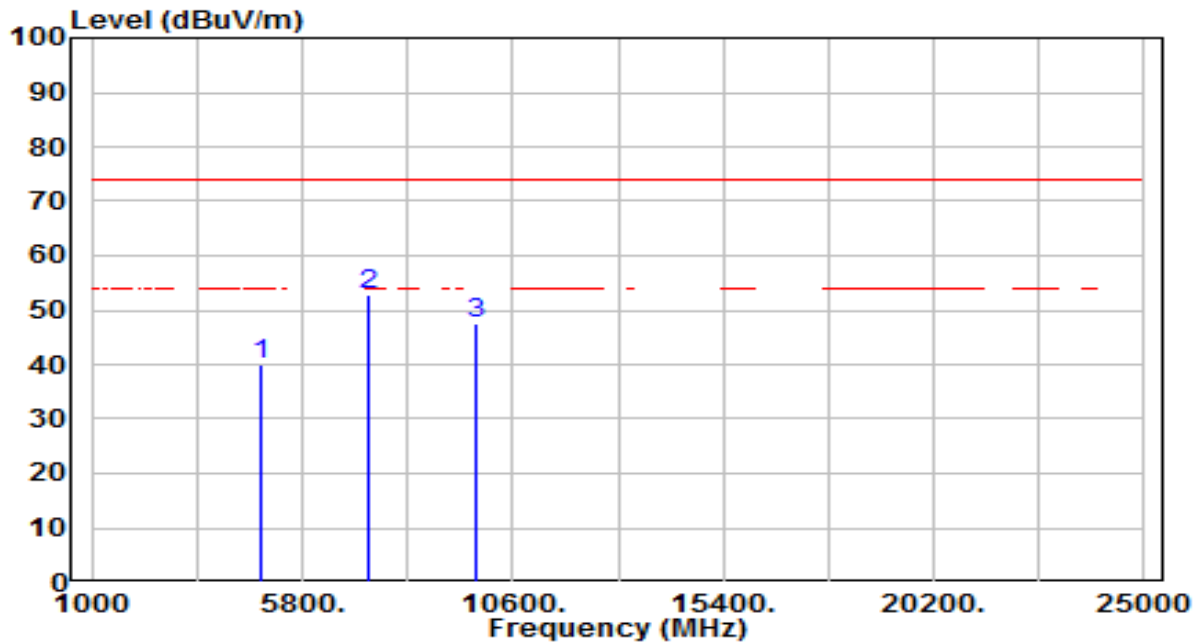

No	Frequency (MHz)	Reading (dBuV)	C.F (dB/m)	Measurement (dBuV/m)	Margin (dB)	Limit (dBuV/m)	Height (cm)	Angle (deg)	Remark (QP/PK/AV)
1	4880.000	36.19	3.75	39.94	-34.06	74.00	150	360	Peak
2	* 7320.000	40.58	12.15	52.73	-21.27	74.00	150	360	Peak
3	9760.000	31.53	15.97	47.50	-26.50	74.00	150	360	Peak

Note:

1. " *", means this data is the worst emission level.
2. C.F (Correction Factor) = Antenna Factor (dB)+ Cable Loss (dB) – Preamplifier(dB).
3. Measurement (dBuV/m) = Reading(dBuV) + C.F (Correction Factor).
4. The emission levels of other frequencies are very lower than the limit and not show in test report.

EUT	Gaming Mouse	Date of Test	2022-09-29
Factor	BBHA 9120D & BBHA 9170	Temp. / Humidity	24°C /68%
Polarity	Horizontal	Site / Test Engineer	AC1 / Kaunaz
Test Mode	BLE_TX_2Mbps_CH 39	Test Voltage	By Battery

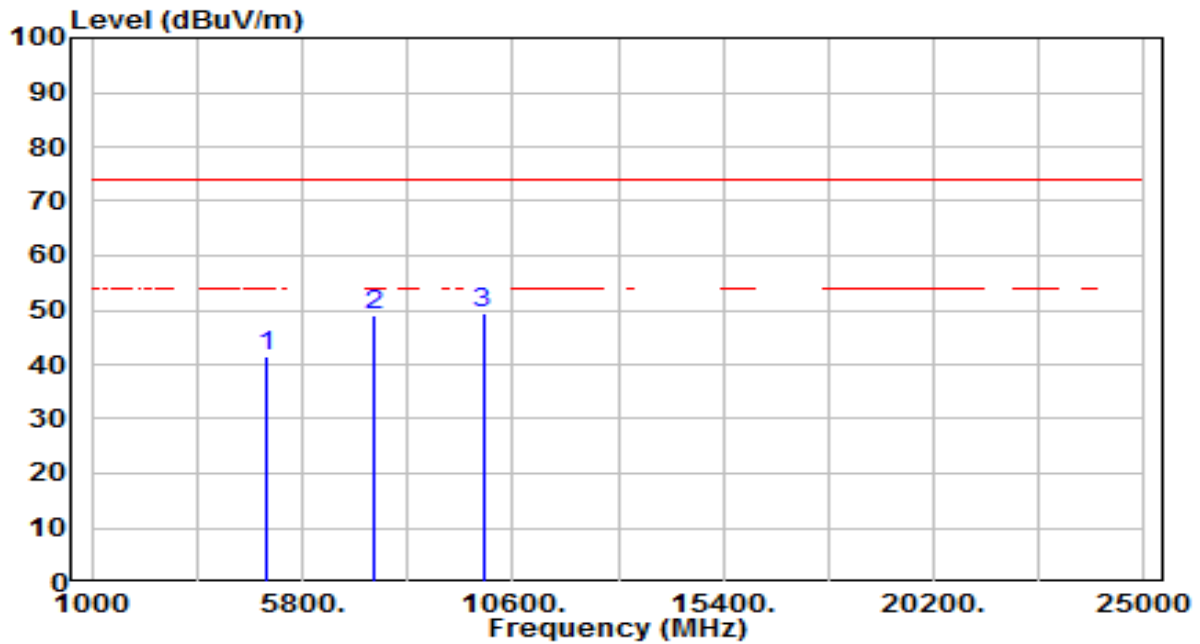

No	Frequency (MHz)	Reading (dBuV)	C.F (dB/m)	Measurement (dBuV/m)	Margin (dB)	Limit (dBuV/m)	Height (cm)	Angle (deg)	Remark (QP/PK/AV)
1	4960.000	37.58	3.90	41.48	-32.52	74.00	150	360	Peak
2	7440.000	36.45	12.65	49.10	-24.90	74.00	150	360	Peak
3	* 9920.000	33.11	16.27	49.38	-24.62	74.00	150	360	Peak

Note:

1. " *", means this data is the worst emission level.
2. C.F (Correction Factor) = Antenna Factor (dB)+ Cable Loss (dB) – Preamplifier(dB).
3. Measurement (dBuV/m) = Reading(dBuV) + C.F (Correction Factor).
4. The emission levels of other frequencies are very lower than the limit and not show in test report.

EUT	Gaming Mouse	Date of Test	2022-09-29
Factor	BBHA 9120D & BBHA 9170	Temp. / Humidity	24°C /68%
Polarity	Vertical	Site / Test Engineer	AC1 / Kaunaz
Test Mode	BLE_TX_2Mbps_CH 39	Test Voltage	By Battery

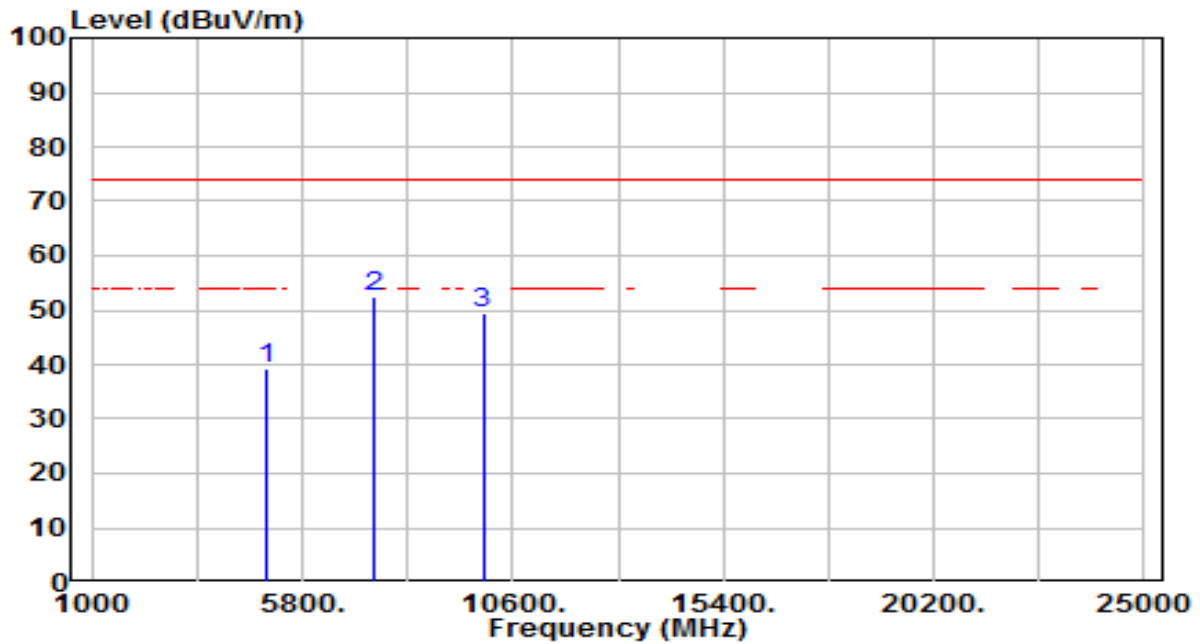

No	Frequency (MHz)	Reading (dBuV)	C.F (dB/m)	Measurement (dBuV/m)	Margin (dB)	Limit (dBuV/m)	Height (cm)	Angle (deg)	Remark (QP/PK/AV)
1	4960.000	35.19	3.90	39.08	-34.92	74.00	150	360	Peak
2	* 7440.000	39.82	12.65	52.47	-21.53	74.00	150	360	Peak
3	9920.000	33.14	16.27	49.41	-24.59	74.00	150	360	Peak

Note:

1. " *", means this data is the worst emission level.
2. C.F (Correction Factor) = Antenna Factor (dB)+ Cable Loss (dB) – Preamplifier(dB).
3. Measurement (dBuV/m) = Reading(dBuV) + C.F (Correction Factor).
4. The emission levels of other frequencies are very lower than the limit and not show in test report.

7.7. Radiated Restricted Band Edge Measurement

7.7.1. Test Limit

All out of band emissions appearing in a restricted band as specified in Section 15.205 of the Title 47 CFR must not exceed the limits shown in Table per Section 15.209.

FCC Part 15 Subpart C Paragraph 15.209		
Frequency [MHz]	Field Strength [V/m]	Measured Distance [Meters]
0.009 - 0.490	2400/F (kHz)	300
0.490 - 1.705	24000/F (kHz)	30
1.705 – 30	30	30
30 – 88	100	3
88 – 216	150	3
216 – 960	200	3
Above 960	500	3

7.7.2. Test Procedure Used

ANSI C63.10-2013 - Section 11.12.1

7.7.3. Test Setting

Peak Field Strength Measurements

1. Analyzer center frequency was set to the frequency of the radiated spurious emission of interest
2. RBW = as specified in Table 1
3. VBW = 3 * RBW
4. Detector = peak
5. Sweep time = auto couple
6. Trace mode = max hold
7. Trace was allowed to stabilize

Table 1 - RBW as a function of frequency

Frequency	RBW
9 ~ 150 kHz	200 ~ 300 Hz
0.15 ~ 30 MHz	9 ~ 10 kHz
30 ~ 1000 MHz	100 ~ 120 kHz
> 1000 MHz	1 MHz

Average Field Strength Measurements

1. Analyzer center frequency was set to the frequency of the radiated spurious emission of interest
2. RBW = 1MHz
3. VBW $\geq 1/T$
4. De As an alternative, the instrument may be set to linear detector mode. Ensure that video filtering is applied in linear voltage domain (rather than in a log or dB domain). Some instruments require linear display mode in order to accomplish this. Others have a setting for Average-VBW Type, which can be set to "Voltage" regardless of the display mode
5. Detector = Peak
6. Sweep time = auto
7. Trace mode = max hold
8. Allow max hold to run for at least 50 times (1/duty cycle) traces

7.7.4. Test Setup

1GHz ~ 18GHz Test Setup:

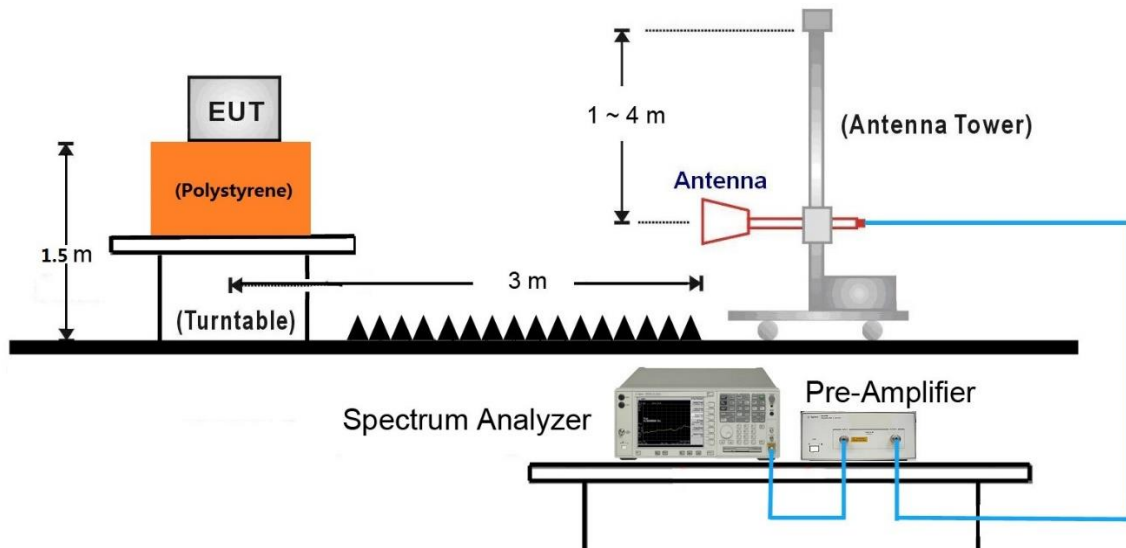

7.7.5. Test Result

EUT	Gaming Mouse	Date of Test	2022-09-29
Factor	BBHA 9120D	Temp. / Humidity	24°C /68%
Polarity	Horizontal	Site / Test Engineer	AC1 / Kaunaz
Test Mode	BLE_TX_1Mbps_CH 0	Test Voltage	By Battery

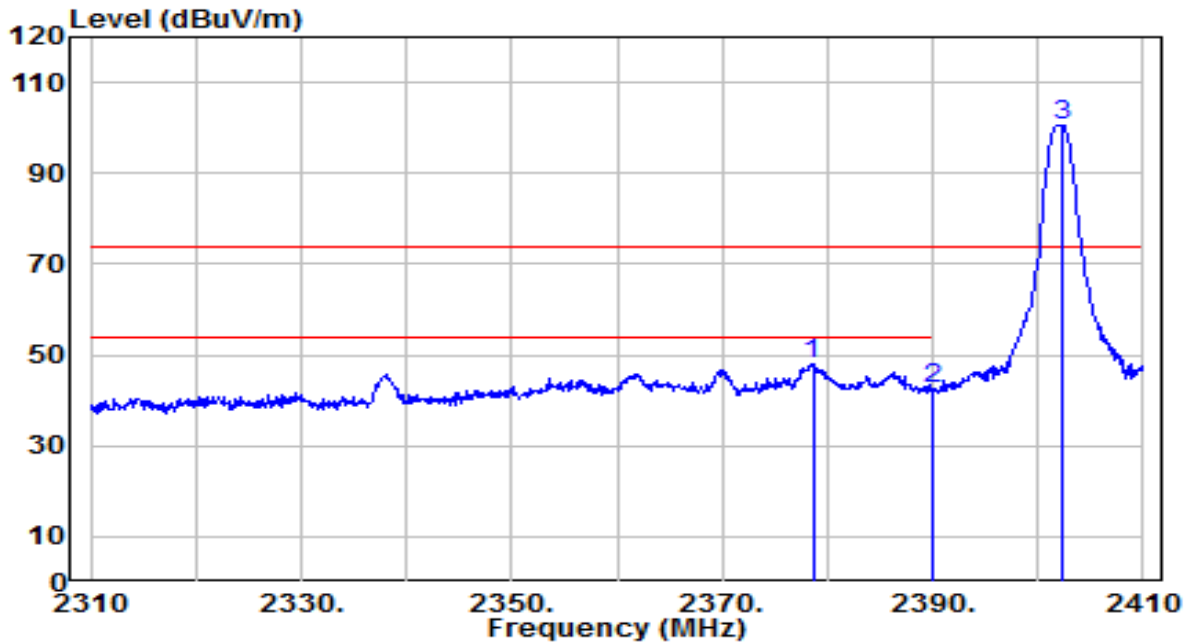

No	Frequency (MHz)	Reading (dBuV)	C.F (dB/m)	Measurement (dBuV/m)	Margin (dB)	Limit (dBuV/m)	Height (cm)	Angle (deg)	Remark (QP/PK/AV)
1	* 2378.600	50.08	-2.07	48.01	-25.99	74.00	105	20	Peak
2	2390.000	44.75	-2.04	42.72	-31.28	74.00	105	20	Peak
3	2402.300	102.53	-2.00	100.53	N/A	N/A	105	20	Peak

Note:

1. " *", means this data is the worst emission level.
2. C.F (Correction Factor) = Antenna Factor (dB)+ Cable Loss (dB) – Preamplifier(dB).
3. Measurement (dBuV/m) = Reading(dBuV) + C.F (Correction Factor).
4. The emission levels of other frequencies are very lower than the limit and not show in test report.

EUT	Gaming Mouse	Date of Test	2022-09-29
Factor	BBHA 9120D	Temp. / Humidity	24°C /68%
Polarity	Vertical	Site / Test Engineer	AC1 / Kaunaz
Test Mode	BLE_TX_1Mbps_CH 0	Test Voltage	By Battery

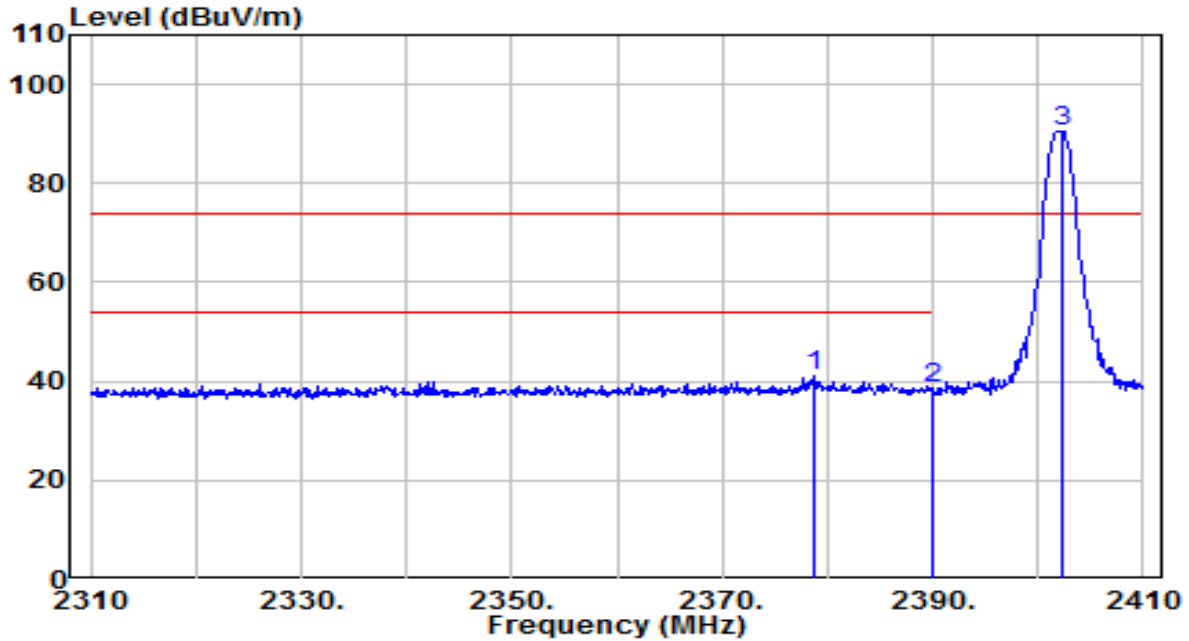

No	Frequency (MHz)	Reading (dBuV)	C.F (dB/m)	Measurement (dBuV/m)	Margin (dB)	Limit (dBuV/m)	Height (cm)	Angle (deg)	Remark (QP/PK/AV)
1	* 2378.700	43.11	-2.07	41.04	-32.96	74.00	155	285	Peak
2	2390.000	40.56	-2.04	38.52	-35.48	74.00	155	285	Peak
3	2402.300	92.47	-2.00	90.47	N/A	N/A	155	285	Peak

Note:

1. " *", means this data is the worst emission level.
2. C.F (Correction Factor) = Antenna Factor (dB)+ Cable Loss (dB) – Preamplifier(dB).
3. Measurement (dBuV/m) = Reading(dBuV) + C.F (Correction Factor).
4. The emission levels of other frequencies are very lower than the limit and not show in test report.

EUT	Gaming Mouse	Date of Test	2022-09-29
Factor	BBHA 9120D	Temp. / Humidity	24°C /68%
Polarity	Horizontal	Site / Test Engineer	AC1 / Kaunaz
Test Mode	BLE_TX_1Mbps_CH 39	Test Voltage	By Battery

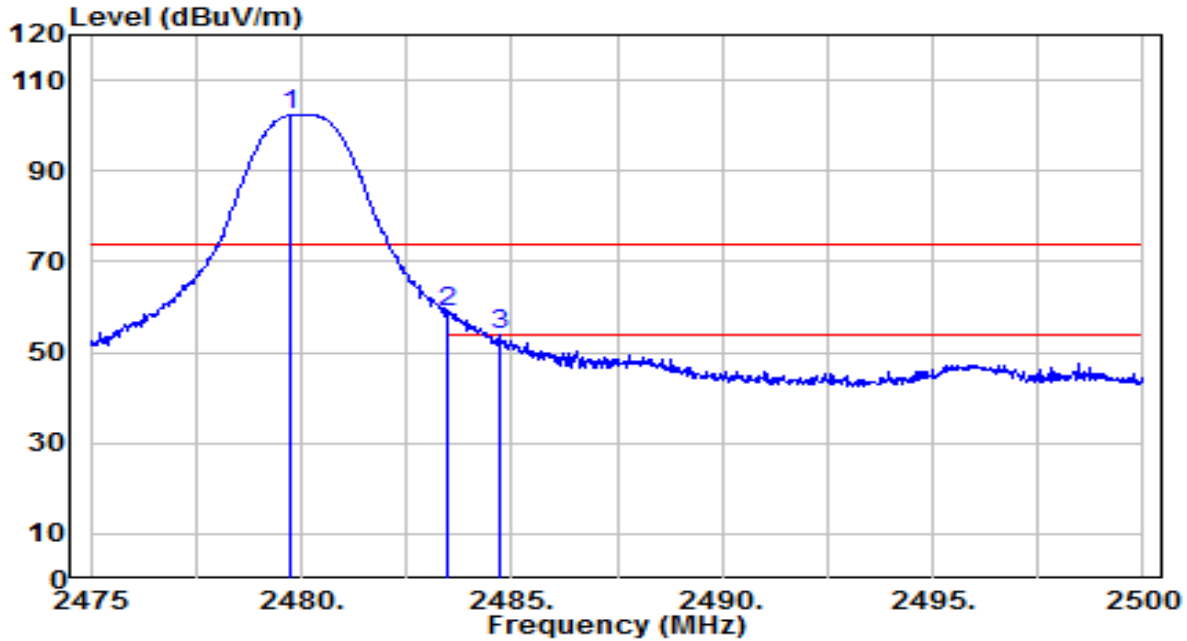

No	Frequency (MHz)	Reading (dBuV)	C.F (dB/m)	Measurement (dBuV/m)	Margin (dB)	Limit (dBuV/m)	Height (cm)	Angle (deg)	Remark (QP/PK/AV)
1	2479.750	103.99	-1.75	102.24	N/A	N/A	100	35	Peak
2	* 2483.500	60.53	-1.74	58.79	-15.21	74.00	100	35	Peak
3	2484.725	55.40	-1.74	53.66	-20.34	74.00	100	35	Peak

Note:

1. " *", means this data is the worst emission level.
2. C.F (Correction Factor) = Antenna Factor (dB)+ Cable Loss (dB) – Preamplifier(dB).
3. Measurement (dBuV/m) = Reading(dBuV) + C.F (Correction Factor).
4. The emission levels of other frequencies are very lower than the limit and not show in test report.

EUT	Gaming Mouse	Date of Test	2022-09-29
Factor	BBHA 9120D	Temp. / Humidity	24°C /68%
Polarity	Horizontal	Site / Test Engineer	AC1 / Kaunaz
Test Mode	BLE_TX_1Mbps_CH 39	Test Voltage	By Battery

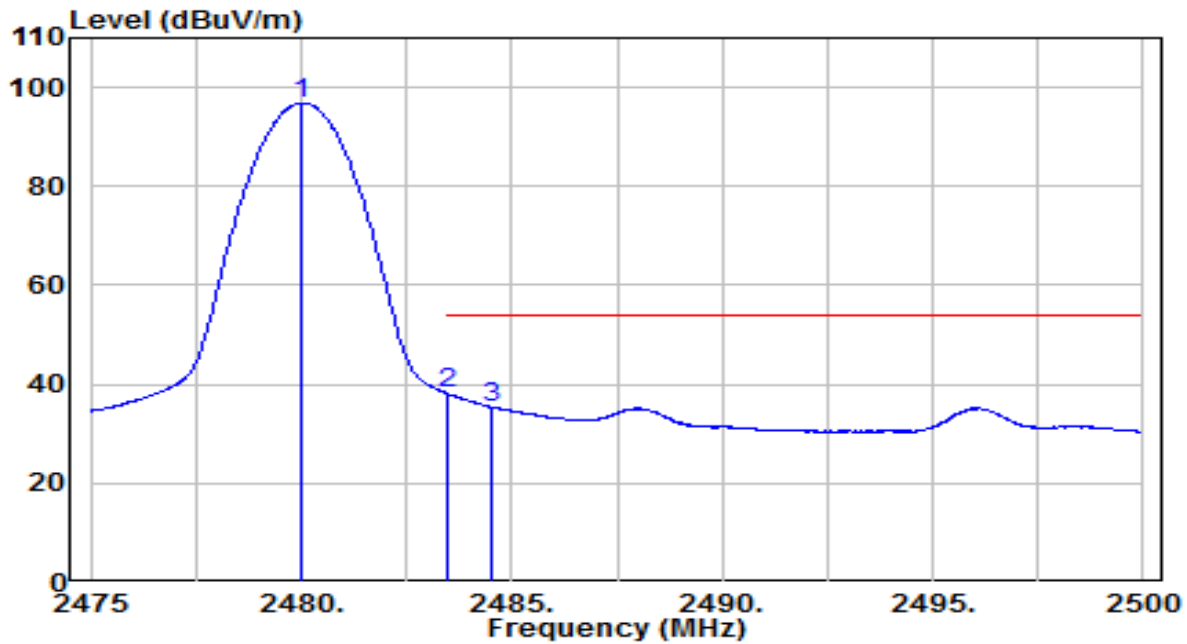

No	Frequency (MHz)	Reading (dBuV)	C.F (dB/m)	Measurement (dBuV/m)	Margin (dB)	Limit (dBuV/m)	Height (cm)	Angle (deg)	Remark (QP/PK/AV)
1	2480.000	98.68	-1.75	96.92	N/A	N/A	100	35	Average
2	* 2483.500	39.85	-1.74	38.11	-15.89	54.00	100	35	Average
3	2484.500	37.23	-1.74	35.49	-18.51	54.00	100	35	Average

Note:

1. " *", means this data is the worst emission level.
2. C.F (Correction Factor) = Antenna Factor (dB)+ Cable Loss (dB) – Preamplifier(dB).
3. Measurement (dBuV/m) = Reading(dBuV) + C.F (Correction Factor).
4. The emission levels of other frequencies are very lower than the limit and not show in test report.

EUT	Gaming Mouse	Date of Test	2022-09-29
Factor	BBHA 9120D	Temp. / Humidity	24°C /68%
Polarity	Vertical	Site / Test Engineer	AC1 / Kaunaz
Test Mode	BLE_TX_1Mbps_CH 39	Test Voltage	By Battery

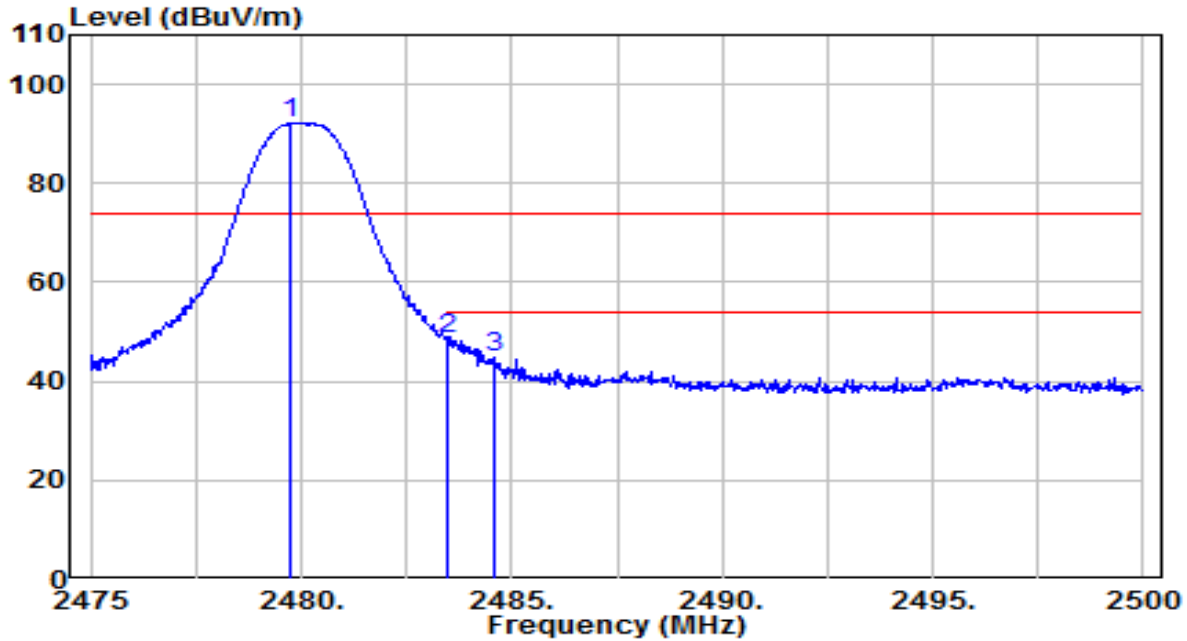

No	Frequency (MHz)	Reading (dBuV)	C.F (dB/m)	Measurement (dBuV/m)	Margin (dB)	Limit (dBuV/m)	Height (cm)	Angle (deg)	Remark (QP/PK/AV)
1	2479.750	93.80	-1.75	92.04	N/A	N/A	170	286	Peak
2	* 2483.500	50.16	-1.74	48.42	-25.58	74.00	170	286	Peak
3	2484.575	46.60	-1.74	44.86	-29.14	74.00	170	286	Peak

Note:

1. " *", means this data is the worst emission level.
2. C.F (Correction Factor) = Antenna Factor (dB)+ Cable Loss (dB) – Preamplifier(dB).
3. Measurement (dBuV/m) = Reading(dBuV) + C.F (Correction Factor).
4. The emission levels of other frequencies are very lower than the limit and not show in test report.

EUT	Gaming Mouse	Date of Test	2022-09-29
Factor	BBBHA 9120D	Temp. / Humidity	24°C /68%
Polarity	Horizontal	Site / Test Engineer	AC1 / Kaunaz
Test Mode	BLE_TX_2Mbps_CH 0	Test Voltage	By Battery

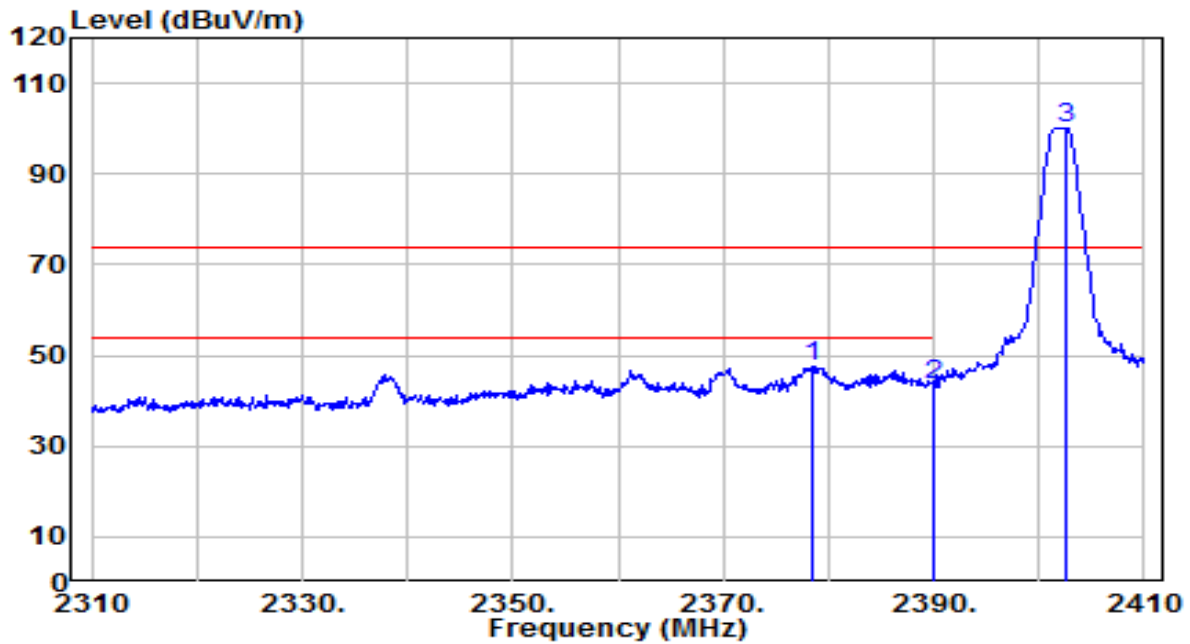

No	Frequency (MHz)	Reading (dBuV)	C.F (dB/m)	Measurement (dBuV/m)	Margin (dB)	Limit (dBuV/m)	Height (cm)	Angle (deg)	Remark (QP/PK/AV)
1	* 2378.400	49.57	-2.07	47.50	-26.50	74.00	105	20	Peak
2	2390.000	45.56	-2.04	43.53	-30.47	74.00	105	20	Peak
3	2402.600	102.25	-2.00	100.25	N/A	N/A	105	20	Peak

Note:

1. " *", means this data is the worst emission level.
2. C.F (Correction Factor) = Antenna Factor (dB)+ Cable Loss (dB) – Preamplifier(dB).
3. Measurement (dBuV/m) = Reading(dBuV) + C.F (Correction Factor).
4. The emission levels of other frequencies are very lower than the limit and not show in test report.

EUT	Gaming Mouse	Date of Test	2022-09-29
Factor	BBBHA 9120D	Temp. / Humidity	24°C /68%
Polarity	Vertical	Site / Test Engineer	AC1 / Kaunaz
Test Mode	BLE_TX_2Mbps_CH 0	Test Voltage	By Battery

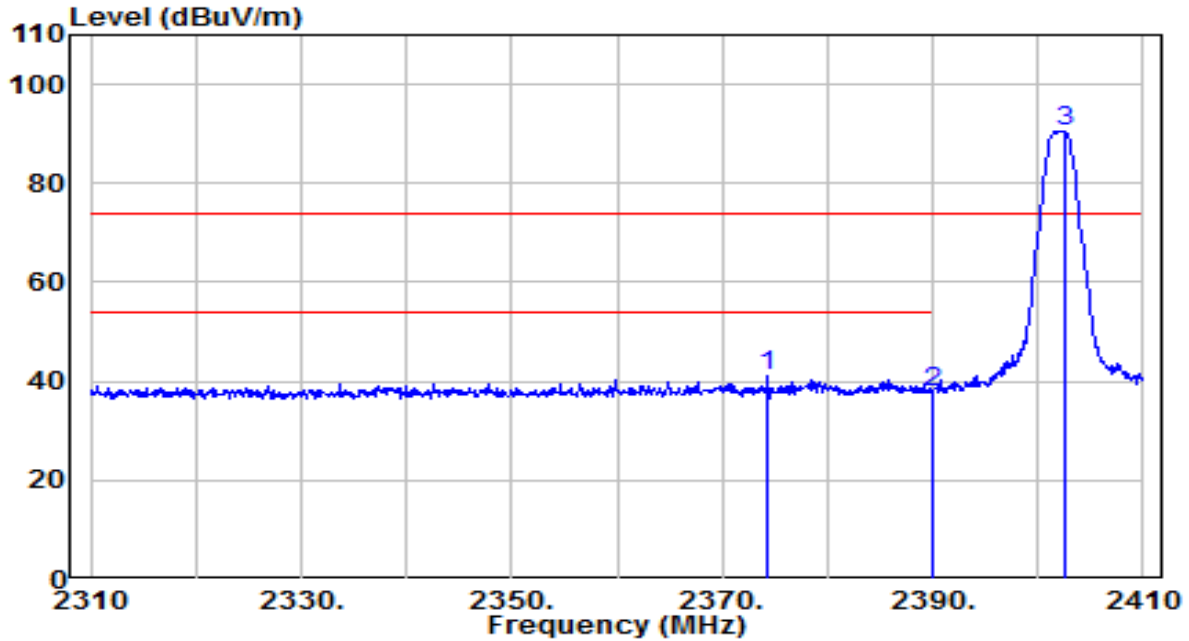

No	Frequency (MHz)	Reading (dBuV)	C.F (dB/m)	Measurement (dBuV/m)	Margin (dB)	Limit (dBuV/m)	Height (cm)	Angle (deg)	Remark (QP/PK/AV)
1	* 2374.400	43.00	-2.09	40.91	-33.09	74.00	155	285	Peak
2	2390.000	39.71	-2.04	37.67	-36.33	74.00	155	285	Peak
3	2402.600	92.48	-2.00	90.48	N/A	N/A	155	285	Peak

Note:

1. " *", means this data is the worst emission level.
2. C.F (Correction Factor) = Antenna Factor (dB)+ Cable Loss (dB) – Preamplifier(dB).
3. Measurement (dBuV/m) = Reading(dBuV) + C.F (Correction Factor).
4. The emission levels of other frequencies are very lower than the limit and not show in test report.

EUT	Gaming Mouse	Date of Test	2022-09-29
Factor	BBBHA 9120D	Temp. / Humidity	24°C /68%
Polarity	Horizontal	Site / Test Engineer	AC1 / Kaunaz
Test Mode	BLE_TX_2Mbps_CH 39	Test Voltage	By Battery

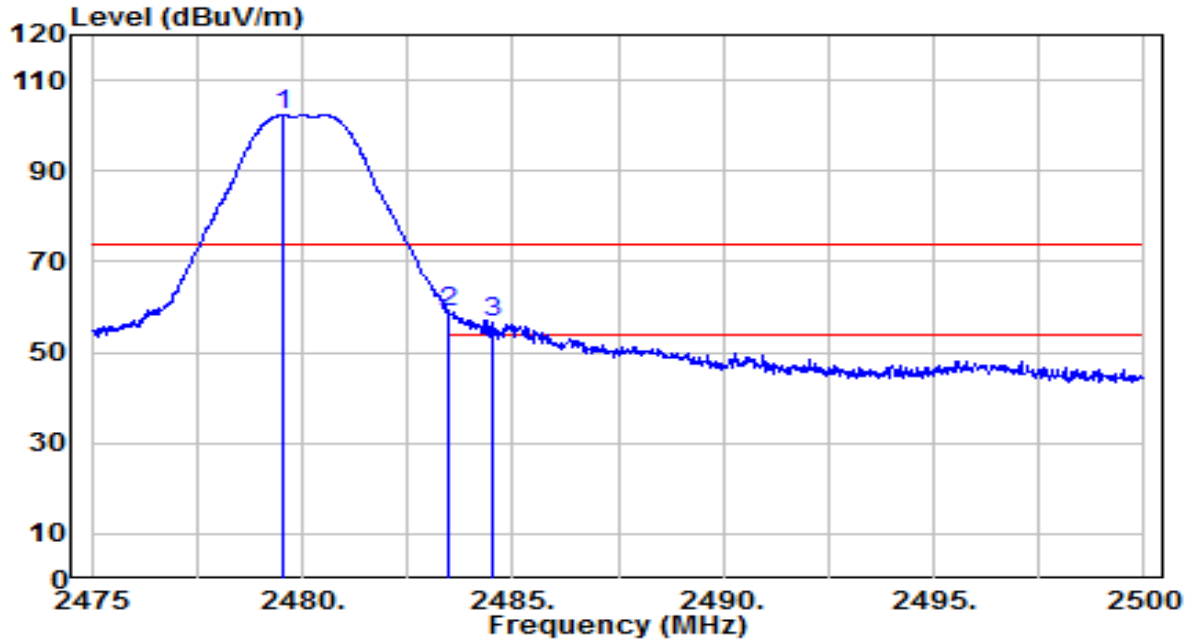

No	Frequency (MHz)	Reading (dBuV)	C.F (dB/m)	Measurement (dBuV/m)	Margin (dB)	Limit (dBuV/m)	Height (cm)	Angle (deg)	Remark (QP/PK/AV)
1	2479.525	103.95	-1.75	102.19	N/A	N/A	100	35	Peak
2	* 2483.500	60.76	-1.74	59.02	-14.98	74.00	100	35	Peak
3	2484.525	58.54	-1.74	56.80	-17.20	74.00	100	35	Peak

Note:

1. " *", means this data is the worst emission level.
2. C.F (Correction Factor) = Antenna Factor (dB)+ Cable Loss (dB) – Preamplifier(dB).
3. Measurement (dBuV/m) = Reading(dBuV) + C.F (Correction Factor).
4. The emission levels of other frequencies are very lower than the limit and not show in test report.

EUT	Gaming Mouse	Date of Test	2022-09-29
Factor	BBBHA 9120D	Temp. / Humidity	24°C /68%
Polarity	Horizontal	Site / Test Engineer	AC1 / Kaunaz
Test Mode	BLE_TX_2Mbps_CH 39	Test Voltage	By Battery

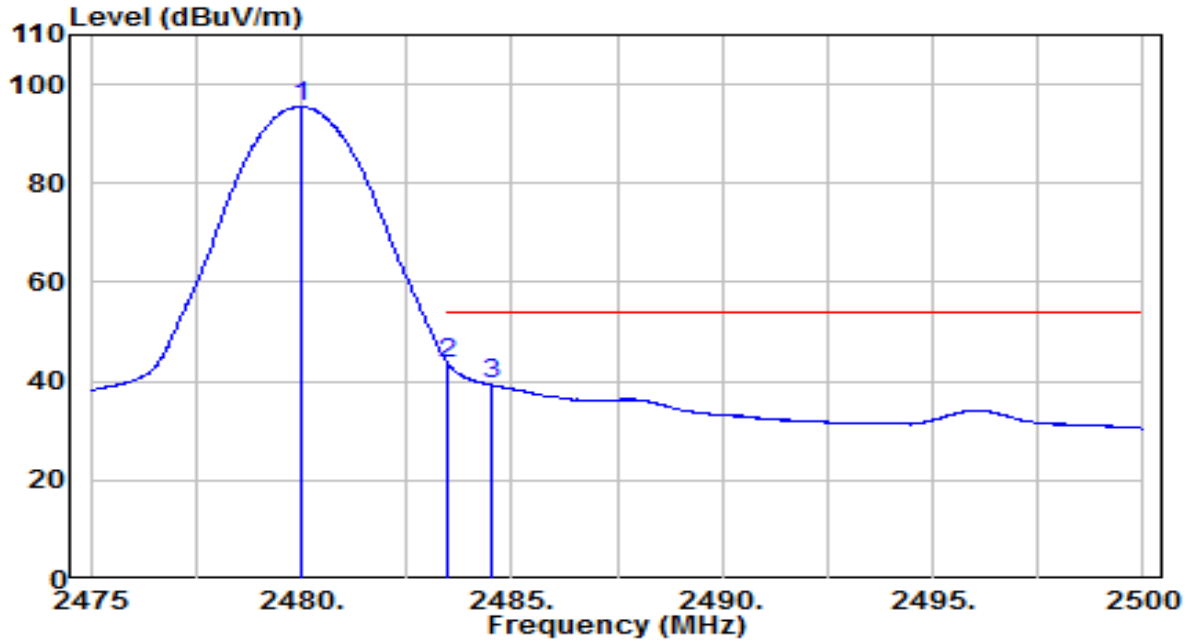

No	Frequency (MHz)	Reading (dBuV)	C.F (dB/m)	Measurement (dBuV/m)	Margin (dB)	Limit (dBuV/m)	Height (cm)	Angle (deg)	Remark (QP/PK/AV)
1	2480.000	97.33	-1.75	95.57	N/A	N/A	100	35	Average
2	* 2483.500	45.23	-1.74	43.49	-10.51	54.00	100	35	Average
3	2484.500	40.99	-1.74	39.25	-14.75	54.00	100	35	Average

Note:

1. " *", means this data is the worst emission level.
2. C.F (Correction Factor) = Antenna Factor (dB)+ Cable Loss (dB) – Preamplifier(dB).
3. Measurement (dBuV/m) = Reading(dBuV) + C.F (Correction Factor).
4. The emission levels of other frequencies are very lower than the limit and not show in test report.

EUT	Gaming Mouse	Date of Test	2022-09-29
Factor	BBBHA 9120D	Temp. / Humidity	24°C /68%
Polarity	Vertical	Site / Test Engineer	AC1 / Kaunaz
Test Mode	BLE_TX_2Mbps_CH 39	Test Voltage	By Battery

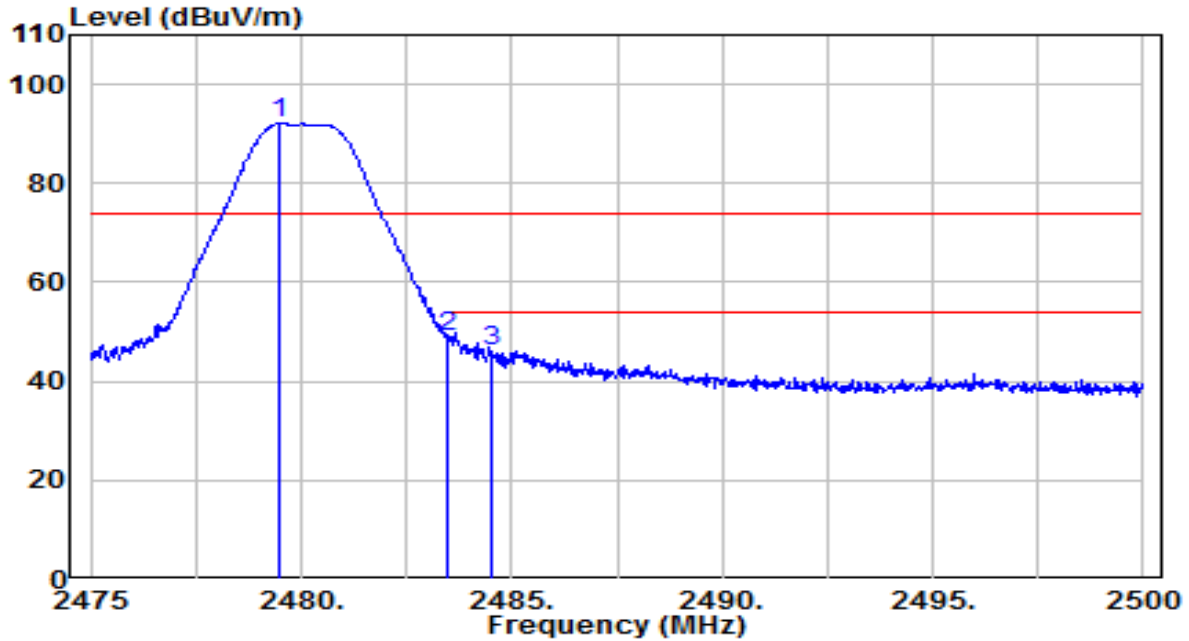

No	Frequency (MHz)	Reading (dBuV)	C.F (dB/m)	Measurement (dBuV/m)	Margin (dB)	Limit (dBuV/m)	Height (cm)	Angle (deg)	Remark (QP/PK/AV)
1	2479.500	93.79	-1.75	92.04	N/A	N/A	170	285	Peak
2	* 2483.500	50.62	-1.74	48.88	-25.12	74.00	170	285	Peak
3	2484.525	47.86	-1.74	46.12	-27.88	74.00	170	285	Peak

Note:

1. " *", means this data is the worst emission level.
2. C.F (Correction Factor) = Antenna Factor (dB)+ Cable Loss (dB) – Preamplifier(dB).
3. Measurement (dBuV/m) = Reading(dBuV) + C.F (Correction Factor).
4. The emission levels of other frequencies are very lower than the limit and not show in test report.

7.8. AC Conducted Emissions Measurement

7.8.1. Test Limit

FCC Part 15 Subpart C Paragraph 15.207 / RSS-Gen Limits		
Frequency (MHz)	QP (dB μ V)	Average (dB μ V)
0.15 - 0.50	66 - 56	56 - 46
0.50 - 5.0	56	46
5.0 - 30	60	50

Note 1: The lower limit shall apply at the transition frequencies.

Note 2: The limit decreases linearly with the logarithm of the frequency in the range 0.15MHz to 0.5MHz.

7.8.2. Test Setup

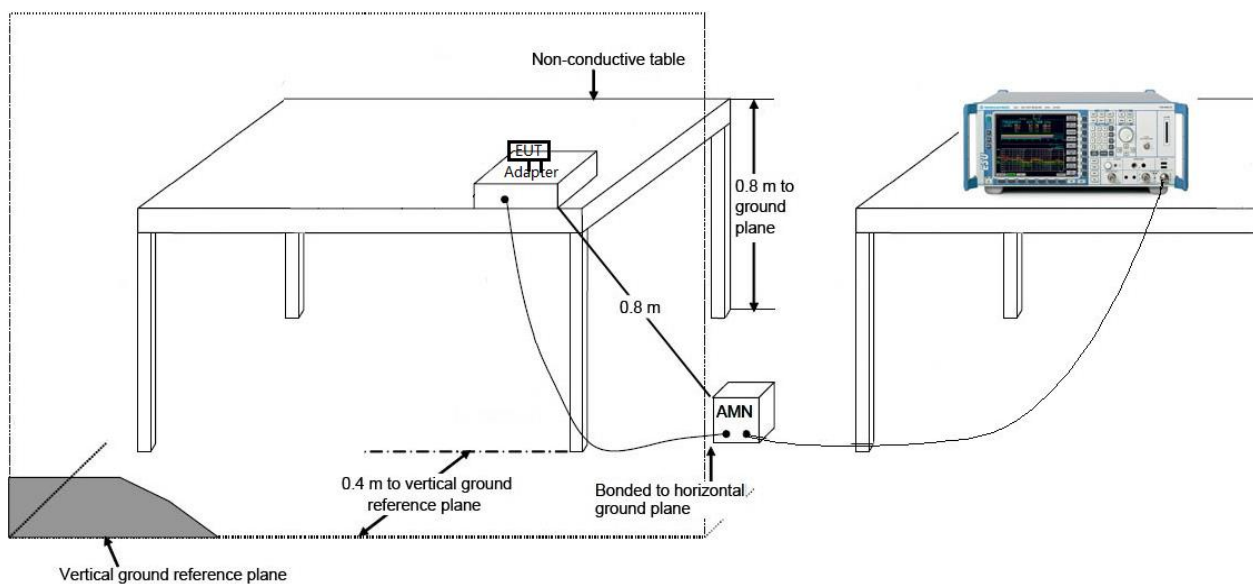

7.8.3. Test Result

The EUT power by battery, no need to test AC Conducted Emissions.

8. CONCLUSION

The data collected relate only the item(s) tested and show that the **Gaming Mouse, FCC ID: RWO-RZ010360** is in compliance with Part 15C of the FCC Rules.

————— The End —————