

FCC Radio Test Report

FCC ID: RWO-RC300380

This report concerns: Original Grant

Project No. : 2101C005
Equipment : USB WIRELESS TRANSCEIVER
Brand Name : RAZER
Test Model : RC30-0380
Series Model : RC30-0380XXXX-XXXX (X can be 0-9 or A-Z)
Applicant : Razer Inc.
Address : 9 Pasteur, Suite 100, Irvine, CA92618, USA.
Manufacturer : Razer (Asia-Pacific) Pte.,Ltd.
Address : 514 Chai Chee Lane, #07-01-06,Singapore 469029
Factory : RAZER TECHNOLOGY AND DEVELOPMENT (SHENZHEN) CO., LTD
Address : East Wing, 3rd Floor, Block 2, Phase 1 of Vision Shenzhen Business Park Keji South Road, Hi-Tech Industrial Park, Shenzhen 518057, China
Date of Receipt : Jan. 04, 2021
Date of Test : Jan. 05, 2021 ~ May 12, 2021
Issued Date : Jun. 24, 2021
Report Version : R00
Test Sample : Sample No.: DG2021010574 for conducted, DG2021020716 for radiated.
Standard(s) : FCC Part15, Subpart C (15.247)
ANSI C63.10-2013
FCC KDB 558074 D01 15.247 Meas Guidance V05r02

The above equipment has been tested and found compliance with the requirement of the relative standards by BTL Inc.



Prepared by : Welly Zhou



Approved by : Ethan Ma



Certificate #5123.02

Add: No.3, Jinshagang 1st Road, Shixia, Dalang Town,Dongguan, Guangdong, China.

Tel: +86-769-8318-3000

Web: www.newbtl.com

Declaration

BTL represents to the client that testing is done in accordance with standard procedures as applicable and that test instruments used has been calibrated with standards traceable to international standard(s) and/or national standard(s).

BTL's reports apply only to the specific samples tested under conditions. It is manufacture's responsibility to ensure that additional production units of this model are manufactured with the identical electrical and mechanical components. **BTL** shall have no liability for any declarations, inferences or generalizations drawn by the client or others from **BTL** issued reports.

The report must not be used by the client to claim product certification, approval, or endorsement by NVLAP, NIST, A2LA, or any agency of the U.S. Government.

This report is the confidential property of the client. As a mutual protection to the clients, the public and ourselves, the test report shall not be reproduced, except in full, without our written approval.

BTL's laboratory quality assurance procedures are in compliance with the **ISO/IEC 17025** requirements, and accredited by the conformity assessment authorities listed in this test report.

BTL is not responsible for the sampling stage, so the results only apply to the sample as received.

The information, data and test plan are provided by manufacturer which may affect the validity of results, so it is manufacturer's responsibility to ensure that the apparatus meets the essential requirements of applied standards and in all the possible configurations as representative of its intended use.

Limitation

For the use of the authority's logo is limited unless the Test Standard(s)/Scope(s)/Item(s) mentioned in this test report is (are) included in the conformity assessment authorities acceptance respective.

Please note that the measurement uncertainty is provided for informational purpose only and are not use in determining the Pass/Fail results.

Table of Contents	Page
REPORT ISSUED HISTORY	4
1 . SUMMARY OF TEST RESULTS	5
1.1 TEST FACILITY	6
1.2 MEASUREMENT UNCERTAINTY	6
1.3 TEST ENVIRONMENT CONDITIONS	6
2 . GENERAL INFORMATION	7
2.1 GENERAL DESCRIPTION OF EUT	7
2.2 DESCRIPTION OF TEST MODES	9
2.3 PARAMETERS OF TEST SOFTWARE	9
2.4 BLOCK DIAGRAM SHOWING THE CONFIGURATION OF SYSTEM TESTED	10
2.5 SUPPORT UNITS	10
3 . RADIATED EMISSION TEST	11
3.1 LIMIT	11
3.2 TEST PROCEDURE	12
3.3 DEVIATION FROM TEST STANDARD	12
3.4 TEST SETUP	12
3.5 EUT OPERATING CONDITIONS	13
3.6 TEST RESULT - 30 MHZ TO 1000 MHZ	13
3.7 TEST RESULT - ABOVE 1000 MHZ	13
4 . MAXIMUM OUTPUT POWER	14
4.1 LIMIT	14
4.2 TEST PROCEDURE	14
4.3 DEVIATION FROM STANDARD	14
4.4 TEST SETUP	14
4.5 EUT OPERATION CONDITIONS	14
4.6 TEST RESULTS	14
5 . MEASUREMENT INSTRUMENTS LIST	15
APPENDIX A - RADIATED EMISSION - 30 MHZ TO 1000 MHZ	16
APPENDIX B - RADIATED EMISSION - ABOVE 1000 MHZ	19
APPENDIX C - MAXIMUM OUTPUT POWER	32

REPORT ISSUED HISTORY

Report Version	Description	Issued Date
R00	Original Issue.	Jun. 24, 2021

1. SUMMARY OF TEST RESULTS

Test procedures according to the technical standard(s):

FCC Part15, Subpart C (15.247)				
Standard(s) Section	Test Item	Test Result	Judgment	Remark
15.247(d) 15.205(a) 15.209(a)	Radiated Emissions	APPENDIX A APPENDIX B	PASS	-----
15.247(b)(3)	Maximum Output Power	APPENDIX C	PASS	-----

Note:

(1) "N/A" denotes test is not applicable to this device.

1.1 TEST FACILITY

The test facilities used to collect the test data in this report is at the location of No.3, Jinshagang 1st Road, Shixia, Dalang Town, Dongguan, Guangdong, China.

BTL's Test Firm Registration Number for FCC: 357015

BTL's Designation Number for FCC: CN1240

1.2 MEASUREMENT UNCERTAINTY

ISO/IEC 17025 requires that an estimate of the measurement uncertainties associated with the emissions test results be included in the report. The measurement uncertainties given below are based on a 95% confidence level (based on a coverage factor (k=2))

The BTL measurement uncertainty as below table:

A. Radiated emissions Measurement:

Test Site	Method	Measurement Frequency Range	Ant. H / V	U, (dB)
DG-CB03	CISPR	9kHz ~ 30MHz	-	3.02
		30MHz ~ 200MHz	V	4.26
		30MHz ~ 200MHz	H	3.38
		200MHz ~ 1,000MHz	V	3.98
		200MHz ~ 1,000MHz	H	3.94
		1GHz ~ 6GHz	-	3.96
		6GHz ~ 18GHz	-	5.24
		18GHz ~ 26.5GHz	-	3.62
		26.5GHz ~ 40GHz	-	4.00

B. Other Measurement:

Parameter	Uncertainty
Maximum Output Power	±0.95 dB
Temperature	±0.08 °C
Time	±0.58 %
Supply voltages	±0.3 %

Note: Unless specifically mentioned, the uncertainty of measurement has not been taken into account to declare the compliance or non-compliance to the specification.

1.3 TEST ENVIRONMENT CONDITIONS

Test Item	Temperature	Humidity	Test Voltage	Tested By
Radiated Emissions-30 MHz to 1GHz	26°C	52%	DC 5V	Hayden Chen
Radiated Emissions-Above 1000 MHz	26°C	52%	DC 5V	Hayden Chen
Maximum Output Power	23°C	52%	DC 5V	Hand Huang

2. GENERAL INFORMATION

2.1 GENERAL DESCRIPTION OF EUT

Equipment	USB WIRELESS TRANSCEIVER
Brand Name	RAZER
Test Model	RC30-0380
Series Model	RC30-0380XXXX-XXXX (X can be 0-9 or A-Z)
Model Difference(s)	The system model number is RZ04-0380XXXX-XXXX, this system consists of Gaming Headset (Model: RZ04-0380) and USB Wireless Transceiver (Model: RC30-0380), X can be 0-9 or A-Z.
Chip Model	AV6301
Power Source	Supplied from PC USB port.
Power Rating	DC 5V
Operation Frequency	2403.35 MHz ~ 2477.35 MHz
Modulation Technology	GFSK
Bit Rate of Transmitter	2 Mbps
Max. Peak Output Power	3.95 dBm (0.0025 W)
Max. Average Output Power	3.12 dBm (0.0021 W)

Note:

1. For a more detailed features description, please refer to the manufacturer's specifications or the user's manual.
2. For this USB WIRELESS TRANSCEIVER, the chip of Model AV6201 can be alternated by the chip of Model AV6301. Due to this two chips have the same electrical characteristics, only the power and radiated spurious emissions above 30MHz were evaluated and recorded in this report.

3. Channel List:

Channel	Frequency (MHz)	Channel	Frequency (MHz)
01	2403.35	20	2441.35
02	2405.35	21	2443.35
03	2407.35	22	2445.35
04	2409.35	23	2447.35
05	2411.35	24	2449.35
06	2413.35	25	2451.35
07	2415.35	26	2453.35
08	2417.35	27	2455.35
09	2419.35	28	2457.35
10	2421.35	29	2459.35
11	2423.35	30	2461.35
12	2425.35	31	2463.35
13	2427.35	32	2465.35
14	2429.35	33	2467.35
15	2431.35	34	2469.35
16	2433.35	35	2471.35
17	2435.35	36	2473.35
18	2437.35	37	2475.35
19	2439.35	38	2477.35

4. Table for Filed Antenna:

Ant.	Brand Name	Model	Antenna Type	Connector	Gain (dBi)
1	N/A	N/A	Monopole	N/A	1.364

Note: The antenna gain is provided by the manufacturer.

2.2 DESCRIPTION OF TEST MODES

The test system was pre-tested based on the consideration of all possible combinations of EUT operation mode.

Pretest Mode	Description
Mode 1	TX Mode NOTE (1)
Mode 2	TX Mode_ 2403.35 MHz

Following mode(s) was (were) found to be the worst case(s) and selected for the final test.

Radiated emissions test - Below 1GHz	
Final Test Mode	Description
Mode 2	TX Mode_ 2403.35 MHz

Radiated emissions test - Above 1GHz	
Final Test Mode	Description
Mode 1	TX Mode NOTE (1)

Output Power test	
Final Test Mode	Description
Mode 1	TX Mode NOTE (1)

Note:

- (1) The measurements are performed at the high, middle, low available channels.
- (2) For radiated emission above 1 GHz test, 1GHz~26.5GHz have been pre-tested and in this report only recorded the worst case. The remaining spurious points are all below the limit value of 20dB.
- (3) For radiated emission below 1 GHz test, the 2403.35 MHz is found to be the worst case and recorded.

2.3 PARAMETERS OF TEST SOFTWARE

During testing channel & power controlling software provided by the customer was used to control the operating channel as well as the output power level.

Test Software	VMIttest-1.1.6.56		
Frequency (MHz)	2403.35	2439.35	2477.35
2Mbps	0x08	0x08	0x08

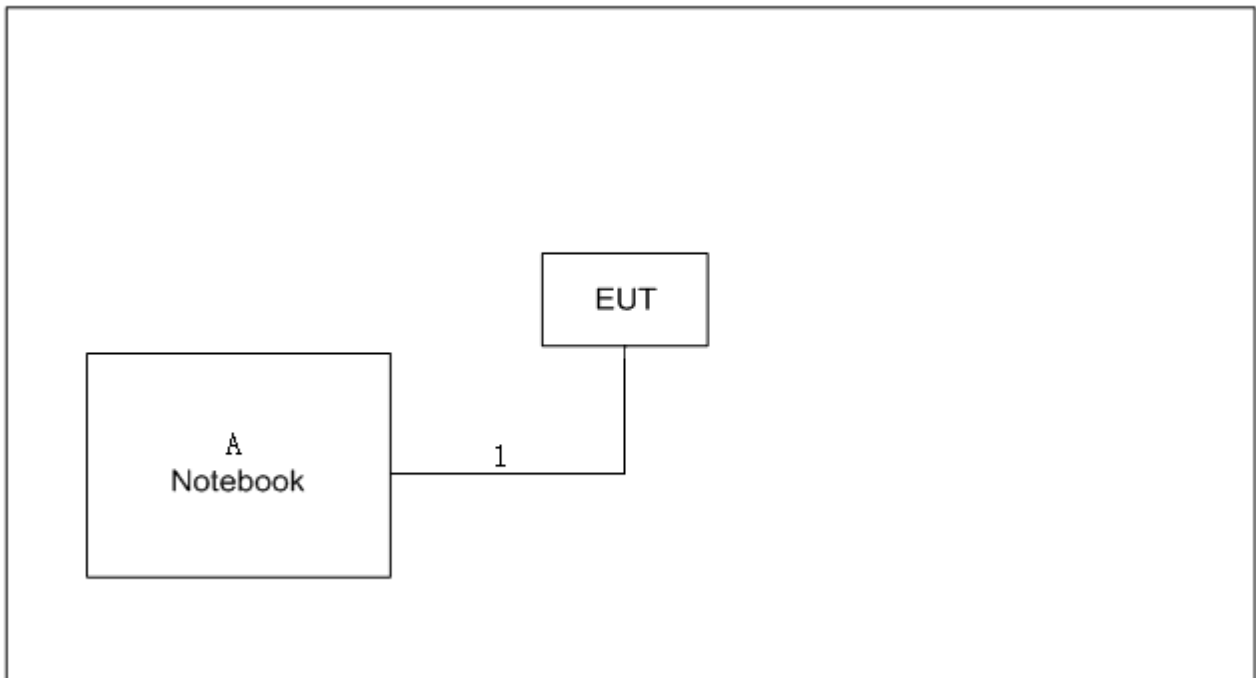
2.4 BLOCK DIAGRAM SHOWING THE CONFIGURATION OF SYSTEM TESTED**2.5 SUPPORT UNITS**

Item	Equipment	Brand	Model No.	Series No.
A	Notebook	HONOR	NBLK-WAX9X	LR07GZNB

Item	Cable Type	Shielded Type	Ferrite Core	Length
1	USB Cable	NO	NO	2m

3. RADIATED EMISSION TEST

3.1 LIMIT

In case the emission fall within the restricted band specified on 15.205(a), then the 15.209(a) limit in the table below has to be followed.

LIMITS OF RADIATED EMISSION MEASUREMENT (9 kHz-1000 MHz)

Frequency (MHz)	Field Strength (microvolts/meter)	Measurement Distance (meters)
0.009-0.490	2400/F(kHz)	300
0.490-1.705	24000/F(kHz)	30
1.705-30.0	30	30
30-88	100	3
88-216	150	3
216-960	200	3
Above 960	500	3

LIMITS OF RADIATED EMISSION MEASUREMENT (Above 1000 MHz)

Frequency (MHz)	(dBuV/m at 3 m)	
	Peak	Average
Above 1000	74	54

Note:

- (1) The limit for radiated test was performed according to FCC PART 15C.
- (2) The tighter limit applies at the band edges.
- (3) Emission level (dBuV/m)=20log Emission level (uV/m).

Spectrum Parameter	Setting
Attenuation	Auto
Start Frequency	1000 MHz
Stop Frequency	10th carrier harmonic
RBW / VBW (Emission in restricted band)	RBW 1 MHz VBW 3 MHz peak detector for Pk value RMS detector for AV value

Receiver Parameter	Setting
Attenuation	Auto
Start ~ Stop Frequency	9 kHz~90 kHz for PK/AVG detector
Start ~ Stop Frequency	90 kHz~110 kHz for QP detector
Start ~ Stop Frequency	110 kHz~490 kHz for PK/AVG detector
Start ~ Stop Frequency	490 kHz~30 MHz for QP detector
Start ~ Stop Frequency	30 MHz~1000 MHz for QP detector

3.2 TEST PROCEDURE

- a. The measuring distance of 3 m shall be used for measurements. The EUT was placed on the top of a rotating table 0.8 meter above the ground at a 3 meter semi-anechoic chamber. The table was rotated 360 degrees to determine the position of the highest radiation.(below 1 GHz)
- b. The measuring distance of 3 m shall be used for measurements. The EUT was placed on the top of a rotating table 1.5 meter above the ground at a 3 meter semi-anechoic chamber. The table was rotated 360 degrees to determine the position of the highest radiation.(above 1 GHz)
- c. The height of the equipment or of the substitution antenna shall be 0.8m or 1.5m; the height of the test antenna shall vary between 1 m to 4 m. Both horizontal and vertical polarizations of the antenna are set to make the measurement.
- d. For each suspected emission, the EUT was arranged to its worst case and then the antenna was tuned to heights find the maximum reading (used Bore sight function).
- e. The receiver system was set to peak and average detect function and specified bandwidth with maximum hold mode when the test frequency is above 1 GHz.
- f. The initial step in collecting radiated emission data is a receiver peak detector mode pre-scanning the measurement frequency range. Significant peaks are then marked and then Quasi Peak detector mode re-measured.
- g. All readings are Peak unless otherwise stated QP in column of Note. Peak denotes that the Peak reading compliance with the QP Limits and then QP Mode measurement didn't perform. (below 1 GHz)
- h. All readings are Peak Mode value unless otherwise stated AVG in column of Note. If the Peak Mode Measured value compliance with the Peak Limits and lower than AVG Limits, the EUT shall be deemed to meet both Peak & AVG Limits and then only Peak Mode was measured, but AVG Mode didn't perform. (above 1 GHz)
- i. For the actual test configuration, please refer to the related Item –EUT Test Photos.

3.3 DEVIATION FROM TEST STANDARD

No deviation

3.4 TEST SETUP

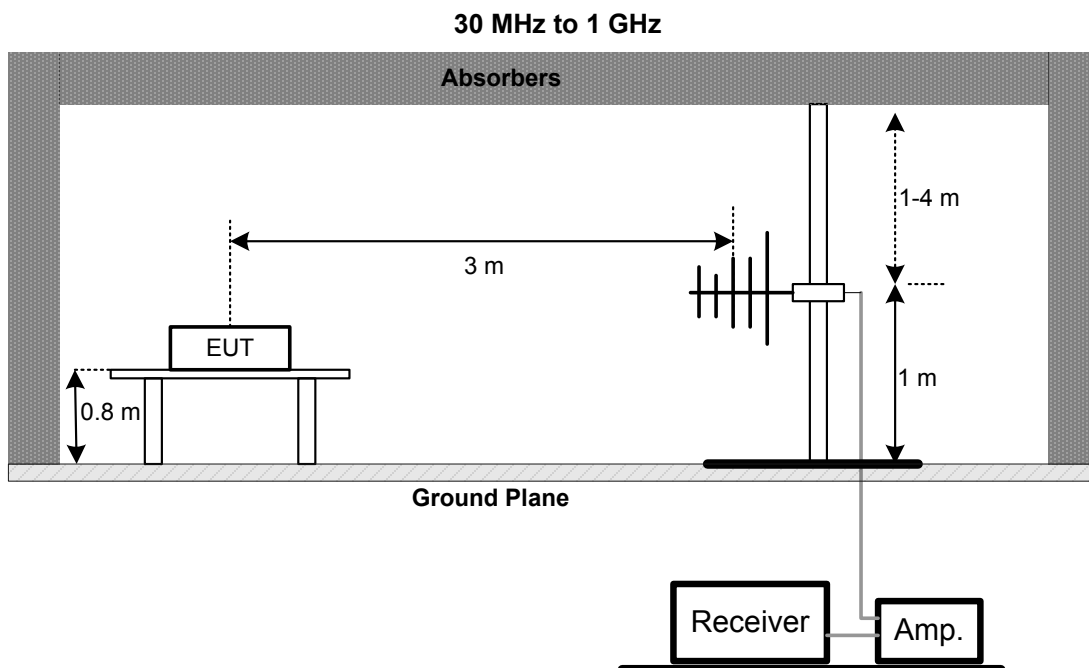

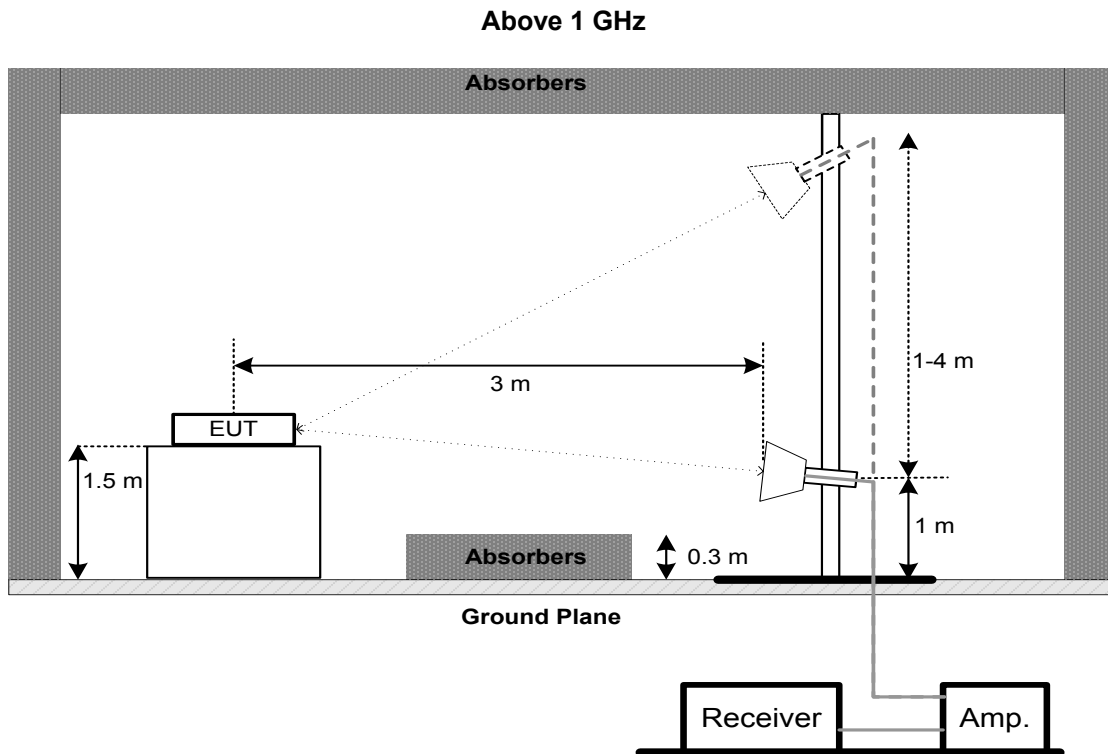

3.5 EUT OPERATING CONDITIONS

The EUT was programmed to be in continuously transmitting mode.

3.6 TEST RESULT - 30 MHz TO 1000 MHz

Please refer to the APPENDIX A.

3.7 TEST RESULT - ABOVE 1000 MHz

Please refer to the APPENDIX B.

Remark:

- (1) No limit: This is fundamental signal, the judgment is not applicable.
For fundamental signal judgment was referred to Peak output test.

4. MAXIMUM OUTPUT POWER

4.1 LIMIT

FCC Part15, Subpart C (15.247)		
Section	Test Item	Limit
15.247(b)(3)	Maximum Output Power	1 watt or 30 dBm

4.2 TEST PROCEDURE

- a. The EUT was directly connected to the spectrum analyzer and antenna output port as show in the block diagram below.
- b. The maximum conducted output power was performed in accordance with method 11.9.1.1 or 11.9.2.2 of ANSI C63.10-2013.

4.3 DEVIATION FROM STANDARD

No deviation.

4.4 TEST SETUP

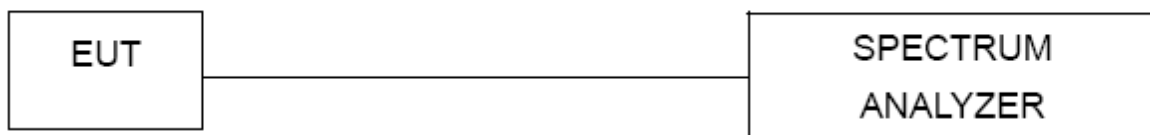

4.5 EUT OPERATION CONDITIONS

The EUT tested system was configured as the statements of 4.5 unless otherwise a special operating condition is specified in the follows during the testing.

4.6 TEST RESULTS

Please refer to the APPENDIX C.

5. MEASUREMENT INSTRUMENTS LIST

Radiated Emissions - 30 MHz to 1 GHz					
Item	Kind of Equipment	Manufacturer	Type No.	Serial No.	Calibrated until
1	Antenna	Schwarzbeck	VULB9160	9160-3232	Mar. 15, 2022
2	Amplifier	HP	8447D	2944A08742	Feb. 28, 2022
3	Receiver	Agilent	N9038A	MY52130039	Jul. 25, 2021
4	Cable	emci	LMR-400(30MHz-1 GHz)(8m+5m)	N/A	May 21, 2022
5	Controller	CT	SC100	N/A	N/A
6	Controller	MF	MF-7802	MF780208416	N/A
7	Measurement Software	Farad	EZ-EMC Ver.NB-03A1-01	N/A	N/A
8	966 Chambe Room	RM	9*6*6m	N/A	Jul. 25, 2021

Radiated Emissions - Above 1 GHz					
Item	Kind of Equipment	Manufacturer	Type No.	Serial No.	Calibrated until
1	Double Ridged Guide Antenna	ETS	3115	75789	May 11, 2022
2	Broad-Band Horn Antenna	Schwarzbeck	BBHA 9170	9170319	Jul. 07, 2021
3	Amplifier	Agilent	8449B	3008A02584	Jul. 25, 2021
4	Microwave Preampifier With Adaptor	EMC INSTRUMENT	EMC2654045	980039 & HA01	Feb. 28, 2022
5	Receiver	Agilent	N9038A	MY52130039	Jul. 25, 2021
6	Controller	CT	SC100	N/A	N/A
7	Controller	MF	MF-7802	MF780208416	N/A
8	Cable	N/A	EMC104-SM-SM-6000	N/A	Oct. 16, 2021
9	Measurement Software	Farad	EZ-EMC Ver.NB-03A1-01	N/A	N/A
10	Filter	STI	STI15-9912	N/A	Jul. 25, 2021
11	966 Chambe Room	RM	9*6*6m	N/A	Jul. 25, 2021

Maximum Output Power					
Item	Kind of Equipment	Manufacturer	Type No.	Serial No.	Calibrated until
1	Spectrum Analyzer	R&S	FSP40	100185	Jul. 25, 2021
2	Attenuator	WOKEN	6SM3502	VAS1214NL	Feb. 10, 2022
3	DC Block	Mini	N/A	N/A	N/A
4	RF Cable	Tongkaichuan	N/A	N/A	N/A

Remark: "N/A" denotes no model name, serial no. or calibration specified.

All calibration period of equipment list is one year.

APPENDIX A - RADIATED EMISSION - 30 MHZ TO 1000 MHZ

Test Mode: TX Mode_ 2403.35 MHz

Vertical

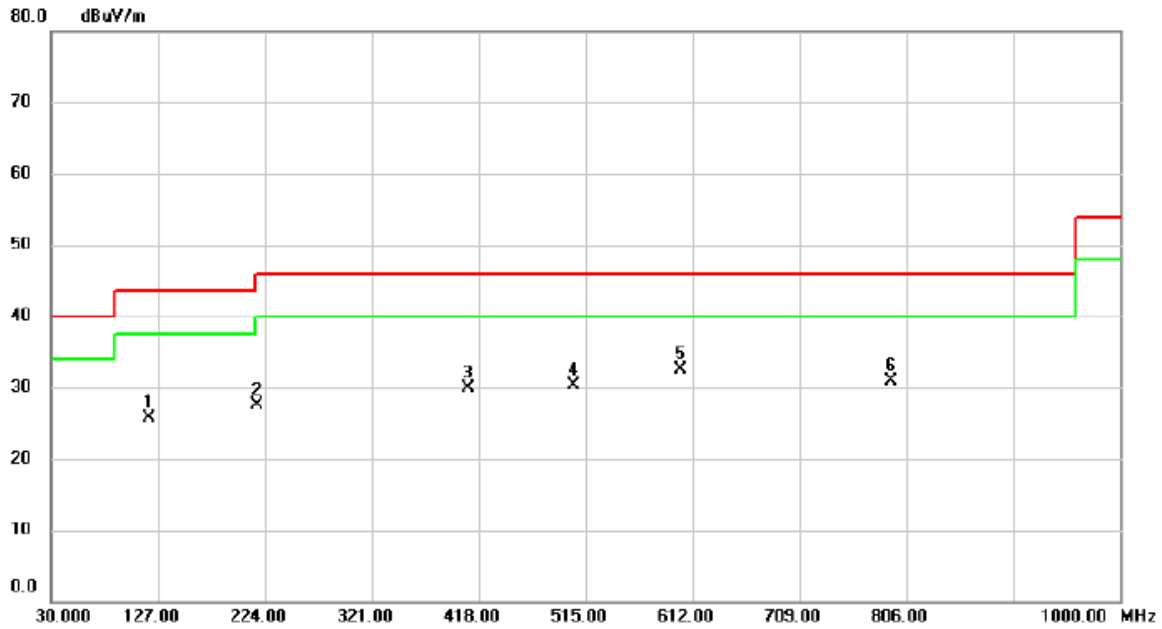

No.	Mk.	Freq. MHz	Reading Level dBuV	Correct Factor dB	Measure- ment dBuV/m	Limit dBuV/m	Margin dB	Detector	Comment
1		118.270	40.01	-14.31	25.70	43.50	-17.80	peak	
2		216.240	42.47	-14.97	27.50	46.00	-18.50	peak	
3		408.300	38.51	-8.55	29.96	46.00	-16.04	peak	
4		504.330	36.87	-6.48	30.39	46.00	-15.61	peak	
5	*	600.360	36.97	-4.55	32.42	46.00	-13.58	peak	
6		792.420	31.75	-0.88	30.87	46.00	-15.13	peak	

REMARKS:

- (1) Measurement Value = Reading Level + Correct Factor.
- (2) Margin Level = Measurement Value - Limit Value.

Test Mode: TX Mode_ 2403.35 MHz

Horizontal

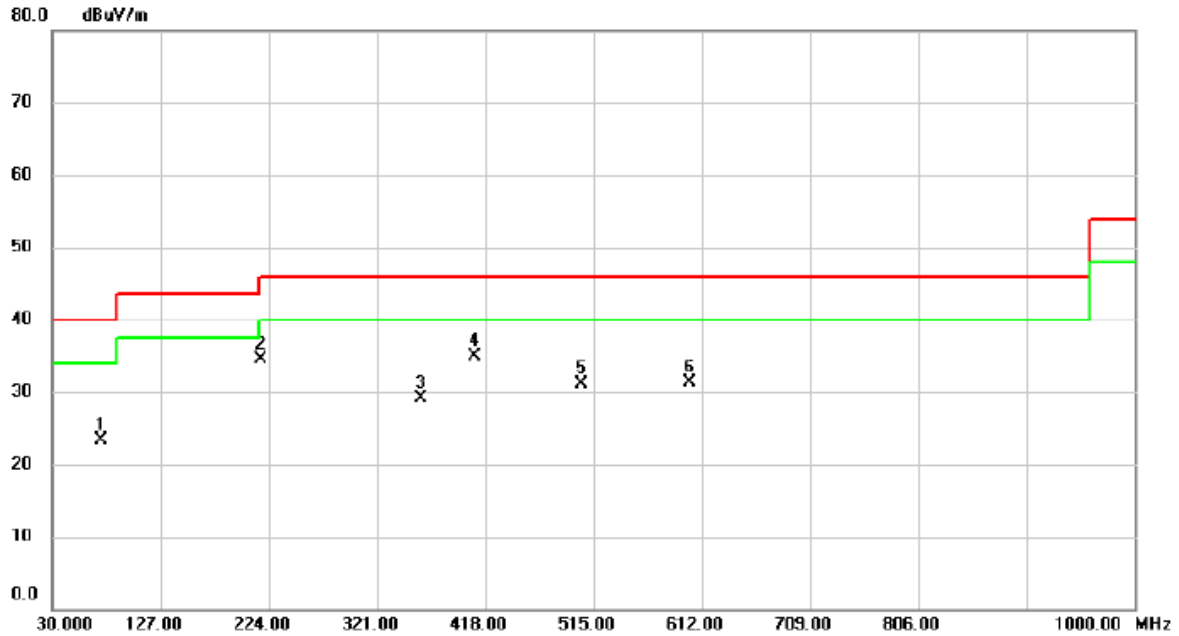

No.	Mk.	Freq. MHz	Reading Level dBuV	Correct Factor dB	Measure- ment dBuV/m	Limit dBuV/m	Margin dB	Detector	Comment
1		73.650	40.40	-17.02	23.38	40.00	-16.62	peak	
2		216.240	49.38	-14.97	34.41	46.00	-11.59	peak	
3		359.800	38.85	-9.73	29.12	46.00	-16.88	peak	
4	*	408.300	43.50	-8.55	34.95	46.00	-11.05	peak	
5		504.330	37.68	-6.48	31.20	46.00	-14.80	peak	
6		600.360	35.76	-4.55	31.21	46.00	-14.79	peak	

REMARKS:

- (1) Measurement Value = Reading Level + Correct Factor.
- (2) Margin Level = Measurement Value - Limit Value.

APPENDIX B - RADIATED EMISSION - ABOVE 1000 MHZ

Test Mode : TX Mode_ 2403.35 MHz

Vertical

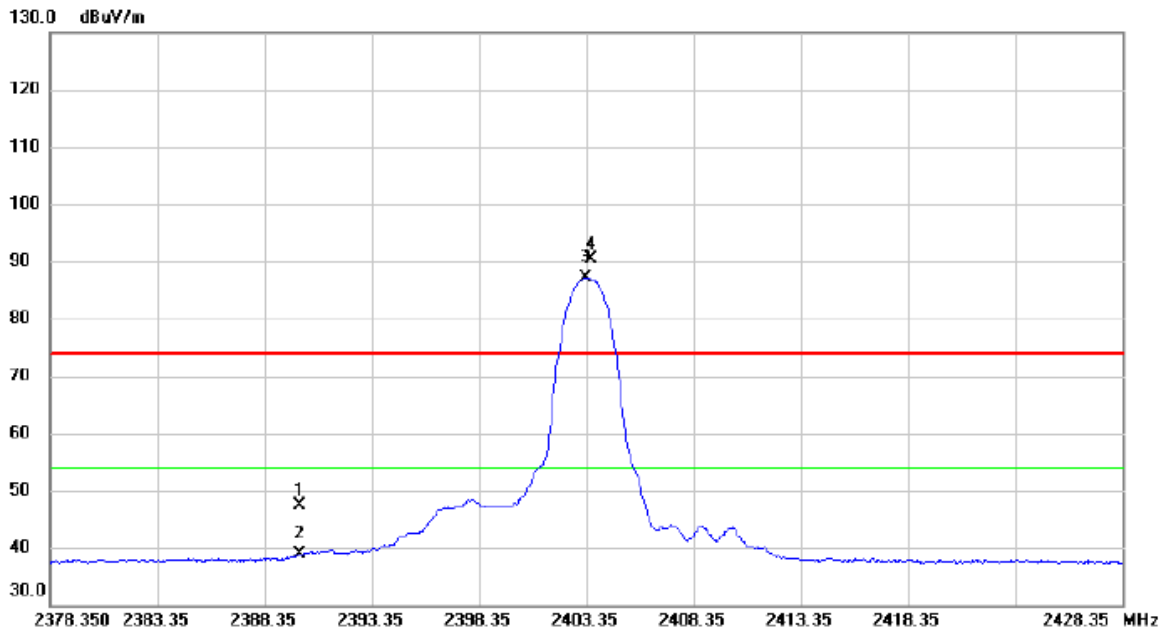

No.	Mk.	Freq. MHz	Reading Level dBuV	Correct Factor dB	Measure- ment dBuV/m	Limit dBuV/m	Margin dB	Detector	Comment
1		2390.000	40.24	7.26	47.50	74.00	-26.50	peak	
2		2390.000	31.74	7.26	39.00	54.00	-15.00	AVG	
3	*	2403.300	79.87	7.26	87.13	54.00	33.13	AVG	No Limit
4	X	2403.550	83.18	7.26	90.44	74.00	16.44	peak	No Limit

REMARKS:

- (1) Measurement Value = Reading Level + Correct Factor.
- (2) Margin Level = Measurement Value - Limit Value.

Test Mode : TX Mode_ 2403.35 MHz

Vertical

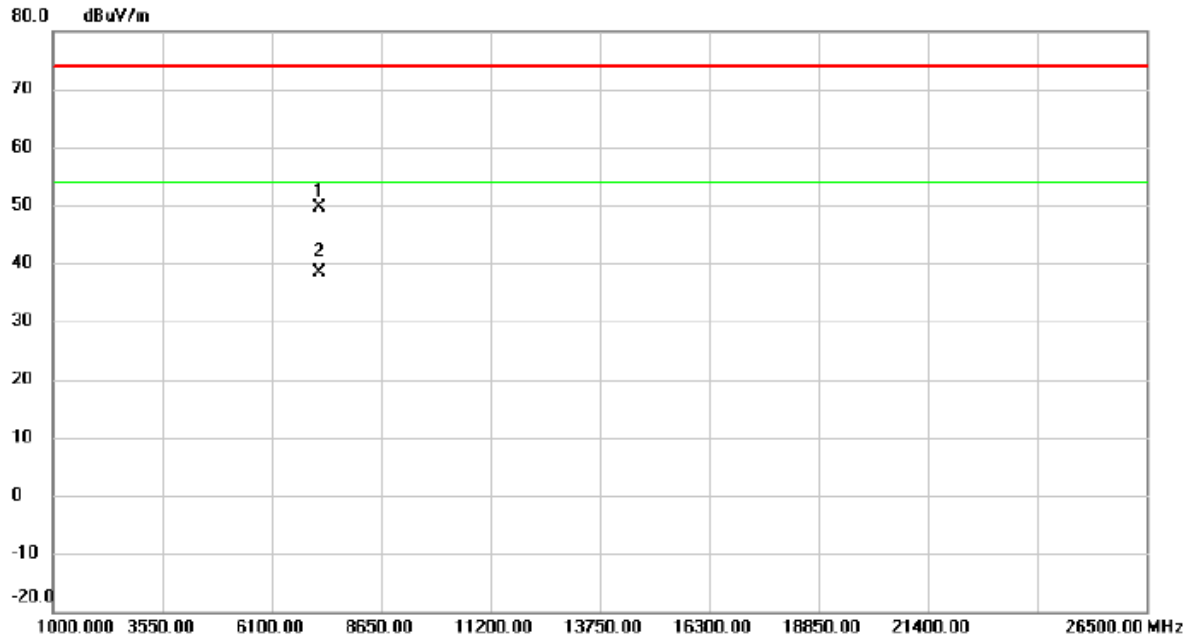

No.	Mk.	Freq. MHz	Reading Level dBuV	Correct Factor dB	Measure- ment dBuV/m	Limit dBuV/m	Margin dB	Detector	Comment
1		7208.300	39.60	10.14	49.74	74.00	-24.26	peak	
2	*	7215.190	28.31	10.15	38.46	54.00	-15.54	AVG	

REMARKS:

(1) Measurement Value = Reading Level + Correct Factor.

(2) Margin Level = Measurement Value - Limit Value.

Test Mode : TX Mode_ 2403.35 MHz

Horizontal

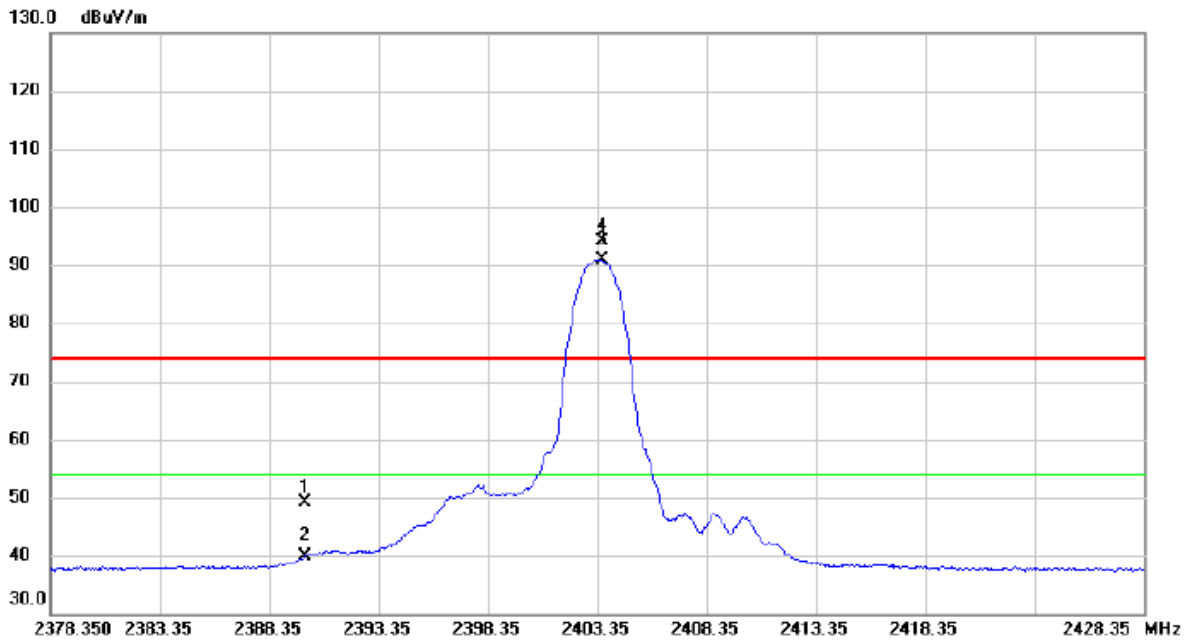

No.	Mk.	Freq. MHz	Reading Level dBuV	Correct Factor dB	Measure- ment dBuV/m	Limit dBuV/m	Margin dB	Detector	Comment
1		2390.000	41.82	7.26	49.08	74.00	-24.92	peak	
2		2390.000	32.74	7.26	40.00	54.00	-14.00	AVG	
3	*	2403.550	83.68	7.26	90.94	54.00	36.94	AVG	No Limit
4	X	2403.600	86.95	7.26	94.21	74.00	20.21	peak	No Limit

REMARKS:

- (1) Measurement Value = Reading Level + Correct Factor.
- (2) Margin Level = Measurement Value - Limit Value.

Test Mode :	TX Mode_ 2403.35 MHz
-------------	----------------------

Horizontal

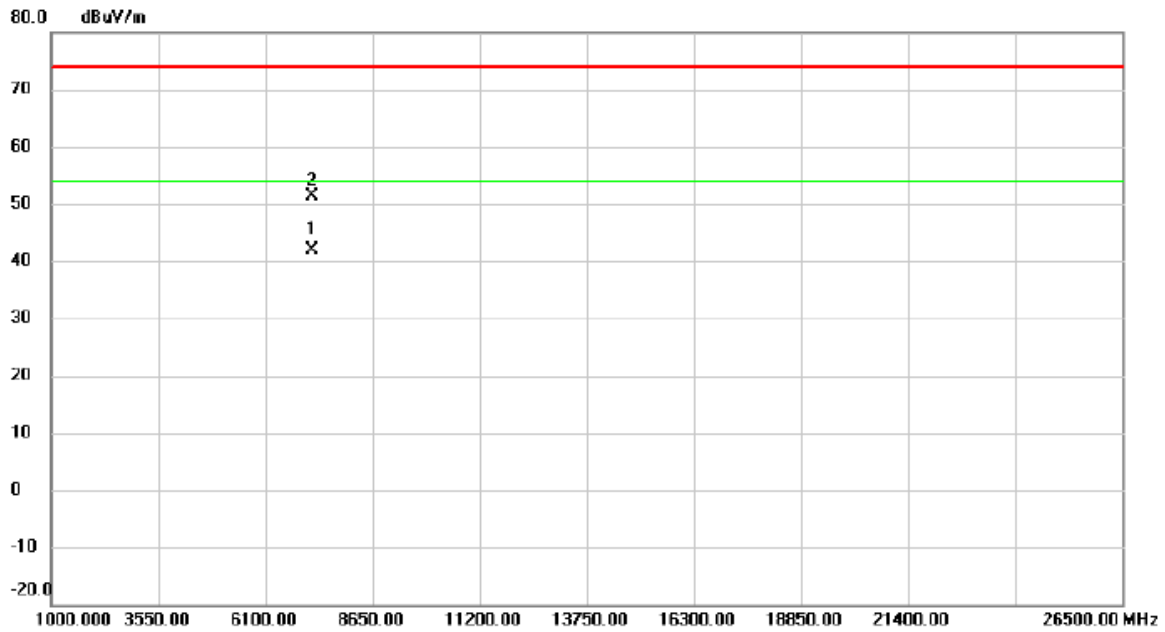

No.	Mk.	Freq.	Reading Level	Correct Factor	Measurement	Limit	Margin		
		MHz	dBuV	dB	dBuV/m	dBuV/m	dB	Detector	Comment
1	*	7210.380	31.74	10.14	41.88	54.00	-12.12	AVG	
2		7210.770	41.21	10.15	51.36	74.00	-22.64	peak	

REMARKS:

(1) Measurement Value = Reading Level + Correct Factor.

(2) Margin Level = Measurement Value - Limit Value.

Test Mode : TX Mode_ 2439.35 MHz

Vertical

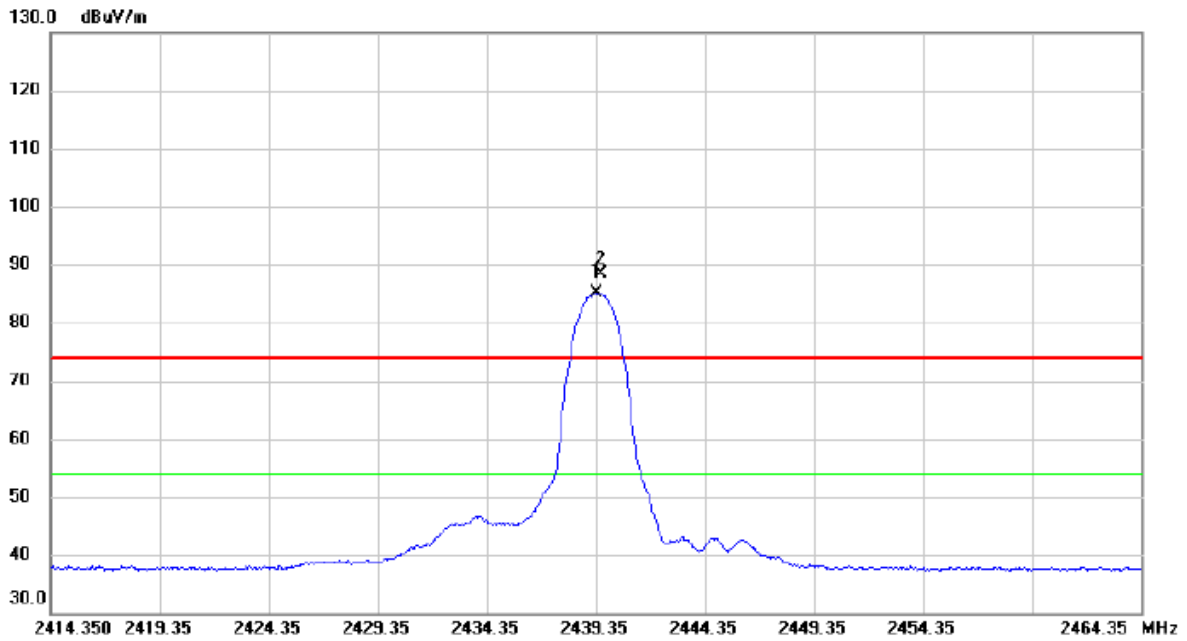

No.	Mk.	Freq. MHz	Reading Level dBuV	Correct Factor dB	Measure- ment dBuV/m	Limit dBuV/m	Margin dB	Detector	Comment
1	*	2439.400	77.76	7.25	85.01	54.00	31.01	AVG	No Limit
2	X	2439.600	81.05	7.25	88.30	74.00	14.30	peak	No Limit

REMARKS:

- (1) Measurement Value = Reading Level + Correct Factor.
- (2) Margin Level = Measurement Value - Limit Value.

Test Mode : TX Mode_ 2439.35 MHz

Vertical

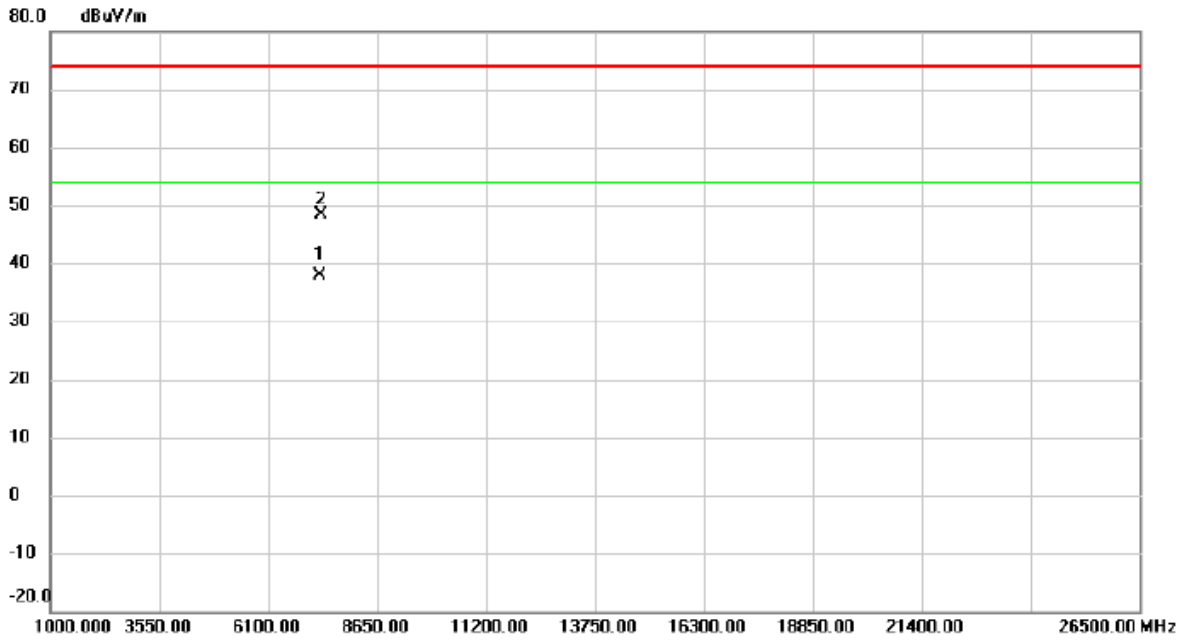

No.	Mk.	Freq. MHz	Reading Level dBuV	Correct Factor dB	Measure- ment dBuV/m	Limit dBuV/m	Margin dB	Detector	Comment
1	*	7309.300	27.61	10.31	37.92	54.00	-16.08	AVG	
2		7326.020	37.91	10.35	48.26	74.00	-25.74	peak	

REMARKS:

- (1) Measurement Value = Reading Level + Correct Factor.
- (2) Margin Level = Measurement Value - Limit Value.

Test Mode : TX Mode_ 2439.35 MHz

Horizontal

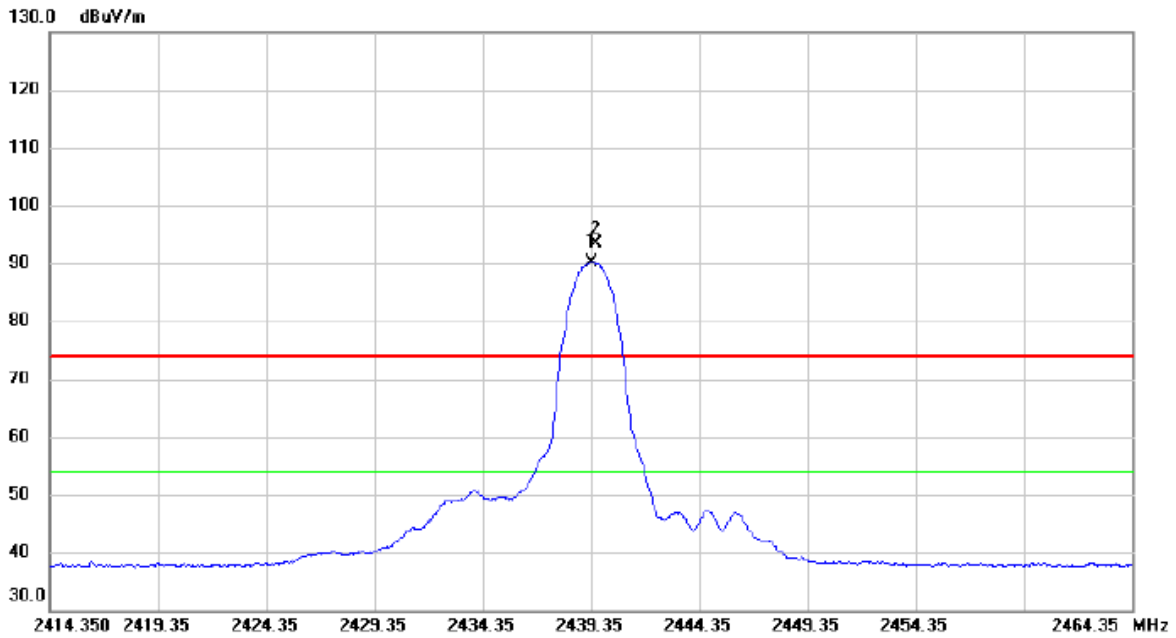

No.	Mk.	Freq. MHz	Reading Level dBuV	Correct Factor dB	Measure- ment dBuV/m	Limit dBuV/m	Margin dB	Detector	Comment
1	*	2439.350	82.90	7.25	90.15	54.00	36.15	AVG	No Limit
2	X	2439.600	86.08	7.25	93.33	74.00	19.33	peak	No Limit

REMARKS:

- (1) Measurement Value = Reading Level + Correct Factor.
- (2) Margin Level = Measurement Value - Limit Value.

Test Mode : TX Mode_ 2439.35 MHz

Horizontal

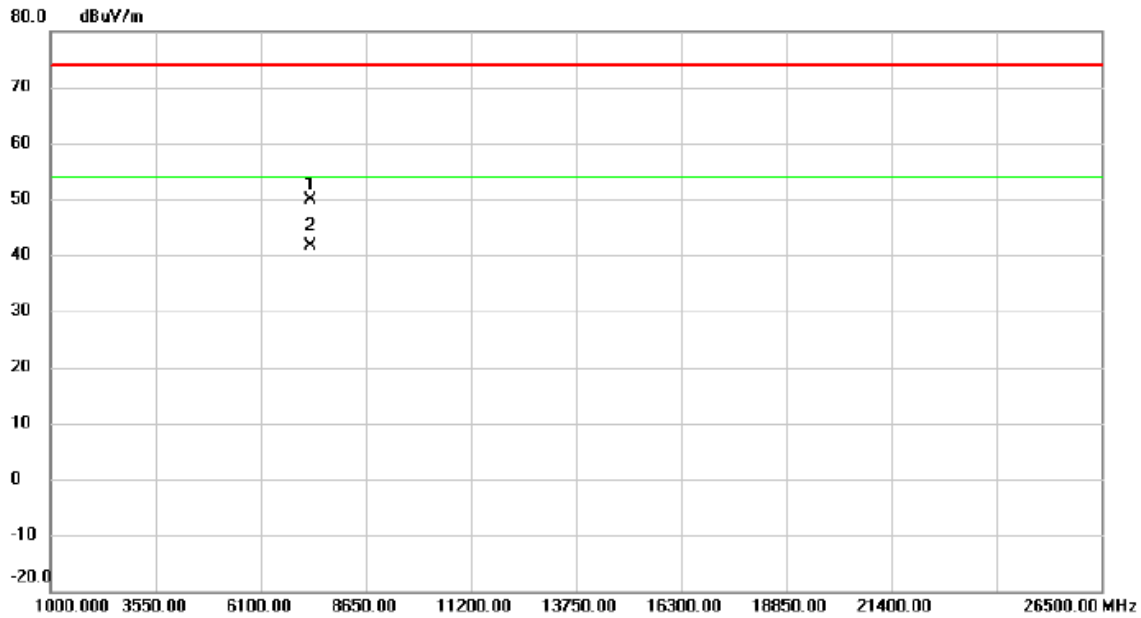

No.	Mk.	Freq. MHz	Reading Level dBuV	Correct Factor dB	Measure- ment dBuV/m	Limit dBuV/m	Margin dB	Detector	Comment
1		7318.310	39.59	10.33	49.92	74.00	-24.08	peak	
2	*	7318.500	31.30	10.33	41.63	54.00	-12.37	AVG	

REMARKS:

- (1) Measurement Value = Reading Level + Correct Factor.
- (2) Margin Level = Measurement Value - Limit Value.

Test Mode : TX Mode_ 2477.35 MHz

Vertical

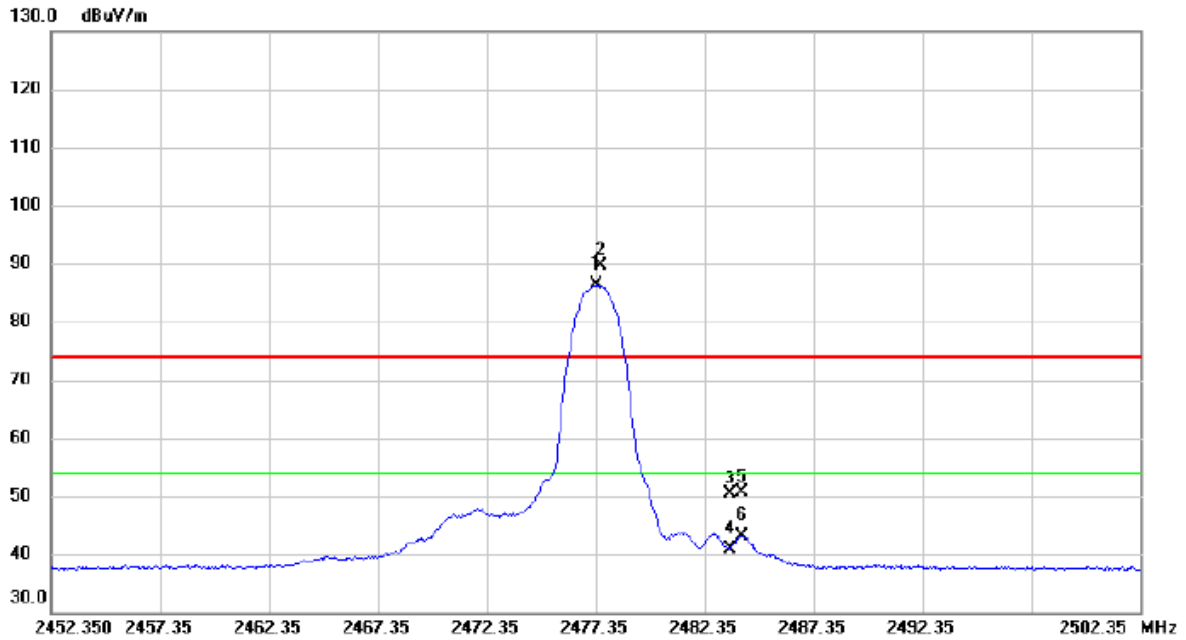

No.	Mk.	Freq. MHz	Reading Level dBuV	Correct Factor dB	Measure- ment dBuV/m	Limit dBuV/m	Margin dB	Detector	Comment
1	*	2477.350	79.03	7.24	86.27	54.00	32.27	AVG	No Limit
2	X	2477.600	82.36	7.24	89.60	74.00	15.60	peak	No Limit
3		2483.500	43.22	7.25	50.47	74.00	-23.53	peak	
4		2483.500	33.67	7.25	40.92	54.00	-13.08	AVG	
5		2484.050	43.31	7.25	50.56	74.00	-23.44	peak	
6		2484.050	35.97	7.25	43.22	54.00	-10.78	AVG	

REMARKS:

- (1) Measurement Value = Reading Level + Correct Factor.
- (2) Margin Level = Measurement Value - Limit Value.

Test Mode : TX Mode_ 2477.35 MHz

Vertical

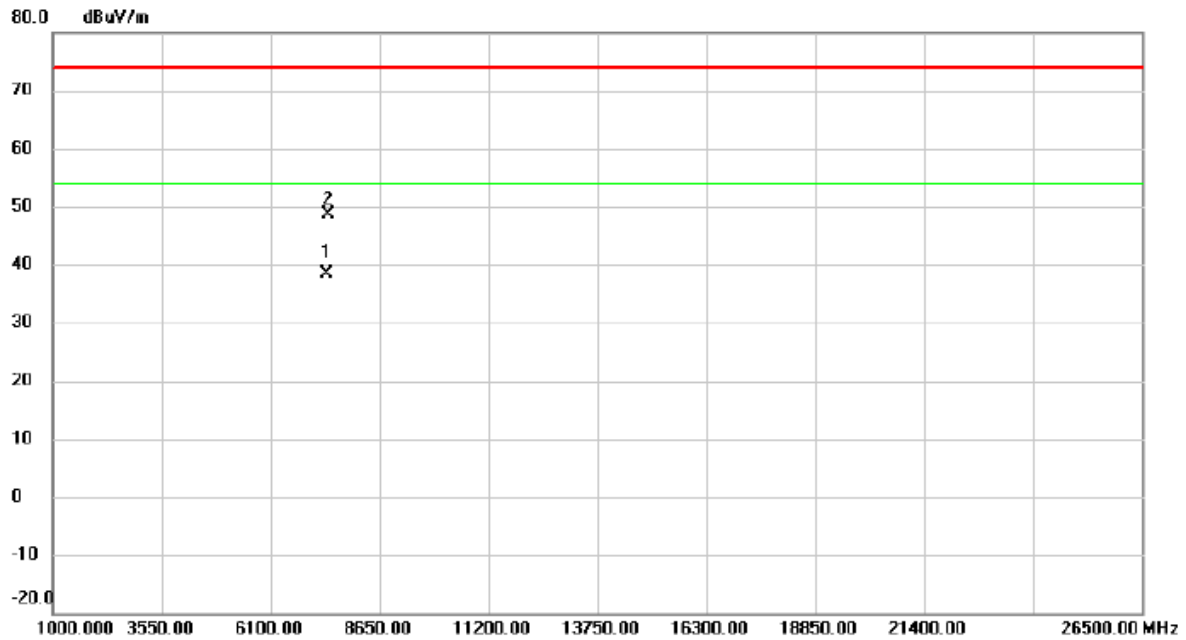

No.	Mk.	Freq. MHz	Reading Level dBuV	Correct Factor dB	Measure- ment dBuV/m	Limit dBuV/m	Margin dB	Detector	Comment
1	*	7425.750	27.82	10.52	38.34	54.00	-15.66	AVG	
2		7438.550	38.21	10.53	48.74	74.00	-25.26	peak	

REMARKS:

- (1) Measurement Value = Reading Level + Correct Factor.
- (2) Margin Level = Measurement Value - Limit Value.

Test Mode : TX Mode_ 2477.35 MHz

Horizontal

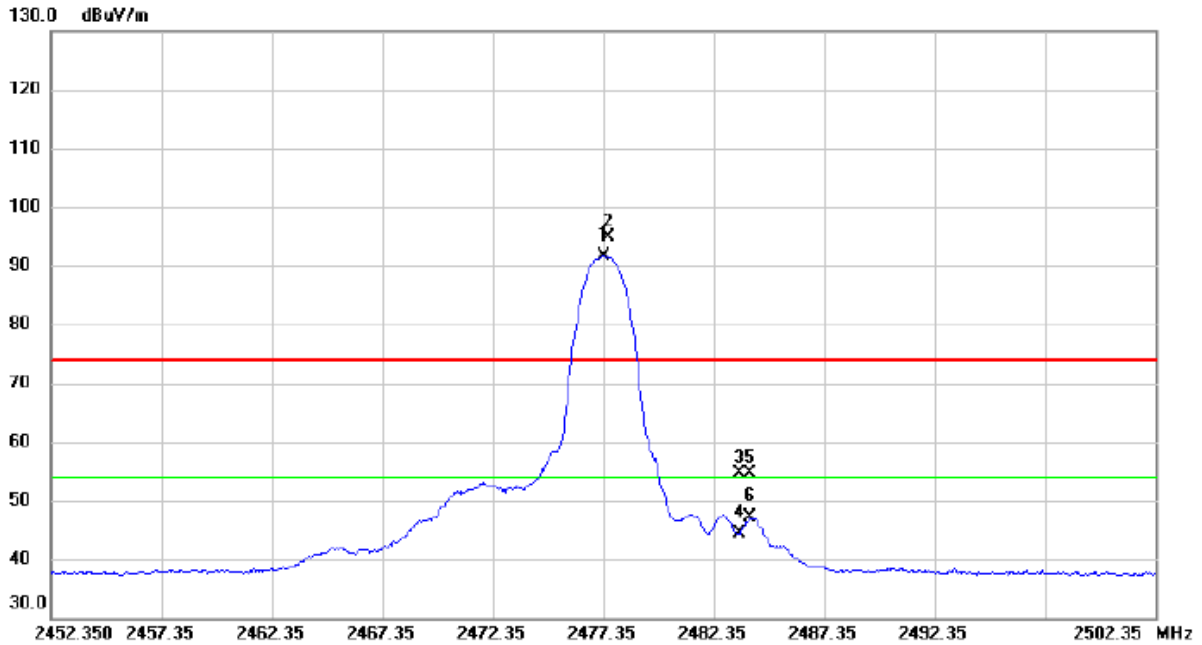

No.	Mk.	Freq. MHz	Reading Level dBuV	Correct Factor dB	Measure- ment dBuV/m	Limit dBuV/m	Margin dB	Detector	Comment
1	*	2477.350	84.34	7.24	91.58	54.00	37.58	AVG	No Limit
2	X	2477.600	87.68	7.24	94.92	74.00	20.92	peak	No Limit
3		2483.500	47.29	7.25	54.54	74.00	-19.46	peak	
4		2483.500	37.18	7.25	44.43	54.00	-9.57	AVG	
5		2484.000	47.32	7.25	54.57	74.00	-19.43	peak	
6		2484.000	39.76	7.25	47.01	54.00	-6.99	AVG	

REMARKS:

- (1) Measurement Value = Reading Level + Correct Factor.
- (2) Margin Level = Measurement Value - Limit Value.

Test Mode :	TX Mode_ 2477.35 MHz
-------------	----------------------

Horizontal

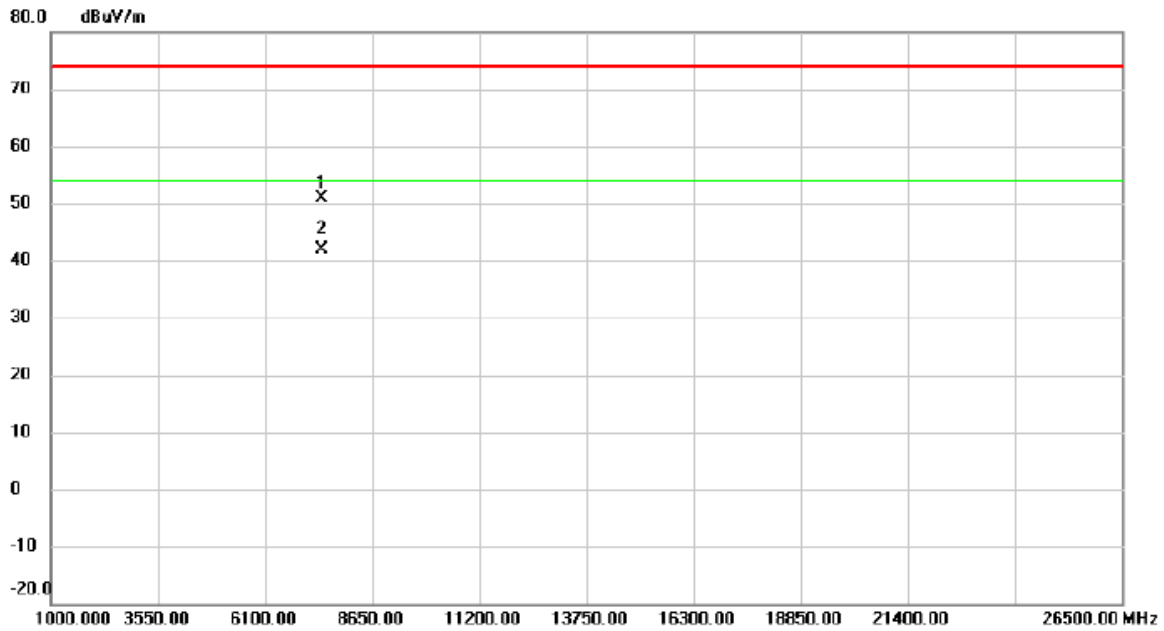

No.	Mk.	Freq.	Reading Level	Correct Factor	Measure-ment	Limit	Margin	Detector	Comment
		MHz	dBuV	dB	dBuV/m	dBuV/m	dB		
1		7432.130	40.34	10.52	50.86	74.00	-23.14	peak	
2	*	7432.310	31.34	10.53	41.87	54.00	-12.13	AVG	

REMARKS:

- (1) Measurement Value = Reading Level + Correct Factor.
- (2) Margin Level = Measurement Value - Limit Value.

APPENDIX C - MAXIMUM OUTPUT POWER

Test Mode:	CH01, CH19, CH38
------------	------------------

Frequency (MHz)	Peak Output Power (dBm)	Peak Output Power (W)	Max. Limit (dBm)	Max. Limit (W)	Test Result
2403.35	3.95	0.0025	30.00	1.00	Pass
2439.35	3.49	0.0022	30.00	1.00	Pass
2477.35	2.89	0.0019	30.00	1.00	Pass

Frequency (MHz)	Average Output Power (dBm)	Average Output Power (W)	Max. Limit (dBm)	Max. Limit (W)	Test Result
2403.35	3.12	0.0021	30.00	1.00	Pass
2439.35	2.66	0.0018	30.00	1.00	Pass
2477.35	2.07	0.0016	30.00	1.00	Pass

CH01

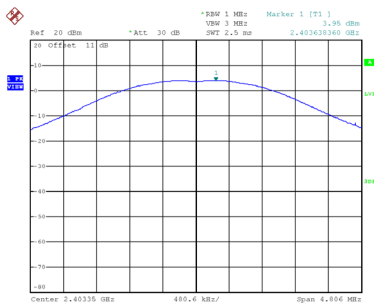

Date: 12_MAY_2021 16:04:58

CH19 Peak Output Power

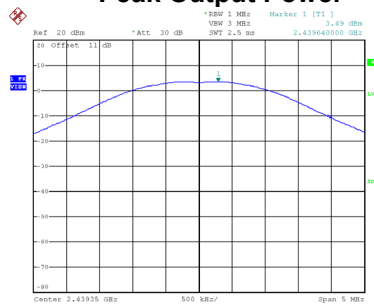

Date: 12_MAY_2021 16:04:30

CH38

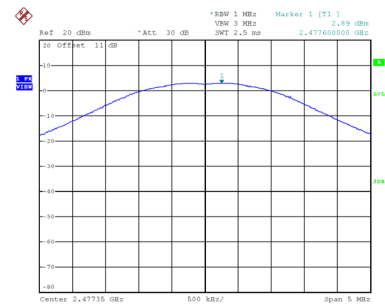

Date: 12_MAY_2021 16:03:37

Average Output Power

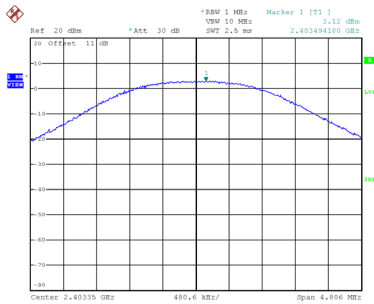

Date: 12_MAY_2021 16:05:13

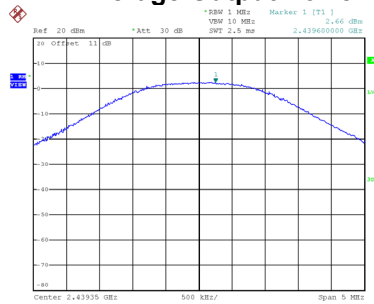

Date: 12_MAY_2021 16:04:17

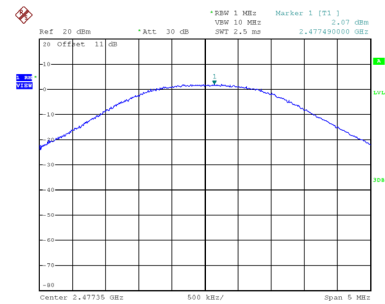

Date: 12_MAY_2021 16:03:51

End of Test Report