

FCC Radio Test Report

FCC ID: RWO-RC30035302

This report concerns: **Class II Permissive Change**

Project No. : 2204E024
Equipment : Wireless Keyboard
Brand Name : RAZER
Test Model : RZ03-0437
Series Model : RZ03-0437XXXX-XXXX (X can be 0-9 or A-Z)
Applicant : Razer Inc.
Address : 9 Pasteur, Suite 100, Irvine, CA92618, USA
Manufacturer : Razer (Asia-Pacific) Pte.,Ltd.
Address : 1 one-north Crescent, #02-01 Singapore 138538
Factory : RAZER TECHNOLOGY AND DEVELOPMENT (SHENZHEN) CO., LTD
Address : East Wing, 3rd Floor, Block 2, Phase 1 of Vision Shenzhen Business Park
Keji South Road, Hi-Tech Industrial Park, Shenzhen 518057, China
Date of Receipt : Apr. 27, 2022
Date of Test : Apr. 29, 2022 ~ May 19, 2022
Issued Date : Jun. 14, 2022
Report Version : R00
Test Sample : Sample No.: DG2022042886 for radiated and AC power line conducted
Emissions, DG2022042884 for output power.
Standard(s) : FCC CFR Title 47, Part 15, Subpart C
FCC KDB 558074 D01 15.247 Meas Guidance v05r02
ANSI C63.10-2013

The above equipment has been tested and found compliance with the requirement of the relative standards by BTL Inc.

Evan Yang

Prepared by : Evan Yang

Chay. Cai

Approved by : Chay Cai



TESTING CERT #5123.02

Add: No. 3 Jinshagang 1st Rd. Shixia, Dalang Town Dongguan City, Guangdong 523792

People's Republic of China

Tel: +86-769-8318-3000

Web: www.newbtl.com

Declaration

BTL represents to the client that testing is done in accordance with standard procedures as applicable and that test instruments used has been calibrated with standards traceable to international standard(s) and/or national standard(s).

BTL's reports apply only to the specific samples tested under conditions. It is manufacture's responsibility to ensure that additional production units of this model are manufactured with the identical electrical and mechanical components. **BTL** shall have no liability for any declarations, inferences or generalizations drawn by the client or others from **BTL** issued reports.

The report must not be used by the client to claim product certification, approval, or endorsement by NVLAP, NIST, A2LA, or any agency of the U.S. Government.

This report is the confidential property of the client. As a mutual protection to the clients, the public and ourselves, the test report shall not be reproduced, except in full, without our written approval.

BTL's laboratory quality assurance procedures are in compliance with the **ISO/IEC 17025** requirements, and accredited by the conformity assessment authorities listed in this test report.

BTL is not responsible for the sampling stage, so the results only apply to the sample as received.

The information, data and test plan are provided by manufacturer which may affect the validity of results, so it is manufacturer's responsibility to ensure that the apparatus meets the essential requirements of applied standards and in all the possible configurations as representative of its intended use.

Limitation

For the use of the authority's logo is limited unless the Test Standard(s)/Scope(s)/Item(s) mentioned in this test report is (are) included in the conformity assessment authorities acceptance respective.

Please note that the measurement uncertainty is provided for informational purpose only and are not use in determining the Pass/Fail results.

Table of Contents	Page
REPORT ISSUED HISTORY	5
1 . SUMMARY OF TEST RESULTS	6
1.1 TEST FACILITY	7
1.2 MEASUREMENT UNCERTAINTY	7
1.3 TEST ENVIRONMENT CONDITIONS	8
2 . GENERAL INFORMATION	9
2.1 GENERAL DESCRIPTION OF EUT	9
2.2 DESCRIPTION OF TEST MODES	11
2.3 PARAMETERS OF TEST SOFTWARE	12
2.4 BLOCK DIAGRAM SHOWING THE CONFIGURATION OF SYSTEM TESTED	13
2.5 SUPPORT UNITS	13
3 . AC POWER LINE CONDUCTED EMISSIONS TEST	14
3.1 LIMIT	14
3.2 TEST PROCEDURE	14
3.3 DEVIATION FROM TEST STANDARD	14
3.4 TEST SETUP	15
3.5 EUT OPERATING CONDITIONS	15
3.6 TEST RESULTS	15
4 . RADIATED EMISSION TEST	16
4.1 LIMIT	16
4.2 TEST PROCEDURE	17
4.3 DEVIATION FROM TEST STANDARD	17
4.4 TEST SETUP	18
4.5 EUT OPERATING CONDITIONS	19
4.6 TEST RESULT - 9 KHZ TO 30 MHZ	19
4.7 TEST RESULT - 30 MHZ TO 1000 MHZ	19
4.8 TEST RESULT - ABOVE 1000 MHZ	19
5 . MAXIMUM OUTPUT POWER	20
5.1 LIMIT	20
5.2 TEST PROCEDURE	20
5.3 DEVIATION FROM STANDARD	20
5.4 TEST SETUP	20

Table of Contents	Page
5.5 EUT OPERATION CONDITIONS	20
5.6 TEST RESULTS	20
6 . MEASUREMENT INSTRUMENTS LIST	21
APPENDIX A - AC POWER LINE CONDUCTED EMISSIONS	23
APPENDIX B - RADIATED EMISSION - 9 KHZ TO 30 MHZ	26
APPENDIX C - RADIATED EMISSION - 30 MHZ TO 1000 MHZ	31
APPENDIX D - RADIATED EMISSION - ABOVE 1000 MHZ	34
APPENDIX E - MAXIMUM OUTPUT POWER	59

REPORT ISSUED HISTORY

Report No.	Version	Description	Issued Date	Note
BTL-FCCP-1-2204E024	R00	Original Report.	Jun. 14, 2022	Valid

1. SUMMARY OF TEST RESULTS

Test procedures according to the technical standard(s):

FCC CFR Title 47, Part 15, Subpart C				
Standard(s) Section	Test Item	Test Result	Judgment	Remark
15.207	AC Power Line Conducted Emissions	APPENDIX A	PASS	-----
15.247(d) 15.205(a) 15.209(a)	Radiated Emissions	APPENDIX B APPENDIX C APPENDIX D	PASS	-----
15.247(a)(2)	Bandwidth	-----	PASS	-----
15.247(b)(3)	Maximum Output Power	APPENDIX E	PASS	-----
15.247(d)	Conducted Spurious Emission	-----	PASS	-----
15.247(e)	Power Spectral Density	-----	PASS	-----
15.203	Antenna Requirement	-----	PASS	Note(2)

Note:

- (1) "N/A" denotes test is not applicable to this device.
- (2) The device what use a permanently attached antenna were considered sufficient to comply with the provisions of 15.203.
- (3) The RF module of this Wireless Keyboard has been tested and certified. Please refer to the module report as listed in the below table for the test results of the RF module.

RF Module Model	Module Function	Report Number	Standard
RC30-035302	Bluetooth LE	BTL-FCCP-1-2005C131	FCC Part15, Subpart C (15.247) ANSI C63.10-2013
	2.4G SRD	BTL-FCCP-2-2005C131	

Thus, the AC Power Line Conducted Emissions, radiated spurious emissions and output power were evaluated and recorded in this report. For the test results of all other test items please refer to above module test report.

1.1 TEST FACILITY

The test facilities used to collect the test data in this report is at the location of No. 3 Jinshagang 1st Rd. Shixia, Dalang Town Dongguan City, Guangdong 523792 People's Republic of China.

BTL's Registration Number for FCC: 357015

BTL's Designation Number for FCC: CN1240

1.2 MEASUREMENT UNCERTAINTY

ISO/IEC 17025 requires that an estimate of the measurement uncertainties associated with the emissions test results be included in the report. The measurement uncertainties given below are based on a 95% confidence level (based on a coverage factor (k=2))

The BTL measurement uncertainty as below table:

A. AC power line conducted emissions Measurement:

Test Site	Method	Measurement Frequency Range	U, (dB)
DG-C02	CISPR	150kHz ~ 30MHz	2.60

B. Radiated emissions Measurement:

Test Site	Method	Measurement Frequency Range	U,(dB)
DG-CB01	CISPR	9kHz ~ 30MHz	2.36

Test Site	Method	Measurement Frequency Range	Ant. H / V	U,(dB)
DG-CB03 (3m)	CISPR	30MHz ~ 200MHz	V	4.36
		30MHz ~ 200MHz	H	3.32
		200MHz ~ 1,000MHz	V	4.08
		200MHz ~ 1,000MHz	H	3.96

Test Site	Method	Measurement Frequency Range	U,(dB)
DG-CB03 (3m)	CISPR	1GHz ~ 6GHz	3.80
		6GHz ~ 18GHz	4.82

Test Site	Method	Measurement Frequency Range	U,(dB)
DG-CB03 (1m)	CISPR	18 ~ 26.5 GHz	3.62
		26.5 ~ 40 GHz	4.00

C. Other Measurement:

Test Item	Uncertainty
Maximum Output Power	±0.95 dB
Temperature	±0.08 °C
Humidity	±1.5%

Note: Unless specifically mentioned, the uncertainty of measurement has not been taken into account to declare the compliance or non-compliance to the specification.

1.3 TEST ENVIRONMENT CONDITIONS

Test Item	Temperature	Humidity	Test Voltage	Tested By
AC Power Line Conducted Emissions	25°C	58%	AC 120V/60Hz	Rod Tang
Radiated Emissions-9K-30MHz	19°C	59%	DC 5V	Chelito Chen
Radiated Emissions-30 MHz to 1GHz	24°C	54%	DC 5V	Meers Zhang
Radiated Emissions-Above 1000 MHz	25°C	55%	DC 5V	Meers Zhang
Maximum Output Power	24°C	52%	DC 5V	Nicole Chen

2. GENERAL INFORMATION

2.1 GENERAL DESCRIPTION OF EUT

Equipment	Wireless Keyboard
Brand Name	RAZER
Test Model	RZ03-0437
Series Model	RZ03-0437XXXX-XXXX (X can be 0-9 or A-Z)
Model Difference(s)	The system's model name is RZ03-0437XXXX-XXXX (X can be 0-9 or A-Z), and the system contains a Wireless Keyboard (Model name: RZ03-0437) and USB Dongle (Model name: DGRFG7).
Power Source	1# Supplied from PC USB port. 2# Supplied from battery. Model: FT5936E2P
Power Rating	1# 5V --- 2.0A 2# DC 3.7V 4200mAh, 15.54Wh
Operation Frequency	2402 MHz ~ 2480 MHz
Modulation Technology	GFSK
Bit Rate of Transmitter	1Mbps, 2Mbps
Max. Output Power	3.25 dBm (0.0021W) For 1Mbps 3.27 dBm (0.0021W) For 2Mbps

Note:

1. For a more detailed features description, please refer to the manufacturer's specifications or the user's manual.

2. Channel List:

Channel	Frequency (MHz)	Channel	Frequency (MHz)
00	2402	20	2442
01	2404	21	2444
02	2406	22	2446
03	2408	23	2448
04	2410	24	2450
05	2412	25	2452
06	2414	26	2454
07	2416	27	2456
08	2418	28	2458
09	2420	29	2460
10	2422	30	2462
11	2424	31	2464
12	2426	32	2466
13	2428	33	2468
14	2430	34	2470
15	2432	35	2472
16	2434	36	2474
17	2436	37	2476
18	2438	38	2478
19	2440	39	2480

3. Table for Filed Antenna:

Ant.	Brand	P/N	Antenna Type	Connector	Gain (dBi)
1	 INPAQ <small>INPAQ TECHNOLOGY CO., LTD</small>	RFPCA301319IMAB301	PCB	N/A	3.58

Note: The antenna gain is provided by the manufacturer.

2.2 DESCRIPTION OF TEST MODES

The test system was pre-tested based on the consideration of all possible combinations of EUT operation mode.

Pretest Mode	Description
Mode 1	TX Mode_1Mbps Channel 00/19/39
Mode 2	TX Mode_2Mbps Channel 00/19/39
Mode 3	TX Mode_2Mbps Channel 39

Following mode(s) was (were) found to be the worst case(s) and selected for the final test.

AC power line conducted emissions test	
Final Test Mode	Description
Mode 3	TX Mode_2Mbps Channel 39

Radiated emissions test - Below 1GHz	
Final Test Mode	Description
Mode 3	TX Mode_2Mbps Channel 39

Radiated emissions test - Above 1GHz	
Final Test Mode	Description
Mode 1	TX Mode_1Mbps Channel 00/19/39
Mode 2	TX Mode_2Mbps Channel 00/19/39

Maximum Output Power test	
Final Test Mode	Description
Mode 1	TX Mode_1Mbps Channel 00/19/39
Mode 2	TX Mode_2Mbps Channel 00/19/39

Note:

- (1) For radiated emission above 1 GHz test, the spurious points of 1GHz~26.5GHz have been pre-tested and in this report only recorded the worst case. The remaining spurious points are all below the limit value of 20dB.
- (2) For AC power line conducted emissions and radiated emissions below 1 GHz test, the 2Mbps channel 39 is found to be the worst case and recorded.
- (3) There are three versions of this product, namely 84 key, 85 key, 88 key and each version has two colors. All versions are evaluated and the worst case is recorded in this report.

2.3 PARAMETERS OF TEST SOFTWARE

During testing channel & power controlling software provided by the customer was used to control the operating channel as well as the output power level.

Test Software	FCCMTKTest_v0.00.02_20200109		
Frequency (MHz)	2402	2440	2480
1Mbps	2	2	2
2Mbps	2	2	2

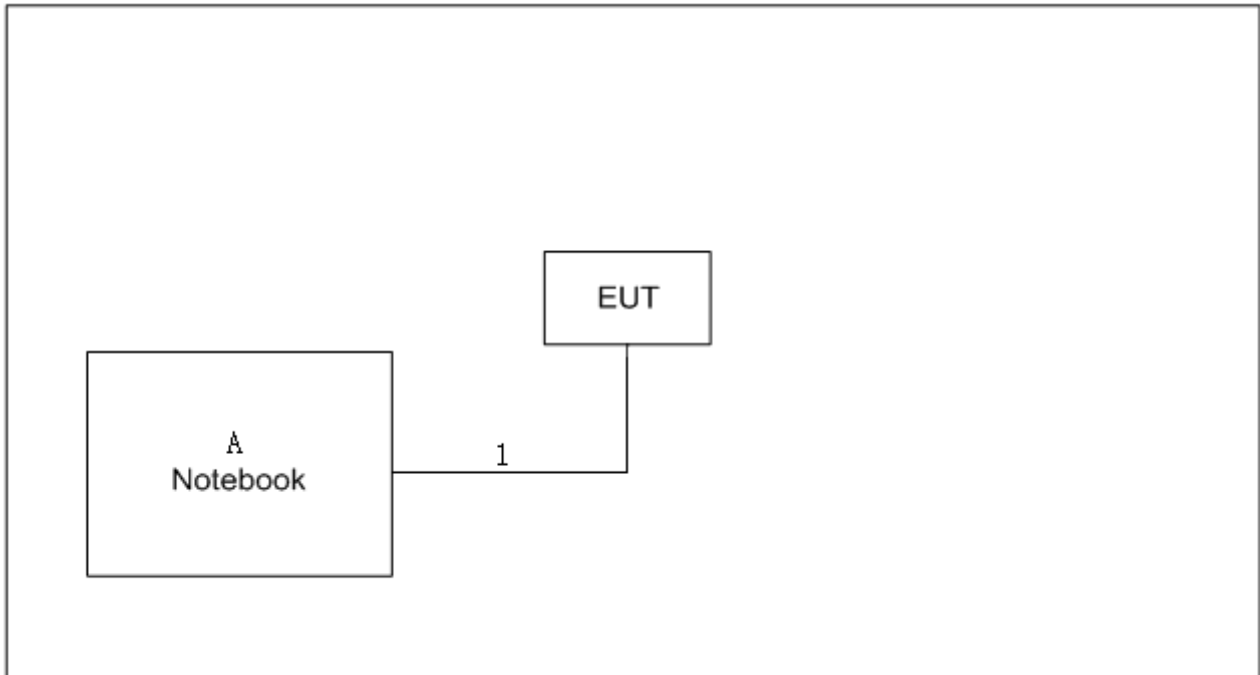
2.4 BLOCK DIAGRAM SHOWING THE CONFIGURATION OF SYSTEM TESTED**2.5 SUPPORT UNITS**

Item	Equipment	Brand	Model No.	Series No.
A	Notebook	Honor	14SER5 3500	N/A

Item	Cable Type	Shielded Type	Ferrite Core	Length
1	USB Type-C Cable	NO	NO	1.5m

3. AC POWER LINE CONDUCTED EMISSIONS TEST

3.1 LIMIT

Frequency of Emission (MHz)	Limit (dB μ V)	
	Quasi-peak	Average
0.15 - 0.50	66 to 56*	56 to 46*
0.50 - 5.0	56	46
5.0 - 30.0	60	50

Note:

- (1) The tighter limit applies at the band edges.
- (2) The limit of " * " marked band means the limitation decreases linearly with the logarithm of the frequency in the range.

The following table is the setting of the receiver

Receiver Parameters	Setting
Attenuation	10 dB
Start Frequency	0.15 MHz
Stop Frequency	30 MHz
IF Bandwidth	9 kHz

3.2 TEST PROCEDURE

- a. The EUT was placed 0.8 meters from the horizontal ground plane with EUT being connected to the power mains through a line impedance stabilization network (LISN). All other support equipment powered from additional LISN(s). The LISN provide 50 Ohm/ 50uH of coupling impedance for the measuring instrument.
- b. Interconnecting cables that hang closer than 40 cm to the ground plane shall be folded back and forth in the center forming a bundle 30 to 40 cm long.
- c. I/O cables that are not connected to a peripheral shall be bundled in the center. The end of the cable may be terminated, if required, using the correct terminating impedance. The overall length shall not exceed 1 m.
- d. LISN at least 80 cm from nearest part of EUT chassis.
- e. For the actual test configuration, please refer to the related Item –EUT Test Photos.

3.3 DEVIATION FROM TEST STANDARD

No deviation

3.4 TEST SETUP

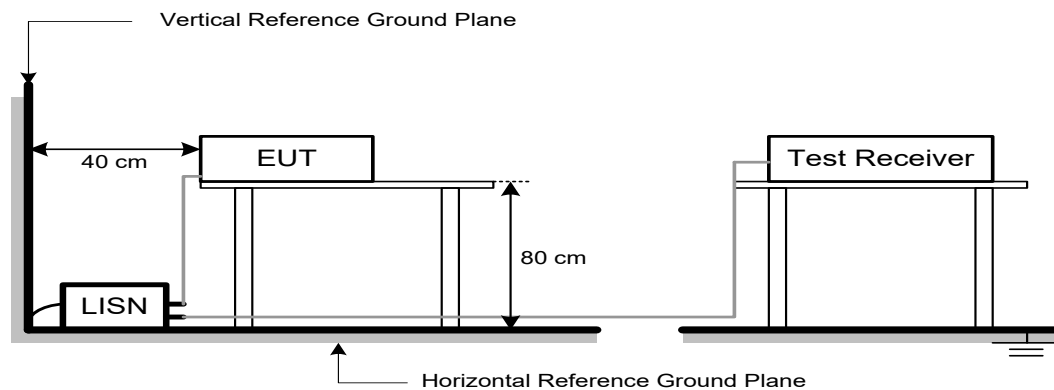

3.5 EUT OPERATING CONDITIONS

The EUT was configured for testing in a typical fashion (as a customer would normally use it). The EUT has been programmed to continuously transmit during test. This operating condition was tested and used to collect the included data.

3.6 TEST RESULTS

Please refer to the APPENDIX A.

Remark:

- (1) All readings are QP Mode value unless otherwise stated AVG in column of 『Note』 . If the QP Mode Measured value compliance with the QP Limits and lower than AVG Limits, the EUT shall be deemed to meet both QP & AVG Limits and then only QP Mode was measured, but AVG Mode didn't perform. In this case, a “ * ” marked in AVG Mode column of Interference Voltage Measured.
- (2) Measuring frequency range from 150 kHz to 30 MHz.

4. RADIATED EMISSION TEST

4.1 LIMIT

In case the emission fall within the restricted band specified on 15.205(a), then the 15.209(a) limit in the table below has to be followed.

LIMITS OF RADIATED EMISSION MEASUREMENT (9 kHz-1000 MHz)

Frequency (MHz)	Field Strength (microvolts/meter)	Measurement Distance (meters)
0.009-0.490	2400/F(kHz)	300
0.490-1.705	24000/F(kHz)	30
1.705-30.0	30	30
30-88	100	3
88-216	150	3
216-960	200	3
Above 960	500	3

LIMITS OF RADIATED EMISSION MEASUREMENT (Above 1000 MHz)

Frequency (MHz)	(dBuV/m at 3 m)	
	Peak	Average
Above 1000	74	54

Note:

- (1) The limit for radiated test was performed according to FCC CFR Title 47, Part 15, Subpart C.
- (2) The tighter limit applies at the band edges.
- (3) Emission level (dBuV/m)=20log Emission level (uV/m).

Spectrum Parameter	Setting
Attenuation	Auto
Start Frequency	1000 MHz
Stop Frequency	10th carrier harmonic
RBW / VBW (Emission in restricted band)	RBW 1 MHz VBW 3 MHz peak detector for Pk value RMS detector for AV value

Receiver Parameter	Setting
Attenuation	Auto
Start ~ Stop Frequency	9 kHz~90 kHz for PK/AVG detector
Start ~ Stop Frequency	90 kHz~110 kHz for QP detector
Start ~ Stop Frequency	110 kHz~490 kHz for PK/AVG detector
Start ~ Stop Frequency	490 kHz~30 MHz for QP detector
Start ~ Stop Frequency	30 MHz~1000 MHz for QP detector

4.2 TEST PROCEDURE

- a. The measuring distance of 3 m shall be used for measurements. The EUT was placed on the top of a rotating table 0.8 meter above the ground at a 3 meter semi-anechoic chamber. The table was rotated 360 degrees to determine the position of the highest radiation.(below 1 GHz)
- b. The measuring distance of 3 m shall be used for measurements. The EUT was placed on the top of a rotating table 1.5 meter above the ground at a 3 meter semi-anechoic chamber. The table was rotated 360 degrees to determine the position of the highest radiation.(above 1 GHz)
- c. The height of the equipment or of the substitution antenna shall be 0.8m or 1.5m; the height of the test antenna shall vary between 1 m to 4 m. Both horizontal and vertical polarizations of the antenna are set to make the measurement.
- d. For each suspected emission, the EUT was arranged to its worst case and then the antenna was tuned to heights find the maximum reading (used Bore sight function).
- e. The receiver system was set to peak and average detect function and specified bandwidth with maximum hold mode when the test frequency is above 1 GHz.
- f. The initial step in collecting radiated emission data is a receiver peak detector mode pre-scanning the measurement frequency range. Significant peaks are then marked and then Quasi Peak detector mode re-measured.
- g. All readings are Peak unless otherwise stated QP in column of Note. Peak denotes that the Peak reading compliance with the QP Limits and then QP Mode measurement didn't perform.
(below 1 GHz)
- h. All readings are Peak Mode value unless otherwise stated AVG in column of Note. If the Peak Mode Measured value compliance with the Peak Limits and lower than AVG Limits, the EUT shall be deemed to meet both Peak & AVG Limits and then only Peak Mode was measured, but AVG Mode didn't perform. (above 1 GHz)
- i. For the actual test configuration, please refer to the related Item –EUT Test Photos.

4.3 DEVIATION FROM TEST STANDARD

No deviation

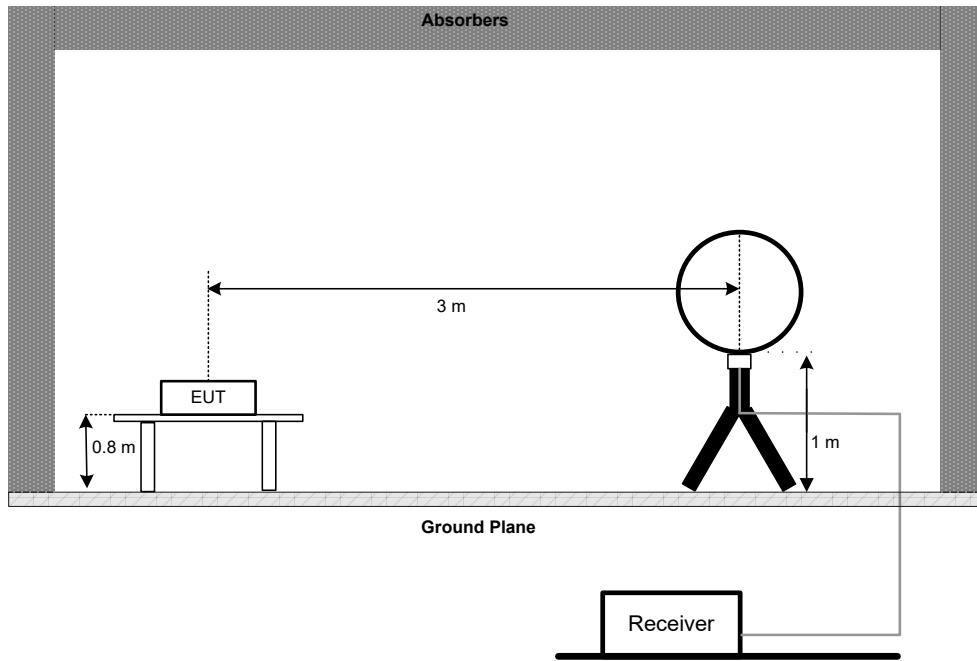
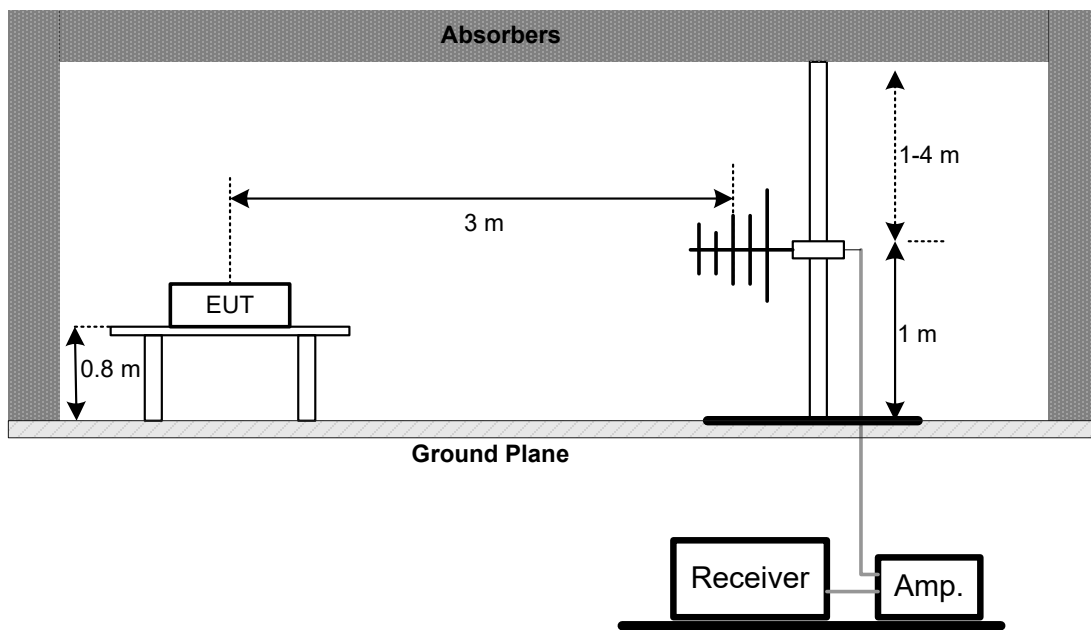
4.4 TEST SETUP**9 kHz-30 MHz****30 MHz to 1 GHz**

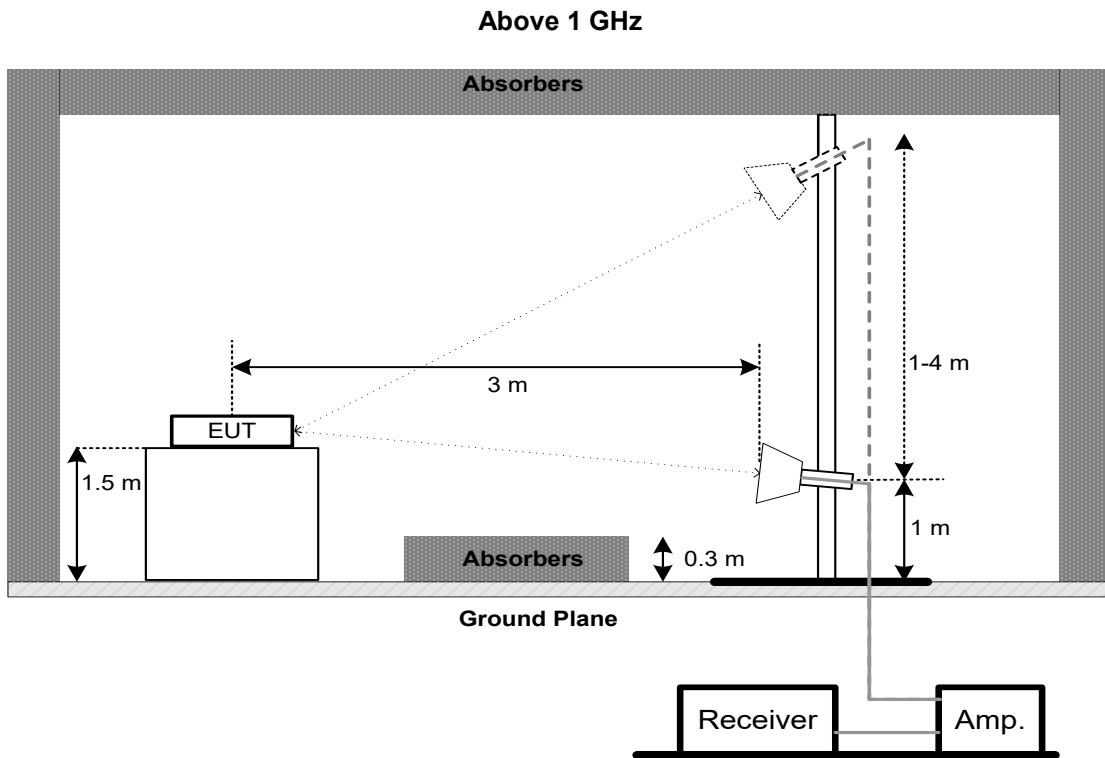

4.5 EUT OPERATING CONDITIONS

The EUT was programmed to be in continuously transmitting mode.

4.6 TEST RESULT - 9 kHz TO 30 MHz

Please refer to the APPENDIX B

Remark:

- (1) Distance extrapolation factor = $40 \log(\text{specific distance} / \text{test distance})$ (dB).
- (2) Limit line = specific limits (dBuV) + distance extrapolation factor.

4.7 TEST RESULT - 30 MHz TO 1000 MHz

Please refer to the APPENDIX C.

4.8 TEST RESULT - ABOVE 1000 MHz

Please refer to the APPENDIX D.

Remark:

- (1) No limit: This is fundamental signal, the judgment is not applicable.
For fundamental signal judgment was referred to Peak output test.

5. MAXIMUM OUTPUT POWER

5.1 LIMIT

Section	Test Item	Limit
FCC 15.247(b)(3)	Maximum Output Power	1.0000 watt or 30.00 dBm

5.2 TEST PROCEDURE

- a. The EUT was directly connected to the spectrum analyzer and antenna output port as show in the block diagram below.
- b. The following table is the setting of the spectrum analyzer:

Spectrum Parameters	Setting
Span Frequency	$\geq 3 \times \text{RBW}$
RBW	3 MHz
VBW	3 MHz
Detector	Peak
Trace	Max Hold
Sweep Time	Auto

Note: Where T is defined in 11.6 of ANSI C63.10-2013.

5.3 DEVIATION FROM STANDARD

No deviation.

5.4 TEST SETUP



5.5 EUT OPERATION CONDITIONS

The EUT was programmed to be in continuously transmitting mode.

5.6 TEST RESULTS

Please refer to the APPENDIX E.

6. MEASUREMENT INSTRUMENTS LIST

AC Power Line Conducted Emissions					
Item	Kind of Equipment	Manufacturer	Type No.	Serial No.	Calibrated until
1	EMI Test Receiver	R&S	ESCI	100382	Jan. 22, 2023
2	LISN	EMCO	3816/2	52765	Jan. 23, 2023
3	TWO-LINE V-NETWORK	R&S	ENV216	101447	Jan. 23, 2023
4	50Ω Terminator	SHX	TF5-3	15041305	N/A
5	Measurement Software	Farad	EZ-EMC Ver.NB-03A1-01	N/A	N/A
6	Cable	N/A	RG223	12m	Mar. 08, 2023
7	643 Shield Room	ETS	6*4*3	N/A	N/A

Radiated Emissions - 9 kHz to 30 MHz					
Item	Kind of Equipment	Manufacturer	Type No.	Serial No.	Calibrated until
1	MXE EMI Receiver	Keysight	N9038A	MY56400091	Jan. 22, 2023
2*	Active Loop Antenna	R&S	HFH2-Z2	830749/020	Aug. 23, 2024
3	Cable	N/A	RG 213/U(9kHz~1GHz)	N/A	May 27, 2022
4	Measurement Software	Farad	EZ-EMC Ver.NB-03A1-01	N/A	N/A
5	966 Chamber Room	ETS	9*6*6	N/A	Jul. 17, 2022

Radiated Emissions - 30 MHz to 1 GHz					
Item	Kind of Equipment	Manufacturer	Type No.	Serial No.	Calibrated until
1	Antenna	Schwarzbeck	VULB9160	9160-3232	Mar. 03, 2023
2	Amplifier	HP	8447D	2944A08742	Jan. 22, 2023
3	Cable	emci	LMR-400	N/A	Nov. 30, 2022
4	Controller	CT	SC100	N/A	N/A
5	Controller	MF	MF-7802	MF780208416	N/A
6	Receiver	Agilent	N9038A	MY52130039	Jan. 22, 2023
7	Measurement Software	Farad	EZ-EMC Ver.NB-03A1-01	N/A	N/A
8	966 Chamber Room	RM	9*6*6	N/A	Jul. 24, 2022

Radiated Emissions - Above 1 GHz					
Item	Kind of Equipment	Manufacturer	Type No.	Serial No.	Calibrated until
1	Double Ridged Horn Antenna	ARA	DRG-118A	16554	Apr. 18, 2023
2	Broad-Band Horn Antenna	Schwarzbeck	BBHA 9170	9170319	Jun. 30, 2022
3	Amplifier	Agilent	8449B	3008A02584	Jul. 10, 2022
4	Controller	CT	SC100	N/A	N/A
5	Controller	MF	MF-7802	MF780208416	N/A
6	Receiver	Agilent	N9038A	MY52130039	Jan. 22, 2023
7	EXA Spectrum Analyzer	Keysight	N9010A	MY56480488	Jan. 22, 2023
8	Low Noise Amplifier	CONNPHY	CLN-18G40G-4330-K	619413	Jul. 16, 2022
9	Cable	Talent microwave	A81-SMAMSMAM-12.5M	N/A	Oct. 15, 2022
10	Cable	Talent microwave	A40-2.92M2.92M-2.5M	N/A	Nov. 30, 2022
11	Filter	STI	STI15-9912	N/A	Jul. 10, 2022
12	Measurement Software	Farad	EZ-EMC Ver.NB-03A1-01	N/A	N/A
13	966 Chamber Room	RM	9*6*6	N/A	Jul. 24, 2022

Maximum Output Power					
Item	Kind of Equipment	Manufacturer	Type No.	Serial No.	Calibrated until
1	Spectrum Analyzer	R&S	FSP40	100185	Jul. 10, 2022
2	Attenuator	WOKEN	6SM3502	VAS1214NL	N/A
3	RF Cable	Tongkaichuan	N/A	N/A	N/A
4	DC Block	Mini	N/A	N/A	N/A

Remark: "N/A" denotes no model name, serial no. or calibration specified.

"*" calibration period of equipment list is three year.

Except * item, all calibration period of equipment list is one year.

APPENDIX A - AC POWER LINE CONDUCTED EMISSIONS

Test Mode	TX Mode Channel 39_2Mbps	Phase	Line
-----------	--------------------------	-------	------

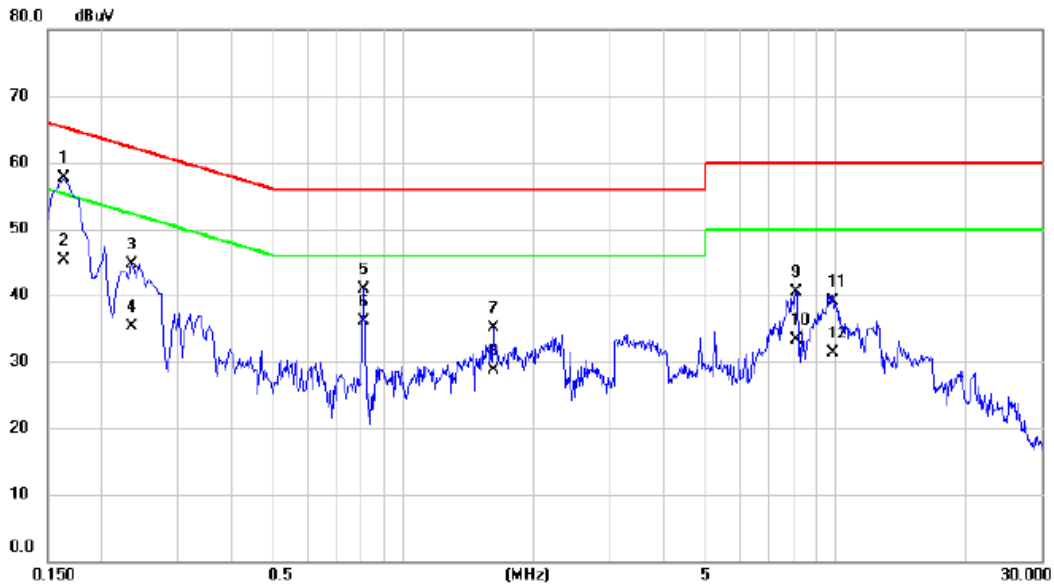

No. Mk.	Freq. MHz	Reading Level dBuV	Correct Factor dB	Measurement dBuV	Limit dBuV	Margin dB	Detector	Comment
1 *	0.1635	48.09	9.67	57.76	65.28	-7.52	QP	
2	0.1635	35.60	9.67	45.27	55.28	-10.01	AVG	
3	0.2355	35.07	9.70	44.77	62.25	-17.48	QP	
4	0.2355	25.60	9.70	35.30	52.25	-16.95	AVG	
5	0.8115	31.20	9.80	41.00	56.00	-15.00	QP	
6	0.8115	26.40	9.80	36.20	46.00	-9.80	AVG	
7	1.6170	25.22	9.86	35.08	56.00	-20.92	QP	
8	1.6170	18.90	9.86	28.76	46.00	-17.24	AVG	
9	8.0834	30.14	10.36	40.50	60.00	-19.50	QP	
10	8.0834	22.90	10.36	33.26	50.00	-16.74	AVG	
11	9.8880	28.54	10.48	39.02	60.00	-20.98	QP	
12	9.8880	20.80	10.48	31.28	50.00	-18.72	AVG	

REMARKS:

- (1) Measurement Value = Reading Level + Correct Factor.
- (2) Margin Level = Measurement Value - Limit Value.

Test Mode	TX Mode Channel 39_2Mbps	Phase	Neutral
-----------	--------------------------	-------	---------

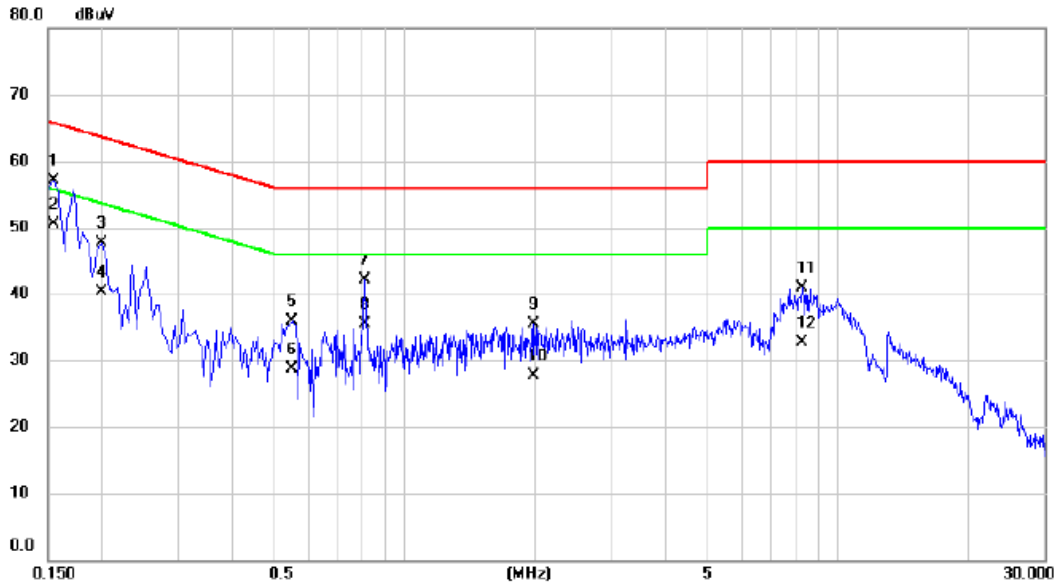

No.	Mk.	Freq. MHz	Reading Level dBuV	Correct Factor dB	Measure- ment dBuV	Limit dBuV	Margin dB	Detector	Comment
1		0.1544	47.48	9.71	57.19	65.76	-8.57	QP	
2	*	0.1544	40.80	9.71	50.51	55.76	-5.25	AVG	
3		0.1995	37.96	9.73	47.69	63.63	-15.94	QP	
4		0.1995	30.60	9.73	40.33	53.63	-13.30	AVG	
5		0.5503	26.00	9.81	35.81	56.00	-20.19	QP	
6		0.5503	18.90	9.81	28.71	46.00	-17.29	AVG	
7		0.8070	32.24	9.83	42.07	56.00	-13.93	QP	
8		0.8070	25.60	9.83	35.43	46.00	-10.57	AVG	
9		1.9770	25.56	9.92	35.48	56.00	-20.52	QP	
10		1.9770	17.80	9.92	27.72	46.00	-18.28	AVG	
11		8.2680	30.61	10.39	41.00	60.00	-19.00	QP	
12		8.2680	22.40	10.39	32.79	50.00	-17.21	AVG	

REMARKS:

- (1) Measurement Value = Reading Level + Correct Factor.
- (2) Margin Level = Measurement Value - Limit Value.

APPENDIX B - RADIATED EMISSION - 9 KHZ TO 30 MHZ

Test Mode:	TX Mode Channel 39 _2Mbps	Polarization	Ant 0°
------------	---------------------------	--------------	--------

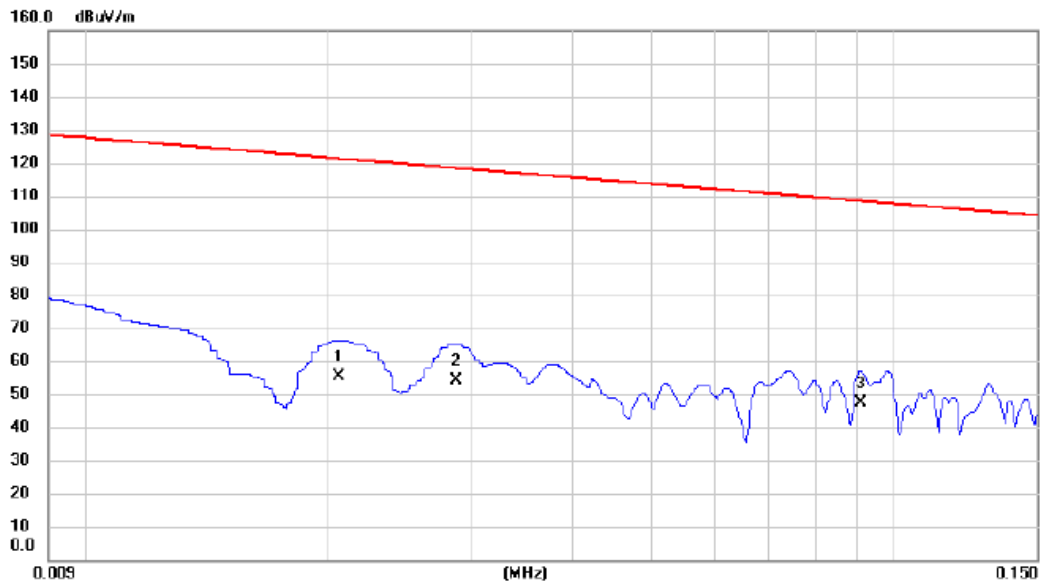

No. Mk.	Freq. MHz	Reading Level dBuV	Correct Factor dB	Measure- ment dBuV/m	Limit dBuV/m	Margin dB	Detector	Comment
1	0.0206	41.09	14.28	55.37	121.33	-65.96	AVG	
2	0.0287	40.03	14.09	54.12	118.45	-64.33	AVG	
3 *	0.0910	33.50	13.72	47.22	108.42	-61.20	AVG	

REMARKS:

- (1) Measurement Value = Reading Level + Correct Factor.
- (2) Margin Level = Measurement Value - Limit Value.

Test Mode:	TX Mode Channel 39 _2Mbps	Polarization	Ant 0°
------------	---------------------------	--------------	--------

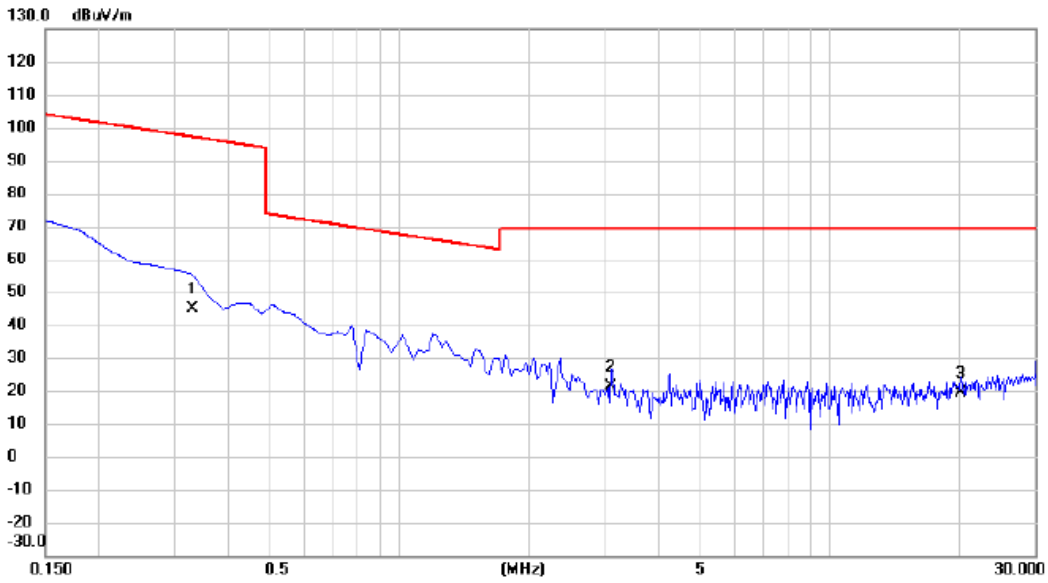

No. Mk.	Freq. MHz	Reading Level dBuV	Correct Factor dB	Measurement dBuV/m	Limit dBuV/m	Margin dB	Detector	Comment
1	0.3291	31.36	13.81	45.17	97.26	-52.09	AVG	
2 *	3.1052	9.27	12.19	21.46	69.54	-48.08	QP	
3	20.0898	6.24	13.10	19.34	69.54	-50.20	QP	

REMARKS:

- (1) Measurement Value = Reading Level + Correct Factor.
- (2) Margin Level = Measurement Value - Limit Value.

Test Mode:	TX Mode Channel 39 _2Mbps	Polarization	Ant 90°
------------	---------------------------	--------------	---------

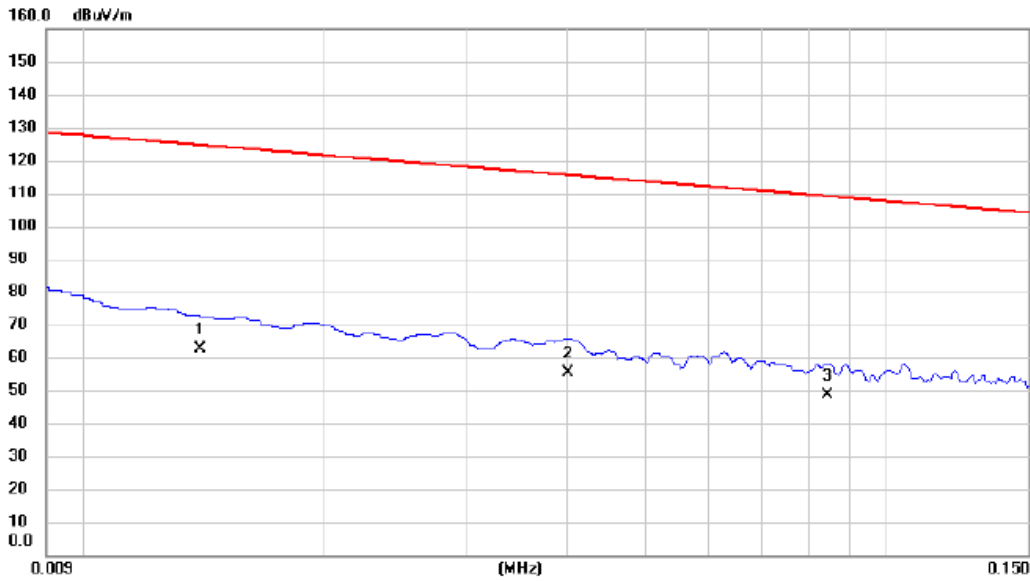

No. Mk.	Freq. MHz	Reading Level dBuV	Correct Factor dB	Measurement dBuV/m	Limit dBuV/m	Margin dB	Detector	Comment
1	0.0140	46.39	16.18	62.57	124.68	-62.11	AVG	
2 *	0.0401	41.49	13.83	55.32	115.54	-60.22	AVG	
3	0.0844	35.07	13.64	48.71	109.08	-60.37	AVG	

REMARKS:

- (1) Measurement Value = Reading Level + Correct Factor.
- (2) Margin Level = Measurement Value - Limit Value.

Test Mode:	TX Mode Channel 39 _2Mbps	Polarization	Ant 90°
------------	---------------------------	--------------	---------

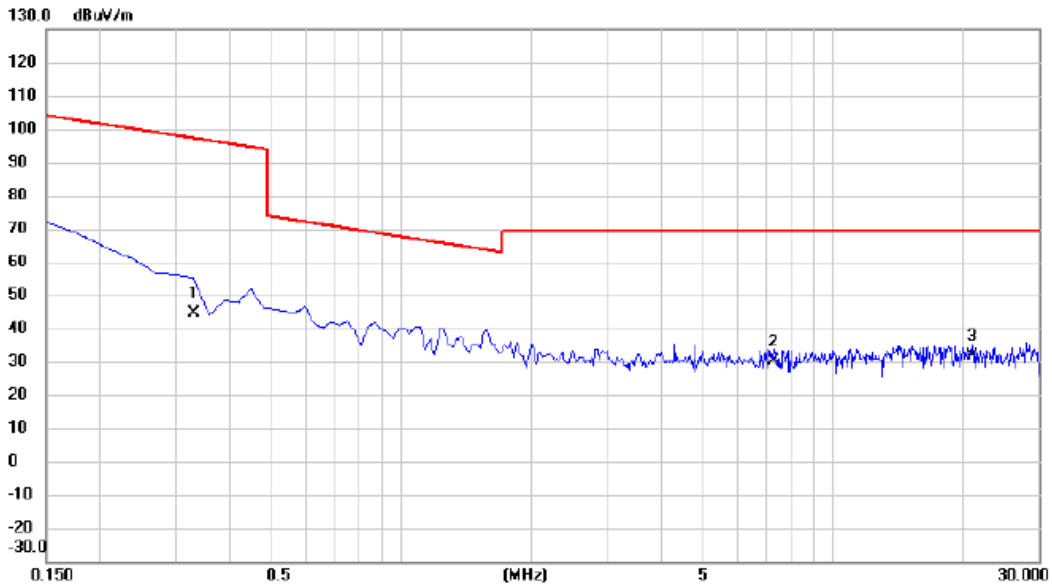

No.	Mk.	Freq. MHz	Reading Level dBuV	Correct Factor dB	Measure- ment dBuV/m	Limit dBuV/m	Margin dB	Detector	Comment
1		0.3291	30.81	13.81	44.62	97.26	-52.64	AVG	
2		7.2842	17.73	12.41	30.14	69.54	-39.40	QP	
3	*	20.9553	18.56	13.22	31.78	69.54	-37.76	QP	

REMARKS:

- (1) Measurement Value = Reading Level + Correct Factor.
- (2) Margin Level = Measurement Value - Limit Value.

APPENDIX C - RADIATED EMISSION - 30 MHZ TO 1000 MHZ

Test Mode	TX Mode Channel 39 _2Mbps	Polarization	Vertical
-----------	---------------------------	--------------	----------

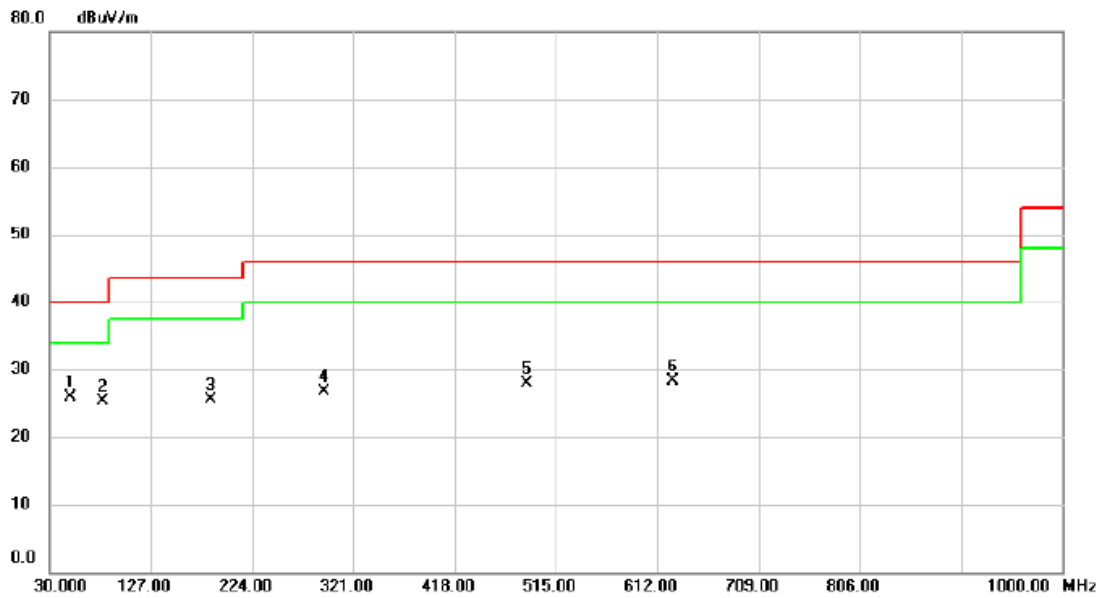

No.	Mk.	Freq. MHz	Reading Level dBuV	Correct Factor dB	Measure- ment dBuV/m	Limit dBuV/m	Margin dB	Detector	Comment
1	*	50.3700	39.66	-13.72	25.94	40.00	-14.06	peak	
2		80.4400	43.64	-18.40	25.24	40.00	-14.76	peak	
3		184.2300	39.64	-14.19	25.45	43.50	-18.05	peak	
4		292.8700	37.84	-11.13	26.71	46.00	-19.29	peak	
5		486.8700	34.69	-6.76	27.93	46.00	-18.07	peak	
6		626.5500	32.51	-4.12	28.39	46.00	-17.61	peak	

REMARKS:

- (1) Measurement Value = Reading Level + Correct Factor.
- (2) Margin Level = Measurement Value - Limit Value.

Test Mode	TX Mode Channel 39_2Mbps	Polarization	Horizontal
-----------	--------------------------	--------------	------------

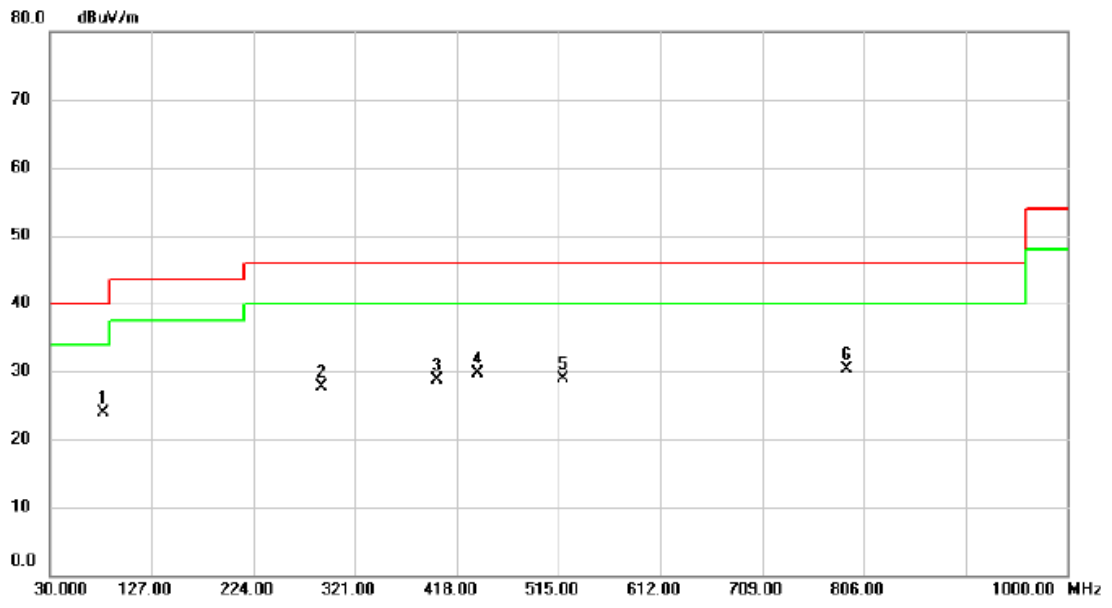

No. Mk.	Freq. MHz	Reading Level dBuV	Correct Factor dB	Measurement dBuV/m	Limit dBuV/m	Margin dB	Detector	Comment
1	80.4400	42.28	-18.40	23.88	40.00	-16.12	peak	
2	289.9600	38.94	-11.22	27.72	46.00	-18.28	peak	
3	399.5700	37.46	-8.78	28.68	46.00	-17.32	peak	
4	438.3700	37.50	-7.73	29.77	46.00	-16.23	peak	
5	518.8800	35.26	-6.30	28.96	46.00	-17.04	peak	
6 *	789.5100	31.24	-0.95	30.29	46.00	-15.71	peak	

REMARKS:
 (1) Measurement Value = Reading Level + Correct Factor.
 (2) Margin Level = Measurement Value - Limit Value.

APPENDIX D - RADIATED EMISSION - ABOVE 1000 MHZ

Test Mode	TX 2402 MHz_CH00_1Mbps	Polarization	Vertical
-----------	------------------------	--------------	----------

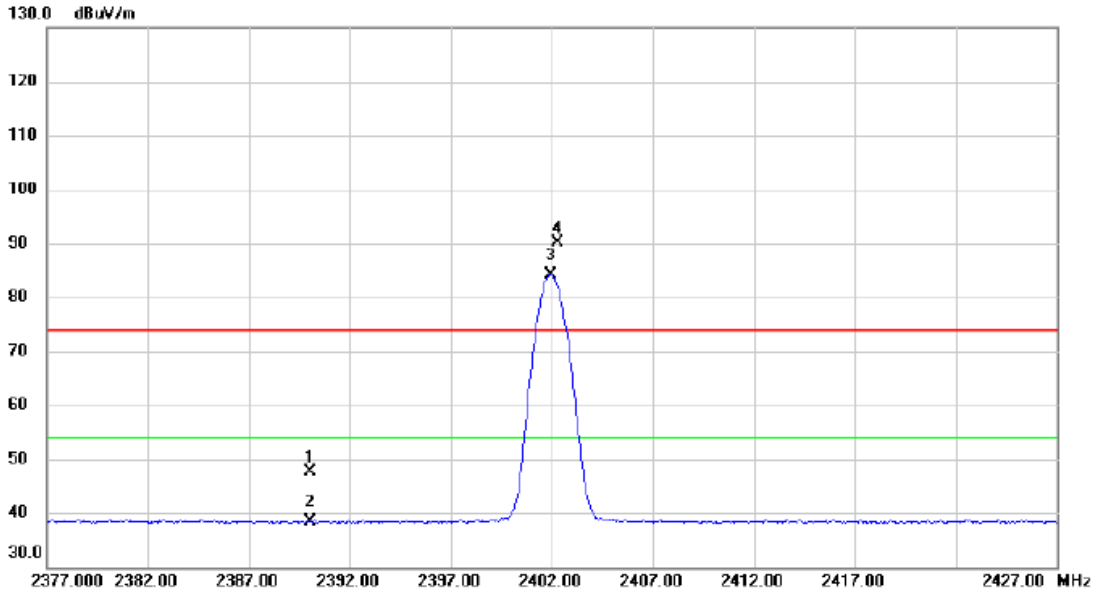

No.	Mk.	Freq.	Reading Level	Correct Factor	Measurement	Limit	Margin	Detector	Comment
		MHz	dBuV	dB	dBuV/m	dBuV/m	dB		
1		2390.000	40.40	7.27	47.67	74.00	-26.33	peak	
2		2390.000	31.06	7.27	38.33	54.00	-15.67	AVG	
3	*	2401.950	76.97	7.28	84.25	54.00	30.25	AVG	No Limit
4	X	2402.300	82.76	7.28	90.04	74.00	16.04	peak	No Limit

REMARKS:

- (1) Measurement Value = Reading Level + Correct Factor.
- (2) Margin Level = Measurement Value - Limit Value.

Test Mode	TX 2402 MHz _CH00_1Mbps	Polarization	Vertical
-----------	-------------------------	--------------	----------

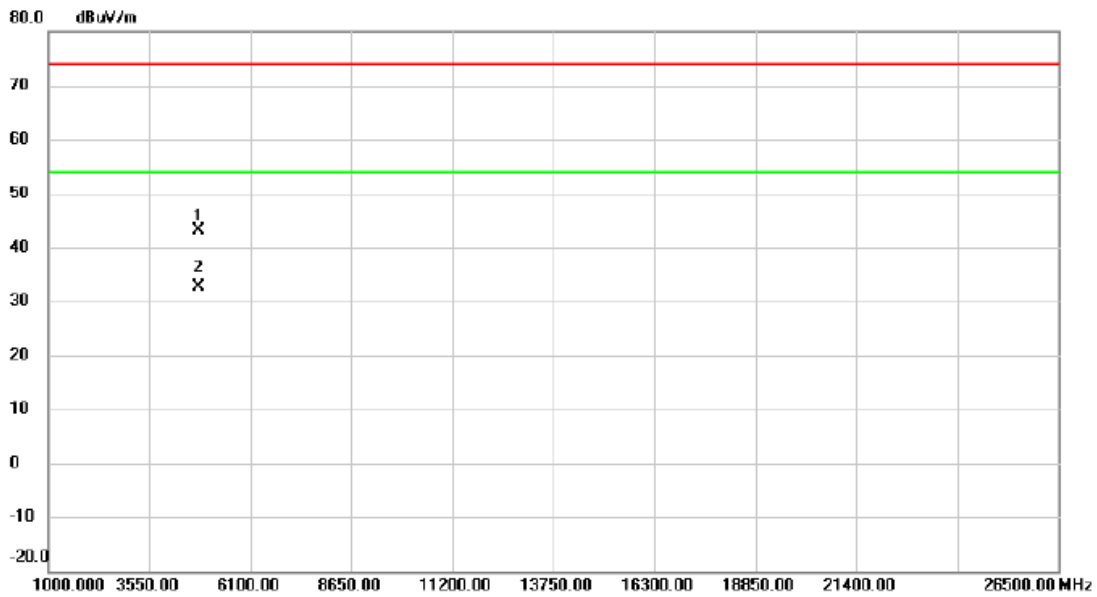

No.	Mk.	Freq. MHz	Reading Level dBuV	Correct Factor dB	Measure- ment dBuV/m	Limit dBuV/m	Margin dB	Detector	Comment
1		4803.715	38.90	4.29	43.19	74.00	-30.81	peak	
2	*	4804.385	28.41	4.30	32.71	54.00	-21.29	AVG	

REMARKS:

- (1) Measurement Value = Reading Level + Correct Factor.
- (2) Margin Level = Measurement Value - Limit Value.

Test Mode	TX 2402 MHz_CH00_1Mbps	Polarization	Horizontal
-----------	------------------------	--------------	------------

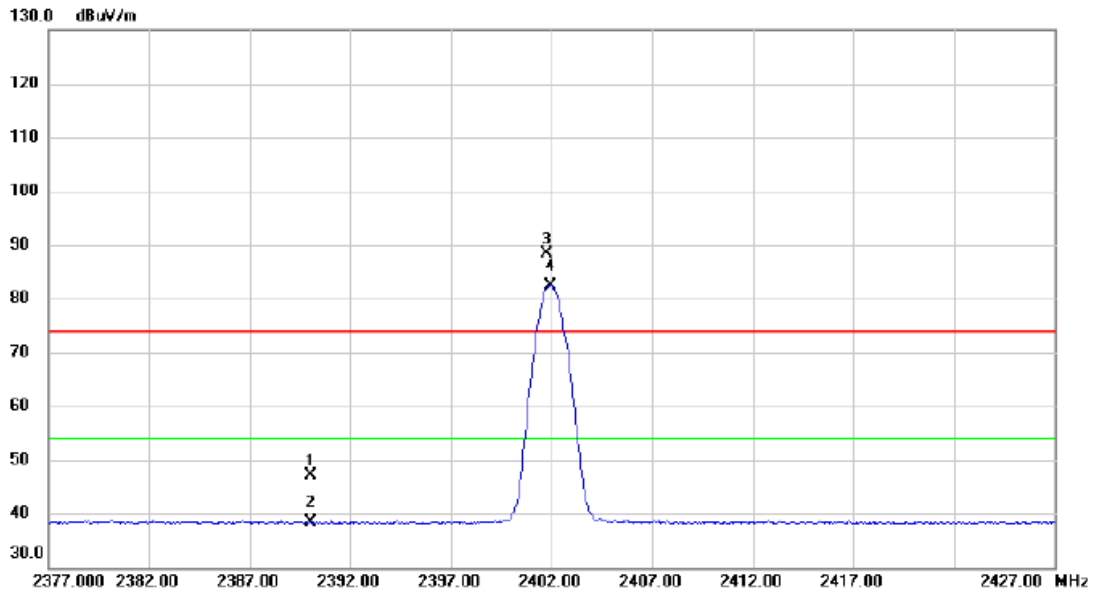

No.	Mk.	Freq. MHz	Reading Level dBuV	Correct Factor dB	Measure- ment dBuV/m	Limit dBuV/m	Margin dB	Detector	Comment
1		2390.000	39.93	7.27	47.20	74.00	-26.80	peak	
2		2390.000	31.07	7.27	38.34	54.00	-15.66	AVG	
3	X	2401.750	81.05	7.28	88.33	74.00	14.33	peak	No Limit
4	*	2401.950	75.22	7.28	82.50	54.00	28.50	AVG	No Limit

REMARKS:

- (1) Measurement Value = Reading Level + Correct Factor.
- (2) Margin Level = Measurement Value - Limit Value.

Test Mode	TX 2402 MHz _CH00_1Mbps	Polarization	Horizontal
-----------	-------------------------	--------------	------------

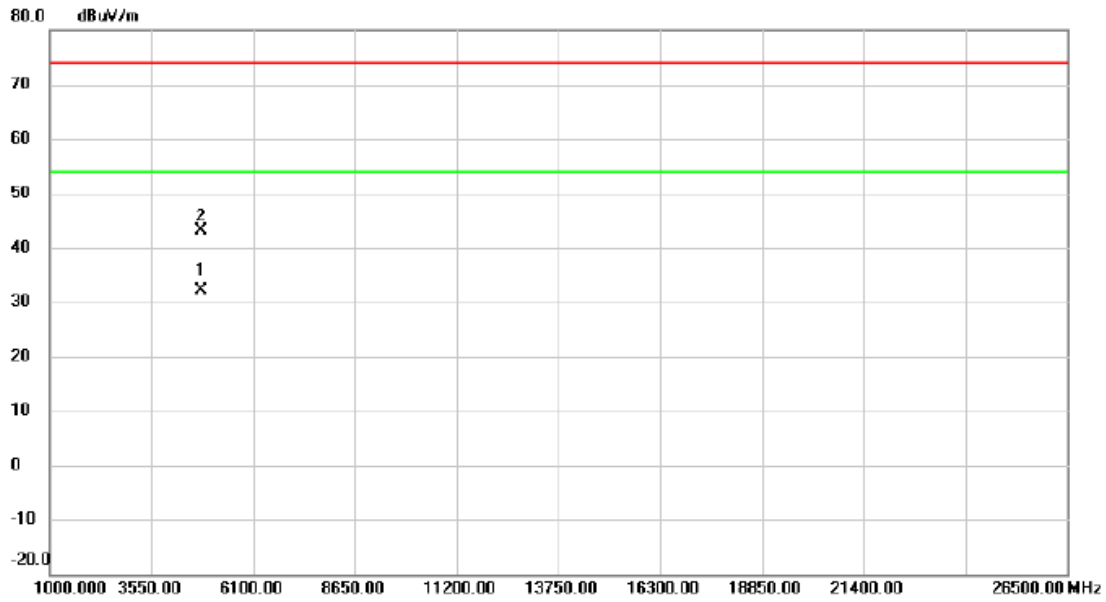

No.	Mk.	Freq. MHz	Reading Level dBuV	Correct Factor dB	Measure- ment dBuV/m	Limit dBuV/m	Margin dB	Detector	Comment
1	*	4804.695	27.73	4.30	32.03	54.00	-21.97	AVG	
2		4805.355	38.72	4.30	43.02	74.00	-30.98	peak	

REMARKS:

- (1) Measurement Value = Reading Level + Correct Factor.
- (2) Margin Level = Measurement Value - Limit Value.

Test Mode	TX 2440 MHz _CH19_1Mbps	Polarization	Vertical
-----------	-------------------------	--------------	----------

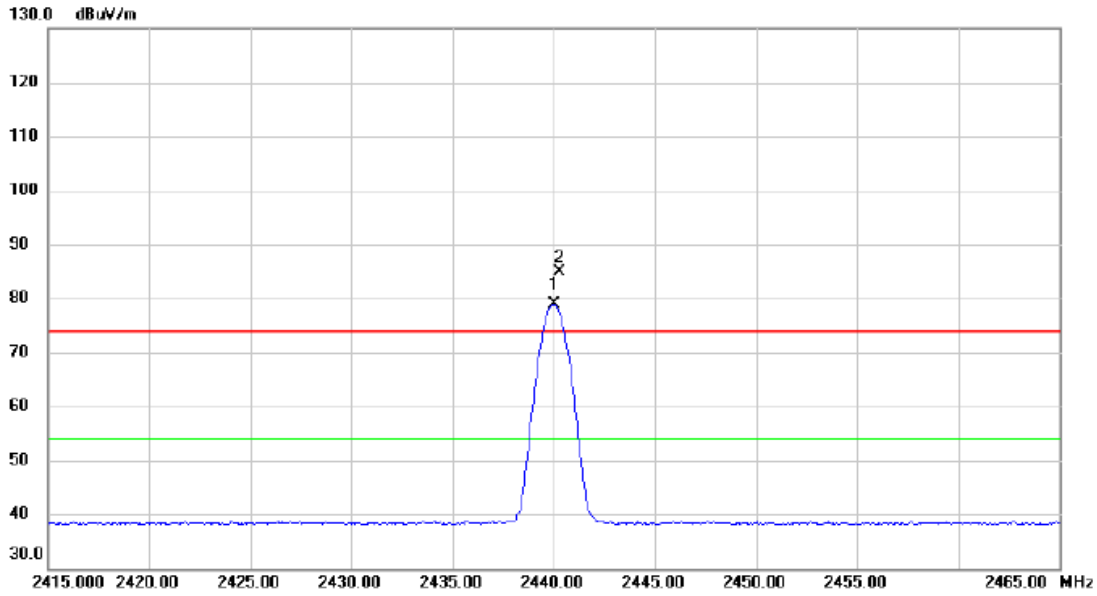

No.	Mk.	Freq.	Reading Level	Correct Factor	Measurement	Limit	Margin	Detector	Comment
		MHz	dBuV	dB	dBuV/m	dBuV/m	dB		
1	*	2440.000	71.63	7.30	78.93	54.00	24.93	AVG	No Limit
2	X	2440.300	77.46	7.30	84.76	74.00	10.76	peak	No Limit

REMARKS:

- (1) Measurement Value = Reading Level + Correct Factor.
- (2) Margin Level = Measurement Value - Limit Value.

Test Mode	TX 2440 MHz _CH19_1Mbps	Polarization	Vertical
-----------	-------------------------	--------------	----------

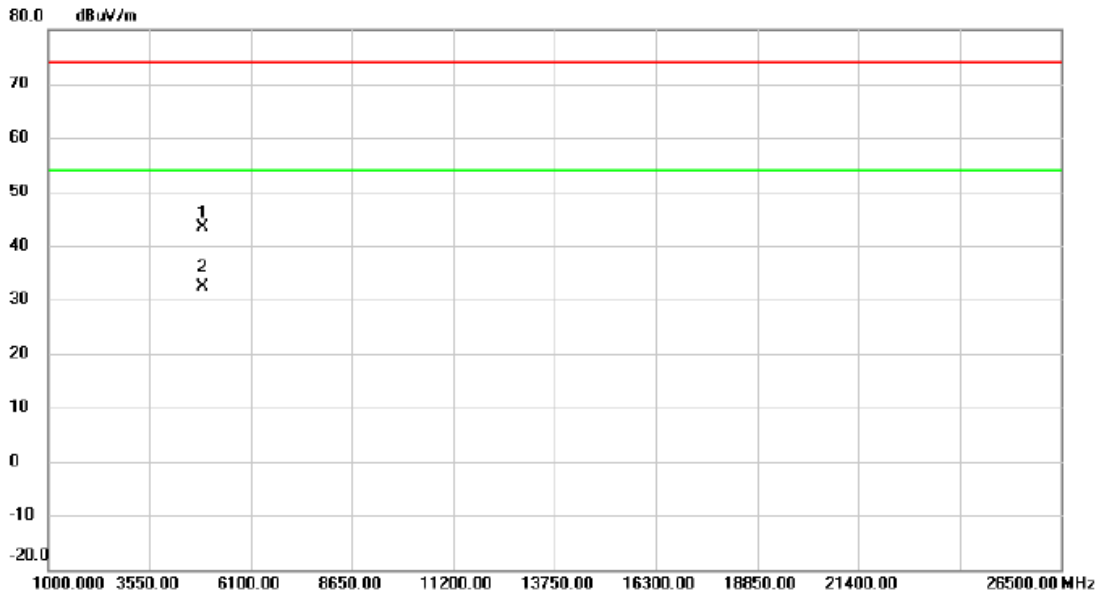

No.	Mk.	Freq. MHz	Reading Level dBuV	Correct Factor dB	Measure- ment dBuV/m	Limit dBuV/m	Margin dB	Detector	Comment
1		4880.210	38.83	4.43	43.26	74.00	-30.74	peak	
2	*	4880.800	27.86	4.43	32.29	54.00	-21.71	AVG	

REMARKS:

- (1) Measurement Value = Reading Level + Correct Factor.
- (2) Margin Level = Measurement Value - Limit Value.

Test Mode	TX 2440 MHz _CH19_1Mbps	Polarization	Horizontal
-----------	-------------------------	--------------	------------

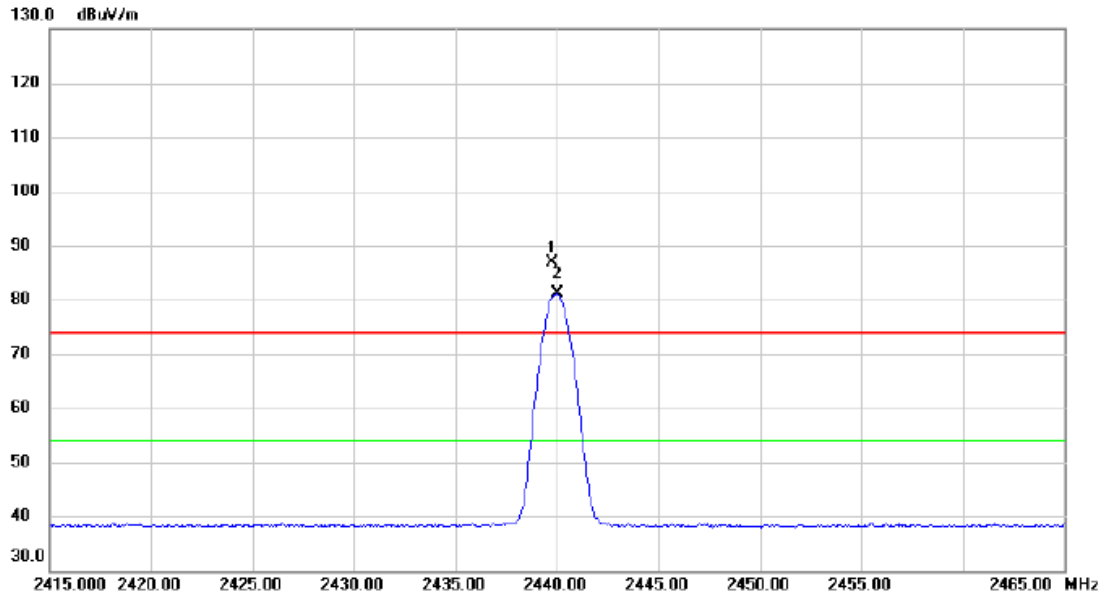

No.	Mk.	Freq.	Reading Level	Correct Factor	Measurement	Limit	Margin		
		MHz	dBuV	dB	dBuV/m	dBuV/m	dB	Detector	Comment
1	X	2439.750	79.63	7.30	86.93	74.00	12.93	peak	No Limit
2	*	2440.000	73.77	7.30	81.07	54.00	27.07	AVG	No Limit

REMARKS:

- (1) Measurement Value = Reading Level + Correct Factor.
- (2) Margin Level = Measurement Value - Limit Value.

Test Mode	TX 2440 MHz _CH19_1Mbps	Polarization	Horizontal
-----------	-------------------------	--------------	------------

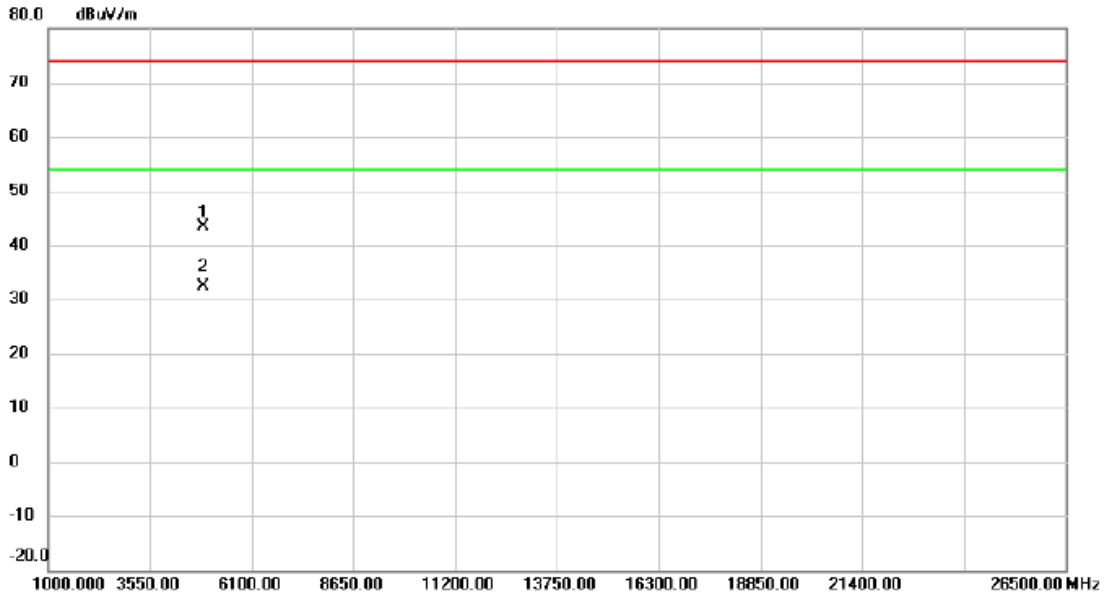

No.	Mk.	Freq.	Reading Level	Correct Factor	Measurement	Limit	Margin	Detector	Comment
		MHz	dBuV	dB	dBuV/m	dBuV/m	dB		
1		4878.770	39.03	4.42	43.45	74.00	-30.55	peak	
2	*	4880.610	27.89	4.43	32.32	54.00	-21.68	AVG	

REMARKS:

- (1) Measurement Value = Reading Level + Correct Factor.
- (2) Margin Level = Measurement Value - Limit Value.

Test Mode	TX 2480 MHz _CH39_1Mbps	Polarization	Vertical
-----------	-------------------------	--------------	----------

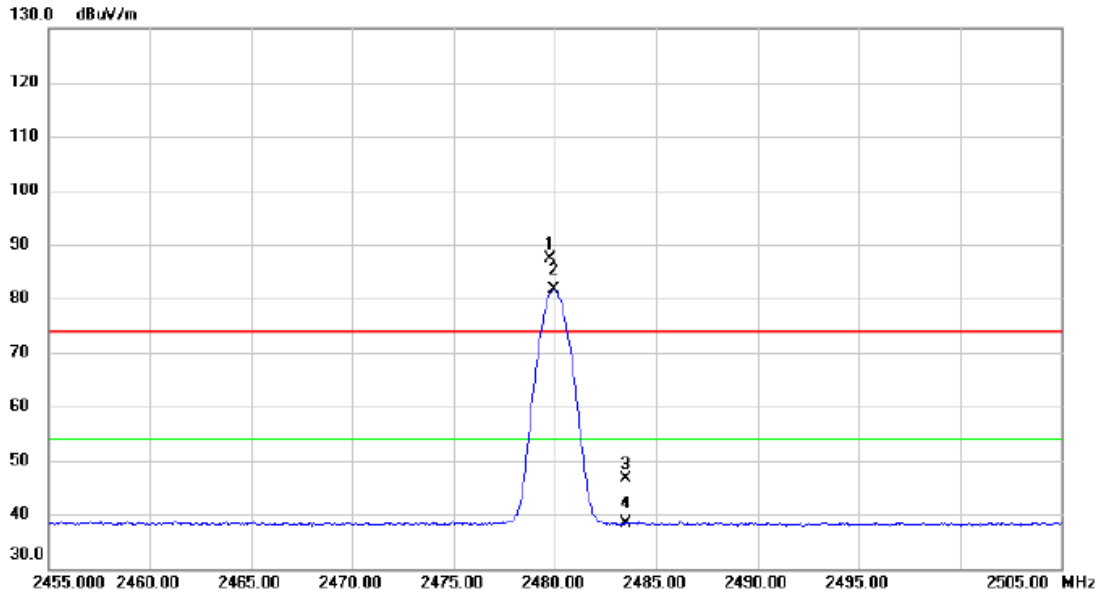

No.	Mk.	Freq.	Reading Level	Correct Factor	Measurement	Limit	Margin	Detector	Comment
		MHz	dBuV	dB	dBuV/m	dBuV/m	dB		
1	X	2479.750	80.06	7.34	87.40	74.00	13.40	peak	No Limit
2	*	2479.950	74.30	7.34	81.64	54.00	27.64	AVG	No Limit
3		2483.500	39.39	7.34	46.73	74.00	-27.27	peak	
4		2483.500	30.92	7.34	38.26	54.00	-15.74	AVG	

REMARKS:

- (1) Measurement Value = Reading Level + Correct Factor.
- (2) Margin Level = Measurement Value - Limit Value.

Test Mode	TX 2480 MHz _CH39_1Mbps	Polarization	Vertical
-----------	-------------------------	--------------	----------

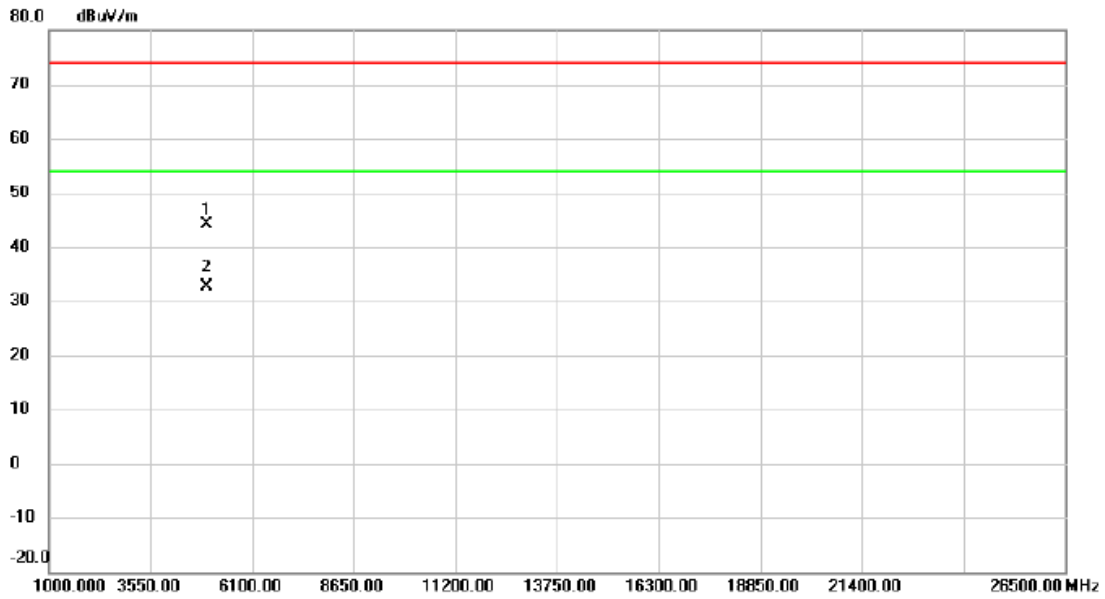

No.	Mk.	Freq. MHz	Reading Level dBuV	Correct Factor dB	Measure- ment dBuV/m	Limit dBuV/m	Margin dB	Detector	Comment
1		4959.550	39.46	4.55	44.01	74.00	-29.99	peak	
2	*	4960.255	28.18	4.55	32.73	54.00	-21.27	AVG	

REMARKS:

- (1) Measurement Value = Reading Level + Correct Factor.
- (2) Margin Level = Measurement Value - Limit Value.

Test Mode	TX 2480 MHz _CH39_1Mbps	Polarization	Horizontal
-----------	-------------------------	--------------	------------

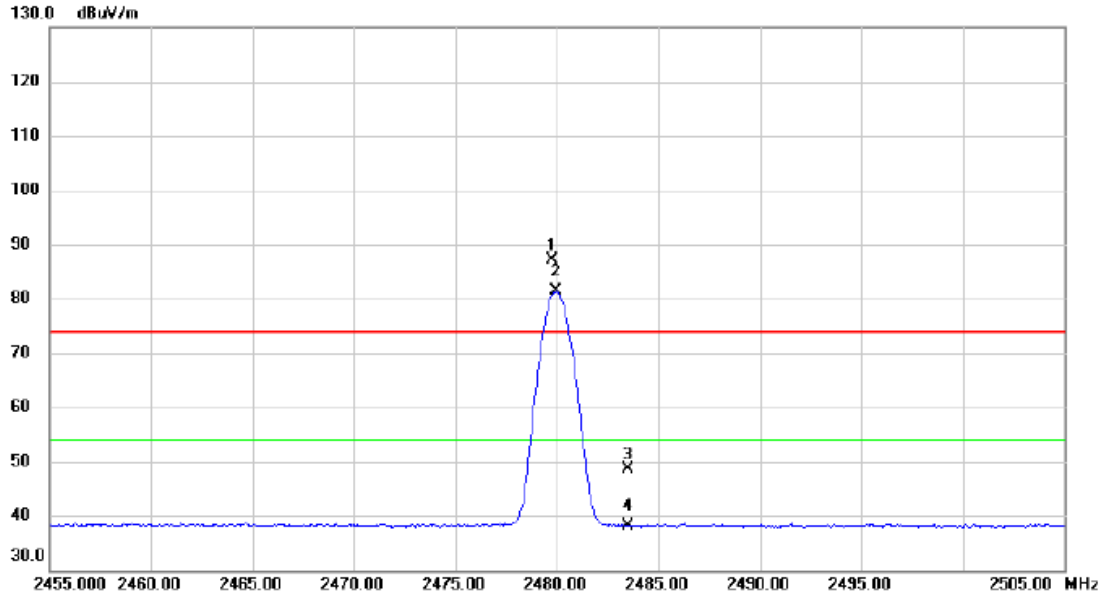

No.	Mk.	Freq. MHz	Reading Level dBuV	Correct Factor dB	Measure- ment dBuV/m	Limit dBuV/m	Margin dB	Detector	Comment
1	X	2479.750	79.74	7.34	87.08	74.00	13.08	peak	No Limit
2	*	2479.950	73.95	7.34	81.29	54.00	27.29	AVG	No Limit
3		2483.500	41.25	7.34	48.59	74.00	-25.41	peak	
4		2483.500	30.79	7.34	38.13	54.00	-15.87	AVG	

REMARKS:
 (1) Measurement Value = Reading Level + Correct Factor.
 (2) Margin Level = Measurement Value - Limit Value.

Test Mode	TX 2480 MHz _CH39_1Mbps	Polarization	Horizontal
-----------	-------------------------	--------------	------------

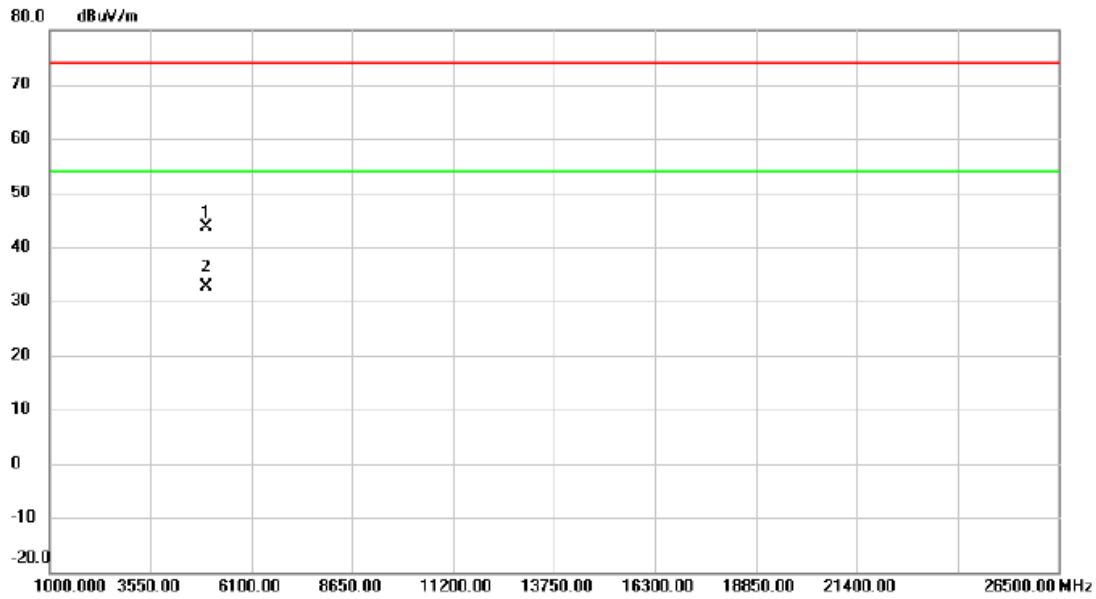

No.	Mk.	Freq. MHz	Reading Level dBuV	Correct Factor dB	Measure- ment dBuV/m	Limit dBuV/m	Margin dB	Detector	Comment
1		4959.435	39.01	4.55	43.56	74.00	-30.44	peak	
2	*	4960.210	28.08	4.55	32.63	54.00	-21.37	AVG	

REMARKS:

- (1) Measurement Value = Reading Level + Correct Factor.
- (2) Margin Level = Measurement Value - Limit Value.

Test Mode :	TX 2402 MHz _CH00_2Mbps	Polarization	Vertical
-------------	-------------------------	--------------	----------

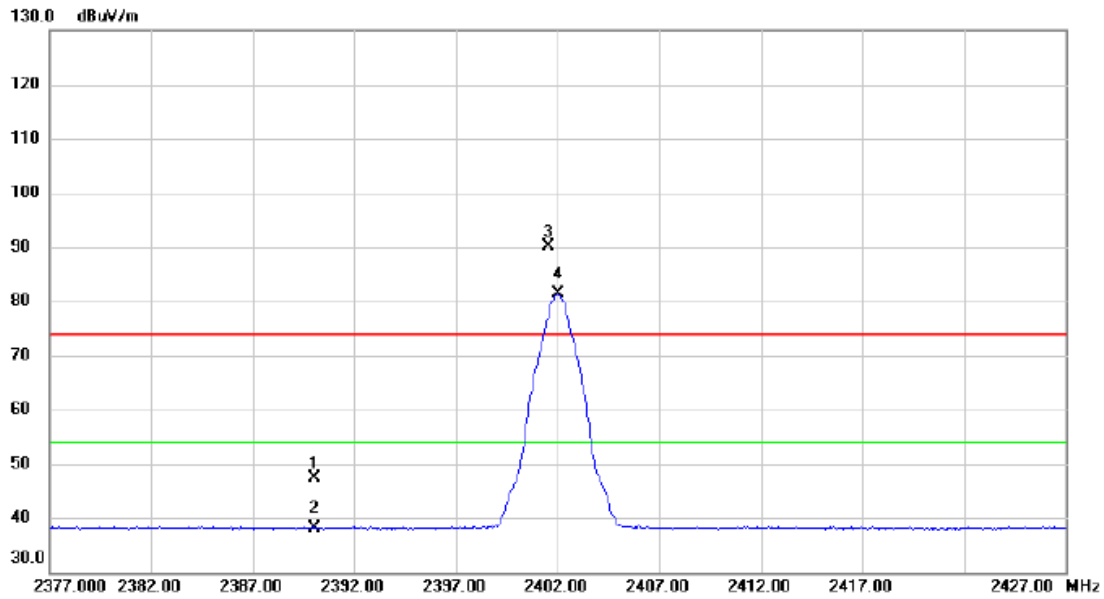

No.	Mk.	Freq. MHz	Reading Level dBuV	Correct Factor dB	Measure- ment dBuV/m	Limit dBuV/m	Margin dB	Detector	Comment
1		2390.000	39.99	7.27	47.26	74.00	-26.74	peak	
2		2390.000	30.88	7.27	38.15	54.00	-15.85	AVG	
3	X	2401.550	82.96	7.28	90.24	74.00	16.24	peak	No Limit
4	*	2402.000	74.00	7.28	81.28	54.00	27.28	AVG	No Limit

REMARKS:

- (1) Measurement Value = Reading Level + Correct Factor.
- (2) Margin Level = Measurement Value - Limit Value.

Test Mode :	TX 2402 MHz _CH00_2Mbps	Polarization	Vertical
-------------	-------------------------	--------------	----------

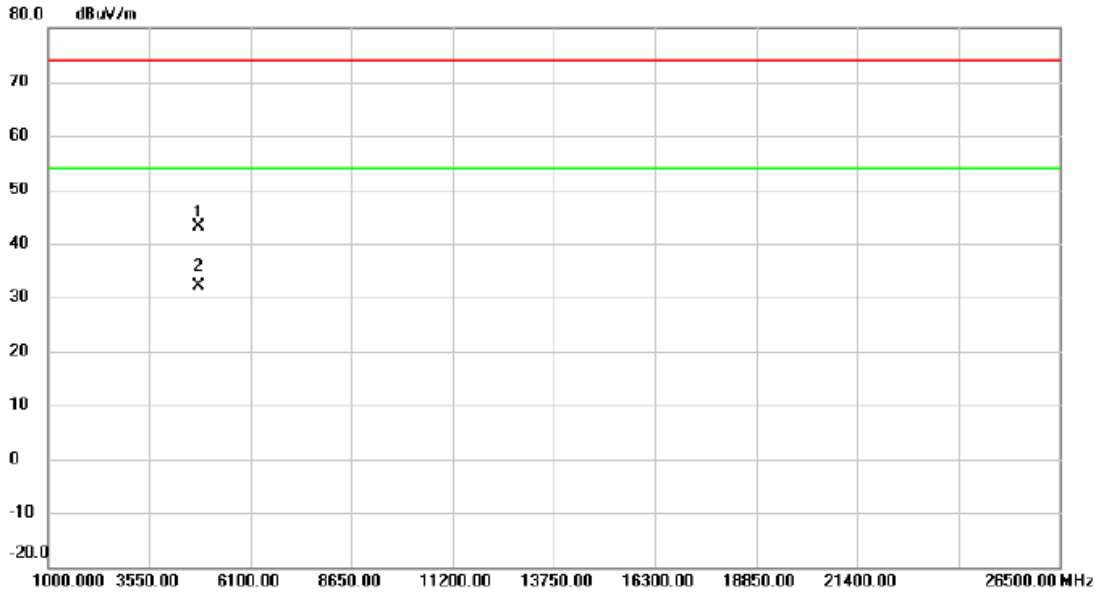

No.	Mk.	Freq. MHz	Reading Level dBuV	Correct Factor dB	Measure- ment dBuV/m	Limit dBuV/m	Margin dB	Detector	Comment
1		4803.755	38.72	4.29	43.01	74.00	-30.99	peak	
2	*	4805.995	27.82	4.30	32.12	54.00	-21.88	AVG	

REMARKS:

- (1) Measurement Value = Reading Level + Correct Factor.
- (2) Margin Level = Measurement Value - Limit Value.

Test Mode :	TX 2402 MHz_CH00_2Mbps	Polarization	Horizontal
-------------	------------------------	--------------	------------

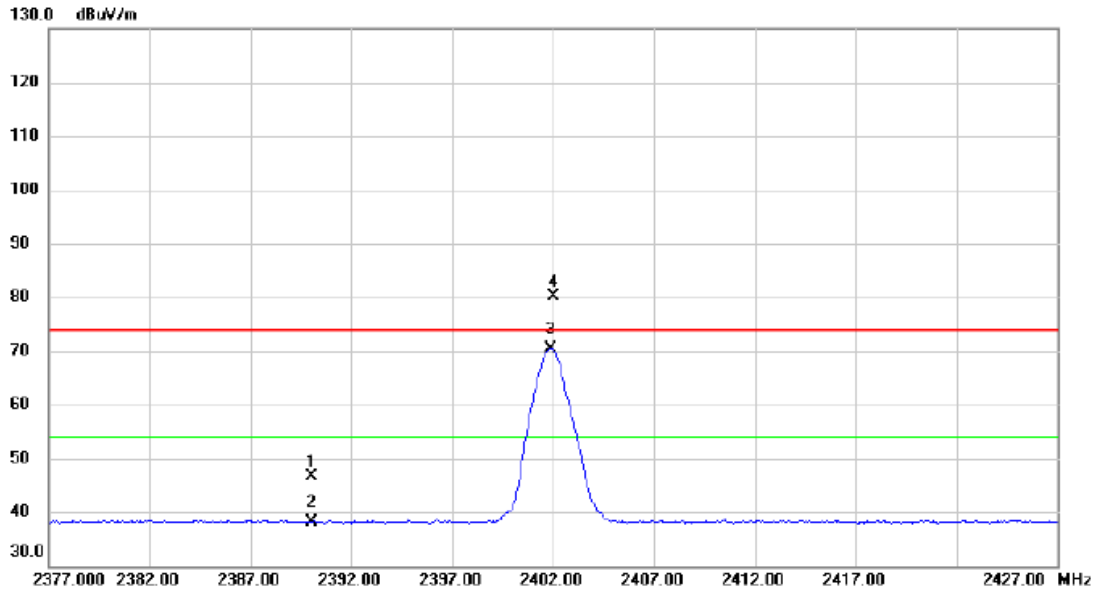

No.	Mk.	Freq. MHz	Reading Level dBuV	Correct Factor dB	Measure- ment dBuV/m	Limit dBuV/m	Margin dB	Detector	Comment
1		2390.000	39.32	7.27	46.59	74.00	-27.41	peak	
2		2390.000	30.83	7.27	38.10	54.00	-15.90	AVG	
3	*	2401.900	63.18	7.28	70.46	54.00	16.46	AVG	No Limit
4	X	2402.000	72.87	7.28	80.15	74.00	6.15	peak	No Limit

REMARKS:
 (1) Measurement Value = Reading Level + Correct Factor.
 (2) Margin Level = Measurement Value - Limit Value.

Test Mode :	TX 2402 MHz _CH00_2Mbps	Polarization	Horizontal
-------------	-------------------------	--------------	------------

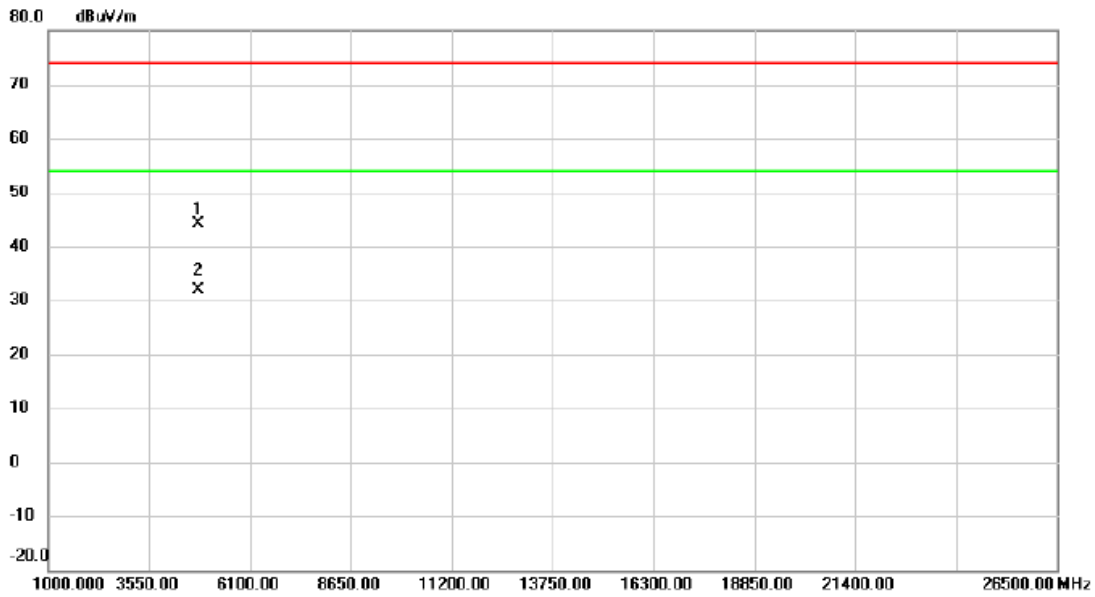

No.	Mk.	Freq. MHz	Reading Level dBuV	Correct Factor dB	Measure- ment dBuV/m	Limit dBuV/m	Margin dB	Detector	Comment
1		4802.210	39.73	4.29	44.02	74.00	-29.98	peak	
2	*	4804.025	27.62	4.29	31.91	54.00	-22.09	AVG	

REMARKS:

- (1) Measurement Value = Reading Level + Correct Factor.
- (2) Margin Level = Measurement Value - Limit Value.

Test Mode :	TX 2440 MHz _CH19_2Mbps	Polarization	Vertical
-------------	-------------------------	--------------	----------

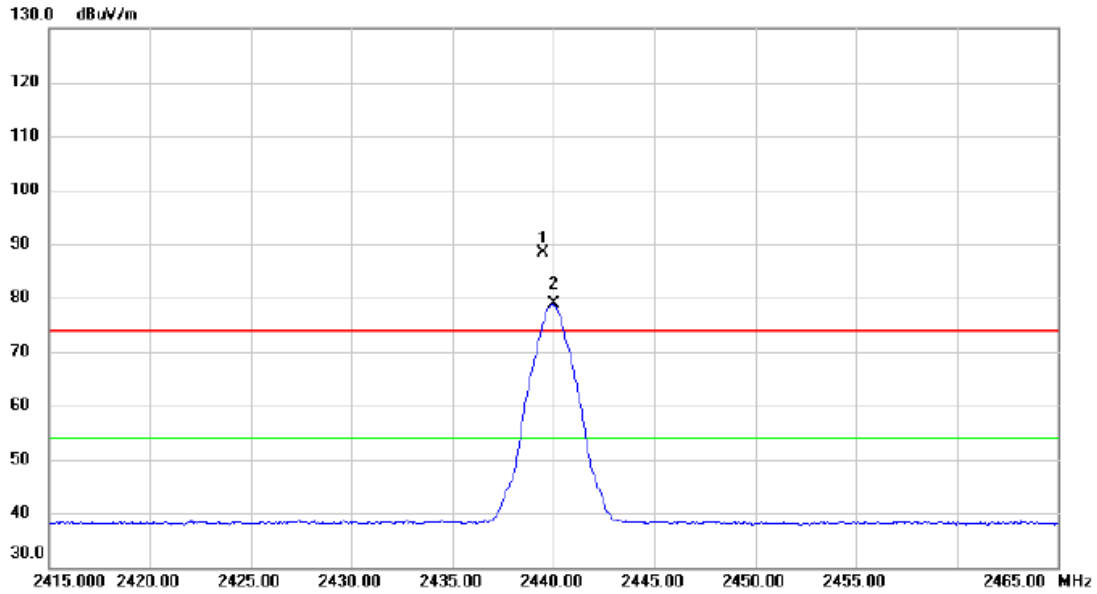

No.	Mk.	Freq. MHz	Reading Level dBuV	Correct Factor dB	Measure- ment dBuV/m	Limit dBuV/m	Margin dB	Detector	Comment
1	X	2439.500	81.08	7.30	88.38	74.00	14.38	peak	No Limit
2	*	2440.000	71.49	7.30	78.79	54.00	24.79	AVG	No Limit

REMARKS:

- (1) Measurement Value = Reading Level + Correct Factor.
- (2) Margin Level = Measurement Value - Limit Value.

Test Mode :	TX 2440 MHz _CH19_2Mbps	Polarization	Vertical
-------------	-------------------------	--------------	----------

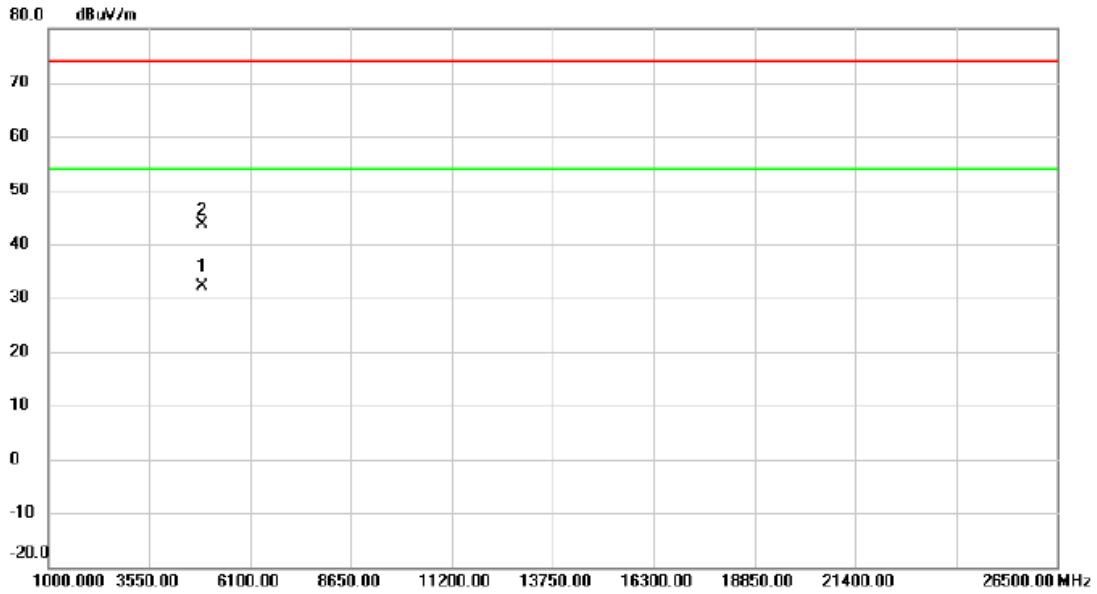

No.	Mk.	Freq. MHz	Reading Level dBuV	Correct Factor dB	Measure- ment dBuV/m	Limit dBuV/m	Margin dB	Detector	Comment
1	*	4879.565	27.65	4.43	32.08	54.00	-21.92	AVG	
2		4880.855	39.12	4.43	43.55	74.00	-30.45	peak	

REMARKS:

- (1) Measurement Value = Reading Level + Correct Factor.
- (2) Margin Level = Measurement Value - Limit Value.

Test Mode :	TX 2440 MHz _CH19_2Mbps	Polarization	Horizontal
-------------	-------------------------	--------------	------------

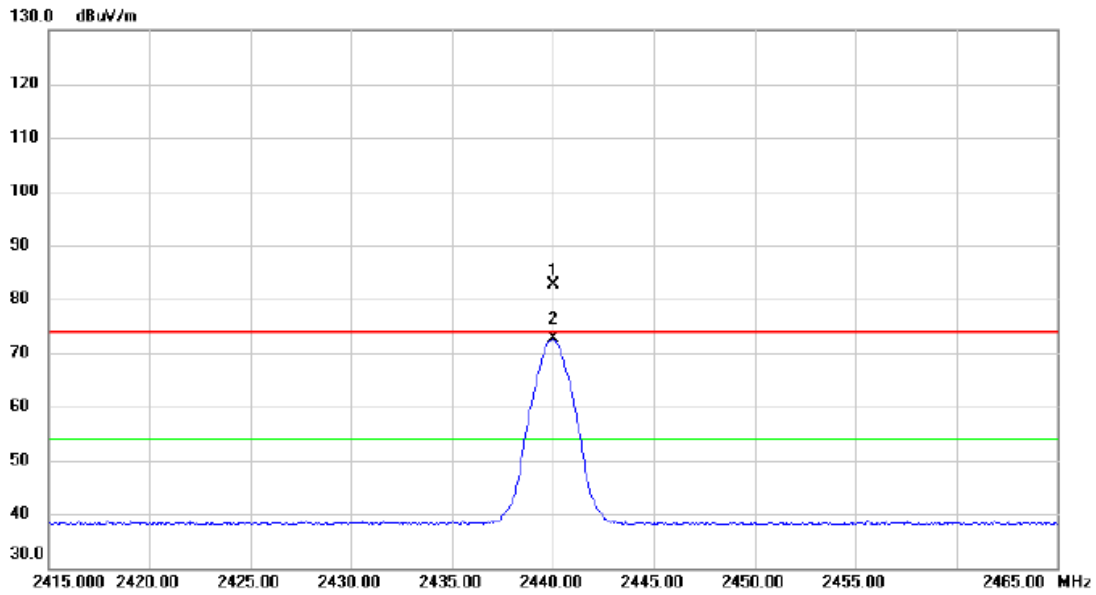

No.	Mk.	Freq. MHz	Reading Level dBuV	Correct Factor dB	Measure- ment dBuV/m	Limit dBuV/m	Margin dB	Detector	Comment
1	X	2440.000	75.25	7.30	82.55	74.00	8.55	peak	No Limit
2	*	2440.000	65.27	7.30	72.57	54.00	18.57	AVG	No Limit

REMARKS:

- (1) Measurement Value = Reading Level + Correct Factor.
- (2) Margin Level = Measurement Value - Limit Value.

Test Mode :	TX 2440 MHz _CH19_2Mbps	Polarization	Horizontal
-------------	-------------------------	--------------	------------

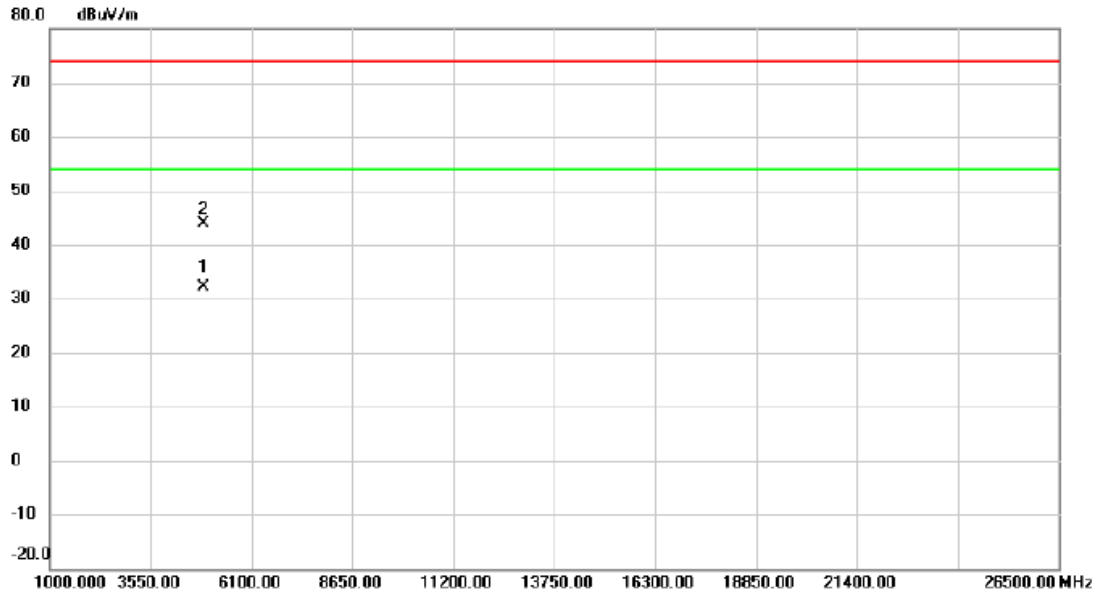

No.	Mk.	Freq. MHz	Reading Level dBuV	Correct Factor dB	Measure- ment dBuV/m	Limit dBuV/m	Margin dB	Detector	Comment
1	*	4881.025	27.72	4.43	32.15	54.00	-21.85	AVG	
2		4882.130	39.45	4.43	43.88	74.00	-30.12	peak	

REMARKS:

- (1) Measurement Value = Reading Level + Correct Factor.
- (2) Margin Level = Measurement Value - Limit Value.

Test Mode :	TX 2480 MHz _CH39_2Mbps	Polarization	Vertical
-------------	-------------------------	--------------	----------

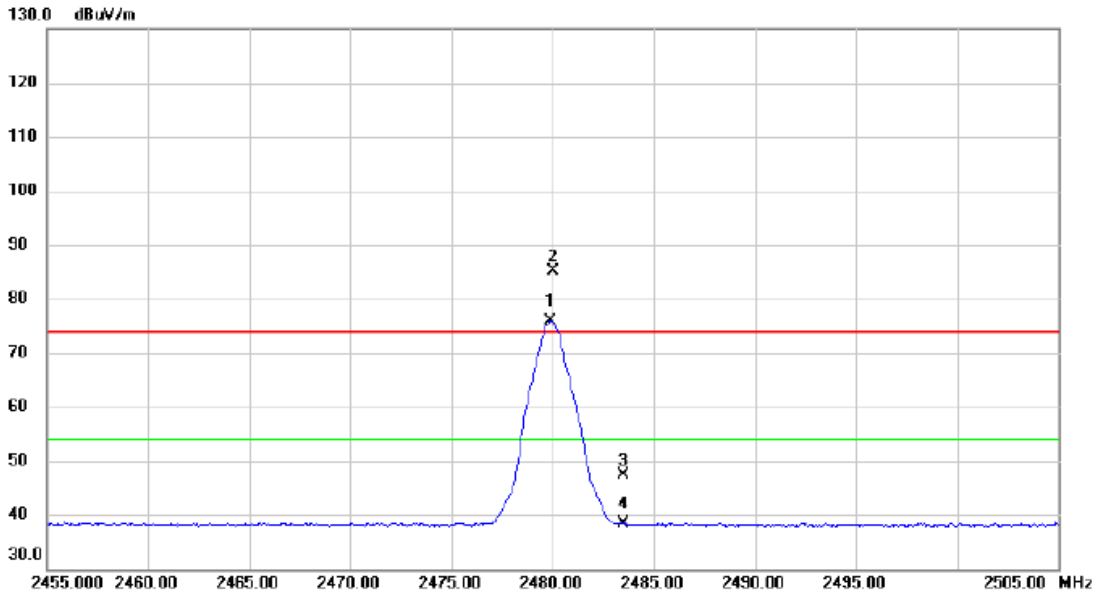

No.	Mk.	Freq. MHz	Reading Level dBuV	Correct Factor dB	Measure- ment dBuV/m	Limit dBuV/m	Margin dB	Detector	Comment
1	*	2479.900	68.57	7.34	75.91	54.00	21.91	AVG	No Limit
2	X	2480.050	77.90	7.34	85.24	74.00	11.24	peak	No Limit
3		2483.500	40.10	7.34	47.44	74.00	-26.56	peak	
4		2483.500	30.94	7.34	38.28	54.00	-15.72	AVG	

REMARKS:

- (1) Measurement Value = Reading Level + Correct Factor.
- (2) Margin Level = Measurement Value - Limit Value.

Test Mode :	TX 2480 MHz _CH39_2Mbps	Polarization	Vertical
-------------	-------------------------	--------------	----------

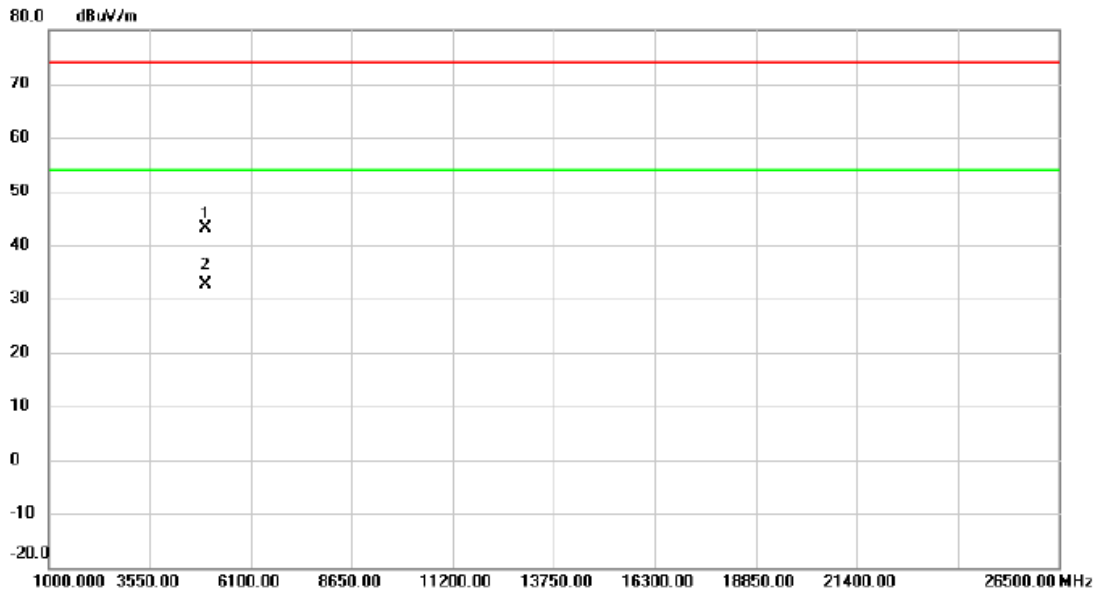

No.	Mk.	Freq. MHz	Reading Level dBuV	Correct Factor dB	Measure- ment dBuV/m	Limit dBuV/m	Margin dB	Detector	Comment
1		4960.635	38.55	4.55	43.10	74.00	-30.90	peak	
2	*	4961.960	28.13	4.55	32.68	54.00	-21.32	AVG	

REMARKS:

- (1) Measurement Value = Reading Level + Correct Factor.
- (2) Margin Level = Measurement Value - Limit Value.

Test Mode :	TX 2480 MHz _CH39_2Mbps	Polarization	Horizontal
-------------	-------------------------	--------------	------------

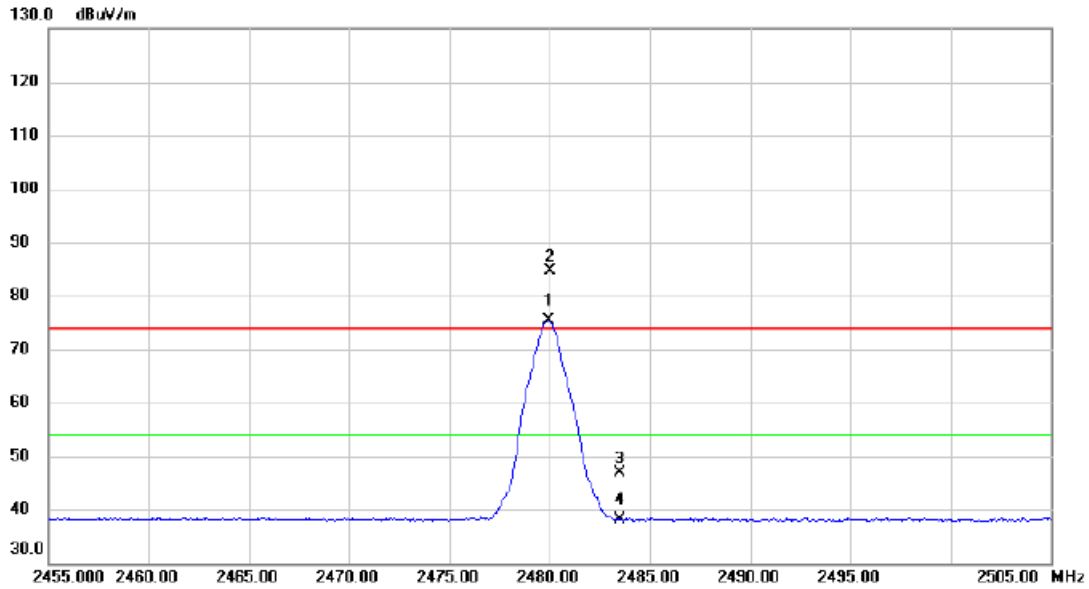

No.	Mk.	Freq. MHz	Reading Level dBuV	Correct Factor dB	Measure- ment dBuV/m	Limit dBuV/m	Margin dB	Detector	Comment
1	*	2479.950	67.96	7.34	75.30	54.00	21.30	AVG	No Limit
2	X	2480.000	77.32	7.34	84.66	74.00	10.66	peak	No Limit
3		2483.500	39.60	7.34	46.94	74.00	-27.06	peak	
4		2483.500	30.90	7.34	38.24	54.00	-15.76	AVG	

REMARKS:

- (1) Measurement Value = Reading Level + Correct Factor.
- (2) Margin Level = Measurement Value - Limit Value.

Test Mode :	TX 2480 MHz _CH39_2Mbps	Polarization	Horizontal
-------------	-------------------------	--------------	------------

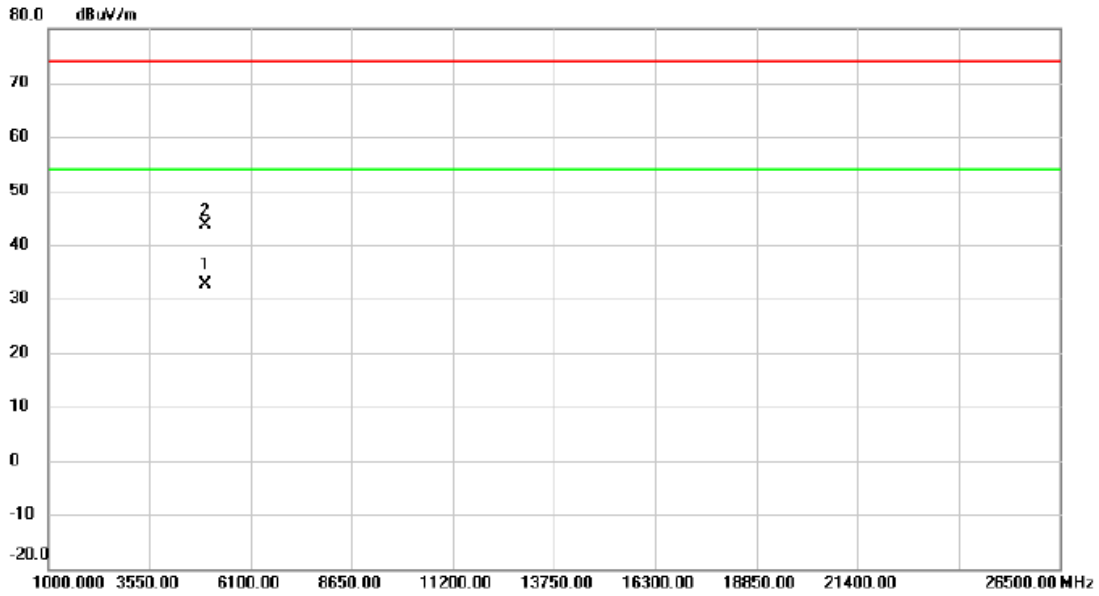

No.	Mk.	Freq. MHz	Reading Level dBuV	Correct Factor dB	Measure- ment dBuV/m	Limit dBuV/m	Margin dB	Detector	Comment
1	*	4959.065	28.05	4.55	32.60	54.00	-21.40	AVG	
2		4960.715	39.17	4.55	43.72	74.00	-30.28	peak	

REMARKS:

- (1) Measurement Value = Reading Level + Correct Factor.
- (2) Margin Level = Measurement Value - Limit Value.

APPENDIX E - MAXIMUM OUTPUT POWER

Test Mode : CH00, CH19 , CH39 - 1Mbps

Frequency (MHz)	Output Power (dBm)	Output Power (W)	Max. Limit (dBm)	Max. Limit (W)	Test Result
2402	3.13	0.0021	30.00	1.00	Pass
2440	2.77	0.0019	30.00	1.00	Pass
2480	3.25	0.0021	30.00	1.00	Pass

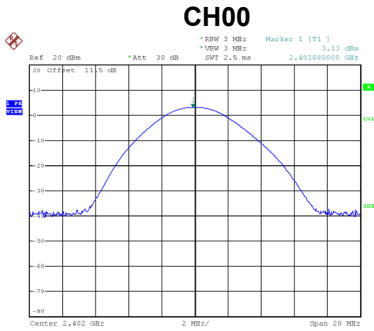

Date: 17.MAY.2022 13:54:41

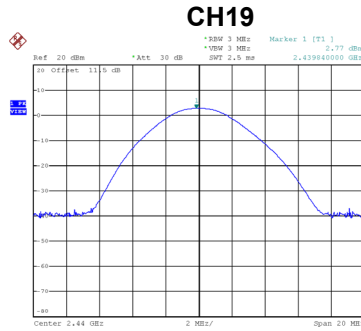

Date: 17.MAY.2022 13:55:22

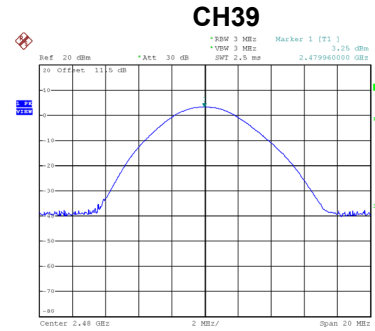

Date: 17.MAY.2022 13:55:38

Test Mode : CH00, CH19 , CH39 - 2Mbps

Frequency (MHz)	Output Power (dBm)	Output Power (W)	Max. Limit (dBm)	Max. Limit (W)	Test Result
2402	3.14	0.0021	30.00	1.00	Pass
2440	2.78	0.0019	30.00	1.00	Pass
2480	3.27	0.0021	30.00	1.00	Pass

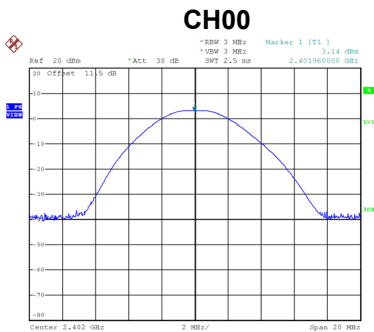

Date: 17.MAY.2022 13:56:26

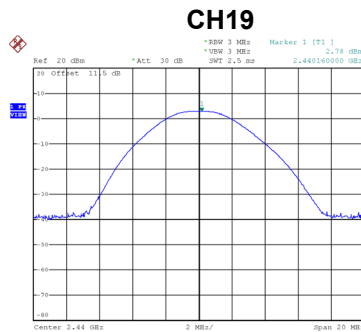

Date: 17.MAY.2022 13:56:56

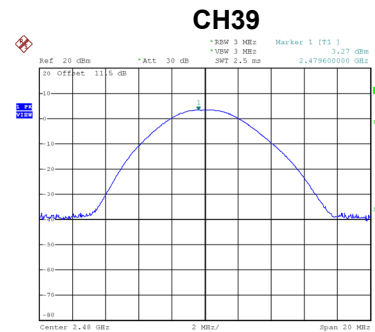

Date: 17.MAY.2022 13:57:12

End of Test Report