

FCC Radio Test Report

FCC ID: RWO-RC30027101

This report concerns (check one): Original Grant Class II Change

Project No. : 1807C001
Equipment : Gaming Mouse
Test Model : RC30-027101
Series Model : N/A
Applicant : Razer Inc.
Address : 201 3rd Street, Suite 900, San Francisco, CA 94103, USA

Date of Receipt : Jul. 02, 2018
Date of Test : Jul. 03, 2018 ~ Jul. 19, 2018
Issued Date : Aug. 01, 2018
Tested by : BTL Inc.

Testing Engineer : Kai Xu
(Kai Xu)

Technical Manager : shawn xiao
(Shawn Xiao)

Authorized Signatory : Steven Lu
(Steven Lu)

B T L I N C .

No.3, Jinshagang 1st Road, Shixia, Dalang Town, Dongguan, Guangdong, China.

TEL: +86-769-8318-3000 FAX: +86-769-8319-6000



Declaration

BTL represents to the client that testing is done in accordance with standard procedures as applicable and that test instruments used has been calibrated with standards traceable to international standard(s) and/or national standard(s).

BTL's reports apply only to the specific samples tested under conditions. It is manufacture's responsibility to ensure that additional production units of this model are manufactured with the identical electrical and mechanical components. **BTL** shall have no liability for any declarations, inferences or generalizations drawn by the client or others from **BTL** issued reports.

The report must not be used by the client to claim product certification, approval, or endorsement by NVLAP, NIST, or any agency of the U.S. Government.

This report is the confidential property of the client. As a mutual protection to the clients, the public and ourselves, the test report shall not be reproduced, except in full, without our written approval.

BTL's laboratory quality assurance procedures are in compliance with the **ISO Guide 17025** requirements, and accredited by the conformity assessment authorities listed in this test report.

BTL is not responsible for the sampling stage, so the results only apply to the sample as received.

The information, data and test plan are provided by manufacturer, so it is manufacturer's responsibility to ensure that the apparatus meets the essential requirements in all the possible configurations as representative of its intended use.

Limitation

For the use of the authority's logo is limited unless the Test Standard(s)/Scope(s)/Item(s) mentioned in this test report is (are) included in the conformity assessment authorities acceptance respective.

Table of Contents	Page
1 . CERTIFICATION	6
2 . SUMMARY OF TEST RESULTS	7
2.1 TEST FACILITY	8
2.2 MEASUREMENT UNCERTAINTY	8
3 . GENERAL INFORMATION	9
3.1 GENERAL DESCRIPTION OF EUT	9
3.2 DESCRIPTION OF TEST MODES	11
3.3 TABLE OF PARAMETERS OF TEXT SOFTWARE SETTING	11
3.4 BLOCK DIAGRAM SHOWING THE CONFIGURATION OF SYSTEM TESTED	12
3.5 DESCRIPTION OF SUPPORT UNITS	12
4 . EMC EMISSION TEST	13
4.1 CONDUCTED EMISSION MEASUREMENT	13
4.1.1 POWER LINE CONDUCTED EMISSION LIMITS	13
4.1.2 TEST PROCEDURE	13
4.1.3 DEVIATION FROM TEST STANDARD	13
4.1.4 TEST SETUP	14
4.1.5 EUT OPERATING CONDITIONS	14
4.1.6 EUT TEST CONDITIONS	14
4.1.7 TEST RESULTS	14
4.2 RADIATED EMISSION MEASUREMENT	15
4.2.1 RADIATED EMISSION LIMITS	15
4.2.2 TEST PROCEDURE	16
4.2.3 DEVIATION FROM TEST STANDARD	16
4.2.4 TEST SETUP	17
4.2.5 EUT OPERATING CONDITIONS	18
4.2.6 EUT TEST CONDITIONS	18
4.2.7 TEST RESULTS (9KHZ TO 30MHZ)	18
4.2.8 TEST RESULTS (30MHZ TO 1000 MHZ)	19
4.2.9 TEST RESULTS (ABOVE 1000 MHZ)	19
5 . BANDWIDTH TEST	20
5.1 APPLIED PROCEDURES / LIMIT	20
5.1.1 TEST PROCEDURE	20
5.1.2 DEVIATION FROM STANDARD	20
5.1.3 TEST SETUP	20
5.1.4 EUT OPERATION CONDITIONS	20
5.1.5 EUT TEST CONDITIONS	20
5.1.6 TEST RESULTS	20

Table of Contents	Page
6 . CONDUCTED OUTPUT POWER TEST	21
6.1 APPLIED PROCEDURES / LIMIT	21
6.1.1 TEST PROCEDURE	21
6.1.2 DEVIATION FROM STANDARD	21
6.1.3 TEST SETUP	21
6.1.4 EUT OPERATION CONDITIONS	21
6.1.5 EUT TEST CONDITIONS	21
6.1.6 TEST RESULTS	21
7 . ANTENNA CONDUCTED SPURIOUS EMISSION	22
7.1 APPLIED PROCEDURES / LIMIT	22
7.1.1 TEST PROCEDURE	22
7.1.2 DEVIATION FROM STANDARD	22
7.1.3 TEST SETUP	22
7.1.4 EUT OPERATION CONDITIONS	22
7.1.5 EUT OPERATION CONDITIONS	22
7.1.6 TEST RESULTS	22
8 . POWER SPECTRAL DENSITY TEST	23
8.1 APPLIED PROCEDURES / LIMIT	23
8.1.1 TEST PROCEDURE	23
8.1.2 DEVIATION FROM STANDARD	23
8.1.3 TEST SETUP	23
8.1.4 EUT OPERATION CONDITIONS	23
8.1.5 EUT TEST CONDITIONS	23
8.1.6 TEST RESULTS	23
9 . MEASUREMENT INSTRUMENTS LIST	24
APPENDIX A - CONDUCTED EMISSION	26
APPENDIX B - RADIATED EMISSION (9KHZ TO 30MHZ)	29
APPENDIX C - RADIATED EMISSION (30MHZ TO 1000MHZ)	34
APPENDIX D - RADIATED EMISSION (ABOVE 1000MHZ)	41
APPENDIX E - BANDWIDTH	54
APPENDIX F - CONDUCTED POWER TEST	57
APPENDIX G - ANTENNA CONDUCTED SPURIOUS EMISSION	60
APPENDIX H - POWER SPECTRAL DENSITY TEST	64

REPORT ISSUED HISTORY

Issued No.	Description	Issued Date
BTL-FCCP-1-1807C001	Original Issue.	Aug. 01, 2018

1. CERTIFICATION

Equipment : Gaming Mouse
Brand Name : RAZER
Test Model : RC30-027101
Series Model : N/A
Applicant : Razer Inc.
Manufacturer : Razer (Asia-Pacific) Pte.,Ltd.
Address : 514 Chai Chee Lane #07-01 ~ 06 Singapore 469029
Factory : RAZER TECHNOLOGY AND DEVELOPMENT (SHENZHEN) CO., LTD
Address : East Wing, 3rd Floor, Block 2, Phase 1 of Vision Shenzhen Business Park Keji
South Road, Hi-Tech Industrial Park, Shenzhen 518057, China
Date of Test : Jul. 03, 2018 ~ Jul. 19, 2018
Test Sample : Engineering Sample No.: D180705388 for conducted, D180705694 for
radiated.
Standard(s) : FCC Part15, Subpart C (15.247) / ANSI C63.10-2013

The above equipment has been tested and found compliance with the requirement of the relative standards by BTL Inc.

The test data, data evaluation, and equipment configuration contained in our test report (Ref No. BTL-FCCP-1-1807C001) were obtained utilizing the test procedures, test instruments, test sites that has been accredited by the Authority of NVLAP according to the ISO-17025 quality assessment standard and technical standard(s).

2. SUMMARY OF TEST RESULTS

Test procedures according to the technical standard(s):

Applied Standard(s): FCC Part15 (15.247) , Subpart C			
Standard(s) Section	Test Item	Judgment	Remark
15.207	Conducted Emission	PASS	
15.247(d)	Antenna conducted Spurious Emission	PASS	
15.247(a)(2)	6dB Bandwidth	PASS	
15.247(b)(3)	Peak Power	PASS	
15.247(e)	Power Spectral Density	PASS	
15.203	Antenna Requirement	PASS	
15.209/15.205	Transmitter Radiated Emissions	PASS	
15.209/15.205	Band Edge Emissions	PASS	

NOTE:

(1) "N/A" denotes test is not applicable to this device.

2.1 TEST FACILITY

The test facilities used to collect the test data in this report is at the location of No.3, Jinshagang 1st Road, Shixia, Dalang Town, Dongguan, Guangdong, China.

BTL's test firm number for FCC: 854385

BTL's designation number for FCC: CN5020

2.2 MEASUREMENT UNCERTAINTY

The measurement uncertainty figures shall be calculated according the methods described in the ETSI TR 100 028 and shall correspond to an expansion factor (coverage factor) $k=1.96$ or $k=2$ (which provide confidence levels of respectively 90% and 95.45% in the case where the distributions characterizing the actual measurement uncertainties are normal (Gaussian)). Measurement Uncertainty for a Level of Confidence of 95 %, $U=2xUc(y)$.

The BTL measurement uncertainty as below table:

A. Conducted Measurement:

Test Site	Method	Measurement Frequency Range	U, (dB)
DG-C02	CISPR	150 KHz ~ 30MHz	2.32

B. Radiated Measurement:

Test Site	Method	Measurement Frequency Range	Ant. H / V	U, (dB)
DG-CB03	CISPR	9KHz~30MHz	V	3.79
		9KHz~30MHz	H	3.57
		30MHz ~ 200MHz	V	3.82
		30MHz ~ 200MHz	H	3.78
		200MHz ~ 1,000MHz	V	4.10
		200MHz ~ 1,000MHz	H	4.06
		1GHz~18GHz	V	3.12
		1GHz~18GHz	H	3.68
		18GHz~40GHz	V	4.15
		18GHz~40GHz	H	4.14

Note: Unless specifically mentioned, the uncertainty of measurement has not been taken into account to declare the compliance or non-compliance to the specification.

3. GENERAL INFORMATION

3.1 GENERAL DESCRIPTION OF EUT

Equipment	Gaming Mouse	
Brand Name	RAZER	
Test Model	RC30-027101	
Series Model	N/A	
Model Difference	The system's model name is RZ01-0271XXXX-XXXX (X: Can be 0-9, A-Z), and the system is contain a Gaming Mouse (Model name: RC30-027101) and USB Dongle (Model name: DGRFG6).	
Product Description	Operation Frequency	2403-2479 MHz
	Modulation Technology	GFSK
	Bit Rate of Transmitter	2 Mbps
	Peak Power (Max.)	5.91 dBm
Power Source	#1 Supplied from USB port. #2 Supplied from battery.	
Power Rating	#1 5V \equiv 500mA #2 DC 3.8V 800mAh	

Note:

1. For a more detailed features description, please refer to the manufacturer's specifications or the user's manual.

2. Channel List:

Channel	Frequency (MHz)	Channel	Frequency (MHz)	Channel	Frequency (MHz)
01	2403	27	2429	53	2455
02	2404	28	2430	54	2456
03	2405	29	2431	55	2457
04	2406	30	2432	56	2458
05	2407	31	2433	57	2459
06	2408	32	2434	58	2460
07	2409	33	2435	59	2461
08	2410	34	2436	60	2462
09	2411	35	2437	61	2463
10	2412	36	2438	62	2464
11	2413	37	2439	63	2465
12	2414	38	2440	64	2466
13	2415	39	2441	65	2467
14	2416	40	2442	66	2468
15	2417	41	2443	67	2469
16	2418	42	2444	68	2470
17	2419	43	2445	69	2471
18	2420	44	2446	70	2472
19	2421	45	2447	71	2473
20	2422	46	2448	72	2474
21	2423	47	2449	73	2475
22	2424	48	2450	74	2476
23	2425	49	2451	75	2477
24	2426	50	2452	76	2478
25	2427	51	2453	77	2479
26	2428	52	2454		

3. Table for Filed Antenna:

Ant.	Brand	Model Name	Antenna Type	Connector	Gain (dBi)
1	N/A	N/A	Printed	N/A	2.09

3.2 DESCRIPTION OF TEST MODES

To investigate the maximum EMI emission characteristics generated from EUT, the test system was pre-scanning tested based on the consideration of following EUT operation mode or test configuration mode which possibly have effect on EMI emission level. Each of these EUT operation mode(s) or test configuration mode(s) mentioned above was evaluated respectively.

Pretest Mode	Description
Mode 1	TX Mode NOTE (1)

The EUT system operated these modes were found to be the worst case during the pre-scanning test as following:

For Conducted Test	
Final Test Mode	Description
Mode 1	TX Mode

For Radiated Test	
Final Test Mode	Description
Mode 1	TX Mode NOTE (1)

Note:

(1) The measurements are performed at the high, middle, low available channels.

3.3 TABLE OF PARAMETERS OF TEST SOFTWARE SETTING

During testing channel & power controlling software provided by the customer was used to control the operating channel as well as the output power level. The RF output power selection is for the setting of RF output power expected by the customer and is going to be fixed on the firmware of the final end product power parameters of WLAN

Test Software Version	N/A		
Frequency (MHz)	2403	2440	2479
Parameters	N/A	N/A	N/A

3.4 BLOCK DIAGRAM SHOWING THE CONFIGURATION OF SYSTEM TESTED

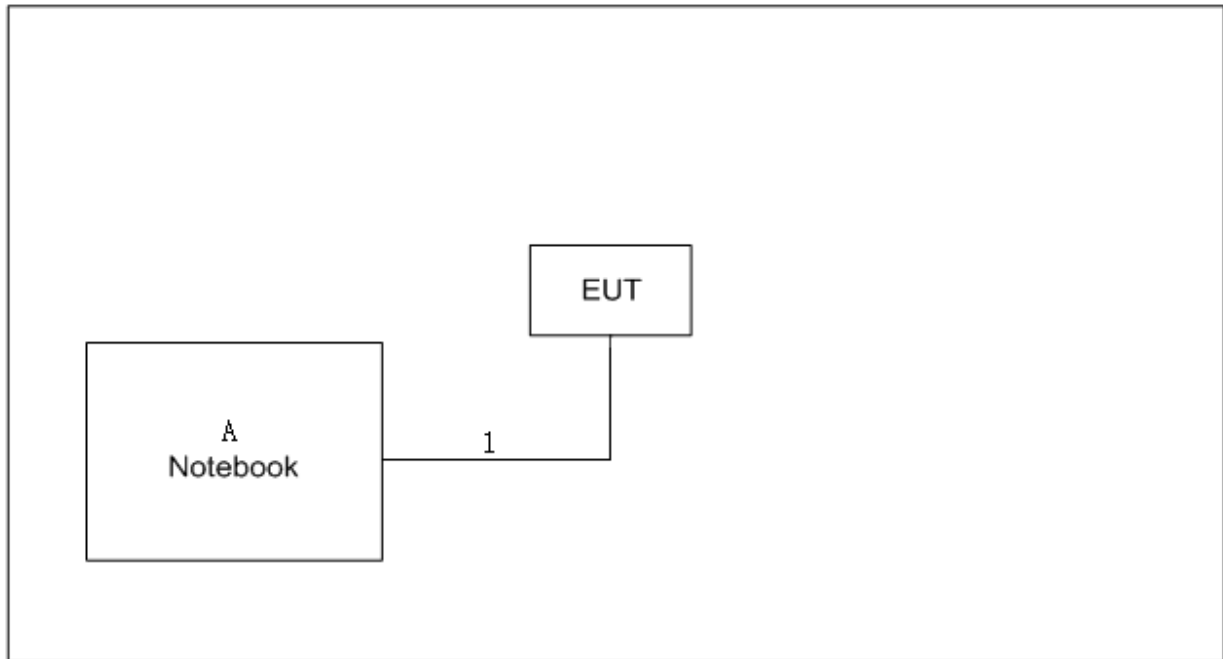

3.5 DESCRIPTION OF SUPPORT UNITS

The EUT has been tested as an independent unit together with other necessary accessories or support units. The following support units or accessories were used to form a representative test configuration during the tests.

Item	Equipment	Mfr/Brand	Model/Type No.	Series No.
A	Notebook	Lenovo	ThinkPadT410	N/A

Item	Shielded Type	Ferrite Core	Length	Note
1	YES	NO	2m	USB Cable

4. EMC EMISSION TEST

4.1 CONDUCTED EMISSION MEASUREMENT

4.1.1 POWER LINE CONDUCTED EMISSION LIMITS (Frequency Range 150KHz-30MHz)

Frequency of Emission (MHz)	Conducted Limit (dB μ V)	
	Quasi-peak	Average
0.15 -0.50	66 to 56*	56 to 46*
0.50 -5.0	56	46
5.0 -30.0	60	50

Note:

- (1) The limit of " * " decreases with the logarithm of the frequency
- (2) The test result calculated as following:
 Measurement Value = Reading Level + Correct Factor
 Correct Factor = Insertion Loss + Cable Loss + Attenuator Factor(if use)
 Margin Level = Measurement Value - Limit Value

The following table is the setting of the receiver

Receiver Parameters	Setting
Attenuation	10 dB
Start Frequency	0.15 MHz
Stop Frequency	30 MHz
IF Bandwidth	9 kHz

4.1.2 TEST PROCEDURE

- a. The EUT was placed 0.8 meters from the horizontal ground plane with EUT being connected to the power mains through a line impedance stabilization network (LISN). All other support equipments powered from additional LISN(s). The LISN provide 50 Ohm/ 50uH of coupling impedance for the measuring instrument.
- b. Interconnecting cables that hang closer than 40 cm to the ground plane shall be folded back and forth in the center forming a bundle 30 to 40 cm long.
- c. I/O cables that are not connected to a peripheral shall be bundled in the center. The end of the cable may be terminated, if required, using the correct terminating impedance. The overall length shall not exceed 1 m.
- d. LISN at least 80 cm from nearest part of EUT chassis.
- e. For the actual test configuration, please refer to the related Item –EUT Test Photos.

4.1.3 DEVIATION FROM TEST STANDARD

No deviation

4.1.4 TEST SETUP

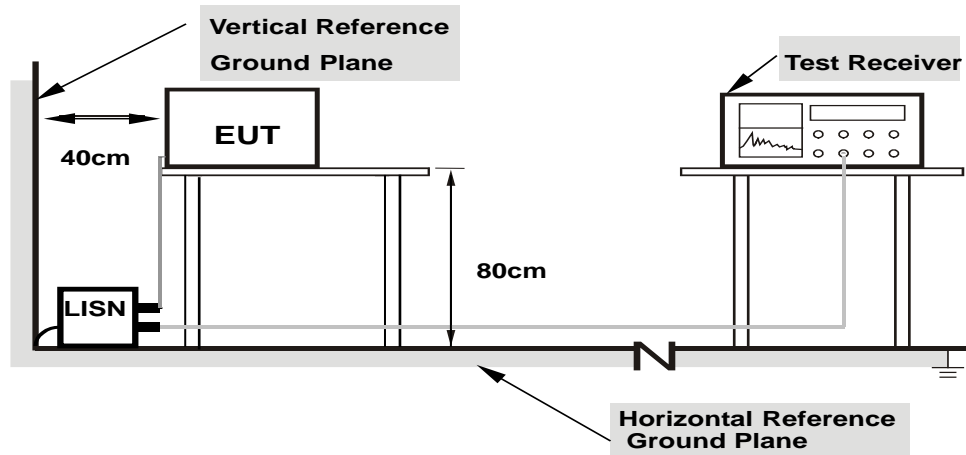

- Note:**
- 1.Support units were connected to second LISN.
 - 2.Both of LISNs (AMN) are 80 cm from EUT and at least 80 from other units and other metal planes

4.1.5 EUT OPERATING CONDITIONS

The EUT was configured for testing in a typical fashion (as a customer would normally use it). The EUT has been programmed to continuously transmit during test. This operating condition was tested and used to collect the included data.

4.1.6 EUT TEST CONDITIONS

Temperature: 25°C Relative Humidity: 53% Test Voltage: AC 120V/60Hz

4.1.7 TEST RESULTS

Please refer to the Appendix A.

Remark:

- (1) All readings are QP Mode value unless otherwise stated AVG in column of『Note』. If the QP Mode Measured value compliance with the QP Limits and lower than AVG Limits, the EUT shall be deemed to meet both QP & AVG Limits and then only QP Mode was measured, but AVG Mode didn't perform.In this case, a “ * ” marked in AVG Mode column of Interference Voltage Measured.
- (2) Measuring frequency range from 150KHz to 30MHz.
- (3) “ N/A” denotes test is not applicable to this device.

4.2 RADIATED EMISSION MEASUREMENT

4.2.1 RADIATED EMISSION LIMITS

In case the emission fall within the restricted band specified on 15.205(a), then the 15.209(a) limit in the table below has to be followed.

LIMITS OF RADIATED EMISSION MEASUREMENT (9KHz-1000MHz)

Frequency (MHz)	Field Strength (microvolts/meter)	Measurement Distance (meters)
0.009~0.490	2400/F(KHz)	300
0.490~1.705	24000/F(KHz)	30
1.705~30.0	30	30
30~88	100	3
88~216	150	3
216~960	200	3
960~1000	500	3

LIMITS OF RADIATED EMISSION MEASUREMENT (Above 1000MHz)

Frequency (MHz)	(dBuV/m) (at 3 meters)	
	PEAK	AVERAGE
Above 1000	74	54

Notes:

- (1) The limit for radiated test was performed according to FCC PART 15C.
- (2) The tighter limit applies at the band edges.
- (3) Emission level (dBuV/m)=20log Emission level (uV/m).
- (4) The test result calculated as following:
 Measurement Value = Reading Level + Correct Factor
 Correct Factor = Antenna Factor + Cable Loss - Amplifier Gain(if use)
 Margin Level = Measurement Value - Limit Value

Spectrum Parameter	Setting
Attenuation	Auto
Start Frequency	1000 MHz
Stop Frequency	10th carrier harmonic
RBW / VBW (Emission in restricted band)	RBW 1MHz VBW 3MHz peak detector for Pk value RMS detector for AV value

Receiver Parameter	Setting
Attenuation	Auto
Start ~ Stop Frequency	9KHz~90KHz for PK/AVG detector
Start ~ Stop Frequency	90KHz~110KHz for QP detector
Start ~ Stop Frequency	110KHz~490KHz for PK/AVG detector
Start ~ Stop Frequency	490KHz~30MHz for QP detector
Start ~ Stop Frequency	30MHz~1000MHz for QP detector

4.2.2 TEST PROCEDURE

- a. The measuring distance of 3 m shall be used for measurements. The EUT was placed on the top of a rotating table 0.8 meter above the ground at a 3 meter semi-anechoic chamber. The table was rotated 360 degrees to determine the position of the highest radiation.(below 1GHz)
- b. The measuring distance of 3 m shall be used for measurements. The EUT was placed on the top of a rotating table 1.5 meter above the ground at a 3 meter semi-anechoic chamber. The table was rotated 360 degrees to determine the position of the highest radiation.(above 1GHz)
- c. The height of the equipment or of the substitution antenna shall be 0.8 m or 1.5 m, the height of the test antenna shall vary between 1 m to 4 m. Both horizontal and vertical polarizations of the antenna are set to make the measurement.
- d. The initial step in collecting radiated emission data is a receiver peak detector mode pre-scanning the measurement frequency range. Significant peaks are then marked and then Quasi Peak detector mode re-measured.
- e. All readings are Peak unless otherwise stated QP in column of Note. Peak denotes that the Peak reading compliance with the QP Limits and then QP Mode measurement didn't perform. (below 1GHz)
- f. All readings are Peak Mode value unless otherwise stated AVG in column of Note. If the Peak Mode Measured value compliance with the Peak Limits and lower than AVG Limits, the EUT shall be deemed to meet both Peak & AVG Limits and then only Peak Mode was measured, but AVG Mode didn't perform. (above 1GHz)
- g. For the actual test configuration, please refer to the related Item –EUT Test Photos.

4.2.3 DEVIATION FROM TEST STANDARD

No deviation

4.2.4 TEST SETUP

(A) Radiated Emission Test Set-Up Frequency Below 1 GHz

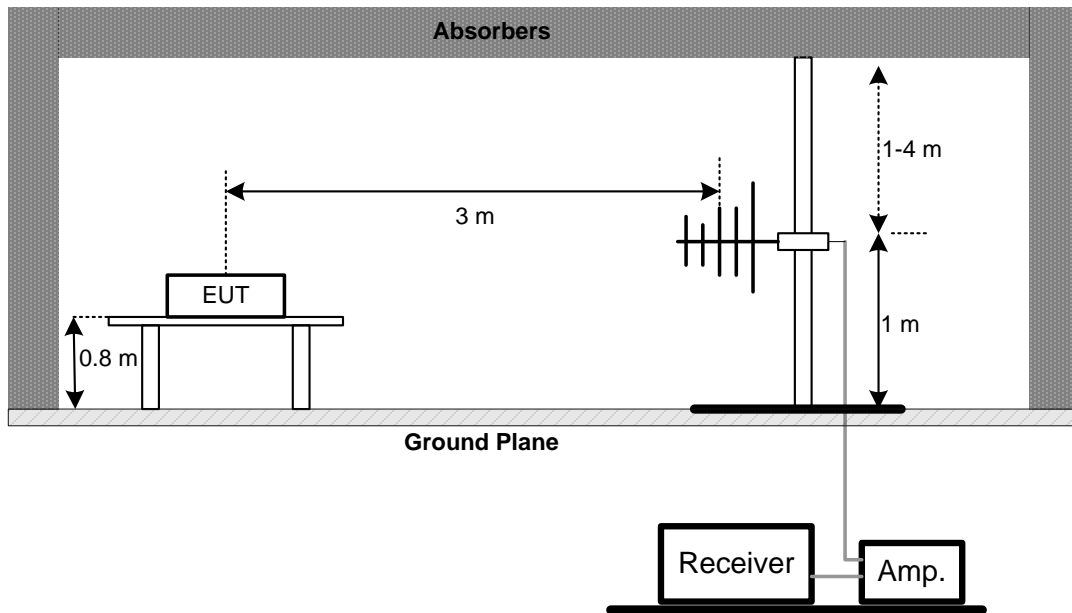

(B) Radiated Emission Test Set-Up Frequency Above 1 GHz

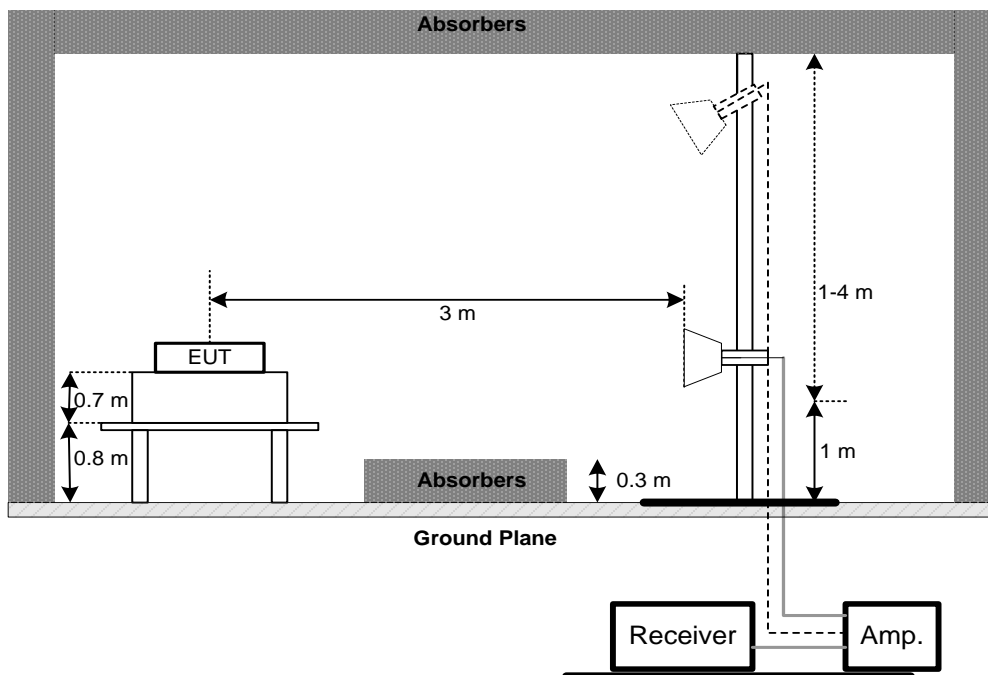

(C) For radiated emissions below 30MHz

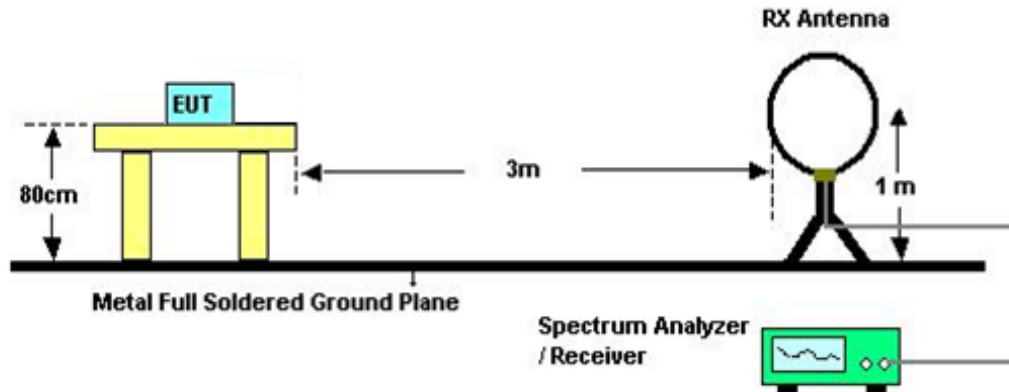

4.2.5 EUT OPERATING CONDITIONS

The EUT tested system was configured as the statements of 4.1.5 unless otherwise a special operating condition is specified in the follows during the testing.

4.2.6 EUT TEST CONDITIONS

Temperature: 25°C Relative Humidity: 60% Test Voltage: DC 5V

4.2.7 TEST RESULTS (9KHZ TO 30MHZ)

Please refer to the Appendix B

Remark:

- (1) The amplitude of spurious emissions which are attenuated by more than 20 dB below the permissible value has no need to be reported.
- (2) Distance extrapolation factor = $40 \log (\text{specific distance} / \text{test distance})$ (dB).
- (3) Limit line = specific limits (dBuV) + distance extrapolation factor.

4.2.8 TEST RESULTS (30MHZ TO 1000 MHZ)

Please refer to the Appendix C.

Remark:

- (1) All readings are Peak unless otherwise stated QP in column of 『Note』 . Peak denotes that the Peak reading compliance with the QP Limits and then QP Mode measurement didn't perform.
- (2) Measuring frequency range from 30MHz to 1000MHz.
- (3) If the peak scan value lower limit more than 20dB, then this signal data does not show in table.

4.2.9 TEST RESULTS (ABOVE 1000 MHZ)

Please refer to the Appendix D.

Remark:

- (1) All readings are Peak unless otherwise stated QP in column of 『Note』 . Peak denotes that the Peak reading compliance with the QP Limits and then QP Mode measurement didn't perform.
- (2) Radiated emissions measured in frequency range above 1000MHz were made with an instrument using Peak detector mode and AV detector mode of the emission
- (3) A preamp and high pass filter were used for this test in order to provide sufficient measurement sensitivity.
- (4) EUT Orthogonal Axis:
"X" - denotes Laid on Table ; "Y" - denotes Vertical Stand ; "Z" - denotes Side Stand
- (5) During the measurements above 1 GHz it is taken care of that the EUT is always within the 3 dB cone of radiation BW of the used antenna
- (6) No limit: This is fundamental signal, the judgment is not applicable.
For fundamental signal judgment was referred to Peak output test.

5. BANDWIDTH TEST

5.1 APPLIED PROCEDURES / LIMIT

FCC Part15 (15.247) , Subpart C				
Section	Test Item	Limit	Frequency Range (MHz)	Result
15.247(a)(2)	Bandwidth	$\geq 500\text{KHz}$ (6dB bandwidth)	2400-2483.5	PASS

5.1.1 TEST PROCEDURE

- The EUT was directly connected to the spectrum analyzer and antenna output port as show in the block diagram below,
- Spectrum Setting : RBW= 100KHz, VBW=300KHz, Sweep time = 2.5 ms.

5.1.2 DEVIATION FROM STANDARD

No deviation.

5.1.3 TEST SETUP

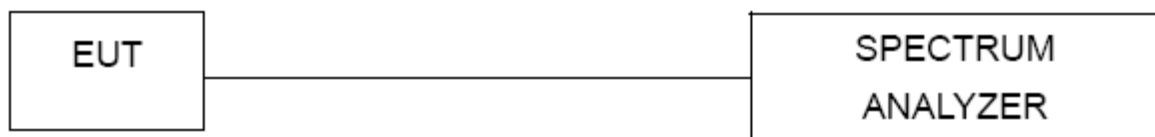

5.1.4 EUT OPERATION CONDITIONS

The EUT tested system was configured as the statements of 4.1.5 unless otherwise a special operating condition is specified in the follows during the testing.

5.1.5 EUT TEST CONDITIONS

Temperature: 25°C Relative Humidity: 60% Test Voltage: DC 5V

5.1.6 TEST RESULTS

Please refer to the Appendix E.

6. CONDUCTED OUTPUT POWER TEST

6.1 APPLIED PROCEDURES / LIMIT

FCC Part15 (15.247) , Subpart C				
Section	Test Item	Limit	Frequency Range (MHz)	Result
15.247(b)(3)	Maximum Output Power	1 watt or 30dBm	2400-2483.5	PASS

6.1.1 TEST PROCEDURE

- a. The EUT was directly connected to the spectrum analyzer and antenna output port as show in the block diagram below,
- b. The maximum conducted output power was performed in accordance with method 9.1.2 of FCC KDB 558074 D01 DTS Meas Guidance v03r05.

6.1.2 DEVIATION FROM STANDARD

No deviation.

6.1.3 TEST SETUP



6.1.4 EUT OPERATION CONDITIONS

The EUT tested system was configured as the statements of 4.1.5 unless otherwise a special operating condition is specified in the follows during the testing.

6.1.5 EUT TEST CONDITIONS

Temperature: 25°C Relative Humidity: 60% Test Voltage: DC 5V

6.1.6 TEST RESULTS

Please refer to the Appendix F.

7. ANTENNA CONDUCTED SPURIOUS EMISSION

7.1 APPLIED PROCEDURES / LIMIT

In any 100 kHz bandwidth outside the frequency band in which the spread spectrum or digitally modulated device is operating, the RF power that is produced shall be at least 20 dB below that in the 100 kHz bandwidth within the band that contains the highest level of the desired power, based on either an RF conducted or a radiated measurement, provided that the transmitter demonstrates compliance with the peak conducted power limits.

7.1.1 TEST PROCEDURE

- a. The EUT was directly connected to the spectrum analyzer and antenna output port as show in the block diagram below,
- b. Spectrum Setting : RBW= 100KHz, VBW=300KHz, Sweep time = 10 ms.

7.1.2 DEVIATION FROM STANDARD

No deviation.

7.1.3 TEST SETUP



7.1.4 EUT OPERATION CONDITIONS

The EUT tested system was configured as the statements of 4.1.5 unless otherwise a special operating condition is specified in the follows during the testing.

7.1.5 EUT OPERATION CONDITIONS

Temperature: 25°C Relative Humidity: 60% Test Voltage: DC 5V

7.1.6 TEST RESULTS

Please refer to the Appendix G.

8. POWER SPECTRAL DENSITY TEST

8.1 APPLIED PROCEDURES / LIMIT

FCC Part15 (15.247) , Subpart C				
Section	Test Item	Limit	Frequency Range (MHz)	Result
15.247(e)	Power Spectral Density	8 dBm (in any 3KHz)	2400-2483.5	PASS

8.1.1 TEST PROCEDURE

- a. The EUT was directly connected to the spectrum analyzer and antenna output port as show in the block diagram below,
- b. Spectrum Setting: RBW=3KHz, VBW=10 KHz, Sweep time = auto.

8.1.2 DEVIATION FROM STANDARD

No deviation.

8.1.3 TEST SETUP



8.1.4 EUT OPERATION CONDITIONS

The EUT tested system was configured as the statements of 4.1.5 unless otherwise a special operating condition is specified in the follows during the testing.

8.1.5 EUT TEST CONDITIONS

Temperature: 25°C Relative Humidity: 60% Test Voltage: DC 5V

8.1.6 TEST RESULTS

Please refer to the Appendix H.

9. MEASUREMENT INSTRUMENTS LIST

Conducted Emission Measurement					
Item	Kind of Equipment	Manufacturer	Type No.	Serial No.	Calibrated until
1	EMI Test Receiver	R&S	ESCI	100382	Mar. 11, 2019
2	LISN	EMCO	3816/2	52765	Mar. 11, 2019
3	50Ω Terminator	SHX	TF2-3G-A	8122901	Mar. 11, 2019
4	TWO-LINE V-NETWORK	R&S	ENV216	101447	Mar. 11, 2019
5	Measurement Software	Farad	EZ-EMC Ver.NB-03A1-01	N/A	N/A
6	Cable	N/A	RG223	12m	Oct. 19, 2018

Radiated Emission Measurement - Below 1GHz					
Item	Kind of Equipment	Manufacturer	Type No.	Serial No.	Calibrated until
1	Antenna	Schwarbeck	VULB9160	9160-3232	Mar. 11, 2019
2	Amplifier	HP	8447D	2944A09673	Oct. 19, 2018
3	Receiver	Agilent	N9038A	MY52130039	Aug. 20, 2018
4	Cable	emci	LMR-400(30MHz-1 GHz)(8m+5m)	N/A	May. 25, 2019
5	Controller	CT	SC100	N/A	N/A
6	Controller	MF	MF-7802	MF780208416	N/A
7	Measurement Software	Farad	EZ-EMC Ver.NB-03A1-01	N/A	N/A
8	Antenna	EM	EM-6876-1	230	Feb. 07, 2019

Radiated Emission Measurement - Above 1GHz					
Item	Kind of Equipment	Manufacturer	Type No.	Serial No.	Calibrated until
1	Double Ridged Guide Antenna	ETS	3115	75789	Mar. 11, 2019
2	Broad-Band Horn Antenna	Schwarzbeck	BBHA 9170	9170319	Jun. 30, 2019
3	Amplifier	Agilent	8449B	3008A02274	Mar. 11, 2019
4	Microwave Preamplifier With Adaptor	EMC INSTRUMENT	EMC2654045	980039 & HA01	Mar. 11, 2019
5	Receiver	Agilent	N9038A	MY52130039	Aug. 20, 2018
6	Controller	CT	SC100	N/A	N/A
7	Controller	MF	MF-7802	MF780208416	N/A
8	Cable	emci	CA500-SMSM-12M (1-26.5GHz)	N/A	Sep. 29, 2018
9	Measurement Software	Farad	EZ-EMC Ver.NB-03A1-01	N/A	N/A

6dB Bandwidth Measurement					
Item	Kind of Equipment	Manufacturer	Type No.	Serial No.	Calibrated until
1	Spectrum Analyzer	R&S	FSP40	100185	Aug. 20, 2018

Conducted Output Power Measurement					
Item	Kind of Equipment	Manufacturer	Type No.	Serial No.	Calibrated until
1	Spectrum Analyzer	R&S	FSP40	100185	Aug. 20, 2018

Antenna Conducted Spurious Emission Measurement					
Item	Kind of Equipment	Manufacturer	Type No.	Serial No.	Calibrated until
1	Spectrum Analyzer	R&S	FSP40	100185	Aug. 20, 2018

Power Spectral Density Measurement					
Item	Kind of Equipment	Manufacturer	Type No.	Serial No.	Calibrated until
1	Spectrum Analyzer	R&S	FSP40	100185	Aug. 20, 2018

Remark: "N/A" denotes no model name, serial no. or calibration specified.

All calibration period of equipment list is one year.

APPENDIX A - CONDUCTED EMISSION

Test Mode: TX Mode

Line

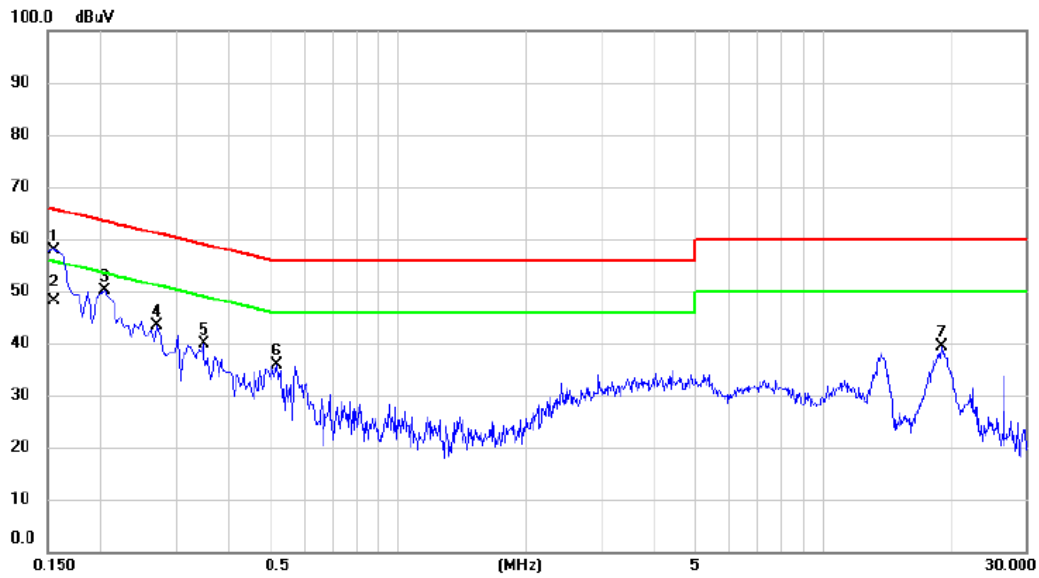

No.	Mk.	Freq. MHz	Reading Level dBuV	Correct Factor dB	Measure- ment dBuV	Limit dBuV	Margin dB	Detector	Comment
1		0.1545	48.18	9.82	58.00	65.75	-7.75	peak	
2	*	0.1545	38.20	9.82	48.02	55.75	-7.73	AVG	
3		0.2040	40.21	9.82	50.03	63.45	-13.42	peak	
4		0.2714	33.45	9.82	43.27	61.07	-17.80	peak	
5		0.3480	29.96	9.81	39.77	59.01	-19.24	peak	
6		0.5190	26.14	9.80	35.94	56.00	-20.06	peak	
7		18.9825	28.17	11.10	39.27	60.00	-20.73	peak	

Test Mode: TX Mode

Neutral

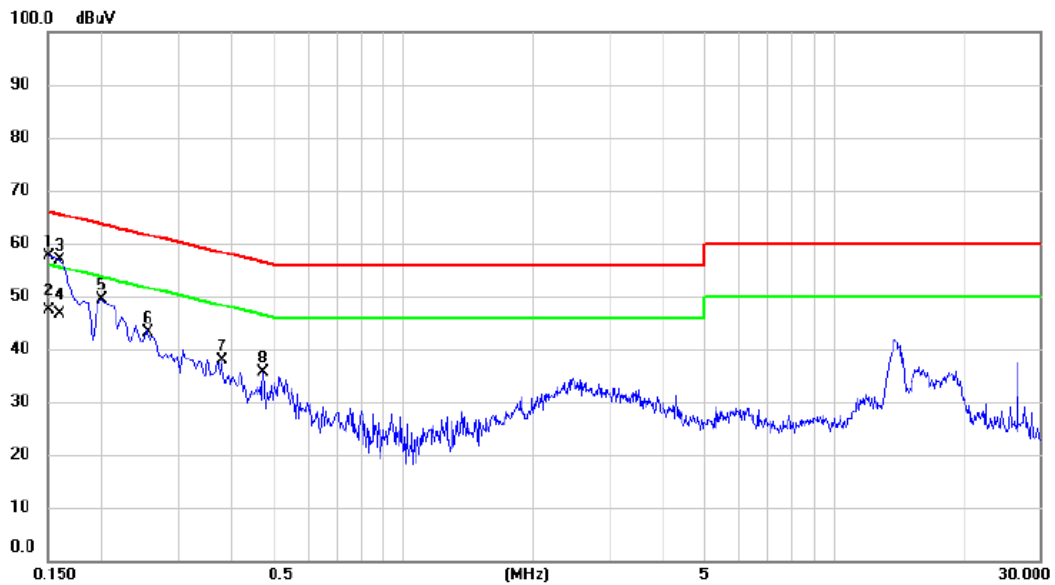

No.	Mk.	Freq. MHz	Reading Level dBuV	Correct Factor dB	Measure- ment dBuV	Limit dBuV	Margin dB	Detector	Comment
1	*	0.1500	47.74	9.91	57.65	66.00	-8.35	peak	
2		0.1500	37.50	9.91	47.41	56.00	-8.59	AVG	
3		0.1590	46.89	9.91	56.80	65.52	-8.72	peak	
4		0.1590	36.70	9.91	46.61	55.52	-8.91	AVG	
5		0.1995	39.40	9.91	49.31	63.63	-14.32	peak	
6		0.2548	33.18	9.92	43.10	61.60	-18.50	peak	
7		0.3795	28.04	9.95	37.99	58.29	-20.30	peak	
8		0.4740	25.77	9.95	35.72	56.44	-20.72	peak	

APPENDIX B - RADIATED EMISSION (9KHZ TO 30MHZ)

Test Mode: TX Mode

Ant 0°

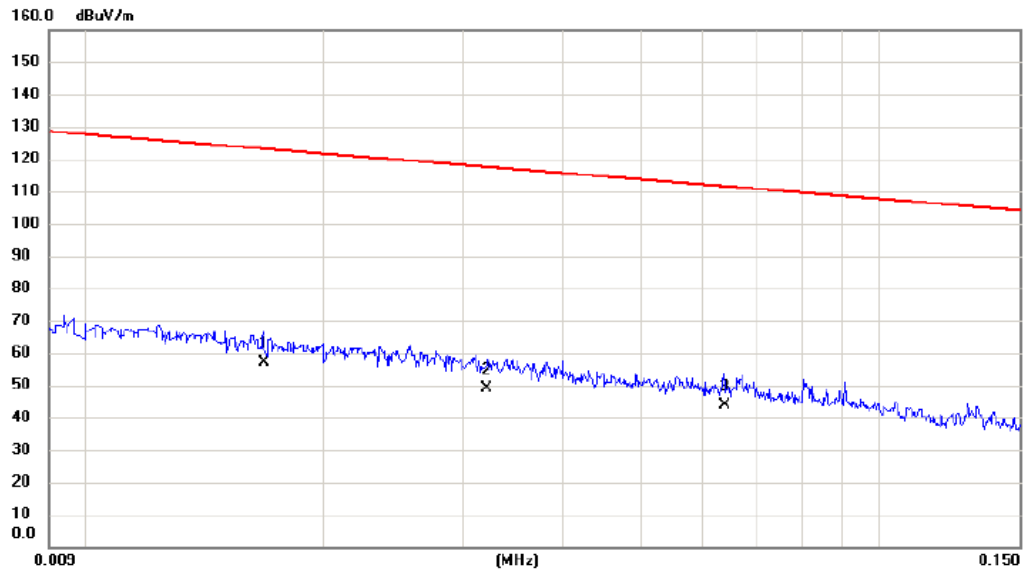

No.	Mk.	Freq. MHz	Reading Level dBuV	Correct Factor dB	Measure- ment dBuV/m	Limit dBuV/m	Margin dB	Detector	Comment
1	*	0.0168	36.40	20.47	56.87	123.10	-66.23	AVG	
2		0.0321	29.10	19.82	48.92	117.47	-68.55	AVG	
3		0.0638	24.70	19.25	43.95	111.51	-67.56	AVG	

Test Mode: TX Mode

Ant 0°

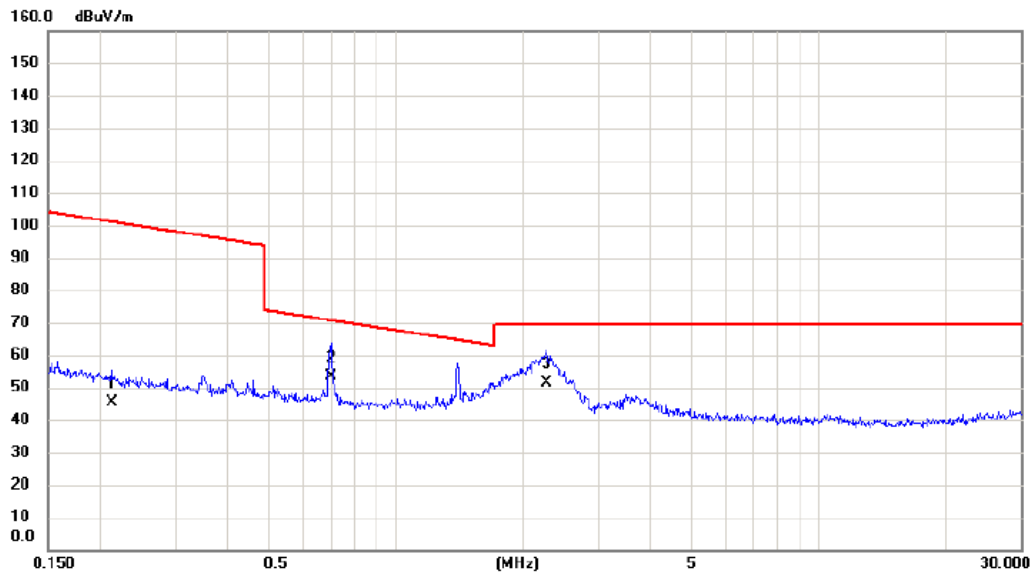

No.	Mk.	Freq.	Reading Level	Correct Factor	Measurement	Limit	Margin	Detector	Comment
		MHz	dBuV	dB	dBuV/m	dBuV/m	dB		
1		0.2128	28.30	17.12	45.42	101.05	-55.63	AVG	
2	*	0.7010	36.50	16.90	53.40	70.69	-17.29	QP	
3		2.2726	34.60	16.96	51.56	69.54	-17.98	QP	

Test Mode: TX Mode

Ant 90°

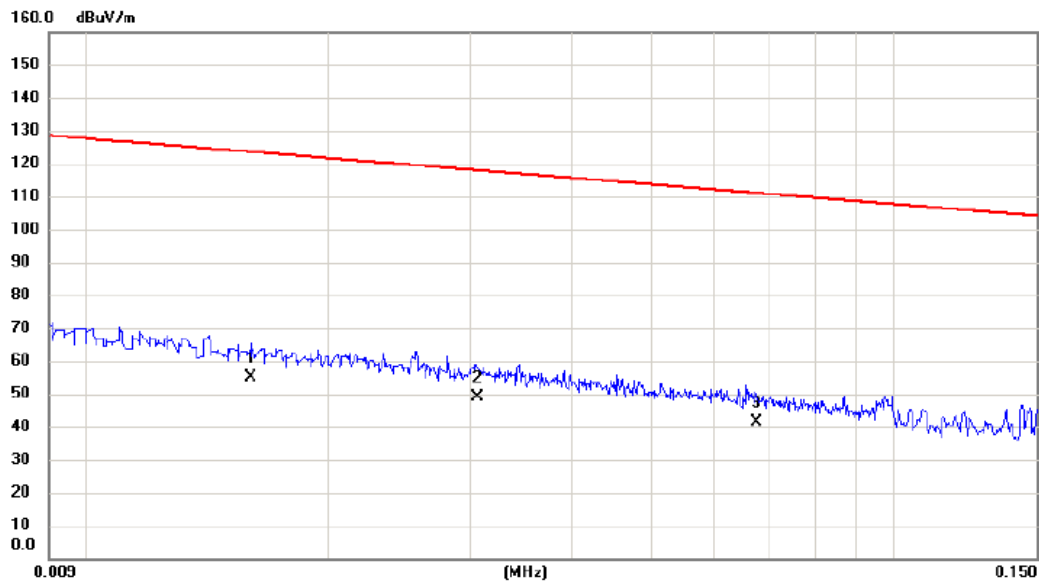

No.	Mk.	Freq. MHz	Reading Level dBuV	Correct Factor dB	Measure- ment dBuV/m	Limit dBuV/m	Margin dB	Detector	Comment
1	*	0.0160	34.50	20.58	55.08	123.52	-68.44	AVG	
2		0.0305	29.30	19.84	49.14	117.92	-68.78	AVG	
3		0.0675	22.10	19.18	41.28	111.02	-69.74	AVG	

Test Mode: TX Mode

Ant 90°

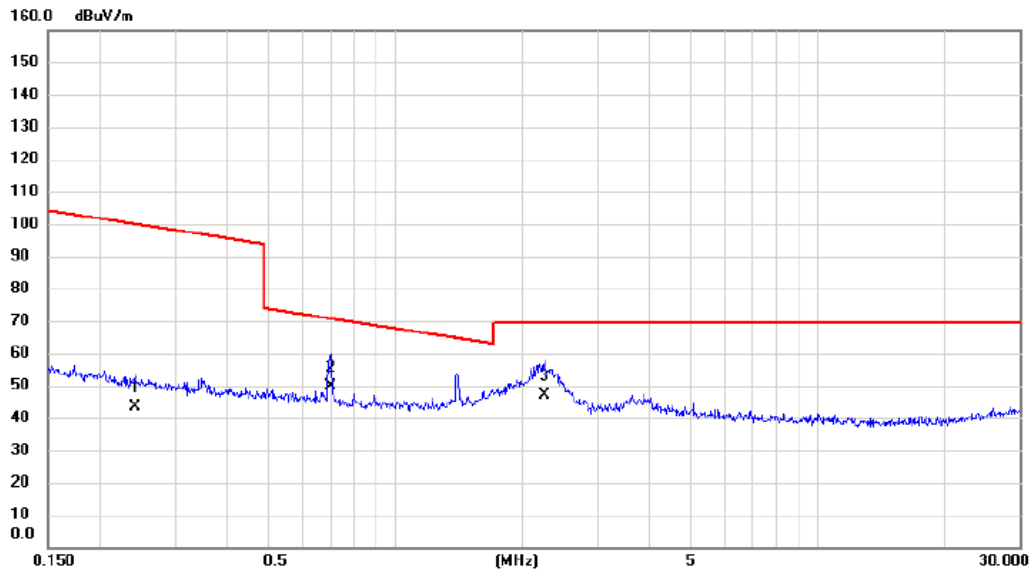

No.	Mk.	Freq. MHz	Reading Level dBuV	Correct Factor dB	Measure- ment dBuV/m	Limit dBuV/m	Margin dB	Detector	Comment
1		0.2416	26.50	17.08	43.58	99.94	-56.36	AVG	
2	*	0.7010	33.10	16.90	50.00	70.69	-20.69	QP	
3		2.2486	30.20	16.96	47.16	69.54	-22.38	QP	

APPENDIX C - RADIATED EMISSION (30MHZ TO 1000MHZ)

Test Mode: TX 2403 MHz

Vertical

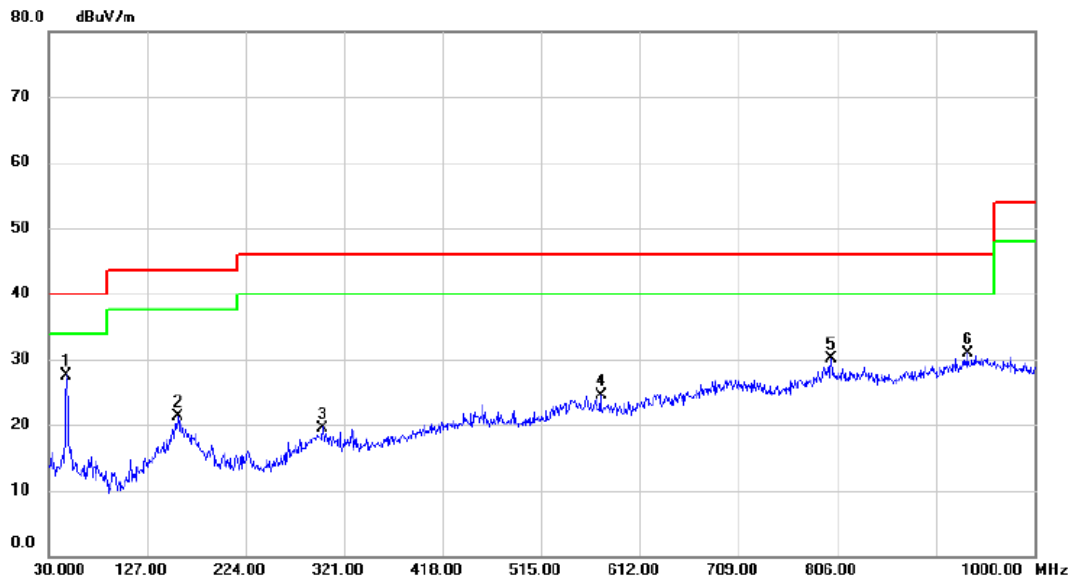

No.	Mk.	Freq. MHz	Reading Level dBuV	Correct Factor dB	Measure- ment dBuV/m	Limit dBuV/m	Margin dB	Detector	Comment
1	*	47.460	42.40	-14.80	27.60	40.00	-12.40	peak	
2		157.070	32.15	-10.86	21.29	43.50	-22.21	peak	
3		299.660	29.99	-10.39	19.60	46.00	-26.40	peak	
4		573.200	30.31	-5.85	24.46	46.00	-21.54	peak	
5		800.180	31.12	-1.04	30.08	46.00	-15.92	peak	
6		934.040	30.06	0.78	30.84	46.00	-15.16	peak	

Test Mode: TX 2403 MHz

Horizontal

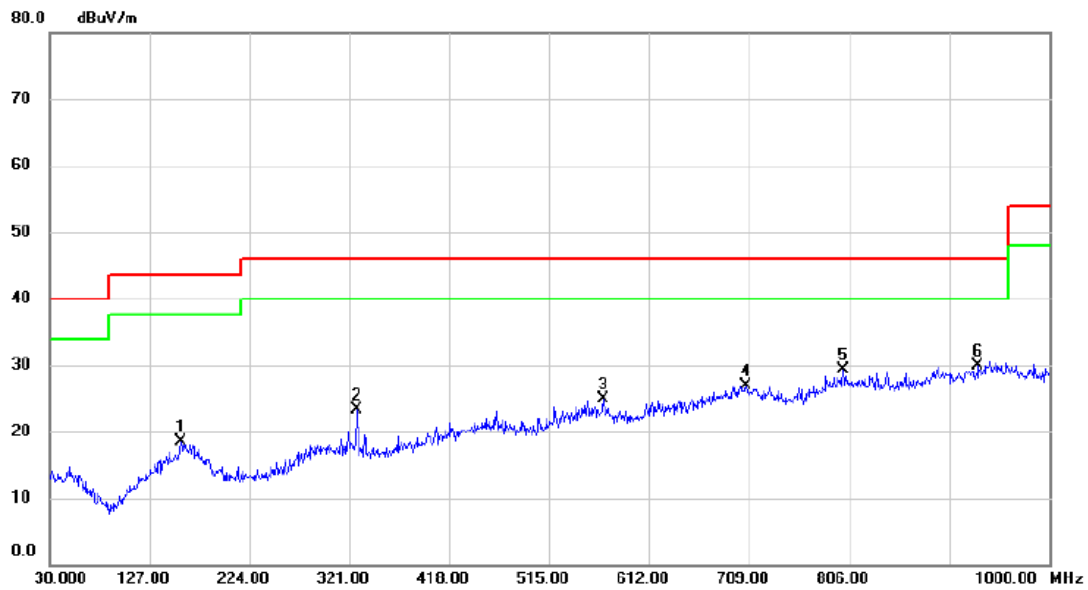

No.	Mk.	Freq. MHz	Reading Level dBuV	Correct Factor dB	Measure- ment dBuV/m	Limit dBuV/m	Margin dB	Detector	Comment
1		157.070	29.33	-10.86	18.47	43.50	-25.03	peak	
2		327.790	34.08	-10.77	23.31	46.00	-22.69	peak	
3		567.380	30.76	-5.76	25.00	46.00	-21.00	peak	
4		706.090	29.90	-2.90	27.00	46.00	-19.00	peak	
5		800.180	30.35	-1.04	29.31	46.00	-16.69	peak	
6	*	931.130	29.16	0.66	29.82	46.00	-16.18	peak	

Test Mode: TX 2440 MHz

Vertical

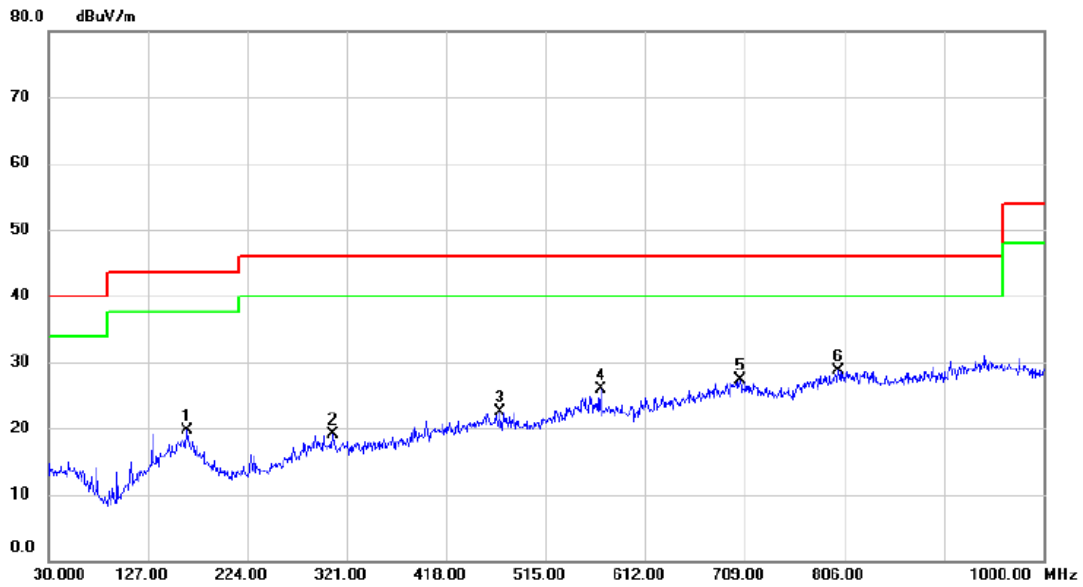

No.	Mk.	Freq. MHz	Reading Level dBuV	Correct Factor dB	Measure- ment dBuV/m	Limit dBuV/m	Margin dB	Detector	Comment
1		164.830	30.65	-10.90	19.75	43.50	-23.75	peak	
2		307.420	29.56	-10.47	19.09	46.00	-26.91	peak	
3		470.380	30.32	-7.86	22.46	46.00	-23.54	peak	
4		568.350	31.64	-5.76	25.88	46.00	-20.12	peak	
5		704.150	30.18	-2.84	27.34	46.00	-18.66	peak	
6	*	800.180	29.73	-1.04	28.69	46.00	-17.31	peak	

Test Mode: TX 2440 MHz

Horizontal

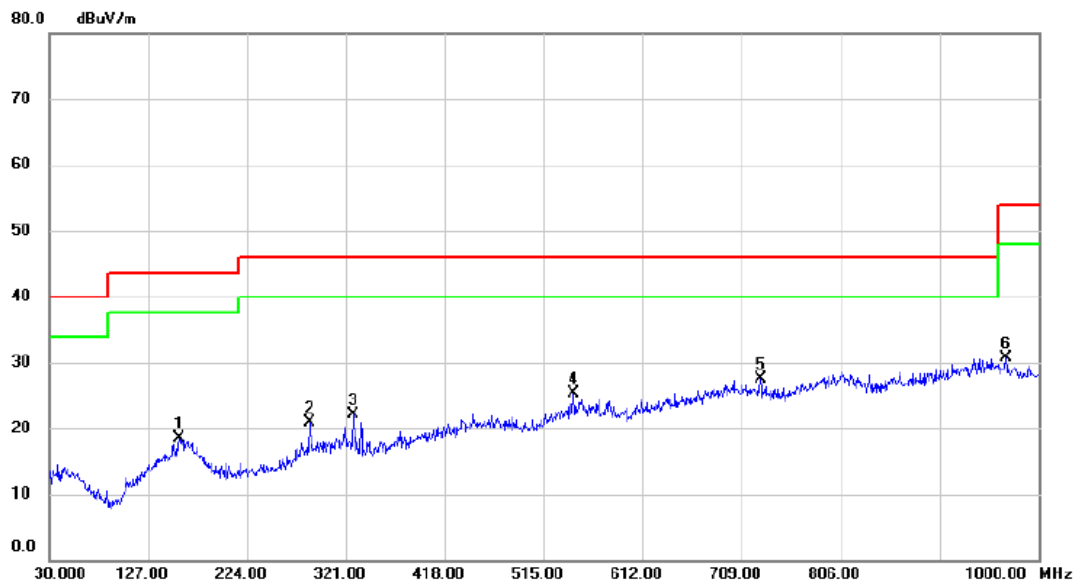

No. Mk.	Freq. MHz	Reading Level dBuV	Correct Factor dB	Measure- ment dBuV/m	Limit dBuV/m	Margin dB	Detector	Comment
1	157.070	29.29	-10.86	18.43	43.50	-25.07	peak	
2	285.110	32.08	-11.14	20.94	46.00	-25.06	peak	
3	327.790	32.89	-10.77	22.12	46.00	-23.88	peak	
4	544.100	31.13	-5.82	25.31	46.00	-20.69	peak	
5 *	727.430	30.93	-3.46	27.47	46.00	-18.53	peak	
6	967.990	29.65	0.98	30.63	54.00	-23.37	peak	

Test Mode: TX 2479 MHz

Vertical

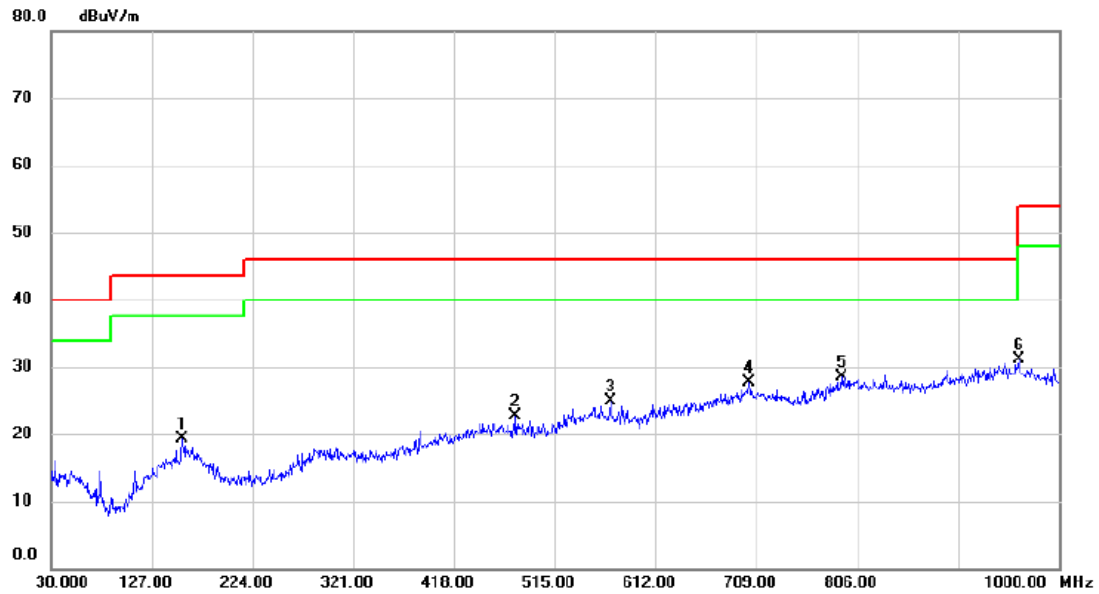

No.	Mk.	Freq. MHz	Reading Level dBuV	Correct Factor dB	Measure- ment dBuV/m	Limit dBuV/m	Margin dB	Detector	Comment
1		156.100	30.16	-10.94	19.22	43.50	-24.28	peak	
2		477.170	30.71	-8.01	22.70	46.00	-23.30	peak	
3		568.350	30.71	-5.76	24.95	46.00	-21.05	peak	
4		702.210	30.46	-2.80	27.66	46.00	-18.34	peak	
5	*	790.480	30.07	-1.61	28.46	46.00	-17.54	peak	
6		961.200	29.90	1.14	31.04	54.00	-22.96	peak	

Test Mode: TX 2479 MHz

Horizontal

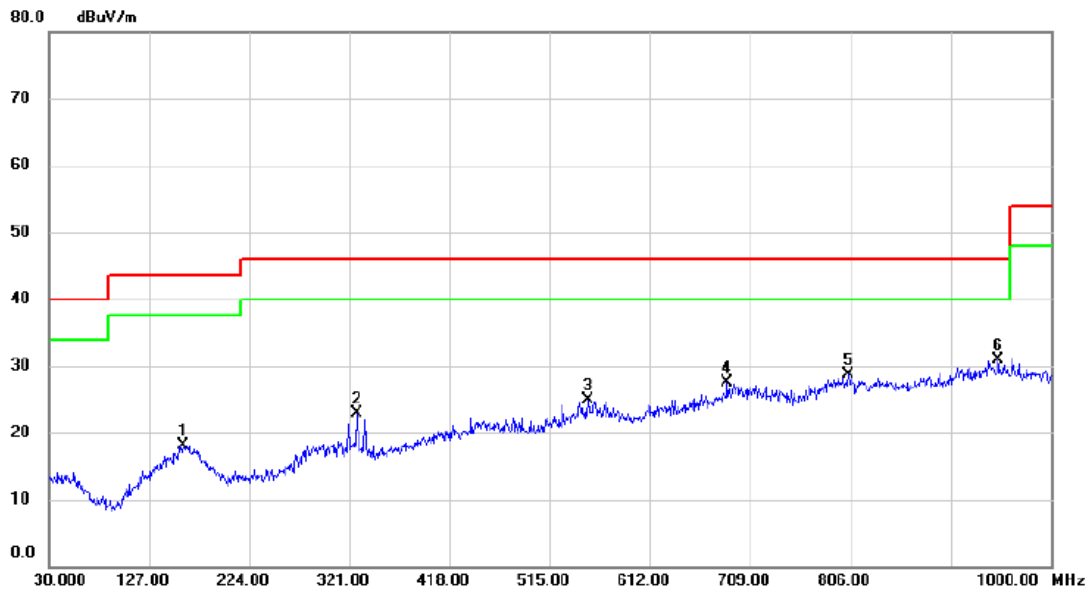

No.	Mk.	Freq. MHz	Reading Level dBuV	Correct Factor dB	Measure- ment dBuV/m	Limit dBuV/m	Margin dB	Detector	Comment
1		159.980	28.76	-10.60	18.16	43.50	-25.34	peak	
2		327.790	33.70	-10.77	22.93	46.00	-23.07	peak	
3		551.860	30.47	-5.49	24.98	46.00	-21.02	peak	
4		686.690	30.82	-3.40	27.42	46.00	-18.58	peak	
5		804.060	29.85	-1.10	28.75	46.00	-17.25	peak	
6 *		948.590	29.58	1.35	30.93	46.00	-15.07	peak	

APPENDIX D - RADIATED EMISSION (ABOVE 1000MHZ)

Test Mode TX Mode_2403 MHz

Vertical

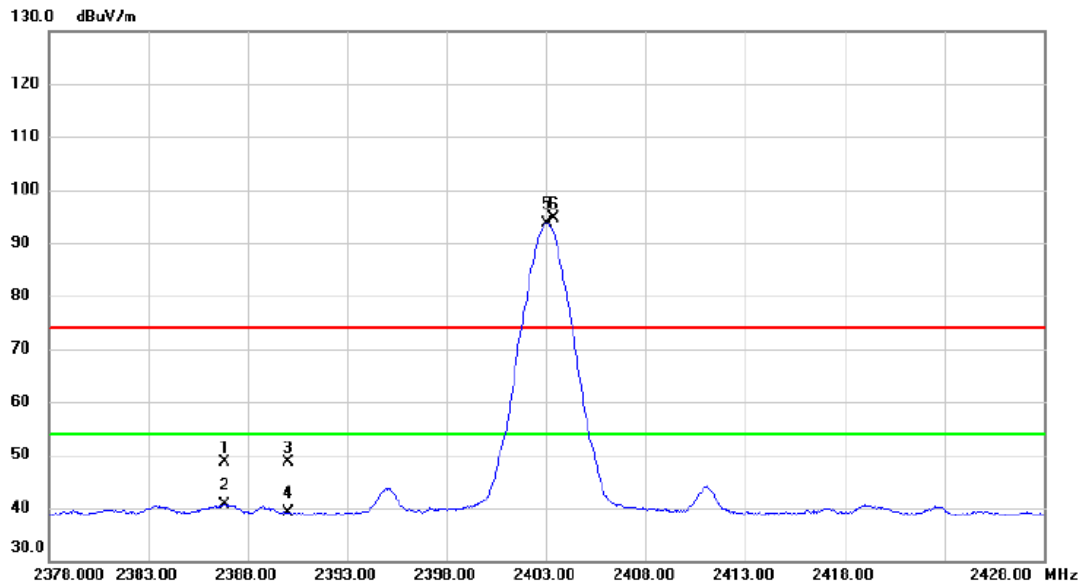

No.	Mk.	Freq. MHz	Reading Level dBuV	Correct Factor dB	Measure- ment dBuV/m	Limit dBuV/m	Margin dB	Detector	Comment
1		2386.800	37.41	11.32	48.73	74.00	-25.27	peak	
2		2386.800	29.40	11.32	40.72	54.00	-13.28	AVG	
3		2390.000	37.44	11.31	48.75	74.00	-25.25	peak	
4		2390.000	27.70	11.31	39.01	54.00	-14.99	AVG	
5	*	2403.050	82.33	11.33	93.66	54.00	39.66	AVG	No Limit
6	X	2403.350	83.34	11.33	94.67	74.00	20.67	peak	No Limit

Test Mode	TX Mode_2403 MHz
-----------	------------------

Vertical

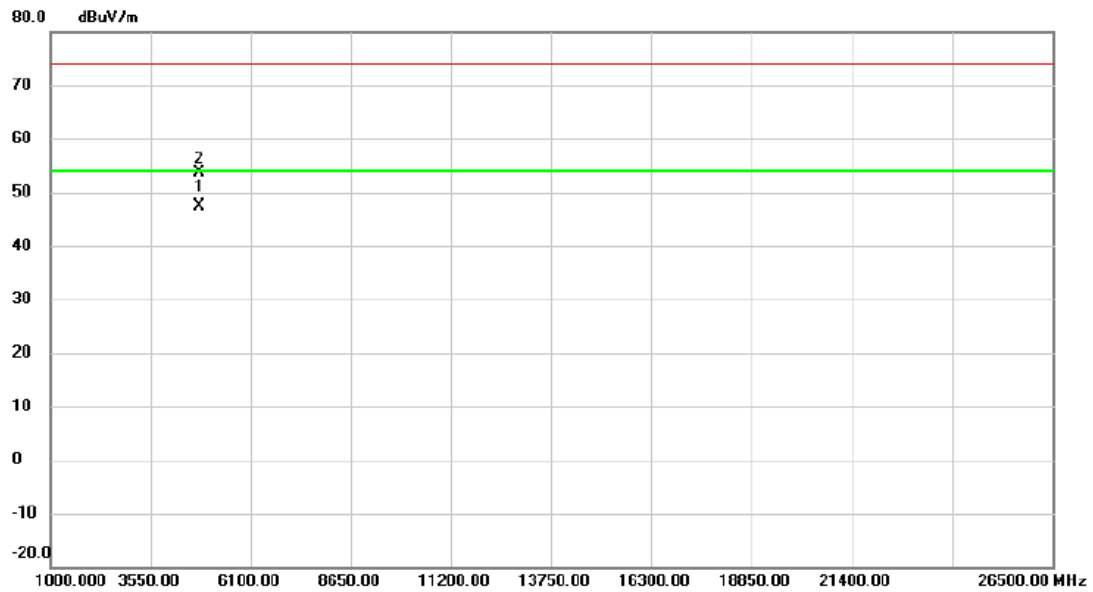

No.	Mk.	Freq.	Reading Level	Correct Factor	Measurement	Limit	Margin	Detector	Comment
		MHz	dBuV	dB	dBuV/m	dBuV/m	dB		
1	*	4805.954	37.34	9.96	47.30	54.00	-6.70	AVG	
2		4806.640	43.75	9.97	53.72	74.00	-20.28	peak	

Test Mode TX Mode_2403 MHz

Horizontal

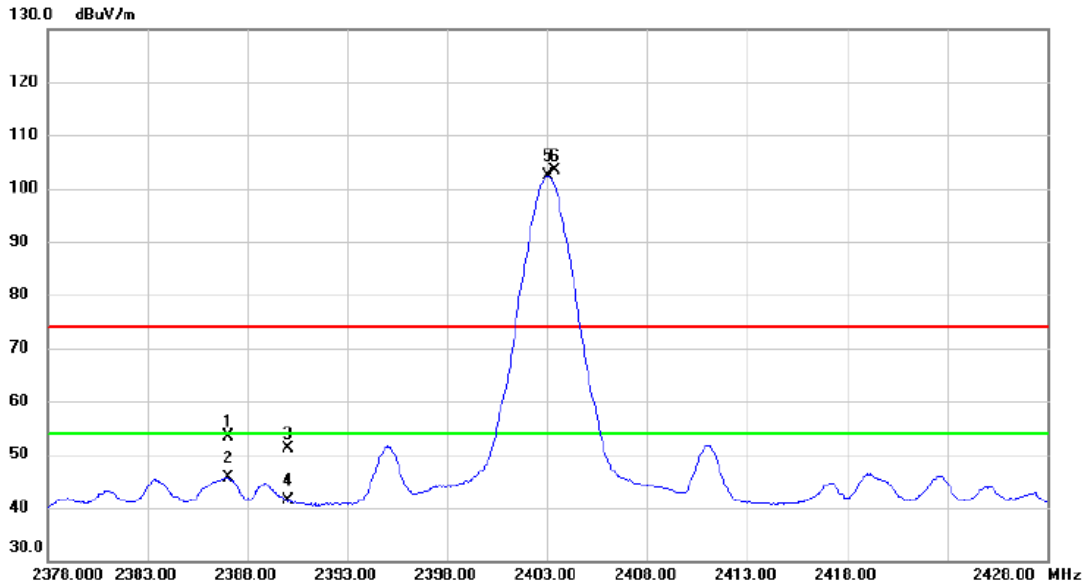

No.	Mk.	Freq. MHz	Reading Level dBuV	Correct Factor dB	Measure- ment dBuV/m	Limit dBuV/m	Margin dB	Detector	Comment
1		2387.050	41.97	11.32	53.29	74.00	-20.71	peak	
2		2387.050	34.42	11.32	45.74	54.00	-8.26	AVG	
3		2390.000	39.91	11.31	51.22	74.00	-22.78	peak	
4		2390.000	29.98	11.31	41.29	54.00	-12.71	AVG	
5	*	2403.050	91.02	11.33	102.35	54.00	48.35	AVG	No Limit
6	X	2403.350	92.05	11.33	103.38	74.00	29.38	peak	No Limit

Test Mode	TX Mode_2403 MHz
-----------	------------------

Horizontal

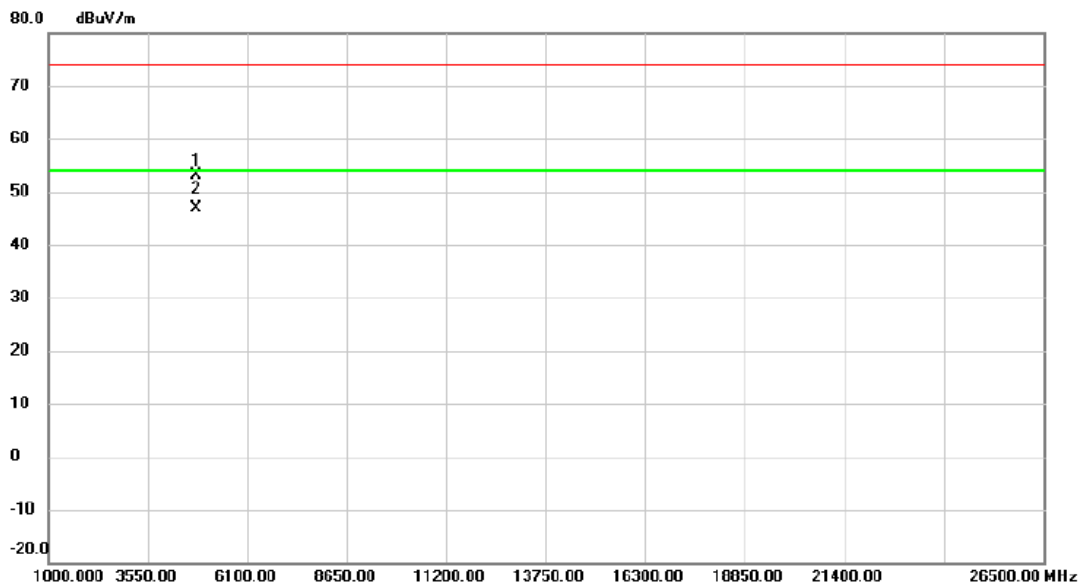

No.	Mk.	Freq.	Reading Level	Correct Factor	Measurement	Limit	Margin	Detector	Comment
		MHz	dBuV	dB	dBuV/m	dBuV/m	dB		
1		4806.016	43.19	9.96	53.15	74.00	-20.85	peak	
2	*	4806.022	36.90	9.96	46.86	54.00	-7.14	AVG	

Test Mode TX Mode_2440 MHz

Vertical

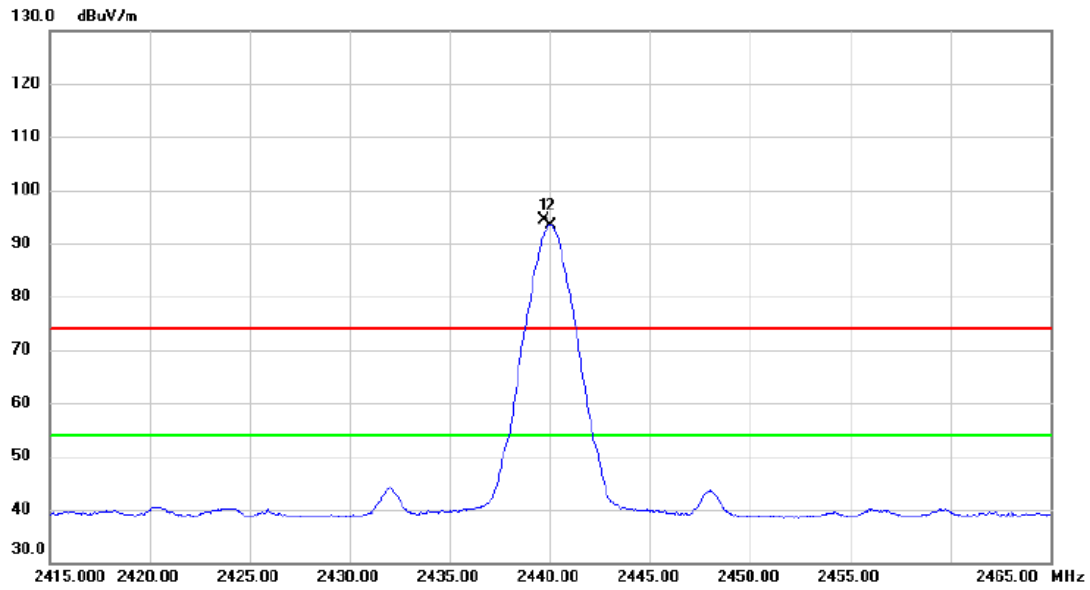

No.	Mk.	Freq. MHz	Reading Level dBuV	Correct Factor dB	Measure- ment dBuV/m	Limit dBuV/m	Margin dB	Detector	Comment
1	X	2439.700	83.07	11.33	94.40	74.00	20.40	peak	No Limit
2	*	2440.050	82.10	11.33	93.43	54.00	39.43	AVG	No Limit

Test Mode TX Mode_2440 MHz

Vertical

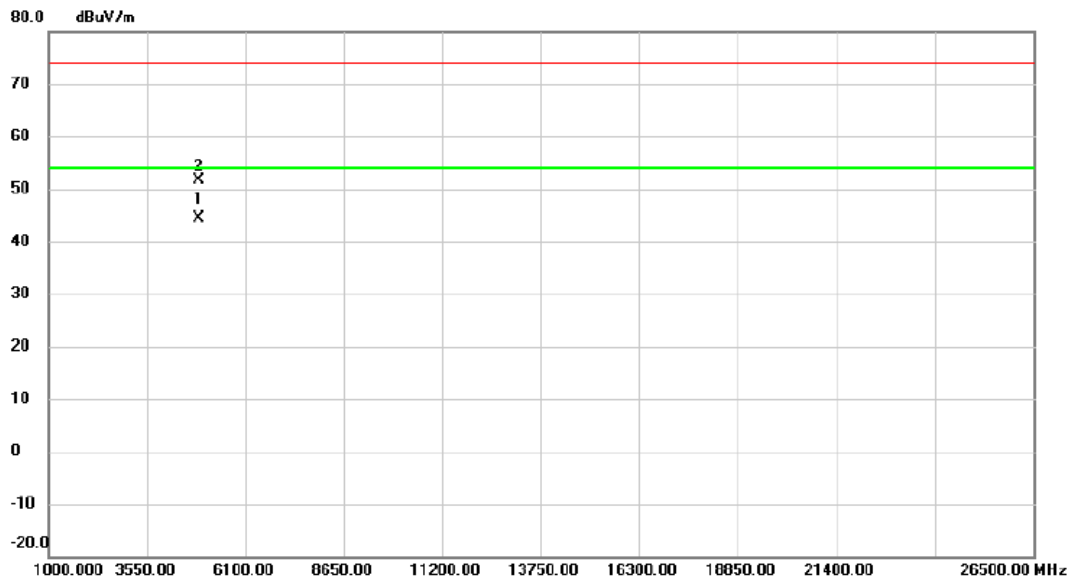

No.	Mk.	Freq. MHz	Reading Level dBuV	Correct Factor dB	Measure- ment dBuV/m	Limit dBuV/m	Margin dB	Detector	Comment
1	*	4880.108	34.20	10.16	44.36	54.00	-9.64	AVG	
2		4880.500	41.46	10.16	51.62	74.00	-22.38	peak	

Test Mode TX Mode_2440 MHz

Horizontal

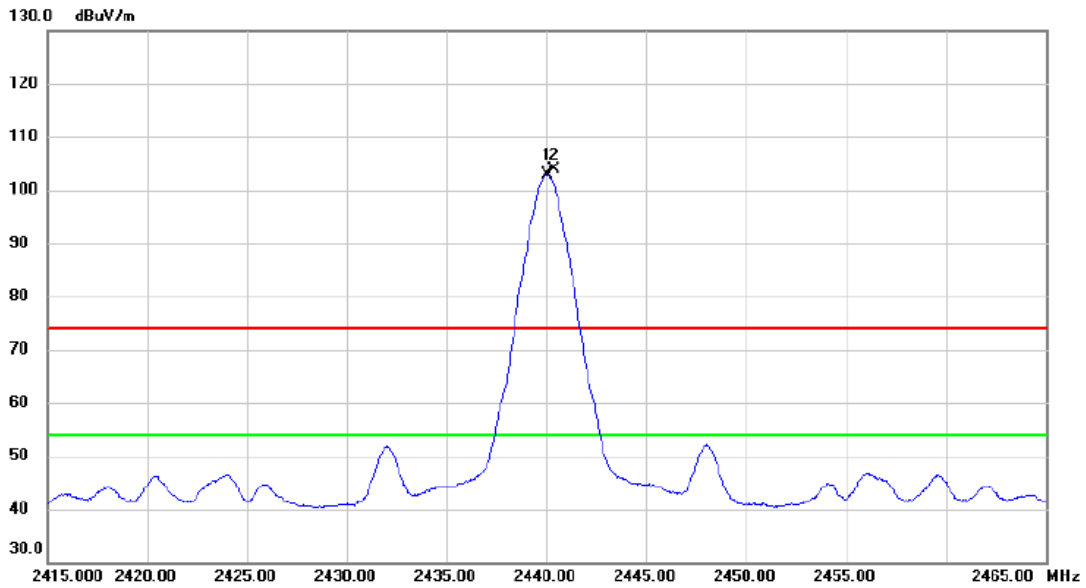

No.	Mk.	Freq.	Reading Level	Correct Factor	Measurement	Limit	Margin	Detector	Comment
		MHz	dBuV	dB	dBuV/m	dBuV/m	dB		
1	*	2440.000	91.53	11.33	102.86	54.00	48.86	AVG	No Limit
2	X	2440.350	92.52	11.33	103.85	74.00	29.85	peak	No Limit

Test Mode TX Mode_2440 MHz

Horizontal

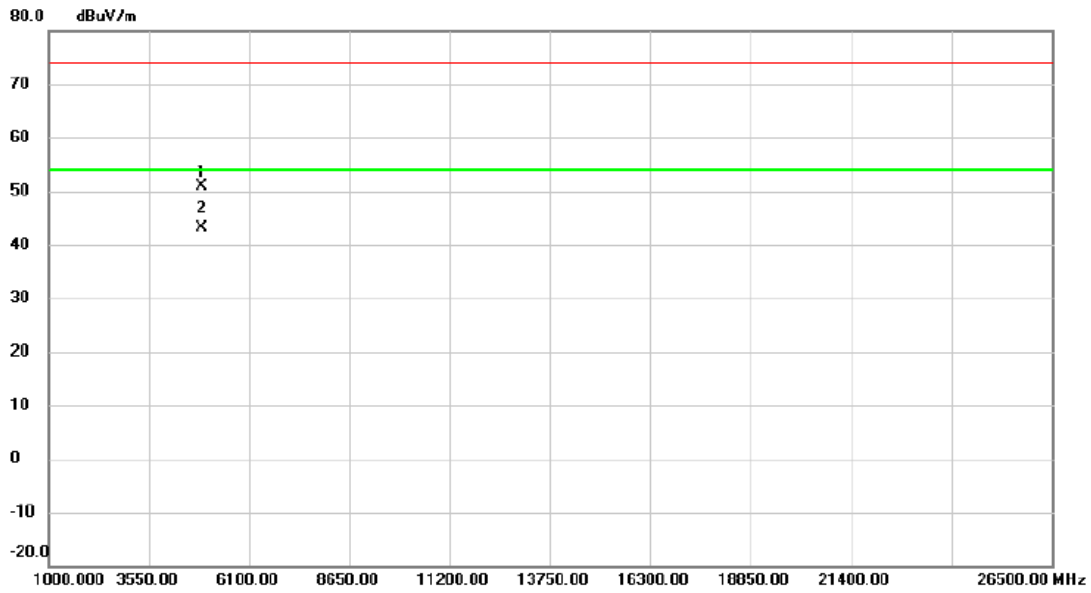

No.	Mk.	Freq. MHz	Reading Level dBuV	Correct Factor dB	Measure- ment dBuV/m	Limit dBuV/m	Margin dB	Detector	Comment
1		4879.384	40.66	10.16	50.82	74.00	-23.18	peak	
2	*	4880.304	33.06	10.16	43.22	54.00	-10.78	AVG	

Test Mode TX Mode_2479 MHz

Vertical

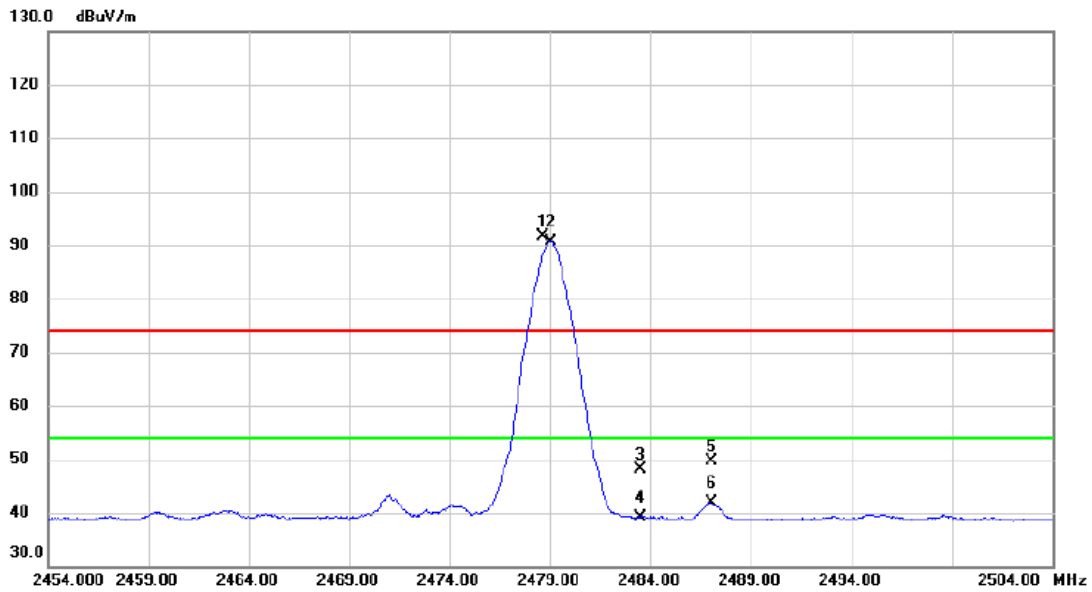

No.	Mk.	Freq. MHz	Reading Level dBuV	Correct Factor dB	Measure- ment dBuV/m	Limit dBuV/m	Margin dB	Detector	Comment
1	X	2478.650	80.25	11.34	91.59	74.00	17.59	peak	No Limit
2	*	2479.050	79.22	11.34	90.56	54.00	36.56	AVG	No Limit
3		2483.500	36.81	11.34	48.15	74.00	-25.85	peak	
4		2483.500	27.84	11.34	39.18	54.00	-14.82	AVG	
5		2487.000	38.25	11.35	49.60	74.00	-24.40	peak	
6		2487.000	30.57	11.35	41.92	54.00	-12.08	AVG	

Test Mode TX Mode_2479 MHz

Vertical

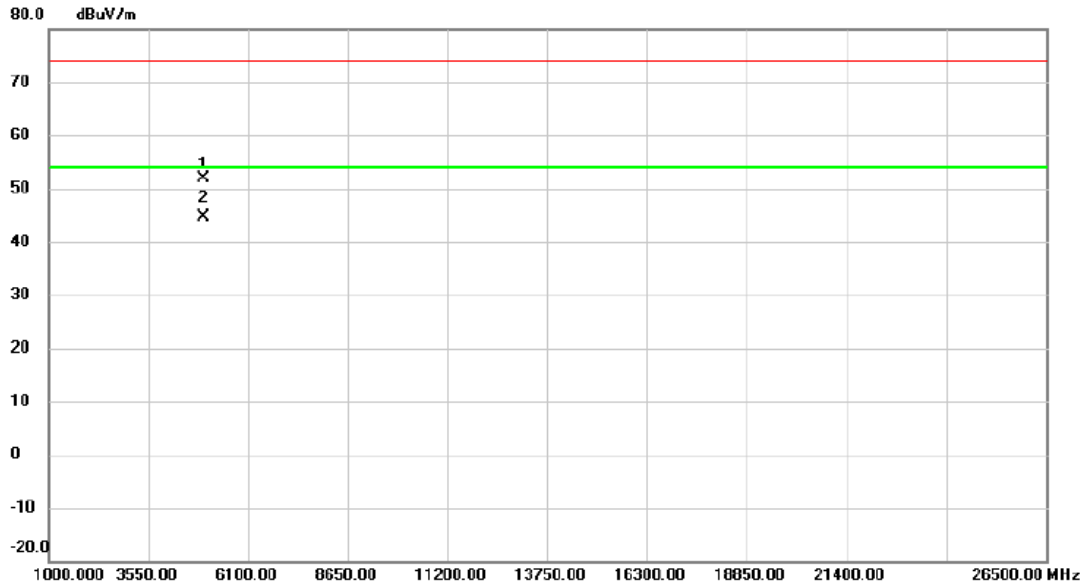

No.	Mk.	Freq.	Reading Level	Correct Factor	Measurement	Limit	Margin	Detector	Comment
		MHz	dBuV	dB	dBuV/m	dBuV/m	dB		
1		4957.350	41.46	10.38	51.84	74.00	-22.16	peak	
2	*	4957.950	34.26	10.38	44.64	54.00	-9.36	AVG	

Test Mode TX Mode_2479 MHz

Horizontal

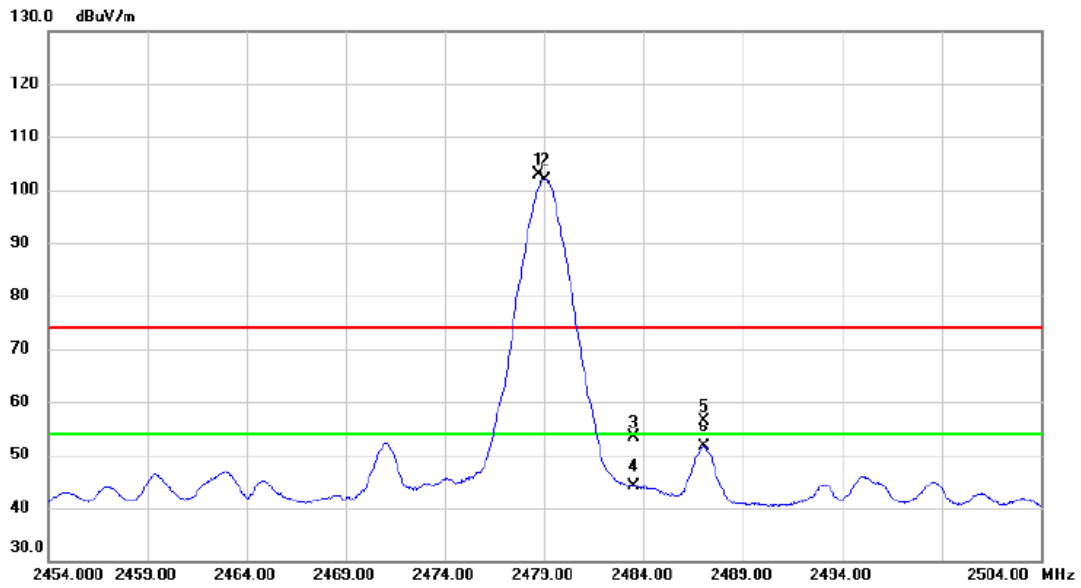

No.	Mk.	Freq. MHz	Reading Level dBuV	Correct Factor dB	Measure- ment dBuV/m	Limit dBuV/m	Margin dB	Detector	Comment
1	X	2478.700	91.65	11.34	102.99	74.00	28.99	peak	No Limit
2	*	2479.000	90.66	11.34	102.00	54.00	48.00	AVG	No Limit
3		2483.500	42.05	11.34	53.39	74.00	-20.61	peak	
4		2483.500	32.77	11.34	44.11	54.00	-9.89	AVG	
5		2487.050	45.10	11.35	56.45	74.00	-17.55	peak	
6		2487.050	40.21	11.35	51.56	54.00	-2.44	AVG	

Test Mode TX Mode_2479 MHz

Horizontal

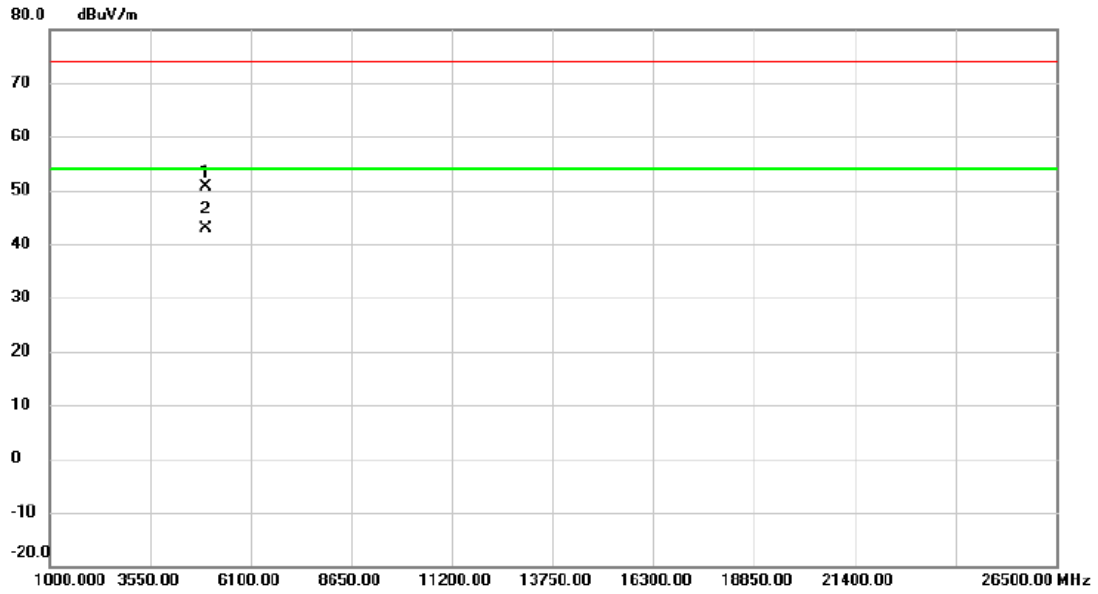

No.	Mk.	Freq. MHz	Reading Level dBuV	Correct Factor dB	Measure- ment dBuV/m	Limit dBuV/m	Margin dB	Detector	Comment
1		4957.375	40.25	10.38	50.63	74.00	-23.37	peak	
2	*	4957.745	32.49	10.38	42.87	54.00	-11.13	AVG	

APPENDIX E - BANDWIDTH

Test Mode:	TX Mode
------------	---------

Frequency (MHz)	6dB Bandwidth (MHz)	99% Occupied BW (MHz)	Min. Limit (kHz)	Test Result
2403	0.82	1.87	500	Complies
2440	0.77	1.85	500	Complies
2479	0.73	1.84	500	Complies

TX CH01

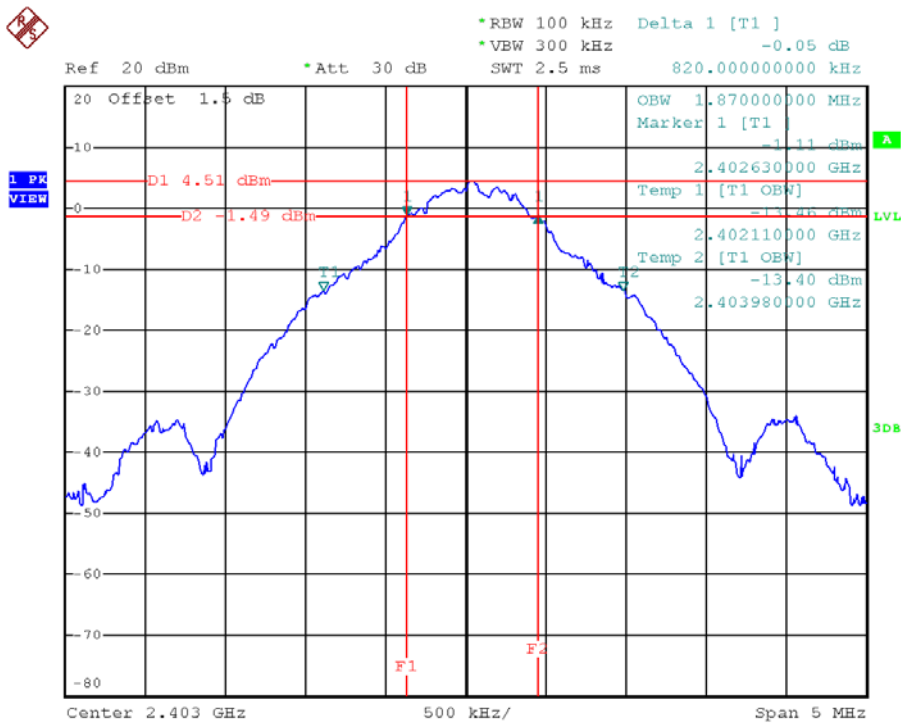

Date: 5.JUL.2018 19:11:28

TX CH38

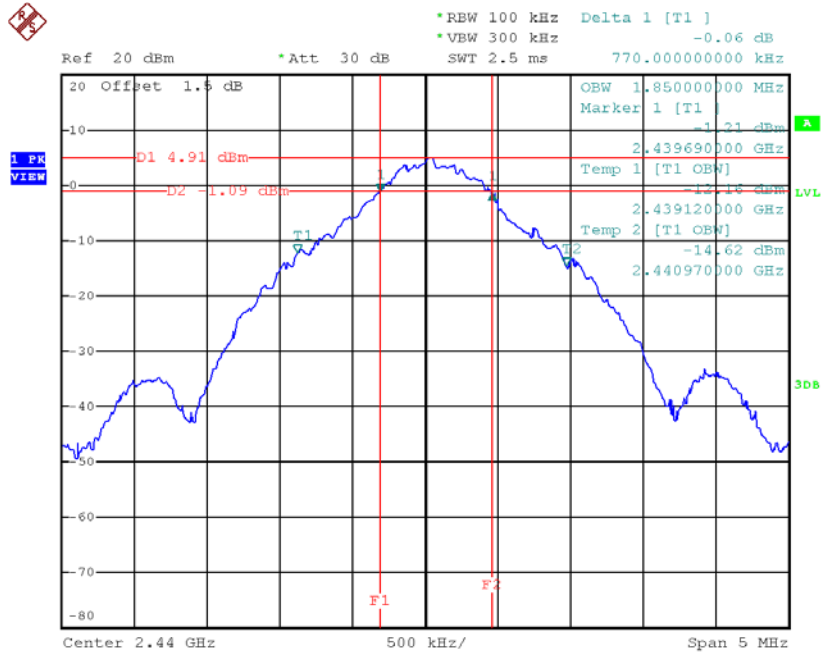

Date: 5.JUL.2018 19:15:19

TX CH77

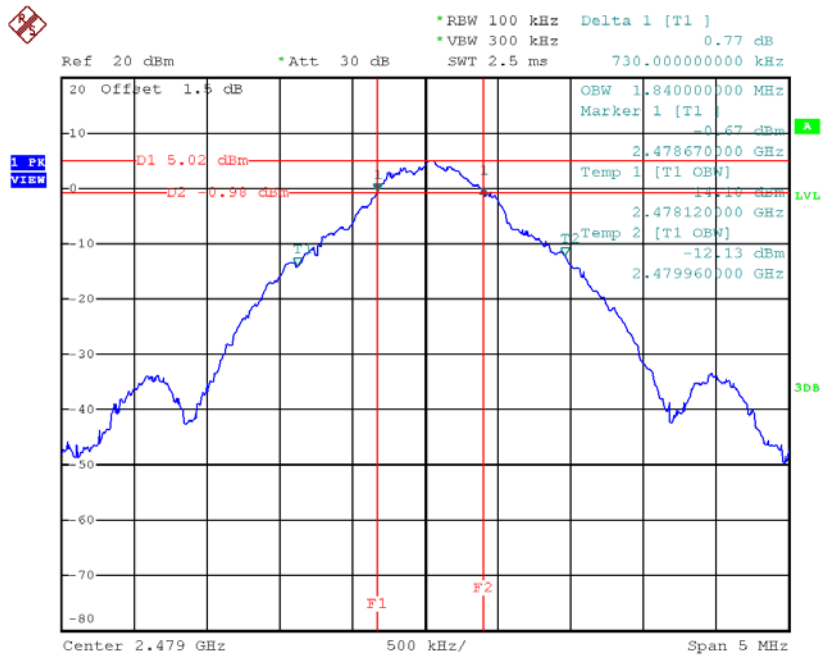

Date: 5.JUL.2018 19:21:49

APPENDIX F - CONDUCTED POWER TEST

Test Mode					
Frequency (MHz)	Conducted Power (dBm)	Conducted Power (W)	Max. Limit (dBm)	Max. Limit (W)	Result
2403	5.91	0.0039	30.00	1.00	Complies
2440	5.87	0.0039	30.00	1.00	Complies
2479	5.91	0.0039	30.00	1.00	Complies

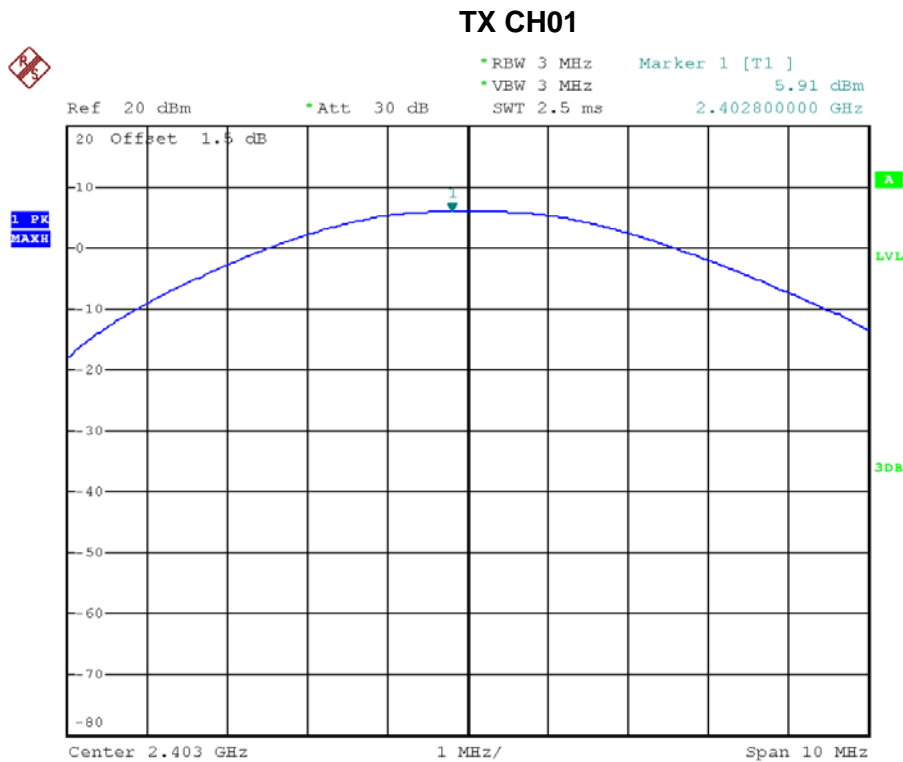

Date: 9.JUL.2018 10:32:25

TX CH38

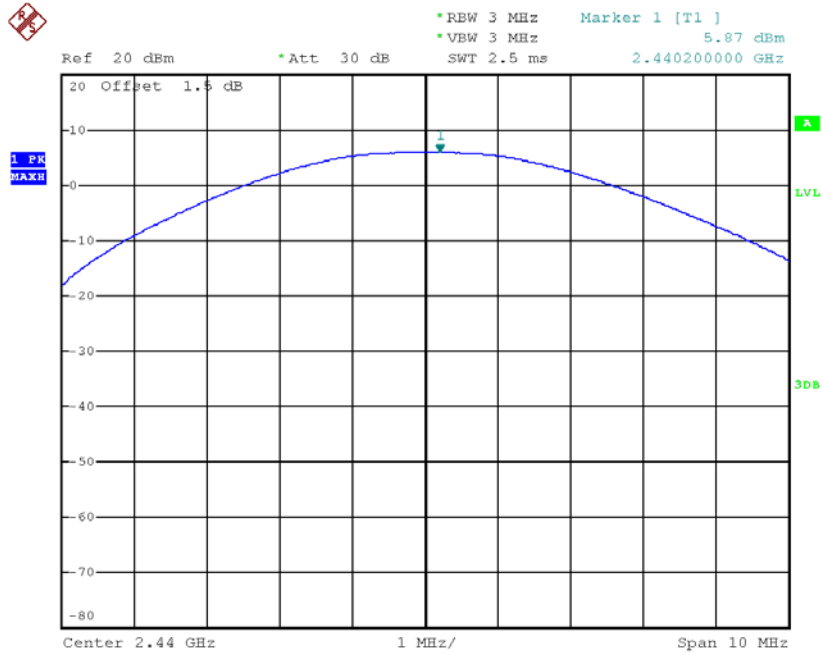

Date: 9.JUL.2018 10:34:12

TX CH77

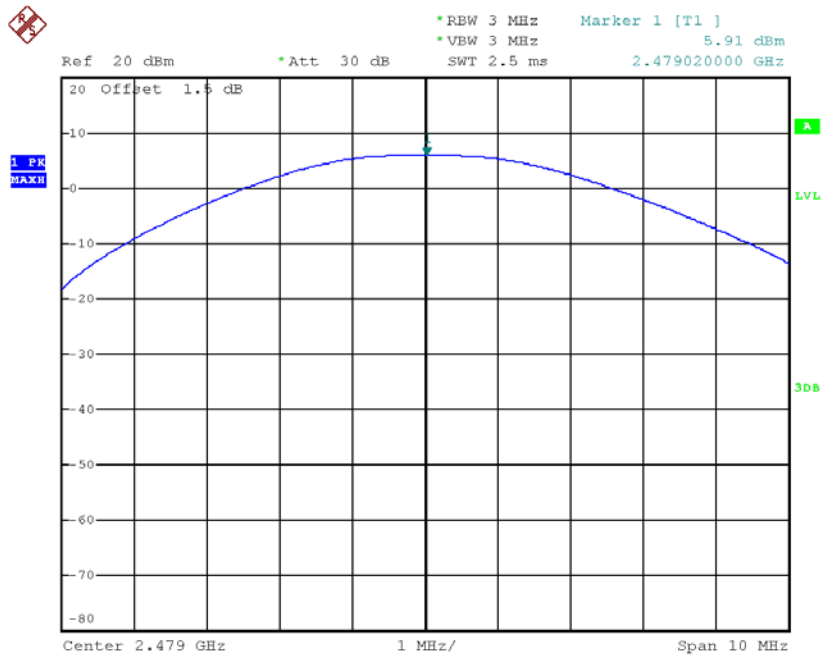

Date: 9.JUL.2018 10:35:09

APPENDIX G - ANTENNA CONDUCTED SPURIOUS EMISSION

Test Mode : CH01, CH38 , CH77

CH01 (Lower)

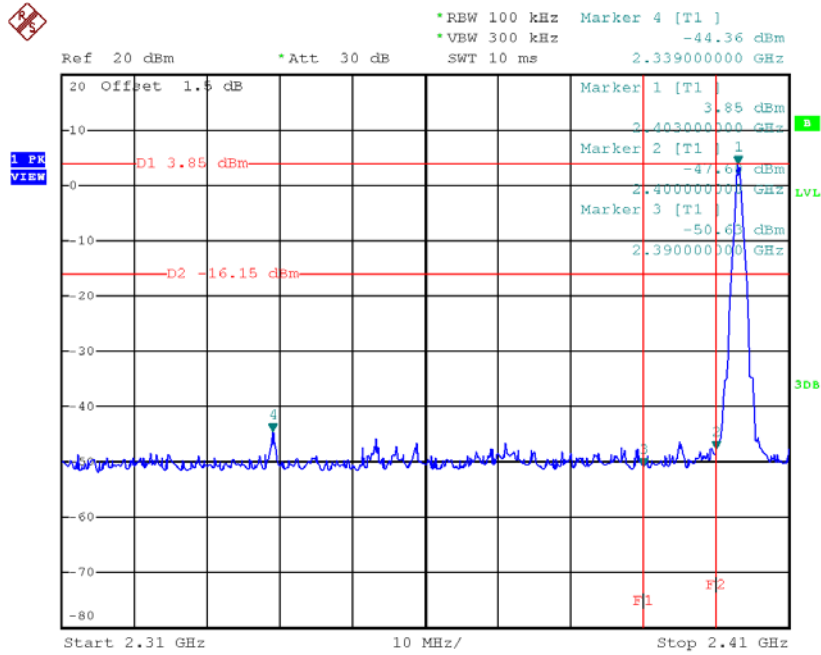

Date: 5.JUL.2018 18:46:46

CH77 (upper)

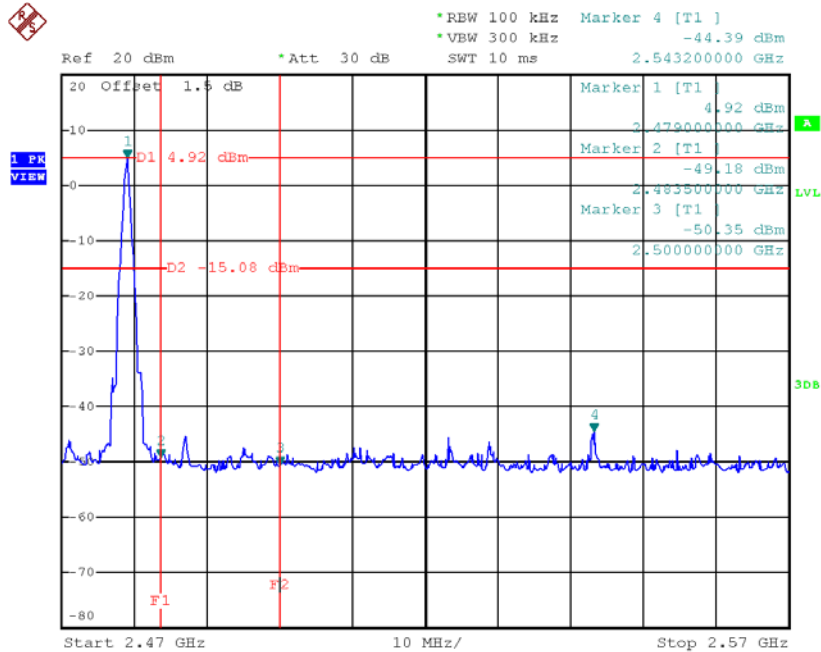

Date: 5.JUL.2018 19:26:42

CH01 (10 Harmonic of the frequency)

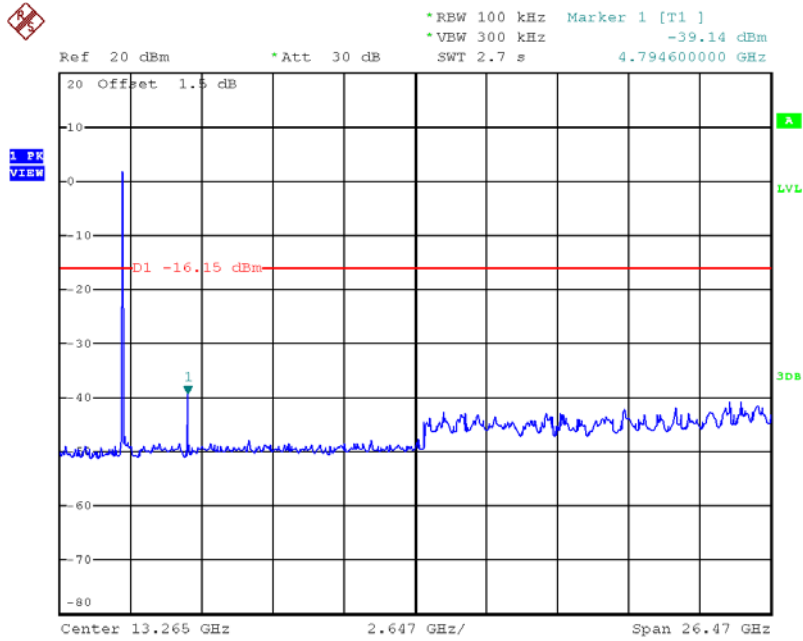

Date: 5.JUL.2018 19:05:25

CH38 (10 Harmonic of the frequency)

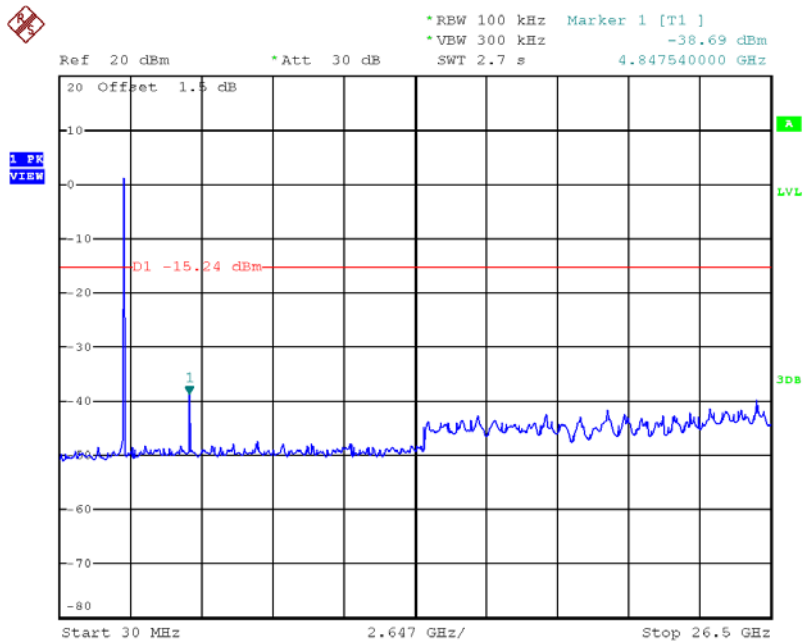

Date: 5.JUL.2018 19:51:48

CH77 (10 Harmonic of the frequency)

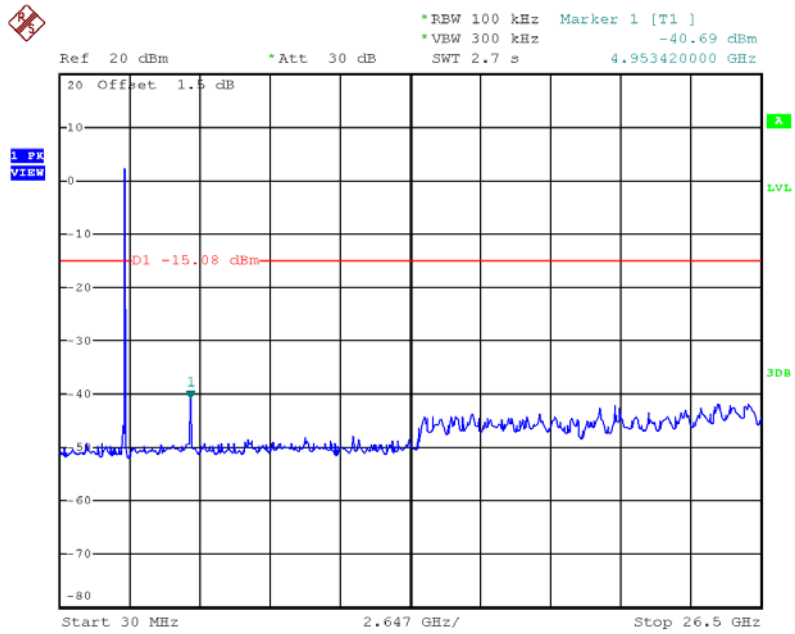

Date: 5.JUL.2018 19:29:50

APPENDIX H - POWER SPECTRAL DENSITY TEST

Test Mode:	TX Mode
------------	---------

Frequency (MHz)	Power Density (dBm/3kHz)	Power Density (mW/3kHz)	Max. Limit (dBm/3kHz)	Result
2403	-7.69	0.0001	8.00	Complies
2440	-8.51	0.0001	8.00	Complies
2479	-9.26	0.0001	8.00	Complies

TX CH01

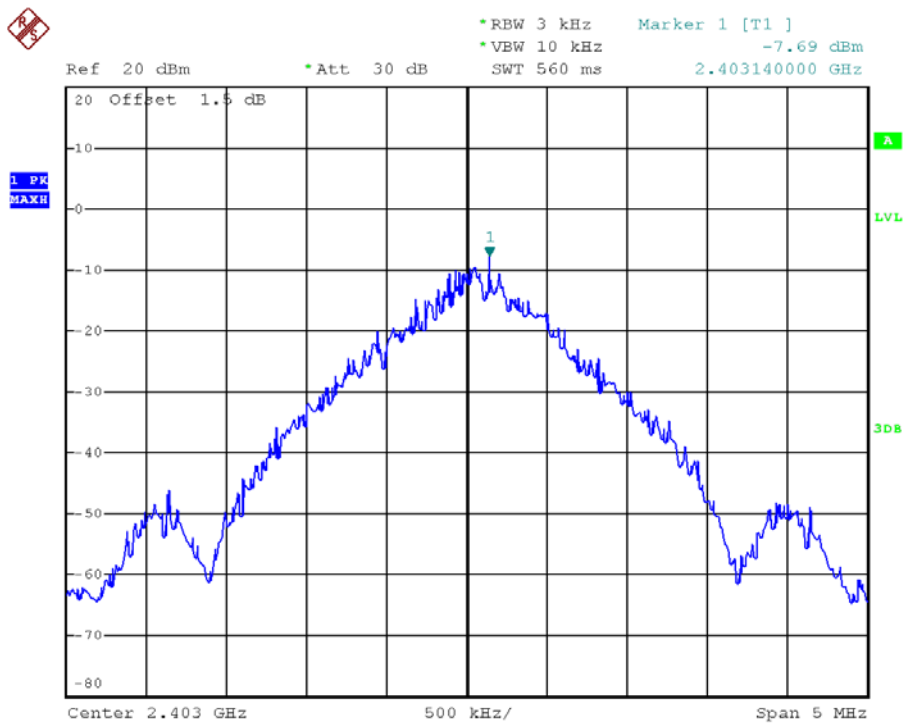

Date: 5.JUL.2018 19:42:29

TX CH38

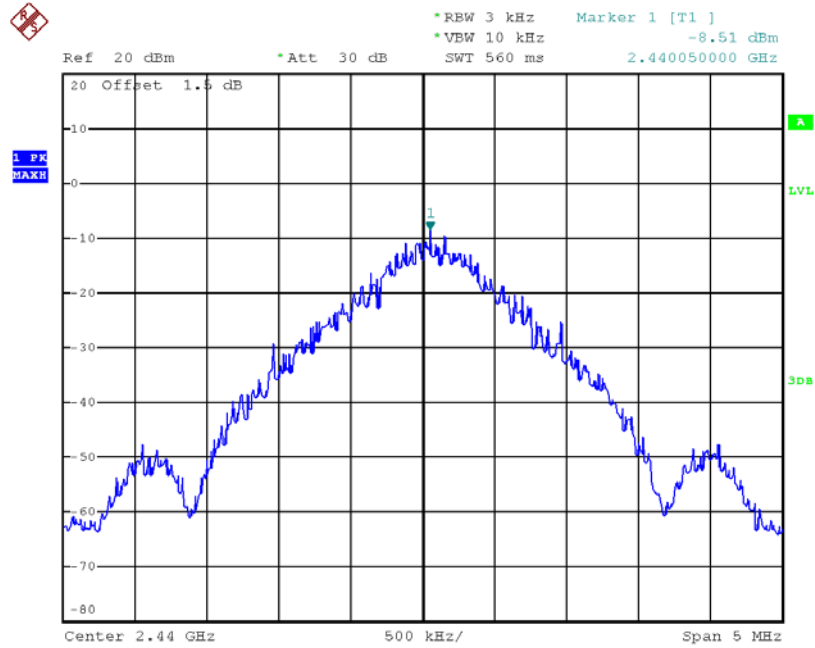

Date: 5.JUL.2018 19:47:22

TX CH77

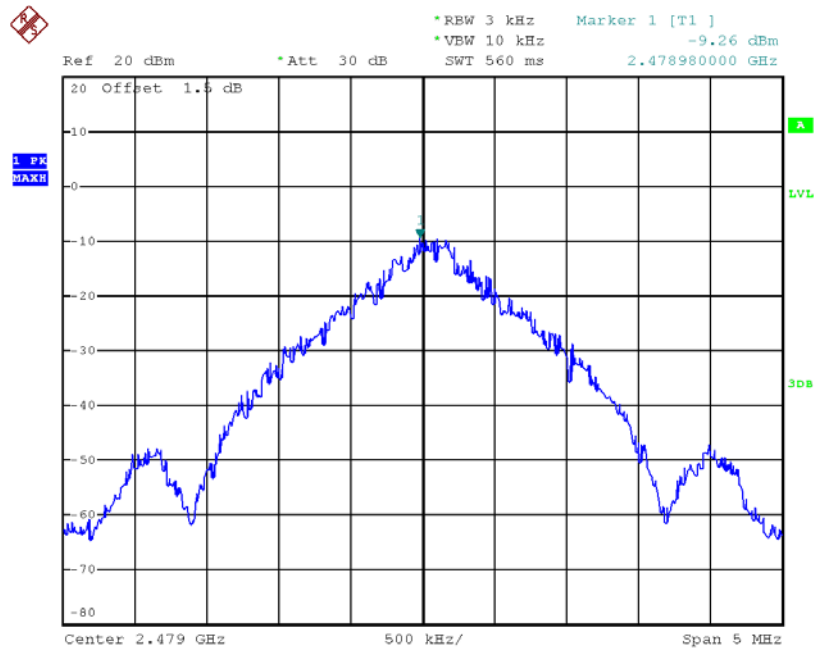

Date: 5.JUL.2018 19:39:07