

FCC Radio Test Report

FCC ID: RWO-RC30015901

This report concerns (check one): Original Grant Class II Change

Project No. : 1701C279B
Equipment : Audio Hub
Model Name : RC30-015901
Applicant : Razer Inc.
Address : 201 3rd Street, Suite 900, San Francisco, CA 94103

Date of Receipt : Jan. 24, 2017
Date of Test : Jan. 24, 2017 ~ Apr. 05, 2017
Issued Date : Apr. 06, 2017
Tested by : BTL Inc.

Testing Engineer : Vitas Zhou
(Vitas Zhou)

Technical Manager : David Mao
(David Mao)

Authorized Signatory : Steven Lu
(Steven Lu)

B T L I N C .

No.3, Jinshagang 1st Road, Shixia, Dalang Town, Dongguan,
Guangdong, China.

TEL: +86-769-8318-3000 FAX: +86-769-8319-6000

Declaration

BTL represents to the client that testing is done in accordance with standard procedures as applicable and that test instruments used has been calibrated with standards traceable to international standard(s) and/or national standard(s).

BTL's reports apply only to the specific samples tested under conditions. It is manufacture's responsibility to ensure that additional production units of this model are manufactured with the identical electrical and mechanical components. **BTL** shall have no liability for any declarations, inferences or generalizations drawn by the client or others from **BTL** issued reports.

BTL's report must not be used by the client to claim product certification, approval, or endorsement by NVLAP, NIST, or any agency of the Federal Government.

This report is the confidential property of the client. As a mutual protection to the clients, the public and **BTL-self**, extracts from the test report shall not be reproduced except in full with **BTL's** authorized written approval.

BTL's laboratory quality assurance procedures are in compliance with the **ISO Guide 17025** requirements, and accredited by the conformity assessment authorities listed in this test report.

Limitation

For the use of the authority's logo is limited unless the Test Standard(s)/Scope(s)/Item(s) mentioned in this test report is (are) included in the conformity assessment authorities acceptance respective.

Table of Contents	Page
1 . CERTIFICATION	6
2 . SUMMARY OF TEST RESULTS	7
2.1 TEST FACILITY	8
2.2 MEASUREMENT UNCERTAINTY	8
3 . GENERAL INFORMATION	9
3.1 GENERAL DESCRIPTION OF EUT	9
3.2 DESCRIPTION OF TEST MODES	11
3.3 TABLE OF PARAMETERS OF TEXT SOFTWARE SETTING	11
3.4 BLOCK DIAGRAM SHOWING THE CONFIGURATION OF SYSTEM TESTED	12
3.5 DESCRIPTION OF SUPPORT UNITS	12
4 . EMC EMISSION TEST	13
4.1 CONDUCTED EMISSION MEASUREMENT	13
4.1.1 POWER LINE CONDUCTED EMISSION LIMITS	13
4.1.2 TEST PROCEDURE	13
4.1.3 DEVIATION FROM TEST STANDARD	13
4.1.4 TEST SETUP	14
4.1.5 EUT OPERATING CONDITIONS	14
4.1.6 EUT TEST CONDITIONS	14
4.1.7 TEST RESULTS	14
4.2 RADIATED EMISSION MEASUREMENT	15
4.2.1 RADIATED EMISSION LIMITS	15
4.2.2 TEST PROCEDURE	16
4.2.3 DEVIATION FROM TEST STANDARD	16
4.2.4 TEST SETUP	17
4.2.5 EUT OPERATING CONDITIONS	18
4.2.6 EUT TEST CONDITIONS	18
4.2.7 TEST RESULTS (9KHZ TO 30MHZ)	18
4.2.8 TEST RESULTS (30MHZ TO 1000 MHZ)	19
4.2.9 TEST RESULTS (ABOVE 1000 MHZ)	19
5 . BANDWIDTH TEST	20
5.1 APPLIED PROCEDURES / LIMIT	20
5.1.1 TEST PROCEDURE	20
5.1.2 DEVIATION FROM STANDARD	20
5.1.3 TEST SETUP	20
5.1.4 EUT OPERATION CONDITIONS	20
5.1.5 EUT TEST CONDITIONS	20
5.1.6 TEST RESULTS	20
6 . MAXIMUM OUTPUT POWER TEST	21

Table of Contents	Page
6.1 APPLIED PROCEDURES / LIMIT	21
6.1.1 TEST PROCEDURE	21
6.1.2 DEVIATION FROM STANDARD	21
6.1.3 TEST SETUP	21
6.1.4 EUT OPERATION CONDITIONS	21
6.1.5 EUT TEST CONDITIONS	21
6.1.6 TEST RESULTS	21
7 . ANTENNA CONDUCTED SPURIOUS EMISSION	22
7.1 APPLIED PROCEDURES / LIMIT	22
7.1.1 TEST PROCEDURE	22
7.1.2 DEVIATION FROM STANDARD	22
7.1.3 TEST SETUP	22
7.1.4 EUT OPERATION CONDITIONS	22
7.1.5 EUT OPERATION CONDITIONS	22
7.1.6 TEST RESULTS	22
8 . POWER SPECTRAL DENSITY TEST	23
8.1 APPLIED PROCEDURES / LIMIT	23
8.1.1 TEST PROCEDURE	23
8.1.2 DEVIATION FROM STANDARD	23
8.1.3 TEST SETUP	23
8.1.4 EUT OPERATION CONDITIONS	23
8.1.5 EUT TEST CONDITIONS	23
8.1.6 TEST RESULTS	23
9 . MEASUREMENT INSTRUMENTS LIST	24
ATTACHMENT A - CONDUCTED EMISSION	26
ATTACHMENT B - RADIATED EMISSION (9KHZ TO 30MHZ)	29
ATTACHMENT C - RADIATED EMISSION (30MHZ TO 1000MHZ)	34
ATTACHMENT D - RADIATED EMISSION (ABOVE 1000MHZ)	41
ATTACHMENT E - BANDWIDTH	57
ATTACHMENT F - MAXIMUM OUTPUT POWER TEST	60
ATTACHMENT G - ANTENNA CONDUCTED SPURIOUS EMISSION	63
ATTACHMENT H - POWER SPECTRAL DENSITY TEST	67

REPORT ISSUED HISTORY

Issued No.	Description	Issued Date
BTL-FCCP-1-1701C279B	Original Issue.	Apr. 06, 2017

1. CERTIFICATION

Equipment : Audio Hub
Brand Name : RAZER
Model Name : RC30-015901
Applicant : Razer Inc.
Manufacturer : Razer (Asia-Pacific) Pte.,Ltd.
Address : 514 Chai Chee Lane #07-01 ~ 06 Singapore 469029
Factory : RAZER TECHNOLOGY AND DEVELOPMENT (SHENZHEN) CO., LTD
Address : East Wing, 3rd Floor, Block 2, Phase 1 of Vision Shenzhen Business Park Keji
South Road, Hi-Tech Industrial Park, Shenzhen 518057, China
Date of Test : Jan. 24, 2017 ~ Apr. 05, 2017
Test Sample : Engineering Sample
Standard(s) : FCC Part15, Subpart C (15.247) / ANSI C63.10-2013

The above equipment has been tested and found compliance with the requirement of the relative standards by BTL Inc.

The test data, data evaluation, and equipment configuration contained in our test report (Ref No. BTL-FCCP-1-1701C279B) were obtained utilizing the test procedures, test instruments, test sites that has been accredited by the Authority of TAF according to the ISO-17025 quality assessment standard and technical standard(s).

2. SUMMARY OF TEST RESULTS

Test procedures according to the technical standard(s):

Applied Standard(s): FCC Part15 (15.247) , Subpart C			
Standard(s) Section	Test Item	Judgment	Remark
15.207	Conducted Emission	PASS	
15.247(d)	Antenna conducted Spurious Emission	PASS	
15.247(a)(2)	6dB Bandwidth	PASS	
15.247(b)(3)	Peak Output Power	PASS	
15.247(e)	Power Spectral Density	PASS	
15.203	Antenna Requirement	PASS	
15.209/15.205	Transmitter Radiated Emissions	PASS	
15.209/15.205	Band Edge Emissions	PASS	

NOTE:

(1) "N/A" denotes test is not applicable to this device.

2.1 TEST FACILITY

The test facilities used to collect the test data in this report is at the location of No.3, Jinshagang 1st Road, Shixia, Dalang Town, Dongguan, Guangdong, China.

BTL's test firm number for FCC: 319330

2.2 MEASUREMENT UNCERTAINTY

Where relevant, the following measurement uncertainty levels have been estimated for tests performed on the EUT as specified in CISPR 16-4-2. The BTL measurement uncertainty is less than the CISPR 16-4-2 U_{CISPR} requirement.

The reported uncertainty of measurement $y \pm U$, where expanded uncertainty U is based on a standard uncertainty multiplied by a coverage factor of $k=2$, providing a level of confidence of approximately 95 %.

A. Conducted Measurement:

Test Site	Method	Measurement Frequency Range	U, (dB)
DG-C02	CISPR	150 KHz ~ 30MHz	2.32

B. Radiated Measurement:

Test Site	Method	Measurement Frequency Range	Ant. H / V	U, (dB)
DG-CB03	CISPR	9KHz~30MHz	V	3.79
		9KHz~30MHz	H	3.57
		30MHz ~ 200MHz	V	3.82
		30MHz ~ 200MHz	H	3.78
		200MHz ~ 1,000MHz	V	4.10
		200MHz ~ 1,000MHz	H	4.06
		1GHz~18GHz	V	3.12
		1GHz~18GHz	H	3.68
		18GHz~40GHz	V	4.15
		18GHz~40GHz	H	4.14

Note: Unless specifically mentioned, the uncertainty of measurement has not been taken into account to declare the compliance or non-compliance to the specification.

3. GENERAL INFORMATION

3.1 GENERAL DESCRIPTION OF EUT

Equipment	Audio Hub	
Brand Name	RAZER	
Model Name	RC30-015901	
Model Difference	The system's model is RZ04-0159, and the system contains of Wireless Gaming Headset (Model: RC30-015902) and Audio Hub (Model: RC30-015901).	
Product Description	Operation Frequency	2405.35-2477.35 MHz
	Modulation Technology	GFSK (2Mbps)
	Bit Rate of Transmitter	
	Output Power (Max.)	6.30dBm (2Mbps)
Power Source	Supplied from PC USB Port	
Power Rating	DC 5V 500mA	

Note:

1. For a more detailed features description, please refer to the manufacturer's specifications or the user's manual.

2. Channel List:

Channel	Frequency (MHz)	Channel	Frequency (MHz)
01	2405.35	21	2445.35
02	2407.35	22	2447.35
03	2409.35	23	2449.35
04	2411.35	24	2451.35
05	2413.35	25	2453.35
06	2415.35	26	2455.35
07	2417.35	27	2457.35
08	2419.35	28	2459.35
09	2421.35	29	2461.35
10	2423.35	30	2463.35
11	2425.35	31	2465.35
12	2427.35	32	2467.35
13	2429.35	33	2469.35
14	2431.35	34	2471.35
15	2433.35	35	2473.35
16	2435.35	36	2475.35
17	2437.35	37	2477.35
18	2439.35		
19	2441.35		
20	2443.35		

3. Table for Filed Antenna:

Ant.	Brand	Model Name	Antenna Type	Connector	Gain (dBi)
1	N/A	N/A	Printed	N/A	3.30
2	N/A	N/A	Printed	N/A	3.30

Note: There are two antennas but only one antenna works at a time.

3.2 DESCRIPTION OF TEST MODES

To investigate the maximum EMI emission characteristics generates from EUT, the test system was pre-scanning tested base on the consideration of following EUT operation mode or test configuration mode which possible have effect on EMI emission level. Each of these EUT operation mode(s) or test configuration mode(s) mentioned above was evaluated respectively.

Pretest Mode	Description
Mode 1	TX Mode NOTE (1)

The EUT system operated these modes were found to be the worst case during the pre-scanning test as following:

For Conducted Test	
Final Test Mode	Description
Mode 1	TX Mode

For Radiated Test	
Final Test Mode	Description
Mode 1	TX Mode NOTE (1)

Note:

(1) The measurements are performed at the high, middle, low available channels.

3.3 TABLE OF PARAMETERS OF TEXT SOFTWARE SETTING

During testing channel & power controlling software provided by the customer was used to control the operating channel as well as the output power level. The RF output power selection is for the setting of RF output power expected by the customer and is going to be fixed on the firmware of the final end product power parameters of WLAN

Test Software Version	N/A		
Frequency (MHz)	2405.35	2441.35	2477.35
-	N/A	N/A	N/A

3.4 BLOCK DIAGRAM SHOWING THE CONFIGURATION OF SYSTEM TESTED

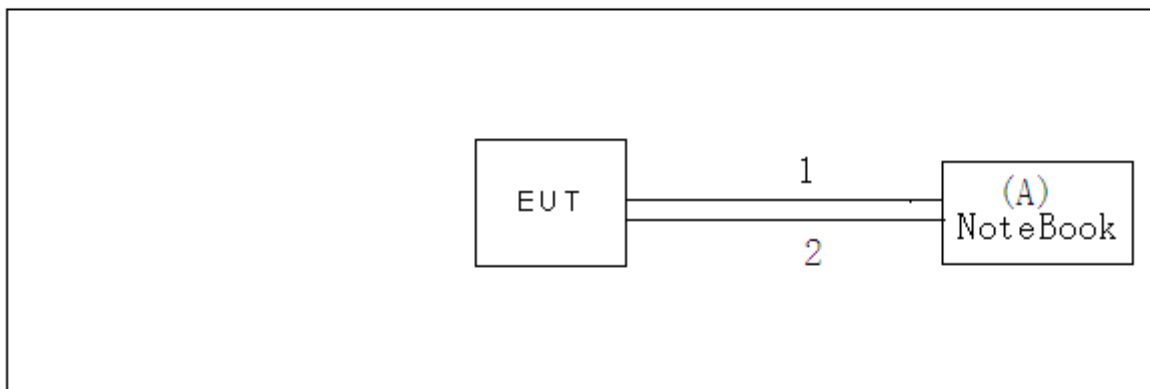

3.5 DESCRIPTION OF SUPPORT UNITS

The EUT has been tested as an independent unit together with other necessary accessories or support units. The following support units or accessories were used to form a representative test configuration during the tests.

Item	Equipment	Mfr/Brand	Model/Type No.	FCC ID	Series No.
A	Notebook	Lenovo	INSPIRON 1420-	DOC	JX193A01SDC2

Item	Shielded Type	Ferrite Core	Length	Note
1	NO	NO	0.8M	USB Cable
2	NO	NO	0.8M	USB Cable

Note:

- (1) For detachable type I/O cable should be specified the length in m in 『Length』 column.

4. EMC EMISSION TEST

4.1 CONDUCTED EMISSION MEASUREMENT

4.1.1 POWER LINE CONDUCTED EMISSION LIMITS (Frequency Range 150KHz-30MHz)

Frequency of Emission (MHz)	Conducted Limit (dB μ V)	
	Quasi-peak	Average
0.15 -0.5	66 to 56*	56 to 46*
0.50 -5.0	56	46
5.0 -30.0	60	50

Note:

- (1) The limit of " * " decreases with the logarithm of the frequency
- (2) The test result calculated as following:
 Measurement Value = Reading Level + Correct Factor
 Correct Factor = Insertion Loss + Cable Loss + Attenuator Factor(if use)
 Margin Level = Measurement Value - Limit Value

The following table is the setting of the receiver

Receiver Parameters	Setting
Attenuation	10 dB
Start Frequency	0.15 MHz
Stop Frequency	30 MHz
IF Bandwidth	9 kHz

4.1.2 TEST PROCEDURE

- a. The EUT was placed 0.8 meters from the horizontal ground plane with EUT being connected to the power mains through a line impedance stabilization network (LISN). All other support equipments powered from additional LISN(s). The LISN provide 50 Ohm/ 50uH of coupling impedance for the measuring instrument.
- b. Interconnecting cables that hang closer than 40 cm to the ground plane shall be folded back and forth in the center forming a bundle 30 to 40 cm long.
- c. I/O cables that are not connected to a peripheral shall be bundled in the center. The end of the cable may be terminated, if required, using the correct terminating impedance. The overall length shall not exceed 1 m.
- d. LISN at least 80 cm from nearest part of EUT chassis.
- e. For the actual test configuration, please refer to the related Item –EUT Test Photos.

4.1.3 DEVIATION FROM TEST STANDARD

No deviation

4.1.4 TEST SETUP

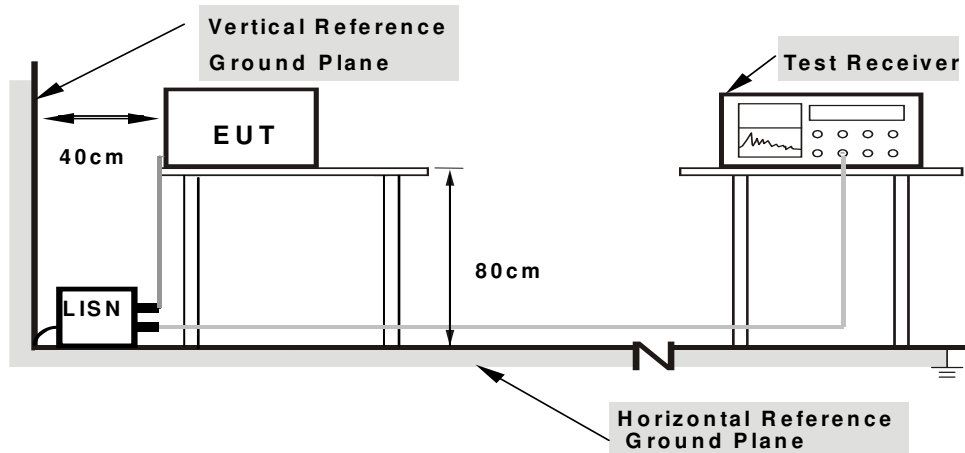

- Note:**
1. Support units were connected to second LISN.
 2. Both of LISNs (AMN) are 80 cm from EUT and at least 80 cm from other units and other metal planes

4.1.5 EUT OPERATING CONDITIONS

The EUT was configured for testing in a typical fashion (as a customer would normally use it). The EUT has been programmed to continuously transmit during test. This operating condition was tested and used to collect the included data.

4.1.6 EUT TEST CONDITIONS

Temperature: 25°C Relative Humidity: 53% Test Voltage: AC 120V/60Hz

4.1.7 TEST RESULTS

Please refer to the Attachment A.

Remark:

- (1) All readings are QP Mode value unless otherwise stated AVG in column of『Note』. If the QP Mode Measured value compliance with the QP Limits and lower than AVG Limits, the EUT shall be deemed to meet both QP & AVG Limits and then only QP Mode was measured, but AVG Mode didn't perform. In this case, a “ * ” marked in AVG Mode column of Interference Voltage Measured.
- (2) Measuring frequency range from 150KHz to 30MHz.
- (3) “ N/A ” denotes test is not applicable to this device.

4.2 RADIATED EMISSION MEASUREMENT

4.2.1 RADIATED EMISSION LIMITS

In case the emission fall within the restricted band specified on 15.205(a), then the 15.209(a) limit in the table below has to be followed.

LIMITS OF RADIATED EMISSION MEASUREMENT (9KHz-1000MHz)

Frequency (MHz)	Field Strength (microvolts/meter)	Measurement Distance (meters)
0.009~0.490	2400/F(KHz)	300
0.490~1.705	24000/F(KHz)	30
1.705~30.0	30	30
30~88	100	3
88~216	150	3
216~960	200	3
960~1000	500	3

LIMITS OF RADIATED EMISSION MEASUREMENT (Above 1000MHz)

Frequency (MHz)	(dBuV/m) (at 3 meters)	
	PEAK	AVERAGE
Above 1000	74	54

Notes:

- (1) The limit for radiated test was performed according to FCC PART 15C.
- (2) The tighter limit applies at the band edges.
- (3) Emission level (dBuV/m)=20log Emission level (uV/m).
- (4) The test result calculated as following:
 Measurement Value = Reading Level + Correct Factor
 Correct Factor = Antenna Factor + Cable Loss - Amplifier Gain(if use)
 Margin Level = Measurement Value - Limit Value

Spectrum Parameter	Setting
Attenuation	Auto
Start Frequency	1000 MHz
Stop Frequency	10th carrier harmonic
RBW / VBW (Emission in restricted band)	RBW 1MHz VBW 3MHz peak detector for Pk value RMS detector for AV value

Receiver Parameter	Setting
Attenuation	Auto
Start ~ Stop Frequency	9KHz~90KHz for PK/AVG detector
Start ~ Stop Frequency	90KHz~110KHz for QP detector
Start ~ Stop Frequency	110KHz~490KHz for PK/AVG detector
Start ~ Stop Frequency	490KHz~30MHz for QP detector
Start ~ Stop Frequency	30MHz~1000MHz for QP detector

4.2.2 TEST PROCEDURE

- a. The measuring distance of 3 m shall be used for measurements. The EUT was placed on the top of a rotating table 0.8 meter above the ground at a 3 meter semi-anechoic chamber. The table was rotated 360 degrees to determine the position of the highest radiation.(below 1GHz)
- b. The measuring distance of 3 m shall be used for measurements. The EUT was placed on the top of a rotating table 1.5 meter above the ground at a 3 meter semi-anechoic chamber. The table was rotated 360 degrees to determine the position of the highest radiation.(above 1GHz)
- c. The height of the equipment or of the substitution antenna shall be 0.8 m or 1.5 m, the height of the test antenna shall vary between 1 m to 4 m. Both horizontal and vertical polarizations of the antenna are set to make the measurement.
- d. The initial step in collecting radiated emission data is a receiver peak detector mode pre-scanning the measurement frequency range. Significant peaks are then marked and then Quasi Peak detector mode re-measured.
- e. All readings are Peak unless otherwise stated QP in column of Note. Peak denotes that the Peak reading compliance with the QP Limits and then QP Mode measurement didn't perform. (below 1GHz)
- f. All readings are Peak Mode value unless otherwise stated AVG in column of Note. If the Peak Mode Measured value compliance with the Peak Limits and lower than AVG Limits, the EUT shall be deemed to meet both Peak & AVG Limits and then only Peak Mode was measured, but AVG Mode didn't perform. (above 1GHz)
- g. For the actual test configuration, please refer to the related Item –EUT Test Photos.

4.2.3 DEVIATION FROM TEST STANDARD

No deviation

4.2.4 TEST SETUP

(A) Radiated Emission Test Set-Up Frequency Below 1 GHz

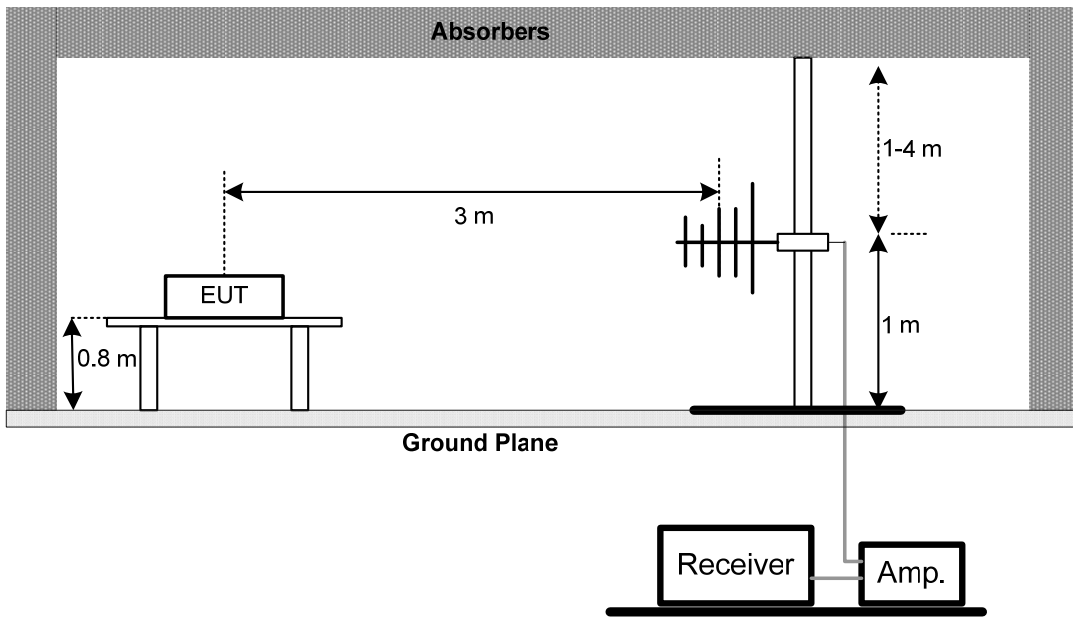

(B) Radiated Emission Test Set-Up Frequency Above 1 GHz

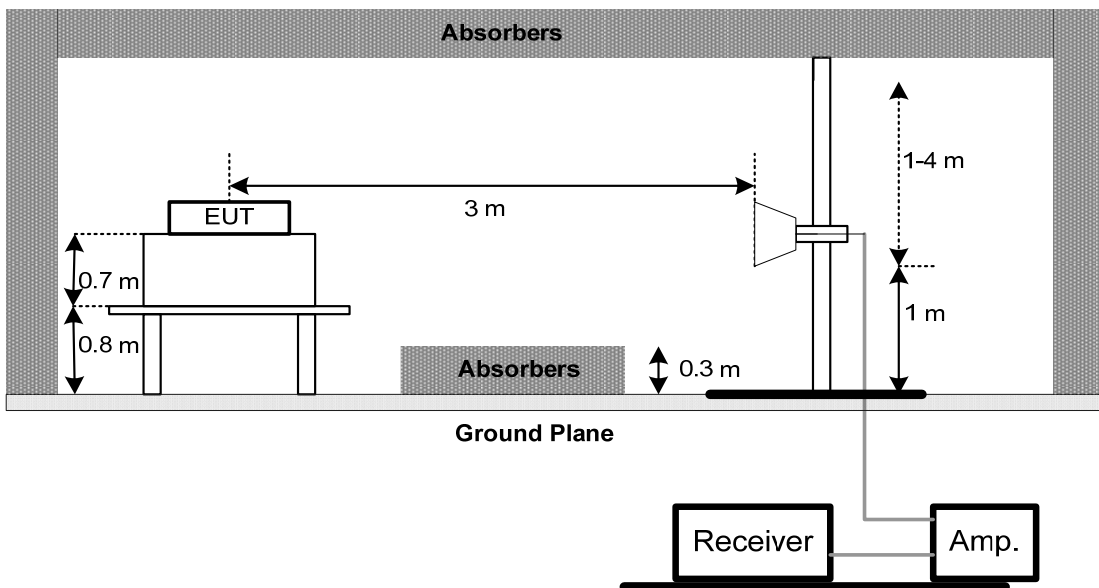

(C) For radiated emissions below 30MHz

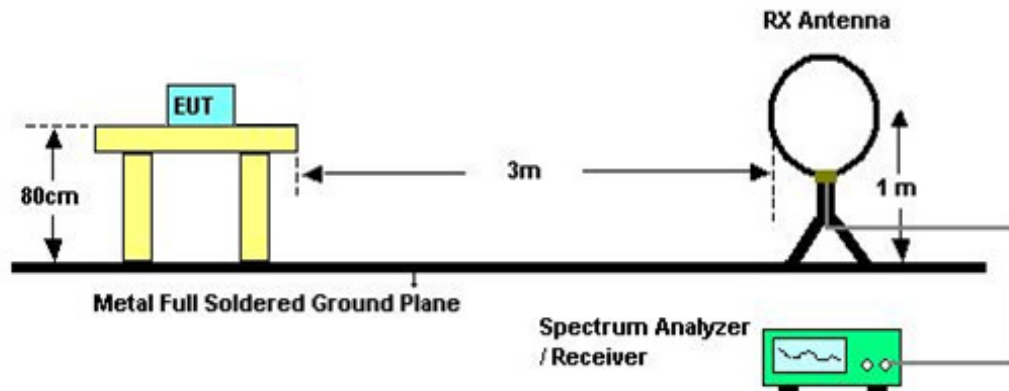

4.2.5 EUT OPERATING CONDITIONS

The EUT tested system was configured as the statements of 4.1.5 unless otherwise a special operating condition is specified in the follows during the testing.

4.2.6 EUT TEST CONDITIONS

Temperature: 25°C Relative Humidity: 60% Test Voltage: AC 120V/60Hz

4.2.7 TEST RESULTS (9KHZ TO 30MHZ)

Please refer to the Attachment B

Remark:

- (1) The amplitude of spurious emissions which are attenuated by more than 20 dB below the permissible value has no need to be reported.
- (2) Distance extrapolation factor = $40 \log (\text{specific distance} / \text{test distance})$ (dB).
- (3) Limit line = specific limits (dBuV) + distance extrapolation factor.

4.2.8 TEST RESULTS (30MHZ TO 1000 MHZ)

Please refer to the Attachment C.

Remark:

- (1) All readings are Peak unless otherwise stated QP in column of 『Note』 . Peak denotes that the Peak reading compliance with the QP Limits and then QP Mode measurement didn't perform.
- (2) Measuring frequency range from 30MHz to 1000MHz.
- (3) If the peak scan value lower limit more than 20dB, then this signal data does not show in table.

4.2.9 TEST RESULTS (ABOVE 1000 MHZ)

Please refer to the Attachment D.

Remark:

- (1) All readings are Peak unless otherwise stated QP in column of 『Note』 . Peak denotes that the Peak reading compliance with the QP Limits and then QP Mode measurement didn't perform.
- (2) Radiated emissions measured in frequency range above 1000MHz were made with an instrument using Peak detector mode and AV detector mode of the emission
- (3) A preamp and high pass filter were used for this test in order to provide sufficient measurement sensitivity.
- (4) EUT Orthogonal Axis:
"X" - denotes Laid on Table ; "Y" - denotes Vertical Stand ; "Z" - denotes Side Stand
- (5) During the measurements above 1 GHz it is taken care of that the EUT is always within the 3 dB cone of radiation BW of the used antenna
- (6) No limit: This is fundamental signal, the judgment is not applicable.
For fundamental signal judgment was referred to Peak output test.

5. BANDWIDTH TEST

5.1 APPLIED PROCEDURES / LIMIT

FCC Part15 (15.247) , Subpart C				
Section	Test Item	Limit	Frequency Range (MHz)	Result
15.247(a)(2)	Bandwidth	$\geq 500\text{KHz}$ (6dB bandwidth)	2400-2483.5	PASS

5.1.1 TEST PROCEDURE

- The EUT was directly connected to the spectrum analyzer and antenna output port as show in the block diagram below,
- Spectrum Setting : RBW= 100KHz, VBW=300KHz, Sweep time = 2.5 ms.

5.1.2 DEVIATION FROM STANDARD

No deviation.

5.1.3 TEST SETUP

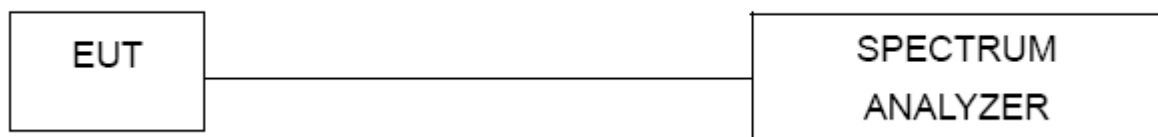

5.1.4 EUT OPERATION CONDITIONS

The EUT tested system was configured as the statements of 4.1.5 unless otherwise a special operating condition is specified in the follows during the testing.

5.1.5 EUT TEST CONDITIONS

Temperature: 25°C Relative Humidity: 60% Test Voltage: DC 5V

5.1.6 TEST RESULTS

Please refer to the Attachment E.

6. MAXIMUM OUTPUT POWER TEST

6.1 APPLIED PROCEDURES / LIMIT

FCC Part15 (15.247) , Subpart C				
Section	Test Item	Limit	Frequency Range (MHz)	Result
15.247(b)(3)	Maximum Output Power	1 watt or 30dBm	2400-2483.5	PASS

6.1.1 TEST PROCEDURE

- a. The EUT was directly connected to the spectrum analyzer and antenna output port as show in the block diagram below,
- b. The maximum conducted output power was performed in accordance with method 9.2 of FCC KDB 558074 D01 DTS Meas Guidance v03r05.

6.1.2 DEVIATION FROM STANDARD

No deviation.

6.1.3 TEST SETUP

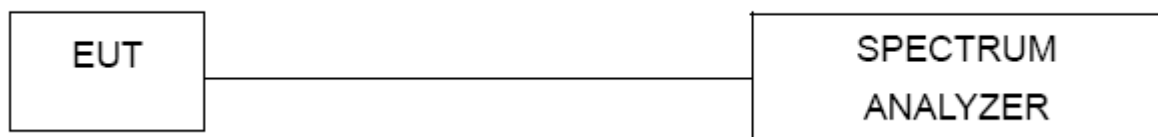

6.1.4 EUT OPERATION CONDITIONS

The EUT tested system was configured as the statements of 4.1.5 unless otherwise a special operating condition is specified in the follows during the testing.

6.1.5 EUT TEST CONDITIONS

Temperature: 25°C Relative Humidity: 60% Test Voltage: DC 5V

6.1.6 TEST RESULTS

Please refer to the Attachment F.

7. ANTENNA CONDUCTED SPURIOUS EMISSION

7.1 APPLIED PROCEDURES / LIMIT

In any 100 kHz bandwidth outside the frequency band in which the spread spectrum or digitally modulated device is operating, the RF power that is produced shall be at least 20 dB below that in the 100 kHz bandwidth within the band that contains the highest level of the desired power, based on either an RF conducted or a radiated measurement, provided that the transmitter demonstrates compliance with the peak conducted power limits.

7.1.1 TEST PROCEDURE

- a. The EUT was directly connected to the spectrum analyzer and antenna output port as show in the block diagram below,
- b. Spectrum Setting : RBW= 100KHz, VBW=300KHz, Sweep time = 10 ms.
- c. Offset=antenna gain+cable loss

7.1.2 DEVIATION FROM STANDARD

No deviation.

7.1.3 TEST SETUP

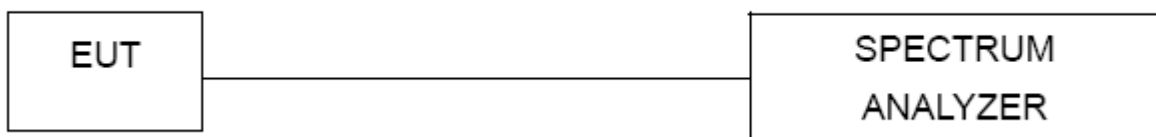

7.1.4 EUT OPERATION CONDITIONS

The EUT tested system was configured as the statements of 4.1.5 unless otherwise a special operating condition is specified in the follows during the testing.

7.1.5 EUT OPERATION CONDITIONS

Temperature: 25°C Relative Humidity: 60% Test Voltage: DC 5V

7.1.6 TEST RESULTS

Please refer to the Attachment G.

8. POWER SPECTRAL DENSITY TEST

8.1 APPLIED PROCEDURES / LIMIT

FCC Part15 (15.247) , Subpart C				
Section	Test Item	Limit	Frequency Range (MHz)	Result
15.247(e)	Power Spectral Density	8 dBm (in any 3KHz)	2400-2483.5	PASS

8.1.1 TEST PROCEDURE

- a. The EUT was directly connected to the spectrum analyzer and antenna output port as show in the block diagram below,
- b. Spectrum Setting: RBW=3KHz, VBW=10 KHz, Sweep time = auto.

8.1.2 DEVIATION FROM STANDARD

No deviation.

8.1.3 TEST SETUP

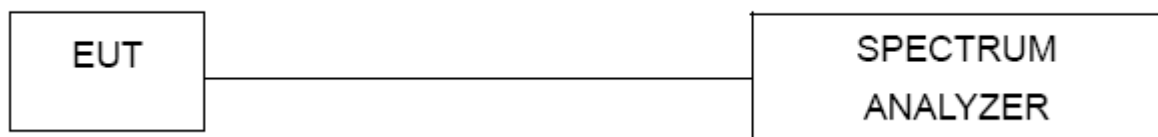

8.1.4 EUT OPERATION CONDITIONS

The EUT tested system was configured as the statements of 4.1.5 unless otherwise a special operating condition is specified in the follows during the testing.

8.1.5 EUT TEST CONDITIONS

Temperature: 25°C Relative Humidity: 60% Test Voltage: DC 5V

8.1.6 TEST RESULTS

Please refer to the Attachment H.

9. MEASUREMENT INSTRUMENTS LIST

Conducted Emission Measurement					
Item	Kind of Equipment	Manufacturer	Type No.	Serial No.	Calibrated until
1	EMI Test Receiver	R&S	ESCI	100382	Mar. 26, 2018
2	LISN	EMCO	3816/2	52765	Mar. 26, 2018
3	50Ω Terminator	SHX	TF2-3G-A	8122901	Mar. 26, 2018
4	TWO-LINE V-NETWORK	R&S	ENV216	101447	Mar. 26, 2018
5	Cable	emci	RG223(9KHz-30M Hz)(5m)	N/A	Mar. 07, 2018
6	Measurement Software	Farad	EZ-EMC Ver.NB-03A1-01	N/A	N/A

Radiated Emission Measurement					
Item	Kind of Equipment	Manufacturer	Type No.	Serial No.	Calibrated until
1	Antenna	Schwarzbeck	VULB9160	9160-3232	Mar. 26, 2018
2	Amplifier	HP	8447D	2944A09673	Oct. 20, 2017
3	Receiver	AGILENT	N9038A	MY52130039	Sep. 04, 2017
4	Test Cable	emci	LMR-400(30MHz-1 GHz)	C-01	Jun. 26, 2017
5	Controller	CT	SC100	N/A	N/A
6	Measurement Software	Farad	EZ-EMC Ver.NB-03A1-01	N/A	N/A
7	Antenna	ETS	3115	00075789	Mar. 26, 2018
8	Amplifier	Agilent	8449B	3008A02274	Nov. 01, 2017
9	Test Cable	emci	EMC104-SM-SM-10000(1GHz-26.5G Hz)	C-68	Jun. 26, 2017
10	Broad-Band Horn Antenna	Schwarzbeck	BBHA 9170	9170319	Apr. 23, 2017
11	Microwave Pre-amplifier With Adaptor	EMC INSTRUMENT	EMC2654045	980039 & HA01	Mar. 26, 2018
12	EMI Test Receiver	R&S	ESCI	100895	Mar. 26, 2018
13	Active Loop Antenna	R&S	HFH2-Z2	830749/020	Sep. 07, 2017

6dB Bandwidth Measurement					
Item	Kind of Equipment	Manufacturer	Type No.	Serial No.	Calibrated until
1	Spectrum Analyzer	R&S	FSP40	100185	Sep. 04, 2017

Peak Output Power Measurement					
Item	Kind of Equipment	Manufacturer	Type No.	Serial No.	Calibrated until
1	Spectrum Analyzer	R&S	FSP40	100185	Sep. 04, 2017

Antenna Conducted Spurious Emission Measurement					
Item	Kind of Equipment	Manufacturer	Type No.	Serial No.	Calibrated until
1	Spectrum Analyzer	R&S	FSP40	100185	Sep. 04, 2017

Power Spectral Density Measurement					
Item	Kind of Equipment	Manufacturer	Type No.	Serial No.	Calibrated until
1	Spectrum Analyzer	R&S	FSP40	100185	Sep. 04, 2017

Remark: "N/A" denotes no model name, serial no. or calibration specified.
 All calibration period of equipment list is one year.

ATTACHMENT A - CONDUCTED EMISSION

Test Mode: TX Mode

Line

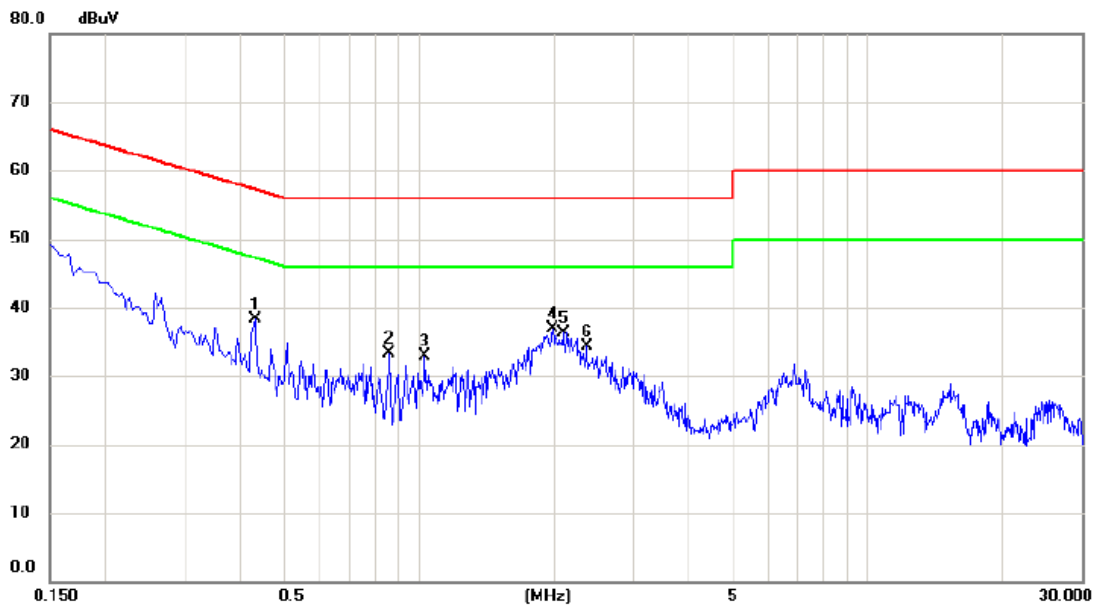

No.	Mk.	Freq. MHz	Reading Level dBuV	Correct Factor dB	Measure- ment dBuV	Limit dBuV	Margin dB	Detector	Comment
1	*	0.4300	28.59	9.62	38.21	57.25	-19.04	peak	
2		0.8580	23.56	9.83	33.39	56.00	-22.61	peak	
3		1.0300	23.11	9.84	32.95	56.00	-23.05	peak	
4		1.9900	26.93	10.01	36.94	56.00	-19.06	peak	
5		2.0940	26.32	10.05	36.37	56.00	-19.63	peak	
6		2.3620	24.08	10.17	34.25	56.00	-21.75	peak	

Test Mode: TX Mode

Neutral

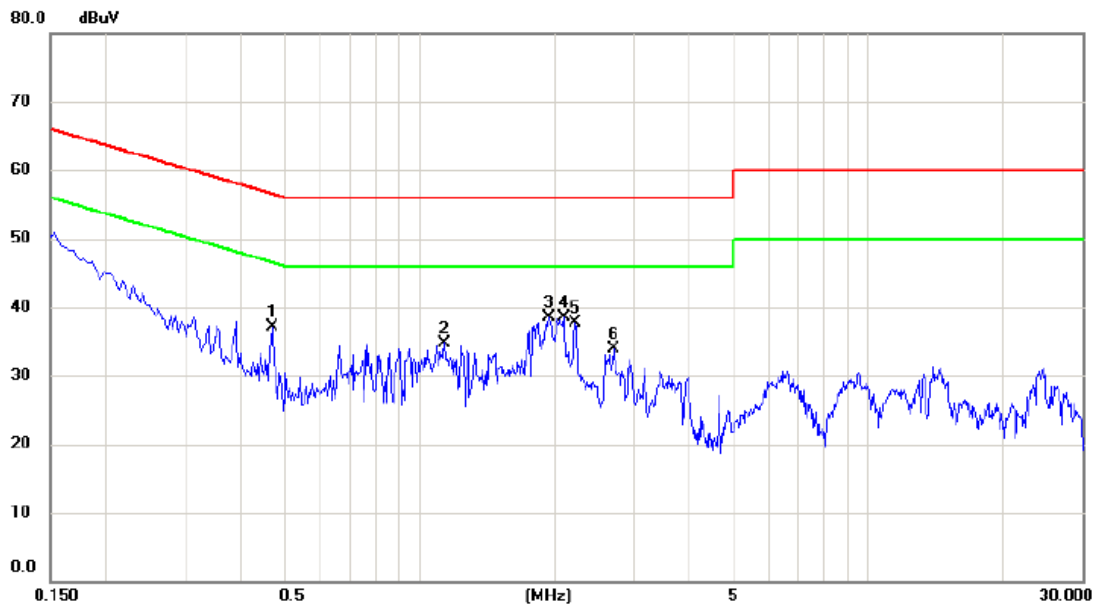

No.	Mk.	Freq. MHz	Reading Level dBuV	Correct Factor dB	Measure- ment dBuV	Limit dBuV	Margin dB	Detector	Comment
1		0.4700	27.70	9.49	37.19	56.51	-19.32	peak	
2		1.1380	25.05	9.75	34.80	56.00	-21.20	peak	
3	*	1.9380	28.64	9.81	38.45	56.00	-17.55	peak	
4		2.0980	28.60	9.83	38.43	56.00	-17.57	peak	
5		2.2260	27.76	9.87	37.63	56.00	-18.37	peak	
6		2.7020	23.87	9.95	33.82	56.00	-22.18	peak	

ATTACHMENT B - RADIATED EMISSION (9KHZ TO 30MHZ)

Test Mode: TX Mode

Ant 0°

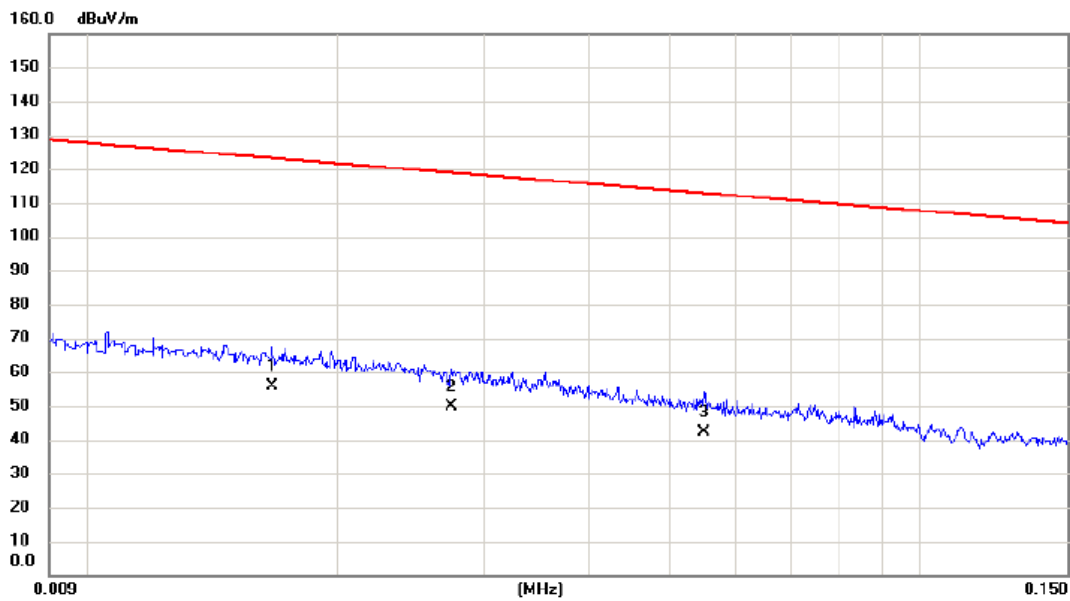

No.	Mk.	Freq. MHz	Reading Level dBuV	Correct Factor dB	Measurement dBuV/m	Limit dBuV/m	Margin dB	Detector	Comment
1	*	0.0167	31.90	23.72	55.62	123.15	-67.53	AVG	
2		0.0274	27.20	22.61	49.81	118.85	-69.04	AVG	
3		0.0550	22.40	19.77	42.17	112.80	-70.63	AVG	

Test Mode: TX Mode

Ant 0°

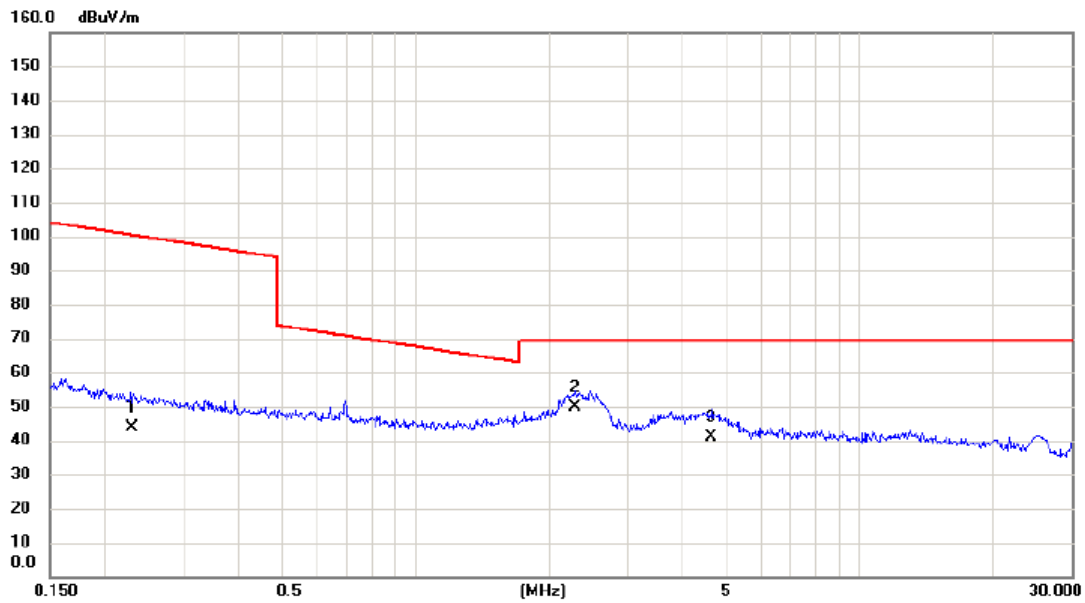

No.	Mk.	Freq. MHz	Reading Level dBuV	Correct Factor dB	Measure- ment dBuV/m	Limit dBuV/m	Margin dB	Detector	Comment
1		0.2292	25.33	18.67	44.00	100.40	-56.40	AVG	
2	*	2.2847	32.16	17.54	49.70	69.54	-19.84	QP	
3		4.6468	23.60	17.41	41.01	69.54	-28.53	QP	

Test Mode: TX Mode

Ant 90°

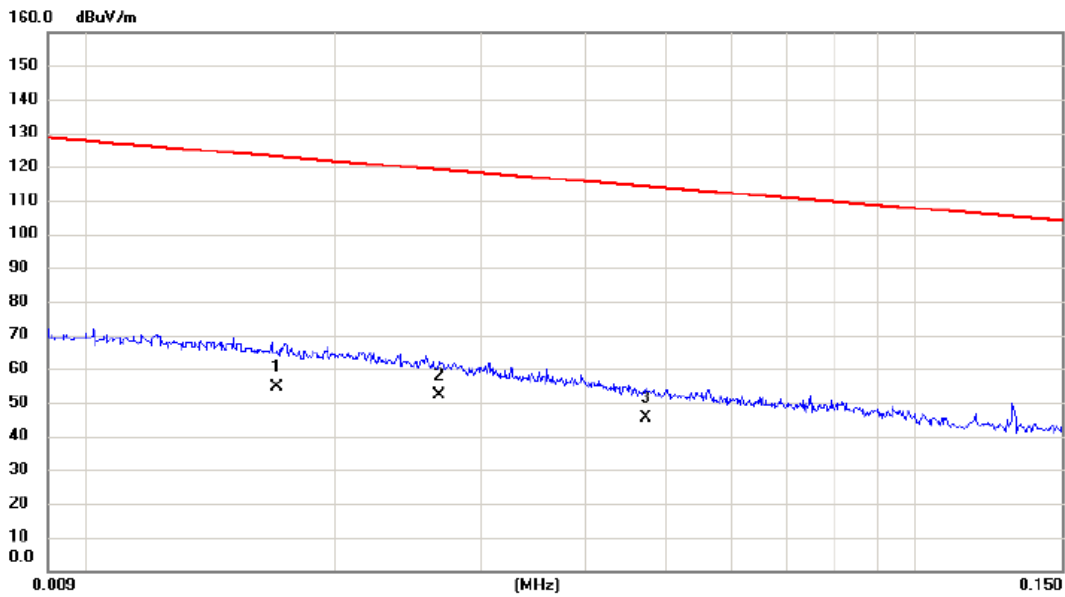

No.	Mk.	Freq. MHz	Reading Level dBuV	Correct Factor dB	Measure- ment dBuV/m	Limit dBuV/m	Margin dB	Detector	Comment
1		0.0170	31.03	23.70	54.73	123.00	-68.27	AVG	
2	*	0.0267	29.56	22.69	52.25	119.07	-66.82	AVG	
3		0.0473	25.07	20.15	45.22	114.11	-68.89	AVG	

Test Mode: TX Mode

Ant 90°

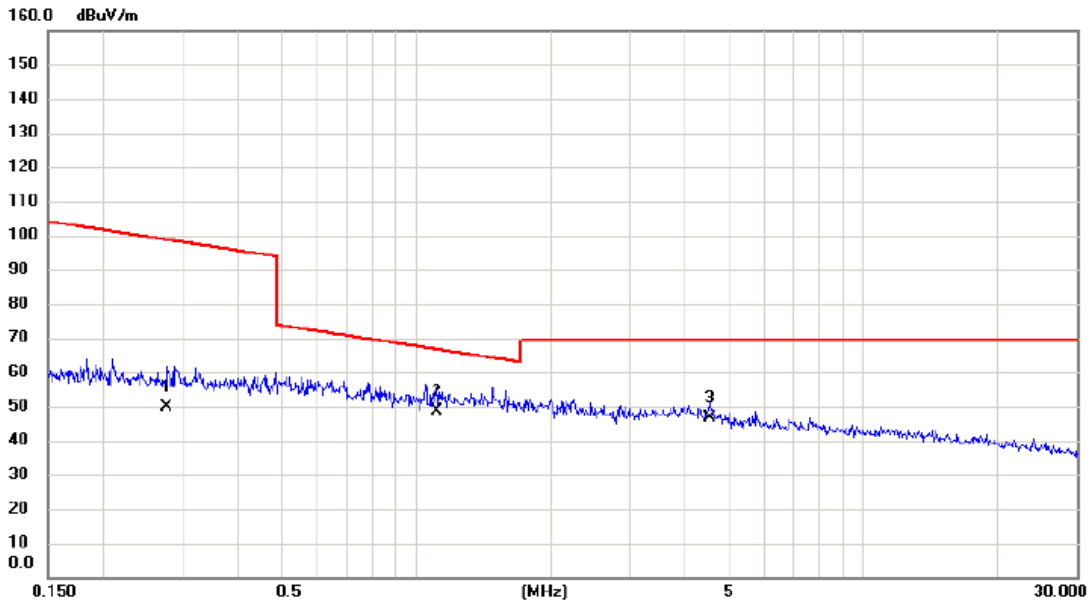

No.	Mk.	Freq. MHz	Reading Level dBuV	Correct Factor dB	Measure- ment dBuV/m	Limit dBuV/m	Margin dB	Detector	Comment
1		0.2773	31.03	18.62	49.65	98.75	-49.10	AVG	
2	*	1.1114	30.86	17.70	48.56	66.69	-18.13	QP	
3		4.5254	28.76	17.67	46.43	69.54	-23.11	QP	

ATTACHMENT C - RADIATED EMISSION (30MHZ TO 1000MHZ)

Test Mode: TX 2405.35MHz

Vertical

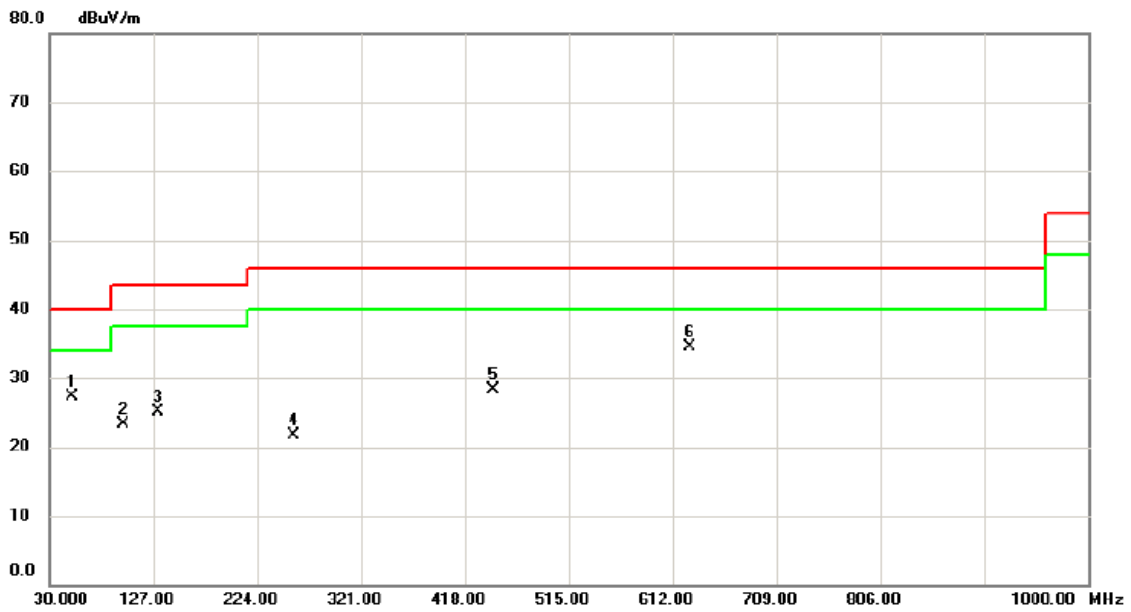

No. Mk.	Freq. MHz	Reading Level dBuV	Correct Factor dB	Measurement dBuV/m	Limit dBuV/m	Margin dB	Detector	Comment
1	51.340	39.75	-12.36	27.39	40.00	-12.61	peak	
2	99.355	38.03	-14.75	23.28	43.50	-20.22	peak	
3	131.850	36.43	-11.28	25.15	43.50	-18.35	peak	
4	257.950	34.64	-12.99	21.65	46.00	-24.35	peak	
5	444.190	35.45	-7.09	28.36	46.00	-17.64	peak	
6 *	628.490	37.46	-3.04	34.42	46.00	-11.58	peak	

Test Mode: TX 2405.35MHz

Horizontal

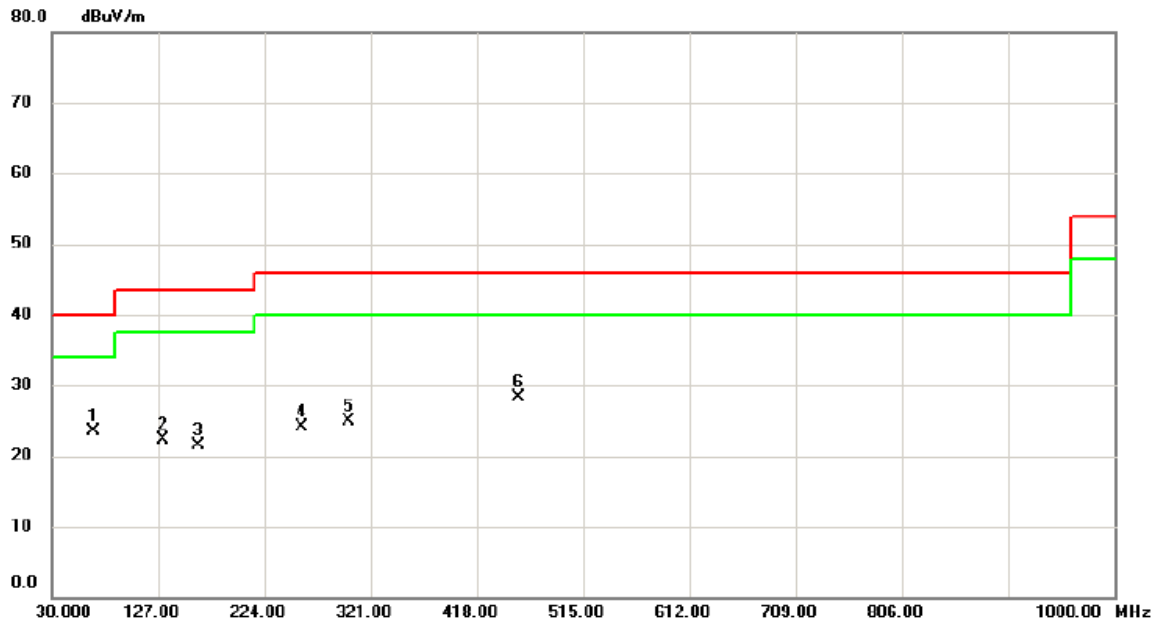

No.	Mk.	Freq. MHz	Reading Level dBuV	Correct Factor dB	Measure- ment dBuV/m	Limit dBuV/m	Margin dB	Detector	Comment
1	*	68.315	38.13	-14.72	23.41	40.00	-16.59	peak	
2		131.850	33.67	-11.28	22.39	43.50	-21.11	peak	
3		163.860	33.41	-11.85	21.56	43.50	-21.94	peak	
4		257.950	37.13	-12.99	24.14	46.00	-21.86	peak	
5		301.115	34.89	-9.96	24.93	46.00	-21.07	peak	
6		455.830	35.46	-7.14	28.32	46.00	-17.68	peak	

Test Mode: TX 2441.35MHz

Vertical

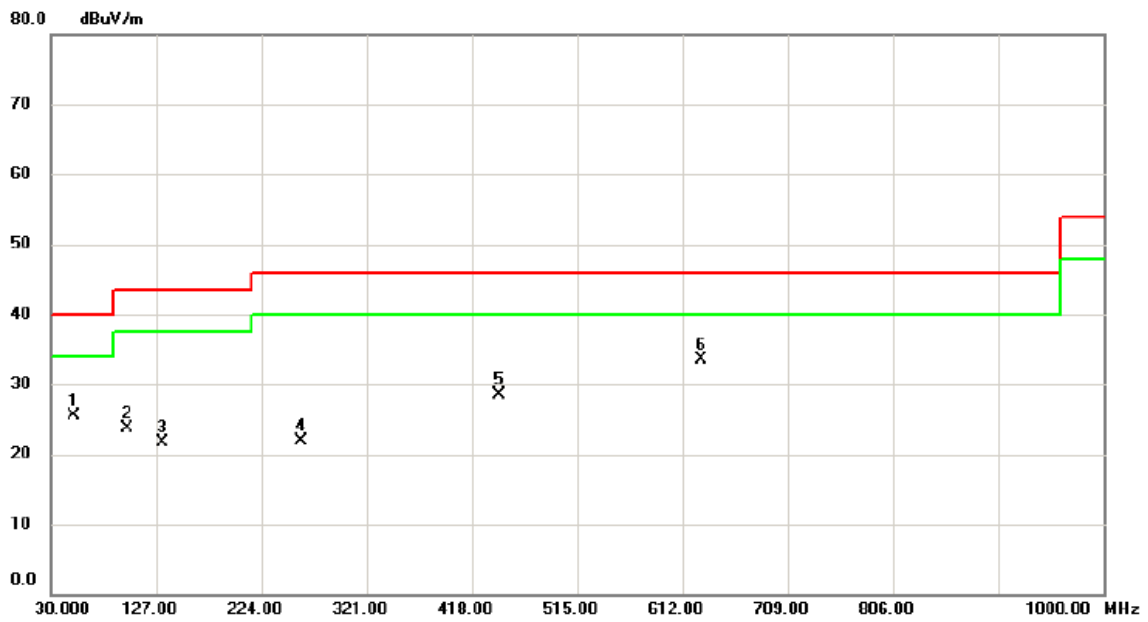

No.	Mk.	Freq. MHz	Reading Level dBuV	Correct Factor dB	Measure- ment dBuV/m	Limit dBuV/m	Margin dB	Detector	Comment
1		51.825	38.00	-12.48	25.52	40.00	-14.48	peak	
2		99.840	38.30	-14.58	23.72	43.50	-19.78	peak	
3		132.335	32.99	-11.31	21.68	43.50	-21.82	peak	
4		260.375	34.78	-12.87	21.91	46.00	-24.09	peak	
5		442.735	35.58	-7.09	28.49	46.00	-17.51	peak	
6	*	629.460	36.55	-2.98	33.57	46.00	-12.43	peak	

Test Mode: TX 2441.35MHz

Horizontal

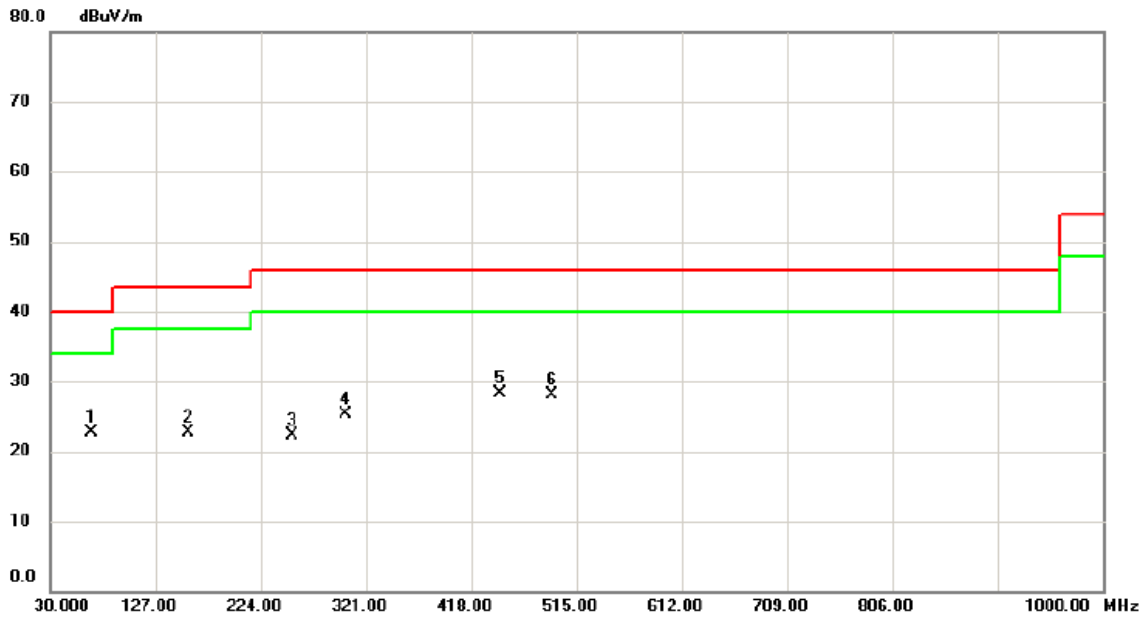

No.	Mk.	Freq. MHz	Reading Level dBuV	Correct Factor dB	Measure- ment dBuV/m	Limit dBuV/m	Margin dB	Detector	Comment
1	*	68.315	37.40	-14.72	22.68	40.00	-17.32	peak	
2		157.555	35.13	-12.40	22.73	43.50	-20.77	peak	
3		252.615	35.50	-13.23	22.27	46.00	-23.73	peak	
4		301.600	35.21	-9.96	25.25	46.00	-20.75	peak	
5		444.190	35.37	-7.09	28.28	46.00	-17.72	peak	
6		491.720	35.73	-7.55	28.18	46.00	-17.82	peak	

Test Mode: TX 2477.35MHz

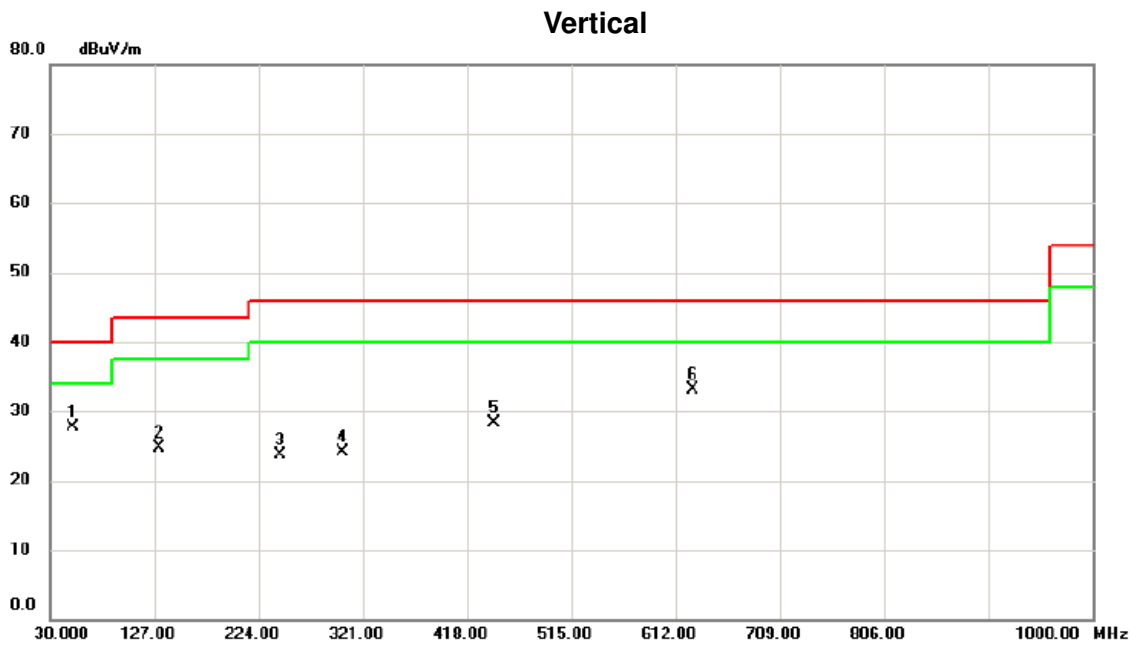

No.	Mk.	Freq.	Reading Level	Correct Factor	Measurement	Limit	Margin	Detector	Comment
		MHz	dBuV	dB	dBuV/m	dBuV/m	dB		
1	*	50.855	39.94	-12.23	27.71	40.00	-12.29	peak	
2		131.850	35.92	-11.28	24.64	43.50	-18.86	peak	
3		243.400	37.02	-13.36	23.66	46.00	-22.34	peak	
4		301.600	33.97	-9.96	24.01	46.00	-21.99	peak	
5		443.705	35.30	-7.09	28.21	46.00	-17.79	peak	
6		628.490	36.24	-3.04	33.20	46.00	-12.80	peak	

Test Mode: TX 2477.35MHz

Horizontal

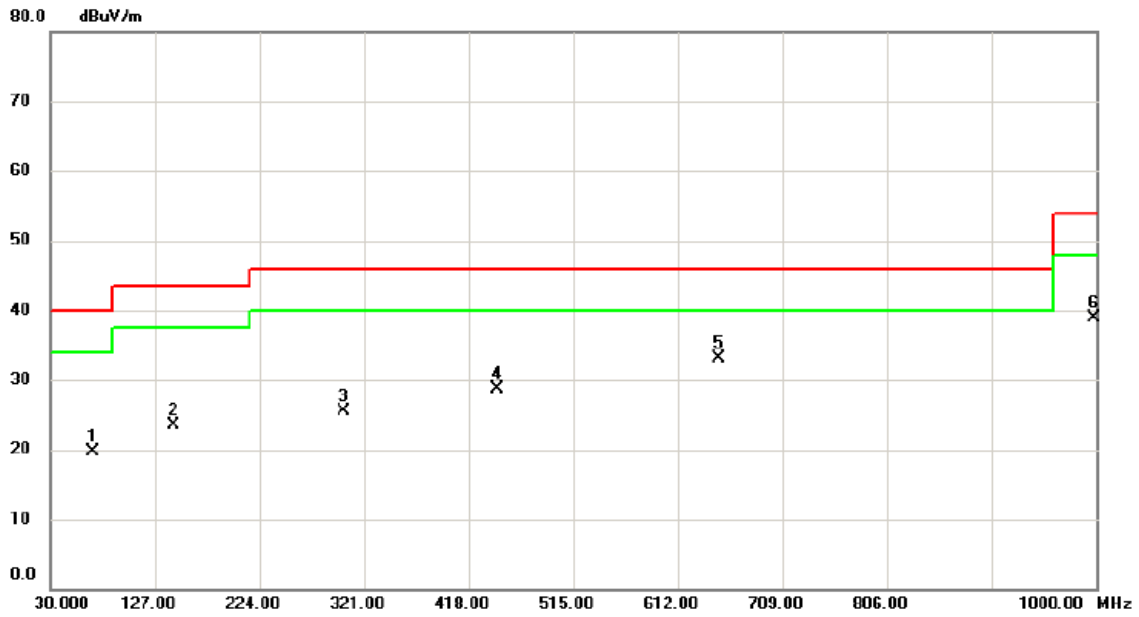

No.	Mk.	Freq. MHz	Reading Level dBuV	Correct Factor dB	Measure- ment dBuV/m	Limit dBuV/m	Margin dB	Detector	Comment
1		69.770	34.86	-15.15	19.71	40.00	-20.29	peak	
2		143.975	35.37	-11.89	23.48	43.50	-20.02	peak	
3		301.600	35.46	-9.96	25.50	46.00	-20.50	peak	
4		444.190	35.79	-7.09	28.70	46.00	-17.30	peak	
5	*	649.830	34.82	-1.70	33.12	46.00	-12.88	peak	
6		997.575	35.08	3.90	38.98	54.00	-15.02	peak	

ATTACHMENT D - RADIATED EMISSION (ABOVE 1000MHZ)

Test Mode TX Mode_2405.35 MHz

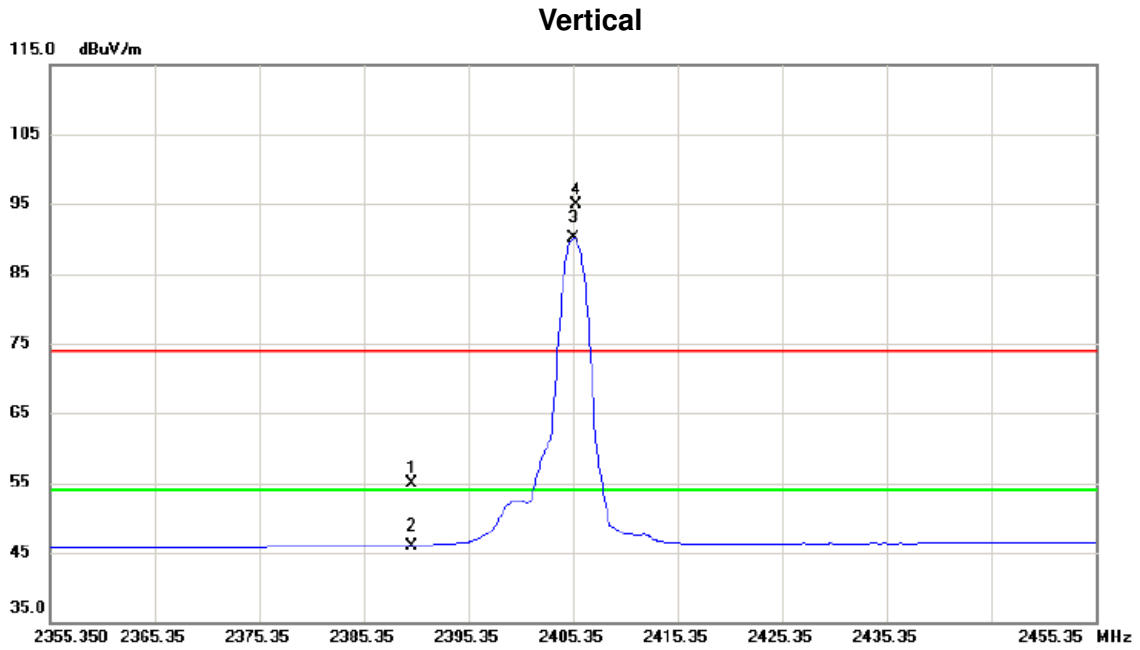

No.	Mk.	Freq. MHz	Reading Level dBuV	Correct Factor dB	Measure- ment dBuV/m	Limit dBuV/m	Margin dB	Detector	Comment
1		2390.000	21.85	33.01	54.86	74.00	-19.14	peak	
2		2390.000	12.97	33.01	45.98	54.00	-8.02	AVG	
3	*	2405.450	57.01	33.08	90.09	54.00	36.09	AVG	No limit
4	X	2405.650	61.75	33.08	94.83	74.00	20.83	peak	No limit

Test Mode TX Mode_2405.35 MHz

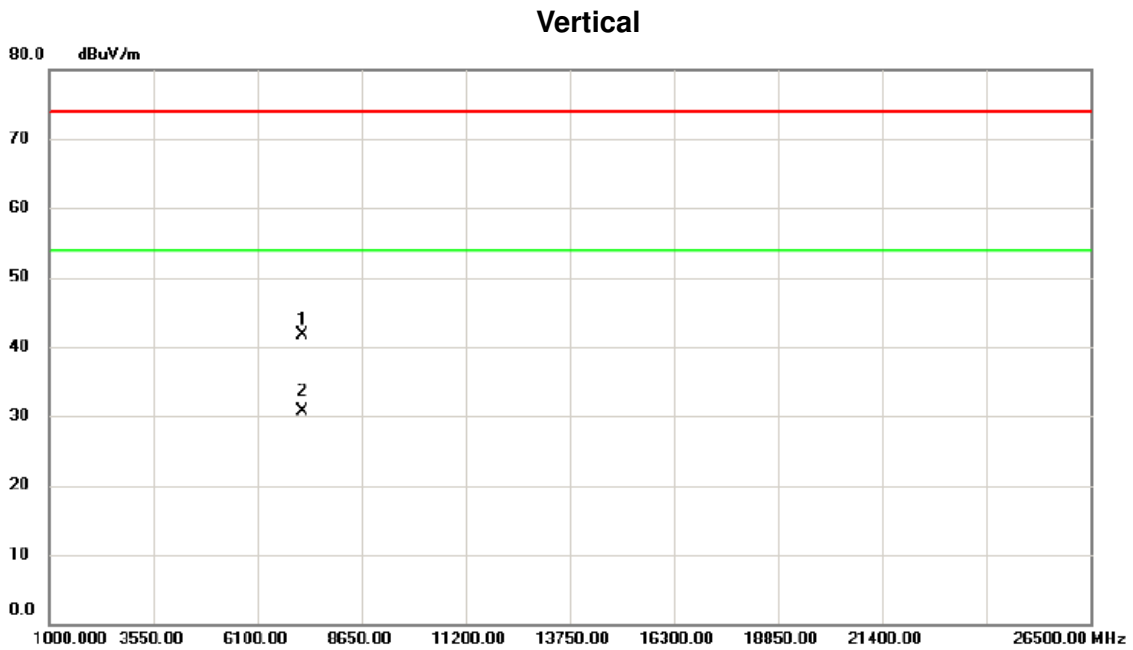

No.	Mk.	Freq. MHz	Reading Level dBuV	Correct Factor dB	Measure- ment dBuV/m	Limit dBuV/m	Margin dB	Detector	Comment
1		7208.750	30.53	11.12	41.65	74.00	-32.35	peak	
2	*	7210.590	19.68	11.12	30.80	54.00	-23.20	AVG	

Test Mode TX Mode_2405.35 MHz

Vertical

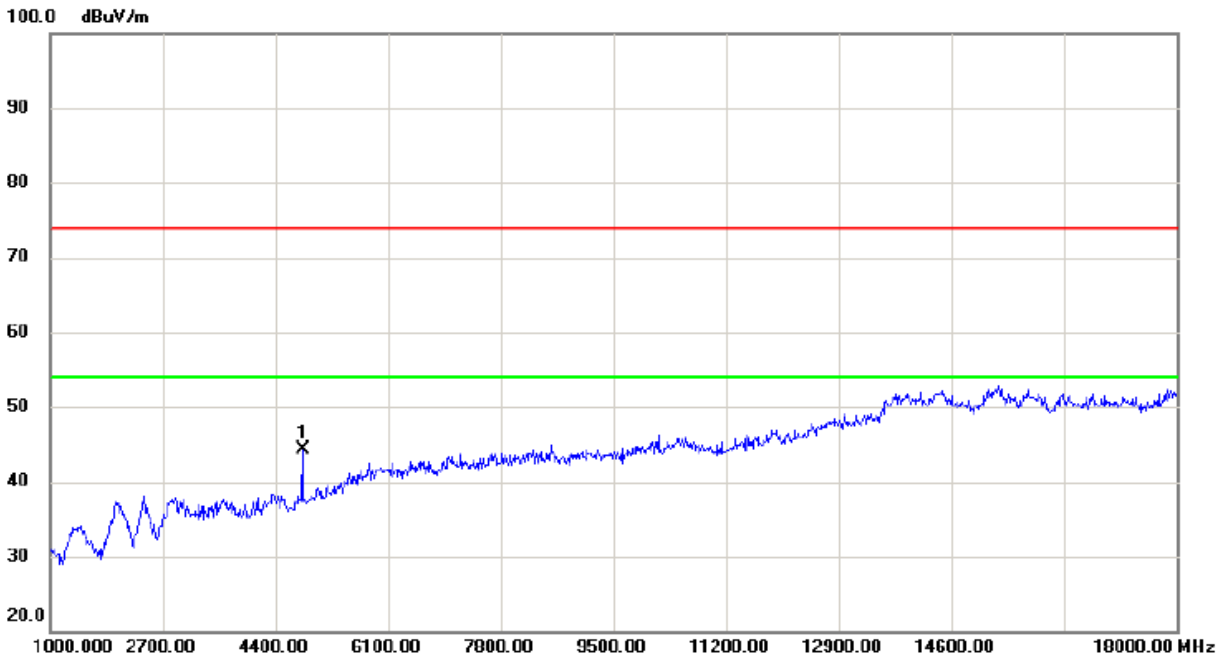

No.	Mk.	Freq. MHz	Reading Level dBuV	Correct Factor dB	Measure- ment dBuV/m	Limit dBuV/m	Margin dB	Detector	Comment
1	*	4808.000	38.81	5.42	44.23	74.00	-29.77	peak	

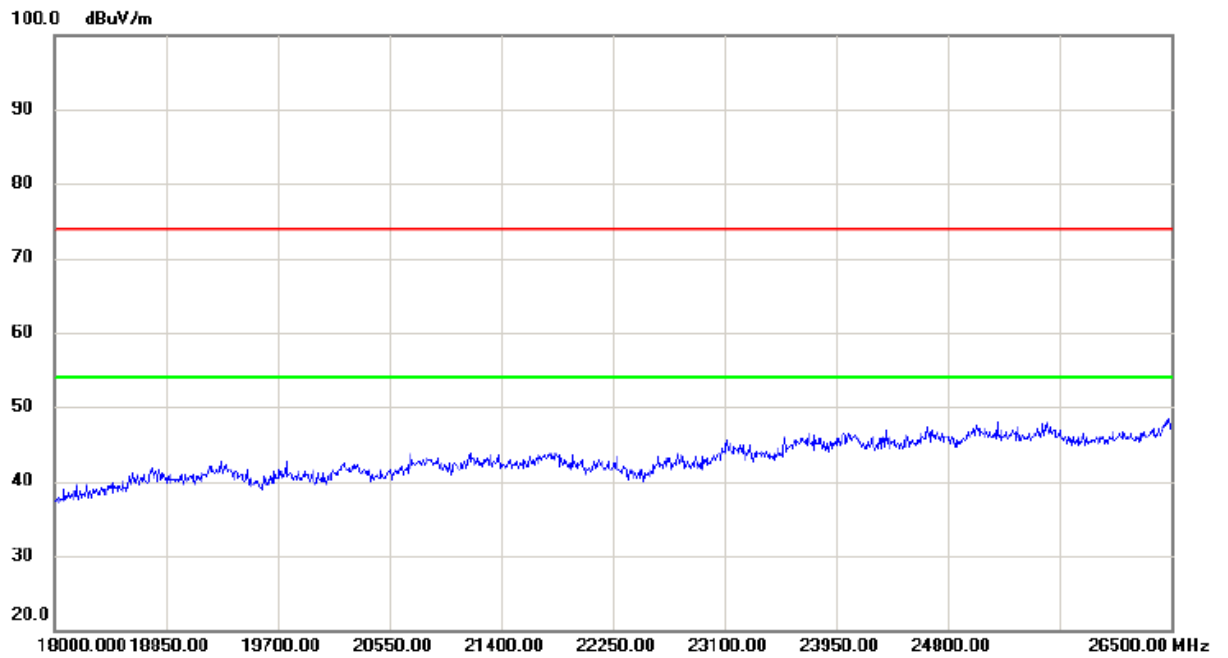

No.	Mk.	Freq. MHz	Reading Level dBuV	Correct Factor dB	Measure- ment dBuV/m	Limit dBuV/m	Margin dB	Detector	Comment
-----	-----	--------------	--------------------------	-------------------------	----------------------------	-----------------	--------------	----------	---------

Test Mode TX Mode_2405.35 MHz

Horizontal

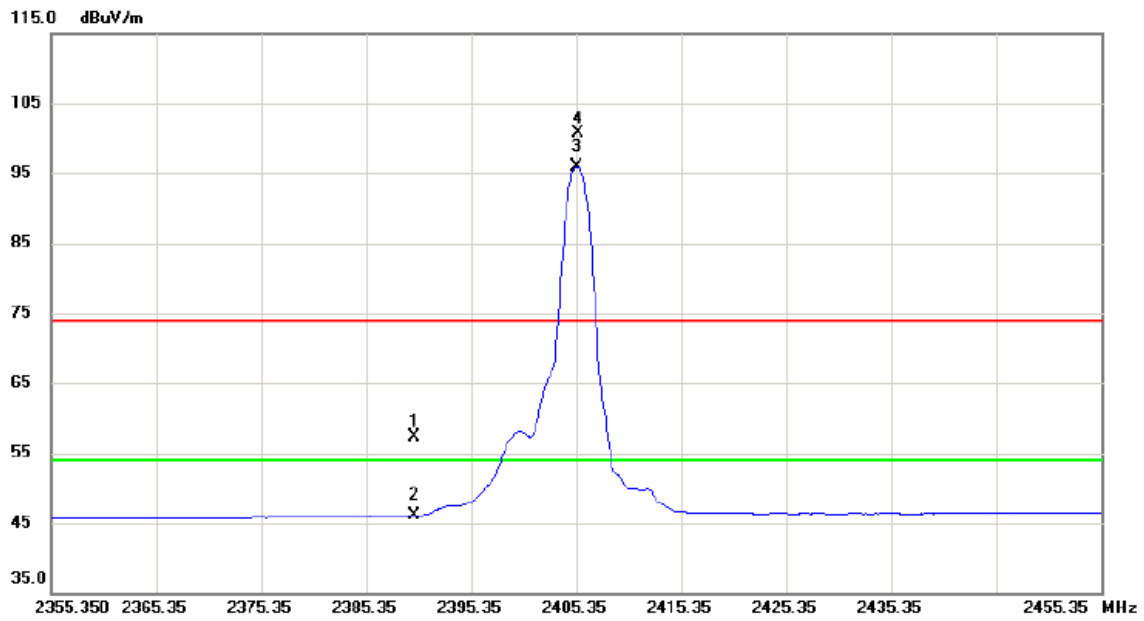

No.	Mk.	Freq. MHz	Reading Level dBuV	Correct Factor dB	Measure- ment dBuV/m	Limit dBuV/m	Margin dB	Detector	Comment
1		2390.000	24.26	33.01	57.27	74.00	-16.73	peak	
2		2390.000	13.11	33.01	46.12	54.00	-7.88	AVG	
3	*	2405.450	62.92	33.08	96.00	54.00	42.00	AVG	No limit
4	X	2405.550	67.59	33.08	100.67	74.00	26.67	peak	No limit

Test Mode	TX Mode_2405.35 MHz
-----------	---------------------

Horizontal

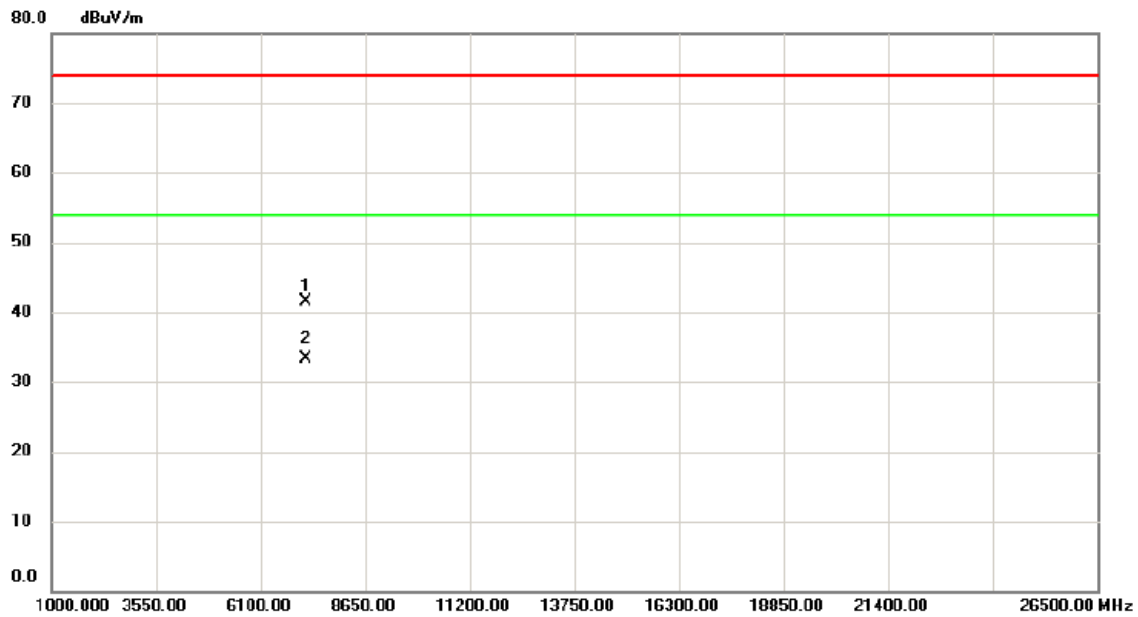

No.	Mk.	Freq.	Reading Level	Correct Factor	Measurement	Limit	Margin	Detector	Comment
		MHz	dBuV	dB	dBuV/m	dBuV/m	dB		
1		7210.590	30.30	11.12	41.42	74.00	-32.58	peak	
2	*	7211.270	22.11	11.12	33.23	54.00	-20.77	AVG	

Test Mode TX Mode_2441.35 MHz

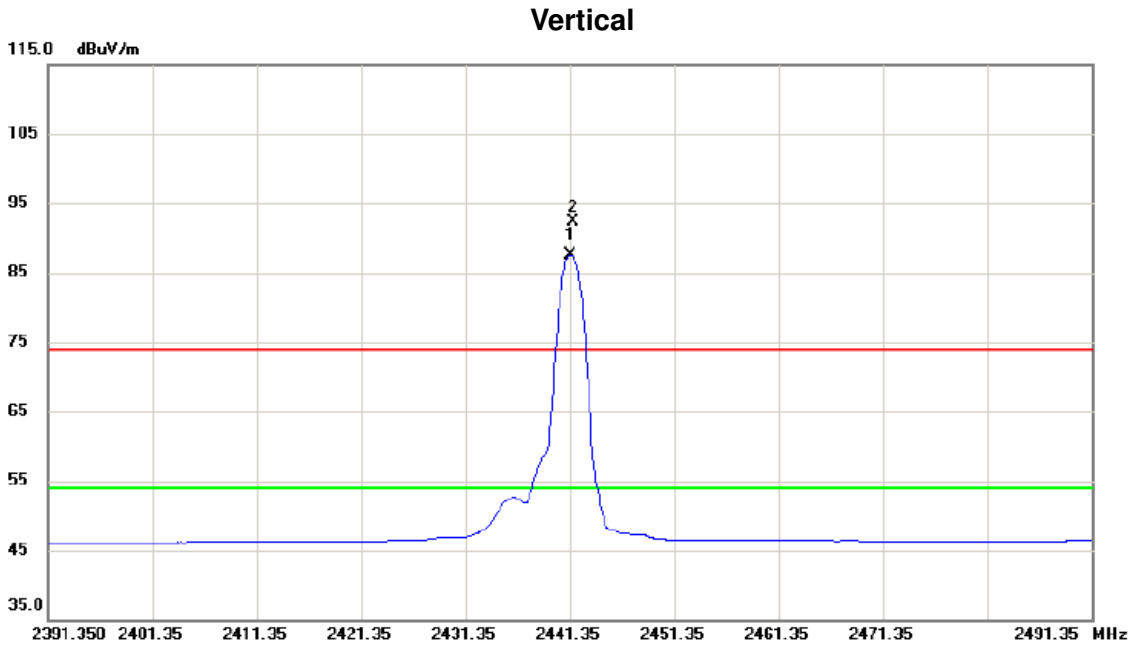

No.	Mk.	Freq. MHz	Reading Level dBuV	Correct Factor dB	Measure- ment dBuV/m	Limit dBuV/m	Margin dB	Detector	Comment
1	*	2441.450	54.38	33.22	87.60	54.00	33.60	AVG	No limit
2	X	2441.650	59.07	33.22	92.29	74.00	18.29	peak	No limit

Test Mode TX Mode_2441.35 MHz

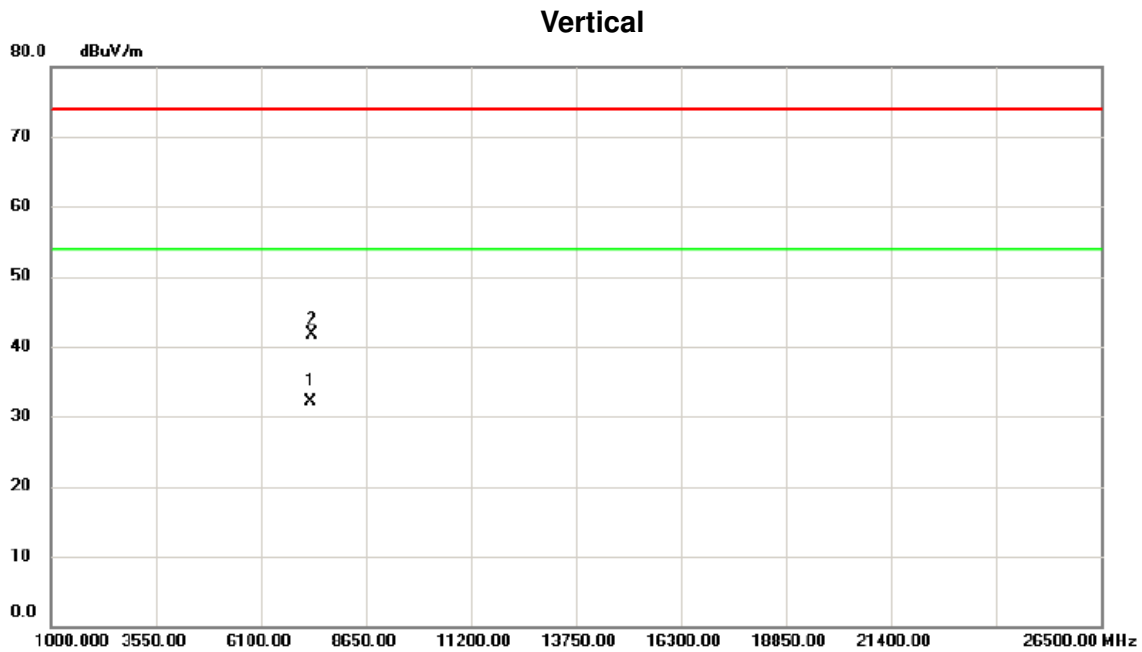

No.	Mk.	Freq. MHz	Reading Level dBuV	Correct Factor dB	Measure- ment dBuV/m	Limit dBuV/m	Margin dB	Detector	Comment
1	*	7323.970	20.73	11.37	32.10	54.00	-21.90	AVG	
2		7325.050	30.30	11.37	41.67	74.00	-32.33	peak	

Test Mode TX Mode_2441.35 MHz

Vertical

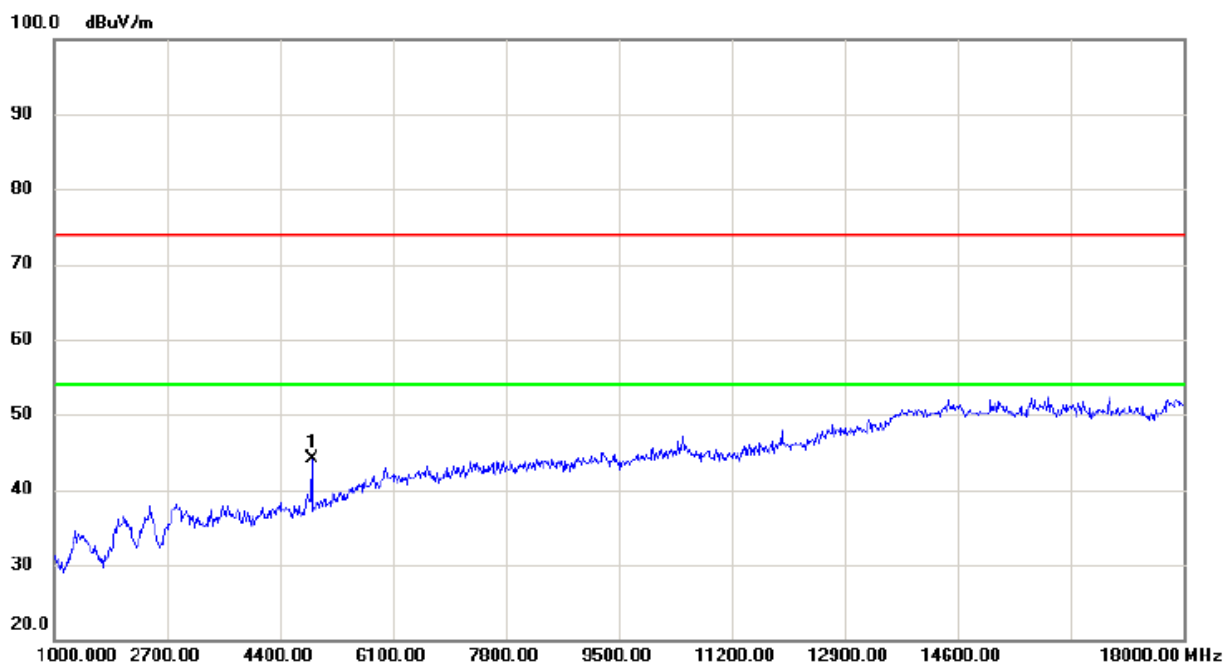

No.	Mk.	Freq. MHz	Reading Level dBuV	Correct Factor dB	Measure- ment dBuV/m	Limit dBuV/m	Margin dB	Detector	Comment
1	*	4876.000	38.55	5.61	44.16	74.00	-29.84	peak	

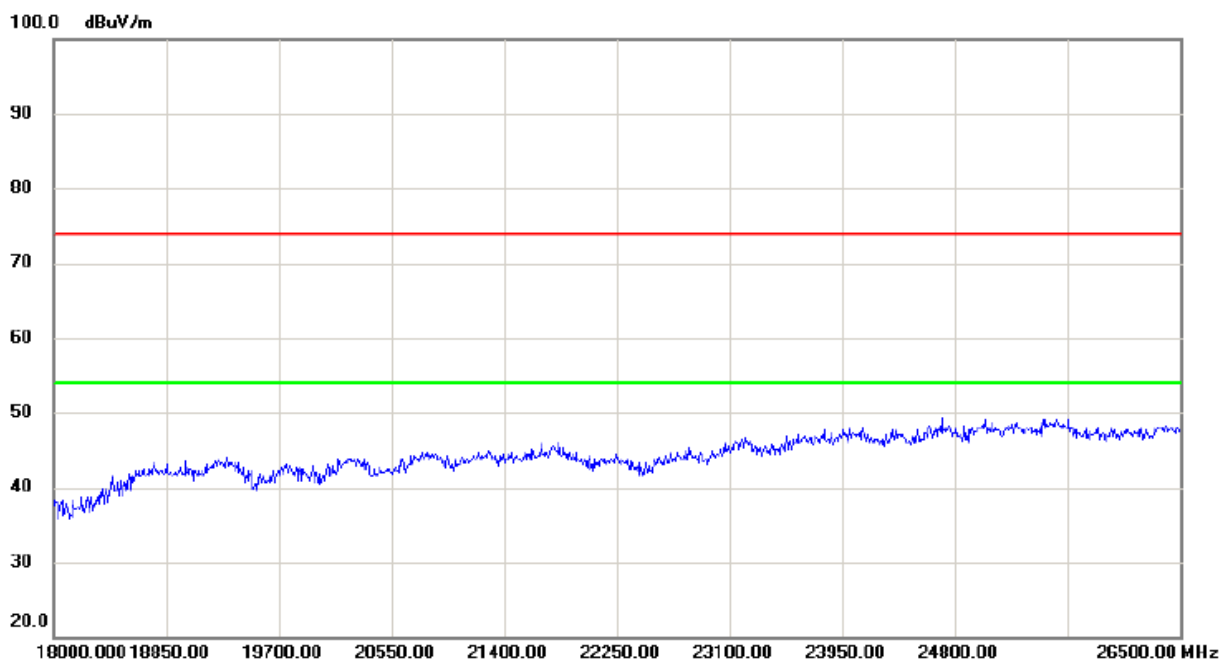

No.	Mk.	Freq. MHz	Reading Level dBuV	Correct Factor dB	Measure- ment dBuV/m	Limit dBuV/m	Margin dB	Detector	Comment
-----	-----	--------------	--------------------------	-------------------------	----------------------------	-----------------	--------------	----------	---------

Test Mode TX Mode_2441.35 MHz

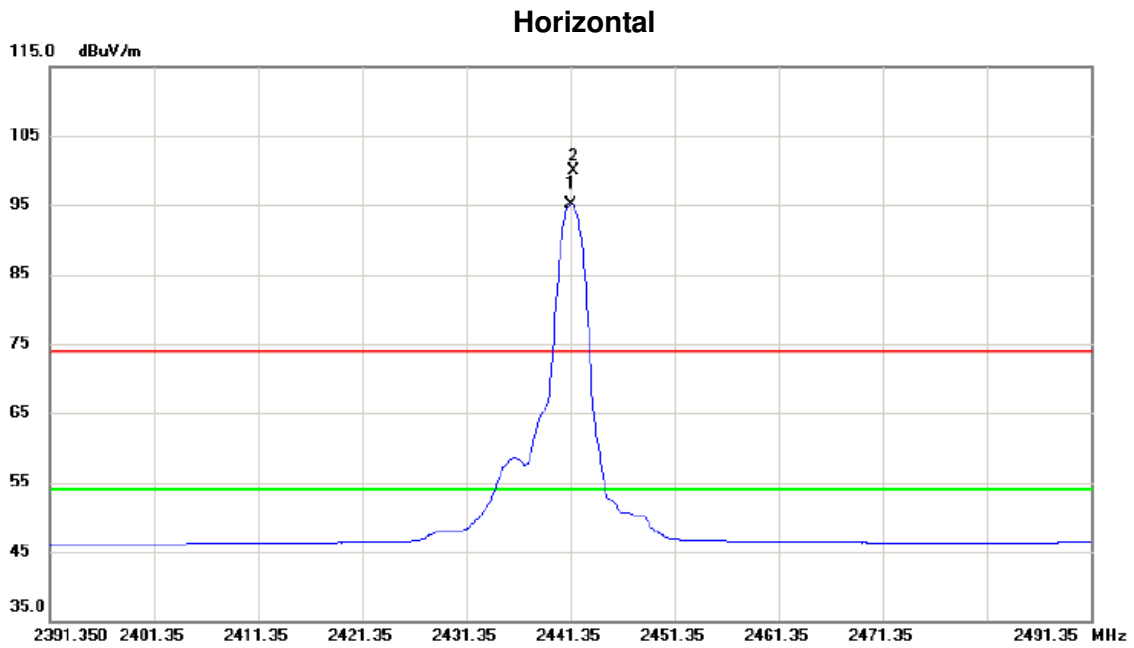

No.	Mk.	Freq. MHz	Reading Level dBuV	Correct Factor dB	Measure- ment dBuV/m	Limit dBuV/m	Margin dB	Detector	Comment
1	*	2441.450	61.92	33.22	95.14	54.00	41.14	AVG	No limit
2	X	2441.650	66.62	33.22	99.84	74.00	25.84	peak	No limit

Test Mode TX Mode_2441.35 MHz

Horizontal

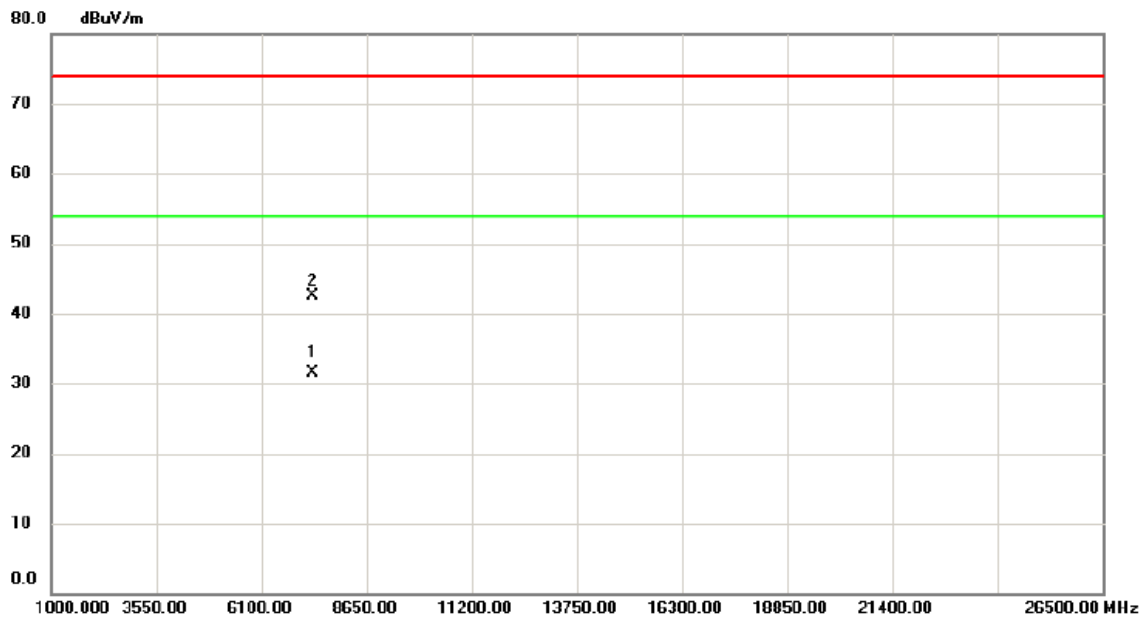

No.	Mk.	Freq. MHz	Reading Level dBuV	Correct Factor dB	Measure- ment dBuV/m	Limit dBuV/m	Margin dB	Detector	Comment
1	*	7324.030	20.13	11.37	31.50	54.00	-22.50	AVG	
2		7324.150	31.17	11.37	42.54	74.00	-31.46	peak	

Test Mode TX Mode_2477.35 MHz

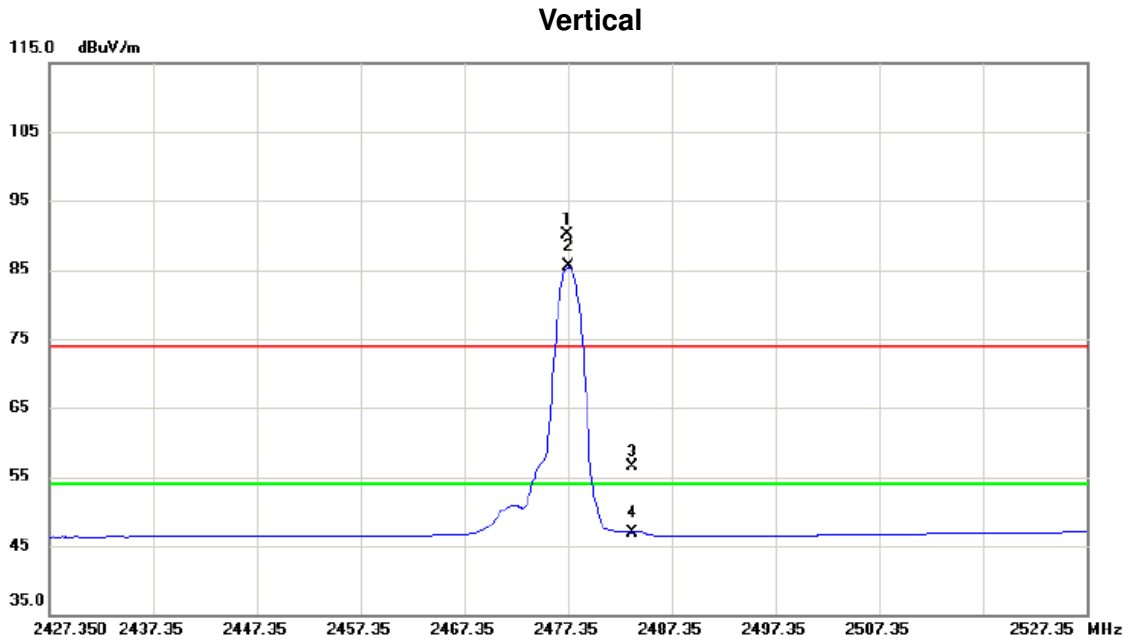

No.	Mk.	Freq. MHz	Reading Level dBuV	Correct Factor dB	Measure- ment dBuV/m	Limit dBuV/m	Margin dB	Detector	Comment
1	X	2477.250	56.76	33.38	90.14	74.00	16.14	peak	No limit
2	*	2477.450	52.02	33.38	85.40	54.00	31.40	AVG	No limit
3		2483.500	23.05	33.40	56.45	74.00	-17.55	peak	
4		2483.500	13.59	33.40	46.99	54.00	-7.01	AVG	

Test Mode TX Mode_2477.35 MHz

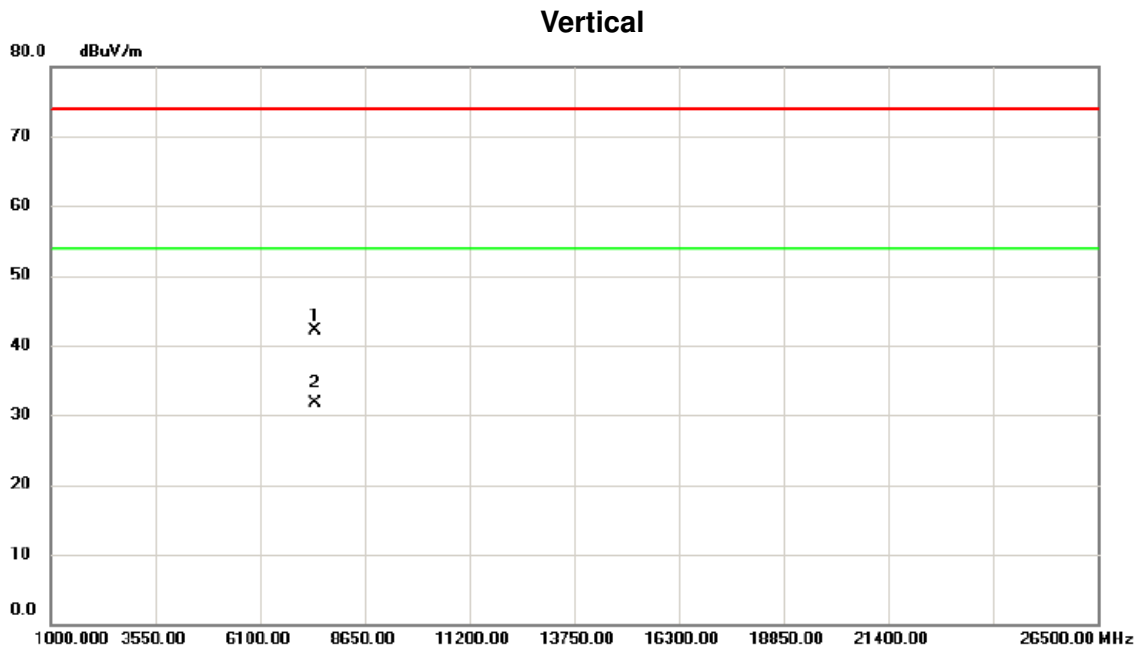

No.	Mk.	Freq. MHz	Reading Level dBuV	Correct Factor dB	Measure- ment dBuV/m	Limit dBuV/m	Margin dB	Detector	Comment
1		7431.070	30.47	11.61	42.08	74.00	-31.92	peak	
2	*	7432.210	20.11	11.61	31.72	54.00	-22.28	AVG	

Test Mode TX Mode_2477.35 MHz

Vertical

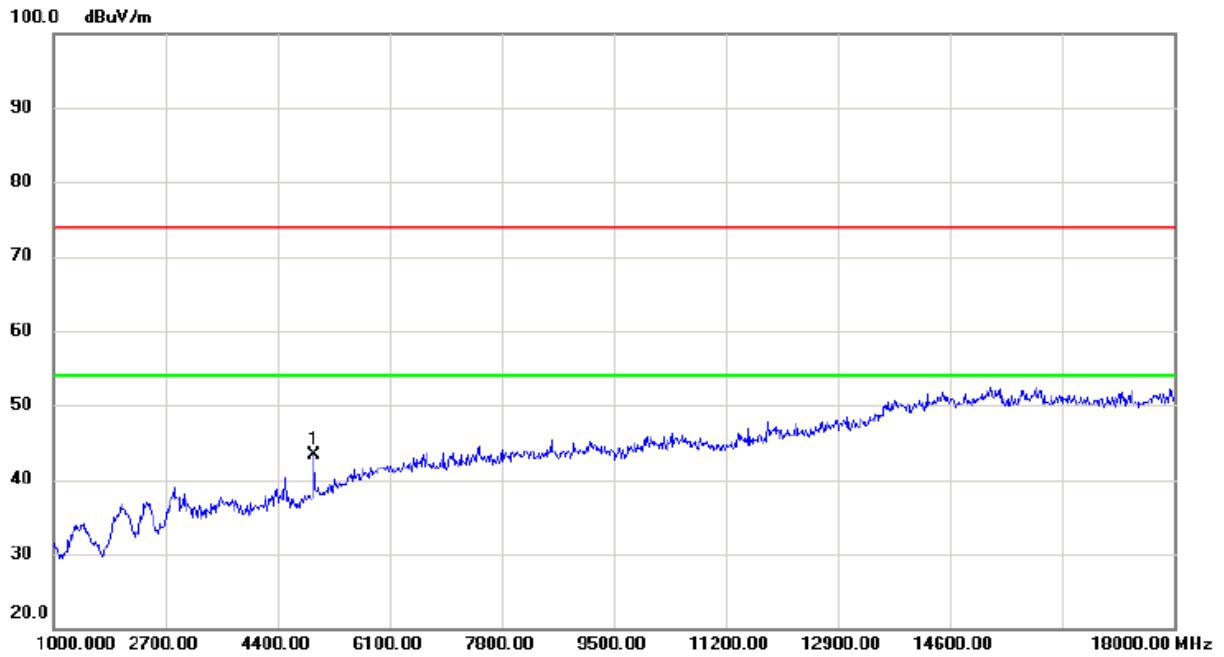

No.	Mk.	Freq. MHz	Reading Level dBuV	Correct Factor dB	Measure- ment dBuV/m	Limit dBuV/m	Margin dB	Detector	Comment
1	*	4961.000	37.43	5.84	43.27	74.00	-30.73	peak	

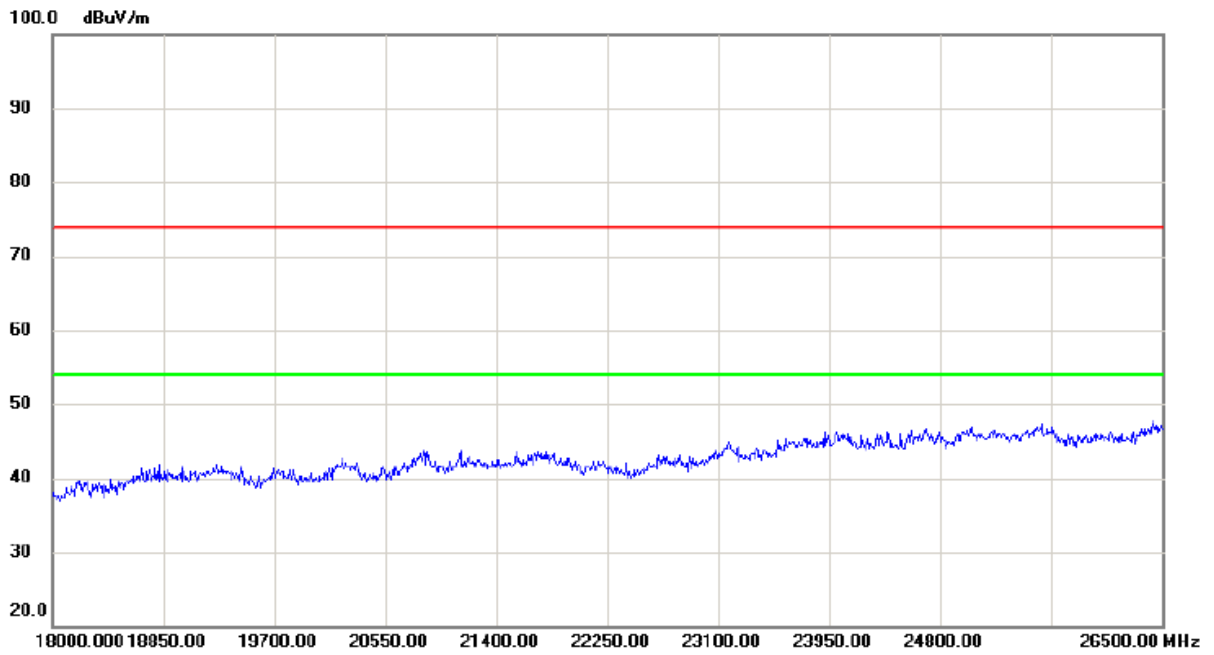

No.	Mk.	Freq. MHz	Reading Level dBuV	Correct Factor dB	Measure- ment dBuV/m	Limit dBuV/m	Margin dB	Detector	Comment
-----	-----	--------------	--------------------------	-------------------------	----------------------------	-----------------	--------------	----------	---------

Test Mode TX Mode_2477.35 MHz

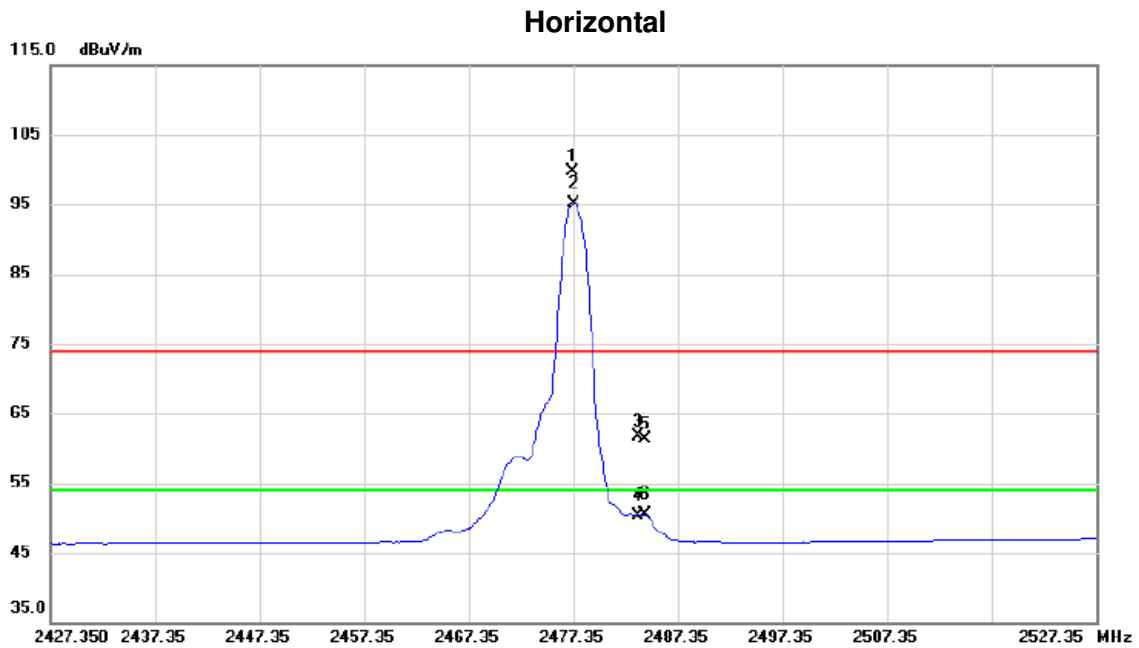

No.	Mk.	Freq. MHz	Reading Level dBuV	Correct Factor dB	Measure- ment dBuV/m	Limit dBuV/m	Margin dB	Detector	Comment
1	X	2477.250	66.40	33.38	99.78	74.00	25.78	peak	No limit
2	*	2477.450	61.71	33.38	95.09	54.00	41.09	AVG	No limit
3		2483.500	28.37	33.40	61.77	74.00	-12.23	peak	
4		2483.500	16.89	33.40	50.29	54.00	-3.71	AVG	
5		2484.150	27.92	33.40	61.32	74.00	-12.68	peak	
6		2484.150	17.19	33.40	50.59	54.00	-3.41	AVG	

Test Mode TX Mode_2477.35 MHz

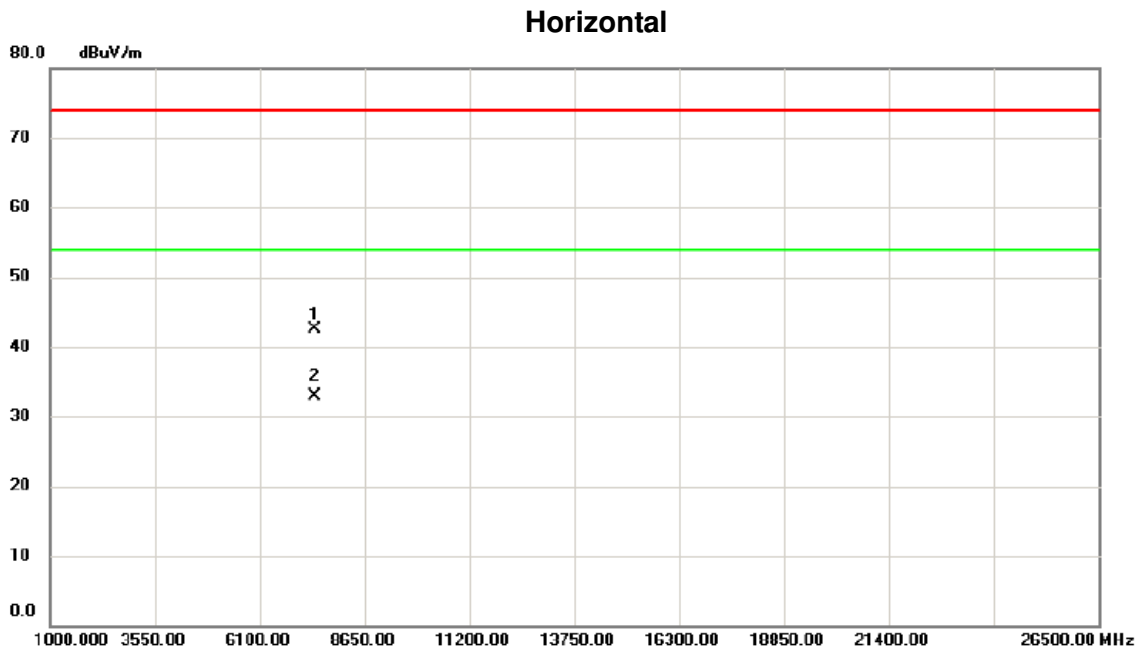

No.	Mk.	Freq. MHz	Reading Level dBuV	Correct Factor dB	Measure- ment dBuV/m	Limit dBuV/m	Margin dB	Detector	Comment
1		7431.730	30.98	11.61	42.59	74.00	-31.41	peak	
2	*	7432.270	21.29	11.61	32.90	54.00	-21.10	AVG	

ATTACHMENT E - BANDWIDTH

Test Mode:	TX Mode
------------	---------

Frequency (MHz)	6dB Bandwidth (MHz)	99% Occupied BW (MHz)	Min. Limit (kHz)	Test Result
2405.35	1.70	1.95	500	Complies
2441.35	1.64	1.94	500	Complies
2477.35	1.66	1.94	500	Complies

TX CH01

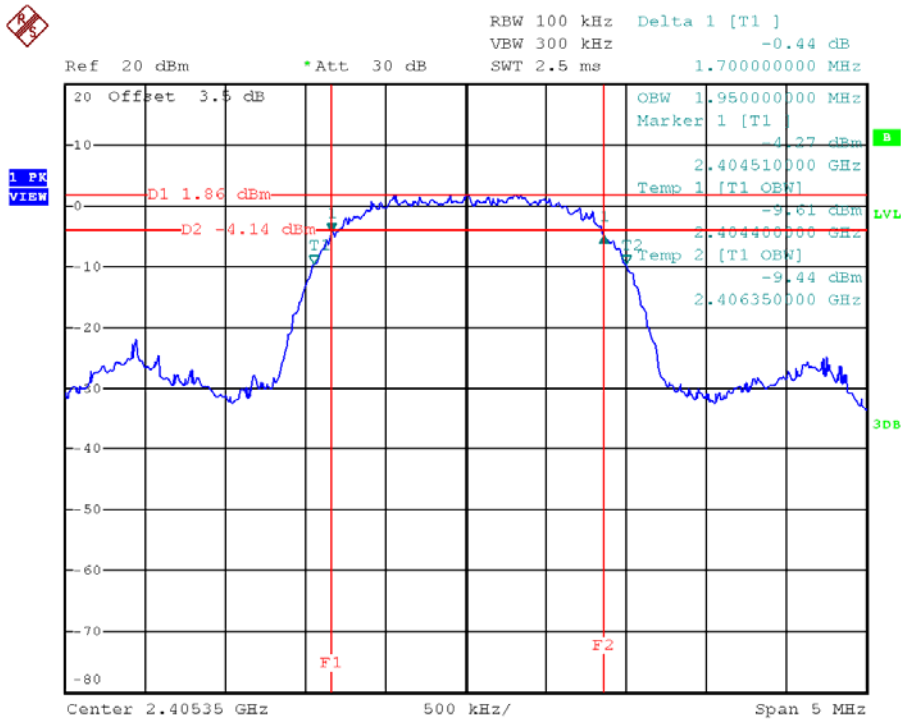

TX CH19

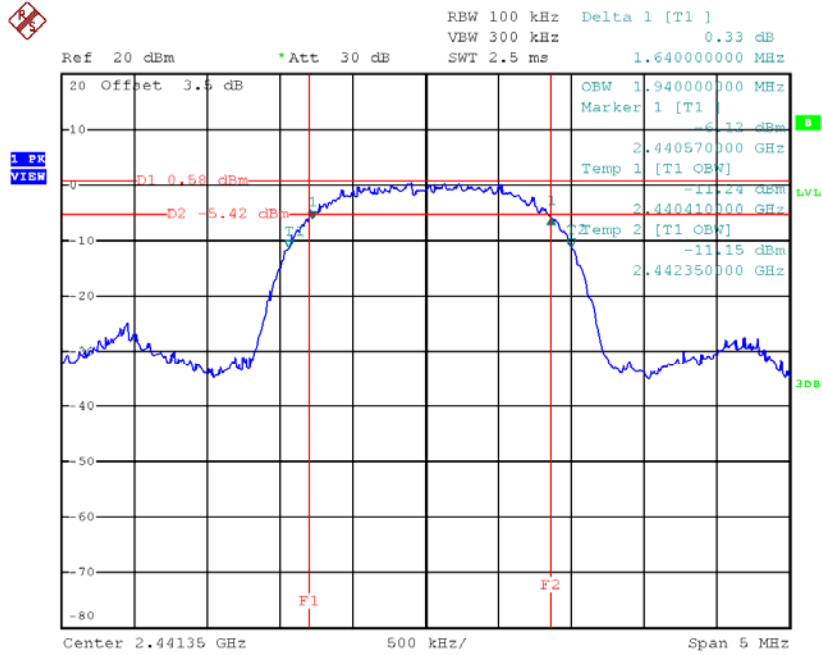

TX CH37

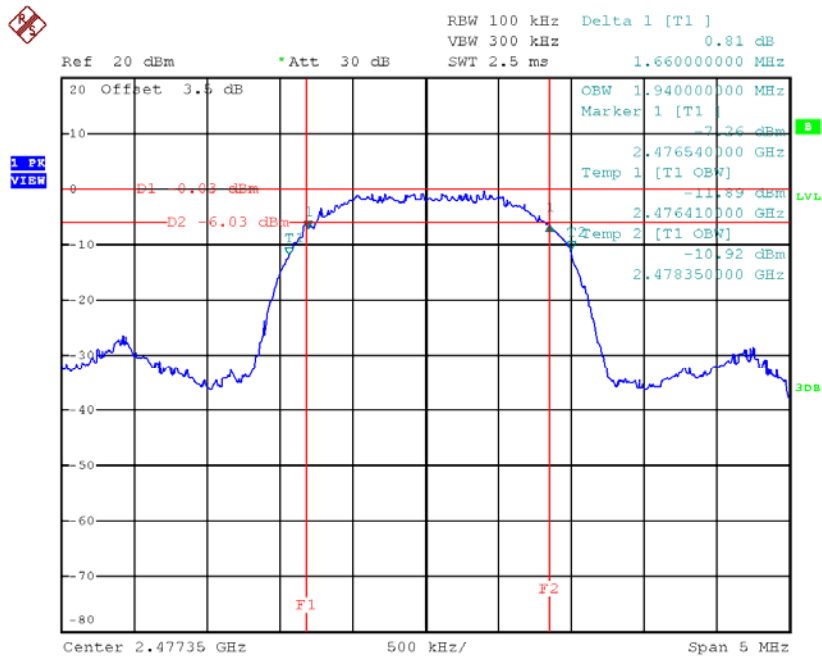

ATTACHMENT F - MAXIMUM OUTPUT POWER TEST

Test Mode					
Frequency (MHz)	Conducted Power (dBm)	Conducted Power (W)	Max. Limit (dBm)	Max. Limit (W)	Result
2405.35	6.30	0.0043	30.00	1.00	Complies
2441.35	4.47	0.0028	30.00	1.00	Complies
2477.35	3.55	0.0023	30.00	1.00	Complies

TX CH01

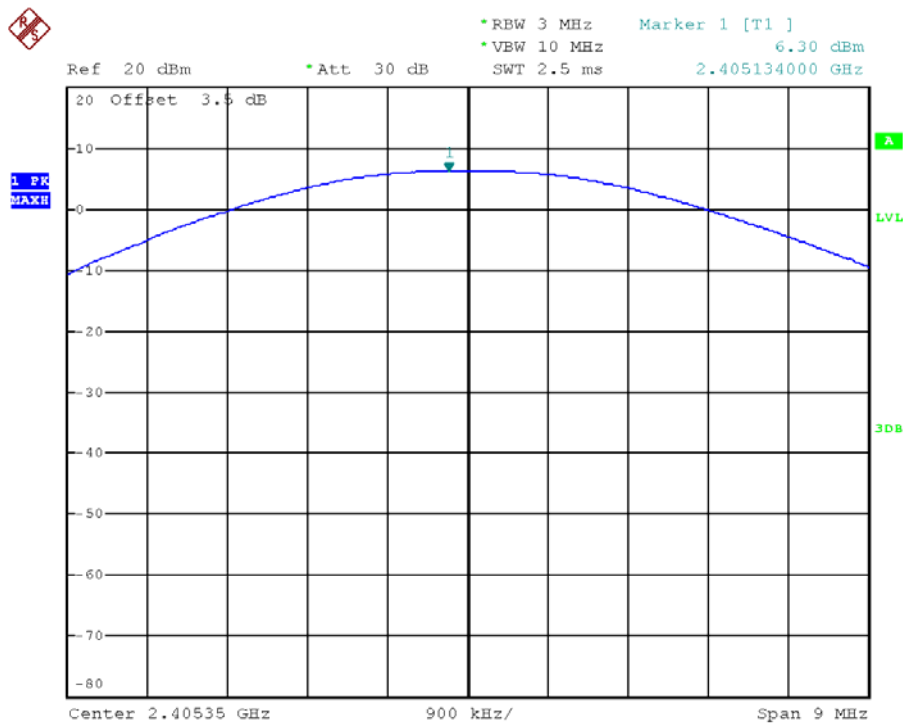

TX CH19

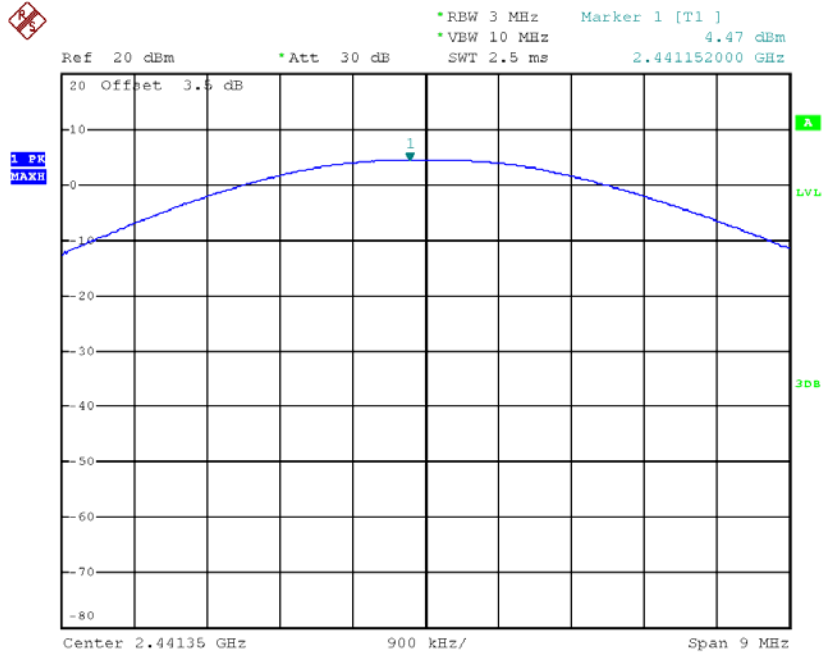

TX CH37

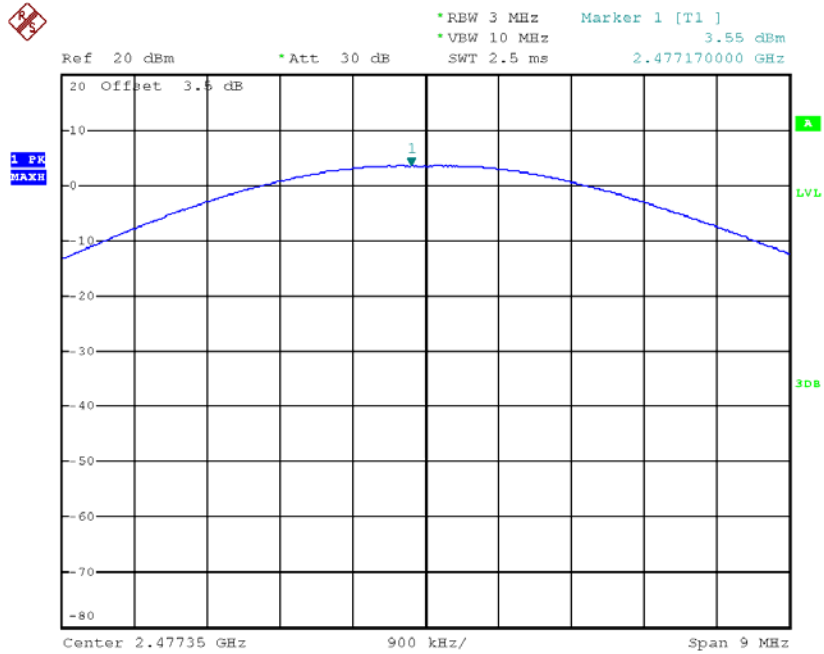

ATTACHMENT G - ANTENNA CONDUCTED SPURIOUS EMISSION

Test Mode : CH01, CH19 , CH37

CH01 (Lower)

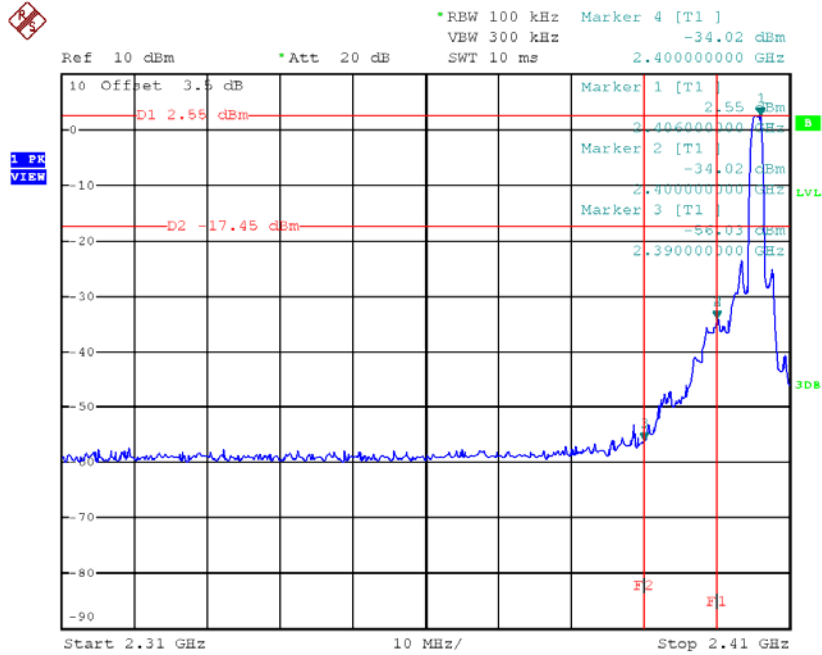

CH37 (upper)

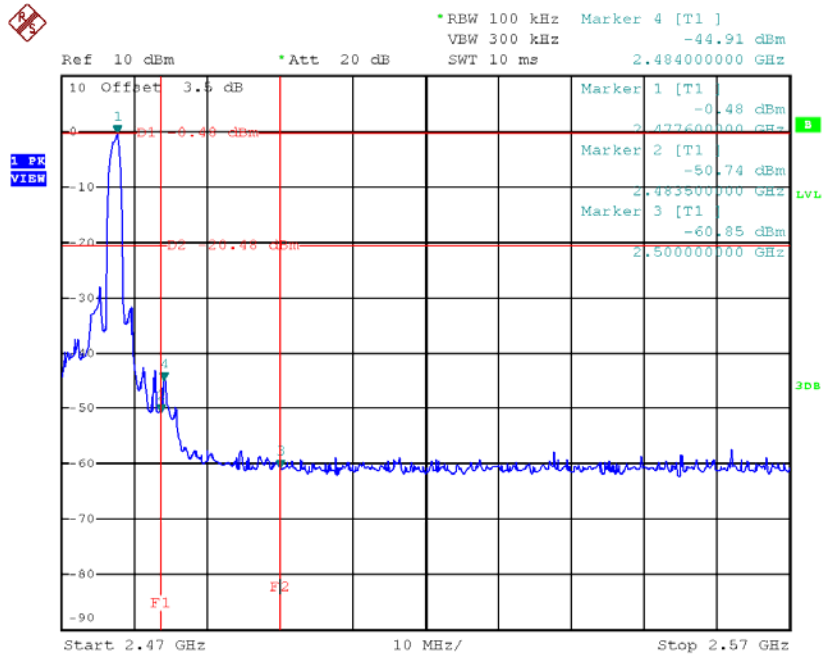

CH01 (10 Harmonic of the frequency)

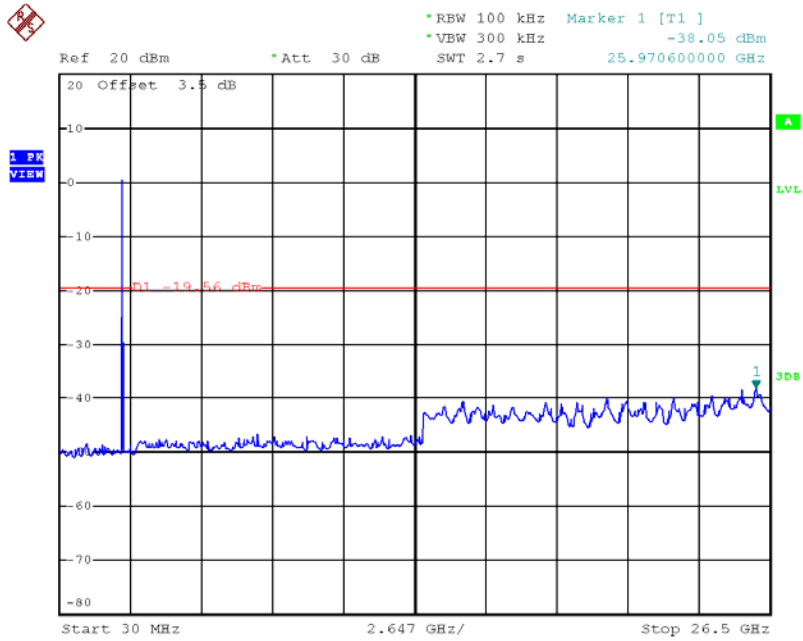

CH19 (10 Harmonic of the frequency)

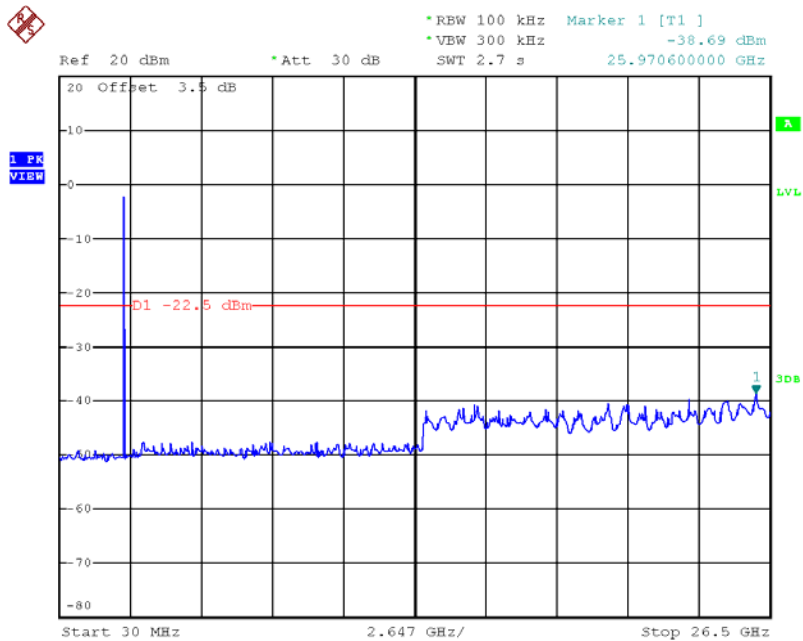

CH37 (10 Harmonic of the frequency)

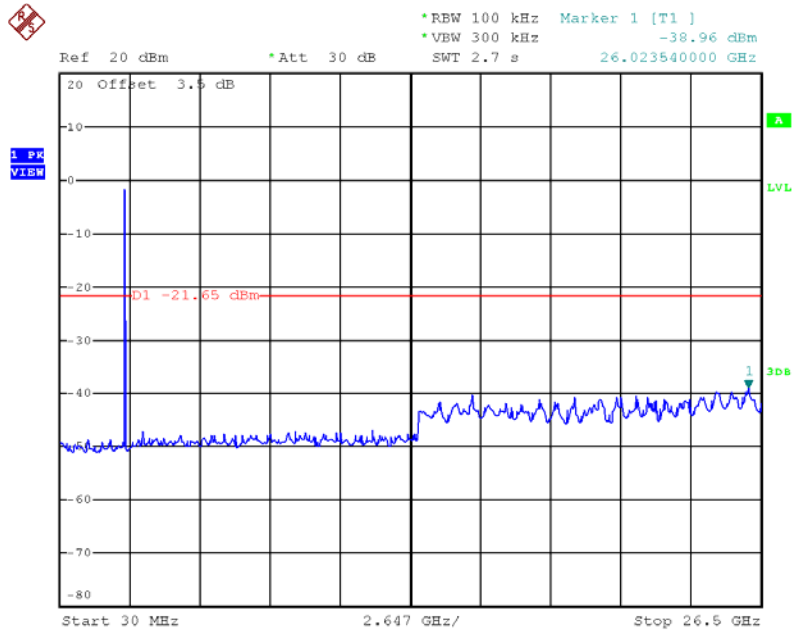

ATTACHMENT H - POWER SPECTRAL DENSITY TEST

Test Mode: TX Mode

Frequency (MHz)	Power Density (dBm/3kHz)	Power Density (mW/3kHz)	Max. Limit (dBm/3kHz)	Result
2405.35	-11.97	0.064	8.00	Complies
2441.35	-13.00	0.050	8.00	Complies
2477.35	-14.19	0.038	8.00	Complies

TX CH01

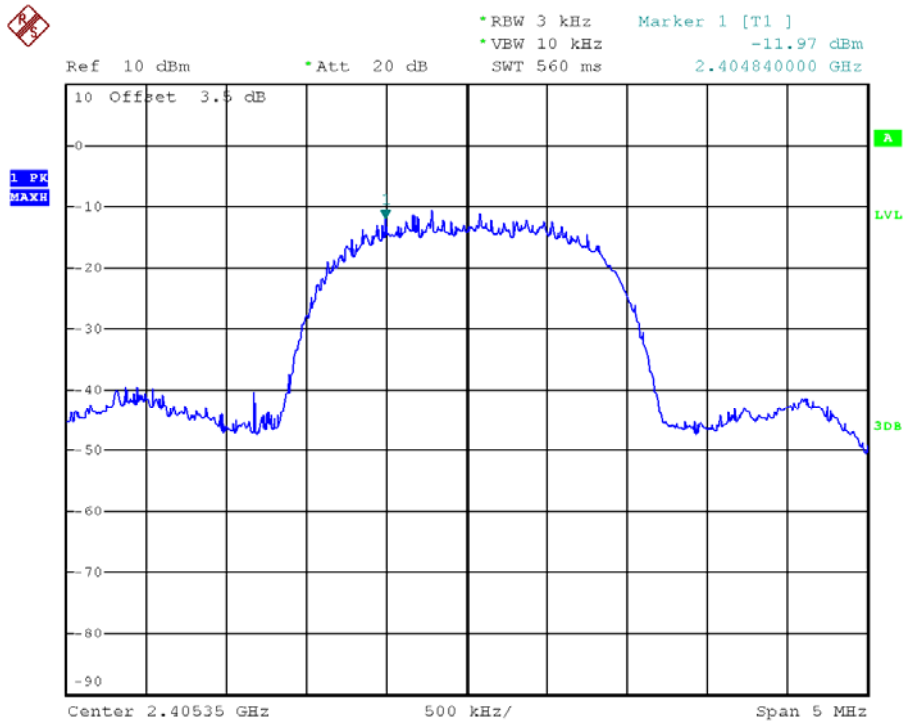

TX CH19

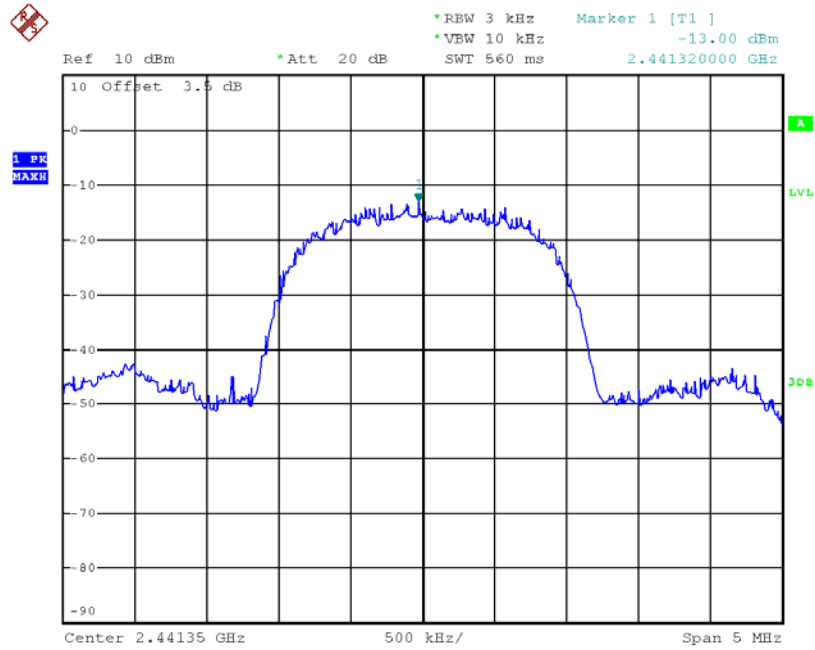

TX CH37

