

# FCC Radio Test Report

## FCC ID: RWO-014901

This report concerns (check one): Original Grant Class II Change

**Project No.** : 1511C119  
**Equipment** : Wireless USB transceiver  
**Model Name** : RC30-014901  
**Applicant** : Razer Inc.  
**Address** : 201 3rd Street, Suite 900, San Francisco,CA 94103

**Date of Receipt** : Nov. 05, 2015  
**Date of Test** : Nov. 05, 2015 ~ Nov. 13, 2015  
**Issued Date** : Nov. 16, 2015  
**Tested by** : BTL Inc.

**Testing Engineer** : Shawn Xiao  
(Shawn Xiao)

**Technical Manager** : David Mao  
(David Mao)

**Authorized Signatory** : Steven Lu  
(Steven Lu)

# **B T L I N C .**

No.3,Jinshagang 1st Road, Shixia,Dalang Town, Dongguan,  
Guangdong, China.

TEL: +86-769-8318-3000 FAX: +86-769-8319-6000

### **Declaration**

**BTL** represents to the client that testing is done in accordance with standard procedures as applicable and that test instruments used has been calibrated with the standards traceable to National Measurement Laboratory (**NML**) of **R.O.C.**, or National Institute of Standards and Technology (**NIST**) of **U.S.A.**

**BTL's** reports apply only to the specific samples tested under conditions. It is manufacture's responsibility to ensure that additional production units of this model are manufactured with the identical electrical and mechanical components. **BTL** shall have no liability for any declarations, inferences or generalizations drawn by the client or others from **BTL** issued reports.

**BTL's** report must not be used by the client to claim product certification, approval, or endorsement by NVLAP, NIST, or any agency of the Federal Government.

This report is the confidential property of the client. As a mutual protection to the clients, the public and **BTL-self**, extracts from the test report shall not be reproduced except in full with **BTL's** authorized written approval.

**BTL's** laboratory quality assurance procedures are in compliance with the **ISO Guide17025** requirements, and accredited by the conformity assessment authorities listed in this test report.

### **Limitation**

For the use of the authority's logo is limited unless the Test Standard(s)/Scope(s)/Item(s) mentioned in this test report is (are) included in the conformity assessment authorities acceptance respective.

<b>Table of Contents</b>	<b>Page</b>
1 . CERTIFICATION	6
2 . SUMMARY OF TEST RESULTS	7
2.1 TEST FACILITY	8
2.2 MEASUREMENT UNCERTAINTY	8
3 .GENERAL INFORMATION	9
3.1 GENERAL DESCRIPTION OF EUT	9
3.2 DESCRIPTION OF TEST MODES	11
3.3 BLOCK DIAGRAM SHOWING THE CONFIGURATION OF SYSTEM TESTED	12
3.4 DESCRIPTION OF SUPPORT UNITS	12
4 . EMC EMISSION TEST	13
4.1 CONDUCTED EMISSION MEASUREMENT	13
4.1.1 POWER LINE CONDUCTED EMISSION	13
4.1.2 TEST PROCEDURE	13
4.1.3 DEVIATION FROM TEST STANDARD	13
4.1.4 TEST SETUP	14
4.1.5 EUT OPERATING CONDITIONS	14
4.1.6 EUT TEST CONDITIONS	14
4.1.7 TEST RESULTS	14
4.2 RADIATED EMISSION MEASUREMENT	15
4.2.1 RADIATED EMISSION LIMITS	15
4.2.2 TESTPROCEDURE	16
4.2.3 DEVIATION FROM TEST STANDARD	16
4.2.4 TESTSETUP	17
4.2.5 EUT OPERATING CONDITIONS	18
4.2.6 EUT TEST CONDITIONS	18
4.2.7 TEST RESULTS (9KHZ 30MHZ)	18
4.2.8 TEST RESULTS (30MHZ to 1000 MHZ)	18
4.2.9 TEST RESULTS (ABOVE1000 MHZ)	19
5 . BANDWIDTH TEST	20
5.1 TEST PROCEDURE	20
5.2 DEVIATION FROM STANDARD	20
5.3 TEST SETUP	20
5.4 EUT OPERATION CONDITIONS	20
5.5 EUT TEST CONDITIONS	20
5.6 TEST RESULTS	20
6 . MEASUREMENT INSTRUMENTS LIST AND SETTING	21
ATTACHMENT A - CONDUCTED EMISSION	22

**Table of Contents****Page**

ATTACHMENT B -RADIATED EMISSION (9KHZ to 30MHZ)	25
ATTACHMENT C -RADIATED EMISSION (30MHZ TO 1000MHZ)	27
ATTACHMENT D -RADIATED EMISSION (ABOVE 1000MHZ)	34
ATTACHMENT E - BANDWIDTH	47

**REPORT ISSUED HISTORY**

Issued No.	Description	Issued Date
BTL-FCCP-1-1511C119	Original Issue.	Nov. 16, 2015

## 1. CERTIFICATION

Equipment : Wireless USB transceiver  
Brand Name : RAZER  
Model Name : RC30-014901  
Applicant : Razer Inc.  
Manufacturer : Razer (Asia-Pacific) Pte.,Ltd.  
Address : 514 Chai Chee Lane #07-01 ~ 06 Singapore 469029, Tel: +65 6505 2188  
Factory : RAZER TECHNOLOGY AND DEVELOPMENT (SHENZHEN) CO., LTD  
Address : East Wing, 3rd Floor, Block 2, Phase 1 of Vision Shenzhen Business Park  
Keji South Road, Hi-Tech Industrial Park, Shenzhen 518057, China  
Date of Test : Nov. 04, 2015 ~ Nov. 13, 2015  
Test Sample : Engineering Sample  
Standard(s) : FCC Part15, Subpart C :2014 (15.249)/ ANSI C63.10-2013

The above equipment has been tested and found compliance with the requirement of the relative standards by BTL Inc.

The test data, data evaluation, and equipment configuration contained in our test report (Ref No. BTL-FCCP-1-1511C119) were obtained utilizing the test procedures, test instruments, test sites that has been accredited by the Authority of TAF according to the ISO-17025 quality assessment standard and technical standard(s).

## 2. SUMMARY OF TEST RESULTS

Test procedures according to the technical standard(s):

FCC Part15, Subpart C (15.249)			
Standard Section	Test Item	Judgment	Remark
FCC			
15.207(a)	Conducted Emission	PASS	
15.205	Restricted Band of Operation	PASS	
15.209 15.249(a)	Radiated Emissions	PASS	
15.215(c)	20dB Bandwidth Test	PASS	

**NOTE:**

(1) "N/A" denotes test is not applicable to this device.

## 2.1 TEST FACILITY

The test facilities used to collect the test data in this report is at the location of No.3, Jinshagang 1st Road, Shixia, Dalang Town, Dongguan, Guangdong, China.  
BTL's test firm number for FCC: 319330

## 2.2 MEASUREMENT UNCERTAINTY

Where relevant, the following measurement uncertainty levels have been estimated for tests performed on the EUT as specified in CISPR 16-4-2. The BTL measurement uncertainty is less than the CISPR 16-4-2  $U_{\text{CISPR}}$  requirement.

The reported uncertainty of measurement  $y \pm U$ , where expanded uncertainty  $U$  is based on a standard uncertainty multiplied by a coverage factor of  $k=2$ , providing a level of confidence of approximately 95%.

### A. Conducted Measurement:

Test Site	Method	Measurement Frequency Range	U,(dB)
DG-C02	CISPR	150 kHz ~ 30MHz	2.32

### B. Radiated Measurement:

Test Site	Method	Measurement Frequency Range	Ant. H / V	U,(dB)
DG-CB03 (3m)	CISPR	9KHz ~ 30MHz	V	3.79
		9KHz ~ 30MHz	H	3.57
		30MHz ~ 200MHz	V	3.82
		30MHz ~ 200MHz	H	3.78
		200MHz ~ 1,000MHz	V	4.10
		200MHz ~ 1,000MHz	H	4.06

Test Site	Method	Measurement Frequency Range	Ant. H / V	U,(dB)
DG-CB03 (3m)	CISPR	1GHz ~ 18GHz	V	3.12
		1GHz ~ 18GHz	H	3.68
		18GHz ~ 40GHz	V	4.15
		18GHz ~ 40GHz	H	4.14

Note: Unless specifically mentioned, the uncertainty of measurement has not been taken into account to declare the compliance or non-compliance to the specification.



### 3. GENERAL INFORMATION

#### 3.1 GENERAL DESCRIPTION OF EUT

Equipment	Wireless USB transceiver	
Brand Name	RAZER	
Model Name	RC30-014901	
Model Difference	The system's model name is RZ04-0149, and the system contains of Wireless Gaming Headset (model name RC30-01490 2) and Wireless USB transceiver (model name RC30-014901).	
Product Description	Operation Frequency	2400~2480MHz
	Modulation Technology	$\pi/4$ DPQSK
	Data rate	2Mbps
	Field Strength	96.46dBuV/m(Peak Max) 92.19dBuV/m(AVG Max)
Power Source	Supplied from PC USB Port	
Power Rating	DC 5V	

Note:

1. For a more detailed features description, please refer to the manufacturer's specifications or the user's manual.

2. Channel List:

Channel	Frequency (MHz)	Channel	Frequency (MHz)
<b>01</b>	<b>2403.35</b>	<b>20</b>	<b>2441.35</b>
02	2405.35	21	2443.35
03	2407.35	22	2445.35
04	2409.35	23	2447.35
05	2411.35	24	2449.35
06	2413.35	25	2451.35
07	2415.35	26	2453.35
08	2417.35	27	2455.35
09	2419.35	28	2457.35
10	2421.35	29	2459.35
11	2423.35	30	2461.35
12	2425.35	31	2463.35
13	2427.35	32	2465.35
14	2429.35	33	2467.35
15	2431.35	34	2469.35
16	2433.35	35	2471.35
17	2435.35	36	2473.35
18	2437.35	37	2475.35
19	2439.35	<b>38</b>	<b>2477.35</b>

3 Table for Filed Antenna:

Ant.	Manufacturer	Model Name	Antenna Type	Connector	Gain(dBi)
1	N/A	N/A	Printed	N/A	0.54

### 3.2 DESCRIPTION OF TEST MODES

To investigate the maximum EMI emission characteristics generated from EUT, the test system was pre-scanning tested based on the consideration of following EUT operation mode or test configuration mode which possible have effect on EMI emission level. Each of these EUT operation mode(s) or test configuration mode(s) mentioned above was evaluated respectively.

Pretest Mode	Description
Mode 1	TX Mode

For Conducted Test	
Final Test Mode	Description
Mode 1	TX Mode

For Radiated Test	
Final Test Mode	Description
Mode 1	TX Mode

Note:

(1) The measurements are performed at the high, middle, low available channels.

### 3.3 BLOCK DIAGRAM SHOWING THE CONFIGURATION OF SYSTEM TESTED

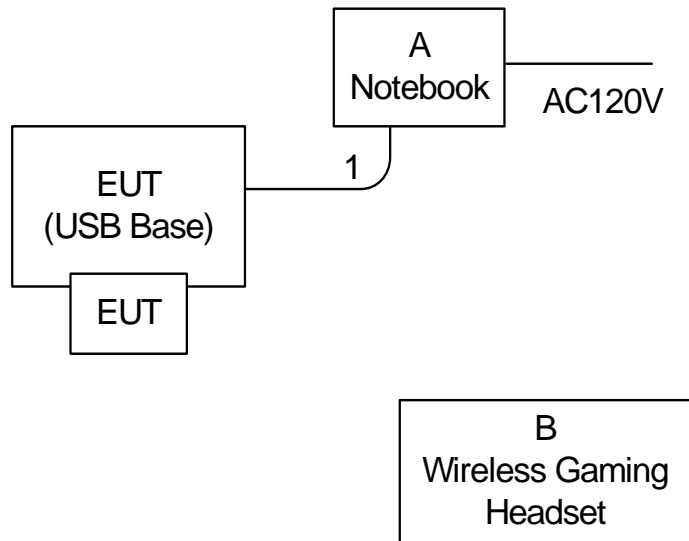

### 3.4 DESCRIPTION OF SUPPORT UNITS

The EUT has been tested as an independent unit together with other necessary accessories or support units. The following support units or accessories were used to form a representative test configuration during the tests.

Item	Equipment	Mfr/Brand	Model/Type No.	FCC ID	Series No.
A	Notebook	DELL	INSPIRON 1420	DOC	N/A
B	Wireless Gaming Headset	RAZER	RC30-014902	RWO- 014902	N/A

Item	Shielded Type	Ferrite Core	Length	Note
1	YES	NO	2.2m	USB Cable

## 4. EMC EMISSION TEST

### 4.1 CONDUCTED EMISSION MEASUREMENT

#### 4.1.1 POWER LINE CONDUCTED EMISSION (FREQUENCY RANGE 150KHZ-30MHZ)

Frequency of Emission (MHz)	Conducted Limit (dB $\mu$ V)	
	Quasi-peak	Average
0.15 -0.5	66 to 56*	56 to 46*
0.50 -5.0	56	46
.0 -30.0	60	50

Note:

- (1) The limit of " \* " decreases with the logarithm of the frequency
- (2) The test result calculated as following:  
 Measurement Value = Reading Level + Correct Factor  
 Correct Factor = Insertion Loss + Cable Loss + Attenuator Factor(if use)  
 Margin Level = Measurement Value - Limit Value

The following table is the setting of the receiver

Receiver Parameters	Setting
Attenuation	10 dB
Start Frequency	0.15 MHz
Stop Frequency	30 MHz
IF Bandwidth	9 kHz

#### 4.1.2 TEST PROCEDURE

- a. The EUT was placed 0.8 meters from the horizontal ground plane with EUT being connected to the power mains through a line impedance stabilization network (LISN). All other support equipments powered from additional LISN(s). The LISN provide 50 Ohm/ 50uH of coupling impedance for the measuring instrument.
- b. Interconnecting cables that hang closer than 40 cm to the groundplane shall be folded back and forth in the center forming a bundle 30 to 40 cm long.
- c. I/O cables that are not connected to a peripheral shall be bundled in the center. The end of the cable may be terminated, if required, using the correct terminating impedance. The overall length shall not exceed 1 m.
- d. LISN at least 80 cm from nearest part of EUT chassis.
- e. For the actual test configuration, please refer to the related Item –EUT Test Photos.

#### 4.1.3 DEVIATION FROM TEST STANDARD

No deviation

#### 4.1.4 TEST SETUP

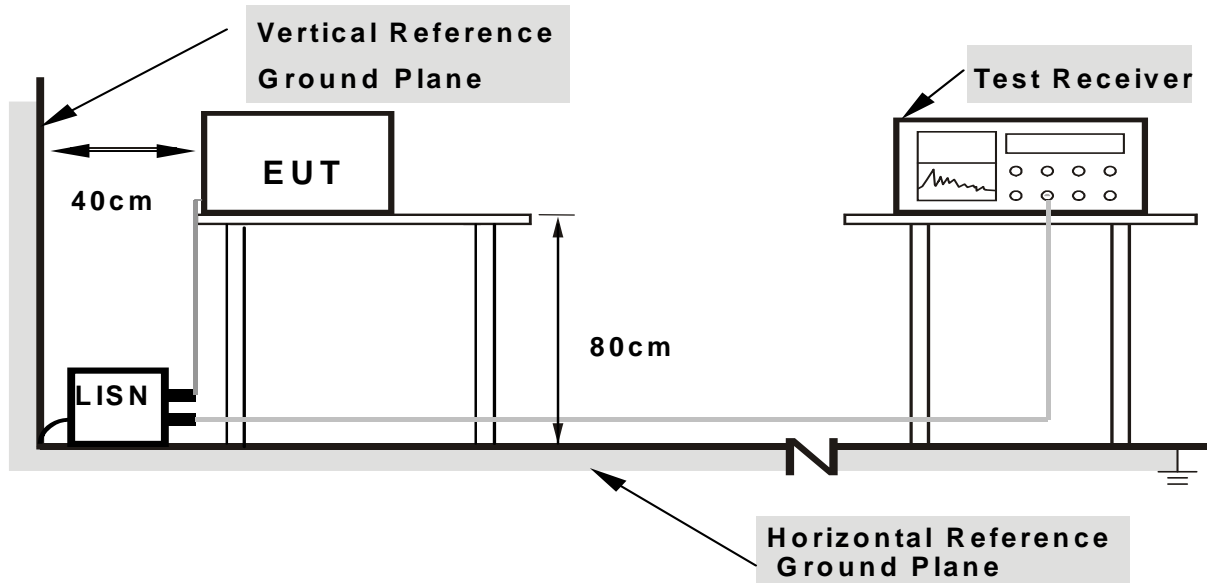

- Note:**
1. Support units were connected to second LISN.
  2. Both of LISNs (AMN) are 80 cm from EUT and at least 80 from other units and other metal planes

#### 4.1.5 EUT OPERATING CONDITIONS

The EUT was configured for testing in a typical fashion (as a customer would normally use it).

#### 4.1.6 EUT TEST CONDITIONS

Temperature: 26°C

Relative Humidity: 58%

Test Voltage: AC 120V/60Hz

#### 4.1.7 TEST RESULTS

Please refer to the Attachment A.

Remark:

- (1) All readings are QP Mode value unless otherwise stated AVG in column of 'Note'. If the QP Mode Measured value compliance with the QP Limits and lower than AVG Limits, the EUT shall be deemed to meet both QP & AVG Limits and then only QP Mode was measured, but AVG Mode didn't perform in this case, a "\*" marked in AVG Mode column of Interference Voltage Measured.
- (2) Measuring frequency range from 150KHz to 30MHz.

## 4.2 RADIATED EMISSION MEASUREMENT

### 4.2.1 RADIATED EMISSION LIMITS (FCC 15.209)

Frequencies (MHz)	Field Strength (micorvolts/meter)	Measurement Distance (meters)
0.009~0.490	2400/F(KHz)	300
0.490~1.705	24000/F(KHz)	30
1.705~30.0	30	30
30~88	100	3
88~216	150	3
216~960	200	3
960~1000	500	3

Harmonic emissions limits comply with below 54 dBuV/m at 3m. Other emissions radiated outside of the specified frequency bands, except for harmonics, shall be attenuated by at least 50 dB below the level of the fundamental or comply with the radiated emissions limits specified in section 15.209(a) limit in the table below has to be followed.

Note:

- (1) The tighter limit applies at the band edges.
- (2) Emission level (dBuV/m)=20log Emission level (uV/m).

### LIMITS OF RADIATED EMISSION MEASUREMENT (FCC 15.209)

FREQUENCY (MHz)	(dBuV/m) (at 3m)	
	PEAK	AVERAGE
Above 1000	74	54

Notes:

- (1) The limit for radiated test was performed according to FCC PART 15C.
- (2) The tighter limit applies at the band edges.
- (3) Emission level (dBuV/m)=20log Emission level (uV/m).

### LIMITS OF RADIATED EMISSION MEASUREMENT (FCC Part 15.249)

FCC Part 15 (15.249), Subpart C	
Limit	Frequency Range(MHz)
Field strength of fundamental 50000 $\mu$ V/m (94 dB $\mu$ V/m) @ 3 m	2400-2483.5
Field strength of harmonics 500 $\mu$ V/m (54 dB $\mu$ V/m) @ 3 m	Above 2483.5

Spectrum Parameter	Setting
Attenuation	Auto
Start Frequency	1000 MHz
Stop Frequency	10th carrier harmonic

Receiver Parameter	Setting
Attenuation	Auto
Start ~ Stop Frequency	9kHz~90kHz for PK/AVG detector
Start ~ Stop Frequency	90kHz~110kHz for QP detector
Start ~ Stop Frequency	110kHz~490kHz for PK/AVG detector
Start ~ Stop Frequency	490kHz~30MHz for QP detector
Start ~ Stop Frequency	30MHz~1000MHz for QP detector

#### 4.2.2 TESTPROCEDURE

- a. The measuring distance of 3 m shall be used for measurements. The EUT was placed on the top of a rotating table 0.8 meter above the ground at a 3 meter semi-anechoic chamber. The table was rotated 360 degrees to determine the position of the highest radiation.(below 1GHz)
- b. The measuring distance of 3 m shall be used for measurements. The EUT was placed on the top of a rotating table 1.5 meter above the ground at a 3 meter semi-anechoic chamber. The table was rotated 360 degrees to determine the position of the highest radiation.(above 1GHz)
- c. The height of the equipment or of the substitution antenna shall be 0.8 m or 1.5m, the height of the test antenna shall vary between 1 m to 4 m. Both horizontal and vertical polarizations of the antenna are set to make the measurement.
- d. The initial step in collecting radiated emission data is a receiver peak detector mode pre-scanning the measurement frequency range. Significant peaks are then marked and then Quasi Peak detector mode re-measured.
- e. All readings are Peak unless otherwise stated QP in column of Note. Peak denotes that the Peak reading compliance with the QP Limits and then QP Mode measurement didn't perform. (below 1GHz)
- f. All readings are Peak Mode value unless otherwise stated AVG in column of Note. If the Peak Mode Measured value compliance with the Peak Limits and lower than AVG Limits, the EUT shall be deemed to meet both Peak & AVG Limits and then only Peak Mode was measured, but AVG Mode didn't perform. (above 1GHz)
- g. For the actual test configuration, please refer to the related Item –EUT Test Photos.

#### 4.2.3 DEVIATION FROM TEST STANDARD

No deviation



#### 4.2.4 TESTSETUP

(A) Radiated Emission Test Set-Up Frequency Below 1 GHz

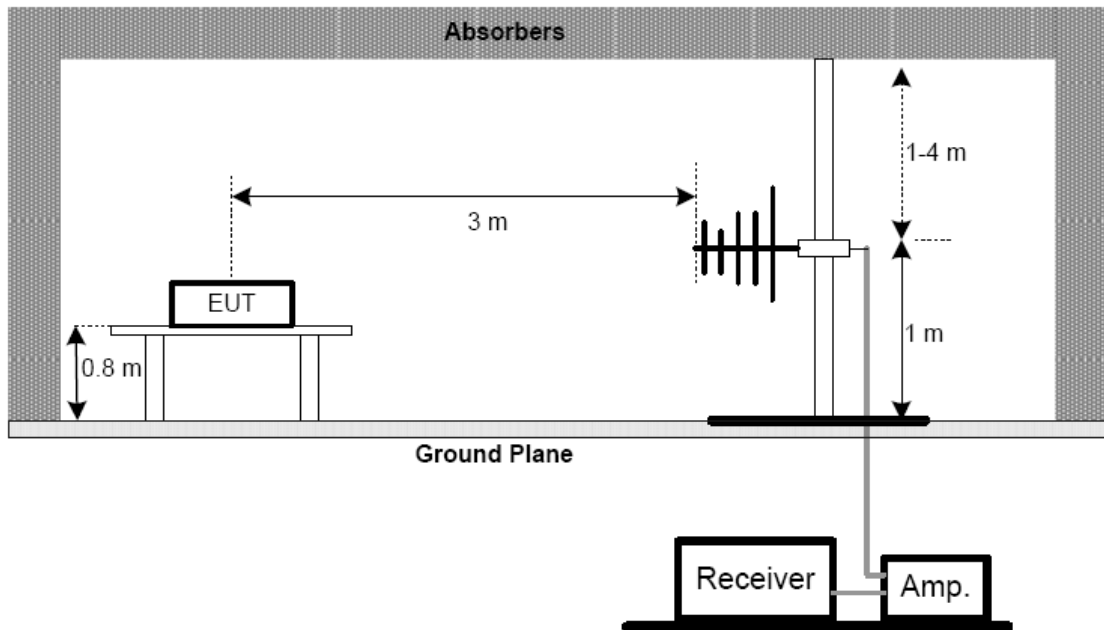

(B) Radiated Emission Test Set-Up Frequency Above 1 GHz

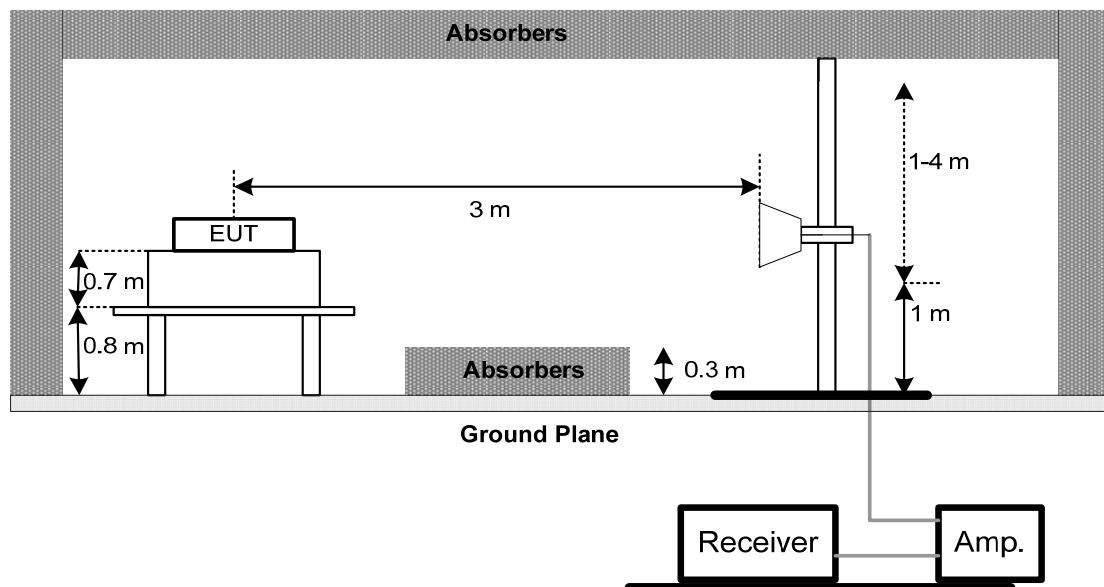

(C) For radiated emissions below 30MHz

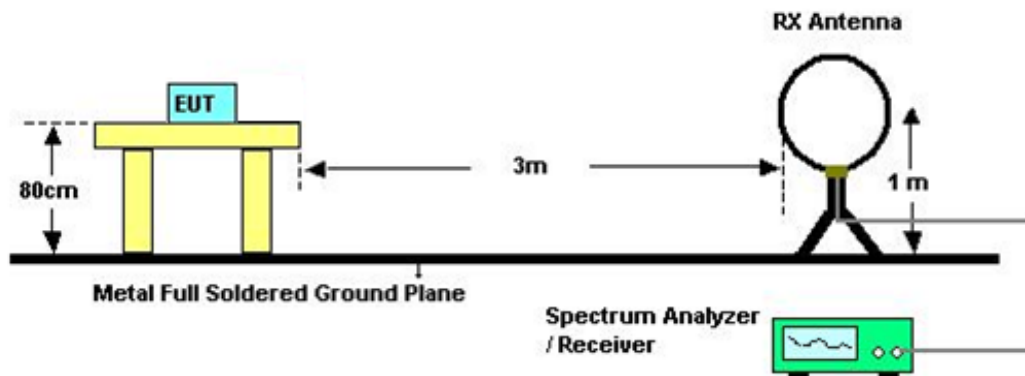

#### 4.2.5 EUT OPERATING CONDITIONS

The EUT was programmed to be in continuously transmitting mode.

#### 4.2.6 EUT TEST CONDITIONS

Temperature: 26°C

Relative Humidity: 58%

Test Voltage: AC 120V/60Hz

#### 4.2.7 TEST RESULTS (9KHZ 30MHZ)

Please refer to the Attachment B.

Remark:

- (1) The amplitude of spurious emissions which are attenuated by more than 20 dB below the permissible value has no need to be reported.
- (2) Distance extrapolation factor =  $40 \log(\text{specific distance} / \text{test distance})$  (dB);.
- (3) Limit line = specific limits (dBuV) + distance extrapolation factor..

#### 4.2.8 TEST RESULTS (30MHZ to 1000 MHZ)

Please refer to the Attachment C

Remark:

- (1) All readings are Peak unless otherwise stated QP in column of 『Note』 . Peak denotes that the Peak reading compliance with the QP Limits and then QP Mode measurement didn't perform.
- (2) Measuring frequency range from 30MHz to 1000MHz or the 10th harmonic of highest fundamental frequency. "F" denotes fundamental frequency; "H" denotes spurious frequency. "E" denotes band edge frequency.
- (3) Radiated emissions measured in frequency range from 30 MHz to 1000 MHz were made with an instrument using Peak detector mode or QP detector mode of the emission .

#### 4.2.9 TEST RESULTS (ABOVE1000 MHZ)

Please refer to the Attachment D

Remark:

- (1) All readings are Peak unless otherwise stated QP in column of 『Note』 . Peak denotes that the Peak reading compliance with the QP Limits and then QP Mode measurement didn't perform.
- (2) Radiated emissions measured in frequency range above 1000MHz were made with an instrument using Peak detector mode and AV detector mode of the emission .
- (3) Data of measurement within this frequency range shown “ \* ” in the table above means the reading of emissions are attenuated more than 20dB below the permissible limits or the field strength is too small to be measured.
- (4) A preamp and high pass filter were used for this test in order to provide sufficient measurement sensitivity.
- (5) EUT Orthogonal Axis:  
“X” - denotes Laid on Table; “Y” - denotes Vertical Stand; “Z” - denotes Side Stand
- (6) During the measurements above 1 GHz it is taken care of that the EUT is always within the 3 dB cone of radiation BW of the used antenna
- (7) No limit: This is fundamental signal, the judgment is not applicable.  
For fundamental signal judgment was referred to Peak output test.

## 5. BANDWIDTH TEST

### 5.1 TEST PROCEDURE

- a. The EUT was directly connected to the spectrum analyzer and antenna output port as show in the block diagram below,
- b. Spectrum Setting: RBW= 100KHz, VBW=100KHz, Sweep time = Auto.

### 5.2 DEVIATION FROM STANDARD

No deviation.

### 5.3 TEST SETUP



### 5.4 EUT OPERATION CONDITIONS

The EUT was programmed to be in continuously transmitting mode.

### 5.5 EUT TEST CONDITIONS

Temperature: 26°C  
Relative Humidity: 58%  
Test Voltage: AC 120V/60Hz

### 5.6 TEST RESULTS

Please refer to the Attachment E

## 6. MEASUREMENT INSTRUMENTS LIST AND SETTING

Conducted Emission Measurement					
Item	Kind of Equipment	Manufacturer	Type No.	Serial No.	Calibrated until
1	LISN	EMCO	699837	0052765	Mar. 28, 2016
2	LISN	R&S	ENV216	101447	Mar. 28, 2016
3	Test Cable	emci	RG223(9KHz-30 MHz)	C_17	Mar. 13, 2016
4	EMI Test Receiver	R&S	ESCS30	826547/022	Mar. 28, 2016
5	50Ω Terminator	SHX	TF2-3G-A	08122901	Mar. 28, 2016
6	Measurement Software	Farad	EZ-EMC Ver.NB-03A1-01	N/A	N/A

Radiated Emission Measurement					
Item	Kind of Equipment	Manufacturer	Type No.	Serial No.	Calibrated until
1	Antenna	Schwarzbeck	VULB9160	9160-3232	Mar. 28, 2016
2	Amplifier	HP	8447D	2944A09673	Nov. 17, 2015
3	Receiver	AGILENT	N9038A	MY52130039	Oct. 11, 2016
4	Test Cable	emci	LMR-400(30MHz-1GHz)	C-01	Jun. 28, 2016
5	Controller	CT	SC100	N/A	N/A
6	Measurement Software	Farad	EZ-EMC Ver.NB-03A1-01	N/A	N/A
7	Antenna	ETS	3115	00075789	Mar. 28, 2016
8	Amplifier	Agilent	8449B	3008A02274	Nov. 01, 2016
9	Receiver	AGILENT	N9038A	MY52130039	Oct. 11, 2016
10	Test Cable	emci	EMC104-SM-SM-10000(1GHz-26.5 GHz)	C-68	Jun. 28, 2016
11	Controller	CT	SC100	N/A	N/A
12	Broad-Band Horn Antenna	Schwarzbeck	BBHA 9170	9170319	Mar. 28, 2016
13	Active Loop Antenna	R&S	HFH2-Z2	830749/020	Sep. 07, 2016

Bandwidth					
Item	Kind of Equipment	Manufacturer	Type No.	Serial No.	Calibrated until
1	Spectrum Analyzer	R&S	FSP 40	100185	Oct. 11, 2016

Remark: "N/A" denotes no model name, serial no. or calibration specified.  
All calibration period of equipment list is one year.

## ATTACHMENT A - CONDUCTED EMISSION

Test Mode: TX Mode

### Line

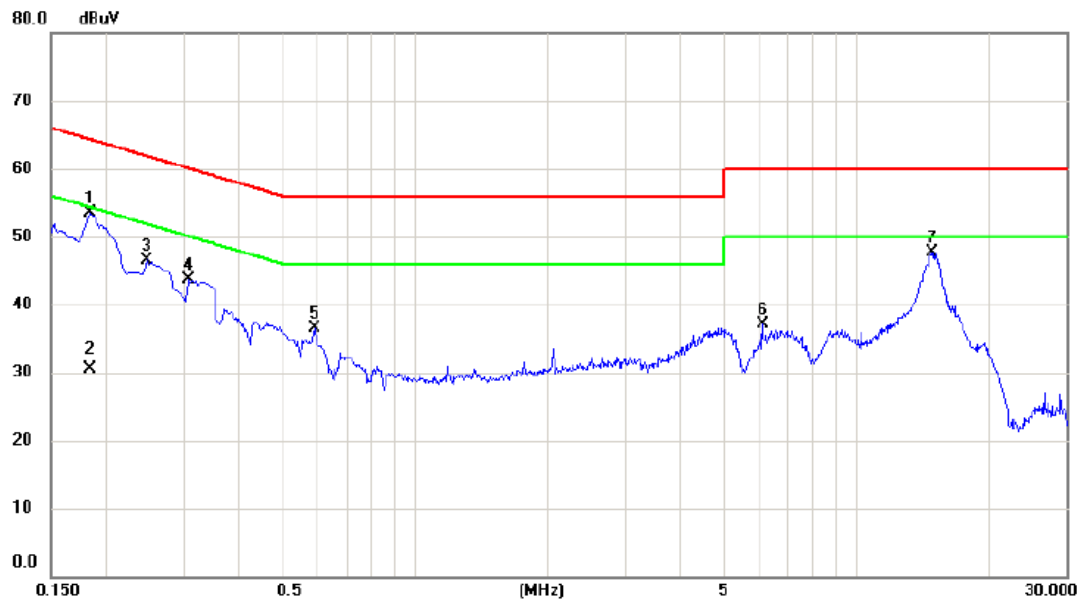

No.	Mk.	Freq. MHz	Reading Level dBuV	Correct Factor dB	Measure- ment dBuV	Limit dBuV	Margin dB	Detector	Comment
1	*	0.1838	43.74	9.70	53.44	64.31	-10.87	peak	
2		0.1838	20.80	9.70	30.50	54.31	-23.81	AVG	
3		0.2468	36.87	9.73	46.60	61.86	-15.26	peak	
4		0.3075	33.89	9.76	43.65	60.04	-16.39	peak	
5		0.5910	26.65	9.86	36.51	56.00	-19.49	peak	
6		6.1440	27.63	9.53	37.16	60.00	-22.84	peak	
7		14.8020	37.43	10.27	47.70	60.00	-12.30	peak	

Test Mode: TX Mode

### Neutral

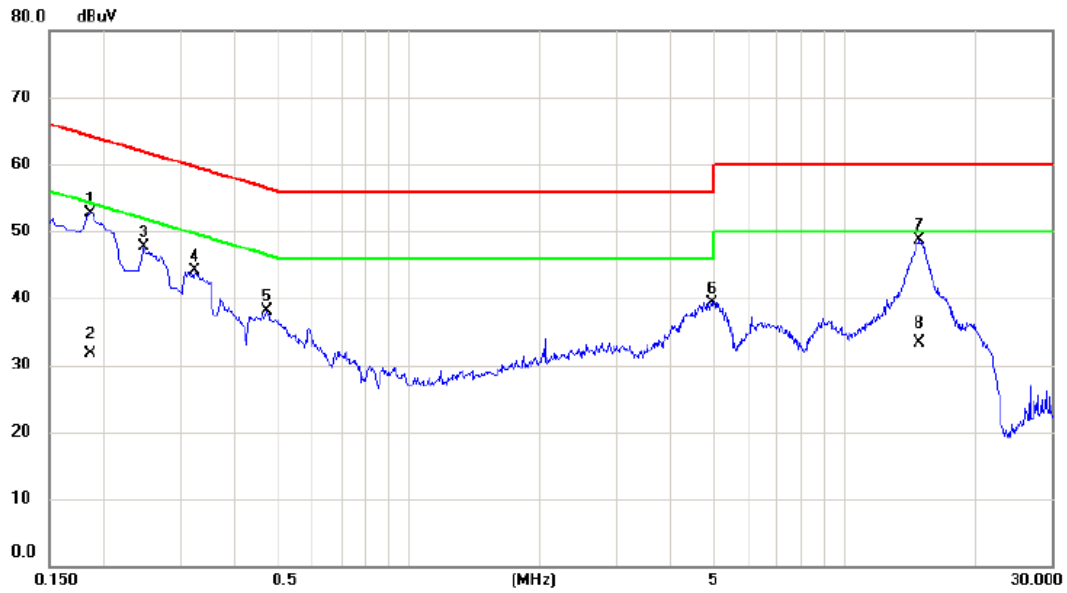

No.	Mk.	Freq. MHz	Reading Level dBuV	Correct Factor dB	Measure- ment dBuV	Limit dBuV	Margin dB	Detector	Comment
1		0.1860	43.01	9.61	52.62	64.21	-11.59	peak	
2		0.1860	22.00	9.61	31.61	54.21	-22.60	AVG	
3		0.2468	38.03	9.62	47.65	61.86	-14.21	peak	
4		0.3232	34.41	9.63	44.04	59.62	-15.58	peak	
5		0.4717	28.45	9.64	38.09	56.48	-18.39	peak	
6		4.9808	29.29	10.10	39.39	56.00	-16.61	peak	
7	*	14.8470	38.40	10.27	48.67	60.00	-11.33	peak	
8		14.8470	23.00	10.27	33.27	50.00	-16.73	AVG	



**ATTACHMENT B -RADIATED EMISSION (9KHZ to 30MHZ)**

Test Mode:	TX Mode
------------	---------

Frequency (MHz)	Ant 0°/90°	Read level dBuV/m	Factor (dB)	Measured(FS) (dBuV/m)	Limit (dBuV/m)	Margin (dB)	Note
0.0097	0°	13.28	24.95	38.23	127.87	-89.64	AVG
0.0097	0°	14.37	24.95	39.32	147.87	-108.55	PEAK
0.0286	0°	6.95	23.76	30.71	118.48	-87.77	AVG
0.0286	0°	8.52	23.76	32.28	138.48	-106.20	PEAK
0.0352	0°	3.26	23.34	26.60	116.67	-90.08	AVG
0.0352	0°	5.66	23.34	29.00	136.67	-107.68	PEAK
0.0545	0°	1.73	22.31	24.04	112.88	-88.84	AVG
0.0545	0°	2.84	22.31	25.15	132.88	-107.73	PEAK
0.5063	0°	19.58	19.82	39.40	73.52	-34.12	QP
1.9559	0°	23.95	19.50	43.45	69.54	-26.09	QP

Frequency (MHz)	Ant 0°/90°	Read level dBuV/m	Factor (dB)	Measured(FS) (dBuV/m)	Limit (dBuV/m)	Margin (dB)	Note
0.0126	90°	13.32	24.30	37.62	125.60	-87.98	AVG
0.0126	90°	14.81	24.30	39.11	145.60	-106.49	PEAK
0.0263	90°	7.52	23.90	31.42	119.21	-87.78	AVG
0.0263	90°	9.12	23.90	33.02	139.21	-106.18	PEAK
0.0454	90°	5.42	22.69	28.11	114.46	-86.35	AVG
0.0454	90°	6.21	22.69	28.90	134.46	-105.56	PEAK
0.0587	90°	1.71	22.23	23.94	112.23	-88.30	AVG
0.0587	90°	2.53	22.23	24.76	132.23	-107.48	PEAK
0.5935	90°	22.46	20.10	42.56	72.14	-29.58	QP
2.0521	90°	25.13	19.47	44.60	69.54	-24.94	QP

**ATTACHMENT C -RADIATED EMISSION (30MHZ TO 1000MHZ)**

Test Mode: TX Low Channel

Vertical

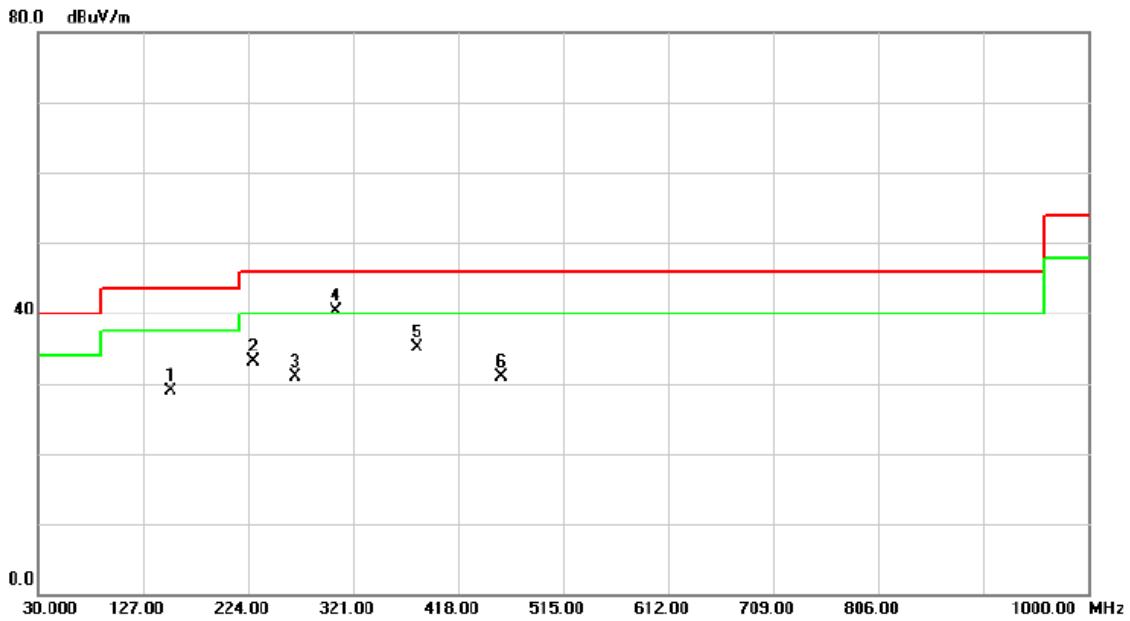

No.	Mk.	Freq. MHz	Reading Level dBuV	Correct Factor dB	Measure- ment dBuV/m	Limit dBuV/m	Margin dB	Detector	Comment
1		152.2200	41.69	-12.88	28.81	43.50	-14.69	peak	
2		228.8500	47.51	-14.34	33.17	46.00	-12.83	peak	
3		266.6800	44.72	-13.83	30.89	46.00	-15.11	peak	
4	*	304.5100	50.85	-10.57	40.28	46.00	-5.72	peak	
5		380.1700	45.13	-10.11	35.02	46.00	-10.98	peak	
6		456.8000	39.18	-8.31	30.87	46.00	-15.13	peak	

Test Mode: TX Low Channel

### Horizontal

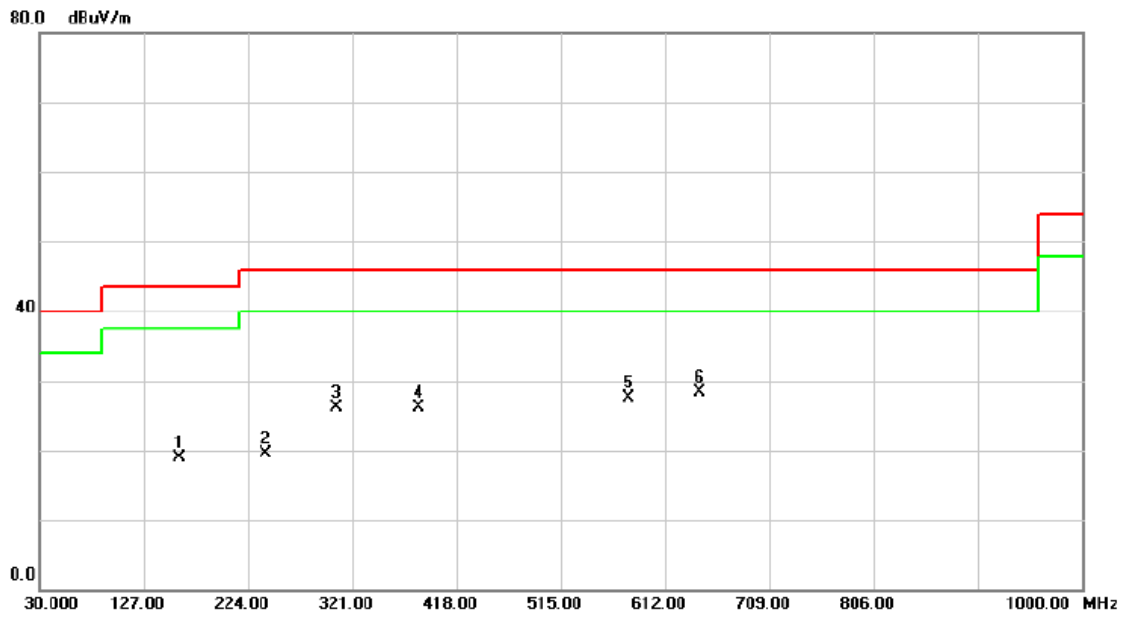

No. Mk.	Freq. MHz	Reading Level dBuV	Correct Factor dB	Measurement dBuV/m	Limit dBuV/m	Margin dB	Detector	Comment
1	159.9800	31.38	-12.42	18.96	43.50	-24.54	peak	
2	240.4900	33.66	-14.15	19.51	46.00	-26.49	peak	
3	305.4800	36.80	-10.60	26.20	46.00	-19.80	peak	
4	382.1100	36.20	-10.04	26.16	46.00	-19.84	peak	
5	577.0800	34.08	-6.62	27.46	46.00	-18.54	peak	
6 *	643.0400	33.84	-5.49	28.35	46.00	-17.65	peak	

Test Mode: TX Middle Channel

Vertical

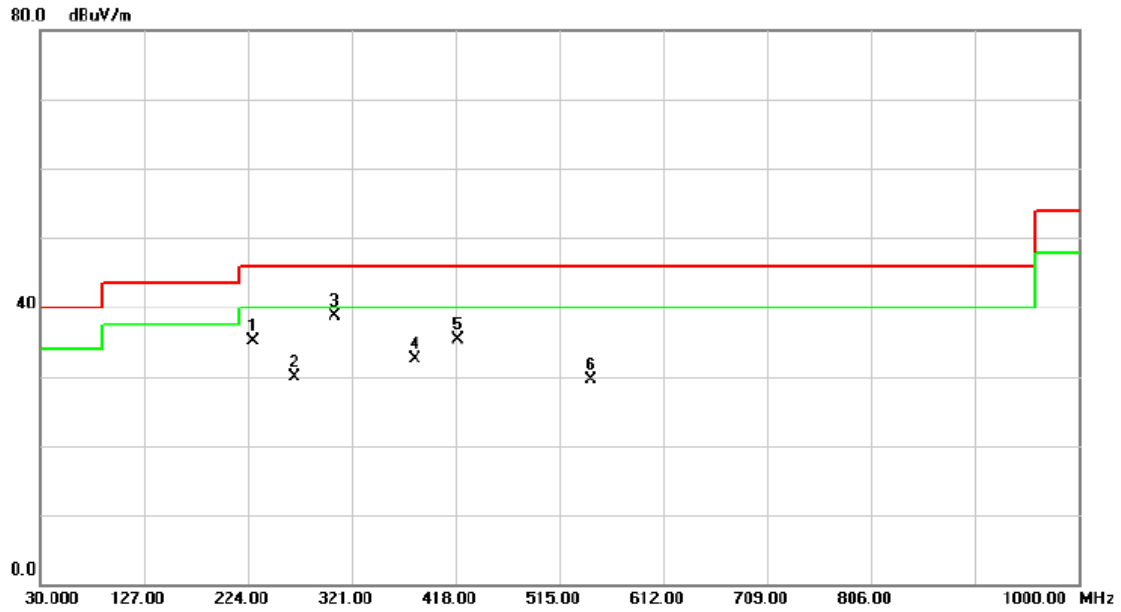

No.	Mk.	Freq. MHz	Reading Level dBuV	Correct Factor dB	Measure- ment dBuV/m	Limit dBuV/m	Margin dB	Detector	Comment
1		228.8500	49.51	-14.34	35.17	46.00	-10.83	peak	
2		266.6800	43.72	-13.83	29.89	46.00	-16.11	peak	
3	*	304.5100	49.35	-10.57	38.78	46.00	-7.22	peak	
4		380.1700	42.63	-10.11	32.52	46.00	-13.48	peak	
5		419.9400	44.16	-8.82	35.34	46.00	-10.66	peak	
6		544.1000	35.25	-5.71	29.54	46.00	-16.46	peak	

Test Mode: TX Middle Channel

### Horizontal

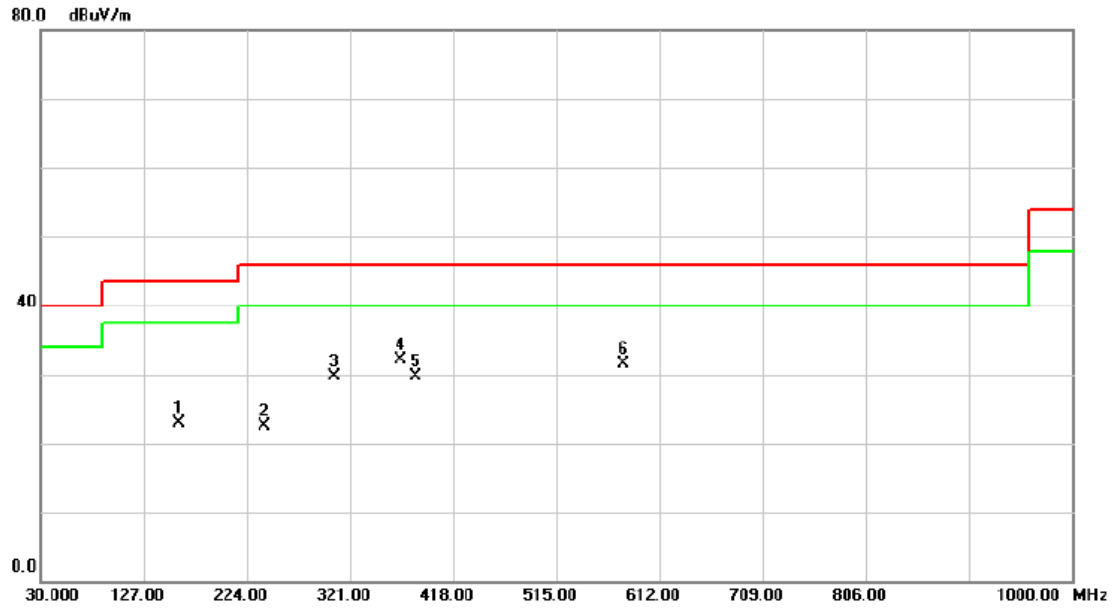

No.	Mk.	Freq. MHz	Reading Level dBuV	Correct Factor dB	Measure- ment dBuV/m	Limit dBuV/m	Margin dB	Detector	Comment
1		159.9800	35.38	-12.42	22.96	43.50	-20.54	peak	
2		240.4900	36.66	-14.15	22.51	46.00	-23.49	peak	
3		305.4800	40.30	-10.60	29.70	46.00	-16.30	peak	
4	*	368.5300	42.67	-10.59	32.08	46.00	-13.92	peak	
5		382.1100	39.70	-10.04	29.66	46.00	-16.34	peak	
6		577.0800	38.08	-6.62	31.46	46.00	-14.54	peak	

Test Mode: TX High Channel

Vertical

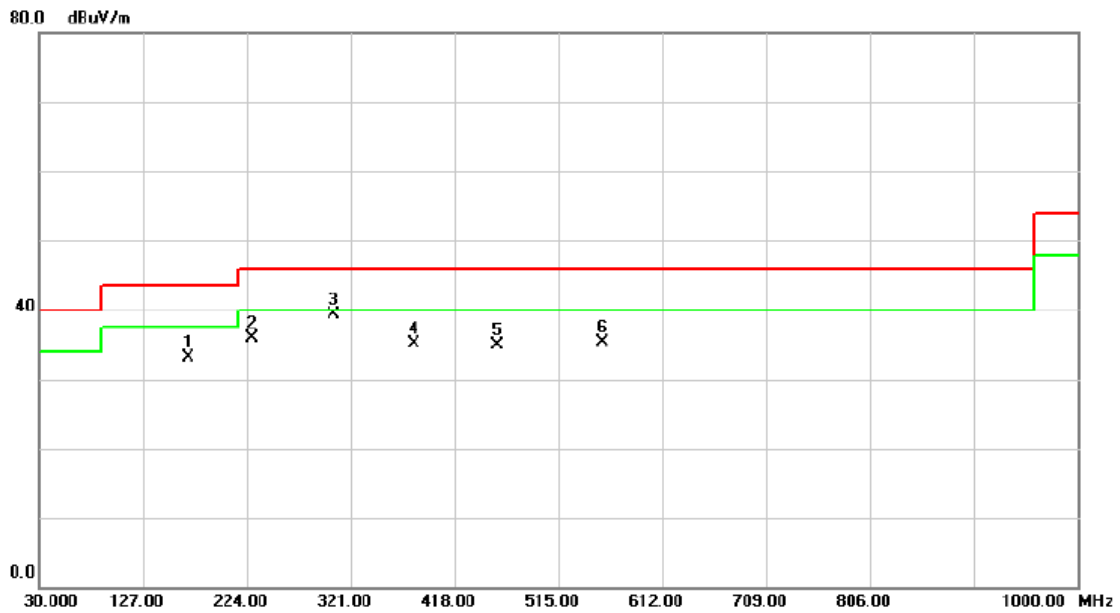

No.	Mk.	Freq. MHz	Reading Level dBuV	Correct Factor dB	Measure- ment dBuV/m	Limit dBuV/m	Margin dB	Detector	Comment
1		168.7100	45.98	-12.82	33.16	43.50	-10.34	peak	
2		227.8800	50.17	-14.34	35.83	46.00	-10.17	peak	
3	*	304.5100	49.85	-10.57	39.28	46.00	-6.72	peak	
4		380.1700	45.13	-10.11	35.02	46.00	-10.98	peak	
5		456.8000	43.18	-8.31	34.87	46.00	-11.13	peak	
6		555.7400	40.77	-5.46	35.31	46.00	-10.69	peak	



Test Mode: TX High Channel

### Horizontal

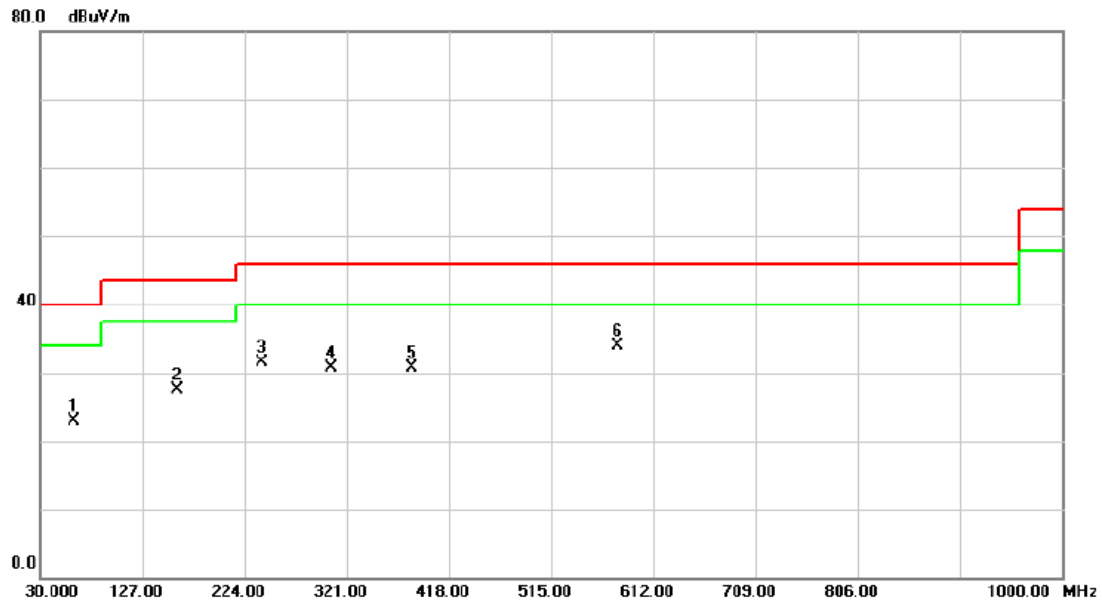

No.	Mk.	Freq. MHz	Reading Level dBuV	Correct Factor dB	Measure- ment dBuV/m	Limit dBuV/m	Margin dB	Detector	Comment
1		61.0400	37.44	-14.63	22.81	40.00	-17.19	peak	
2		159.9800	39.88	-12.42	27.46	43.50	-16.04	peak	
3		240.4900	45.66	-14.15	31.51	46.00	-14.49	peak	
4		305.4800	41.30	-10.60	30.70	46.00	-15.30	peak	
5		382.1100	40.70	-10.04	30.66	46.00	-15.34	peak	
6	*	577.0800	40.58	-6.62	33.96	46.00	-12.04	peak	

## **ATTACHMENT D -RADIATED EMISSION (ABOVE 1000MHZ)**

Test Mode : TX Low Channel

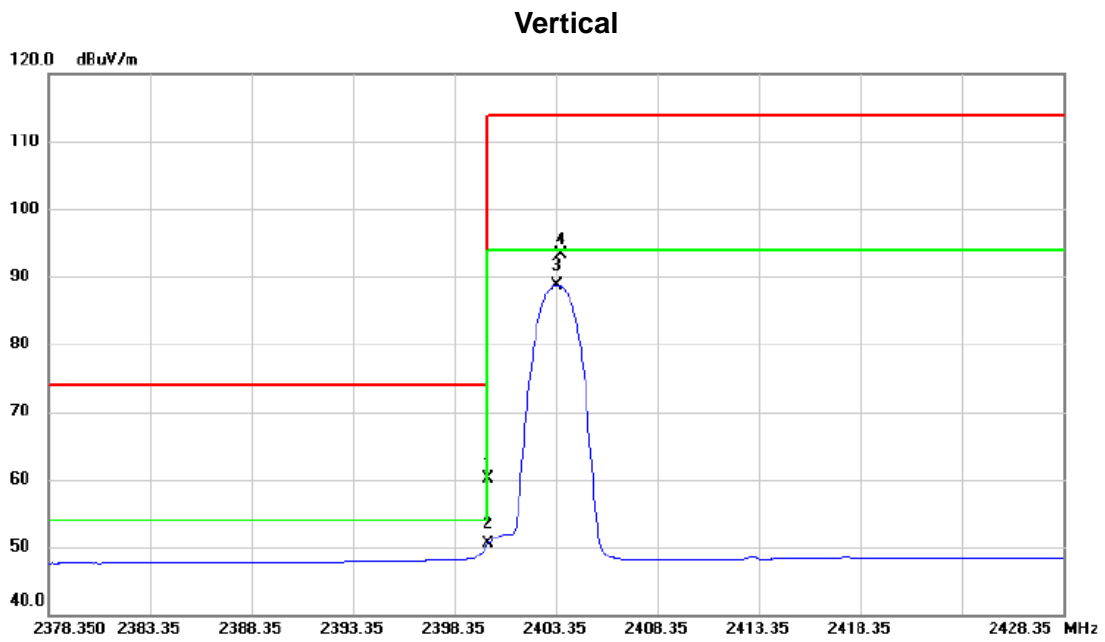

No.	Mk.	Freq. MHz	Reading Level dBuV	Correct Factor dB	Measure- ment dBuV/m	Limit dBuV/m	Margin dB	Detector	Comment
1		2400.000	25.90	34.29	60.19	74.00	-13.81	peak	
2	*	2400.000	16.17	34.29	50.46	54.00	-3.54	AVG	
3		2403.350	54.41	34.31	88.72	94.00	-5.28	AVG	No Limit
4		2403.550	58.92	34.31	93.23	114.00	-20.77	peak	No Limit

Test Mode : TX Low Channel

Vertical

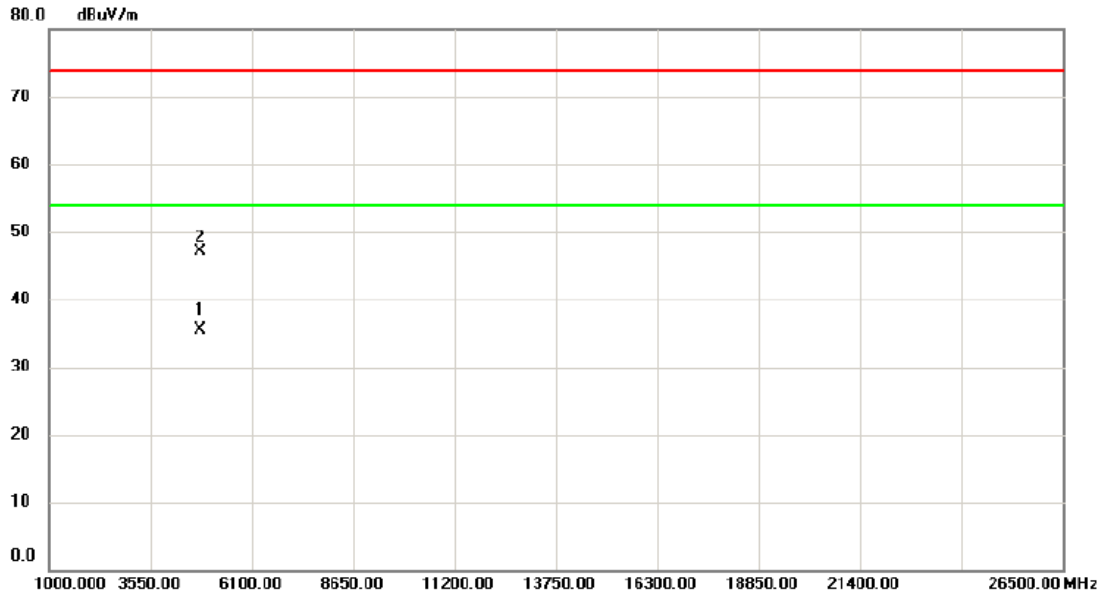

No.	Mk.	Freq. MHz	Reading Level dBuV	Correct Factor dB	Measure- ment dBuV/m	Limit dBuV/m	Margin dB	Detector	Comment
1	*	4807.600	29.75	5.82	35.57	54.00	-18.43	AVG	
2		4807.750	41.20	5.82	47.02	74.00	-26.98	peak	

Test Mode : TX Low Channel

### Horizontal

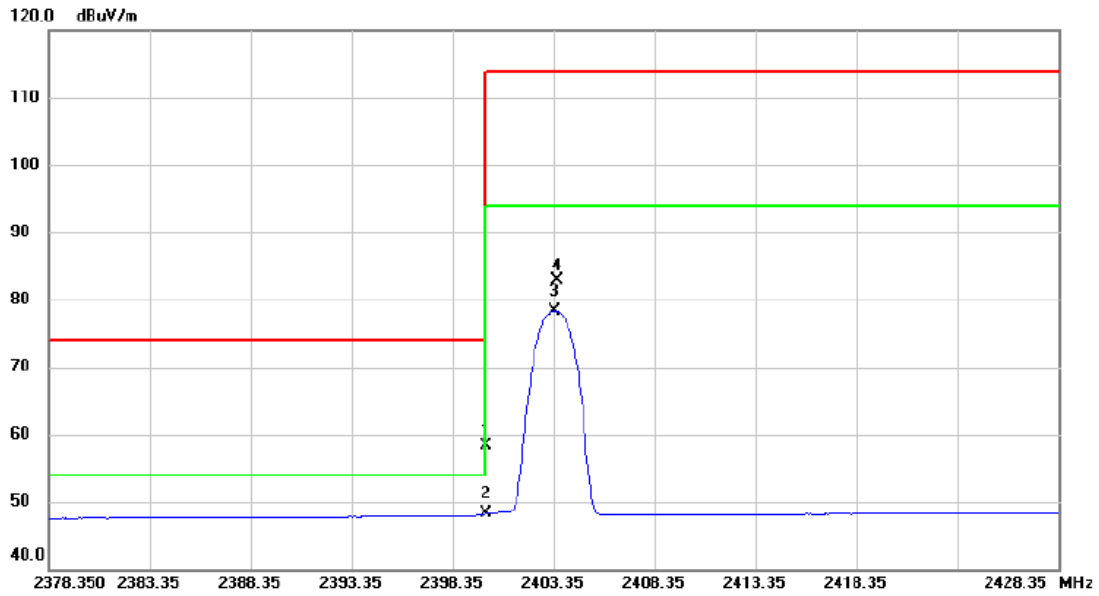

No.	Mk.	Freq.	Reading Level	Correct Factor	Measurement	Limit	Margin	Detector	Comment
		MHz	dBuV	dB	dBuV/m	dBuV/m	dB		
1		2400.000	23.98	34.29	58.27	74.00	-15.73	peak	
2	*	2400.000	13.92	34.29	48.21	54.00	-5.79	AVG	
3		2403.400	44.01	34.31	78.32	94.00	-15.68	AVG	No Limit
4		2403.500	48.57	34.31	82.88	114.00	-31.12	peak	No Limit

Test Mode : TX Low Channel

### Horizontal

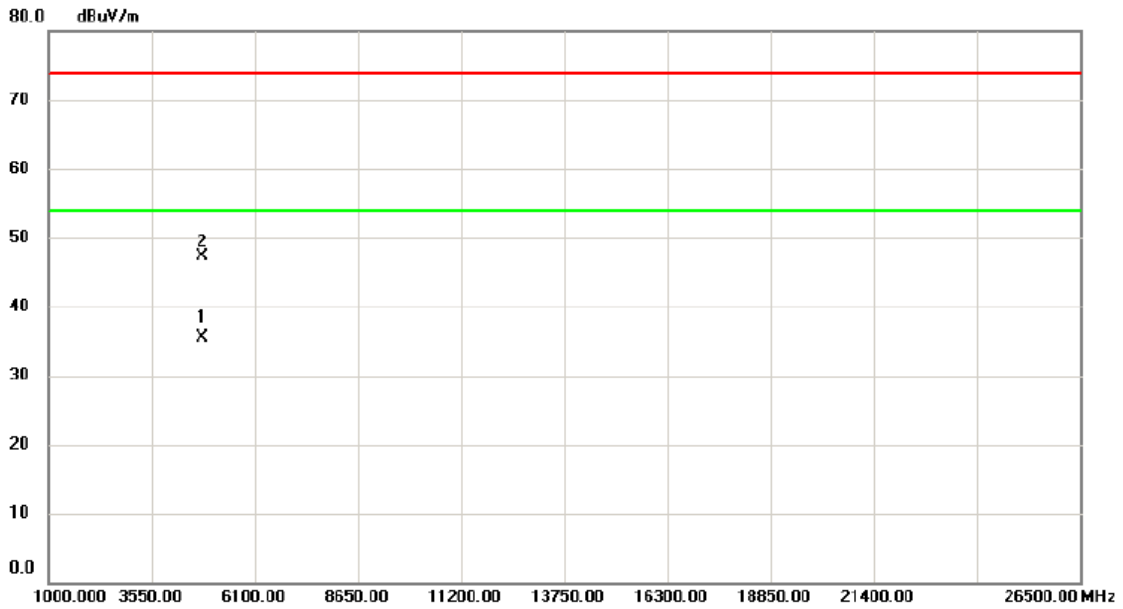

No.	Mk.	Freq. MHz	Reading Level dBuV	Correct Factor dB	Measure- ment dBuV/m	Limit dBuV/m	Margin dB	Detector	Comment
1	*	4807.500	29.60	5.82	35.42	54.00	-18.58	AVG	
2		4807.650	41.43	5.82	47.25	74.00	-26.75	peak	

Test Mode : TX Middle Channel

Vertical

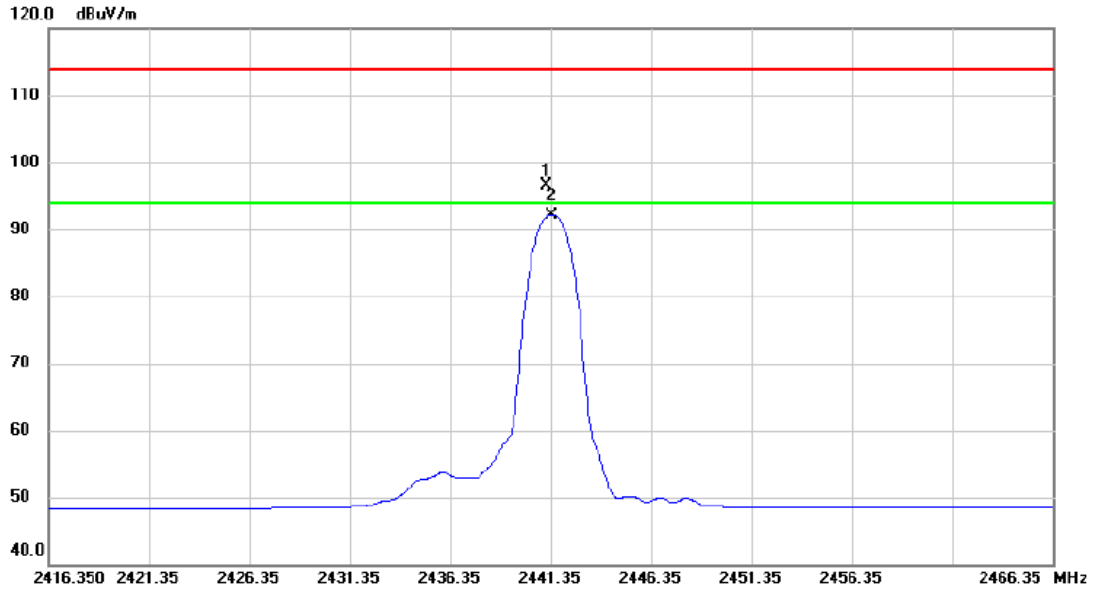

No.	Mk.	Freq. MHz	Reading Level dBuV	Correct Factor dB	Measure- ment dBuV/m	Limit dBuV/m	Margin dB	Detector	Comment
1		2441.100	61.93	34.53	96.46	114.00	-17.54	peak	No Limit
2	*	2441.400	57.66	34.53	92.19	94.00	-1.81	AVG	No Limit

Test Mode : TX Middle Channel

Vertical

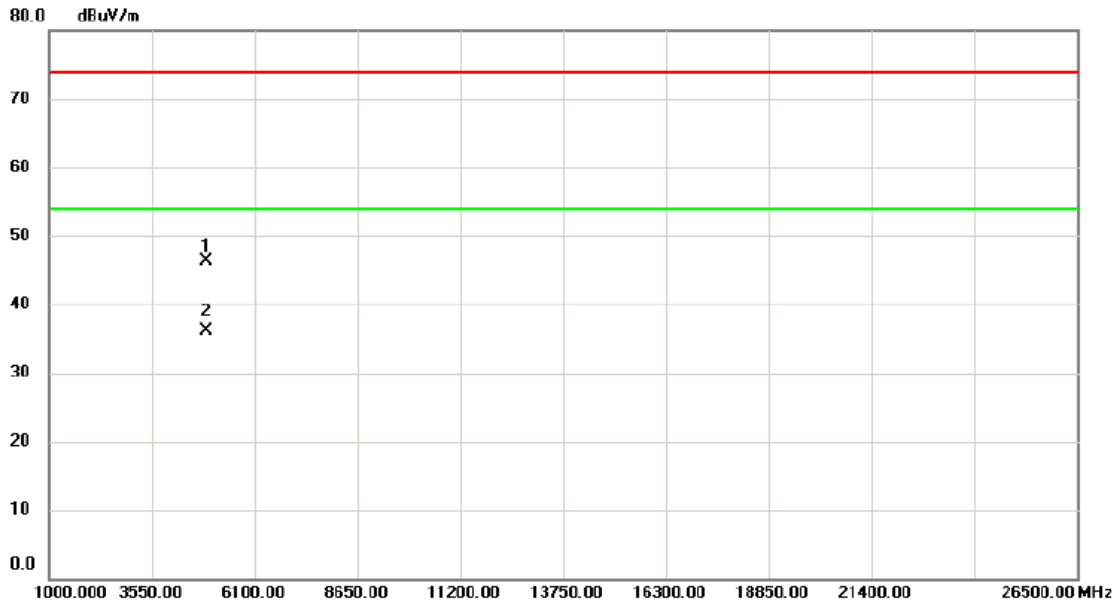

No.	Mk.	Freq. MHz	Reading Level dBuV	Correct Factor dB	Measure- ment dBuV/m	Limit dBuV/m	Margin dB	Detector	Comment
1		4881.620	40.24	6.03	46.27	74.00	-27.73	peak	
2	*	4883.340	30.15	6.03	36.18	54.00	-17.82	AVG	



Test Mode : TX Middle Channel

### Horizontal

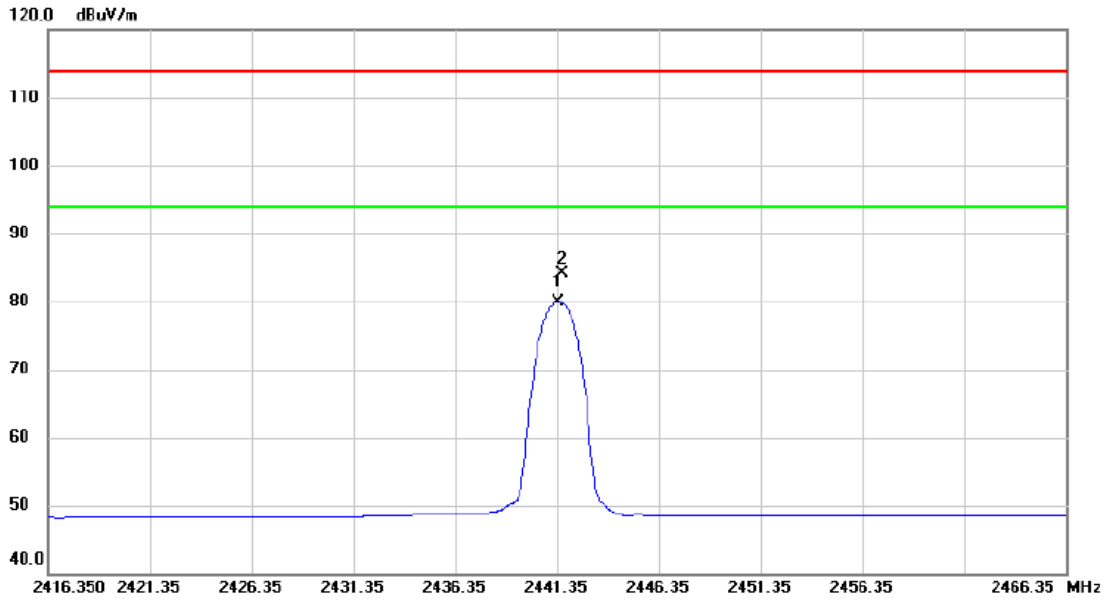

No.	Mk.	Freq.	Reading Level	Correct Factor	Measurement	Limit	Margin		
		MHz	dBuV	dB	dBuV/m	dBuV/m	dB	Detector	Comment
1	*	2441.400	45.38	34.53	79.91	94.00	-14.09	AVG	No Limit
2		2441.550	49.65	34.53	84.18	114.00	-29.82	peak	No Limit

Test Mode : TX Middle Channel

### Horizontal

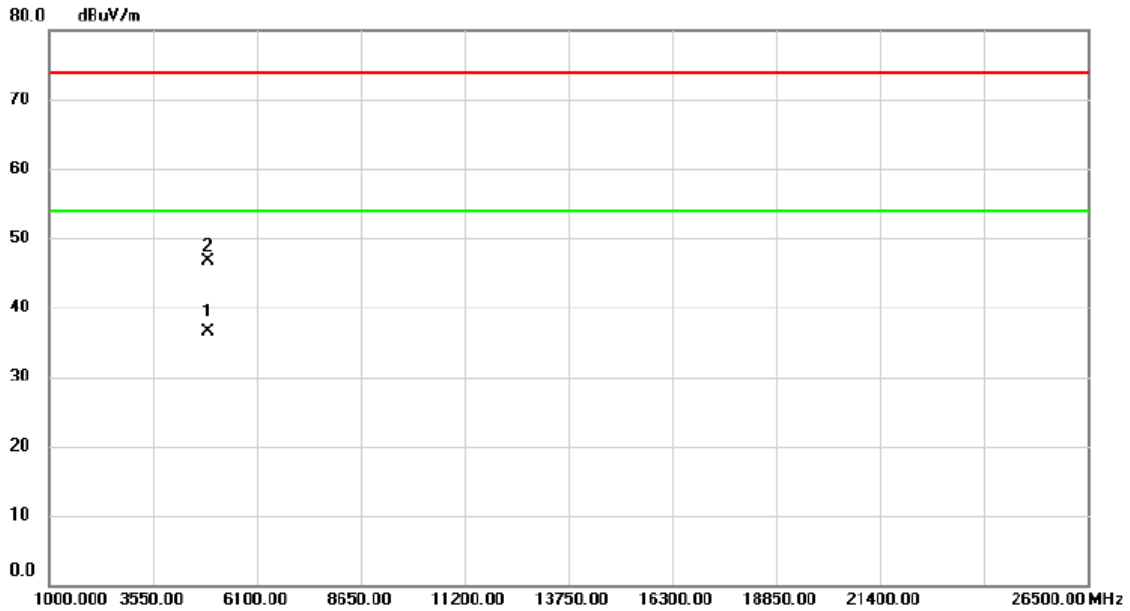

No.	Mk.	Freq. MHz	Reading Level dBuV	Correct Factor dB	Measure- ment dBuV/m	Limit dBuV/m	Margin dB	Detector	Comment
1	*	4882.250	30.50	6.03	36.53	54.00	-17.47	AVG	
2		4882.630	40.75	6.03	46.78	74.00	-27.22	peak	

Test Mode : TX High Channel

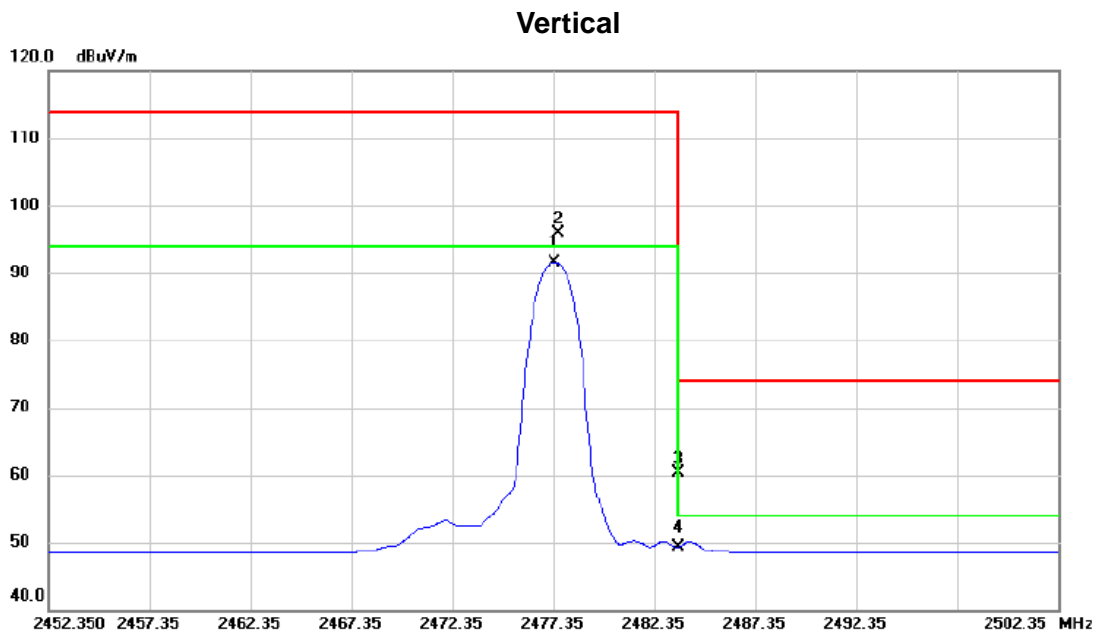

No.	Mk.	Freq. MHz	Reading Level dBuV	Correct Factor dB	Measure- ment dBuV/m	Limit dBuV/m	Margin dB	Detector	Comment
1	*	2477.350	56.79	34.74	91.53	94.00	-2.47	AVG	No Limit
2		2477.550	61.09	34.74	95.83	114.00	-18.17	peak	No Limit
3		2483.500	25.55	34.78	60.33	74.00	-13.67	peak	
4		2483.500	14.59	34.78	49.37	54.00	-4.63	AVG	

Test Mode : TX High Channel

Vertical

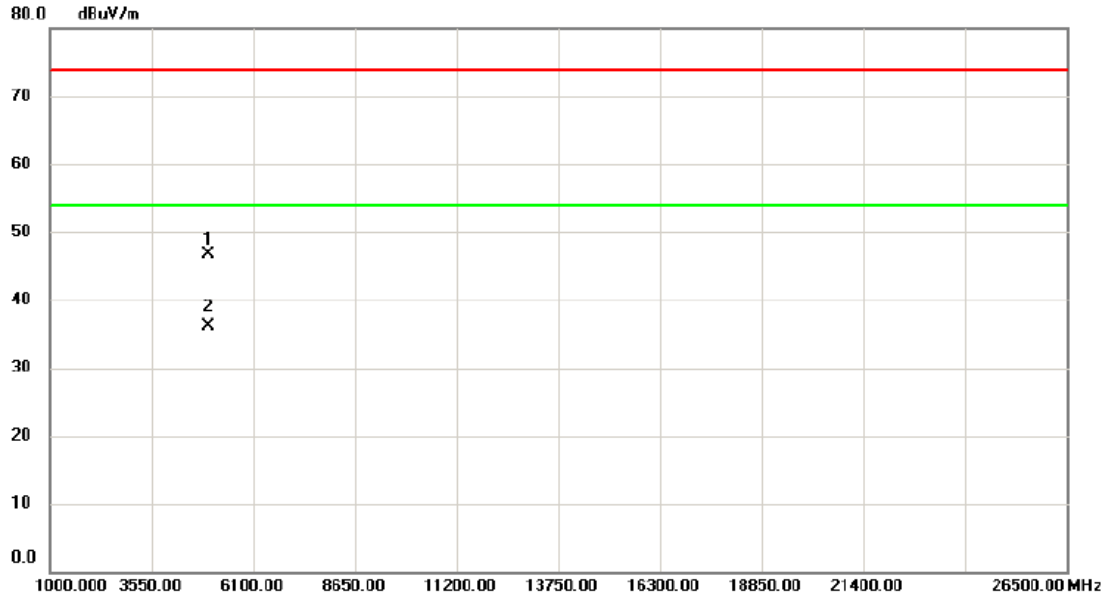

No.	Mk.	Freq. MHz	Reading Level dBuV	Correct Factor dB	Measure- ment dBuV/m	Limit dBuV/m	Margin dB	Detector	Comment
1		4954.820	40.43	6.21	46.64	74.00	-27.36	peak	
2	*	4955.670	29.87	6.21	36.08	54.00	-17.92	AVG	

Test Mode : TX High Channel

### Horizontal

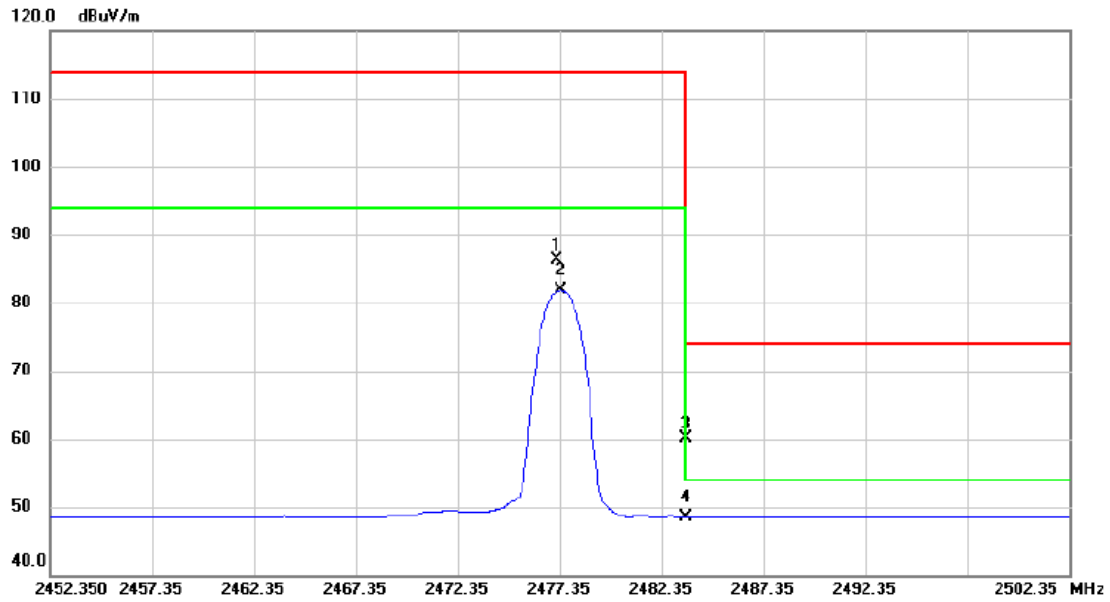

No.	Mk.	Freq. MHz	Reading Level dBuV	Correct Factor dB	Measure- ment dBuV/m	Limit dBuV/m	Margin dB	Detector	Comment
1		2477.200	51.49	34.74	86.23	114.00	-27.77	peak	No Limit
2		2477.350	47.07	34.74	81.81	94.00	-12.19	AVG	No Limit
3		2483.500	25.26	34.78	60.04	74.00	-13.96	peak	
4	*	2483.500	13.76	34.78	48.54	54.00	-5.46	AVG	

Test Mode : TX High Channel

### Horizontal

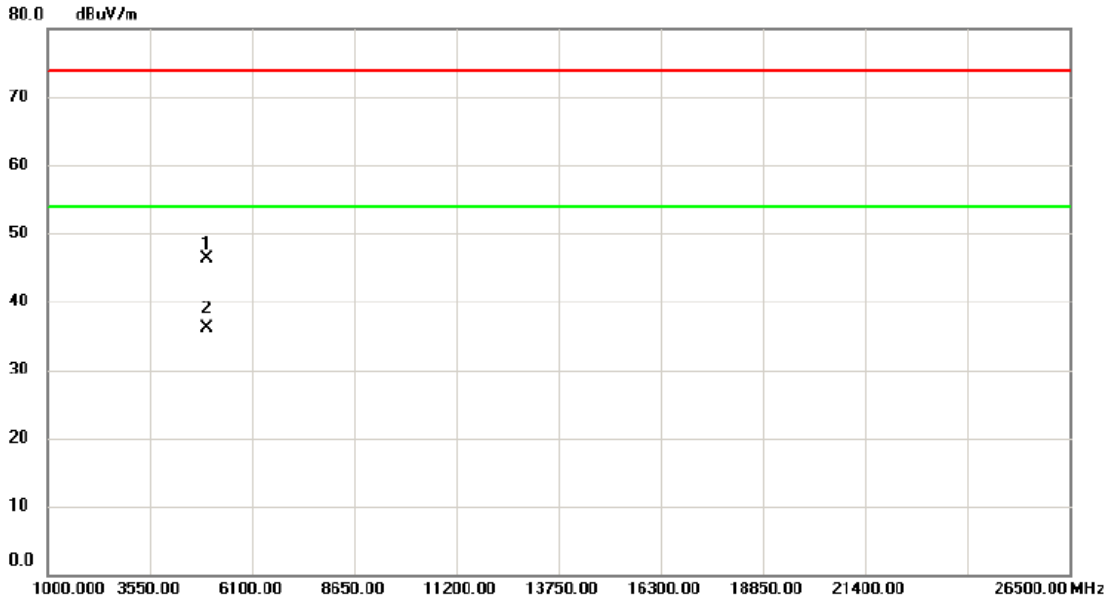

No.	Mk.	Freq. MHz	Reading Level dBuV	Correct Factor dB	Measure- ment dBuV/m	Limit dBuV/m	Margin dB	Detector	Comment
1		4953.100	40.06	6.21	46.27	74.00	-27.73	peak	
2	*	4955.230	29.96	6.21	36.17	54.00	-17.83	AVG	

## ATTACHMENT E - BANDWIDTH

Test Mode:	TX Mode
------------	---------

Frequency (MHz)	20dB Bandwidth (MHz)	99% Occupied BW (MHz)
Low Channel	2.17	1.93
Middle Channel	2.18	1.94
High Channel	2.15	1.94

### TX Low Channel

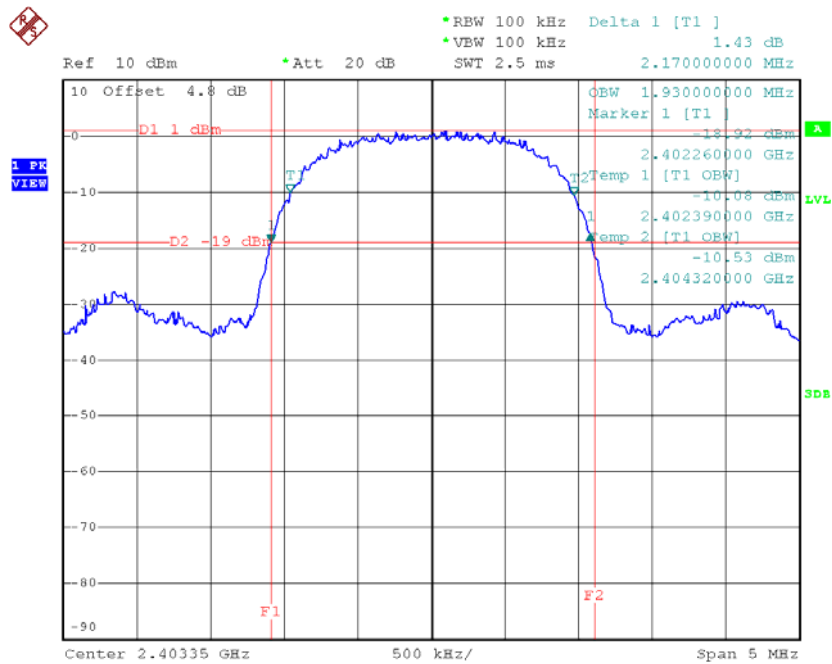

Date: 12.NOV.2015 18:49:04



### TX Middle Channel

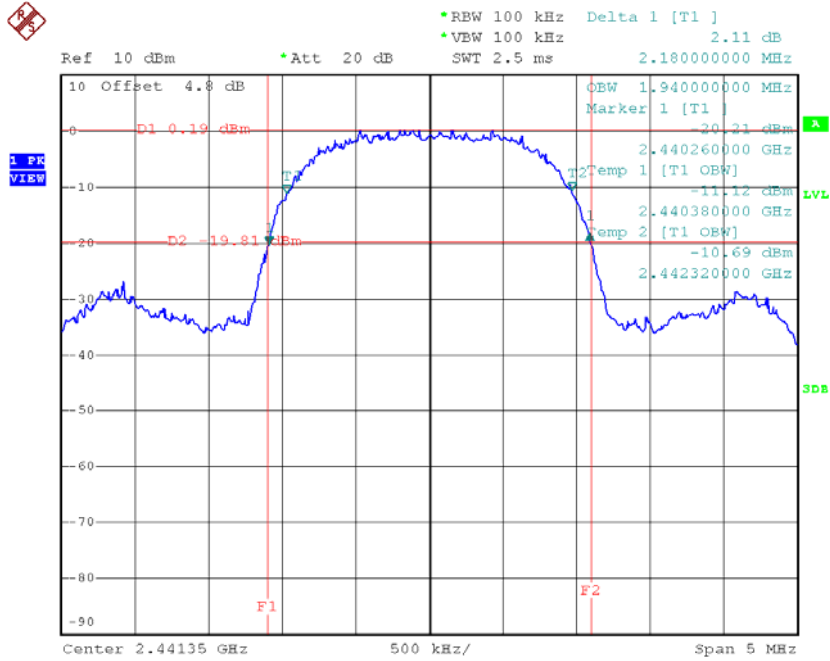

Date: 12.NOV.2015 18:53:52

### TX High Channel

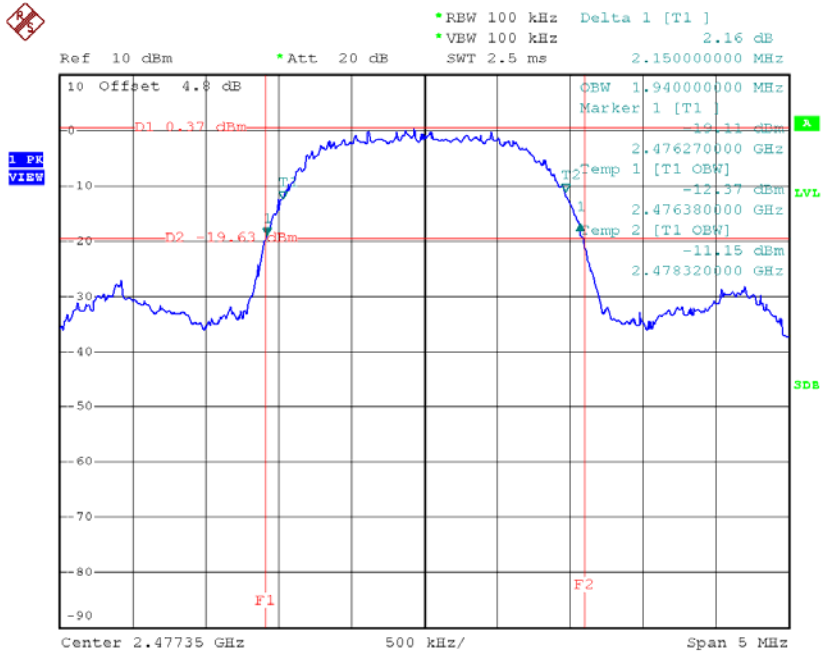

Date: 12.NOV.2015 18:56:28