



FCC PART 15 SUBPART C TEST REPORT

FCC PART 15.247

Report Reference No.....: TRE1305013301 R/C:22760

FCC ID: RVZHYM740

Compiled by

(position+printed name+signature)..: File administrators Jerome Luo

Jerome Luo

Supervised by

(position+printed name+signature)..: Test Engineer Yuchao Wang

yuchao.wang

Approved by

(position+printed name+signature)..: Manager Wenliang Li

Wenliang Li

Date of issue.....: May 31, 2013

Testing Laboratory Name: Shenzhen Huatongwei International Inspection Co., Ltd

Address: Keji Nan No.12 Road, Hi-tech Park, Shenzhen, China

Applicant's name: Winnix Technologies Co., Limited

Address: 4/F R2-B Building, Hi-tech Park, NanShan District, ShenZhen, GuangDong, China

Test specification:

Standard: **FCC Part 15.247: Operation within the bands 902-928 MHz, 2400-2483.5 MHz and 5725-5850 MHz Direct Sequence System**

TRF Originator.....: Shenzhen Huatongwei International Inspection CO., Ltd

Master TRF.....: Dated 2006-06

Shenzhen Huatongwei International Inspection Co., Ltd. All rights reserved.

This publication may be reproduced in whole or in part for non-commercial purposes as long as the Shenzhen Huatongwei International Inspection Co., Ltd is acknowledged as copyright owner and source of the material. Shenzhen Huatongwei International Inspection Co., Ltd takes no responsibility for and will not assume liability for damages resulting from the reader's interpretation of the reproduced material due to its placement and context.

Test item description: UHF RFID Reader Module

Trade Mark: /

Model/Type reference.....: HYM740,UM620,UM7

Modulation: GFSK

Manufacturer.....: REALID TECHNOLOGY CO., LTD.

Listed Models: /

Ratings: DC 5.0 V

Result.....: **Positive**

T E S T R E P O R T

Test Report No. :	TRE1305013301	May 31, 2013
		Date of issue

Equipment under Test : UHF RFID Reader Module

Model /Type : HYM740,UM620,UM7

Listed Models : /

Applicant : **Winnix Technologies Co., Limited.**

Address : 4/F R2-B Building,Hi-tech Park,NanShan District,ShenZhen, GuangDong,China

Manufacturer : **REALID TECHNOLOGY CO., LTD.**

Address : Unit04,7/F,Bright way tower,NO.33 Mong KOK Road,Kowlood,HK.

Test Result according to the standards on page 4:	Positive
--	-----------------

The test report merely corresponds to the test sample.

It is not permitted to copy extracts of these test result without the written permission of the test laboratory.

Contents

1.	<u>TEST STANDARDS</u>	4
2.	<u>SUMMARY</u>	5
2.1.	General Remarks	5
2.2.	Equipment Under Test	5
2.3.	Short description of the Equipment under Test (EUT)	5
2.4.	EUT operation mode	5
2.5.	Related Submittal(s) / Grant (s)	6
2.6.	Configuration of Test System	6
2.7.	EUT configuration	6
2.8.	Modifications	6
2.9.	NOTE	7
3.	<u>TEST ENVIRONMENT</u>	8
3.1.	Address of the test laboratory	8
3.2.	Test Facility	8
3.3.	Environmental conditions	9
3.4.	Test Description	9
3.5.	Statement of the measurement uncertainty	9
3.6.	Equipments Used during the Test	10
4.	<u>TEST CONDITIONS AND RESULTS</u>	11
4.1.	AC Power Conducted Emission(Not Applicable)	11
4.2.	Radiated Emission	12
4.3.	Spurious RF CONDUCTED EMISSIONS	18
4.4.	Maximum Peak Output Power	21
4.5.	20dB Bandwidth	24
4.6.	Band Edge	27
4.7.	Frequency Separation	29
4.8.	Number of hopping frequency	32
4.9.	Time Of Occupancy(Dwell Time)	33
4.10.	Receiver spurious Emissions	36
4.11.	Antenna Requirement	42
5.	<u>TEST SETUP PHOTOS OF THE EUT</u>	43
6.	<u>EXTERNAL AND INTERNAL PHOTOS OF THE EUT</u>	45

1. TEST STANDARDS

The tests were performed according to following standards:

[FCC Rules Part 15.247](#): Frequency Hopping, Direct Spread Spectrum and Hybrid Systems that are in operation within the bands of 902-928 MHz, 2400-2483.5 MHz, and 5725-5850 MHz.

[ANSI C63.10-2009](#): American National Standard for Testing Unlicensed Wireless Devices

2. SUMMARY

2.1. General Remarks

Date of receipt of test sample	:	May 23,2013
Testing commenced on	:	May 23,2013
Testing concluded on	:	May 31, 2013

2.2. Equipment Under Test

Power supply system utilised

Power supply voltage	:	<input type="radio"/> 120V / 60 Hz	<input type="radio"/> 115V / 60Hz
		<input type="radio"/> 12 V DC	<input type="radio"/> 24 V DC
		<input checked="" type="radio"/> Other (specified in blank below)	

DC 5.0V

2.3. Short description of the Equipment under Test (EUT)

902-928MHz (UHF RFID Reader Module (HYM740,UM620,UM7)),

For more details, refer to the user's manual of the EUT.

Serial number: Prototype

2.4. EUT operation mode

The EUT has been tested under typical operating condition. The Applicant provides communication tools software to control the EUT for staying in continuous transmitting and receiving mode for testing. There are 50 channels of EUT, and the test carried out at the lowest channel, middle channel and highest channel .

Frequency Range:	902-928MHz
Channel number:	50 channels
Modulation type:	GFSK
Antenna:	External Antenna

Description of the test mode

There are fifty channels provide to the EUT.

Channel	Frequency(MHz)	Channel	Frequency(MHz)
1	902.75	26	915.25
2	903.25	27	915.75
3	903.75	28	916.25
4	904.25	29	916.75
5	904.75	30	917.25
6	905.25	31	917.75
7	905.75	32	918.25
8	906.25	33	918.75
9	906.75	34	919.25
10	907.25	35	919.75
11	907.75	36	920.25
12	908.25	37	920.75
13	908.75	38	921.25

14	909.25	39	921.75
15	909.75	40	922.25
16	910.25	41	922.75
17	910.75	42	923.25
18	911.25	43	923.75
19	911.75	44	924.25
20	912.25	45	924.75
21	912.75	46	925.25
22	913.25	47	925.75
23	913.75	48	926.25
24	914.25	49	926.75
25	914.75	50	927.25

2.5. Related Submittal(s) / Grant (s)

This submittal(s) (test report) is intended for **FCC ID:RVZHYM740** filing to comply with Section 15.247 of the FCC Part 15, Subpart C Rules.

2.6. Configuration of Test System

Block Diagram of Test Setup

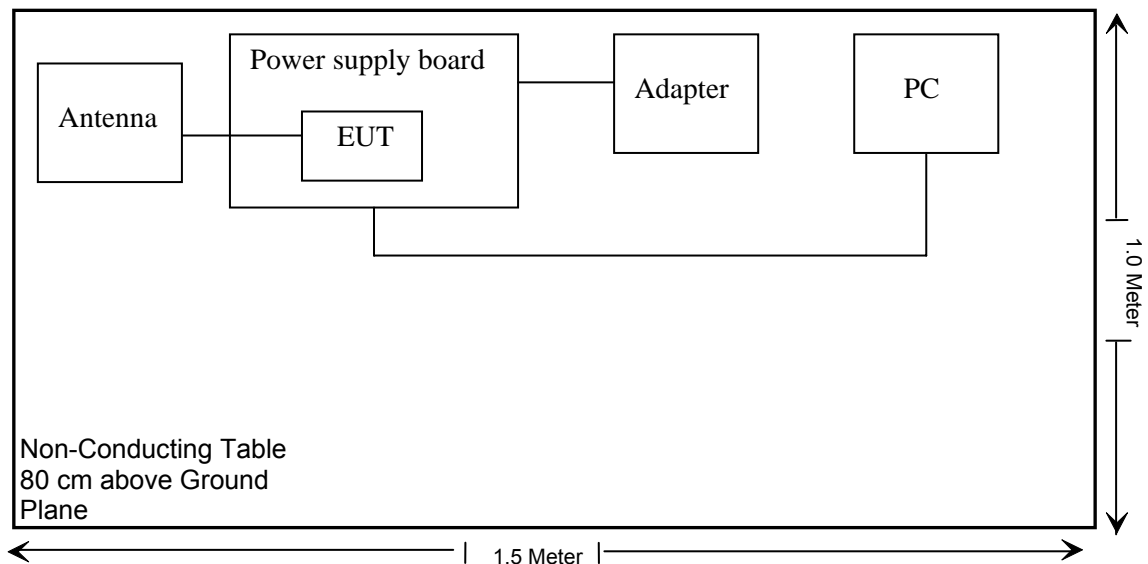

2.7. EUT configuration

The following peripheral devices and interface cables were connected during the measurement:

○ - supplied by the manufacturer

● - supplied by the lab

Support Equipment List and Details

Manufacturer	Description	Model	Serial Number	FCC ID
Notebook PC	ACER	D610	CN-0D4571-48643-51S-0236	N/A

2.8. Modifications

No modifications were implemented to meet testing criteria.

2.9. NOTE

1. The EUT is a UHF RFID Reader Module. The functions of the EUT are listed as below:

	Test Standards	Reference Report
Radio	FCC Part 15 Subpart C (Section15.247)	TRE1305013301
RF Exposure	OET 65	TRE1305013302

2. The frequency bands used in this EUT are listed as follows:

Frequency Band(MHz)	902-928	2400-2483.5	5470-5725	5725-5850
EUT	√	—	—	—

3. TEST ENVIRONMENT

3.1. Address of the test laboratory

Shenzhen Huatongwei International Inspection Co., Ltd
Keji Nan No.12 Road, Hi-tech Park, Shenzhen, China
Phone: 86-755-26715686 Fax: 86-755-26748089

The sites are constructed in conformance with the requirements of ANSI C63.7, ANSI C63.4 (2009) and CISPR Publication 22.

3.2. Test Facility

The test facility is recognized, certified, or accredited by the following organizations:

CNAS-Lab Code: L1225

Shenzhen Huatongwei International Inspection Co., Ltd. has been assessed and proved to be in compliance with CNAS-CL01 Accreditation Criteria for Testing and Calibration Laboratories (identical to ISO/IEC 17025: 2005 General Requirements) for the Competence of Testing and Calibration Laboratories, Date of Registration: Mar. 01, 2012. Valid time is until Feb 28, 2015.

A2LA-Lab Cert. No. 2243.01

Shenzhen Huatongwei International Inspection Co., Ltd. EMC Laboratory has been accredited by A2LA for technical competence in the field of electrical testing, and proved to be in compliance with ISO/IEC 17025: 2005 General Requirements for the Competence of Testing and Calibration Laboratories and any additional program requirements in the identified field of testing. Valid time is until Sept. 30, 2013.

FCC-Registration No.: 662850

Shenzhen Huatongwei International Inspection Co., Ltd. EMC Laboratory has been registered and fully described in a report filed with the FCC (Federal Communications Commission). The acceptance letter from the FCC is maintained in our files. Registration 662850, Renewal date Jun. 01, 2012, valid time is until Jun. 01, 2015.

IC-Registration No.: 5377A

The 3m Alternate Test Site of Shenzhen Huatongwei International Inspection Co., Ltd. has been registered by Certification and Engineering Bureau of Industry Canada for the performance of radiated measurements with Registration No. 5377A on Jan. 25, 2011, valid time is until Jan. 24, 2014.

ACA

Shenzhen Huatongwei International Inspection Co., Ltd. EMC Laboratory can also perform testing for the Australian C-Tick mark as a result of our A2LA accreditation.

VCCI

The 3m Semi-anechoic chamber (12.2m×7.95m×6.7m) and Shielded Room (8m×4m×3m) of Shenzhen Huatongwei International Inspection Co., Ltd. has been registered in accordance with the Regulations for Voluntary Control Measures with Registration No.: G-292. Date of Registration: Dec. 24, 2010. Valid time is until Dec. 23, 2013.

Main Ports Conducted Interference Measurement of Shenzhen Huatongwei International Inspection Co., Ltd. has been registered in accordance with the Regulations for Voluntary Control Measures with Registration No.: C-2726. Date of Registration: Dec. 20, 2012. Valid time is until Dec. 19, 2015.

Telecommunication Ports Conducted Interference Measurement of Shenzhen Huatongwei International Inspection Co., Ltd. has been registered in accordance with the Regulations for Voluntary Control Measures with Registration No.: T-1837. Date of Registration: May 07, 2013. Valid time is until May 06, 2016.

DNV

Shenzhen Huatongwei International Inspection Co., Ltd. has been found to comply with the requirements of DNV towards subcontractor of EMC and safety testing services in conjunction with the EMC and Low voltage Directives and in the voluntary field. The acceptance is based on a formal quality Audit and follow-ups according to relevant parts of ISO/IEC Guide 17025 (2005), in accordance with the requirements of the DNV

Laboratory Quality Manual towards subcontractors. Valid time is until Aug. 24, 2016.

3.3. Environmental conditions

During the measurement the environmental conditions were within the listed ranges:

Temperature:	<u>15-35 ° C</u>
Humidity:	<u>30-60 %</u>
Atmospheric pressure:	<u>950-1050mbar</u>

3.4. Test Description

FCC Part 15 15.247 Requirement		
FCC Part 15.207	AC Power Conducted Emission	N/A
FCC Part 15.247(a)(2)	20dB Bandwidth	PASS
FCC Part 15.247(d)	Spurious RF Conducted Emission	PASS
FCC Part 15.247(b)	Maximum Peak Output Power	PASS
FCC Part 15.247(a)(1)(iii)	Number of hopping frequency& Time of Occupancy	PASS
FCC Part 15.247(a)(1)	Frequency Separation	PASS
FCC Part 15.109/ 15.205/ 15.209	Radiated Emissions	PASS
FCC Part 15.247(d)	Band Edge Compliance of RF Emission	PASS
FCC Part 15.203/15.247 (b)	Antenna Requirement	PASS
FCC Part 1.1307 (b)	MPE Evaluation	PASS
FCC Part 15B 15.109	Receiver spurious Emissions	PASS

Remark: The measurement uncertainty is not included in the test result.

3.5. Statement of the measurement uncertainty

The data and results referenced in this document are true and accurate. The reader is cautioned that there may be errors within the calibration limits of the equipment and facilities. The measurement uncertainty was calculated for all measurements listed in this test report acc. to CISPR 16 - 4 „Specification for radio disturbance and immunity measuring apparatus and methods – Part 4: Uncertainty in EMC Measurements“ and is documented in the Shenzhen Huatongwei International Inspection Co., Ltd quality system acc. to DIN EN ISO/IEC 17025. Furthermore, component and process variability of devices similar to that tested may result in additional deviation. The manufacturer has the sole responsibility of continued compliance of the device.

Hereafter the best measurement capability for Shenzhen Huatongwei laboratory is reported:

Test Items	Measurement Uncertainty	Notes
Transmitter power conducted	0.57 dB	(1)
Transmitter power Radiated	2.20 dB	(1)
Conducted spurious emission 9KHz-40 GHz	1.60 dB	(1)
Radiated spurious emission 9KHz-40 GHz	2.20 dB	(1)
Conducted Emission 9KHz-30MHz	3.39 dB	(1)
Radiated Emission 30~1000MHz	4.24 dB	(1)
Radiated Emissio 1~18GHz	5.16 dB	(1)
Radiated Emissio 18-40GHz	5.54 dB	(1)
Occupied Bandwidth	-----	(1)

(1) This uncertainty represents an expanded uncertainty expressed at approximately the 95% confidence level using a coverage factor of k=1.96.

3.6. Equipments Used during the Test

Maximum Peak Output Power / Frequency Separation / Band Edge Compliance of RF Emission / Spurious RF Conducted Emission/ Number of hopping frequency/ Time of Occupancy					
Item	Test Equipment	Manufacturer	Model No.	Serial No.	Last Cal.
1	EMI TEST RECEIVER	Rohde&Schwarz	ESI 26	100009	2012/10/27
2	Spectrum Analyzer	Rohde&Schwarz	FSP	1164.4391.40	2012/10/27

Radiated Emission					
Item	Test Equipment	Manufacturer	Model No.	Serial No.	Last Cal.
1	ULTRA-BROADBAND ANTENNA	Rohde&Schwarz	HL562	100015	2012/10/27
2	EMI TEST RECEIVER	Rohde&Schwarz	ESI 26	100009	2012/10/27
3	RF TEST PANEL	Rohde&Schwarz	TS / RSP	335015/ 0017	N/A
4	TURNTABLE	ETS	2088	2149	N/A
5	ANTENNA MAST	ETS	2075	2346	N/A
6	EMI TEST SOFTWARE	Rohde&Schwarz	ESK1	N/A	N/A
7	HORN ANTENNA	Rohde&Schwarz	HF906	100039	2012/10/27
8	Amplifer	Sonoma	310N	E009-13	2012/10/27
9	JS amplifer	Rohde&Schwarz	JS4-00101800-28-5A	F201504	2012/10/27
10	High pass filter	Compliance Direction systems	BSU-6	34202	2012/10/27
11	Broad-Band Horn Antenna	Schwarzbeck	BBHA9170	470	2012/10/27
12	Ultra-Broadband Antenna	ShwarzBeck	VULB9163	539	2012/10/27
13	HORN ANTENNA	ShwarzBeck	9120D	1011	2012/10/27
14	TURNTABLE	MATURO	TT2.0	----	N/A
15	ANTENNA MAST	MATURO	TAM-4.0-P	----	N/A
16	Loop Antenna	Rohde&Schwarz	HFH2-Z2	100020	2012/10/27

The Calibration Interval was one year.

4. TEST CONDITIONS AND RESULTS

4.1. AC Power Conducted Emission(Not Applicable)

TEST CONFIGURATION

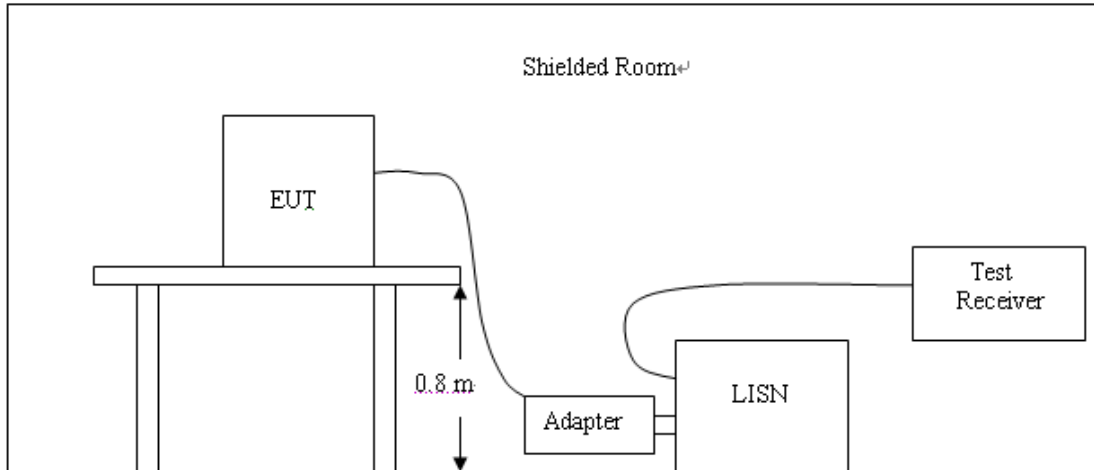

TEST PROCEDURE

- 1 The equipment was set up as per the test configuration to simulate typical actual usage per the user's manual. The EUT is a tabletop system, a wooden table with a height of 0.8 meters is used and is placed on the ground plane as per ANSI C63.10-2009.
- 2 Support equipment, if needed, was placed as per ANSI C63.10-2009
- 3 All I/O cables were positioned to simulate typical actual usage as per ANSI C63.10-2009
- 4 The EUT received DC5V power from the adapter, the adapter received AC120V/60Hz power through a Line Impedance Stabilization Network (LISN) which supplied power source and was grounded to the ground plane.
- 5 All support equipments received AC power from a second LISN, if any.
- 6 The EUT test program was started. Emissions were measured on each current carrying line of the EUT using a spectrum Analyzer / Receiver connected to the LISN powering the EUT. The LISN has two monitoring points: Line 1 (Hot Side) and Line 2 (Neutral Side). Two scans were taken: one with Line 1 connected to Analyzer / Receiver and Line 2 connected to a 50 ohm load; the second scan had Line 1 connected to a 50 ohm load and Line 2 connected to the Analyzer / Receiver.
- 7 Analyzer / Receiver scanned from 150 KHz to 30MHz for emissions in each of the test modes.
- 8 During the above scans, the emissions were maximized by cable manipulation.

AC Power Conducted Emission Limit

For intentional device, according to § 15.207(a) AC Power Conducted Emission Limits is as following :

Frequency (MHz)	Maximum RF Line Voltage (dBµV)			
	CLASS A		CLASS B	
	Q.P.	Ave.	Q.P.	Ave.
0.15 - 0.50	79	66	66-56*	56-46*
0.50 - 5.00	73	60	56	46
5.00 - 30.0	73	60	60	50

* Decreasing linearly with the logarithm of the frequency

TEST RESULTS

Not applicable to this device.

4.2. Radiated Emission

TEST CONFIGURATION

Radiated Emission Test Set-Up

Frequency range 9KHz – 30MHz

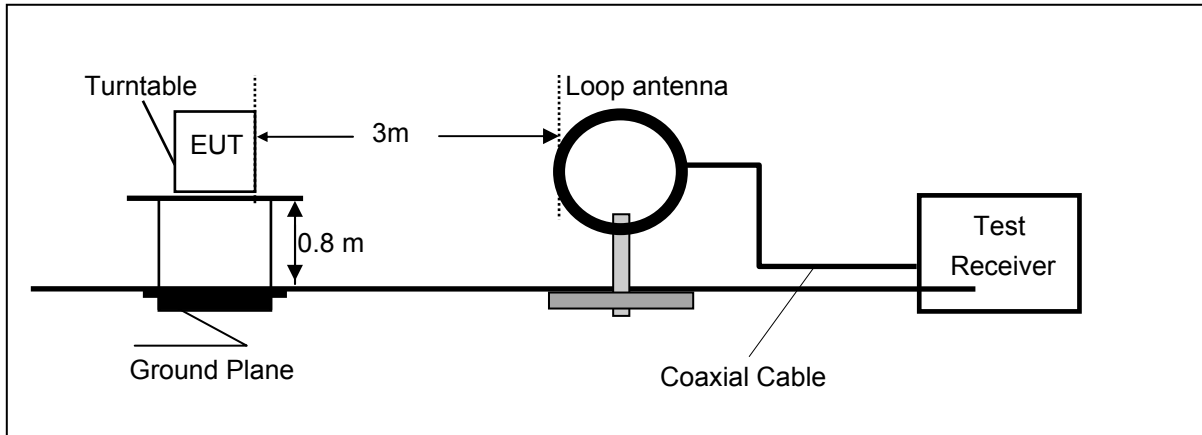

Frequency range 30MHz – 1000MHz

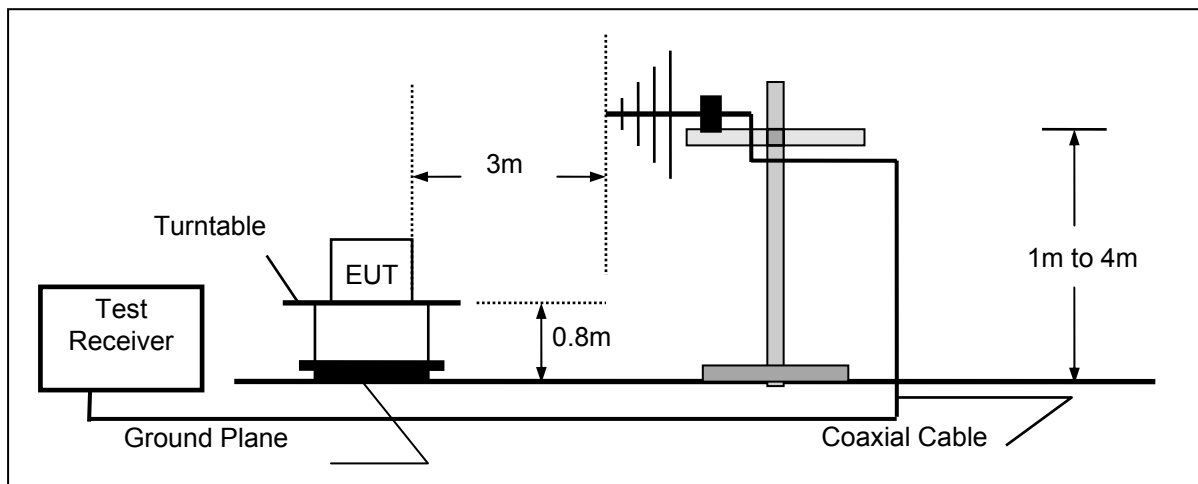

Frequency range above 1GHz-25GHz

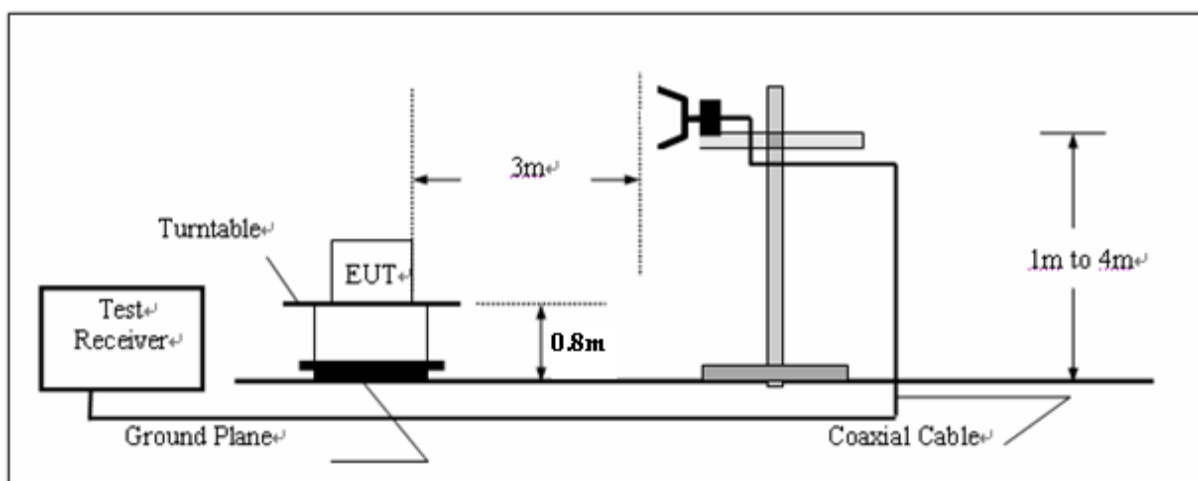

TEST PROCEDURE

- 1 The EUT was placed on a turn table which is 0.8m above ground plane.

2. Maximum procedure was performed by raising the receiving antenna from 1m to 4m and rotating the turn table from 0°C to 360°C to acquire the highest emissions from EUT
3. And also, each emission was to be maximized by changing the polarization of receiving antenna both horizontal and vertical.
4. Repeat above procedures until all frequency measurements have been completed.
5. The minimum clock frequency was 18.432MHz and fundamental frequency is 902-928MHz, So the radiation emissions frequency range were tested from 9KHz to 10GHz.

Field Strength Calculation

The field strength is calculated by adding the Antenna Factor and Cable Factor and subtracting the Amplifier Gain and Duty Cycle Correction Factor(if any) from the measured reading. The basic equation with a sample calculation is as follows:

$$FS = RA + AF + CL - AG$$

Where FS = Field Strength	CL = Cable Attenuation Factor (Cable Loss)
RA = Reading Amplitude	AG = Amplifier Gain
AF = Antenna Factor	

For example

Frequency (MHz)	FS (dBµV/m)	RA (dBµV/m)	AF (dB)	CL (dB)	AG (dB)	Transd (dB)
300.00	40	58.1	12.2	1.6	31.90	-18.1

$$Transd=AF +CL-AG$$

RADIATION LIMIT

For intentional device, according to § 15.209(a), the general requirement of field strength of radiated emission from intentional radiators at a distance of 3 meters shall not exceed the following table. According to § 15.247(d), in any 100kHz bandwidth outside the frequency band in which the EUT is operating, the radio frequency power that is produced by the intentional radiator shall be at least 20dB below that in the100kHz bandwidth within the band that contains the highest level of desired power.

Frequency (MHz)	Distance (Meters)	Radiated dBµV/m)	Radiated (µV/m)
30-88	3	40.0	100
88-216	3	43.5	150
216-960	3	46.0	200
Above 960	3	54.0	500

TEST RESULTS

- Note: 1. The EUT has four equivalent antenna interface, these antenna interface have the same circuit, we tested four antenna ports and recorded worst case in the report.
2. The minimum clock frequency was 18.432 MHz, I tested three channels(High, Middle, Low) for Radiated Emission form 9KHz to 10000MHz and recored the worst mode data.
3. Test was repeated in three different EUT positions.

For 9KHz to 30MHz

Frequency (MHz)	Corrected Reading (dBµV/m)@3m	FCC Limit (dBµV/m) @3m	Margin (dB)	Detector	Result
2.65	42.52	69.54	27.02	QP	PASS
9.63	43.66	69.54	25.88	QP	PASS
18.66	47.62	69.54	21.92	QP	PASS

For 30MHz to 1000MHz

SWEEP TABLE: "test (30M-1G)"

Short Description:		Field Strength			
Start	Stop	Detector	Meas. Time	IF Bandw.	Transducer
30.0 MHz	1.0 GHz	MaxPeak	Coupled	120 kHz	HL562

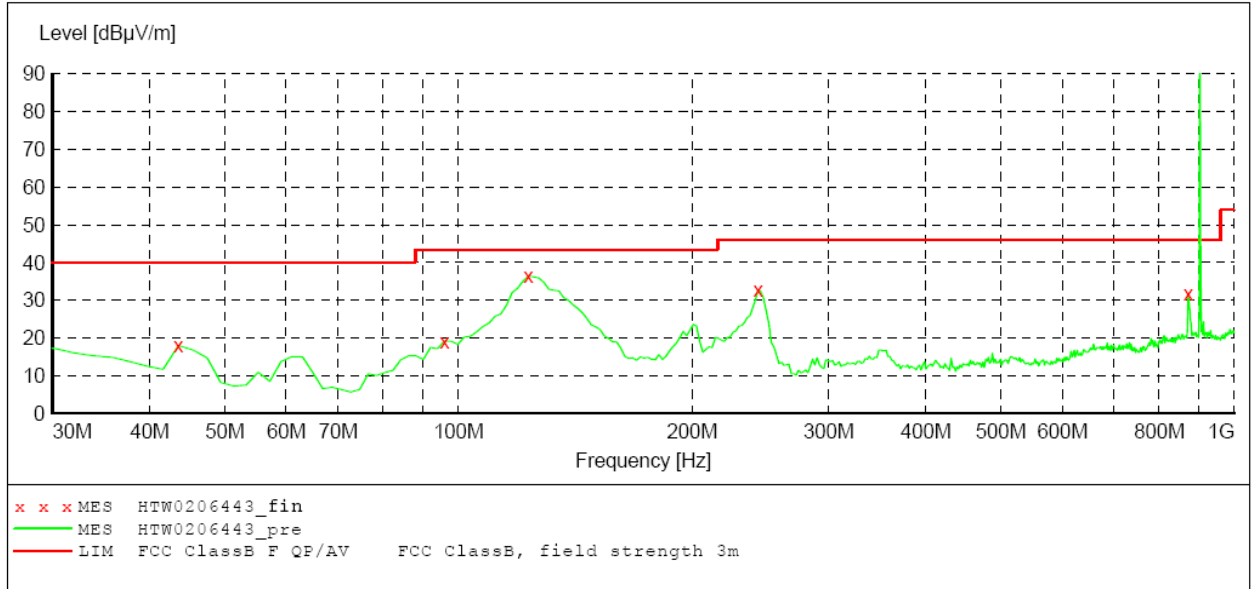

MEASUREMENT RESULT: "HTW0206443_fin"

2/6/2013 2:44PM

Frequency MHz	Level dBµV/m	Transd dB	Limit dBµV/m	Margin dB	Det.	Height cm	Azimuth deg	Polarization
43.580000	18.10	-18.3	40.0	21.9	QP	100.0	251.00	HORIZONTAL
95.960000	19.30	-20.1	43.5	24.2	QP	100.0	357.00	HORIZONTAL
123.120000	36.40	-19.5	43.5	7.1	QP	100.0	231.00	HORIZONTAL
243.400000	32.70	-18.8	46.0	13.3	QP	100.0	125.00	HORIZONTAL
871.960000	31.70	-6.9	46.0	14.3	QP	100.0	56.00	HORIZONTAL

SWEEP TABLE: "test (30M-1G)"

Short Description:		Field Strength			
Start	Stop	Detector	Meas.	IF	Transducer
Frequency	Frequency		Time	Bandw.	
30.0 MHz	1.0 GHz	MaxPeak	Coupled	120 kHz	HL562

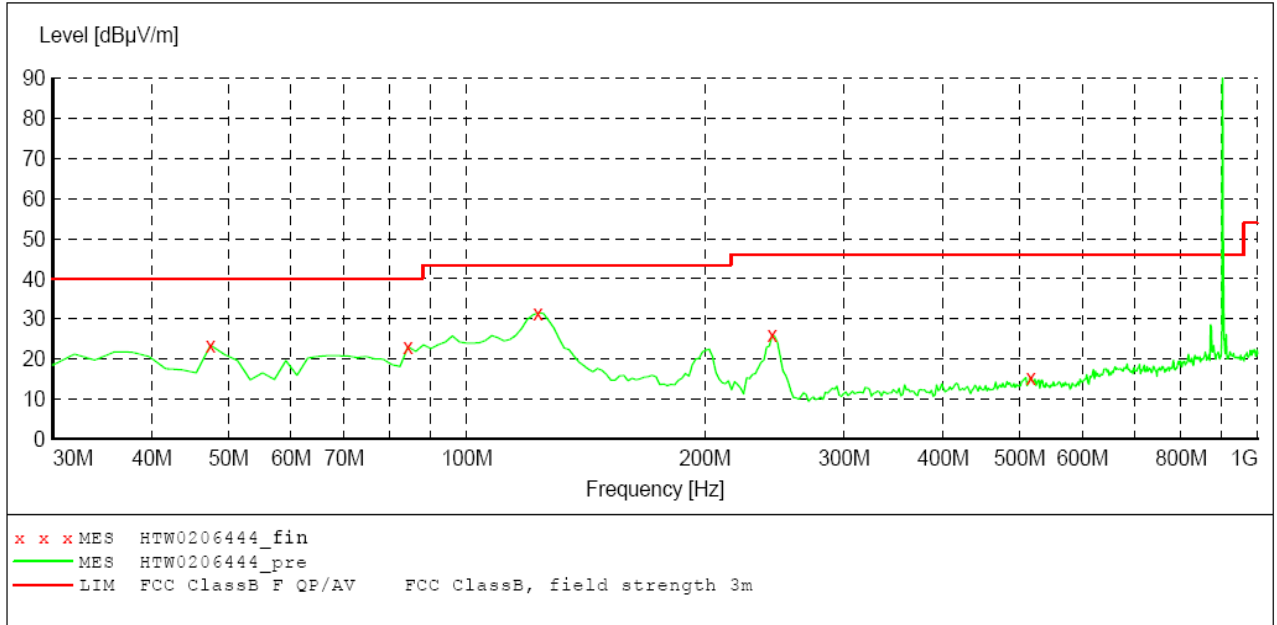

MEASUREMENT RESULT: "HTW0206444_fin"

2/6/2013 2:43PM

Frequency MHz	Level dBµV/m	Transd dB	Limit dBµV/m	Margin dB	Det.	Height cm	Azimuth deg	Polarization
47.460000	23.50	-20.9	40.0	16.5	QP	100.0	176.00	VERTICAL
84.320000	23.10	-21.3	40.0	16.9	QP	100.0	282.00	VERTICAL
123.120000	31.50	-19.5	43.5	12.0	QP	100.0	299.00	VERTICAL
243.400000	26.10	-18.8	46.0	19.9	QP	100.0	166.00	VERTICAL
516.940000	15.50	-13.0	46.0	30.5	QP	100.0	350.00	VERTICAL

Above 1G

The frequency spectrum above 1 GHz for Transmitter was investigated. All emission not reported are much lower than the prescribed limits. Set the RBW=1MHz,VBW=3MHz for Peak Detector while the RBW=1MHz,VBW=10Hz for Average Detector,Readings are both peak and average values. The pre-test have done for the EUT in three axes and found the worst emission at position shown in test setup photos.

Low Channel

ANTENNA POLARITY & TEST DISTANCE: HORIZONTAL AT 3 M												
No.	Frequency (MHz)	Emission Level (dBuV/m)		Limit (dBuV/m)	Margin (dB)	Antenna Height (m)	Table Angle (Degree)	Raw Value (dBuV)	Antenna Factor (dB/m)	Cable Factor (dB)	Pre-amplifier	Correction Factor (dB/m)
1	*902.75	125.65	PK			1.00 H	63	127.61	20.20	9.34	31.50	-1.96
2	1805.50	56.77	PK	74.00	17.23	1.00 H	58	57.37	27.40	4.30	32.30	-0.6
3	2708.25	52.32	PK	74.00	21.68	1.00 H	147	49.72	29.80	5.30	32.50	2.6
4	3611.00	50.12	PK	74.00	23.88	1.00 H	224	45.02	31.90	5.90	32.70	5.1

ANTENNA POLARITY & TEST DISTANCE: VERTICAL AT 3 M												
No.	Frequency (MHz)	Emission Level (dBuV/m)		Limit (dBuV/m)	Margin (dB)	Antenna Height (m)	Table Angle (Degree)	Raw Value (dBuV)	Antenna Factor (dB/m)	Cable Factor (dB)	Pre-amplifier	Correction Factor (dB/m)
1	*902.75	127.22	PK			1.00 V	49	129.18	20.20	9.34	31.50	-1.96
2	1805.50	58.20	PK	74.00	15.80	1.00 V	256	58.8	27.40	4.30	32.30	-0.6
3	2708.25	54.32	PK	74.00	19.68	1.00 V	117	51.72	29.80	5.30	32.50	2.6
4	3611.00	52.36	PK	74.00	21.64	1.00 V	58	47.26	31.90	5.90	32.70	5.1

Middle Channel

ANTENNA POLARITY & TEST DISTANCE: HORIZONTAL AT 3 M												
No.	Frequency (MHz)	Emission Level (dBuV/m)		Limit (dBuV/m)	Margin (dB)	Antenna Height (m)	Table Angle (Degree)	Raw Value (dBuV)	Antenna Factor (dB/m)	Cable Factor (dB)	Pre-amplifier	Correction Factor (dB/m)
1	*914.75	125.23	PK			1.00 H	336	127.19	20.20	9.34	31.50	-1.96
2	1829.50	57.22	PK	74.00	16.78	1.00 H	247	57.82	27.40	4.30	32.30	-0.6
3	2744.25	53.26	PK	74.00	20.74	1.00 H	110	50.66	29.80	5.30	32.50	2.6
4	3659.00	51.35	PK	74.00	22.65	1.00 H	158	46.25	31.90	5.90	32.70	5.1

ANTENNA POLARITY & TEST DISTANCE: VERTICAL AT 3 M												
No.	Frequency (MHz)	Emission Level (dBuV/m)		Limit (dBuV/m)	Margin (dB)	Antenna Height (m)	Table Angle (Degree)	Raw Value (dBuV)	Antenna Factor (dB/m)	Cable Factor (dB)	Pre-amplifier	Correction Factor (dB/m)
1	*914.75	128.05	PK			1.00 V	250	130.01	20.20	9.34	31.50	-1.96
2	1829.50	58.01	PK	74.00	15.99	1.00 V	214	58.61	27.40	4.30	32.30	-0.6
3	2744.25	55.20	PK	74.00	18.8	1.00 V	185	52.6	29.80	5.30	32.50	2.6
4	3659.00	49.32	PK	74.00	24.68	1.00 V	65	44.22	31.90	5.90	32.70	5.1

High Channel

ANTENNA POLARITY & TEST DISTANCE: HORIZONTAL AT 3 M												
No.	Frequency (MHz)	Emission Level (dBuV/m)		Limit (dBuV/m)	Margin (dB)	Antenna Height (m)	Table Angle (Degree)	Raw Value (dBuV)	Antenna Factor (dB/m)	Cable Factor (dB)	Pre-amplifier	Correction Factor (dB/m)
1	*927.25	126.22	PK			1.00 H	63	128.18	20.20	9.34	31.50	-1.96
2	1854.50	57.08	PK	74.00	16.92	1.00 H	145	57.68	27.40	4.30	32.30	-0.6
3	2781.75	53.65	PK	74.00	20.35	1.00 H	260	51.05	29.80	5.30	32.50	2.6
4	3709.00	50.45	PK	74.00	23.55	1.00 H	140	45.35	31.90	5.90	32.70	5.1

ANTENNA POLARITY & TEST DISTANCE: VERTICAL AT 3 M

No.	Frequency (MHz)	Emission Level (dBuV/m)		Limit (dBuV/m)	Margin (dB)	Antenna Height (m)	Table Angle (Degree)	Raw Value (dBuV)	Antenna Factor (dB/m)	Cable Factor (dB)	Pre-amplifier	Correction Factor (dB/m)
1	*927.25	128.29	PK			1.00 V	320	130.25	20.20	9.34	31.50	-1.96
2	1854.50	54.26	PK	74.00	19.74	1.00 V	65	54.86	27.40	4.30	32.30	-0.6
3	2781.75	52.02	PK	74.00	21.98	1.00 V	144	49.42	29.80	5.30	32.50	2.6
4	3709.00	50.36	PK	74.00	23.64	1.00 V	56	45.26	31.90	5.90	32.70	5.1

- REMARKS:**
1. Emission level (dBuV/m) = Raw Value (dBuV) + Correction Factor (dB/m)
 2. Correction Factor (dB/m) = Antenna Factor (dB/m) + Cable Factor (dB) - Pre-amplifier Factor
 3. The other emission levels were very low against the limit.
 4. Margin value = Limit value - Emission level.
 5. The limit value is defined as per 15.247
 6. " * " : Fundamental frequency
 7. The average measurement was not performed when the peak measured data under the limit of average detection.

4.3. Spurious RF Conducted Emissions

TEST CONFIGURATION

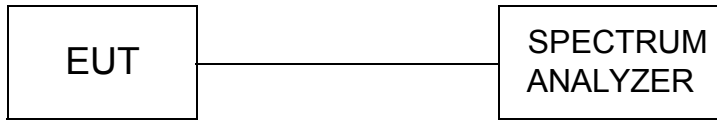

TEST PROCEDURE

Remove the antenna from the EUT and then connect a low loss RF cable from the antenna port to the spectrum.

LIMIT

The Spurious RF CONDUCTED EMISSIONS Measurement result is lower than the fundamental power 20dBc.

TEST RESULTS

Note: 1. The test results including the cable lose.

Low Channel

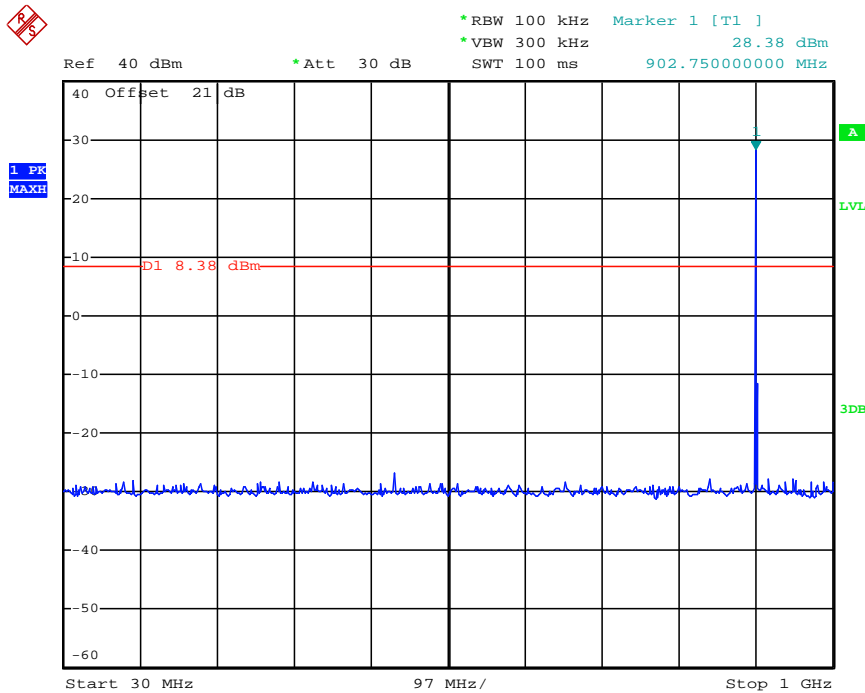

Date: 29.MAY.2013 14:47:14

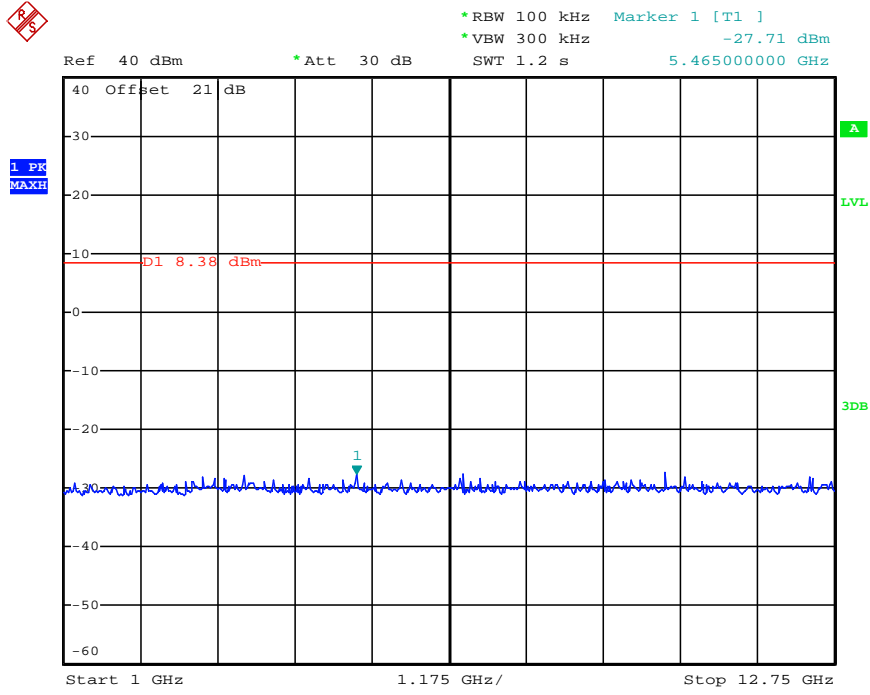

Date: 29.MAY.2013 14:47:58

Middle Channel

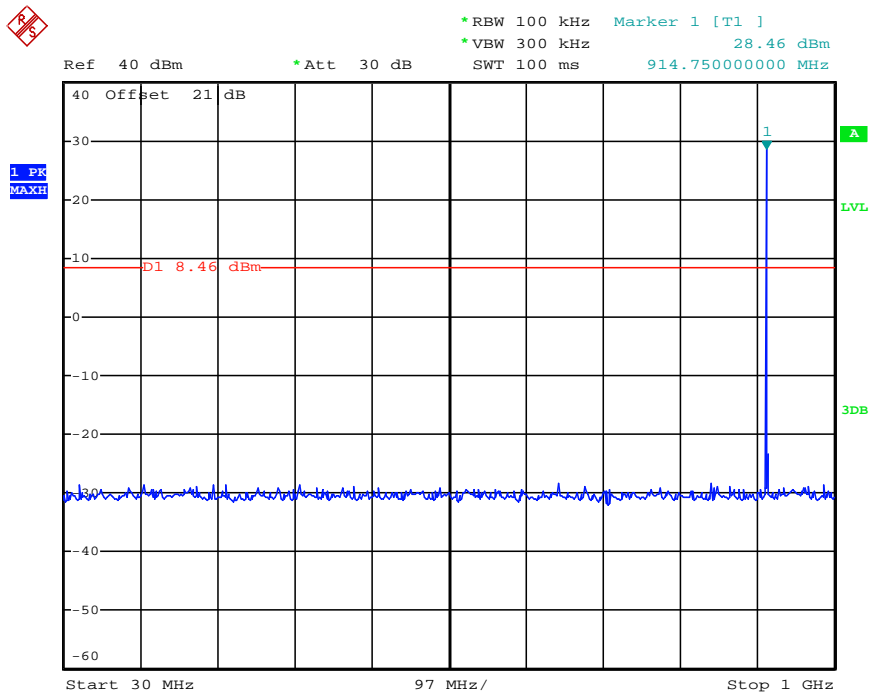

Date: 29.MAY.2013 14:50:57

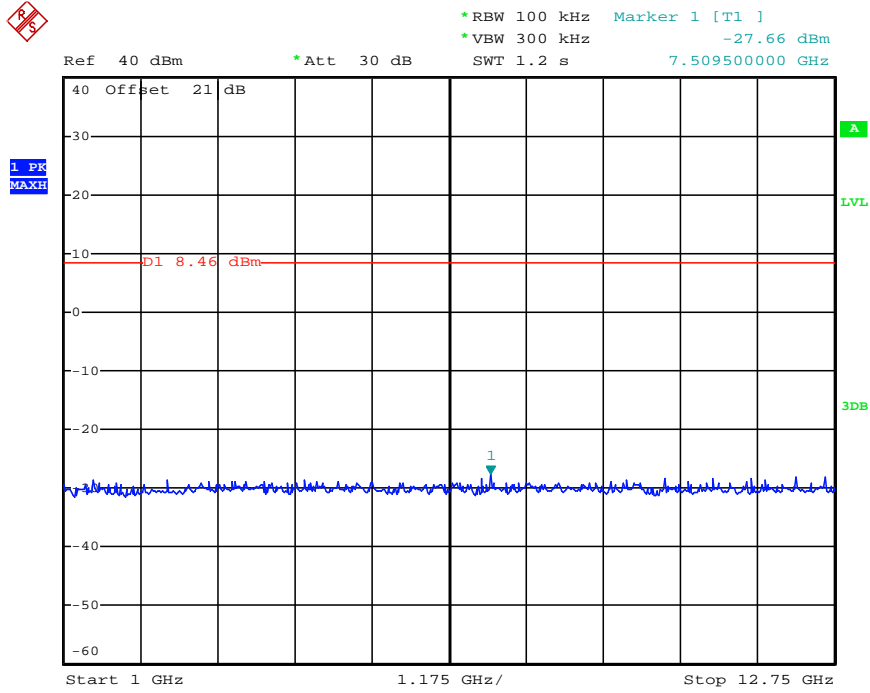

Date: 29.MAY.2013 14:51:21

High Channel

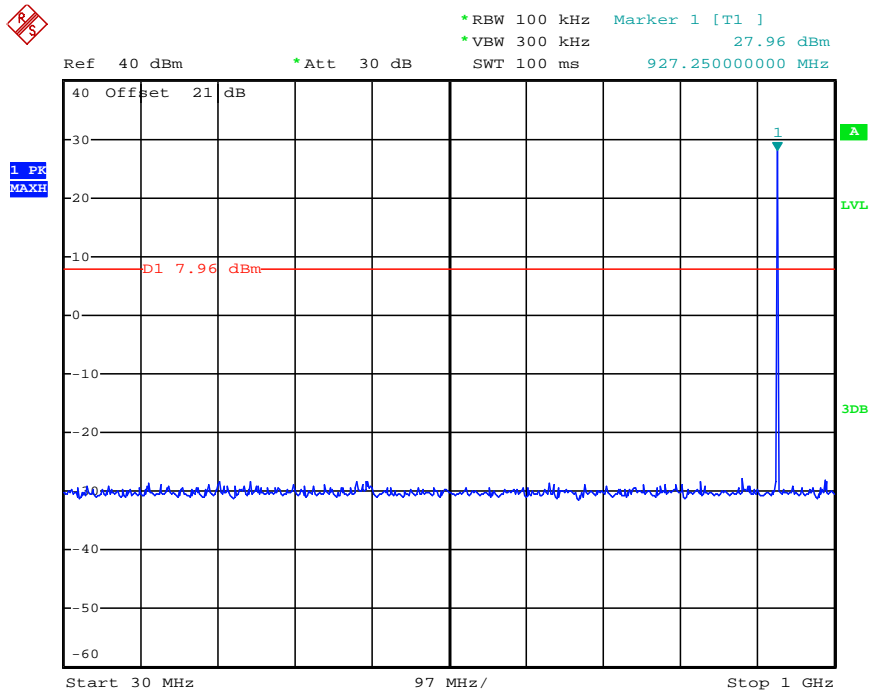

Date: 29.MAY.2013 14:53:21

4.4. Maximum Peak Output Power

TEST CONFIGURATION

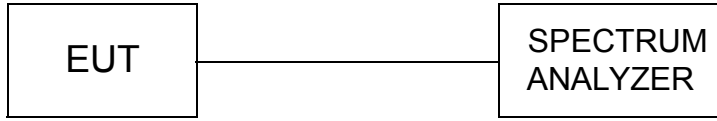

TEST PROCEDURE

Remove the antenna from the EUT and then connect a low loss RF cable from the antenna port to the spectrum.

LIMIT

For frequency hopping systems operating in the 902–928 MHz band: 1 watt for systems employing at least 50 hopping channels; and, 0.25 watts for systems employing less than 50 hop-ping channels, but at least 25 hopping channels, as permitted under para-graph (a)(1)(i) of this section.

And according to FCC 47 CFR Section 15.247 (c), if transmitting antennas of directional gain greater than 6dBi are used, the power shall be reduced by the amount in dB that the directional gain of the antenna exceeds 6dBi. The product with 50 hopping channel and maximum antenna gain was 7dBi, so the maximum output power should not exceed 29dBm.

TEST RESULTS

Channel Frequency (MHz)	Peak Power Output (dBm)	Peak Power Limit (dBm)	Verdict
902.75	28.95	29	PASS
914.75	28.84	29	PASS
927.25	28.36	29	PASS

Note: 1. The test results including the cable lose.

Low channel

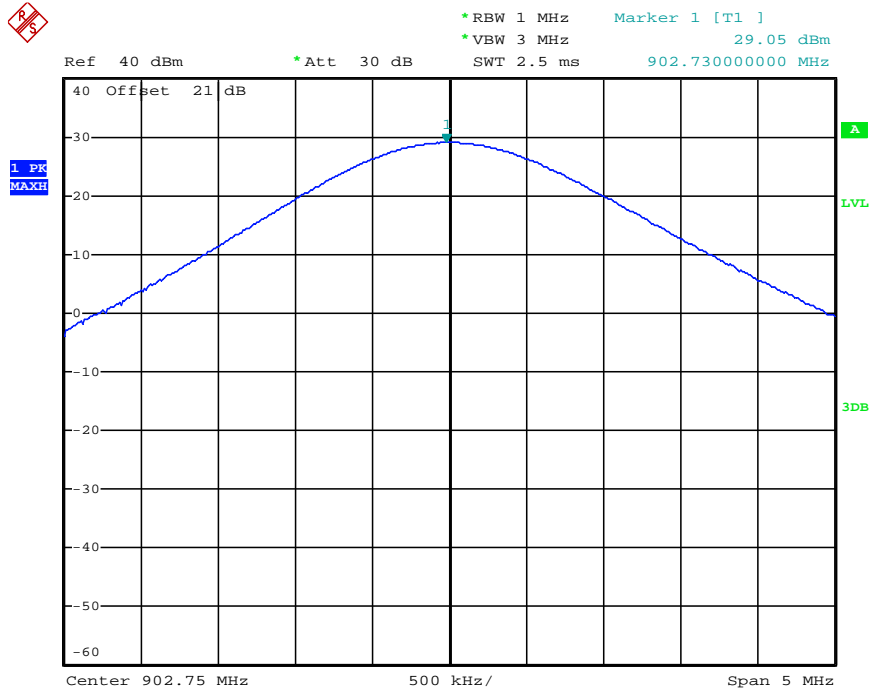

Date: 29.MAY.2013 12:22:24

Middle channel

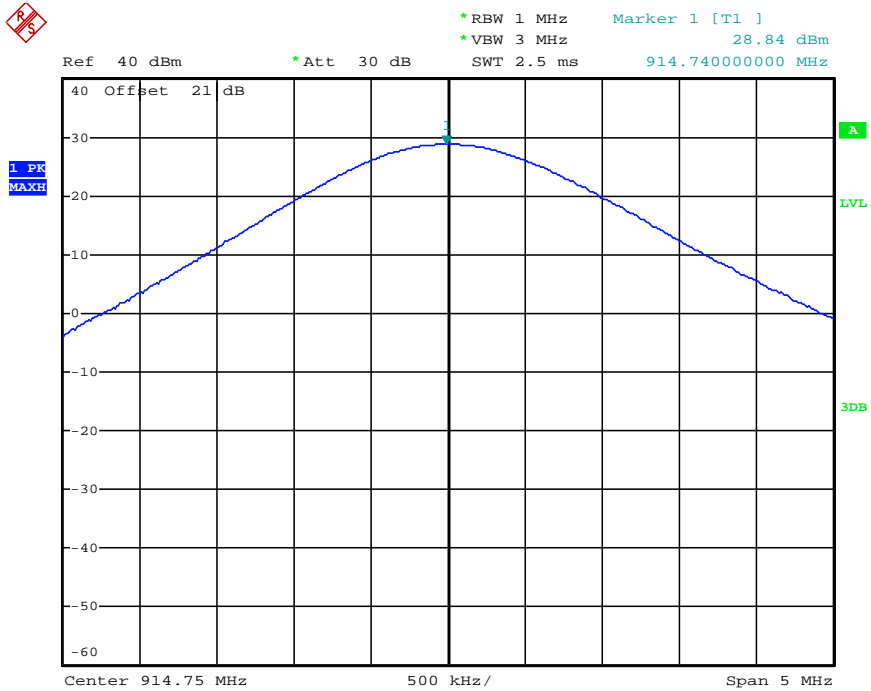

Date: 29.MAY.2013 12:20:29

High channel

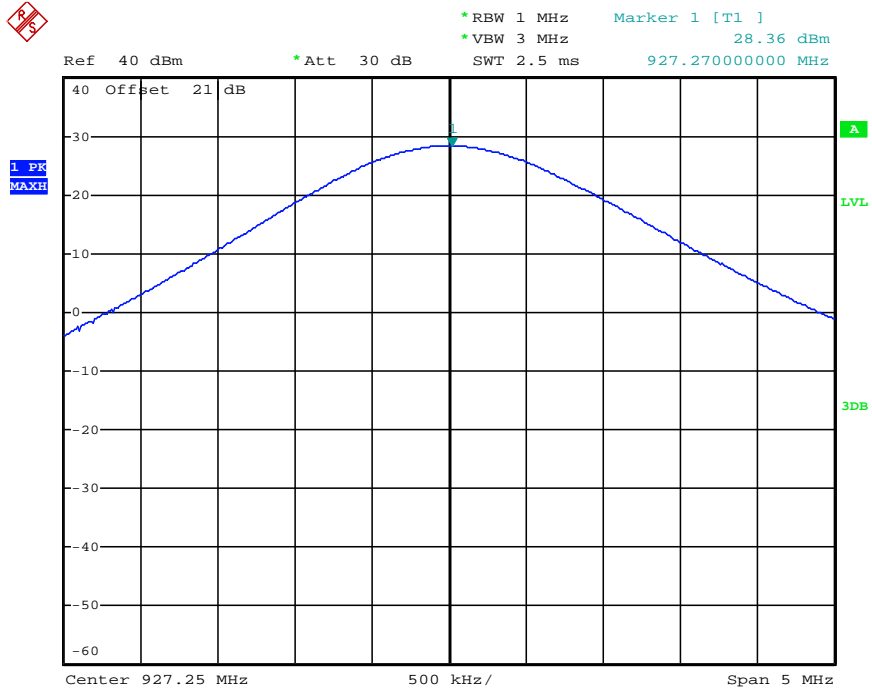

Date: 29.MAY.2013 12:23:55

4.5. 20dB Bandwidth

TEST CONFIGURATION

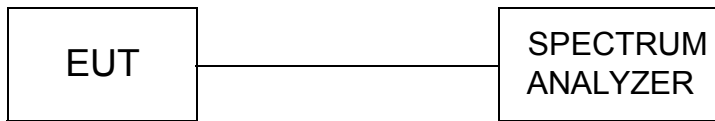

TEST PROCEDURE

The transmitter output was connected to the spectrum analyzer through an attenuator. The bandwidth of the fundamental frequency was measured by spectrum analyzer with 30 KHz RBW and 100KHz VBW.

The 20dB bandwidth is defined as the total spectrum the power of which is higher than peak power minus 20dB.

LIMIT

If the 20 dB bandwidth of the hopping channel is less than 250 kHz, the system shall use at least 50 hopping frequencies and the average time of occupancy on any frequency shall not be greater than 0.4 seconds within a 20 second period; if the 20 dB bandwidth of the hopping channel is 250 kHz or greater, the system shall use at least 25 hopping frequencies and the average time of occupancy on any frequency shall not be greater than 0.4 seconds within a 10 second period. The maximum allowed 20 dB bandwidth of the hopping channel is 500 kHz.

TEST RESULTS

Channel Frequency (MHz)	20dB Bandwidth (MHz)	Limit (MHz)	Verdict
902.75	0.142	0.250	PASS
914.75	0.140	0.250	PASS
927.25	0.134	0.250	PASS

Note: 1. The test results including the cable loss.

Photos of 20dB Bandwidth Measurement:

Low Channel

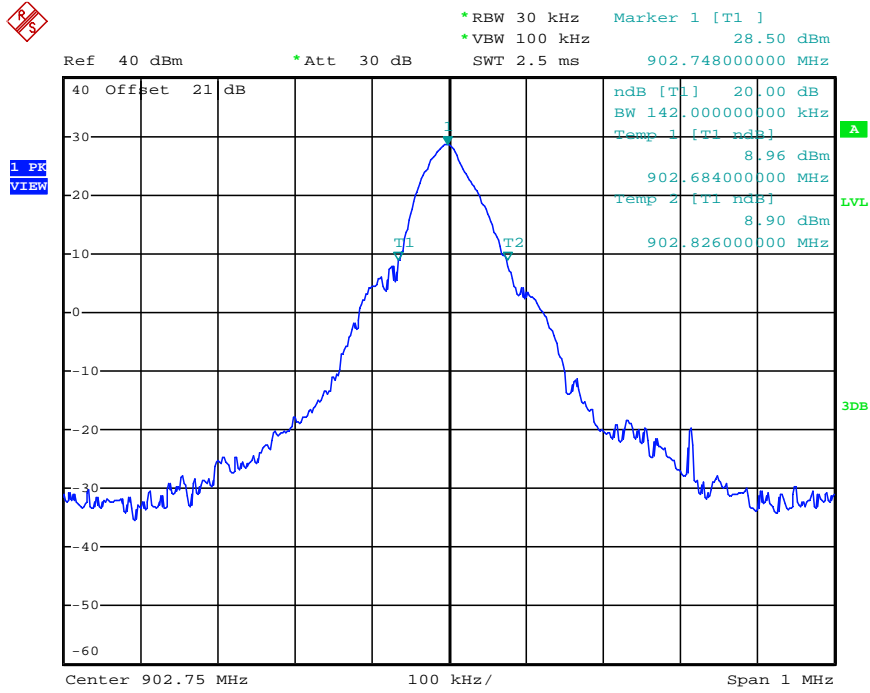

Date: 29.MAY.2013 15:00:00

Middle Channel

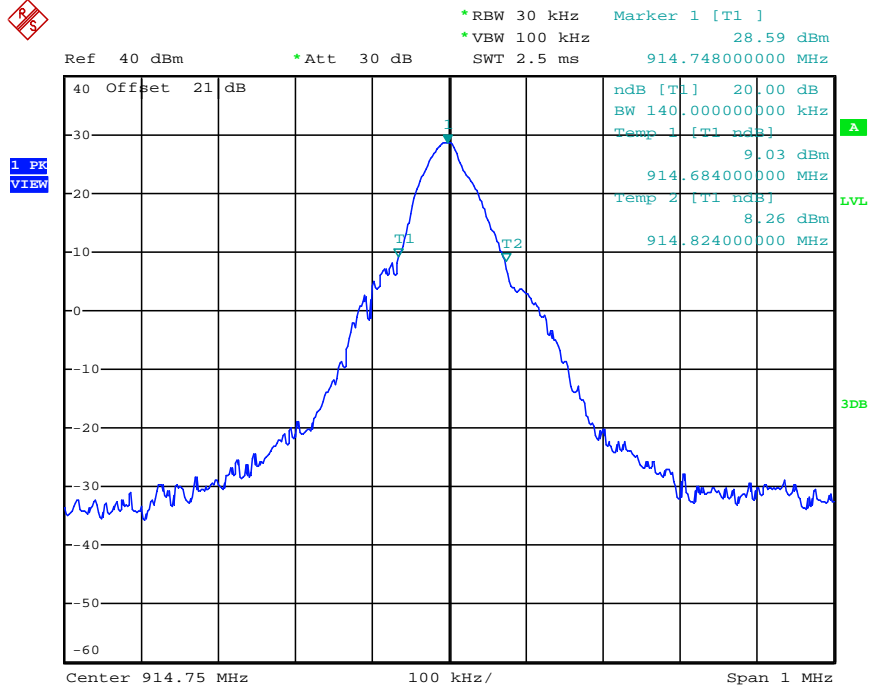

Date: 29.MAY.2013 15:11:29

High Channel

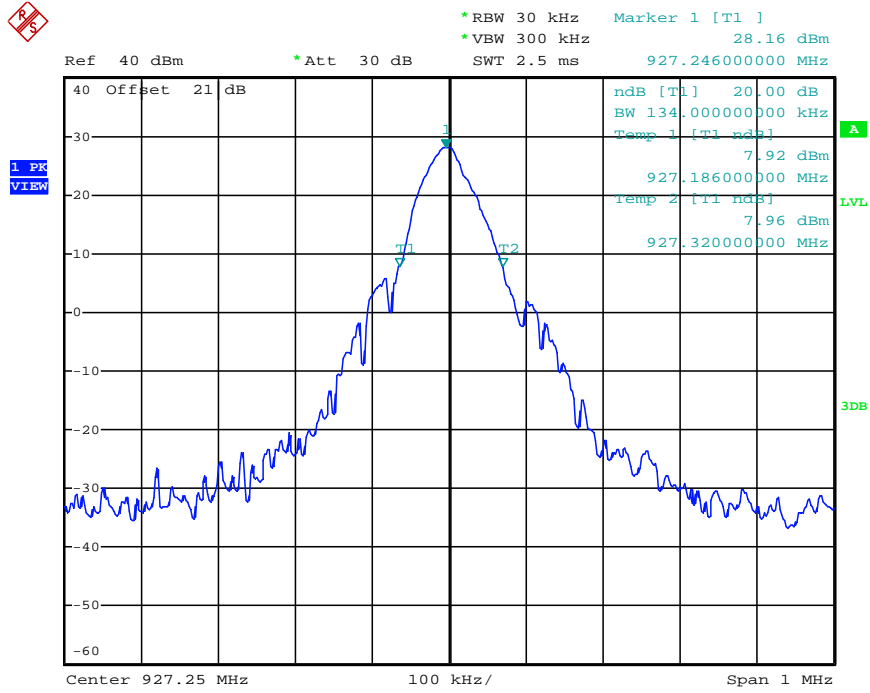

Date: 29.MAY.2013 15:05:43

4.6. Band Edge

Applicable Standard

In any 100 kHz bandwidth outside the frequency band in which the spread spectrum or digitally modulated intentional radiator is operating, the radio frequency power that is produced by the intentional radiator shall be at least 20 dB below that in the 100 kHz bandwidth within the band that contains the highest level of the desired power, based on either an RF conducted or a radiated measurement, provided the transmitter demonstrates compliance with the peak conducted power limits. If the transmitter complies with the conducted power limits based on the use of RMS averaging over a time interval, as permitted under paragraph (b)(3) of this section, the attenuation required under this paragraph shall be 30 dB instead of 20 dB. Attenuation below the general limits specified in §15.209(a) is not required. In addition, radiated emissions which fall in the restricted bands, as defined in §15.205(a), must also comply with the radiated emission limits specified in §15.209(a) (see §15.205(c)).

TEST PROCEDURE

1. Check the calibration of the measuring instrument using either an internal calibrator or a known signal from an external generator.
2. Remove the antenna from the EUT and then connect to a low loss RF cable from the antenna port to a EMI test receiver, then turn on the EUT and make it operate in transmitting mode. Then set it to Low Channel and High Channel within its operating range, and make sure the instrument is operated in its linear range.
3. Set both RBW and VBW of spectrum analyzer to 100 kHz with a convenient frequency span including 100kHz bandwidth from band edge, for Radiated emissions restricted band RBW=1MHz, VBW=3MHz.
4. Measure the highest amplitude appearing on spectral display and set it as a reference level. Plot the graph with marking the highest point and edge frequency.
5. Repeat above procedures until all measured frequencies were complete.

TEST RESULTS

EUT Channel	Delta peak to band emission (dBc)	Limit(dBc)	Verdict
1	-55.86	-20	PASS
50	-54.50	-20	PASS

Note: 1. The test results including the cable lose.

Photos of Band Edge Measurement:

Band Edge: Left Side

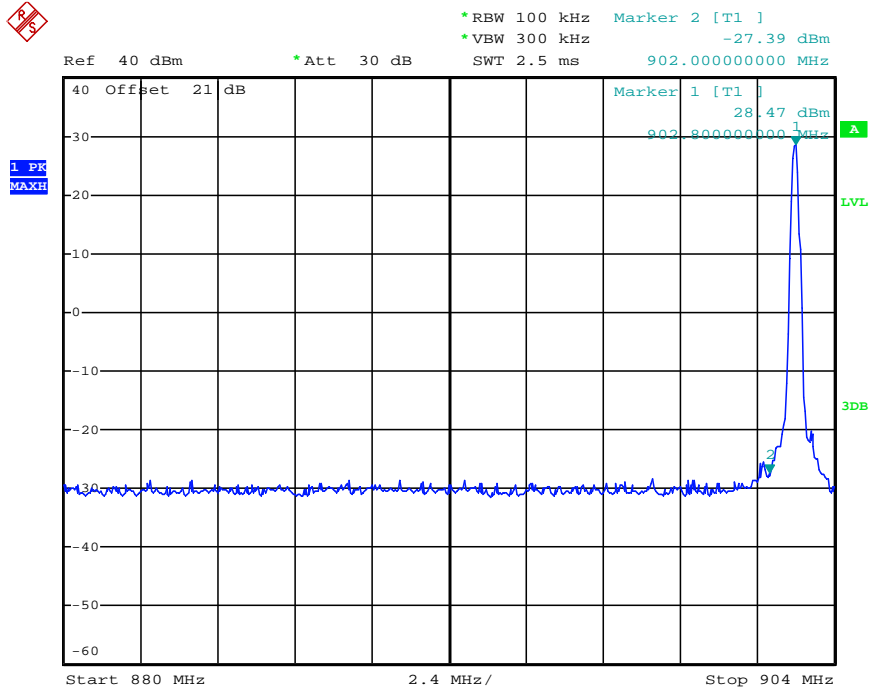

Date: 29.MAY.2013 15:01:53

Band Edge: Right Side

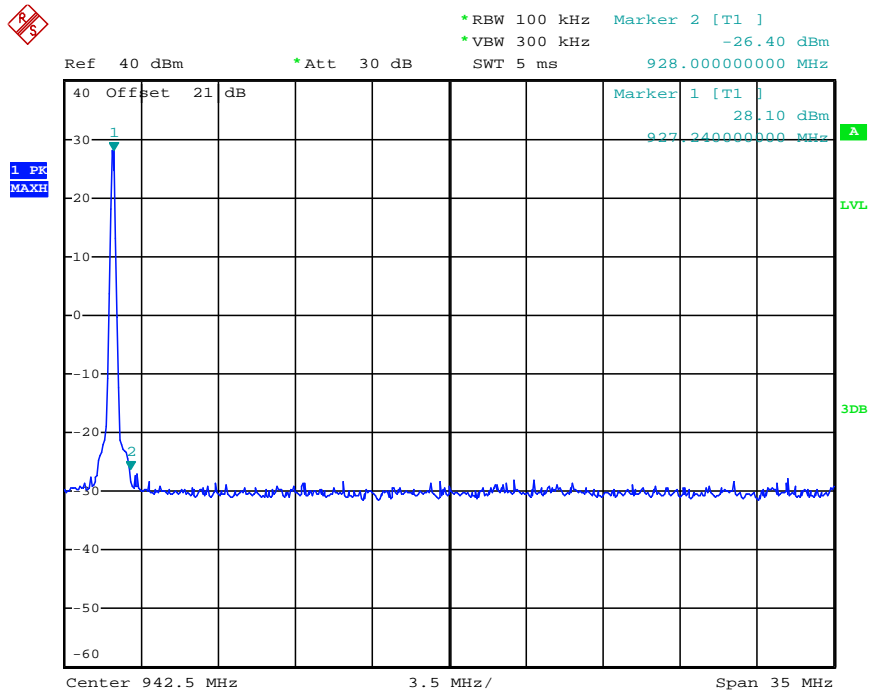

Date: 29.MAY.2013 15:07:02

4.7. Frequency Separation

TEST CONFIGURATION

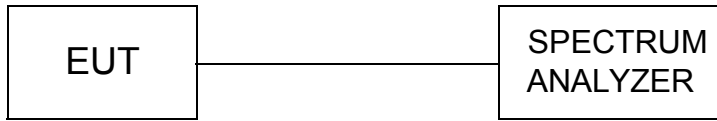

TEST PROCEDURE

The transmitter output was connected to the spectrum analyzer through an attenuator. The bandwidth of the fundamental frequency was measured by spectrum analyzer with 100 KHz RBW and 300KHz VBW.

LIMIT

According to 15.247(a)(1), frequency hopping systems shall have hopping channel carrier frequencies separated by minimum of 25KHz or the $2/3 \times 20\text{dB}$ bandwidth of the hopping channel, whichever is greater.

TEST RESULTS

Channel	Channel Frequency (MHz)	Channel Separation (MHz)	Limit (MHz)	Verdict
Low Channel	902.75	0.502	At least 25KHz or $2/3 \times 20\text{dB}$ bandwidth(0.095MHz)	PASS
Adjacency Channel	903.25			
Mid Channel	914.75	0.500	At least 25KHz or $2/3 \times 20\text{dB}$ bandwidth(0.093MHz)	PASS
Adjacency Channel	915.25			
High Channel	927.25	0.502	At least 25KHz or $2/3 \times 20\text{dB}$ bandwidth(0.089MHz)	PASS
Adjacency Channel	926.75			

Note: 1. The test results including the cable loss.

Photos of Frequency separation Measurement:

Low channel

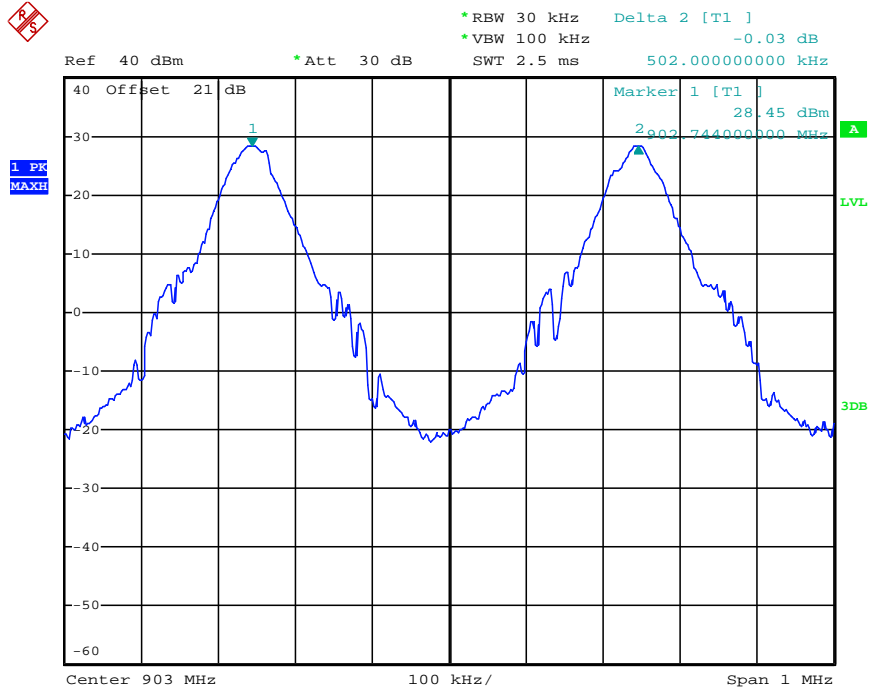

Date: 29.MAY.2013 15:29:22

Middle channel

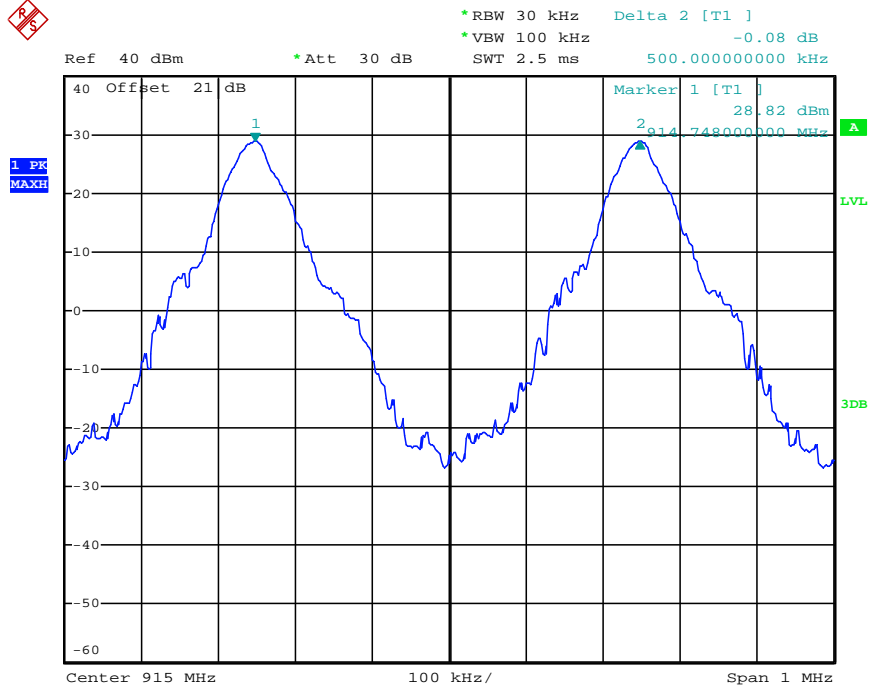

Date: 29.MAY.2013 15:27:58

High channel

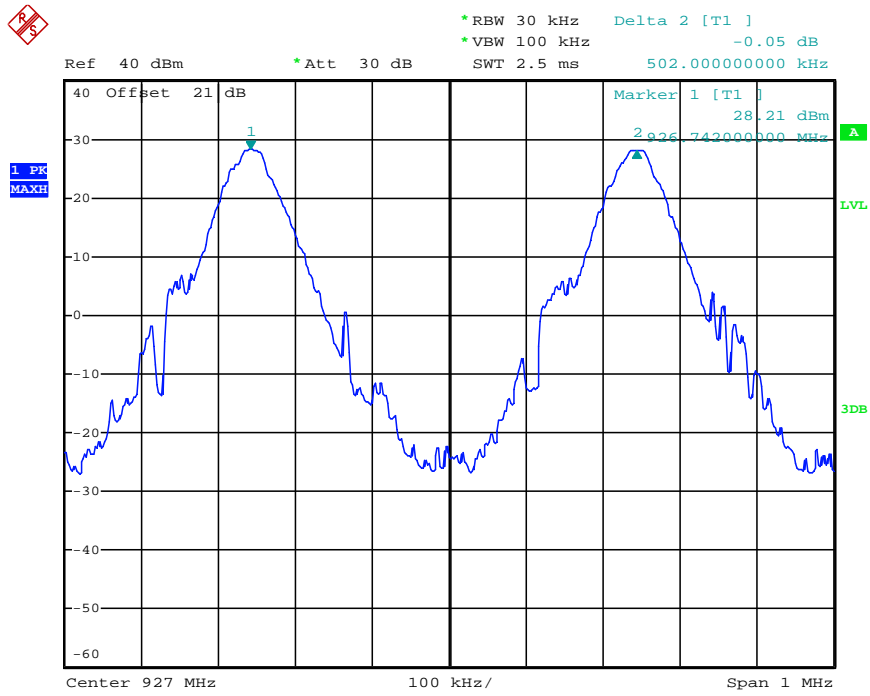

Date: 29.MAY.2013 15:31:34

4.8. Number of hopping frequency

TEST CONFIGURATION

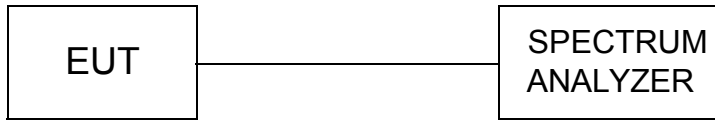

TEST PROCEDURE

The transmitter output was connected to the spectrum analyzer through an attenuator. Set spectrum analyzer start 902MHz to 928MHz with 100 KHz RBW and 300KHz VBW.

LIMIT

If the 20 dB bandwidth of the hopping channel is less than 250 kHz, the system shall use at least 50 hopping frequencies and the average time of occupancy on any frequency shall not be greater than 0.4 seconds within a 20 second period; if the 20 dB bandwidth of the hopping channel is 250 kHz or greater, the system shall use at least 25 hopping frequencies and the average time of occupancy on any frequency shall not be greater than 0.4 seconds within a 10 second period. The maximum allowed 20 dB bandwidth of the hopping channel is 500 kHz.

TEST RESULTS

Hopping Channel Frequency Range (MHz)	Number of Hopping Channel	Limit	Verdict
902-928	50	≥50	PASS

Note: 1. The test results including the cable lose.

Photos of Number of hopping channel Measurement:

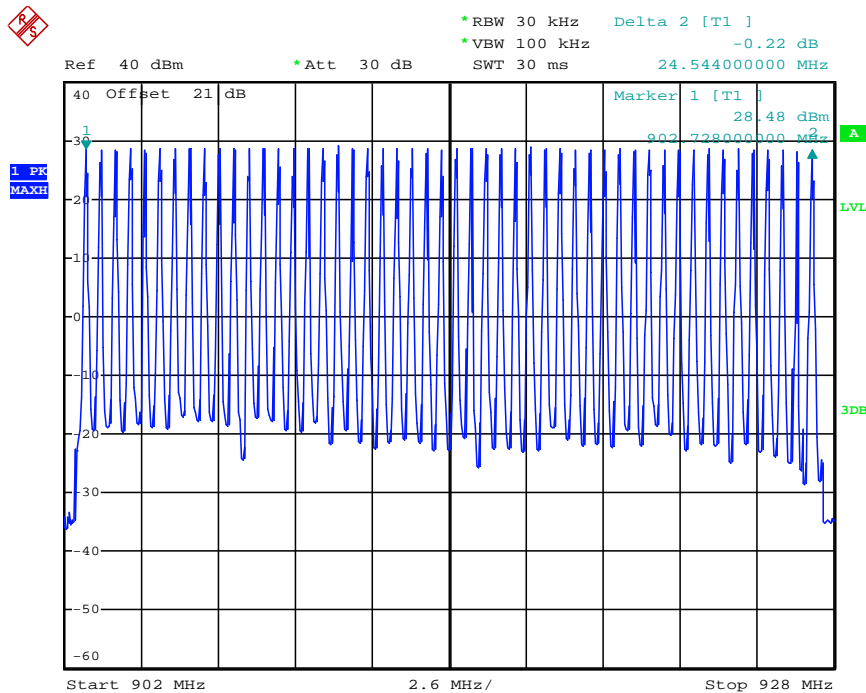

4.9. Time Of Occupancy(Dwell Time)

TEST CONFIGURATION

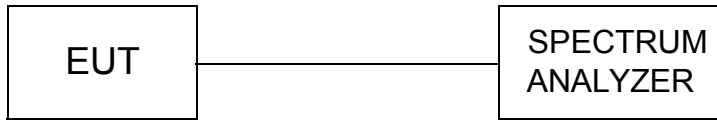

TEST PROCEDURE

The transmitter output was connected to the spectrum analyzer through an attenuator. Set center frequency of spectrum analyzer=operating frequency with 1MHz RBW and 3MHz VBW, Span 0Hz.

LIMIT

For frequency hopping systems operating in the 902–928 MHz band: if the 20 dB bandwidth of the hopping channel is less than 250 kHz, the system shall use at least 50 hopping frequencies and the average time of occupancy on any frequency shall not be greater than 0.4 seconds within a 20 second period; if the 20 dB bandwidth of the hopping channel is 250 kHz or greater, the system shall use at least 25 hopping frequencies and the average time of occupancy on any frequency shall not be greater than 0.4 seconds within a 10 second period. The maximum allowed 20 dB bandwidth of the hopping channel is 500 kHz.

TEST RESULTS

Photos of Dwell time Measurement

In the connection mode RFID uses 50 channels,As defined in 15.247,a 1 l,the limit for time of occupancy is 0.4s over time of 20s.

Results:

In measurement time of 20s,total of 10 transmissions occurred. The duration of one transmission was (3.4+5.2+18.0)ms.Based on these measurements the transmitter operated $10 \times (3.4+5.2+18.0) \text{ms} = 0.266 \text{s}$ during the 20s period.The measurement result $0.266 \text{s} < 0.4 \text{s}$,The test result is pass.

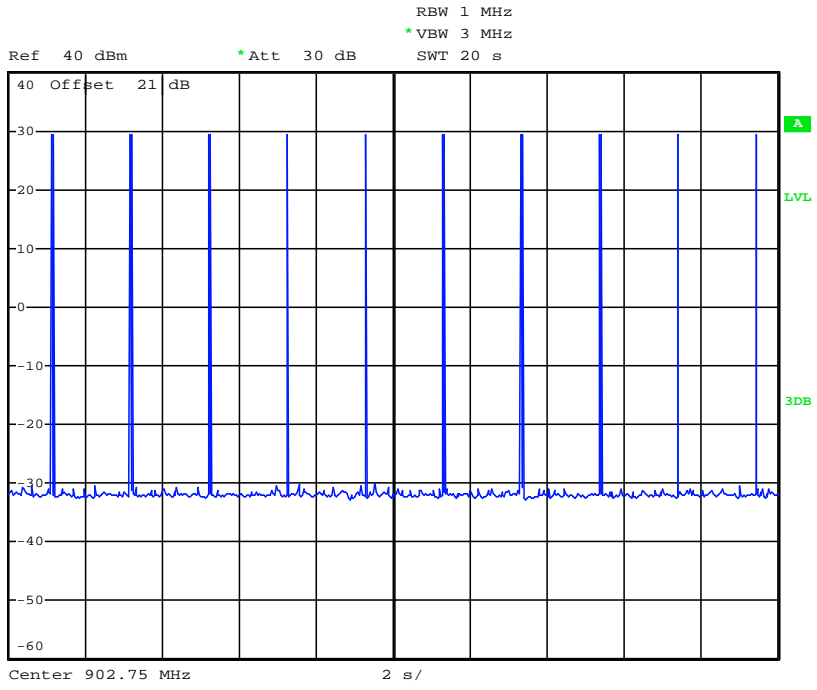

Date: 29.MAY.2013 16:11:13

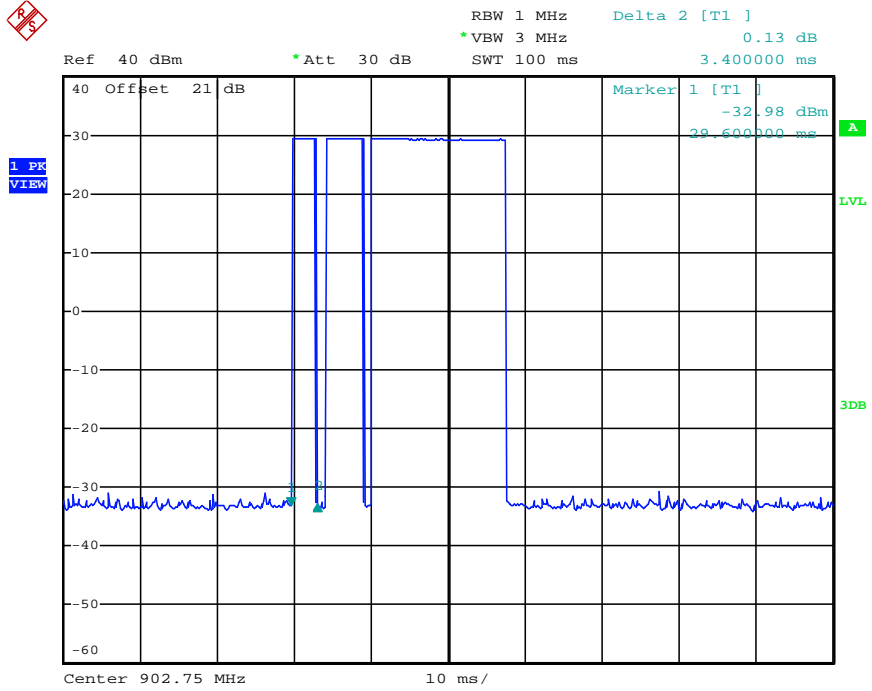

Date: 29.MAY.2013 16:12:23

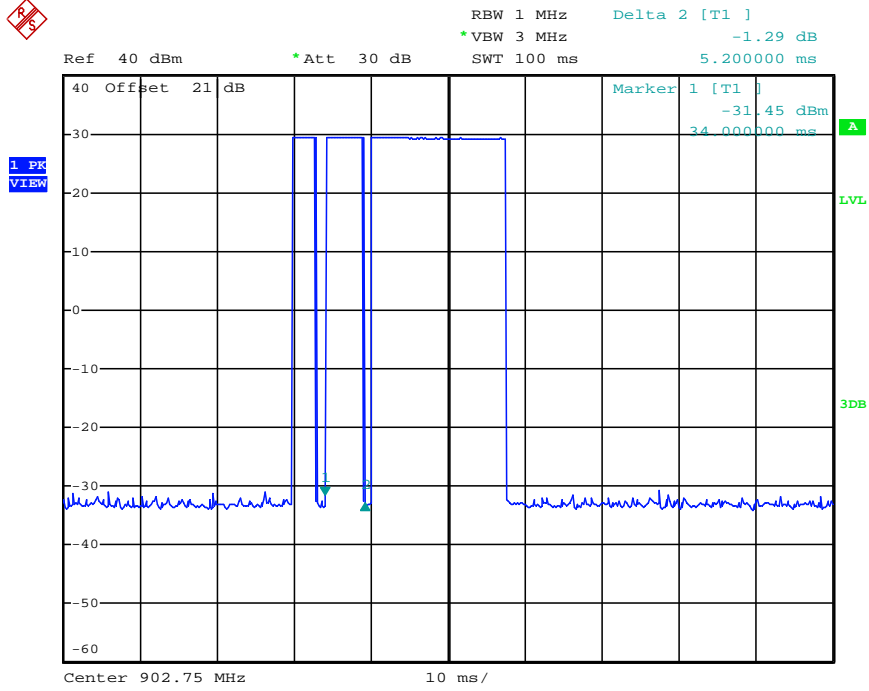

Date: 29.MAY.2013 16:16:12

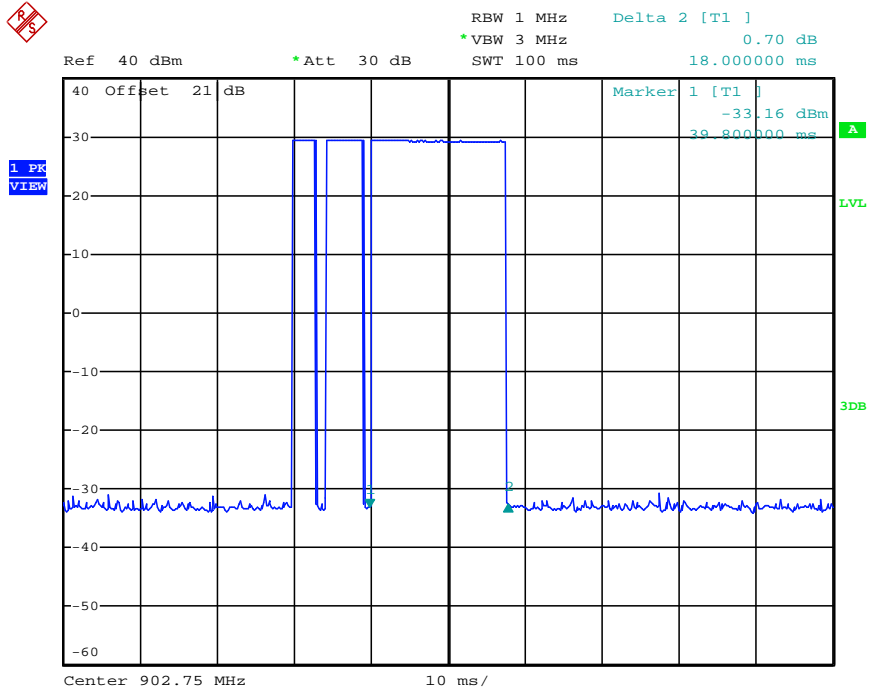

Date: 29.MAY.2013 16:16:54

4.10. Receiver spurious Emissions

TEST APPLICABLE

The field strength is calculated by adding the Antenna Factor and Cable Factor and subtracting the Amplifier Gain and Duty Cycle Correction Factor (if any) from the measured reading. The basic equation with a sample calculation is as follows:

$$FS = RA + AF + CL - AG$$

Where FS = Field Strength	CL = Cable Attenuation Factor (Cable Loss)
RA = Reading Amplitude	AG = Amplifier Gain
AF = Antenna Factor	

TEST CONFIGURATION

Frequency range 30MHz – 1000MHz

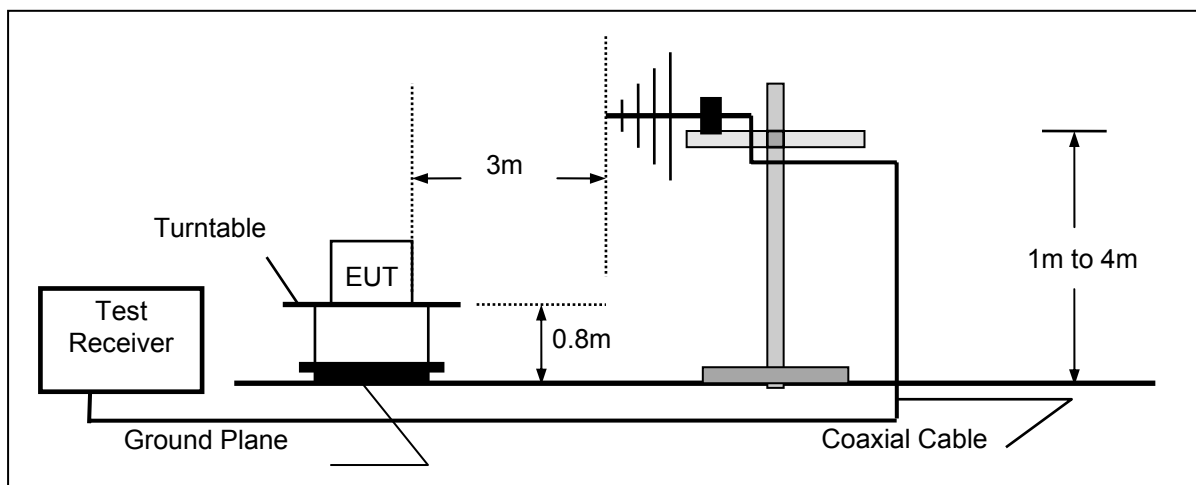

Frequency range above 1GHz-25GHz

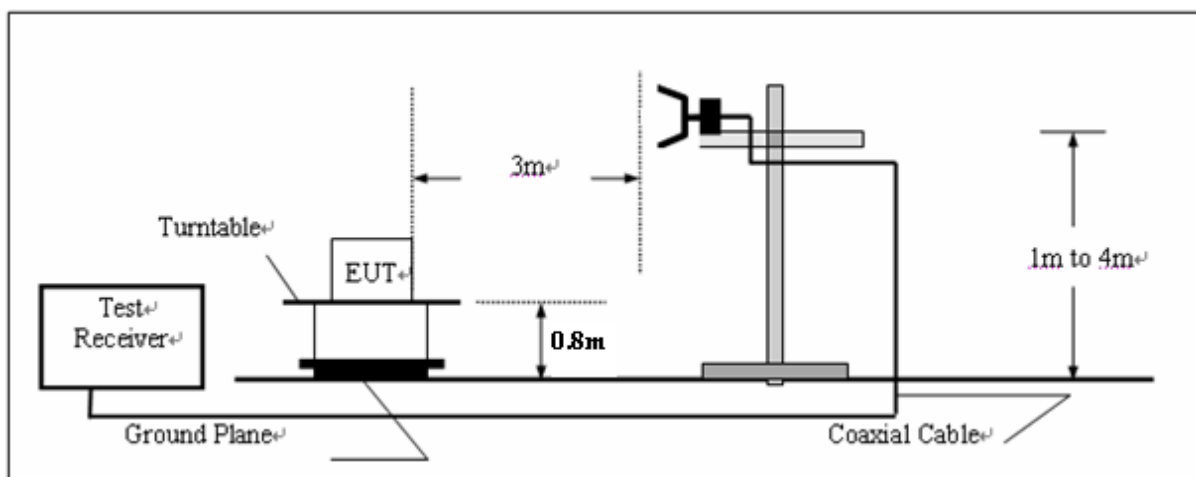

TEST PROCEDURE

- 1 The EUT was placed on a turn table which is 0.8m above ground plane.
- 2 Maximum procedure was performed by raising the receiving antenna from 1m to 4m and rotating the turn table from 0° to 360° to acquire the highest emissions from EUT
- 3 And also, each emission was to be maximized by changing the polarization of receiving antenna both horizontal and vertical.
- 4 Repeat above procedures until all frequency measurements have been completed.

RECEIVER RADIATED SPOUIOUS LIMIT

For unintentional device, according to § 15.109(a), except for Class A digital devices, the field strength of radiated emissions from unintentional radiators at a distance of 3 meters shall not exceed the following values:

Frequency (MHz)	Distance (Meters)	Radiated dBμV/m)	Radiated (μV/m)
30-88	3	40.0	100
88-216	3	43.5	150
216-960	3	46.0	200
Above 960	3	54.0	500

For intentional device, according to § 15.209(a), the general requirement of field strength of radiated emissions from intentional radiators at a distance of 3 meters shall not exceed the above table.

TEST RESULTS

The Radiated Measurement are performed to the three channels (the high channel, the middle channel and the low channel), the datum recorded below is the worst case for each channel separation;and the EUT shall be scanned from 30 MHz to the 5th harmonic of the highest oscillator frequency in the digital devices or 1 GHz whichever is higher.

TEST RESULTS

Below 1GHz

SWEEP TABLE: "test (30M-1G)"

Short Description:		Field Strength			
Start	Stop	Detector	Meas. Time	IF Bandw.	Transducer
Frequency	Frequency	MaxPeak	Coupled	120 kHz	HL562
30.0 MHz	1.0 GHz				

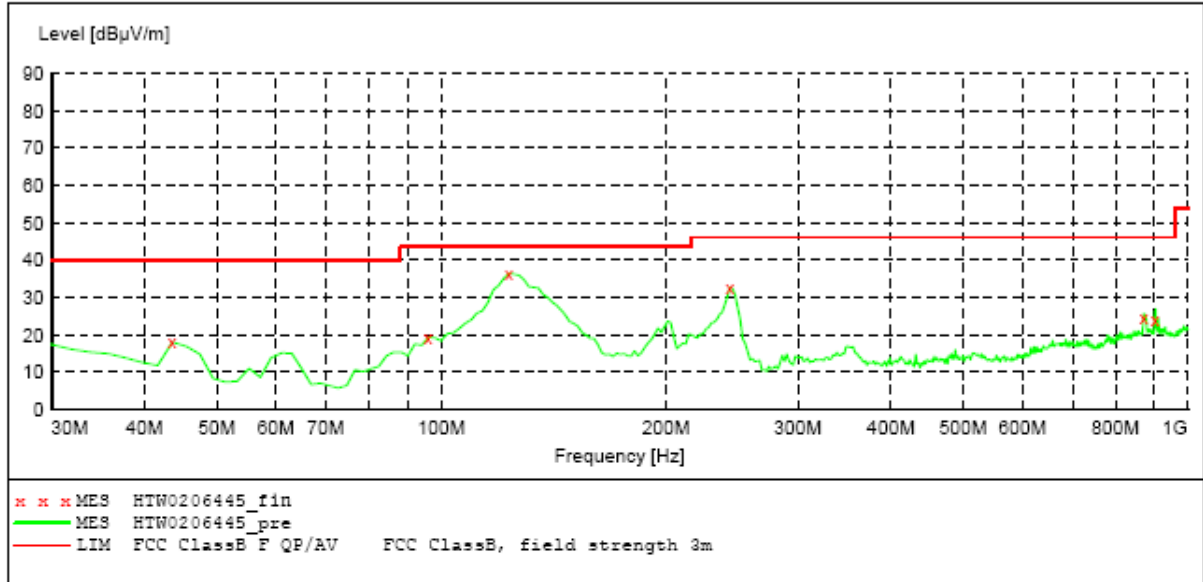

MEASUREMENT RESULT: "HTW0206445_fin"

2/22/2013 1:56PM

Frequency MHz	Level dBuV/m	Transd dB	Limit dBuV/m	Margin dB	Det.	Height cm	Azimuth deg	Polarization
43.580000	18.10	-18.3	40.0	21.9	QP	100.0	251.00	HORIZONTAL
95.960000	19.30	-20.1	43.5	24.2	QP	100.0	357.00	HORIZONTAL
123.120000	36.40	-19.5	43.5	7.1	QP	100.0	231.00	HORIZONTAL
243.400000	32.70	-18.8	46.0	13.3	QP	100.0	125.00	HORIZONTAL
871.960000	24.70	-6.9	46.0	14.3	QP	100.0	56.00	HORIZONTAL
902.750000	24.00	-7.3	46.0	14.0	QP	100.0	111.00	HORIZONTAL

SWEEP TABLE: "test (30M-1G)"

Short Description:		Field Strength			
Start	Stop	Detector	Meas. Time	IF Bandw.	Transducer
30.0 MHz	1.0 GHz	MaxPeak	Coupled	120 kHz	HL562

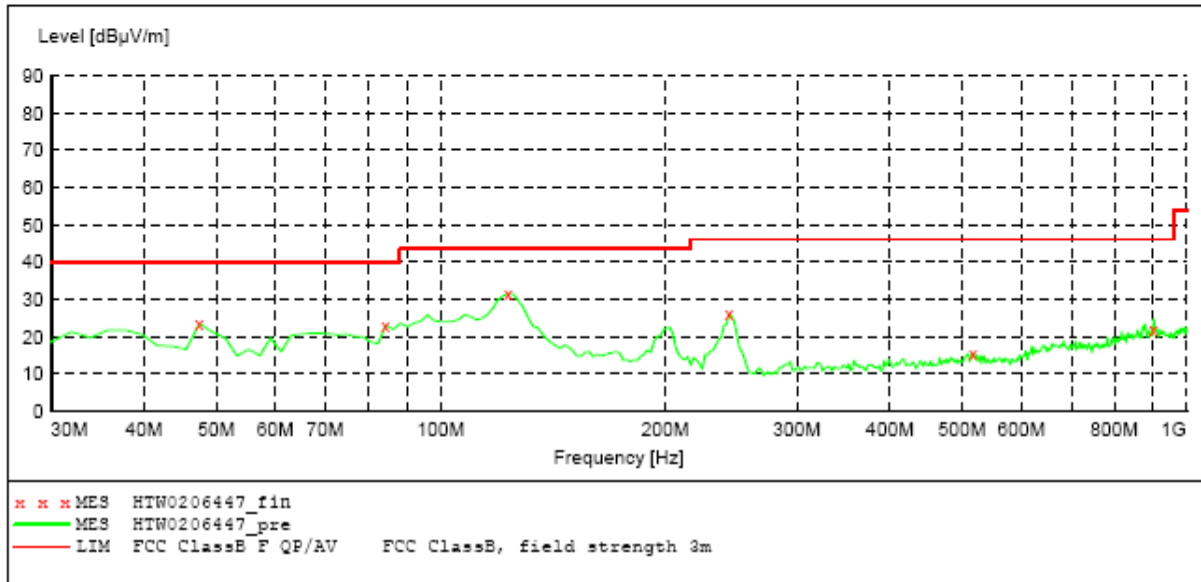

MEASUREMENT RESULT: "HTW0206447_fin"

2/22/2013 2:18PM

Frequency MHz	Level dBuV/m	Transd dB	Limit dBuV/m	Margin dB	Det.	Height cm	Azimuth deg	Polarization
47.460000	23.50	-20.9	40.0	16.5	QP	100.0	176.00	VERTICAL
84.320000	23.10	-21.3	40.0	16.9	QP	100.0	282.00	VERTICAL
123.120000	31.50	-19.5	43.5	12.0	QP	100.0	299.00	VERTICAL
243.400000	26.10	-18.8	46.0	19.9	QP	100.0	166.00	VERTICAL
516.940000	15.50	-13.0	46.0	30.5	QP	100.0	350.00	VERTICAL
902.750000	22.00	-7.3	46.0	24.0	QP	100.0	220.00	VERTICAL

*Within measurement uncertainty.

Above 1GHz

SWEEP TABLE: "test (1G-18G) P"

Short Description: EN 55022 Field Strength
 Start Stop Detector Meas. IF Transducer
 Frequency Frequency Time Bandw.
 1.0 GHz 18.0 GHz MaxPeak Coupled 1 MHz HF906
 Average

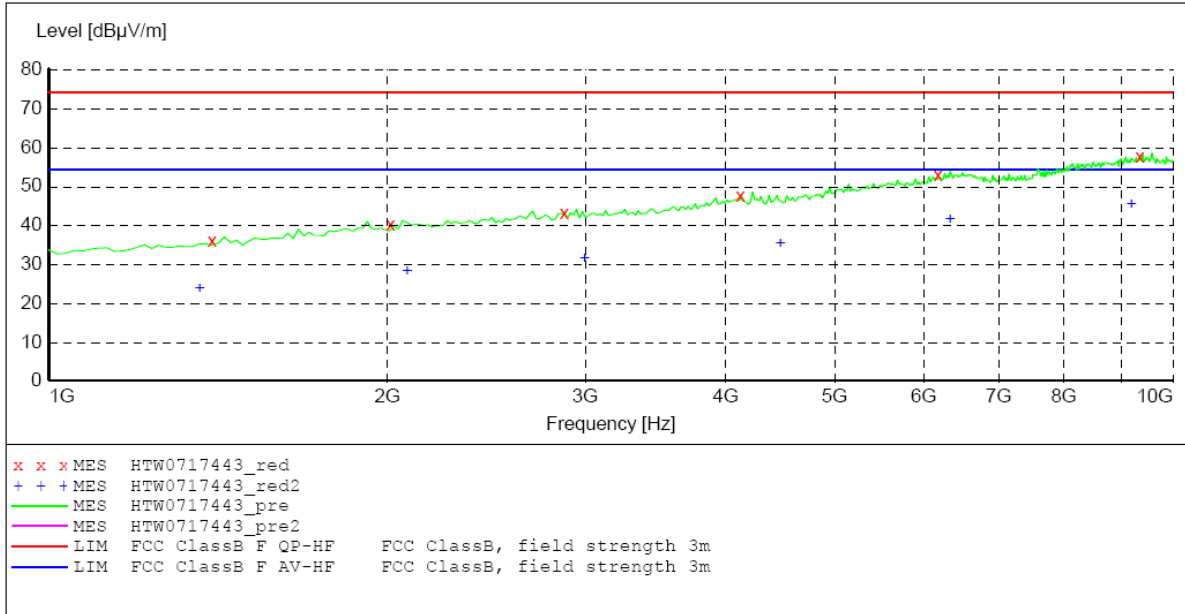

MEASUREMENT RESULT: "HTW0717443_red"

7/17/2012 8:22PM

Frequency MHz	Level dBµV/m	Transd dB	Limit dBµV/m	Margin dB	Det.	Height cm	Azimuth deg	Polarization
1432.865731	36.80	-10.3	74.0	37.2	PK	100.0	40.00	VERTICAL
2064.128257	41.00	-6.3	74.0	33.0	PK	100.0	201.00	VERTICAL
2947.895792	43.90	-3.4	74.0	30.1	PK	100.0	341.00	VERTICAL
4228.456914	48.40	-0.5	74.0	25.6	PK	100.0	294.00	VERTICAL
6338.677355	53.60	4.1	74.0	20.4	PK	100.0	114.00	VERTICAL
9585.170341	58.40	12.0	74.0	15.6	PK	100.0	274.00	VERTICAL

MEASUREMENT RESULT: "HTW0717443_red2"

7/17/2012 8:22PM

Frequency MHz	Level dBµV/m	Transd dB	Limit dBµV/m	Margin dB	Det.	Height cm	Azimuth deg	Polarization
1396.793587	24.40	-10.4	54.0	29.6	AV	100.0	341.00	VERTICAL
2136.272545	29.00	-6.0	54.0	25.0	AV	100.0	34.00	VERTICAL
3074.148297	32.20	-3.2	54.0	21.8	AV	100.0	176.00	VERTICAL
4589.178357	35.90	-0.3	54.0	18.1	AV	100.0	238.00	VERTICAL
6501.002004	42.30	4.8	54.0	11.7	AV	100.0	333.00	VERTICAL
9422.845691	46.10	11.8	54.0	7.9	AV	100.0	140.00	VERTICAL

SWEEP TABLE: "test (1G-18G) P"

Short Description: EN 55022 Field Strength
 Start Stop Detector Meas. IF Transducer
 Frequency Frequency Time Bandw.
 1.0 GHz 18.0 GHz MaxPeak Coupled 1 MHz HF906
 Average

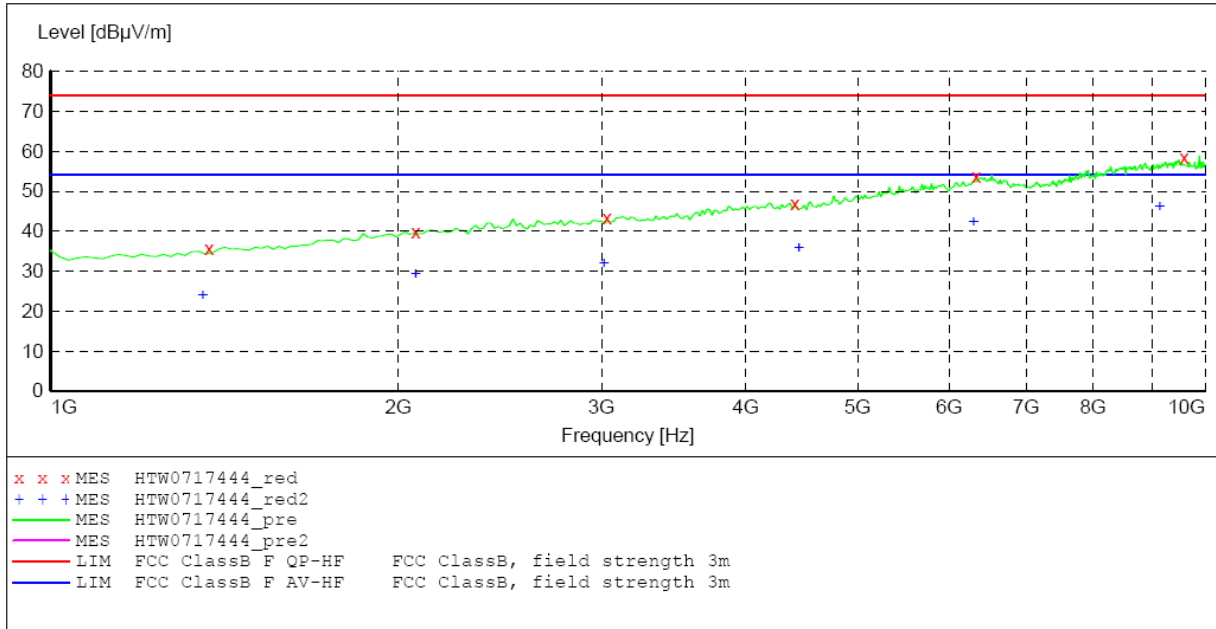

MEASUREMENT RESULT: "HTW0717444_red"

7/17/2012 8:25PM

Frequency MHz	Level dBµV/m	Transd dB	Limit dBµV/m	Margin dB	Det.	Height cm	Azimuth deg	Polarization
1414.829659	35.90	-10.4	74.0	38.1	PK	100.0	74.00	HORIZONTAL
2136.272545	40.20	-6.0	74.0	33.8	PK	100.0	165.00	HORIZONTAL
3128.256513	43.60	-3.1	74.0	30.4	PK	100.0	183.00	HORIZONTAL
4553.106212	47.30	-0.5	74.0	26.7	PK	100.0	0.00	HORIZONTAL
6537.074148	53.90	4.7	74.0	20.1	PK	100.0	55.00	HORIZONTAL
9891.783567	58.80	12.0	74.0	15.2	PK	100.0	121.00	HORIZONTAL

MEASUREMENT RESULT: "HTW0717444_red2"

7/17/2012 8:25PM

Frequency MHz	Level dBµV/m	Transd dB	Limit dBµV/m	Margin dB	Det.	Height cm	Azimuth deg	Polarization
1396.793587	24.00	-10.4	54.0	30.0	AV	100.0	245.00	HORIZONTAL
2136.272545	29.40	-6.0	54.0	24.6	AV	100.0	106.00	HORIZONTAL
3110.220441	32.10	-3.1	54.0	21.9	AV	100.0	38.00	HORIZONTAL
4589.178357	35.90	-0.3	54.0	18.1	AV	100.0	31.00	HORIZONTAL
6501.002004	42.40	4.8	54.0	11.6	AV	100.0	295.00	HORIZONTAL
9422.845691	46.30	11.8	54.0	7.7	AV	100.0	215.00	HORIZONTAL

*Within measurement uncertainty.

4.11. Antenna Requirement

Standard Applicable

For intentional device, according to FCC 47 CFR Section 15.203, an intentional radiator shall be designed to ensure that no antenna other than that furnished by the responsible party shall be used with the device.

And according to FCC 47 CFR Section 15.247 (c), if transmitting antennas of directional gain greater than 6dBi are used, the power shall be reduced by the amount in dB that the directional gain of the antenna exceeds 6dBi.

Refer to statement below for compliance.

The manufacturer may design the unit so that the user can replace a broken antenna, but the use of a standard antenna jack or electrical connector is prohibited. Further, this requirement does not apply to intentional radiators that must be professionally installed.

Antenna Connected Construction

The antenna used in this product is a External Antenna .The maximum Gain of the antenna was 7dBi. Detail please see the photos as following:



5. Test Setup Photos of the EUT

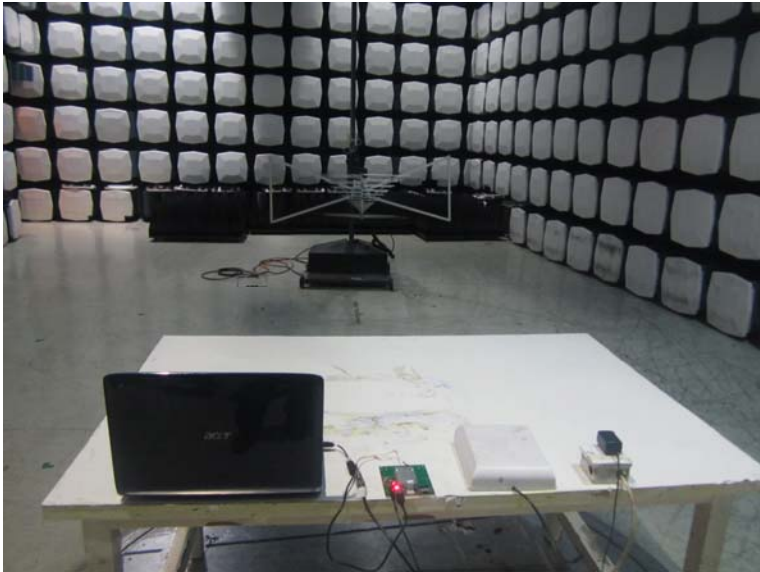
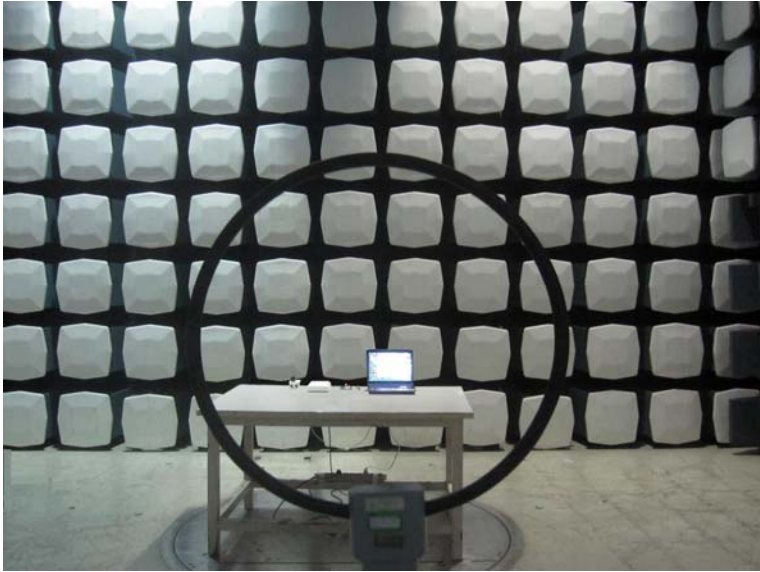



6. External and Internal Photos of the EUT

External Photos

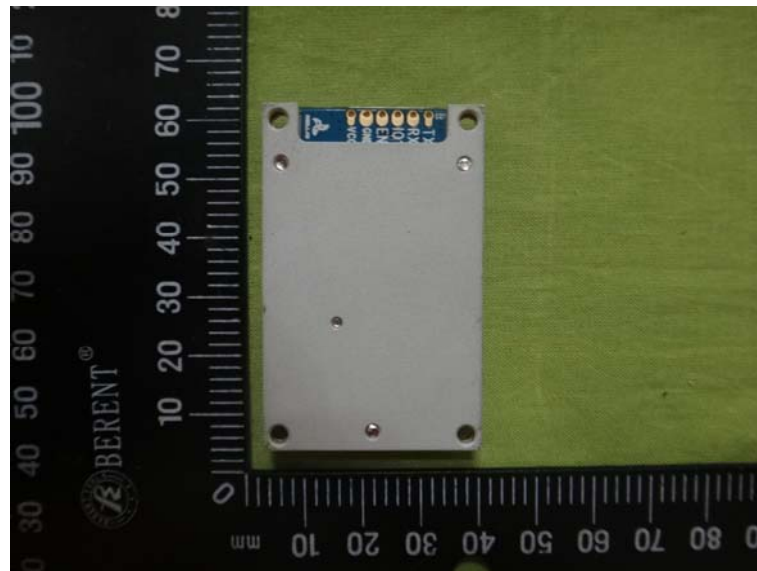
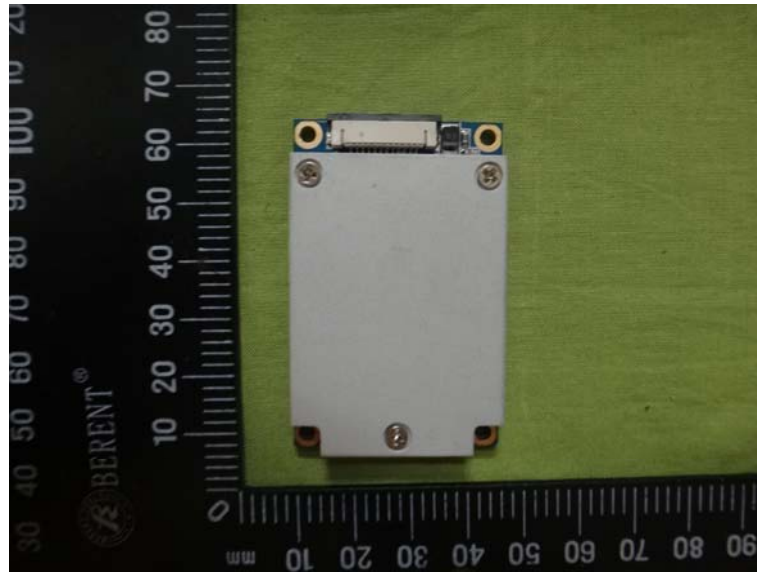

Internal Photos

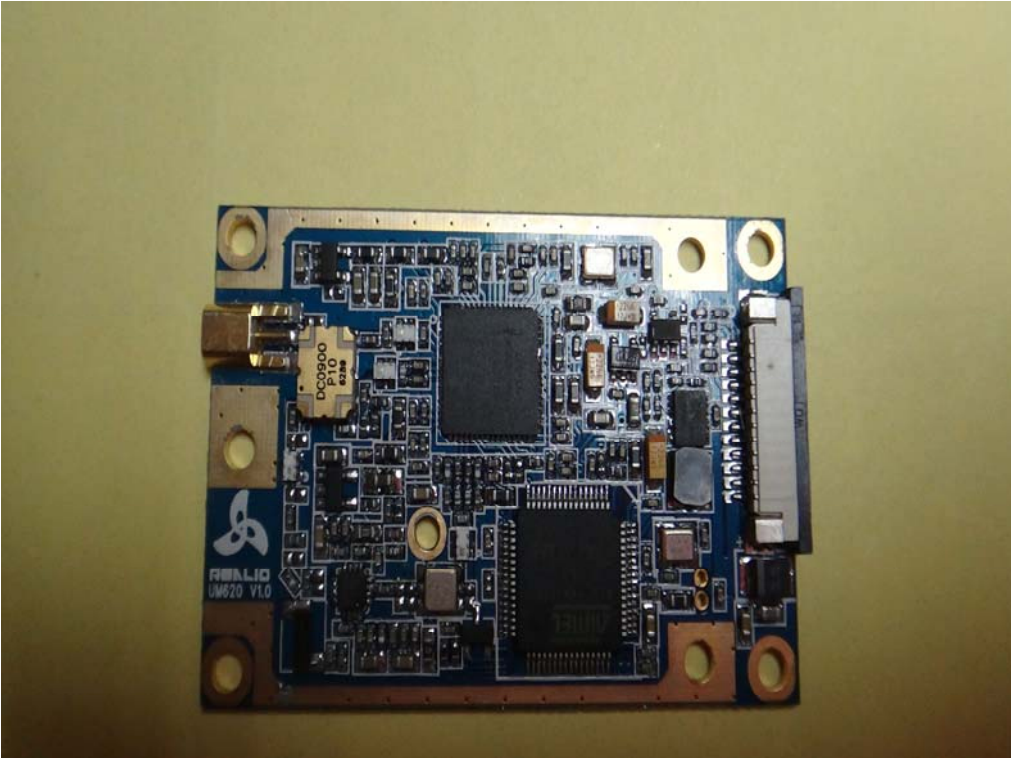

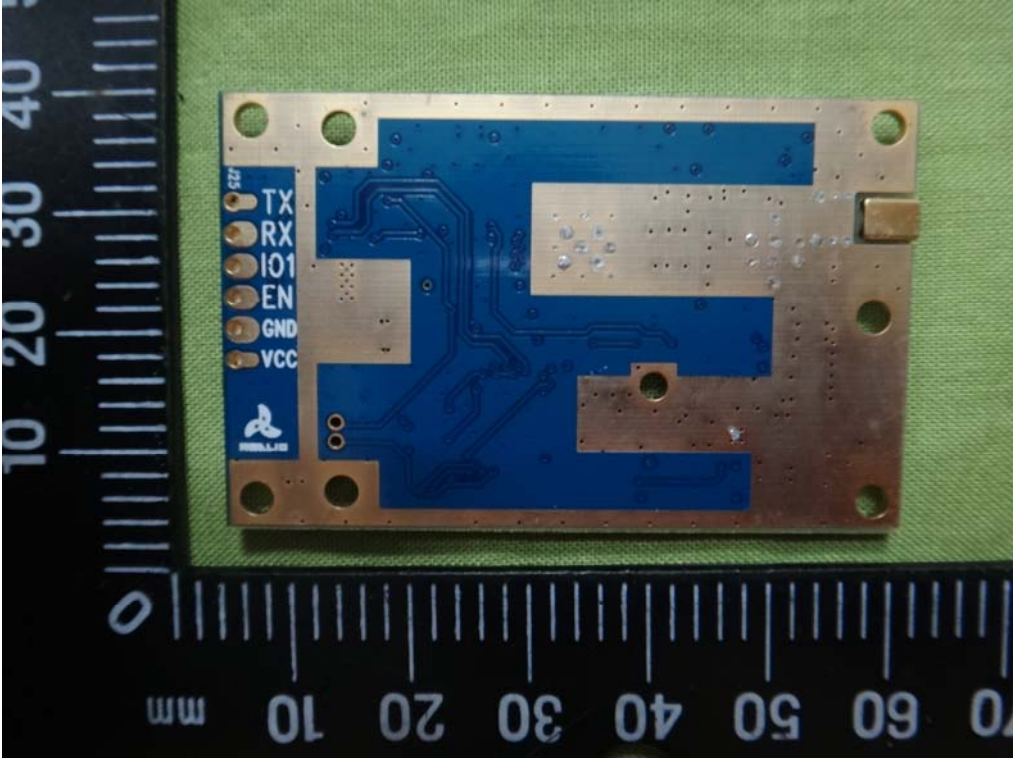

.....End of Report.....