



4655 Great America Parkway
Santa Clara, California 95054
www.nortelnetworks.com

FCC Part 15.247 Certification Application

Industrie Canada RSS210 Certification

**EMI Test Report
and
Technical Documentation
on
Nortel 802.11 Access Point.
Models: 2231 & 2231 INT**

FCC ID: [RVW2231](#)

Prepared by:

David Waitt
202 Calvert Drive #217
Cupertino, Ca. 95014
david@waitt.us
(408) 832 7053

Table of Contents

Section	Page
General information-----	3
Detailed product information-----	4
Results summary-----	5
Test facilities-----	6
Test Equipment-----	7
Test methods-----	8
Test Results	
Maximum power at RF Output-----	10
6dB Bandwidth-----	13
Power spectral density-----	17
Out of band emissions -----	21
Radiated emissions in restricted bands-----	23
Radiated emissions in restricted bands (band edge)-----	26
AC Line conducted Emissions -----	31

General Information

Unit(s) Under Test: Nortel 802.11 Access Point (AP)
Model: 2231
2231 INT
Product Description: IEEE 802.11 A/B/G Access point

FCC ID: RVW2231

Tested For: Nortel Networks
4655 Great America Parkway
Santa Clara, CA 95054, USA

Tested At: Elliott Laboratories
684 West Maude Ave
Sunnyvale, CA 94086

Tested By: Juan Martinez, Sr. Test Engineer, Elliott Laboratories
Chris Byleckie, Test Engineer, Elliott Laboratories
Trinh Waitt, (Independent Consultant for Nortel)

Test Specifications: FCC CFR 47, Part 15.247, 2.4 GHz DSSS

Test Date: Nov 2003

Requested Certification: Part 15.247 Certification

Detailed Product Information

The Nortel radio is an IEEE 802.11 B/G Access point (AP) intended to be professionally installed and configured in corporate and industrial environments.

The device utilizes a mini PCI module manufactured by an outside vendor. The manufacturer of the module has received FCC modular approval. The Nortel access point uses the module with a higher gain antenna than was certified for use with the module, therefore Nortel is applying for their own grant.

The modules incorporated into the access point radio are IEEE802.11 A/B/G mini PCI modules. However the functionality of the module is determined by the mini PCI slot in which the module is inserted. (See internal photos) There are two slots within the access point, 802.11 A and 802.11 B/G. In the case of the B/G access point, the module is inserted into the B/G slot, therefore the A/B/G module functions ONLY as 802.11 B/G. The user cannot modify this selectivity behavior via the configuration software.

INTERNAL ANTENNA VERSION

The AP utilizes integral antennas on the 802.11 B/G band. The access point effectively includes only a single 2.4GHz patch antenna, however, there are actually two 2.4 GHz antennas internal to the access point chassis. The module switches rapidly between the two antennas and when a signal is detected, the access point uses the antenna offering the best transmission characteristics. At any one time, there is only one antenna connected to the internal PCI module.

The effective gain of the 2.4 GHz internal antenna path (the antenna switch and the antenna itself) is 6.8dBi. The diagrams below outline the RF path from the output of the mini PCI module to the integral antennas within the access point. In the internal antenna version shown below, the software prohibits the switching of the FET antenna switches.

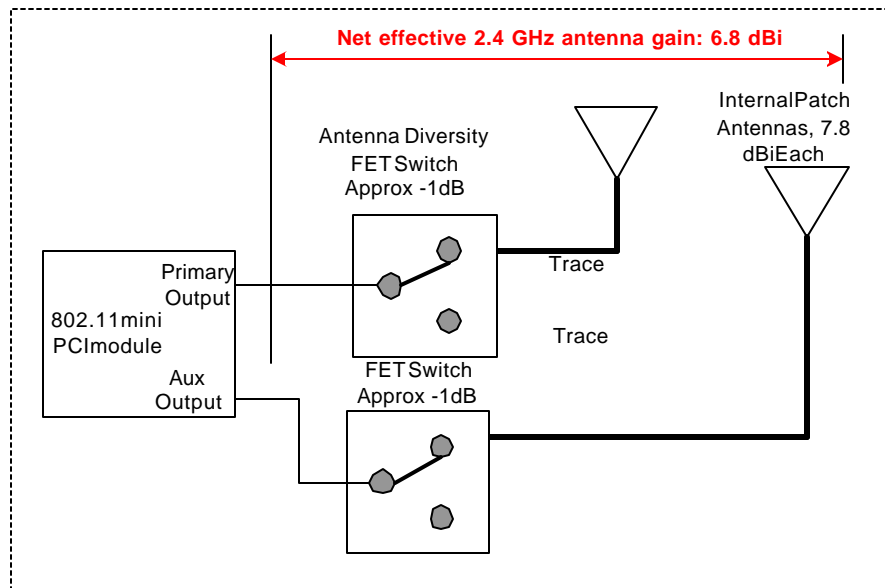

2.4 GHz RF Block Diagram (Internal Antenna Version)

INTERNAL/EXTERNAL ANTENNA VERSION

Additionally, there is a version of the access point which allows connection of external antennas. When External antennas are connected to the access point, the configuration software switches the internal antenna switches into the EXT position. The antenna diversity functionality described earlier works in the same manor for the external antennas. The external antennas used with the access point must be "patch" type antennas and have a net effective gain (antenna gain - cable loss) equal to 6.8 dBi or less. At any one time, ONLY the internal or external antennas may be selected. It is NOT possible to configure the access point to rapidly toggle between external and internal antennas.

The only difference between the internal only version and the internal / external version of the access point is the addition of a small coax cable to an external 15.203 compliant antenna connector in the chassis.

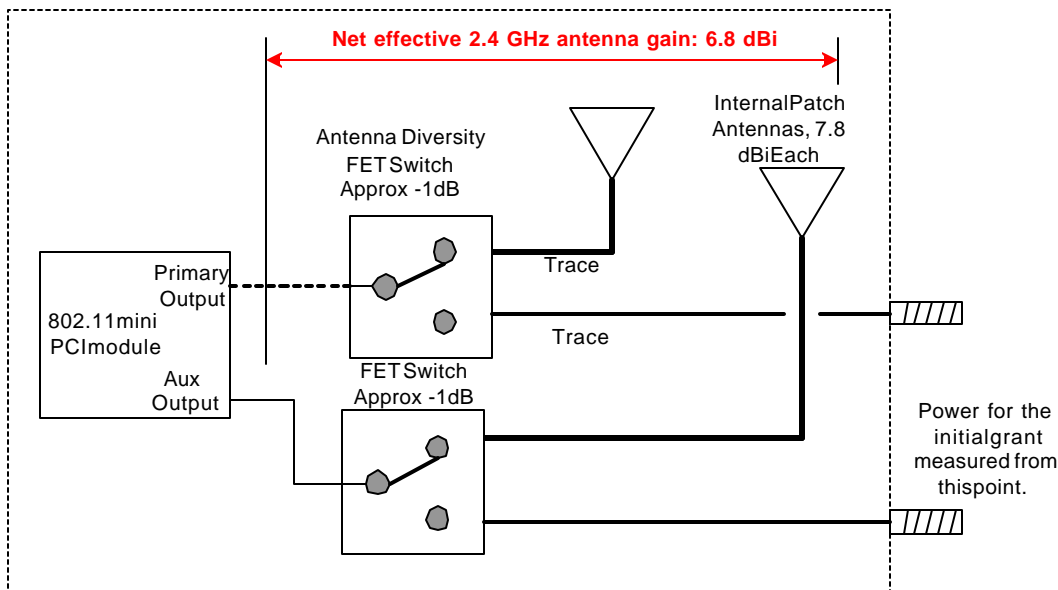

2.4 GHz RF Block Diagram (Internal / External Antenna Version)

Test Results Summary

This report presents the results of the tests that verify compliance with FCC Part 15.247..

A brief results summary of all the in this report is below.

Part 15 Paragraph	RSS-210 Paragraph	Test	Results
15.247(b)	6.2.2(o)(a) 3	Maximum Power Output (802.11 B)	20.4 dBm Max
15.247(b)	6.2.2(o)(a) 3	Maximum Power Output (802.11 G)	20.4 dBm Max
15.247(a)(2)	6.2.2(o)(e1)	6dB Bandwidth (802.11 B)	12.00 MHz Min
15.247(a)(2)	6.2.2(o)(e1)	6dB Bandwidth (802.11 G)	16.83 MHz Min
15.247(d)	6.2.2(o)(d1)	Power Spectral Density (802.11 B)	-12.96dBm/3kHz Max
15.247(d)	6.2.2(o)(d1)	Power Spectral Density (802.11 G)	-13.00dBm/3kHz Max
15.247(c)	6.2.2(o)(a) 4	Out of Band Spurious Emissions	-44 dBc Max
15.205	6.3(c)	Radiated Emissions in Restricted bands	1.1 dB in spec min @2390 MHz (802.11 G)

Test Facilities

Many of the certification tests were performed at:

Elliott Labs
684 West Maude Ave
Sunnyvale, CA 94086

The tests performed at Elliott include:

- All radiated emissions tests required in FCC Part 15.205 for 2.4 GHz.
- Out of band emissions (Conducted) (for 2.4 GHz)

General:

Final 802.11 B radiated test measurements were taken at Elliott Laboratories Open Area Test Site #4.

The test site contains separate areas for radiated and conducted emissions testing. Pursuant to section 2.948 of the Rules, construction, calibration, and equipment data has been filed with the Commission.

The FCC recommends that ambient noise at the test site be at least 6 dB below the allowable limits. Ambient levels are below this requirement with the exception of predictable local TV, radio, and mobile communications traffic. The test site contains separate areas for radiated and conducted emissions testing. Considerable engineering effort has been expended to ensure that the facilities conform to all pertinent FCC requirements.

OATS:

The FCC has determined that radiation measurements made in a shielded enclosure are not suitable for determining levels of radiated emissions. Radiated emissions are performed in an open field environment. The test site is maintained free of conductive objects within the CISPR defined elliptical area incorporated in ANSI C63.4 Guidelines.

Antenna, Antenna Mast and Turntable

The Horn antennas that are used to measure radiated emissions above 1000MHz are mounted on a non-conductive antenna mast equipped with a motor drive to vary the antenna height.

ANSI C63.4 specifies that the test height above the ground plane shall be 80cm unless the equipment is intended to be floor mounted. During the radiated emissions tests the equipment is positioned on a motorized turntable in conformance with the ANSI requirement.

Equipment Lists

Instrument Calibration

All test equipment is regularly checked to ensure that performance is maintained in accordance with the manufacturer's specifications. All antennas are calibrated at regular intervals with respect to tuned half-wave dipoles. An exhibit of this report contains the list of test equipment used and calibration information.

The following test equipment was used to perform the testing

Elliott Test Equipment

<u>Item</u>	<u>Desc.</u>	<u>Manufacturer</u>	<u>Model</u>	<u>S/N (Elliott #)</u>	<u>Cal due date</u>
1.	Spectrum Analyzer	Hewlett Packard	8595EM		2 Feb 2004
2.	3.5 GHz HPF	HP	NA	84300-80038	1 Mar 04
3.	Pre Amp	Miteq	ASF 44	805817	7 Jan 04
4.	Antenna	EMCO	3115	9711-5359	20 April 04
5.	Microwave test system	Hewlett Packard	84125		2 April 2004

Test Methods

The tests are performed at a low, middle and high channel of the applicable band. The typical frequencies used for the Part15.247 2.4 GHz tests are listed below. Unless otherwise noted, all testing was performed on these channels / frequencies

ISM 802.11 B		
2400 - 2483.5 MHz		
Channel	Freq(MHz)	
Low	Chan 1	2412
Mid	Chan 6	2437
High	Chan 11	2462

In order to comply with the “radiated emissions in restricted bands” requirements the transmit power had to be lowered on some of the channels at the edges of the operating band. The maximum power setting that allowed compliance with the radiated emissions requirements will be programmed into the configuration firmware of the access point ensuring that maximum possible power setting will be correct for each channel. Given that the access point will normally be operated at these power settings, these same settings were also used during the “bench top” conducted RF tests (Spectral density, bandwidth etc).

For each of the channels, the transmit power on 802.11 B was higher than that on 802.11 G. Because of this, radiated spurious emission was tested in the 802.11 B operating mode only.

The tests listed below are performed using the basic “conducted” test setup shown below unless otherwise noted. In most cases, the EUT was running special diagnostic software to allow it to transmit random data on a particular channel indefinitely.

Part 15	Test
15.247(a)(1)	6dB Bandwidth
15.247(c)	Out of Band Conducted Emissions
15.247(a)(1)(i)	Power Spectral Density
15.247(b)	Transmit Power

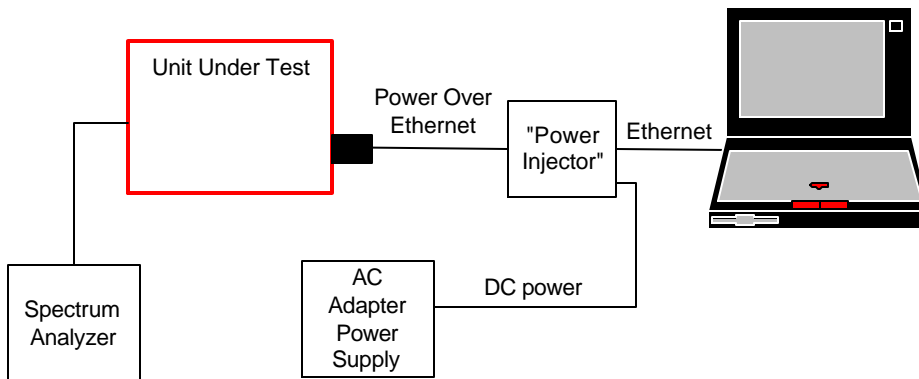

Basic Conducted RF Bench Test Setup

Unless otherwise noted, the support equipment for the bench tests is listed below.

Support Equipment				
Description	Model number	FCC ID or SN	Manufacturer	Power Cable
Laptop	Armada E 500	P31000T4X20DC12N2	Compaq	Laptop PS
Test Software	Atheros Radio Test		Atheros	
48VDC AC adapter	Generic		Generic	Standard Twin lead DC wire

NOTE: The “Power Injector” is simply a connector attached to wires “broken out” of the Ethernet cable. It is not really a piece of equipment.

Test Results

Detailed test procedures and test results are contained in the following sections. In cases where the test setup differs from the Conducted RF test setup shown earlier, the test setup is also presented.

Test Conditions			
Temperature	18C	Humidity:	52%
ATM pressure	1002 mBar	Grounding:	None
Tested By	David Waitt	Date of Test:	Nov 2003
Test Reference	Refer to individual test results		
Tested Range	Test Dependent		
Test Voltage	48 VDC to the AP		
Modifications	No modifications were made to the unit during the tests		

802.11 B Maximum RF Power Output at Antenna Terminals

Specifications:

FCC Specification: Paragraph: 15.247(b)

Procedure:

The test was configured as shown in the conducted RF test setup. The unit was tuned to the test channels and configured to transmit random data packets and measured from the auxiliary output of the module

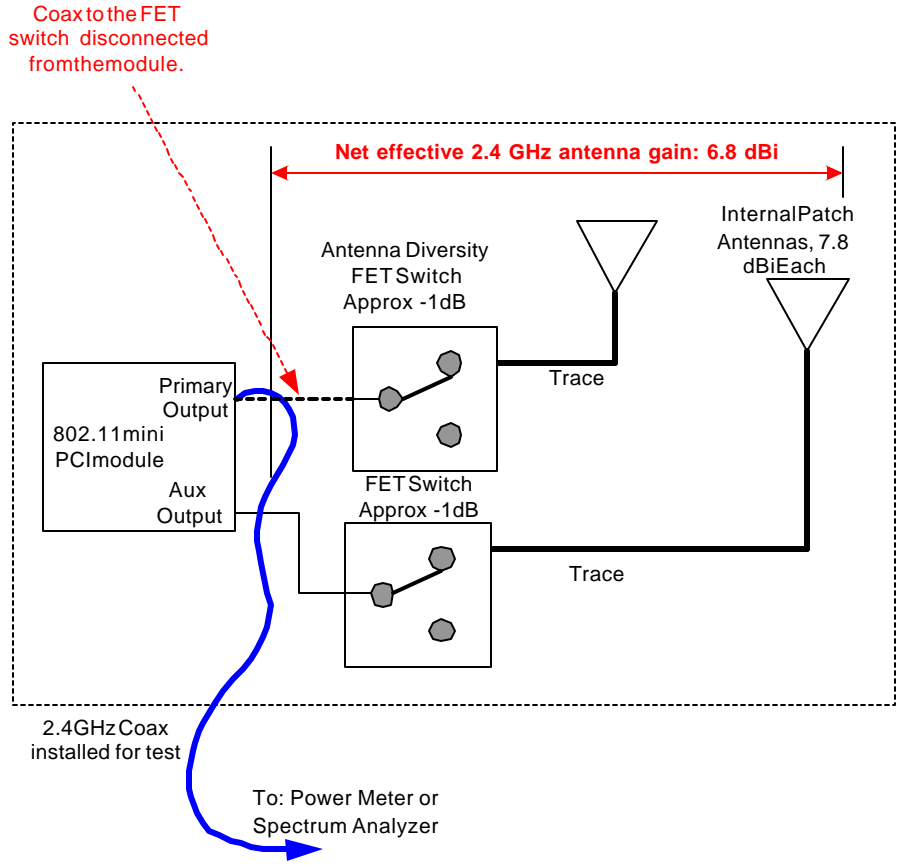

RF Transmit Power Result:

The power levels below reflect the power into the antenna, and are adjusted down by 1 dB from what was actually measured to account for the 1 dB loss of the FET switch. The power measurements listed in the tables above are also applicable for the power into the external antennas if used with the product

NOTE: The power was reduced for the channels at the band edge to comply with restricted band emissions requirements

Freq (MHz)	802.11 B			802.11 G			Spec (dBm)	Min Delta (dB)
	Power into antenna (dBm)	Power into antenna (mW)	Xmit Power (dBm EIRP)	Power into antenna (dBm)	Power into antenna (mW)	Xmit Power (dBm EIRP)		
2412	18.1	64.57	25.9	18.1	64.57	25.9	30	11.9
2437	20.4	109.65	28.2	20.4	109.65	28.2	30	9.6
2462	15.9	38.90	23.7	14.1	25.70	21.9	30	14.1

ISM 6 dB bandwidth

Specifications

FCC Specification: Paragraph 15.247(a)(2)

Procedure:

The Nortel AP access point operates on the standard IEEE 802.11 A / B channels. The 6dB bandwidth was measured on the low middle and high channel of the 2.4 GHz ISM band using the conducted RF test setup. The spectrum analyzer was configured for MAX HOLD and the trace allowed to stabilize. A peak search was performed and the then Delta-Marker used to locate the point -6dB below the peak.

Once this was complete, the point was used as a reference and another delta measurement was performed and an attempt made to make the two markers "level". The delta frequency between the two markers was measured as the 6 dB BW of the signal. The bandwidth test was performed at the power settings that will be used in the final system.

Results:

Frequency (MHz)	802.11 B Measured BW (MHz)	802.11 G Measured BW (MHz)	Spec (min .5 MHz)	Delta (min MHz)
2412	12.75	16.83	0.5	12.25
2437	12.00	16.92	0.5	11.50
2462	12.60	16.92	0.5	12.10

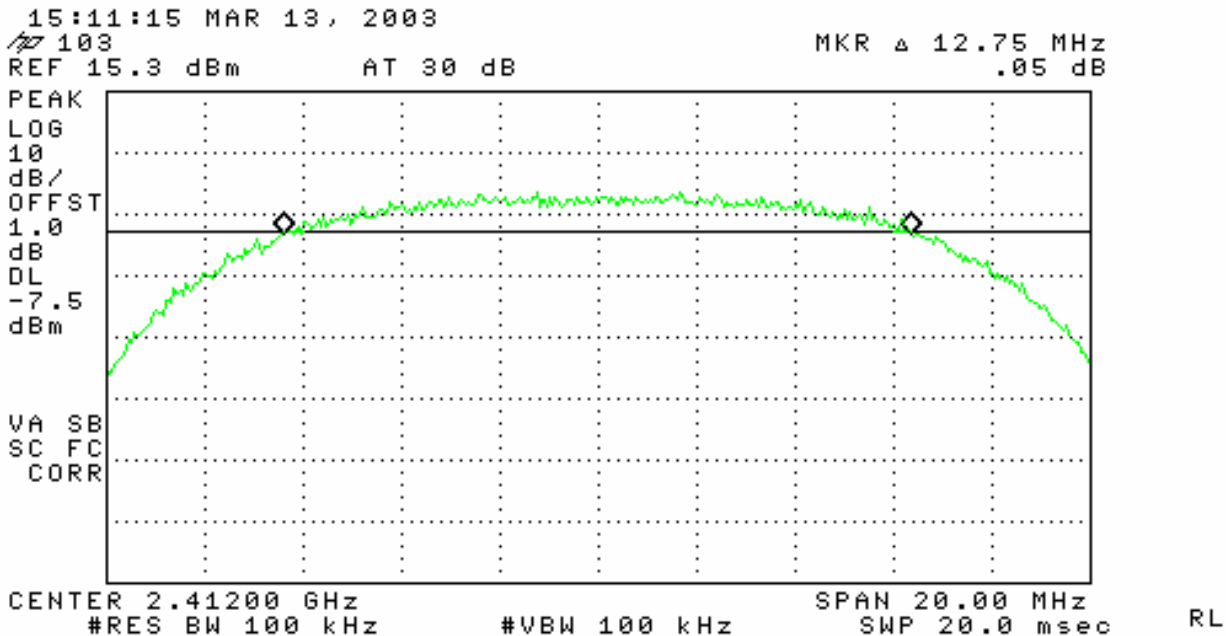

802.11 B 6 dB BW, 2412 MHz

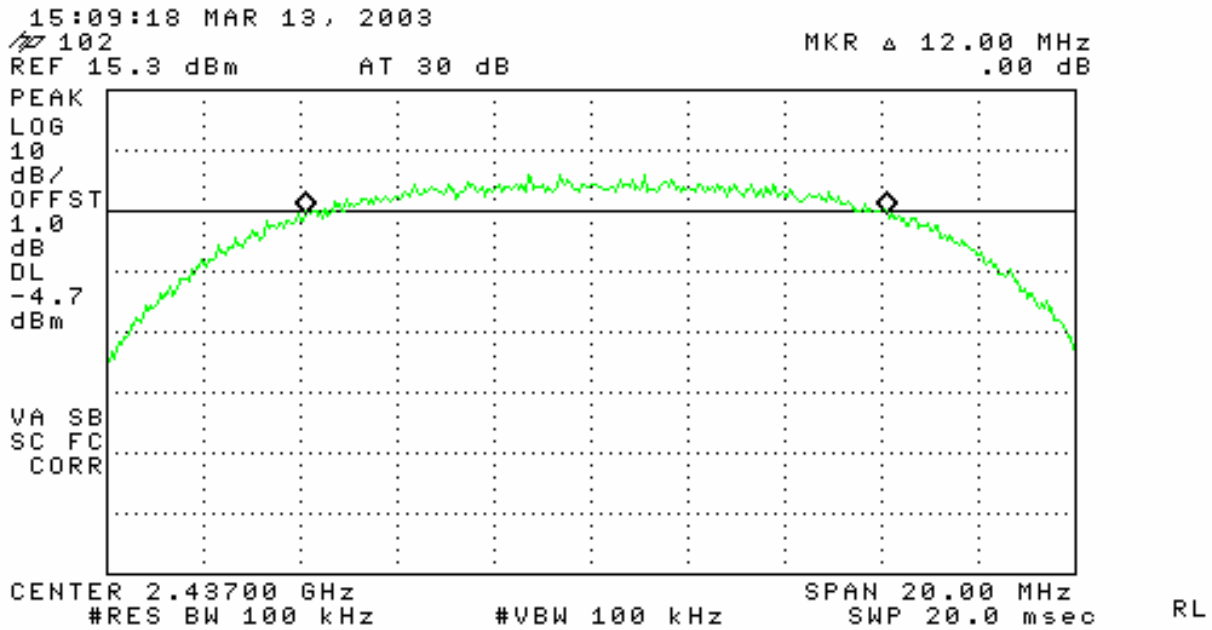

802.11 B 6 dB BW, 2437 MHz

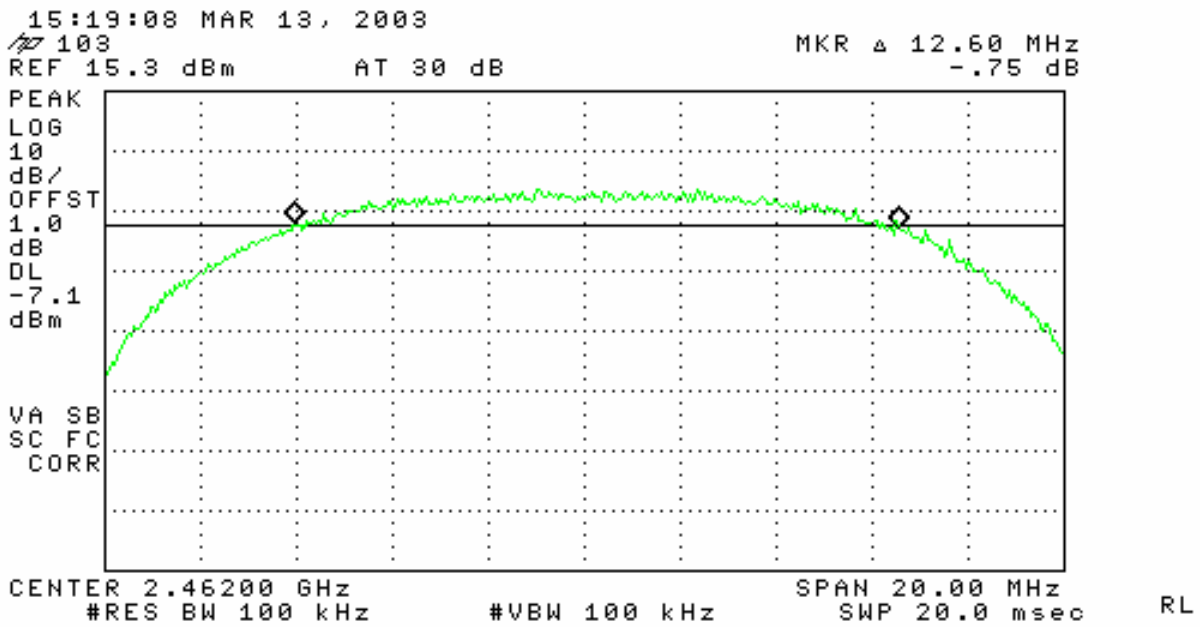

802.11 B 6 dB BW, 2462 MHz

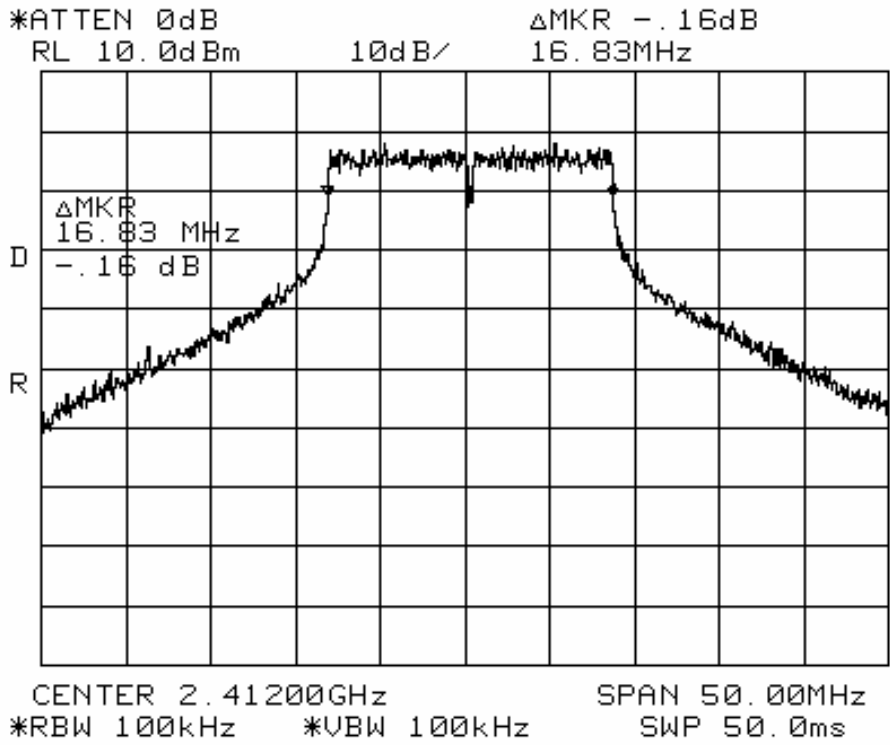

6 dB BW, Channel 1, 2412 MHz, 802.11 G

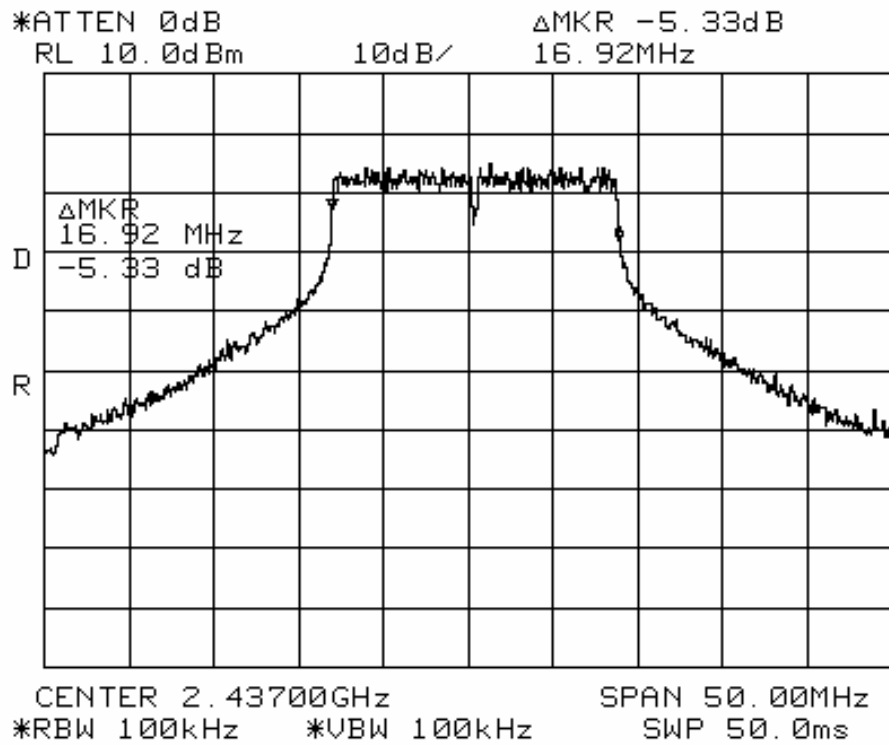

6 dB BW, Channel 6 , 2437 MHz, 802.11 G

ISM Power Spectral Density

FCC Specification: Paragraph: 15.247(4)(d)

Procedure

The test setup was configured as shown in the conducted test setup. The UUT was configured to continuously transmit random data packets.

Procedure(2.4 GHz):

Initially the bandwidth of the entire channel was examined. Using MAX HOLD, the trace was allowed to stabilize. Once the trace was stable, a peak search was performed and the frequency with the maximum power was determined.

The measurement span was then narrowed to 300kHz and centered on the “MAX power” frequency, the RBW set to 3 kHz with a 100 second sweep. The analyzer was then set to MAX HOLD and a display line placed at +8dBm.

The power spectral density was measured at the low, middle and high-test channels with the appropriate power setting for the given test channel.

Results:

Frequency (MHz)	Specification (dBm/3 kHz)	802.11 B Measured PSD (dBm)	Spec Delta 802.11 B (dBm Min)	802.11 G Measured PSD (dBm)	802.11 G Spec Delta (dBm Min)
2412	8	-15.32	-23.32	-13.00	-21.00
2437	8	-12.96	-20.96	-16.17	-24.17
2462	8	-14.58	-22.58	-17.67	-25.67

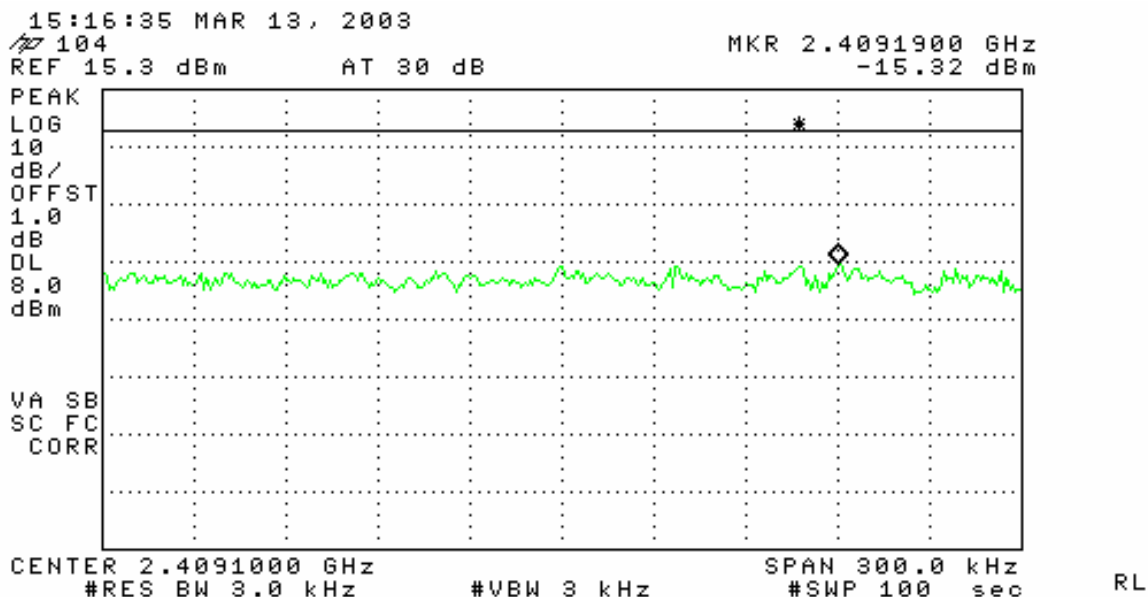

Power Spectral Density,802.11 B LOW Channel, 2412MHz

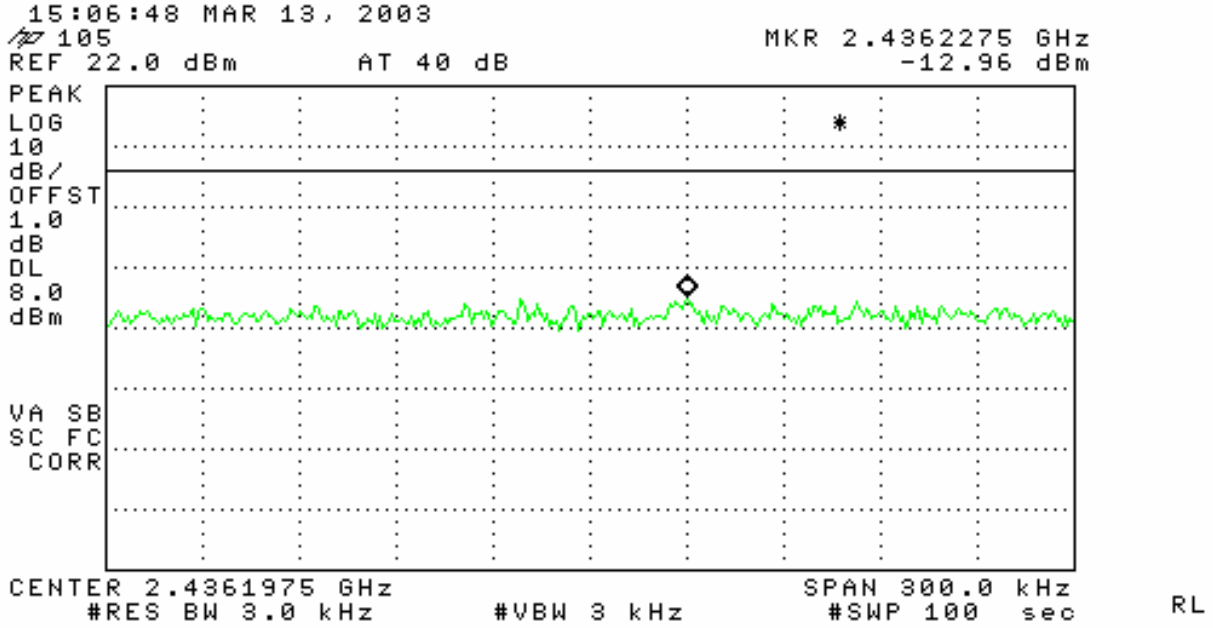

Power Spectral Density ,802.11 B MID Channel, 2437MHz

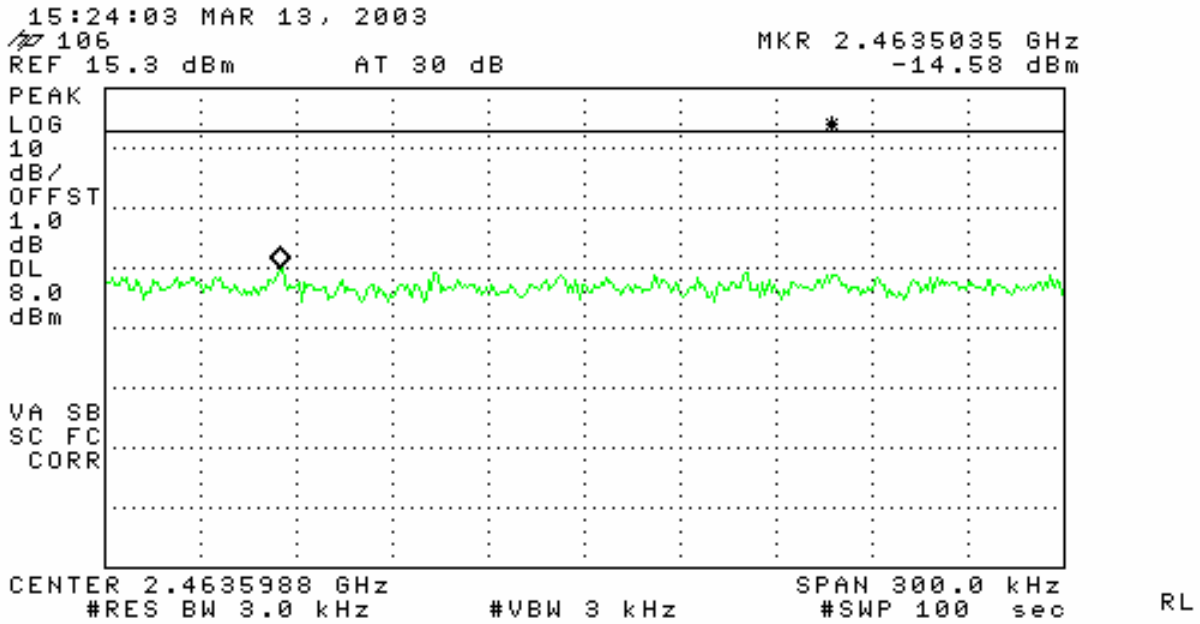

Power Spectral Density, 802.11 B HIGH Channel, 2462MHz

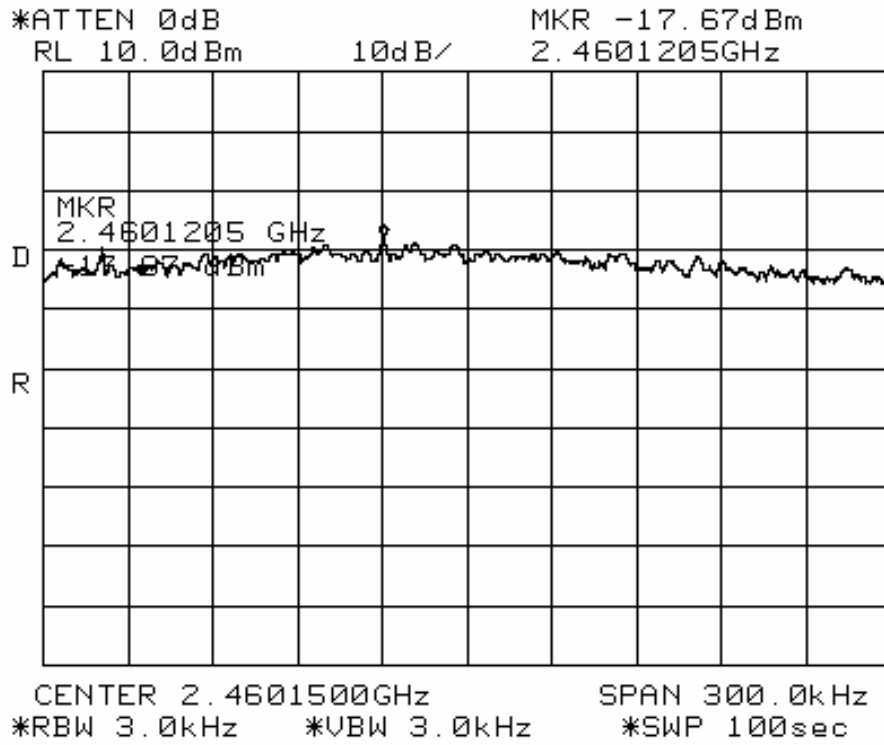

Power Spectral Density, 802.11 G, HIGH Channel, 2462MHz

ISM Out of Band Emissions

Specifications:

FCC Part 15 Paragraph 15.247(c)

Procedure:

The test was configured as shown in the bench conducted RF test setup. The UUT was configured to transmit random data packets. The band from 1 GHz to 25GHz was examined for spurious emissions. This test was conducted the low middle and high channels. The UUT was configured to transmit at the appropriate power levels for each channel (1 , 6 and 11) that was used in the RF power test.

Results:

The entire band of interest was examined at one time to clearly demonstrate compliance. There were no spurious emissions above the limit (-20dBc)

Out of Band Emissions Plots

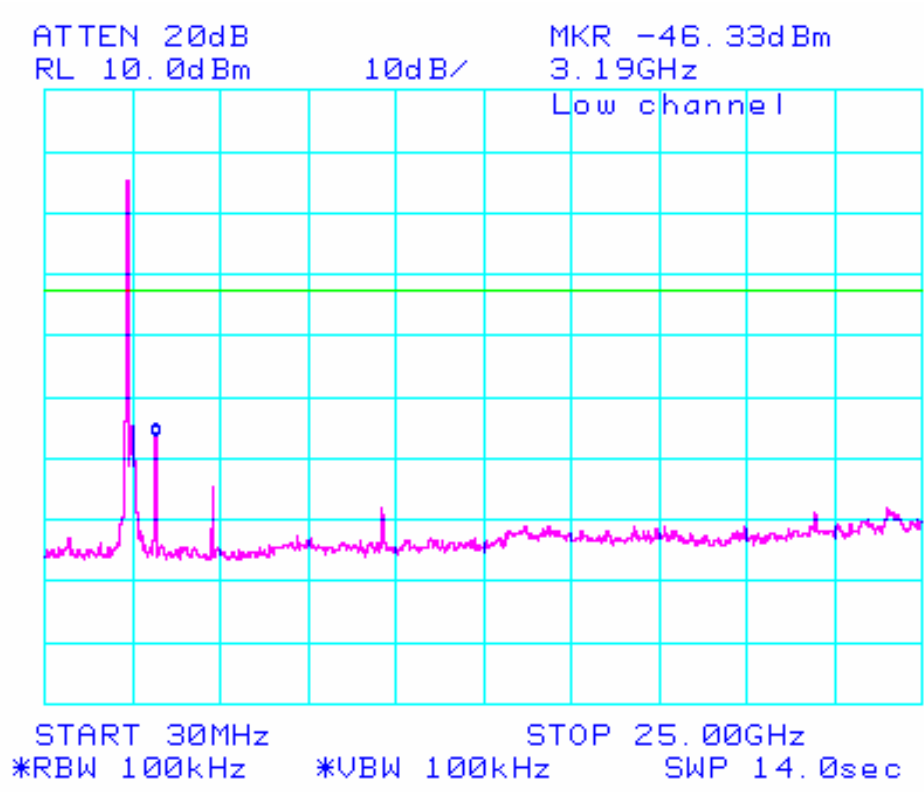

OOB Emissions, Transmit on Channel 1 (2412MHz)

ISM Radiated Emissions in Restricted bands

Specifications: FCC Part 15: Paragraph 15.247(c)

Procedure:

This test was conducted on a 3-meter open-air test site at Elliott Laboratories. The unit was placed on a rotating wooden table 80cm above the ground plane. A Horn antenna was secured to a mast 3 meters away. The unit was tested at each of the Low, Mid and High channels. The UUT was running in the diagnostic mode and set to transmit CW at maximum power on each of the channels. The test equipment was configured as shown below.

The harmonics of the fundamental that fell within restricted bands (up to the tenth) were measured (See table 1 below). A high pass filter prior to the pre-amplifier was required to prevent the large signal level of the fundamental frequency from overloading the front end of the spectrum analyzer and creating harmonics within the analyzer.

The EUT was rotated 360 degrees and the height of the antenna adjusted from 1 to 4 meters above the ground plane to determine the maximum level of the emission. The level of the harmonic emission was measured in two modes, "Peak" and "Average".

The spectrum analyzer reading was entered into a spreadsheet where correction factors (antenna factor, cable loss, pre-amplifier gain, HPF loss...) were then applied by Elliott Lab's Software to obtain a final corrected measurement.

This procedure was repeated for the low (Ch 1), mid (Ch 6) and high (Ch 11) channels within the 2400-2483.5MHz band.

The band up to 25 GHz was examined, however there were no spurious emissions noted above approximately 12 GHz., additionally, the only visible emissions were harmonics of the transmit frequency.

The table below indicates the harmonics that fall within restricted bands.

FUND	Harmonic (MHz)								
	2	3	4	5	6	7	8	9	10
2412	4824	7236	9648	12060	14472	16884	19296	21708	24120
2437	4874	7311	9748	12185	14622	17059	19496	21933	24370
2462	4924	7386	9848	12310	14772	17234	19696	22158	24620

15.205 Harmonic test tables

NOTE: **RED** indicates a harmonic that falls within a restricted band and is subject to 15.205. The harmonics in **black** are NOT in restricted bands and are subject to 15.209

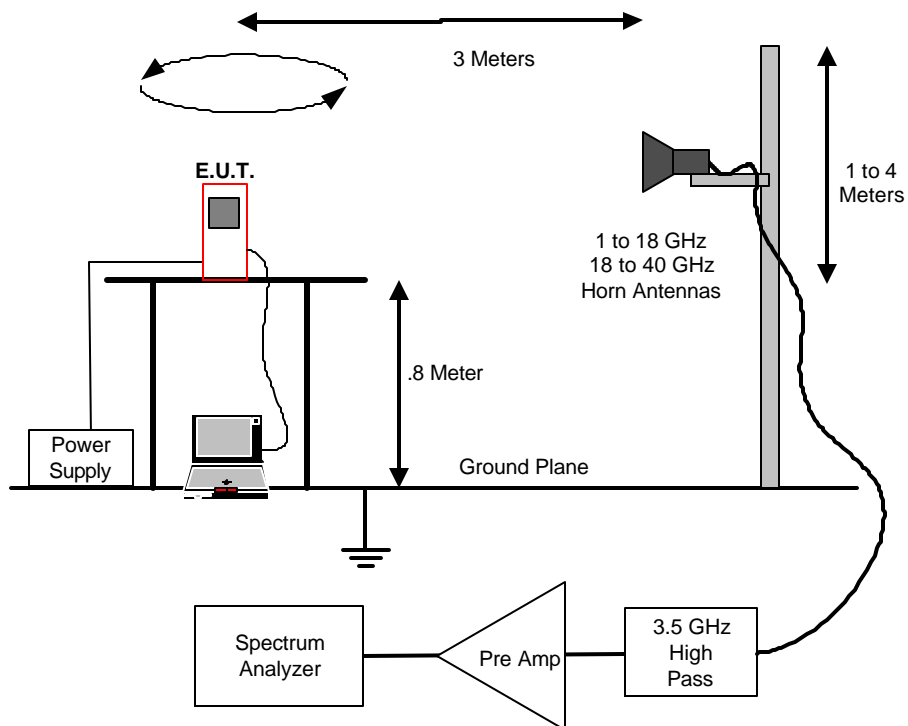

Radiated Emissions in Restricted Bands Test Setup

Support Equipment				
Description	Model number	FCC ID or SN	Manufacturer	Power Cable
Laptop	Armada E 500	P31000T4X20DC12N2	Compaq	Laptop PS
Test Software	Atheros Radio Test		Atheros	
48VDC AC adapter	Generic		Generic	Standard Twin lead DC wire

Test Conditions			
Temperature	19 C	Humidity:	39%
ATM pressure	1020 mBar	Grounding:	None
Tested By	J Martinez / C Byleckie Elliott Labs	Date of Test:	March 2003
Test Reference	FCC Part 15.205 IC Paragraph RSS210, 6.2.3 (c)		
Setup Method	ANSI C63.4		
Tested Range	1 GHz to 24 GHz		
Test Voltage	120 VAC / 60 Hz		
Modifications	No modifications were made to the unit		

NOTES: For emissions in restricted bands, the limit of 15.209 was used. For all other emissions, the limit was set 20dB below the level of the fundamental. No emission detected above 15GHz.

Restricted Band Peak Measurements: Resolution and Video BW: 1 MHz
 Restricted Band Average Measurements: Resolution BW: 1MHz and Video BW: 10 Hz.
 All other measurements, RBW = 1MHz and VBW = 3MHz, video averaging on (100 samples).

Results:**UUT Xmitting on low Channel: 2412 MHz**

Frequency	Level	Pol	15.209 / 15.247		Detector	Azimuth	Height	Comments
			MHz	dBmV/m				
4824.000	58.6	h	74.0	-15.4	Pk	290	1.0	
4824.000	44.5	h	54.0	-9.5	Avg	290	1.0	
12060.00	56.2	h	74.0	-17.8	Pk	55	1.0	Noise Floor
12060.00	43.5	h	54.0	-10.5	Avg	55	1.0	Noise Floor
14472.00	55.7	h	74.0	-18.3	Pk	198	1.0	Noise Floor
14472.00	45.2	h	54.0	-8.8	Avg	198	1.0	Noise Floor
4824.000	55.1	v	74.0	-18.9	Pk	134	1.0	
4824.000	41.9	v	54.0	-12.1	Avg	134	1.0	
12060.00	56.2	v	74.0	-17.8	Pk	361	1.0	Noise Floor
12060.00	43.2	v	54.0	-10.8	Avg	361	1.0	Noise Floor
14472.00	58.6	v	74.0	-15.4	Pk	78	1.0	Noise Floor
14472.00	44.5	v	54.0	-9.5	Avg	78	1.0	Noise Floor

UUT Xmitting on mid Channel: 2437 MHz

Frequency	Level	Pol	15.209 / 15.247		Detector	Azimuth	Height	Comments
			MHz	dBmV/m				
4874.000	62.5	h	74.0	-11.5	Pk	59	1.0	
4874.000	48.8	h	54.0	-5.2	Avg	59	1.0	
7311.000	56.2	h	74.0	-17.8	Pk	137	1.0	
7311.000	46.0	h	54.0	-8.0	Avg	137	1.0	
12185.00	57.8	h	74.0	-16.2	Pk	182	1.0	Noise Floor
12185.00	43.7	h	54.0	-10.3	Avg	182	1.0	Noise Floor
4874.000	61.8	v	74.0	-12.2	Pk	282	1.0	
4874.000	48.0	v	54.0	-6.0	Avg	282	1.0	
7311.000	55.2	v	74.0	-18.8	Pk	144	1.7	
7311.000	44.1	v	54.0	-9.9	Avg	144	1.7	
12185.00	57.5	v	74.0	-16.5	Pk	156	1.5	Noise Floor
12185.00	43.3	v	54.0	-10.7	Avg	156	1.5	Noise Floor

UUT Xmitting on high Channel: 2462 MHz

Frequency	Level	Pol	15.209 / 15.247		Detector	Azimuth	Height	Comments
			MHz	dBmV/m				
4924.000	56.9	h	74.0	-17.2	Pk	90	1.0	
4924.000	42.9	h	54.0	-11.1	Avg	90	1.0	
7386.00	51.3	h	74.0	-22.7	Pk	249	1.0	
7386.00	38.6	h	54.0	-15.4	Avg	249	1.0	
12310.00	56.8	h	74.0	-17.2	Pk	48	1.0	Noise Floor
12310.00	42.3	h	54.0	-11.7	Avg	48	1.0	Noise Floor
4924.000	55.2	v	74.0	-18.8	Pk	239	1.3	
4924.000	41.1	v	54.0	-12.9	Avg	239	1.3	
7386.00	53.4	v	74.0	-20.7	Pk	87	1.5	
7386.00	41.3	v	54.0	-12.7	Avg	87	1.5	
12310.00	56.2	v	74.0	-17.8	Pk	325	1.0	Noise Floor
12310.00	42.2	v	54.0	-11.8	Avg	325	1.0	Noise Floor

ISM Radiated Emissions in Restricted bands (2.4 GHz External Antenna)

Specifications: FCC Part 15: Paragraph 15.247(c)

Procedure:

This test was conducted in a manner similar to the previous radiated emissions test setup however the access point was connected to a 5 dBi external patch antenna. (See external antenna data sheet)

Results: Radiated emission with the 5 dBi external patch antenna

UUT xmitting on low Channel: 2412 MHz

Frequency MHz	Level dBµV/m	Pol v/h	15.209 / 15.247		Detector Pk/QP/Avg	Azimuth degrees	Height meters	Comments
			Limit	Margin				
4824.000	56.6	h	74.0	-17.4	Pk	297	1.7	
4824.000	43.7	h	54.0	-10.3	Avg	297	1.7	
12060.00	57.2	h	74.0	-16.8	Pk	73	1.0	Noise Floor
12060.00	43.3	h	54.0	-10.7	Avg	73	1.0	Noise Floor
14472.00	58.3	h	74.0	-15.7	Pk	79	1.0	Noise Floor
14472.00	46.3	h	54.0	-7.7	Avg	79	1.0	Noise Floor
4824.000	58.2	v	74.0	-15.8	Pk	186	1.0	
4824.000	44.6	v	54.0	-9.4	Avg	186	1.0	
12060.00	57.7	v	74.0	-16.3	Pk	103	1.0	Noise Floor
12060.00	43.2	v	54.0	-10.8	Avg	103	1.0	Noise Floor
14472.00	59.3	v	74.0	-14.7	Pk	111	1.0	Noise Floor
14472.00	45.0	v	54.0	-9.0	Avg	111	1.0	Noise Floor

UUT xmitting on mid Channel: 2437 MHz

Frequency MHz	Level dBµV/m	Pol v/h	15.209 / 15.247		Detector Pk/QP/Avg	Azimuth degrees	Height meters	Comments
			Limit	Margin				
4874.000	59.2	h	74.0	-14.8	Pk	83	1.8	
4874.000	46.3	h	54.0	-7.7	Avg	83	1.8	
7311.000	56.0	h	74.0	-18.0	Pk	182	1.3	
7311.000	47.0	h	54.0	-7.0	Avg	182	1.3	
12185.00	58.6	h	74.0	-15.4	Pk	184	1.2	
12185.00	48.3	h	54.0	-5.7	Avg	184	1.2	
4874.000	62.1	v	74.0	-11.9	Pk	161	1.0	
4874.000	48.7	v	54.0	-5.3	Avg	161	1.0	
7311.000	58.2	v	74.0	-15.8	Pk	118	1.8	
7311.000	48.0	v	54.0	-6.0	Avg	118	1.8	
12185.00	58.1	v	74.0	-15.9	Pk	32	1.2	
12185.00	47.1	v	54.0	-7.0	Avg	32	1.2	

UUT xmitting on high Channel: 2462 MHz

Frequency MHz	Level dBµV/m	Pol v/h	15.209 / 15.247		Detector Pk/QP/Avg	Azimuth degrees	Height meters	Comments
			Limit	Margin				
4924.000	55.7	h	74.0	-18.3	Pk	0	1.0	
4924.000	43.1	h	54.0	-11.0	Avg	0	1.0	
7386.00	52.3	h	74.0	-21.7	Pk	304	1.0	
7386.00	37.2	h	54.0	-16.8	Avg	304	1.0	
12310.00	55.8	h	74.0	-18.2	Pk	0	1.0	Noise Floor
12310.00	41.7	h	54.0	-12.3	Avg	0	1.0	Noise Floor
4924.000	56.3	v	74.0	-17.7	Pk	189	1.0	
4924.000	43.4	v	54.0	-10.6	Avg	189	1.0	
7386.00	54.2	v	74.0	-19.8	Pk	123	1.2	
7386.00	43.5	v	54.0	-10.5	Avg	123	1.2	
12310.00	56.1	v	74.0	-17.9	Pk	350	1.2	Noise Floor
12310.00	44.7	v	54.0	-9.3	Avg	350	1.2	Noise Floor

ISM Radiated Emissions in Restricted bands (2.4 GHz Band Edges)

FCC Specifications: Paragraph 15.247(c)

Procedure:

Since this is a 2.4 GHz product, there is a restricted band that begins immediately at the high end of the operating band and another that begins 10 MHz below the low end of the operating band.



This test was conducted on a 3-meter OATS #4 at Elliott labs Sunnyvale facility. There are three steps to performing this test.

STEP 1) The first involves making a radiated measurement of the fundamental signal with the UUT on the operating channel closest to the edge of the band. The unit was placed on a rotating wooden table 80cm above the OATS ground plane. A Horn antenna was secured to a mast 3 meters away. The test equipment was configured as shown below.

The EUT was rotated 360 degrees and the height of the antenna adjusted from 1 to 4 meters above the ground plane to determine the maximum level of the emission. The level of the fundamental emission was measured in two modes, "Peak" and "Average" using RBW and VBW of 1MHz/1MHz and 1MHz/10Hz respectively.

STEP 2) A second measurement (conducted) is made using narrower bandwidths (100 kHz) to determine a $-dB_c$ (delta dB) level between the peak of the fundamental level (measured in a 100 kHz BW) and the highest level within the restricted band near the operating band.

STEP 3) A third and final measurement (conducted) is made to determine the apparent drop in fundamental carrier power when the RBW is narrowed from 1MHz (in the reference measurement) to 100kHz (for the delta dB measurement). This is referred to below as the "BW Delta".

The level of the emission in the restricted band is then calculated using the following formulas.

$\begin{aligned} \text{Restricted band level (AVG)} &= \text{AVG reference level} - \text{delta dB} - \text{BW Delta dB} \\ \text{Restricted band level (Peak)} &= \text{Peak reference level} - \text{delta dB} - \text{BW Delta dB} \end{aligned}$
--

802.11 B Band Edge (Restricted band @ 2.390GHz)												
Pol	Fundamental Radiated Ref Msmt		Delta Msmt		RBW Msmt		Radiated Level at Band Edge		Specification		Delta (dB below Limit)	
	Peak dbuv/m	Avg dbuv/m	Peak dBc	Avg dBc	Pk dB	Avg dB	Peak dBuv/m	Avg dBuv/m	Peak dBuv/m	Avg dBuv/m	Peak dBuv/m	Avg dBuv/m
Vert	115.4	108.4	46	50.5	7.56	9.08	61.87	48.82	74	54	12.13	5.18
Horz	104.3	98.5					50.77	38.92			23.23	15.08
802.11 B Band Edge (Restricted band @ 2.4835GHz)												
Pol	Fundamental Radiated Ref Msmt		Delta Msmt		RBW Msmt		Radiated Level at Band Edge		Specification		Delta (dB below Limit)	
	Peak dbuv/m	Avg dbuv/m	Peak dBc	Avg dBc	Pk dB	Avg dB	Peak dBuv/m	Avg dBuv/m	Peak dBuv/m	Avg dBuv/m	Peak dBuv/m	Avg dBuv/m
Vert	112.2	105.9	47.4	46.9	6.6	11.26	58.2	47.74	74	54	15.8	6.26
Horz	104.1	97.1					50.1	38.94			23.9	15.06
802.11 G Band Edge (Restricted band @ 2.390GHz)												
Pol	Fundamental Radiated Ref Msmt		Delta Msmt		RBW Msmt		Radiated Level at Band Edge		Specification		Delta (dB below Limit)	
	Peak dbuv/m	Avg dbuv/m	Peak dBc	Avg dBc	Pk dB	Avg dB	Peak dBuv/m	Avg dBuv/m	Peak dBuv/m	Avg dBuv/m	Peak dBuv/m	Avg dBuv/m
Vert	111.5	101.3	33.2	40.6	15.2	7.8	63.14	52.9	74	54	10.86	1.1
Horz	103.7	93.3					55.34	44.9			18.66	9.1
802.11 G Band Edge (Restricted band @ 2.4835GHz)												
Pol	Fundamental Radiated Ref Msmt		Delta Msmt		RBW Msmt		Radiated Level at Band Edge		Specification		Delta (dB below Limit)	
	Peak dbuv/m	Avg dbuv/m	Peak dBc	Avg dBc	Pk dB	Avg dB	Peak dBuv/m	Avg dBuv/m	Peak dBuv/m	Avg dBuv/m	Peak dBuv/m	Avg dBuv/m
Vert	110.9	100.7	37.7	41.5	8.02	8.56	65.21	50.64	74	54	8.79	3.36
Horz	100.4	92.3					54.71	42.24			19.29	11.76

Radiated emissions at band edge sample calculation (Vertical, Avg, 802.11 G, Low Edge):

$$\text{Emission Level} = \text{Fund Ref msmt} - \text{Delta msmt} - \text{RBW Delta msmt}$$

Example: 101.3 dBuV/m – 40.26 dBc – 7.8dB = 52.9dBuV/m
 54 dBuV/m - 52.9dBuV/m = 1.1 dB margin

Agilent 10:51:26 Mar 11, 2004

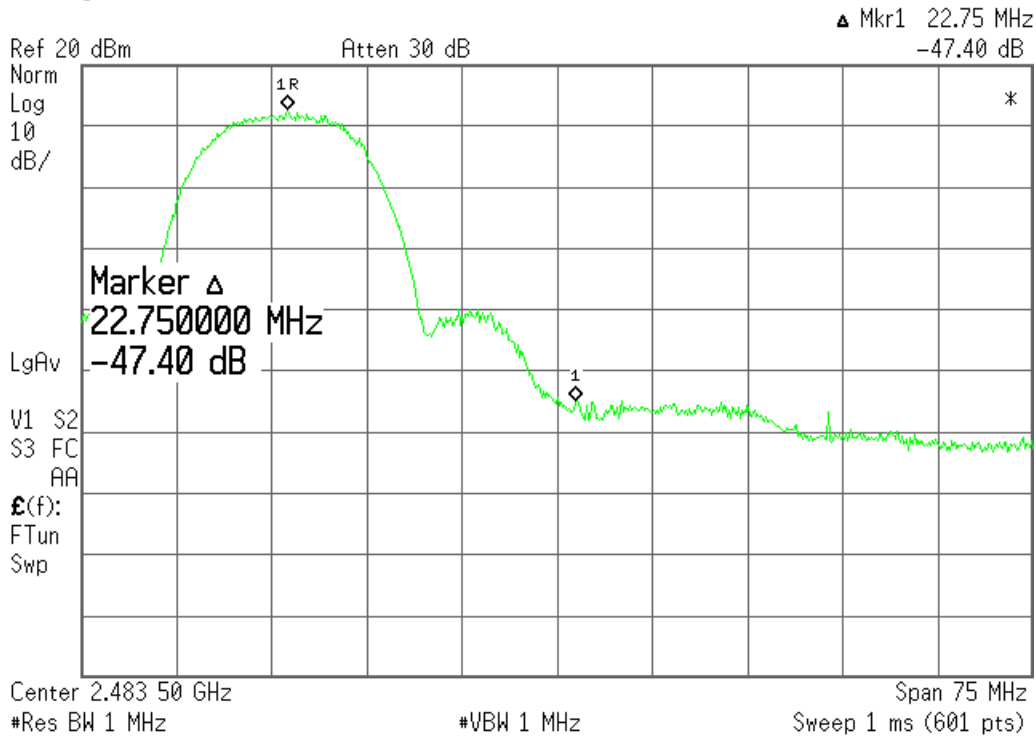

Agilent 11:18:03 Mar 11, 2004

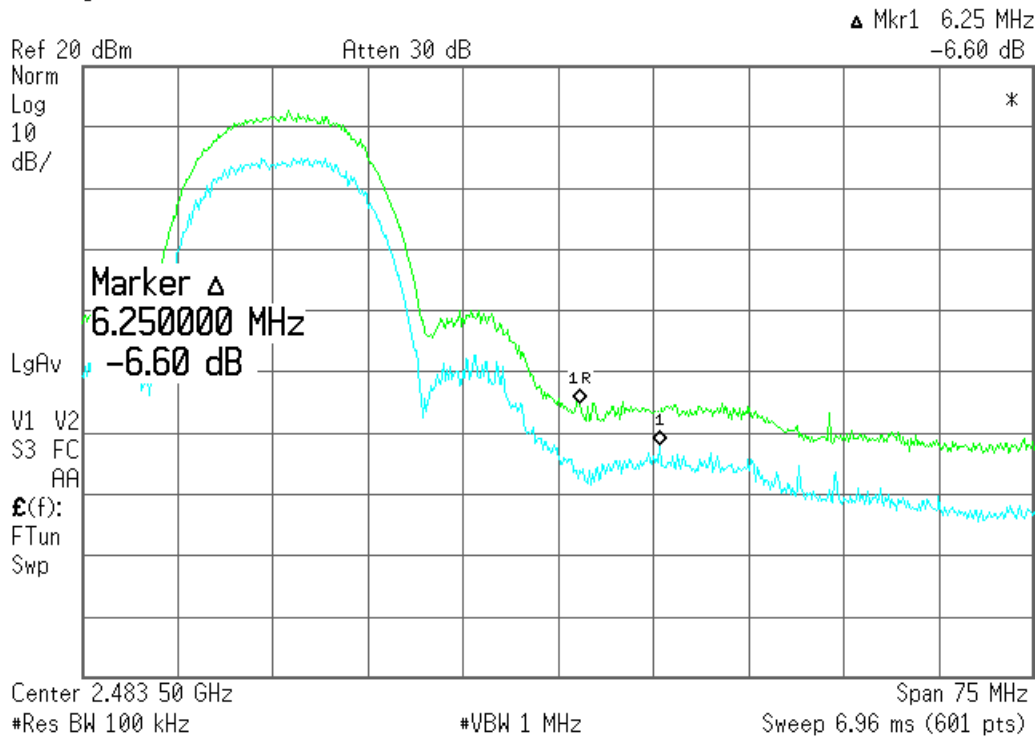

Agilent 12:11:38 Mar 11, 2004

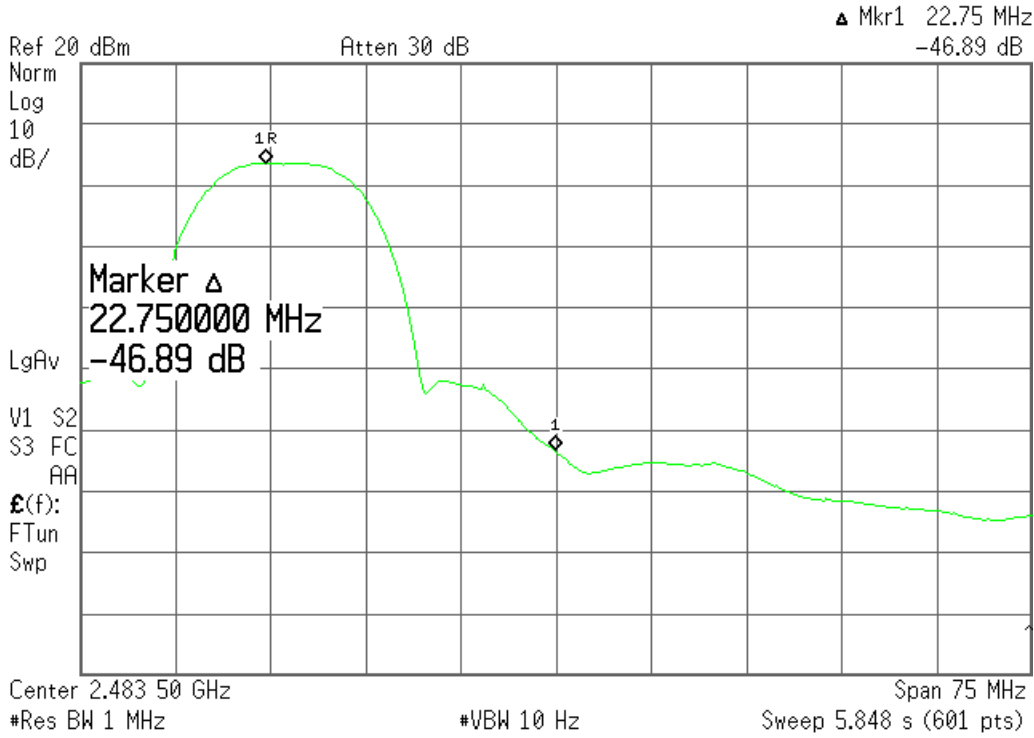

2483.5 MHz band edge
802.11 B
dBc Msmt, AVG
(scrn 21)

Agilent 12:25:23 Mar 11, 2004

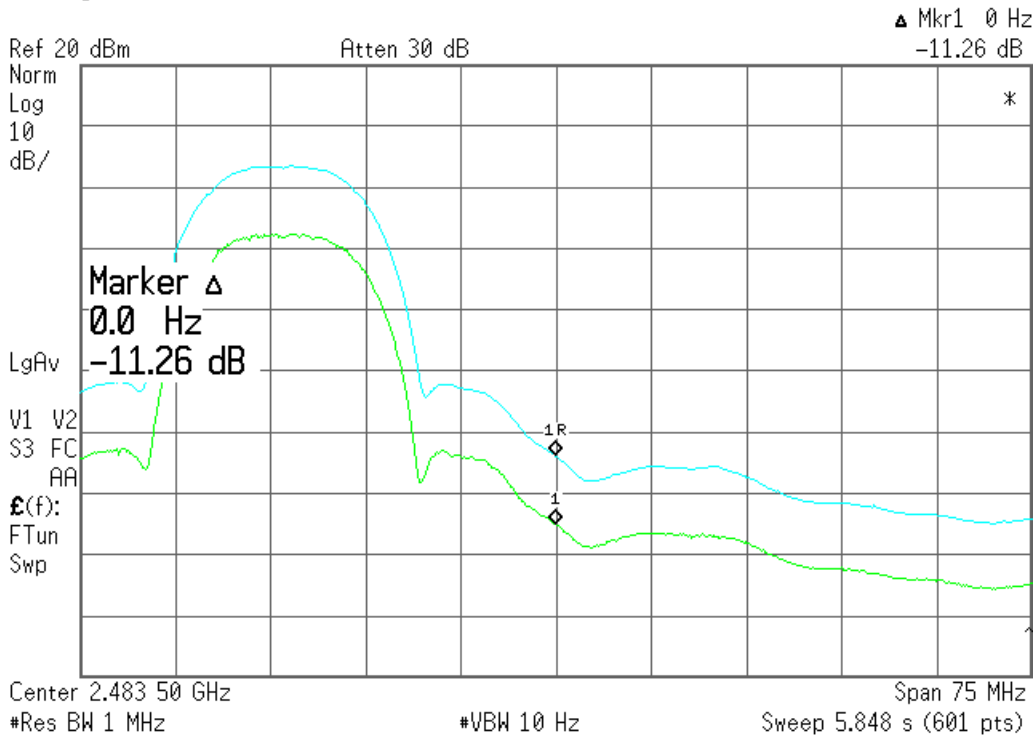

2483.5 MHz band edge
802.11 B
BW Delta Msmt, AVG
1M/10H to 100k/10H
(scrn 22)

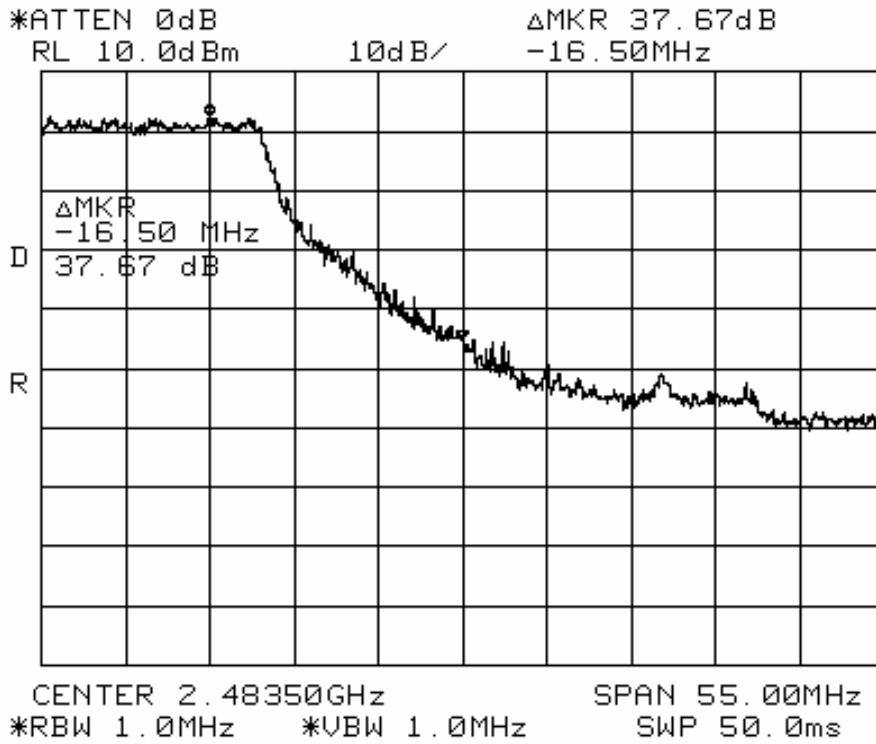

2483.5 MHz band edge
802.11 G
dBc Msmt, PK

Agilent 13:01:52 Feb 26, 2004

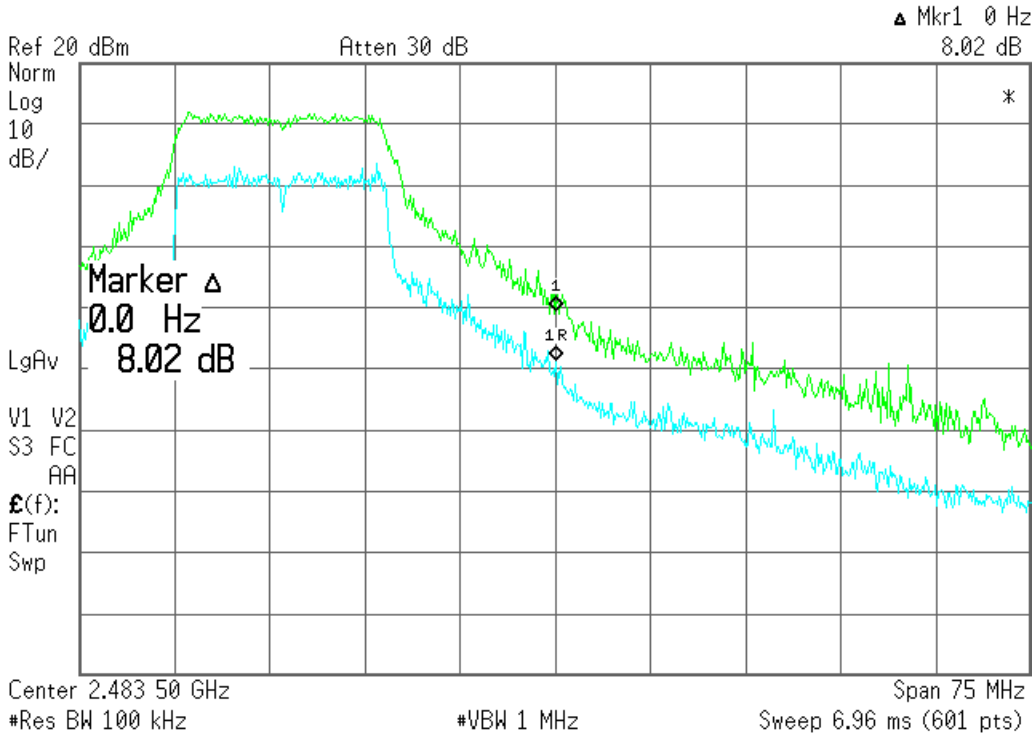

2483.5 MHz band edge
802.11 G
BW Delta Msmt, PK
1M/1M to 100k/1M
(scrn 25)

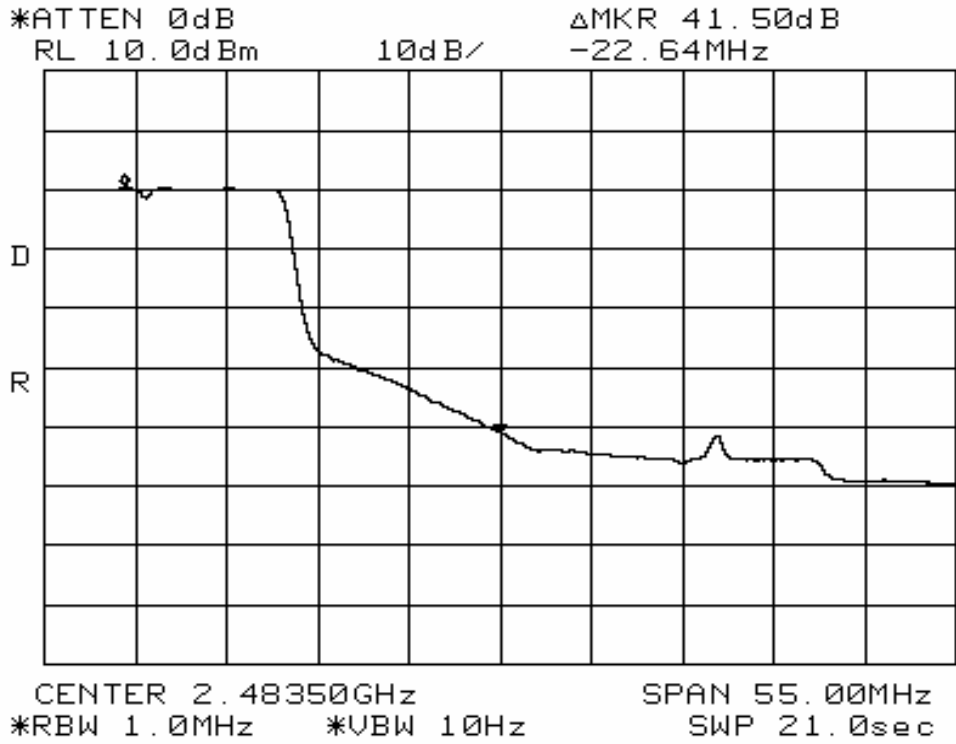

2483.5 MHz
band edge
802.11 G
dBc Msmt,
AVG

Agilent 12:59:47 Feb 26, 2004

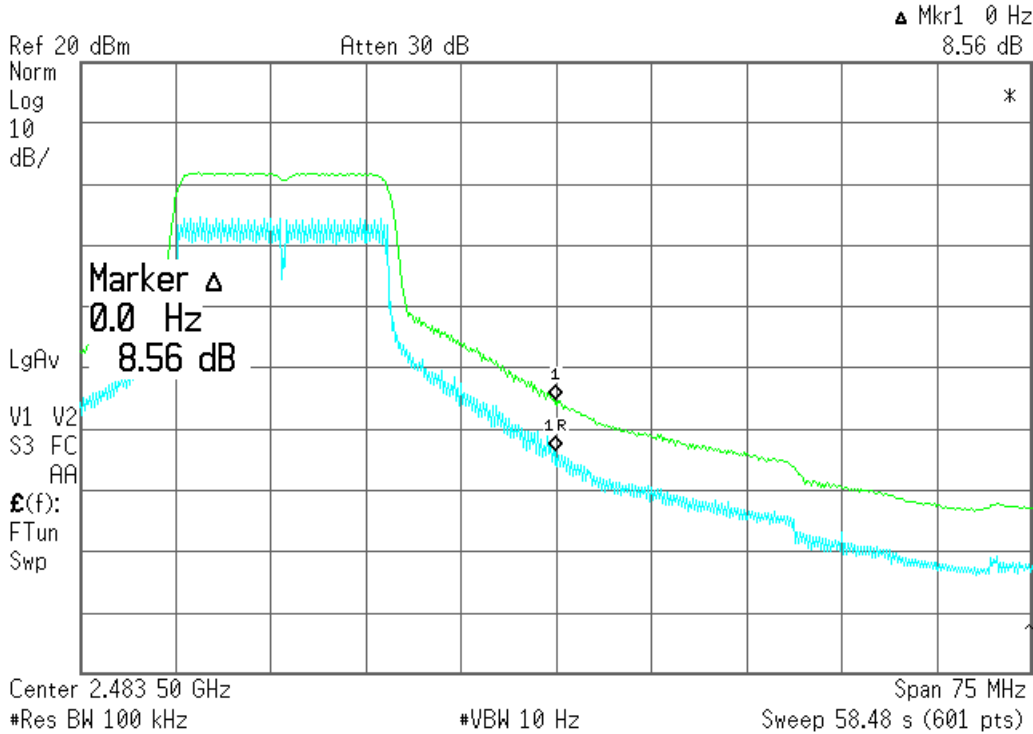

2483.5 MHz band edge
802.11 G
BW Delta Msmt, AVG
1M/10H to 100k/10H
(scrn 24)

Agilent 13:28:41 Feb 26, 2004

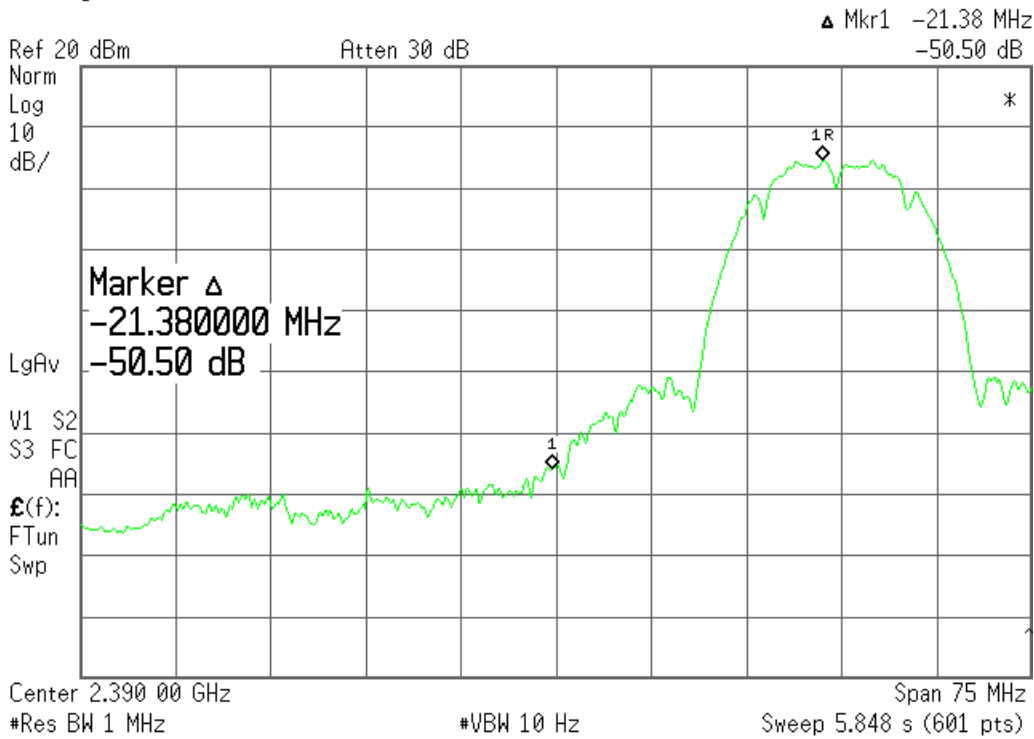

2390 MHz band edge
802.11 B
dBc Msmt, AVG
(scrn 34)

Agilent 13:37:53 Feb 26, 2004

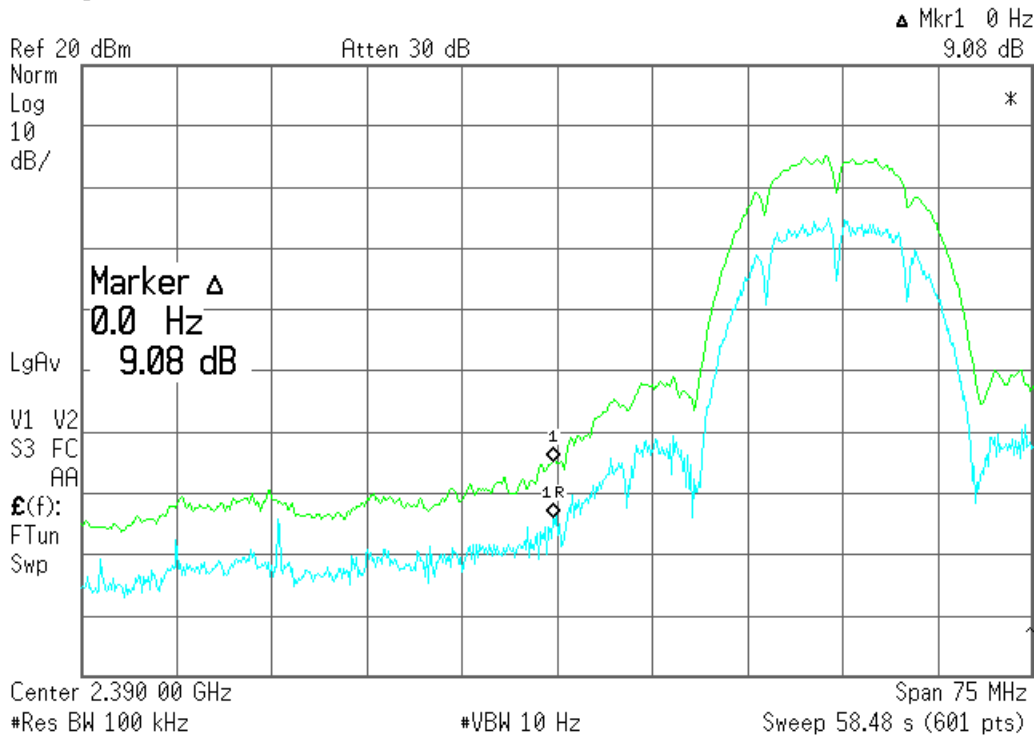

2390 MHz band edge
802.11 B
BW Delta Msmt,
AVG
1M/10H to
100k/10H
(scrn 35)

Agilent 13:07:09 Feb 26, 2004

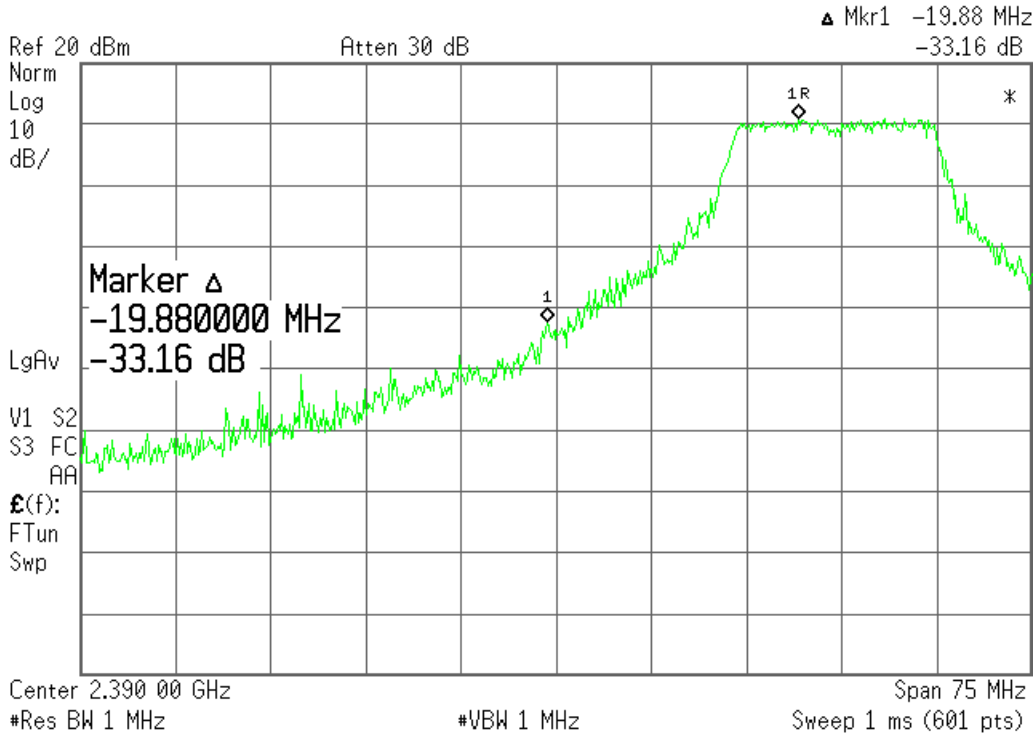

2390 MHz band edge
802.11 G
dBc Msmt, PK
(Scrn 26)

Agilent 13:17:06 Feb 26, 2004

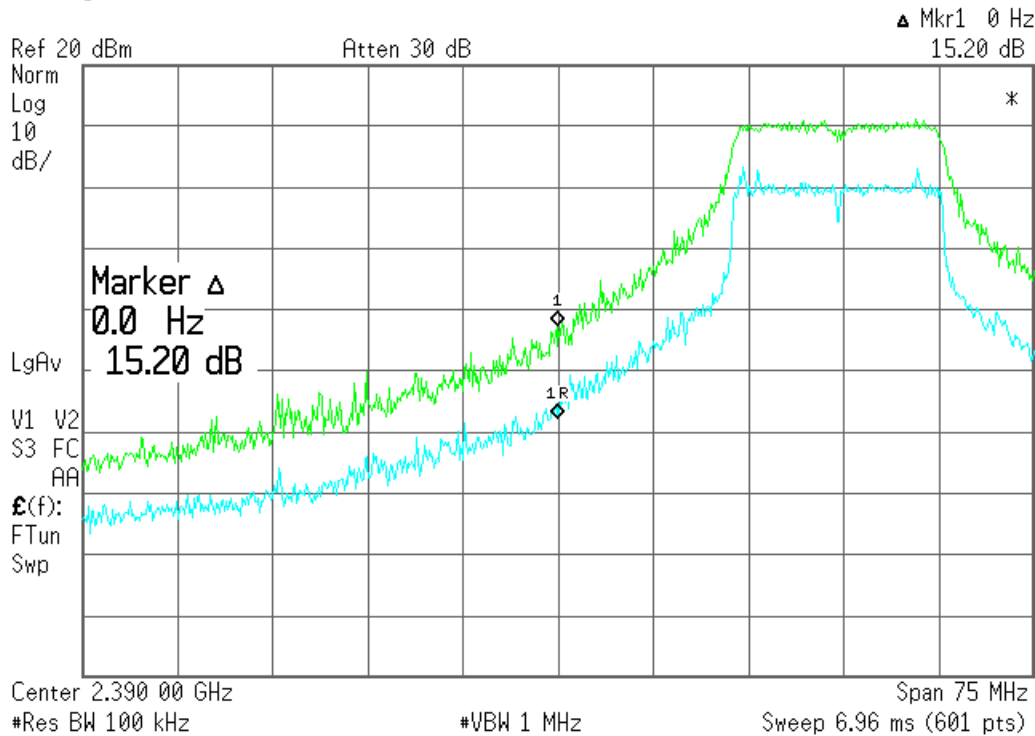

2390 MHz band edge
802.11 G
BW Delta Msmt,
AVG
1M/1M to 100k/1M
(scrn 30)

Agilent 13:12:49 Feb 26, 2004

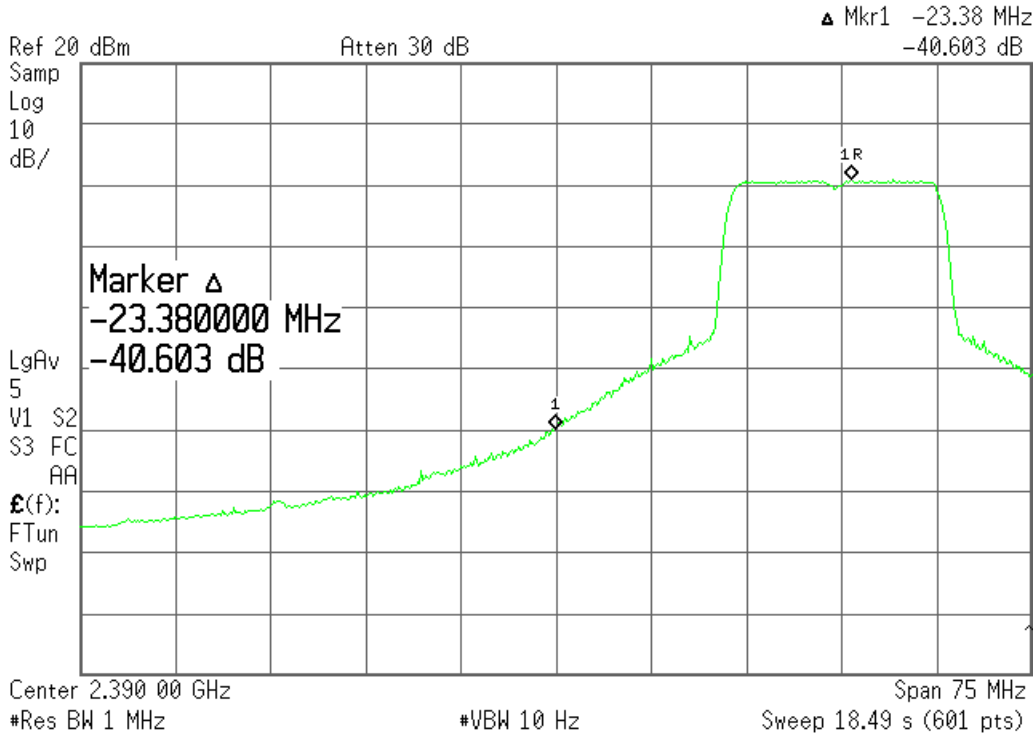

2390 MHz band edge
802.11 G
dBc Msmt, AVG
(Scr 28)

Agilent 13:20:20 Feb 26, 2004

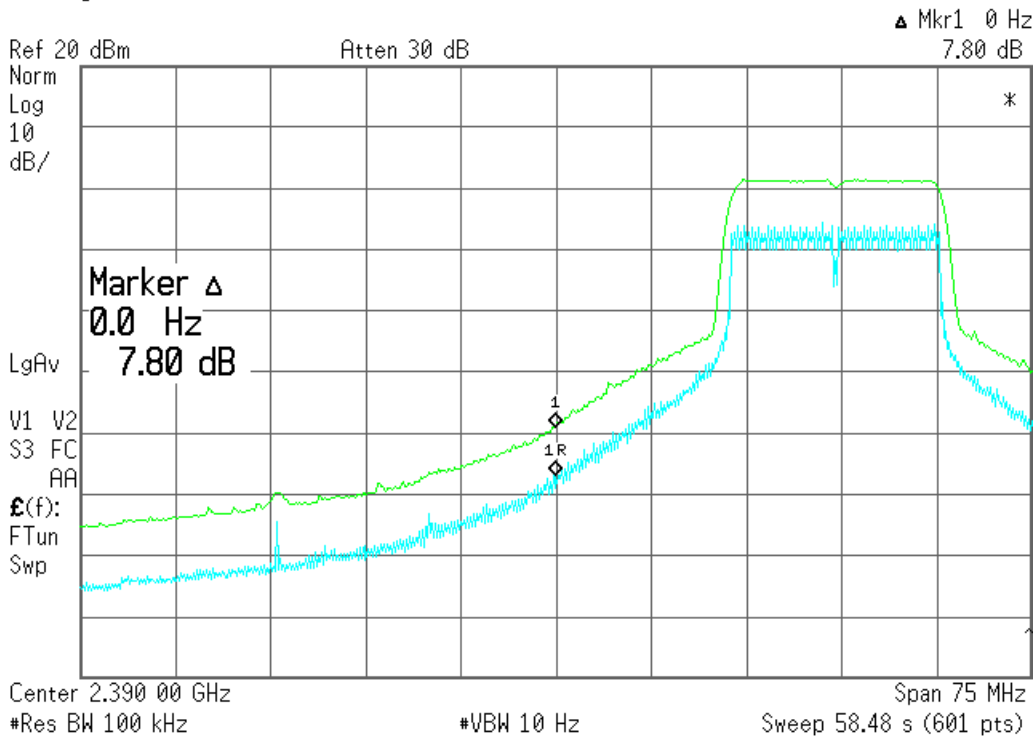

2390 MHz band edge
802.11 G
BW Delta Msmt,
AVG
1M/10H to 100k/10H
(scrn 31)

AC Line Conducted Emissions

Specification:

FCC Specification: Paragraph CISPR 22

Procedure:

The test was set up according to the guidelines set forth in EN55022:1998 and FCC Part 2 for AC Line Conducted Emissions. The measurement used a LISN line on each AC line and an EMI receiver. A peak scan was made over the measurement frequency range (150 kHz to 30 MHz). The highest peaks were then marked and re-measured and quasi-peaked and averaged.

The test was configured as shown below. The product was tested with an AC adapter while running on 120 VAC @ 60 Hz. The access point is also capable of running on power provided over the Ethernet lines from an Ethernet switch. Line conducted emissions out of the Ethernet switch were measured as part of the Ethernet switch Class A compliance testing. The AC emissions of the AC adapter are worse than that of the Ethernet switch, thus, the AC adapter results are presented below.

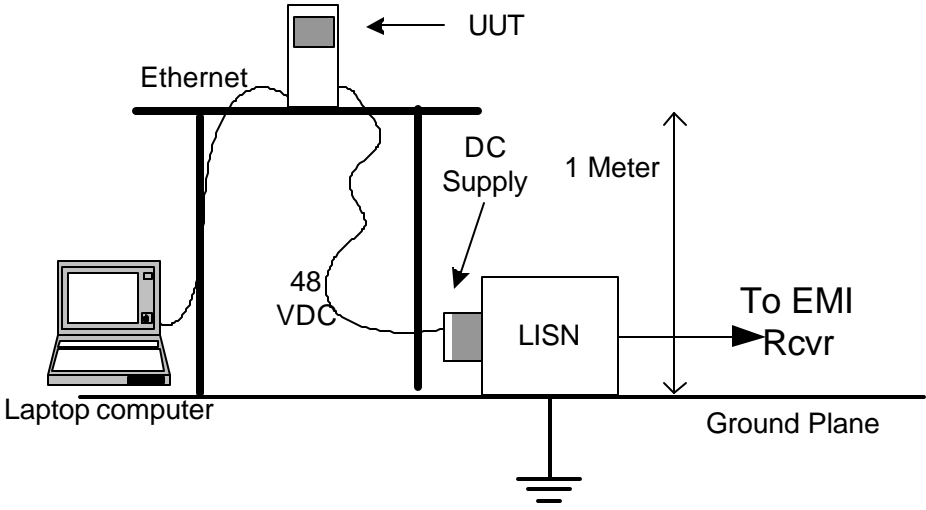

Results:

The “Quasi-peak” and the AVG results for the unit transmitting packets are contained in the table below

Note that all of the significant emissions occurred within a very narrow frequency band between approximately 25 and 30 MHz

Quasi Peak Test Results, CISPR 22 Class B limits

Freq (MHz)	Line	QP Level (dBuV)	Class B QP Limit (dBuV)	Delta (dB)	Freq (MHz)	Line	Class B QP Limit (dBuV)	Spec (dBuV)	Delta (dB)
	Neutral					Neutral			
25.83	Line	40.97	60	19.03	25.65.	Neutral	40.05	60	19.95
26.35	Line	47.89	60	12.11	26.35	Neutral	43.48	60	16.52
26.62	Line	41.25	60	18.75	26.62	Neutral	42.53	60	17.47
26.85	Line	46.92	60	13.08	26.84	Neutral	46.86	60	13.14
27.1	Line	46.91	60	13.09	27.1	Neutral	43.35	60	16.65
27.29	Line	58.75	60	1.25	27.59	Neutral	48.14	60	11.86
27.6	Line	46.98	60	13.02	27.86	Neutral	41.28	60	18.72
27.83	Line	48.61	60	11.39	28/09	Neutral	46.23	60	13.77
28.12	Line	41.46	60	18.54	28.32	Neutral	48.92	60	11.08
29.58	Line	45.29	60	14.71	28.57	Neutral	45.2	60	14.8

AVG Test Results, CISPR 22, Class B limits

Freq (MHz)	Line	AVG Level (dBuV)	Class B AVG limit (dBuV)	Delta (dB)	Freq (MHz)	Line	AVG Level (dBuV)	Class B AVG limit (dBuV)	Delta (dB)
	Neutral					Neutral			
25.83	Line	25.475	50	24.53	25.65.	Neutral	30.7	50	19.3
26.35	Line	30.23	50	19.77	26.35	Neutral	30.35	50	19.65
26.62	Line	31.44	50	18.56	26.62	Neutral	33.05	50	16.95
26.85	Line	34.257	50	15.74	26.84	Neutral	32.17	50	17.83
27.1	Line	29.59	50	20.41	27.1	Neutral	30.37	50	19.63
27.29	Line	36.118	50	13.9	27.59	Neutral	27.96	50	22.04
27.6	Line	28.64	50	21.36	27.86	Neutral	31.04	50	18.96
27.83	Line	29.9	50	20.1	28/09	Neutral	31.55	50	18.45
28.12	Line	34.03	50	15.97	28.32	Neutral	35.91	50	14.09
29.58	Line	32.43	50	17.57	28.57	Neutral	28.19	50	21.81