



Test report issued under the responsibility of:
EMITECH MONTPELLIER laboratory
MRA US-EU Designation Number: FR0006
Canadian CAB Identifier: FR0003

RADIO TEST REPORT

FCC part 15
FCC part 15.247
RSS-247_Issue 2, February 2017
ANSI C 63.10:2013
ANSI C 63.4:2014

Company: **ELA INNOVATION**
Address.....: 297 RUE MAURICE BEJART
34080 MONTPELLIER
FRANCE

Test item description: **BLUE ANCHOR FAMILY**
Trade Mark: BLUE ANCHOR FAMILY
Manufacturer: ELA INNOVATION
Model/Type reference.....: IDF32XXX
FCC ID.....: RVVBANCHPF1
IC: 20429-BANCHPF1
Ratings.....: 3.0Vdc to 3,6Vdc

Testing Laboratory: **EMITECH MONTPELLIER laboratory**
Address.....: 145 rue de Massacan
34740 VENDARGUES
FRANCE

Report Reference No.....: **RR410-19-104019-3A**
Test procedure: FCC IC Certification
Diffusion.....: MR LEBRUN
Applicant's name: ELA INNOVATION
Date of issue.....: February 19, 2020
Total number of pages.....: 69
Revision.....: 0
Modified page(s).....: Creation
Compiled by.....: Olivier AELBRECHT
Approved by (+ signature).....: David MONTAULON (Technical Manager)

Duplication of this test report is only permitted for an integral photographic facsimile. It includes the number of pages referenced here above. This document is the result of testing a specimen or a sample of the product submitted. It does not imply an assessment of the conformity of the whole manufactured products of the tested sample.



REPORT INDEX:

1. GENERAL INFORMATIONS	3
2. REFERENCE DOCUMENT(S).....	4
3. EQUIPMENT TECHNICAL DESCRIPTION	5
3.1. TEST CONDITIONS	5
3.2. EUT MARKING PLATE	5
3.3. EUT GENERAL VIEW	6
3.4. EUT ELECTRONIC BOARD	6
3.5. EUT MECHANICAL AND ELECTRICAL DESIGN.....	7
3.6. EUT INPUT/OUTPUT PORTS.....	7
3.7. EUT RADIO SPECIFICATIONS.....	8
4. EUT REQUIREMENTS FOR FCC RULES	9
4.1. SUBPART A - GENERAL	9
4.2. SUBPART B - UNINTENTIONAL RADIATORS	11
5. OPINION(S) AND INTERPRETATION(S).....	11
6. RESULT SUMMARY	12
7. RF EXPOSURE	12
8. MEASUREMENT UNCERTAINTY	13
9. TEST CONDITIONS AND RESULTS	14
9.1. DUTY CYCLE OF TEST SIGNAL	14
9.2. TRANSMITTER RADIATED SPURIOUS EMISSIONS AT FREQUENCIES <30MHZ.....	15
9.3. TRANSMITTER RADIATED SPURIOUS EMISSIONS AT FREQUENCIES >30MHZ.....	20
9.4. BAND-EDGE COMPLIANCE	34
9.5. MAXIMUM PEAK CONDUCTED POWER OF THE INTENTIONAL RADIATOR	41
9.6. 20DB & 6DB BANDWIDTH FOR DIGITALLY MODULATION SYSTEMS	49
9.7. POWER SPECTRAL DENSITY	57
9.8. OCCUPIED BANDWIDTH	62
9.9. MEASUREMENT OF FREQUENCY STABILITY.....	67

REVISION HISTORY:

Revision	Date	Modified pages	Modifications
0	February 19, 2020	/	Creation

1. GENERAL INFORMATIONS

This document submits the results of Radio tests performed on the equipment **BLUE ANCHOR FAMILY** (denominated hereafter E.U.T.: equipment under test) according to document(s) listed in §2 of this test report.

TESTING PROCEDURE AND TESTING LOCATION:					
Testing Location : EMITECH MONTPELLIER laboratory					
Address..... : 145 rue de Massacan 34740 VENDARGUES FRANCE					
Test procedure. : FCC IC Certification					
Tested by : Olivier AELBRECHT					
Test supervisor : None					
Date of receipt of test item..... : N/A					
Date (s) of performance of tests..... : From December the 16th to the 18th of 2019					
APPLICANT'S GENERAL INFORMATIONS:					
Company name : ELA INNOVATION					
Company address. : 297 RUE MAURICE BEJART 34080 MONTPELLIER FRANCE					
Person(s) present during the tests. : Mr BIBI					
Responsible..... : MR LEBRUN					
GENERAL REMARKS:					
<p>The information in italics is declared by the manufacturer and is under his responsibility The test results presented in this report relate only to the object tested. The results contained in this report reflect the results for this particular model and serial number. It is the responsibility of the manufacturer to ensure that all production models meet the intent of the requirements detailed within this report.</p> <p>"(see Enclosure #)" refers to additional information appended to the report. "(see appended table)" refers to a table appended to the report. Throughout this report the decimal separator is point.</p>					
POSSIBLE TEST CASE VERDICTS:					
Test case does not apply to the test object.. : N/A					
Test case not performed..... : N/P					
Test object does meet the requirement..... : P (Pass)					
Test object does not meet the requirement.. : F (Fail)					
DEFINITIONS AND ABBREVIATIONS:					
E.U.T.	Equipement under test	AE	Ancillary equipment	Pk	Peak detector
RBW	Resolution bandwidth	VBW	Video bandwidth	QP	Quasi-peak detector
OATS	Open area test site	FAR	Full anechoic room	Av	Average detector
VP	Vertical Polarization	HP	Horizontal Polarization	RMS	Root Mean Square
RF	Radio frequency	NTR	Nothing to report	N/C	Not communicated

2. REFERENCE DOCUMENT(S)

NORMATIVE REFERENCES:

The following referenced documents are necessary for the application of the present test report.

FCC part 15

Code of federal regulations. Title 47- Telecommunication Chapter 1- Federal Communication Commission. Part 15- Radio frequency devices Subpart B- Unintentional Radiators. Limits and methods of measurement of radio disturbance. Characteristic of information technology equipment

FCC part 15.247

Operation within the bands 902-928 MHz, 2400-2483.5 MHz, and 5725-5850MHz. (frequency hopping and digitally modulated)

RSS-247_Issue 2, February 2017

Digital Transmission Systems (DTSs), Frequency Hopping Systems (FHSs) and Licence Exempt Local Area Network (LE-LAN) Devices

ANSI C 63.10:2013

American National Standard of Procedures for Compliance Testing of Unlicensed Wireless Devices

ANSI C 63.4:2014

American National Standard for Methods of measurement of Radio-Noise from low-voltage Electrical and Electronic Equipment in the Range of 9 kHz to 40 GHz W

Although the product standard uses obsolete technical standards, the latest versions of standards achievable by the laboratory will be used for testing.

INFORMATIVE REFERENCES:

The following referenced documents are not necessary for the application of the present test report but they assist the user with regard to a particular subject area.

3. EQUIPMENT TECHNICAL DESCRIPTION

3.1. Test Conditions

Test item description. : BLUE ANCHOR FAMILY
Model/Type reference..... : IDF32XXX
Trade Mark. : BLUE ANCHOR FAMILY
Serial number (S/N)..... : Not communicated
Part number (P/N). : Not communicated
Software version..... : N/A
Firmware version. : *Not communicated*
Type of sample..... : Pre-serial
Function(s)..... : Depend on business application
Manufacturer name. : ELA INNOVATION
Address..... : 297 rue Maurice BEJART
 34080 MONTPELLIER
 FRANCE

General product information:

N/A

3.2. EUT Marking plate

During tests the marking plate was not present on EUT.
Hereunder an example of marking plate provided by the customer.



3.3. EUT General view

Front View



Back View



3.4. EUT Electronic board

Front View

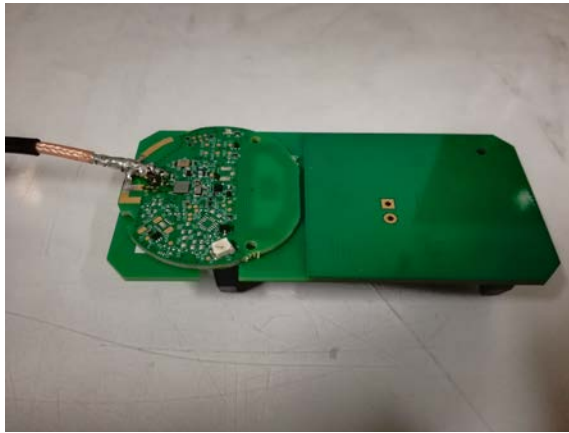

Back View



3.5. EUT Mechanical and Electrical Design

Power supply. : 3.6Vdc
 Power supply range..... : 3.6Vdc to 3.0Vdc
 Power type..... : Battery
 Power (W)..... : Not communicated
 Nominal current (A). : Not communicated
 Dimensions (L x W x H) (mm). : 119.2 x 51.2 x 24 mm
 Weight (g). : 122g
 Temperature range (°C). : -40°C to +85°C
 Ground bounding strap..... : No

Comments:

N/A

3.6. EUT Input/Output ports

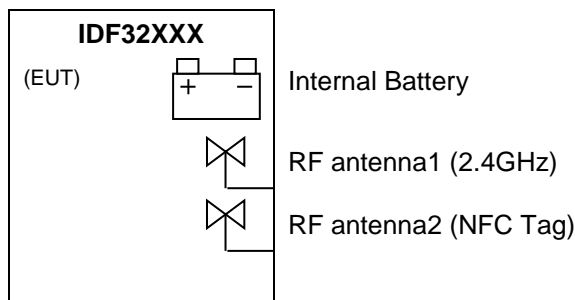

PORT	NAME	TYPE	LENGHT	CABLE TYPE	COMMENTS
0	Main frame	N/E	N/A	Plastic	
1	Internal Battery	DC	N/A	N/A	3.6Vdc
2	RF antenna 1	RF	N/A	N/A	PCB printed antenna used for QUUPPA and BLUETOOTH
3	RF antenna 2	RF	N/A	N/A	PCB printed antenna used for NFC

AC/DC : AC/DC Converter port
 I/O.....: Input or Output port
 N/E: Non Electrical port

AC.....: Alternative current port
 TP: Telecommunication port

DC.....: Discontinuous current port
 RF.....: Radio frequency port

3.7. EUT Radio Specifications

a) GENERAL INFORMATIONS	
According to manufacturer's declarations :	
EUT type.....	: <i>Transceiver</i>
Technology	: <i>QUUPPA/BLEUTOOTH</i>
Environmental profile.....	: <i>Data transmissions</i>
Temperature range.....	: <i>-40°C to +85°C</i>
Antenna type	: <i>Internal Antenna</i>
Antenna Gain.....	: <i>Not communicated</i>
Comments:	
b) TRANSMITTER PARAMITERS (Tx)	
Frequency bands	: <i>2400Mhz to 2483.5Mhz</i>
RF Power.....	: <i>+4dBm</i>
Number of channels / Separation.....	: <i>81 channels each 1MHz</i>
Modulation type	: <i>GFSK</i>
Duty cycle	: <i>Not communicated</i>
Tested frequency.....	: <i>2401MHz (Low Channel)</i> <i>2441MHz (Mid Channel)</i> <i>2481MHz (High Channel)</i>
c) RECEIVER PARAMETERS (Rx)	
Frequency bands	: <i>2400Mhz to 2483.5Mhz</i>
Category/Class	: <i>Not communicated</i>
Bandwidth	: <i>Not communicated</i>

4. EUT REQUIREMENTS FOR FCC RULES

4.1. Subpart A - General

This part sets out the regulations under which an intentional, unintentional, or incidental radiator may be operated without an individual license. It also contains the technical specifications, administrative requirements and other conditions relating to the marketing of part 15 devices.

The user notice **Not communicated**, shall include the following informations:

a) LABELING REQUIREMENTS (§15.19):
<p>Equipment authorization: Supplier's Declaration of Conformity (SDoC) or Certification</p> <p>List of different type of devices and associated "<i>statement on product</i>":</p> <p>§15.19(a)(1) - Receivers associated with the operation of a licensed radio service: <i>"This device complies with part 15 of the FCC Rules. Operation is subject to the condition that this device does not cause harmful interference."</i></p> <p>§15.19(a)(2) - A stand-alone cable input selector switch: <i>"This device complies with part 15 of the FCC Rules for use with cable television service."</i></p> <p>§15.19(a)(3) - All other devices: <i>"This device complies with part 15 of the FCC Rules. Operation is subject to the following two conditions:</i> <i>(1) This device may not cause harmful interference, and</i> <i>(2) this device must accept any interference received, including interference that may cause undesired operation.</i></p> <p>§15.19(a)(4) - Where a device is constructed in two or more sections connected by wires and marketed together: The statement specified only to the main control unit: <i>"This device complies with part 15 of the FCC Rules. Operation is subject to the condition that this device does not cause harmful interference."</i></p> <p>§15.19(a)(5) - When the device is so small: The statement of §15.19(a) shall be placed in the user manual and must also either be placed on the device packaging or on a removable label attached to the device.</p> <p>Compliance information (§2.1077): The identification, by name, address and telephone number or internet contact information, of the responsible party, as defined in § 2.909 of the standard. The responsible party for Supplier's Declaration of Conformity must be located within the United States.</p> <p>Identification (§2.1074): (a) Devices subject only to Supplier's Declaration of Conformity shall be uniquely identified by the party responsible for marketing or importing the equipment within the United States. (b) Devices subject to authorization under Supplier's Declaration of Conformity may be labeled with the following logo on a voluntary basis as a visual indication that the product complies with the applicable FCC requirements.</p> <div style="text-align: center;">  <p>(image size: 6.7 x 2.8" ;3.5 x 1.4" ;1.6 x .7")</p> </div>

The label shall be located in a conspicuous location on the device.

The label shall not be a stick-on, paper label. The label on these products shall be permanently affixed to the product and shall be readily visible (font of at least 4-point or larger) to the purchaser at the time of purchase.

EUT LABEL

During tests the marking plate was not present on EUT.
Hereunder an example of marking plate provided by the customer.

**b) INFORMATION TO USER (§15.21):**

The users manual or instruction manual for an intentional or unintentional radiator shall caution the user that:
“The grantee is not responsible for any changes or modifications not expressly approved by the party responsible for compliance. Such modifications could void the user’s authority to operate the equipment”

4.2. Subpart B - Unintentional Radiators

In addition to Subpart A, the user notice Not communicated, shall include the following informations:

a) INFORMATION TO USER (§15.105):
<p>Equipment authorization: Supplier's Declaration of Conformity (SDoC) or Certification</p> <p>§15.105(a) - For a Class A digital device or peripheral, the instructions furnished the user shall include the following or similar statement, placed in a prominent location in the text of the manual:</p> <p><i>“NOTE: This equipment has been tested and found to comply with the limits for a Class A digital device, pursuant to part 15 of the FCC Rules. These limits are designed to provide reasonable protection against harmful interference when the equipment is operated in a commercial environment. This equipment generates, uses, and can radiate radio frequency energy and, if not installed and used in accordance with the instruction manual, may cause harmful interference to radio communications. Operation of this equipment in a residential area is likely to cause harmful interference in which case the user will be required to correct the interference at his own expense.”</i></p> <p>§15.105(b) - For a Class B digital device or peripheral, the instructions furnished the user shall include the following or similar statement, placed in a prominent location in the text of the manual:</p> <p><i>“NOTE: This equipment has been tested and found to comply with the limits for a Class B digital device, pursuant to part 15 of the FCC Rules. These limits are designed to provide reasonable protection against harmful interference in a residential installation. This equipment generates, uses and can radiate radio frequency energy and, if not installed and used in accordance with the instructions, may cause harmful interference to radio communications. However, there is no guarantee that interference will not occur in a particular installation. If this equipment does cause harmful interference to radio or television reception, which can be determined by turning the equipment off and on, the user is encouraged to try to correct the interference by one or more of the following measures:</i></p> <ul style="list-style-type: none"> <i>—Reorient or relocate the receiving antenna.</i> <i>—Increase the separation between the equipment and receiver.</i> <i>—Connect the equipment into an outlet on a circuit different from that to which the receiver is connected.</i> <i>—Consult the dealer or an experienced radio/TV technician for help.”</i>

5. OPINION(S) AND INTERPRETATION(S)

TEST(S) PERFORMED	DEVIATION(S) TO TEST METHOD(S)
FCC part 15.247 and RSS-247	N/A
FCC part 15.109, 15.209, 15.205, 15.215 RSS-247, RSS Gen	N/A

Comments: N/A

6. RESULT SUMMARY

TEST DESIGNATION	SEVERITY	VERDICT	BASIC STANDARDS / COMMENTS
Conducted emissions Transmitter radiated spurious emissions at frequencies <30MHz - Tx Mode / 0° / All Channels - Tx Mode / 45° / All Channels - Tx Mode / 90° / All Channels Transmitter radiated spurious emissions at frequencies >30MHz - Tx mode - All Channels for Freq < 1Ghz - Tx mode - Low Channel for Freq > 1Ghz - Tx mode - Mid Channel for Freq > 1Ghz - Tx mode - High Channel for Freq > 1Ghz Operation within the band 902-928MHz, 2400-2483.5MHz and 5725-5850MHz - Frequency hopping and digitally modulated - Frequency hopping system - Digital modulation system - Maximum peak conducted output power - For hopping system in the 2400-2483.5 MHz and 5725-5850 MHz bands - For hopping system in the 902-928MHz band - For system using digital modulation in the 902-928 MHz, 2400-2483.5 MHz and 5725-5850 MHz bands - Operation with directional antenna gains > 6 dBi - Out-of-band emissions - Power spectral density conducted - Hybrid system - Frequency hopping additional requirements - Frequency hopping intelligence - RF exposure compliance		N/A PASS PASS PASS PASS PASS PASS PASS - N/A PASS - N/A N/A PASS N/A PASS PASS N/A N/A N/A N/A PASS	Powered by internal batteries ANSI C63.10: 2013 ANSI C63.10: 2013 15.247 / RSS 247 a) a) (1) a) (2) b) b) (1) b) (2) b) (3) / EUT has its dedicated internal PCB antenna, due to this, this measurement was done in radiated. Integral antenna d) e) f) g) h) i)

Sample subject to the test complies for tests done with the requirements of the reference document(s) listed in §2 of this test report and, where applicable, with deviation(s) specified in this document.

To declare, or not, the compliance with the specifications, it was not explicitly taken account of uncertainty associated with the results.

TEST(S) PERFORMED	MODIFICATION(S)
FCC part 15.247 and RSS-247, FCC part 15.109, 15.209 and RSS Gen	N/A

7. RF EXPOSURE

Maximum EIRP with = 3.133 mW (eirp) at 2441MHz

In accordance with KDB 447498 D01 General RF Exposure Guidance v06:

$$PSD = \frac{EIRP}{(4 \cdot \pi \cdot R^2)} = \frac{3.133}{(4 \cdot \pi \cdot (20 \text{ cm})^2)} = 0.001 \text{ mW/cm}^2$$

$$\text{Limit} = 1 \text{ mW/cm}^2$$

8. MEASUREMENT UNCERTAINTY

PARAMETER	MAXIMAL EMITECH UNCERTAINTY	MINIMAL STANDARD UNCERTAINTY
Radio frequency	$\pm 1 \times 10^{-7}$	$\pm 1 \times 10^{-7}$
RF power, conducted		
RF power	$\pm 0.8\text{dB}$	$\pm 1 \text{ dB}$
Power spectral density	$\pm 2.3\text{dB}$	$\pm 3 \text{ dB}$
Occupied bandwidth		
RF power	$\pm 3.8 \%$	$\pm 5 \%$
Maximum frequency deviation		
300 Hz < audio frequency < 6 kHz	$\pm 1.2 \%$	$\pm 5 \%$
6 kHz < audio frequency < 25 kHz	$\pm 1.2 \%$	$\pm 3 \text{ dB}$
Adjacent channel power	$\pm 1.6 \text{ dB}$	$\pm 3 \text{ dB}$
Sensibility of receiver (conducted)	$\pm 2.0 \text{ dB}$	$\pm 3 \text{ dB}$
Blocking	$\pm 4.0 \text{ dB}$	$\pm 4 \text{ dB}$
Transitoire		
Amplitude	$\pm 8.5 \%$	$\pm 20 \%$
At the frequency	$\pm 166 \text{ Hz}$	$\pm 250 \text{ Hz}$
Conducted emission (spurious)		
$f \leq 1 \text{ GHz}$	$\pm 0.8 \text{ dB}$	
1 GHz - 12.75 GHz	$\pm 1.6 \text{ dB}$	$\pm 3 \text{ dB}$
Radiated emission (PAR / PIRE / RNE)		
$f \leq 62.5 \text{ MHz}$	$\pm 5.1 \text{ dB}$	$\pm 6 \text{ dB}$
62.5 MHz - 1 GHz	$\pm 5.1 \text{ dB}$	$\pm 6 \text{ dB}$
1 GHz - 18 GHz	$\pm 5.2 \text{ dB}$	$\pm 6 \text{ dB}$
18 GHz – 26 GHz	$\pm 5.1 \text{ dB}$	$\pm 6 \text{ dB}$
26 GHz – 40 GHz	$\pm 5.4 \text{ dB}$	$\pm 6 \text{ dB}$
180-1000 MHz / 1 – 12.75 GHz (EN 301 908-1)	$\pm 3.0 / 2.9 \text{ dB}$	$\pm 3 \text{ dB}$
RF power (EN 300328 / EN 301893)	$\pm 5.3 \text{ dB}$	$\pm 6 \text{ dB}$
PIRE and power spectral density with diode	$\pm 5.2 \text{ dB}$	$\pm 6 \text{ dB}$
Radiated emission (magnetic field)		
9kHz – 30MHz	$\pm 3 \text{ dB}$	$\pm 6 \text{ dB}$
RF level for a given BER	$\pm 0.8 \text{ dB}$	$\pm 1.5 \text{ dB}$
Supply voltages	$\pm 3 \%$	$\pm 3 \%$
Temperature	$\pm 1 \text{ }^\circ\text{C}$	$\pm 1^\circ\text{C}$
Humidity	$\pm 5 \%$	$\pm 5 \%$
Time / Duty cycle	$\pm 4.4 \%$	$\pm 5 \%$
Adaptivity	$\pm 2.9 \text{ dB}$	/
Radiated emission (electric field for FCC standard)		
9kHz – 30MHz	$\pm 2.7 \text{ dB}$	/
30MHz – 1GHz	$\pm 5.0 \text{ dB}$	/
1GHz – 18GHz	$\pm 5.6 \text{ dB}$	/
18GHz – 26GHz	$\pm 5.7 \text{ dB}$	/
26GHz – 40GHz	$\pm 5.7 \text{ dB}$	/

For the calcul of expanded uncertainty, the confidence interval is 95 % (k=2).

9. TEST CONDITIONS AND RESULTS

9.1. Duty Cycle of Test Signal

Reference standard:	FCC part 15 Radio part 15.247 and RSS-247
Test method:	ANSI C63.10 : 2013 §11
Test description: EUT is directly connected to a spectrum analyser using attenuators.	

TEST EQUIPMENT USED					
CATEGORY	BRAND	TYPE	IDENTIFIER	CAL. DATE	CAL. DUE
Attenuator	Radiall	R412710124	16491	25/06/2019	25/08/2021
Cable	N	3m	16426	04/05/2019	04/07/2021
Cable	Huber + Suhner	SF102K	16041	28/02/2019	28/04/2021
Spectrum analyzer	Rohde & Schwarz	FSW43	14830	28/12/2018	28/02/2020
Thermohyrometer	Testo	608-H2	12268	27/11/2017	27/01/2020

DUTY CYCLE OF TEST SIGNAL - GRAPH			
EUT mode:	Continuous modulated Tx	T (°C):	22.2
Test Date:	17/12/2019	H (%):	44.5
Test Operator:	OAT	P (hPa):	998

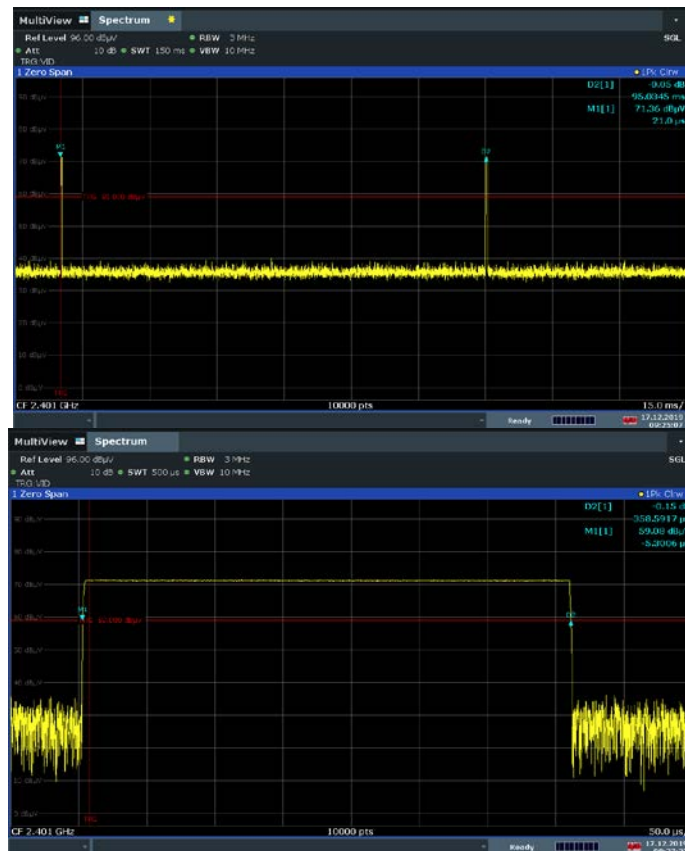

Duty Cycle = $0.358/95.035 = 0.0037$ (0.37%)

Duty Factor = $10 * \log(1/0.0037) = 24.32$

Duty cycle test mode is < 98%. A **24.32dB** duty factor shall be considered.

9.2. Transmitter radiated spurious emissions at frequencies <30MHz

Reference standard:	FCC part 15 Radio part 15.247 and RSS-247
Test method:	ANSI C63.4: 2014 & ANSI C63.10: 2013
<p>Test description: EUT is set on an insulating support at 80cm above the ground reference plane.</p> <p>Preliminary (peak) measurements were performed at an antenna to EUT separation distance of 3-meter in a anechoic chamber. The EUT was rotated 360° in order to maximize radiated levels. Test antenna was oriented in 3 axes (0°, 45° and 90°).</p> <p>Final measurements (quasi-peak) were then performed in a 10-meter Open Area Test Site that complies to CISPR 16 in the same measurement conditions.</p> <p>All frequencies were investigated, where applicable.</p>	

TESTED CONFIGURATION	PARAMETER	SEVERITY	RESULT TAB.	VERDICT
Tx Mode / 0° / All Channels	9kHz-30MHz	15.209	EMI4598	PASS
Tx Mode / 45° / All Channels	9kHz-30MHz	15.209	EMI4599	PASS
Tx Mode / 90° / All Channels	9kHz-30MHz	15.209	EMI4600	PASS

LABORATORY PARAMETERS:	REQUIRED PRIOR TO THE TEST	DURING THE TEST
Ambient Temperature	15 to 35 °C	See Graph(es)
Relative Humidity	20 to 75 %	See Graph(es)
Atmospheric pressure	N/A	See Graph(es)
Test method deviation: N/A		
Supplementary information: From 9 kHz to 30MHz: limit indicated on the curves is calculated with 40 dB/decade extrapolation factor and 51.5 dB conversion factor.		

TEST EQUIPMENT USED					
CATEGORY	BRAND	TYPE	IDENTIFIER	CAL. DATE	CAL. DUE
Antenna	Rohde & Schwarz	HFH2-Z2	5825(*)	21/09/2017	21/05/2020
Cable	MegaPhase	N-3m	14853	12/02/2018	12/04/2020
Cable	SUCOFLEX	N-6,5m	14380	25/07/2019	25/09/2021
Cable	MegaPhase	N-8m	15813	12/11/2018	12/01/2021
Cable	Huber + Suhner	SF102K	16041	28/02/2019	28/04/2021
Receiver	Rohde & Schwarz	FSW43	14830	28/12/2018	28/02/2020
Shielded enclosure	COMTEST	SAC 3m	14494		
Software	Nexio		0000		
Thermohygrometer	Testo	608-H2	12269	27/11/2017	27/01/2020
Turntable	Maturo	NCD	14657		

BAT-EMC software version: V3.18.0.26

Blank cells = Permanent validity

(*) Under derogation EQS DER 000 S41 00068

TEST SETUP PHOTO(S)

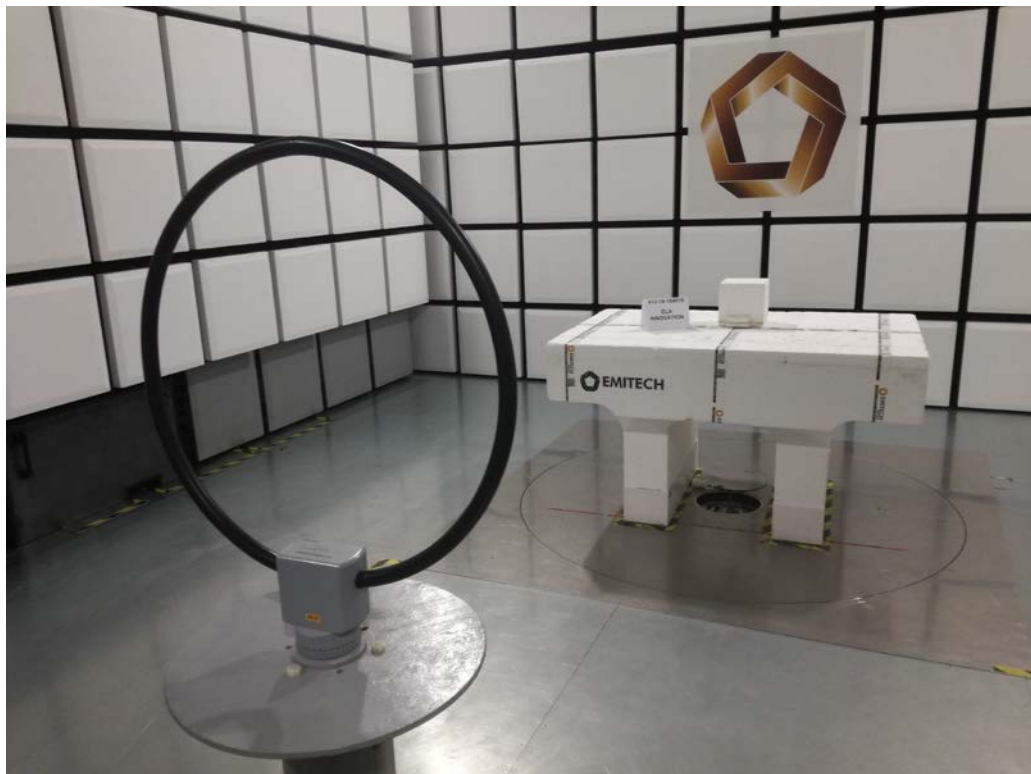
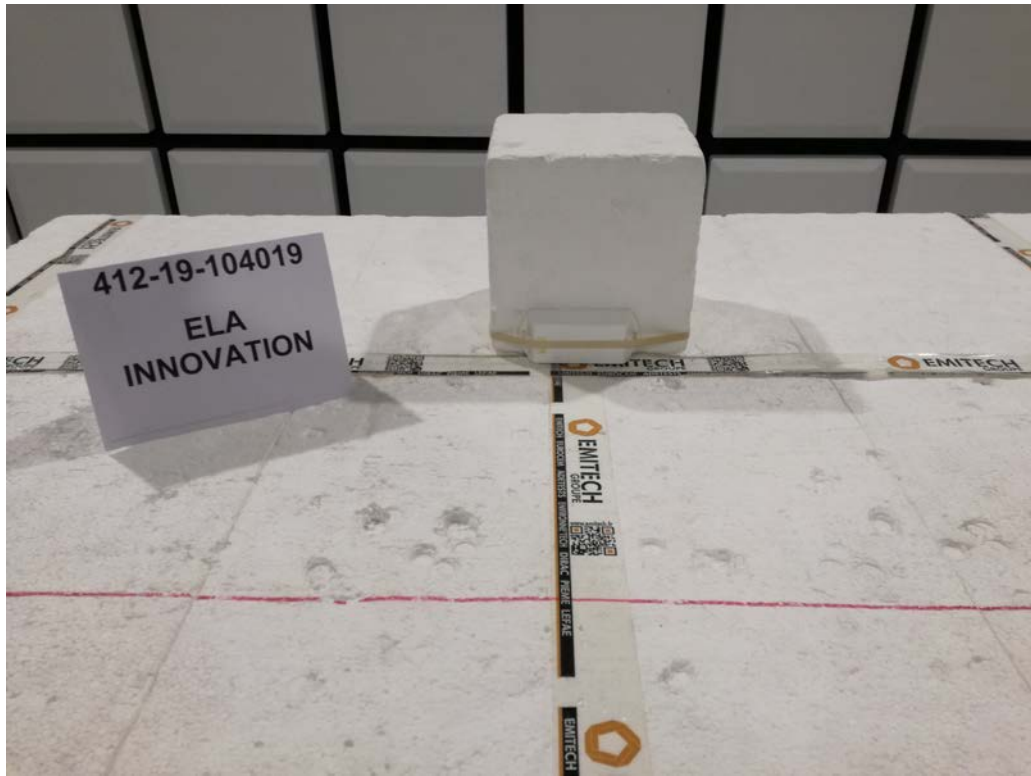

TRANSMITTER RADIATED SPURIOUS EMISSIONS - TABULATED RESULTS							
Frequency (MHz)	Polarization	Level Peak (dBµV/m)	Level Avg (dBµV/m)	Limit Qpeak (dBµV/m)	Limit Peak (dBµV/m)	Limit Avg (dBµV/m)	Margin dB
N/A	N/A	N/A	N/A	N/A	N/A	N/A	N/A

No spurious emissions were detected.

TRANSMITTER RADIATED SPURIOUS EMISSIONS AT FREQUENCIES <30MHz - GRAPH			
Tx MODE / 0° / ALL CHANNELS			EMI4598
EUT mode:	Continuous modulated Tx		T (°C): 19.3
Test Date:	18/12/2019 08:01:08		H (%): 64.8
Test Operator:	OAT		P (hPa): 992

— FCC/FCC Part 15 §209 Tx - Moyenne/3.0m/
— FCC/FCC Part 15 §209 Tx - QCrête/3.0m/
— Meas.Peak

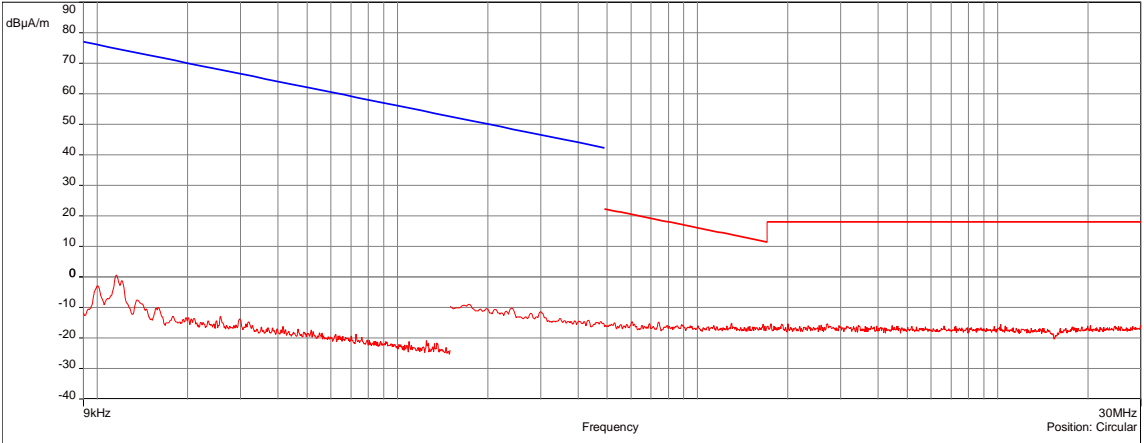

POSITION	FREQUENCIES	RBW	VBW	DETECTOR
Circular	9kHz-150kHz	300Hz	1kHz	Peak
Circular	150kHz-1MHz	10kHz	30kHz	Peak
Circular	1MHz-30MHz	10kHz	30kHz	Peak

Configuration:

Comments: Limit indicated on these plots are calculated with 40 dB/decade extrapolation factor and 51.5dB conversion factor.

EUT modification(s): N/A

TRANSMITTER RADIATED SPURIOUS EMISSIONS AT FREQUENCIES <30MHz - TABULATED RESULTS			
Tx MODE / 0° / ALL CHANNELS			EMI4598
Frequency (MHz)	Antenna Position	Level (dBµA/m)	Limit (dBµA/m)
N/A	N/A	N/A	N/A

No spurious emissions were detected.

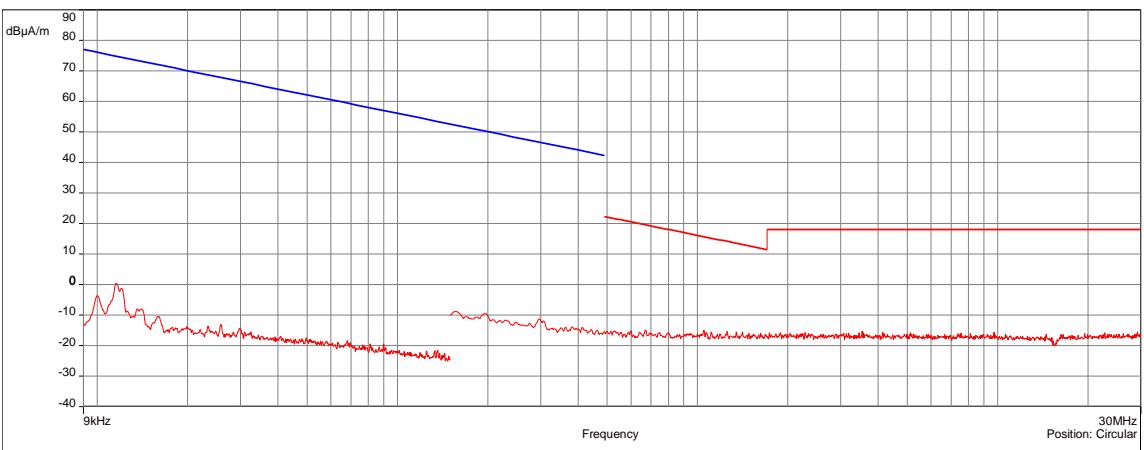
TRANSMITTER RADIATED SPURIOUS EMISSIONS AT FREQUENCIES <30MHz - GRAPH				
Tx MODE / 45° / ALL CHANNELS				EMI4599
EUT mode:	Continuous modulated Tx			T (°C): 19.3
Test Date:	18/12/2019 08:05:04			H (%): 64.8
Test Operator:	OAT			P (hPa): 992
				
POSITION	FREQUENCIES	RBW	VBW	DETECTOR
Circular	9kHz-150kHz	300Hz	1kHz	Peak
Circular	150kHz-1MHz	10kHz	30kHz	Peak
Circular	1MHz-30MHz	10kHz	30kHz	Peak
Configuration:				
Comments:	Limit indicated on these plots are calculated with 40 dB/decade extrapolation factor and 51.5dB conversion factor.			
EUT modification(s): N/A				

TRANSMITTER RADIATED SPURIOUS EMISSIONS AT FREQUENCIES <30MHz - TABULATED RESULTS			
Tx MODE / 45° / ALL CHANNELS			EMI4599
Frequency (MHz)	Antenna Position	Level (dBµA/m)	Limit (dBµA/m)
N/A	N/A	N/A	N/A

No spurious emissions were detected.

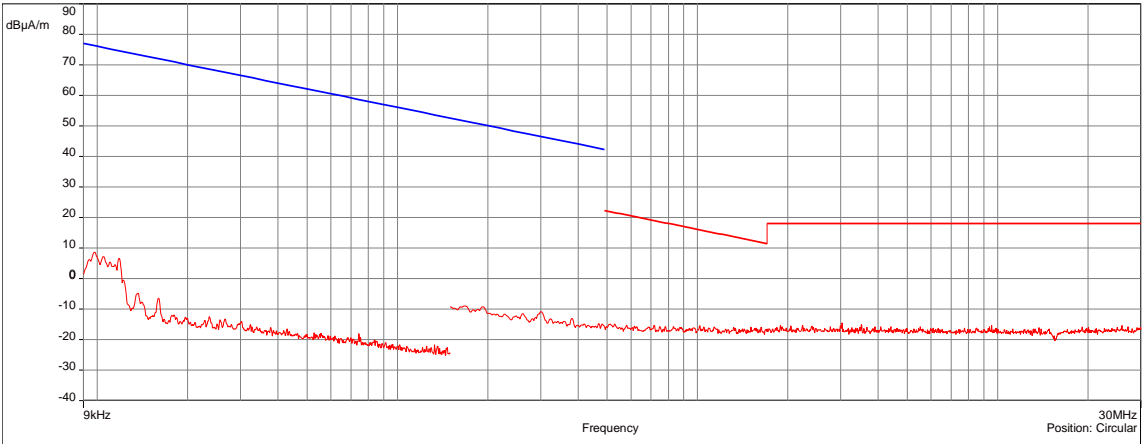
TRANSMITTER RADIATED SPURIOUS EMISSIONS AT FREQUENCIES <30MHz - GRAPH				
Tx MODE / 90° / ALL CHANNELS			EMI4600	
EUT mode:	Continuous modulated Tx		T (°C):	19.3
Test Date:	18/12/2019 08:08:12		H (%):	64.8
Test Operator:	OAT		P (hPa):	992
<div style="text-align: right;"> <p>— FCC/FCC Part 15 §209 Tx - Moyenne/3.0m/ — FCC/FCC Part 15 §209 Tx - QCrête/3.0m/ — Meas.Peak</p> </div> 				
POSITION	FREQUENCIES	RBW	VBW	DETECTOR
Circular	9kHz-150kHz	300Hz	1kHz	Peak
Circular	150kHz-1MHz	10kHz	30kHz	Peak
Circular	1MHz-30MHz	10kHz	30kHz	Peak
Configuration:				
Comments:	Limit indicated on these plots are calculated with 40 dB/decade extrapolation factor and 51.5dB conversion factor.			
EUT modification(s): N/A				

TRANSMITTER RADIATED SPURIOUS EMISSIONS AT FREQUENCIES <30MHz - TABULATED RESULTS			
Tx MODE / 90° / ALL CHANNELS			EMI4600
Frequency (MHz)	Antenna Position	Level (dBµA/m)	Limit (dBµA/m)
N/A	N/A	N/A	N/A

No spurious emissions were detected.

9.3. Transmitter radiated spurious emissions at frequencies >30MHz

Reference standard:	FCC part 15 Radio part 15.247 and RSS-247
Test method:	ANSI C63.10: 2013
<p>General test setup: EUT is set on an insulating support at 80cm above the ground reference plane (150cm for f >1GHz).</p> <p>Preliminary (peak) measurements were performed at an antenna to EUT separation distance of 3-meter. The EUT was rotated 360° about its azimuth with the receive antenna located at various heights in horizontal and vertical polarities.</p> <p>Final measurements (quasi-peak or average) were then performed in a semi-anechoic chamber or Open Area Test Site that complies to CISPR 16. The EUT was rotated 360° about its azimuth and adjusting the receive antenna height from 1 to 4 m.</p> <p>All frequencies were investigated, where applicable.</p> <p>For portable equipments a research of maximum level is done on the 3 axes. Only the highest levels are recorded.</p>	

TESTED CONFIGURATION	PARAMETER	SEVERITY	RESULT TAB.	VERDICT
Tx mode - All Channels for Freq < 1Ghz	30MHz-1GHz	15.209	EMI4597	PASS
Tx mode - Low Channel for Freq > 1Ghz	1GHz-18GHz		EMI4554	PASS
Tx mode - Mid Channel for Freq > 1Ghz	1GHz-18GHz		EMI4575	PASS
Tx mode - High Channel for Freq > 1Ghz	1GHz-18GHz		EMI4574	PASS

LABORATORY PARAMETERS:	REQUIRED PRIOR TO THE TEST	DURING THE TEST
Ambient Temperature	15 to 35 °C	See Graph(es)
Relative Humidity	20 to 75 %	See Graph(es)
Atmospheric pressure	N/A	See Graph(es)
Test method deviation: N/A		
Supplementary information: N/A		

TEST EQUIPMENT USED					
CATEGORY	BRAND	TYPE	IDENTIFIER	CAL. DATE	CAL. DUE
Antenna	ETS-Lindgren	3117	5456	24/07/2019	24/09/2022
Antenna	Electro Metrics	BIA-30HF	0824	13/06/2018	13/08/2021
Antenna	Rohde & Schwarz	HL223	3126	13/06/2018	13/08/2021
Cable	MegaPhase	F135N1N28	16664	25/10/2019	25/12/2021
Cable	MegaPhase	F135N1N28	16666	25/10/2019	25/12/2021
Cable	SUCOFLEX	N-3m	14378	25/06/2019	25/08/2021
Cable	SUCOFLEX	N-3m	14379	25/06/2019	25/08/2021
Cable	MegaPhase	N-3m	14852	29/10/2018	29/12/2020
Cable	MegaPhase	N-3m	14853	12/02/2018	12/04/2020
Cable	MegaPhase	N-5m	14855	12/02/2018	12/04/2020
Cable	SUCOFLEX	N-6,5m	14380	25/07/2019	25/09/2021
Cable	MegaPhase	N-8m	15813	12/11/2018	12/01/2021
Cable	Huber + Suhner	SF102K	16041	28/02/2019	28/04/2021
Filter	Micro-Tronics	HPM 15162	10273	11/01/2019	11/03/2021
Filter	Micro-Tronics	HPM18865	12843	08/06/2018	08/08/2020
Filter	Wainwright	WRCGV	9771	07/01/2019	07/03/2021

CATEGORY	BRAND	TYPE	IDENTIFIER	CAL. DATE	CAL. DUE
	Instruments	2402/2480- 2380/2500- 40/10EE-200W			
Preamplifier	Techniwave	APS16-0087	14040	25/06/2019	25/08/2020
Receiver	Rohde & Schwarz	FSW43	14830	28/12/2018	28/02/2020
Shielded enclosure	RAY PROOF	C.V2	1423		
Shielded enclosure	COMTEST	SAC 3m	14494		
Software	Nexio		0000		
Thermohygrometer	Testo	608-H1	7562	25/01/2019	25/03/2021
Thermohygrometer	Testo	608-H2	12269	27/11/2017	27/01/2020
Thermohygrometer	Bioblock Scientific	Météostar	0963	25/01/2019	25/03/2021

BAT-EMC software version: V3.18.0.26

Blank cells = Permanent validity

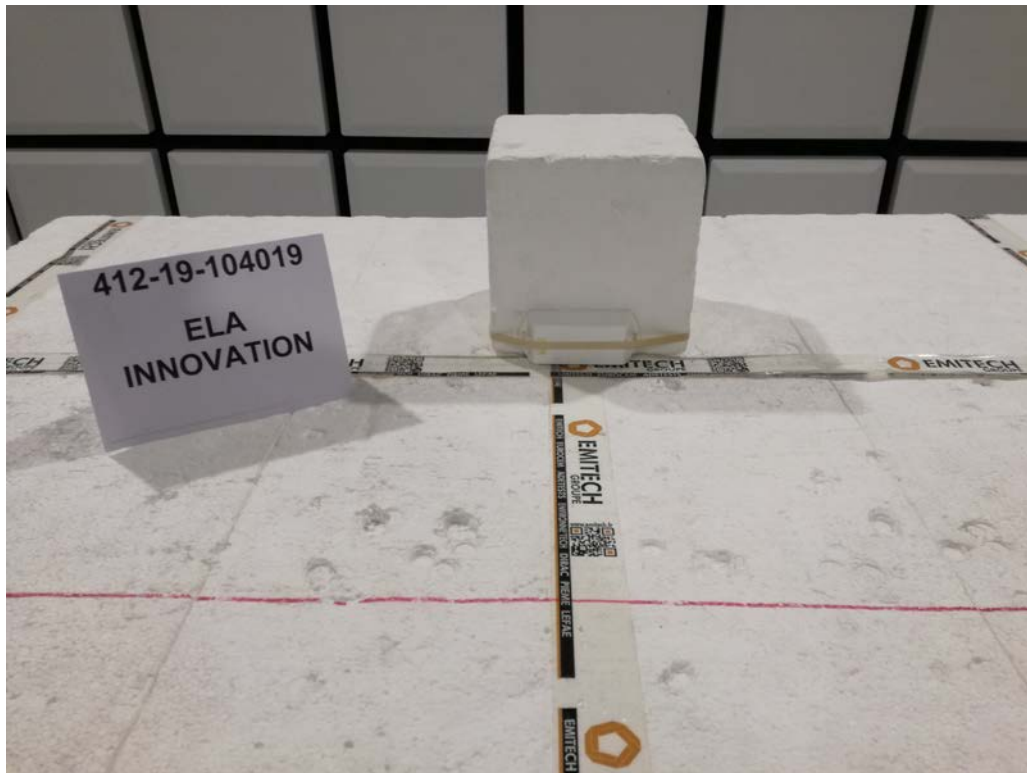
TEST SETUP PHOTO(S) – EUT POSITION FOR FREQ < 1GHZ

TEST SETUP PHOTO(S) – EUT POSITION FOR FREQ > 1GHZ



TEST SETUP PHOTO(S) – FOR 30MHZ <FREQ< 200MHZ



TEST SETUP PHOTO(S) - FOR 200MHZ <FREQ< 1GHZ



TEST SETUP PHOTO(S) - FOR 1GHZ <FREQ

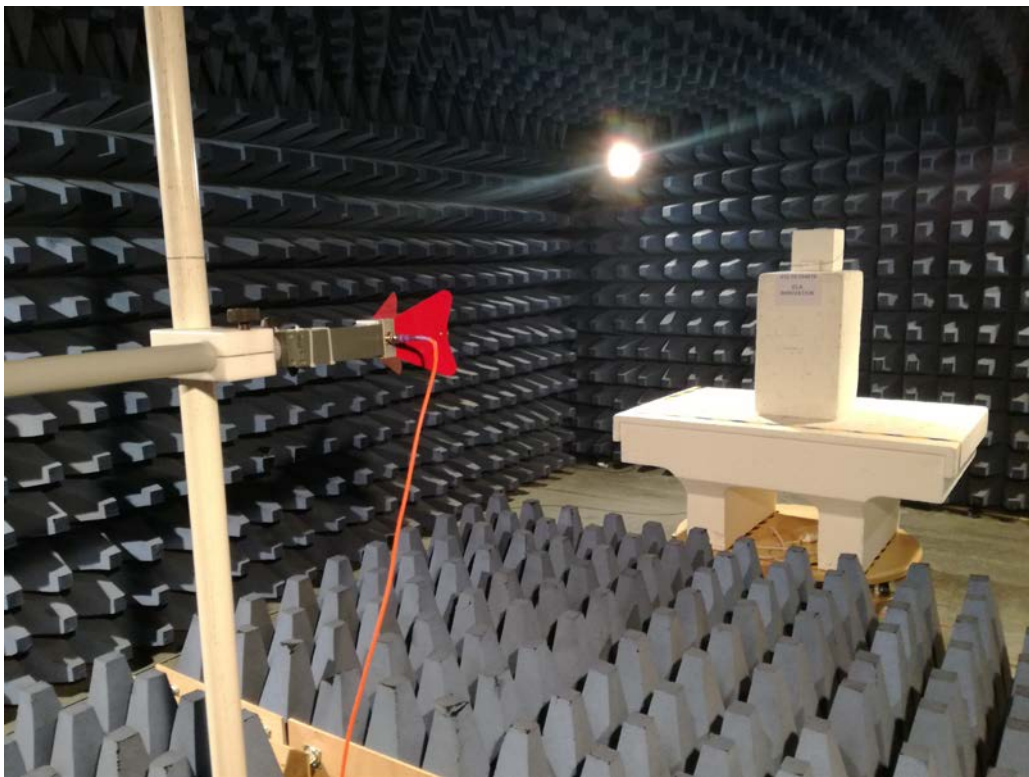

TRANSMITTER RADIATED SPURIOUS EMISSIONS - TABULATED RESULTS					
TX MODE - LOW CHANNEL					
Frequency (MHz)	Polarization	Level Peak (dB μ V/m)	Level Avg (dB μ V/m)	Limit Avg (dB μ V/m)	Margin dB
2233.523	Vertical	42.97	N/P	54	11.03
2249.325	Vertical	46.35	N/P	54	7.65
2272.527	Vertical	48.43	N/P	54	5.57
2280.728	Vertical	46.35	N/P	54	7.65
2296.930	Vertical	45.87	N/P	54	8.13
2313.131	Vertical	46.26	N/P	54	7.74
2329.333	Vertical	47.61	N/P	54	6.39
2345.535	Vertical	45.48	N/P	54	8.52
2360.936	Vertical	45.43	N/P	54	8.57
2368.937	Vertical	44.84	N/P	54	9.16
2376.938	Vertical	49.15	N/P	54	4.85
2209.121	Horizontal	45.51	34.99	54	19.01
2233.323	Horizontal	49.51	34.89	54	19.11
2248.925	Horizontal	50.36	35.59	54	18.41
2265.327	Horizontal	53.45	36.09	54	17.91
2272.727	Horizontal	55.58	37.73	54	16.27
2281.328	Horizontal	54.98	36.31	54	17.69
2288.929	Horizontal	53.91	36.25	54	17.75
2297.130	Horizontal	53.71	36.39	54	17.61
2313.131	Horizontal	54.02	36.08	54	17.92
2329.133	Horizontal	53.2	36.82	54	17.18
2344.734	Horizontal	53.12	37.14	54	16.86
2360.936	Horizontal	53.13	36.62	54	17.38
2376.738	Horizontal	53.38	37.07	54	16.93
2388.539	Horizontal	53.45	36.06	54	17.94
2489.149	Horizontal	44.46	34.47	54	19.53
2496.750	Horizontal	48.04	34.55	54	19.45
4801.680	Vertical	48.73	N/P	54	5.27

Spurious which has more than 20 dB of margin compared to the applicable limit is not necessarily reported

TRANSMITTER RADIATED SPURIOUS EMISSIONS - TABULATED RESULTS					
TX MODE - MID CHANNEL					
Frequency (MHz)	Polarization	Level Peak (dB μ V/m)	Level Avg (dB μ V/m)	Limit Avg (dB μ V/m)	Margin dB
2244.324	Vertical	43.24	N/P	54	10.76
2275.328	Vertical	47.6	N/P	54	6.4
2292.329	Vertical	47.48	N/P	54	6.52
2313.131	Vertical	49.89	N/P	54	4.11
2329.533	Vertical	47.69	N/P	54	6.31
2336.934	Vertical	48.44	N/P	54	5.56
2353.535	Vertical	49.81	N/P	54	4.19
2369.137	Vertical	47.29	N/P	54	6.71
2385.339	Vertical	45.64	N/P	54	8.36
2496.750	Vertical	45.5	N/P	54	8.5
2228.123	Horizontal	45.41	35.09	54	18.91
2235.924	Horizontal	46.97	34.98	54	19.02
2244.124	Horizontal	48.52	34.94	54	19.06
2251.925	Horizontal	50.94	34.94	54	19.06
2259.526	Horizontal	50.39	35.23	54	18.77
2268.727	Horizontal	52.29	35.49	54	18.51
2275.728	Horizontal	55.88	35.32	54	18.68
2288.929	Horizontal	52	36.85	54	17.15
2296.530	Horizontal	51.45	36.41	54	17.59
2313.131	Horizontal	57.92	40.83	54	13.17
2321.532	Horizontal	53.18	36.95	54	17.05
2329.333	Horizontal	56.57	37.16	54	16.84
2336.734	Horizontal	55.06	36.34	54	17.66
2345.535	Horizontal	53.12	36.82	54	17.18
2353.335	Horizontal	54.7	36.25	54	17.75
2369.537	Horizontal	53.08	36.34	54	17.66
2380.738	Horizontal	50.8	35.83	54	18.17
2496.950	Horizontal	50.24	35.26	54	18.74
4881.188	Vertical	47.9	N/P	54	6.1
7323.432	Vertical	42.11	N/P	54	11.89
7323.432	Horizontal	45.62	N/P	54	8.38

Spurious which has more than 20 dB of margin compared to the applicable limit is not necessarily reported.

TRANSMITTER RADIATED SPURIOUS EMISSIONS - TABULATED RESULTS					
TX MODE - HIGH CHANNEL					
Frequency (MHz)	Polarization	Level Peak (dB μ V/m)	Level Avg (dB μ V/m)	Limit Avg (dB μ V/m)	Margin dB
2259.326	Vertical	45.36	N/P	54	8.64
2275.928	Vertical	50.72	N/P	54	3.28
2291.729	Vertical	46.06	N/P	54	7.94
2320.332	Vertical	44.74	N/P	54	9.26
2329.533	Vertical	46.76	N/P	54	7.24
2345.535	Vertical	48.18	N/P	54	5.82
2353.335	Vertical	52.54	N/P	54	1.46
2377.138	Vertical	46.65	N/P	54	7.35
2265.327	Horizontal	44.6	35.45	54	18.55
2280.728	Horizontal	45.95	35.26	54	18.74
2312.931	Horizontal	50.7	35.71	54	18.29
2320.732	Horizontal	50.99	36.33	54	17.67
2329.133	Horizontal	55.44	37.23	54	16.77
2336.734	Horizontal	53.09	36.53	54	17.47
2345.135	Horizontal	55.2	37.32	54	16.68
2353.135	Horizontal	60	40.36	54	13.64
2369.337	Horizontal	55.7	37.13	54	16.87
2377.138	Horizontal	54.6	37.59	54	16.41
2385.139	Horizontal	51.92	36.54	54	17.46
2495.350	Horizontal	46.12	34.94	54	19.06
4960.696	Vertical	45.04	N/P	54	8.96
7441.944	Horizontal	47.55	N/P	54	6.45

Spurious which has more than 20 dB of margin compared to the applicable limit is not necessarily reported

TRANSMITTER RADIATED SPURIOUS EMISSIONS AT FREQUENCIES >30MHZ - GRAPH			
TX MODE - ALL CHANNELS FOR FREQ < 1GHZ			EMI4595
EUT mode:	Continuous modulated Tx		T (°C): 19.3
Test Date:	17/12/2019 16:08:18		H (%): 64.8
Test Operator:	OAT		P (hPa): 992

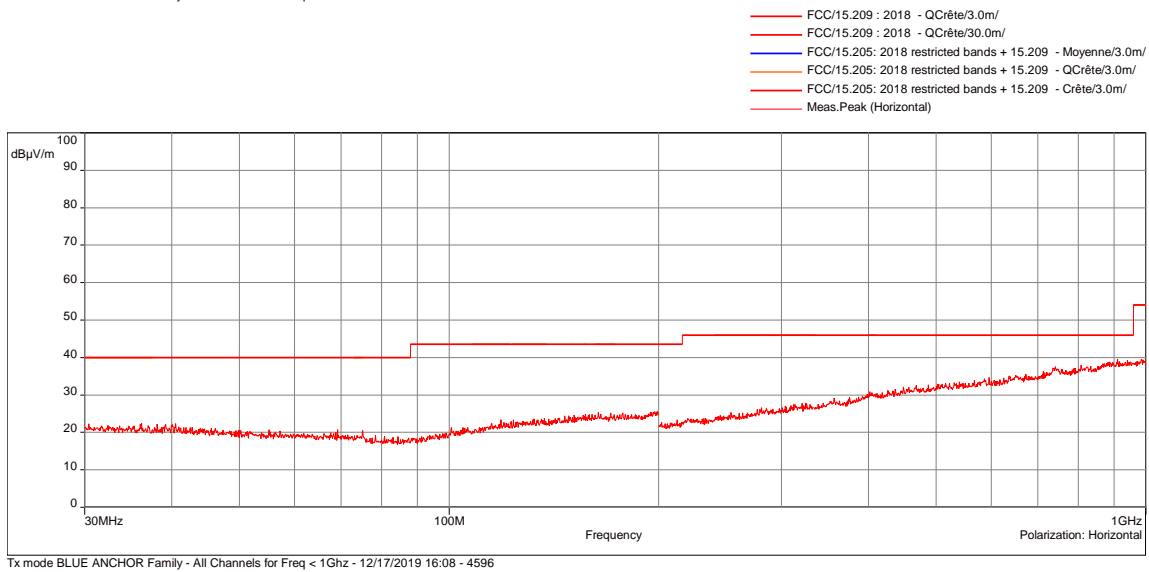
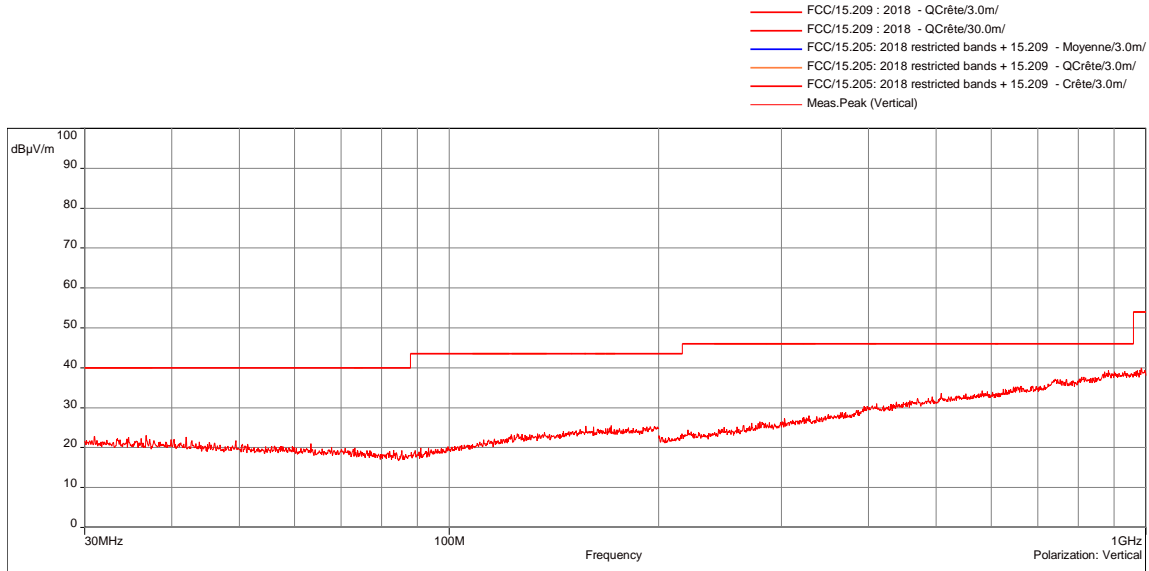

POSITION	FREQUENCIES	RBW	VBW	DETECTOR
Vertical	30MHz-200MHz	100kHz	300kHz	Peak
Horizontal	30MHz-200MHz	100kHz	300kHz	Peak
Vertical	200MHz-1GHz	100kHz	300kHz	Peak
Horizontal	200MHz-1GHz	100kHz	300kHz	Peak

EUT modification(s): N/A

TRANSMITTER RADIATED SPURIOUS EMISSIONS AT FREQUENCIES >30MHZ - TABULATED RESULTS			
TX MODE - ALL CHANNELS FOR FREQ < 1GHZ			EMI4595
Frequency (MHz)	Polarization	Level (dBm)	Limit (dBm)
N/A	N/A	N/A	N/A

No spurious emissions were detected.

TRANSMITTER RADIATED SPURIOUS EMISSIONS AT FREQUENCIES >30MHz - GRAPH

Tx MODE - LOW CHANNEL FOR FREQ > 1GHz

EMI4554

EUT mode:	Continuous modulated Tx	T (°C):	21.9
Test Date:	17/12/2019 10:37:08	H (%):	42.6
Test Operator:	OAT	P (hPa):	992

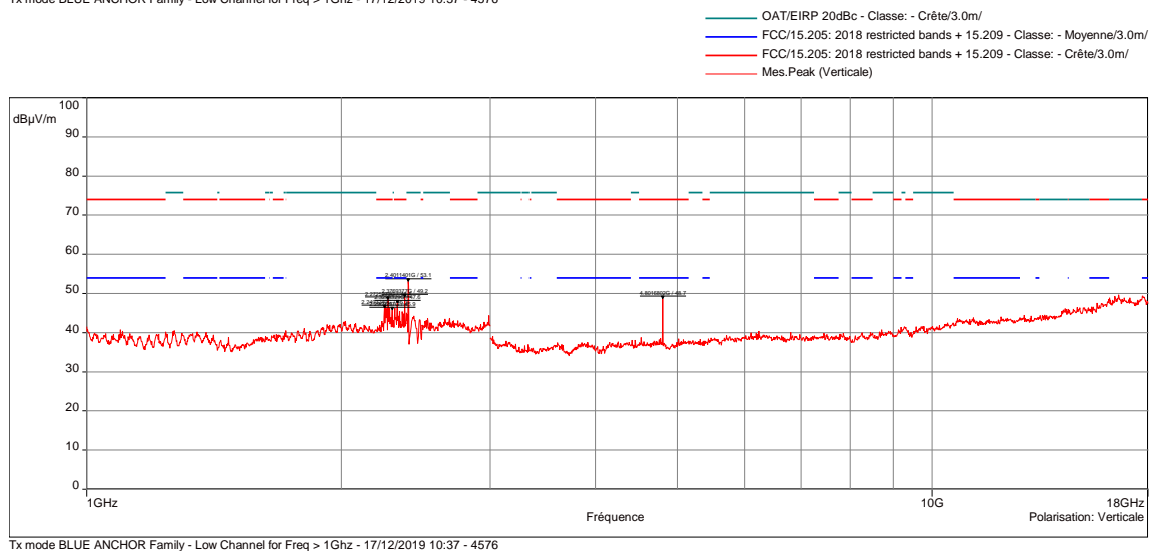
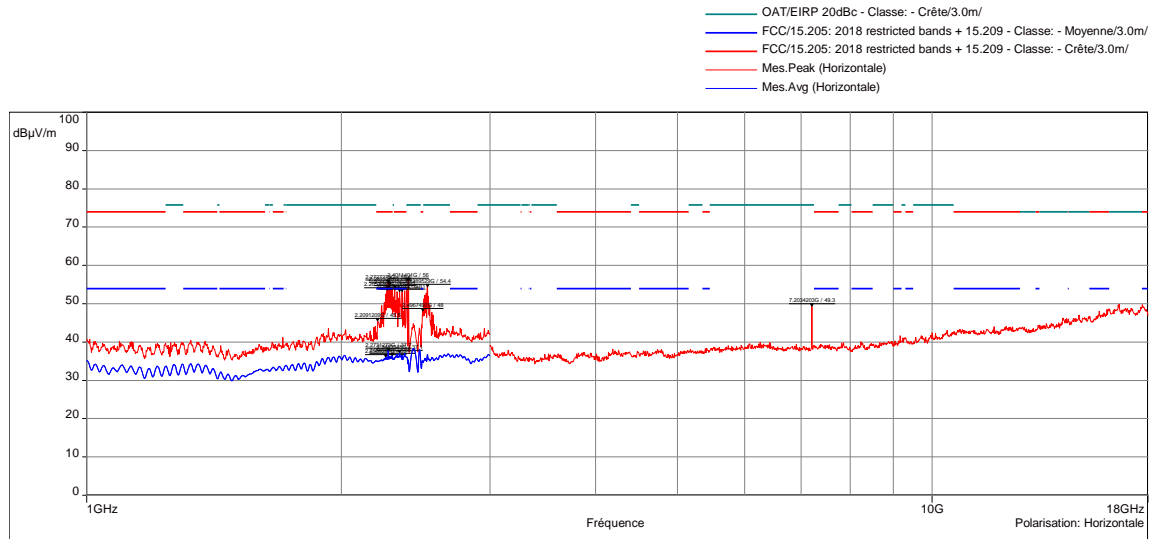

POSITION	FREQUENCIES	RBW	VBW	DETECTOR
Vertical	1GHz-3GHz	1MHz	3MHz	Peak
Horizontal	1GHz-3GHz	1MHz	3MHz	Mes.Peak; Mes.Avg;
Vertical	3GHz-18GHz	1MHz	3MHz	Peak
Horizontal	3GHz-18GHz	1MHz	3MHz	Peak
Configuration:				
Comments:	Above 18GHz no spurious emissions were detected.			
EUT modification(s): N/A				

TRANSMITTER RADIATED SPURIOUS EMISSIONS AT FREQUENCIES >30MHZ - TABULATED RESULTS					
TX MODE - LOW CHANNEL FOR FREQ > 1GHZ				EMI4554	
Frequency (MHz)	Polarization	Level Peak (dB μ V/m)	Level Avg (dB μ V/m)	Limit Avg (dB μ V/m)	Margin dB
2233.523	Vertical	42.97	N/P	54	11.03
2249.325	Vertical	46.35	N/P	54	7.65
2272.527	Vertical	48.43	N/P	54	5.57
2280.728	Vertical	46.35	N/P	54	7.65
2296.930	Vertical	45.87	N/P	54	8.13
2313.131	Vertical	46.26	N/P	54	7.74
2329.333	Vertical	47.61	N/P	54	6.39
2345.535	Vertical	45.48	N/P	54	8.52
2360.936	Vertical	45.43	N/P	54	8.57
2368.937	Vertical	44.84	N/P	54	9.16
2376.938	Vertical	49.15	N/P	54	4.85
2209.121	Horizontal	45.51	34.99	54	19.01
2233.323	Horizontal	49.51	34.89	54	19.11
2248.925	Horizontal	50.36	35.59	54	18.41
2265.327	Horizontal	53.45	36.09	54	17.91
2272.727	Horizontal	55.58	37.73	54	16.27
2281.328	Horizontal	54.98	36.31	54	17.69
2288.929	Horizontal	53.91	36.25	54	17.75
2297.130	Horizontal	53.71	36.39	54	17.61
2313.131	Horizontal	54.02	36.08	54	17.92
2329.133	Horizontal	53.2	36.82	54	17.18
2344.734	Horizontal	53.12	37.14	54	16.86
2360.936	Horizontal	53.13	36.62	54	17.38
2376.738	Horizontal	53.38	37.07	54	16.93
2388.539	Horizontal	53.45	36.06	54	17.94
2489.149	Horizontal	44.46	34.47	54	19.53
2496.750	Horizontal	48.04	34.55	54	19.45
4801.680	Vertical	48.73	N/P	54	5.27

Spurious which has more than 20 dB of margin compared to the applicable limit is not necessarily reported

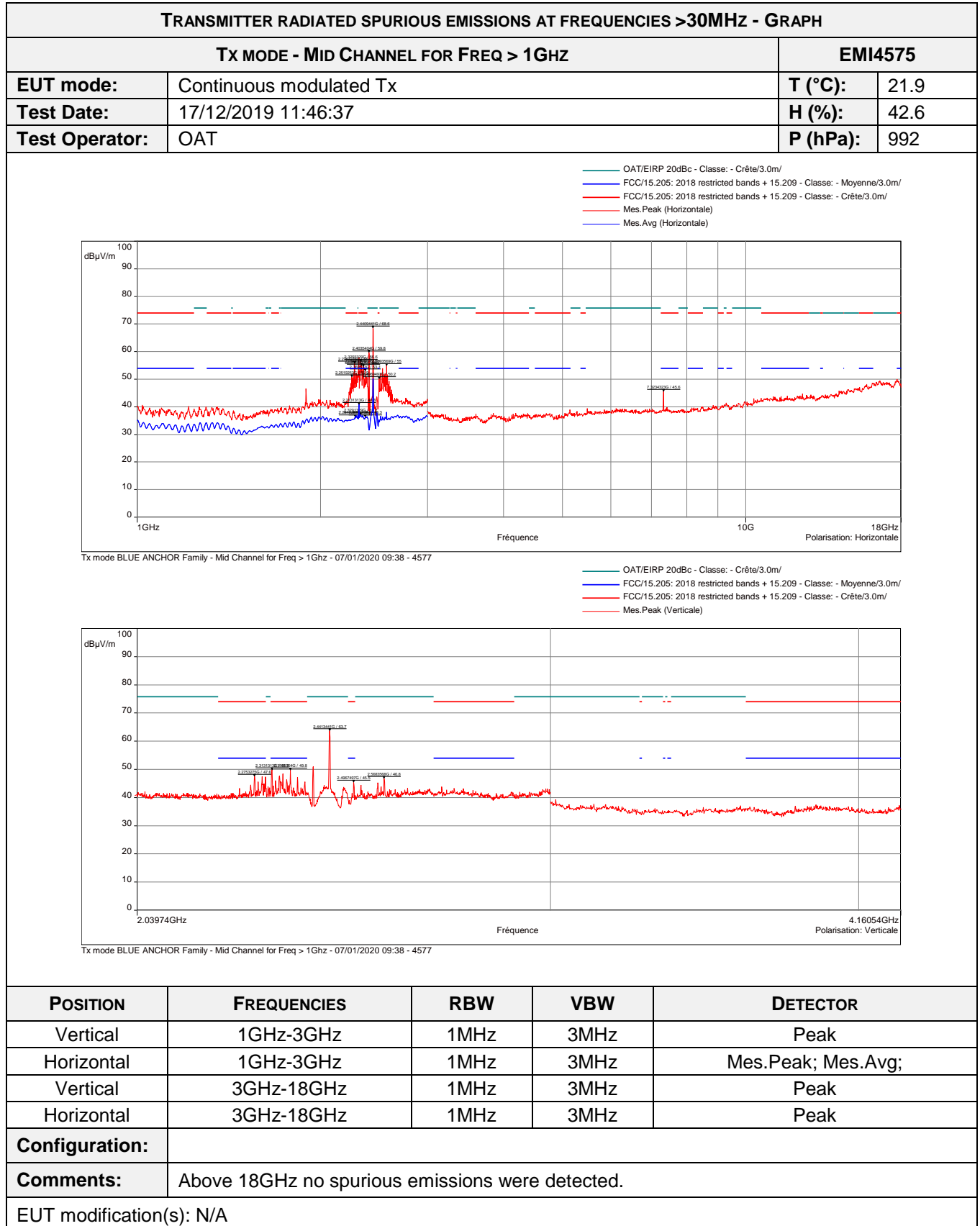

TRANSMITTER RADIATED SPURIOUS EMISSIONS AT FREQUENCIES >30MHZ - TABULATED RESULTS					
TX MODE - MID CHANNEL FOR FREQ > 1GHZ				EMI4575	
Frequency (MHz)	Polarization	Level Peak (dBµV/m)	Level Avg (dBµV/m)	Limit Avg (dBµV/m)	Margin dB
2244.324	Vertical	43.24	N/P	54	10.76
2275.328	Vertical	47.6	N/P	54	6.4
2292.329	Vertical	47.48	N/P	54	6.52
2313.131	Vertical	49.89	N/P	54	4.11
2329.533	Vertical	47.69	N/P	54	6.31
2336.934	Vertical	48.44	N/P	54	5.56
2353.535	Vertical	49.81	N/P	54	4.19
2369.137	Vertical	47.29	N/P	54	6.71
2385.339	Vertical	45.64	N/P	54	8.36
2496.750	Vertical	45.5	N/P	54	8.5
2228.123	Horizontal	45.41	35.09	54	18.91
2235.924	Horizontal	46.97	34.98	54	19.02
2244.124	Horizontal	48.52	34.94	54	19.06
2251.925	Horizontal	50.94	34.94	54	19.06
2259.526	Horizontal	50.39	35.23	54	18.77
2268.727	Horizontal	52.29	35.49	54	18.51
2275.728	Horizontal	55.88	35.32	54	18.68
2288.929	Horizontal	52	36.85	54	17.15
2296.530	Horizontal	51.45	36.41	54	17.59
2313.131	Horizontal	57.92	40.83	54	13.17
2321.532	Horizontal	53.18	36.95	54	17.05
2329.333	Horizontal	56.57	37.16	54	16.84
2336.734	Horizontal	55.06	36.34	54	17.66
2345.535	Horizontal	53.12	36.82	54	17.18
2353.335	Horizontal	54.7	36.25	54	17.75
2369.537	Horizontal	53.08	36.34	54	17.66
2380.738	Horizontal	50.8	35.83	54	18.17
2496.950	Horizontal	50.24	35.26	54	18.74
4881.188	Vertical	47.9	N/P	54	6.1
7323.432	Vertical	42.11	N/P	54	11.89
7323.432	Horizontal	45.62	N/P	54	8.38

Spurious which has more than 20 dB of margin compared to the applicable limit is not necessarily reported

TRANSMITTER RADIATED SPURIOUS EMISSIONS AT FREQUENCIES >30MHz - GRAPH			
TX MODE - HIGH CHANNEL FOR FREQ > 1GHz			EMI4574
EUT mode:	Continuous modulated Tx	T (°C):	21.9
Test Date:	17/12/2019 10:46:10	H (%):	42.6
Test Operator:	OAT	P (hPa):	992

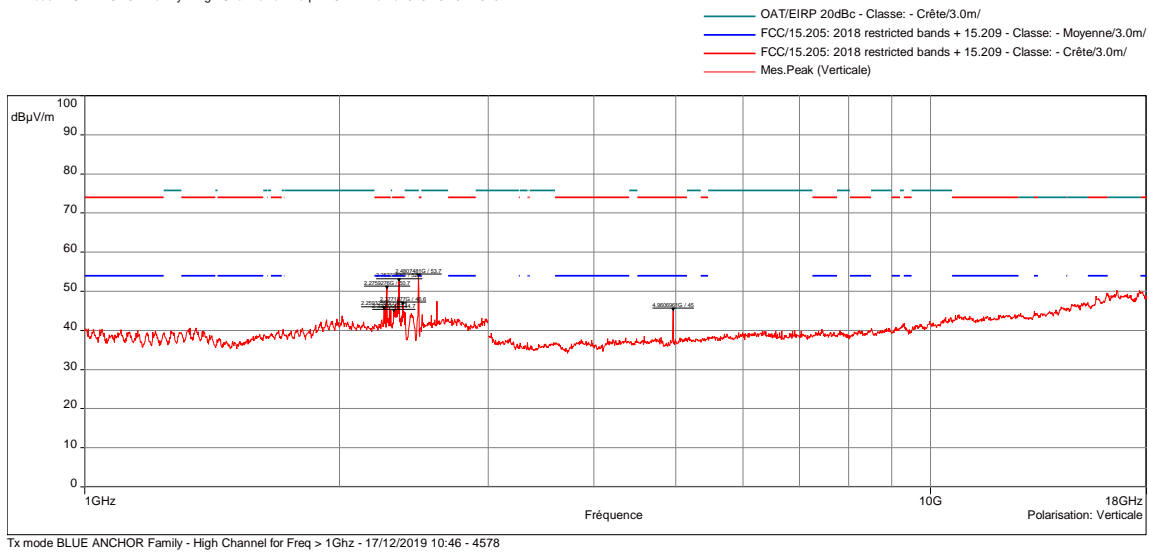
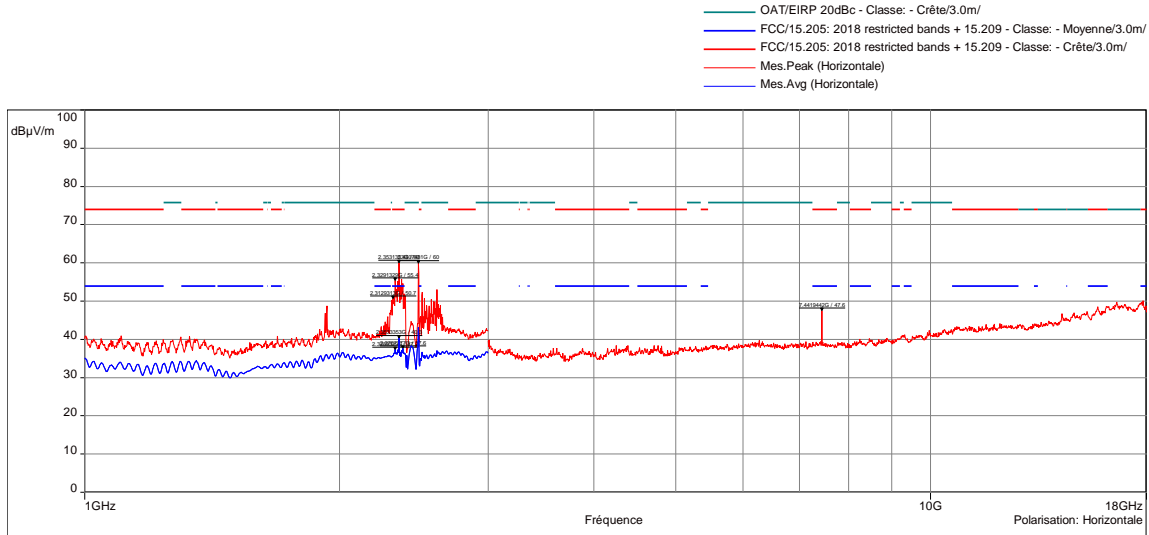

POSITION	FREQUENCIES	RBW	VBW	DETECTOR
Vertical	1GHz-3GHz	1MHz	3MHz	Peak
Horizontal	1GHz-3GHz	1MHz	3MHz	Mes.Peak; Mes.Avg;
Vertical	3GHz-18GHz	1MHz	3MHz	Peak
Horizontal	3GHz-18GHz	1MHz	3MHz	Peak
Configuration:				
Comments:	Above 18GHz no spurious emissions were detected.			
EUT modification(s): N/A				

TRANSMITTER RADIATED SPURIOUS EMISSIONS AT FREQUENCIES >30MHZ - TABULATED RESULTS					
TX MODE - HIGH CHANNEL FOR FREQ > 1GHZ				EMI4574	
Frequency (MHz)	Polarization	Level Peak (dB μ V/m)	Level Avg (dB μ V/m)	Limit Avg (dB μ V/m)	Margin dB
2259.326	Vertical	45.36	N/P	54	8.64
2275.928	Vertical	50.72	N/P	54	3.28
2291.729	Vertical	46.06	N/P	54	7.94
2320.332	Vertical	44.74	N/P	54	9.26
2329.533	Vertical	46.76	N/P	54	7.24
2345.535	Vertical	48.18	N/P	54	5.82
2353.335	Vertical	52.54	N/P	54	1.46
2377.138	Vertical	46.65	N/P	54	7.35
2265.327	Horizontal	44.6	35.45	54	18.55
2280.728	Horizontal	45.95	35.26	54	18.74
2312.931	Horizontal	50.7	35.71	54	18.29
2320.732	Horizontal	50.99	36.33	54	17.67
2329.133	Horizontal	55.44	37.23	54	16.77
2336.734	Horizontal	53.09	36.53	54	17.47
2345.135	Horizontal	55.2	37.32	54	16.68
2353.135	Horizontal	60	40.36	54	13.64
2369.337	Horizontal	55.7	37.13	54	16.87
2377.138	Horizontal	54.6	37.59	54	16.41
2385.139	Horizontal	51.92	36.54	54	17.46
2495.350	Horizontal	46.12	34.94	54	19.06
4960.696	Vertical	45.04	N/P	54	8.96
7441.944	Horizontal	47.55	N/P	54	6.45

Spurious which has more than 20 dB of margin compared to the applicable limit is not necessarily reported

9.4. Band-edge compliance

Reference standard:	FCC part 15 Radio part 15.247 and RSS-247
Test method:	FCC part 15.247 subclause d) and RSS-247
Test description: d) In any 100 kHz bandwidth outside the frequency band in which the intentional radiator is operating, the radio frequency power that is produced by the intentional radiator shall be at least 20 dB below that in the 100 kHz bandwidth within the band that contains the highest level of the desired power, based on either an RF conducted or a radiated measurement, provided the transmitter demonstrates compliance with the peak conducted power limits. If the transmitter complies with the conducted power limits based on the use of RMS averaging over a time interval, the attenuation required under this paragraph shall be 30 dB instead of 20 dB. EUT is set on an insulating support at 80cm above the ground reference plane (150cm for $f > 1\text{GHz}$). Measurements were performed in a semi-anechoic chamber or Open Area Test Site that complies to CISPR 16. The EUT was rotated 360° about its azimuth and adjusting the receive antenna height from 1 to 4 m. For portable equipments a research of maximum level is done on the 3 axes. Only the highest levels are recorded.	

TESTED CONFIGURATION	PARAMETER	SEVERITY	RESULT TAB.	VERDICT
Band edge / Low Channel	2.3835GHz- 2.4035GHz	15.247	EMI4571	PASS
Band edge / High Channel	2.4785GHz- 2.4985GHz	15.247	EMI4570	PASS

LABORATORY PARAMETERS:	REQUIRED PRIOR TO THE TEST	DURING THE TEST
Ambient Temperature	15 to 35 °C	See Graph(es)
Relative Humidity	20 to 75 %	See Graph(es)
Atmospheric pressure	N/A	See Graph(es)
TEST METHOD DEVIATION:		
Supplementary information: N/A		

TEST EQUIPMENT USED					
CATEGORY	BRAND	TYPE	IDENTIFIER	CAL. DATE	CAL. DUE
Antenna	ETS-Lindgren	3117	5456	24/07/2019	24/09/2022
Cable	MegaPhase	TM18-N1N1-118	12841	09/05/2018	09/07/2020
Cable	MegaPhase	TM18-N1N1-197	12840	09/05/2018	09/07/2020
Receiver	Rohde & Schwarz	FSW43	14830	28/12/2018	28/02/2020
Shielded enclosure	RAY PROOF	C.V2	1423		
Software	Nexio		0000		
Thermohygrometer	Testo	608-H1	7561	25/01/2019	25/03/2021
Thermohygrometer	Bioblock Scientific	Météostar	0963	25/01/2019	25/03/2021

BAT-EMC software version: V3.18.0.26

Blank cells = Permanent validity

TEST SETUP PHOTO(S)

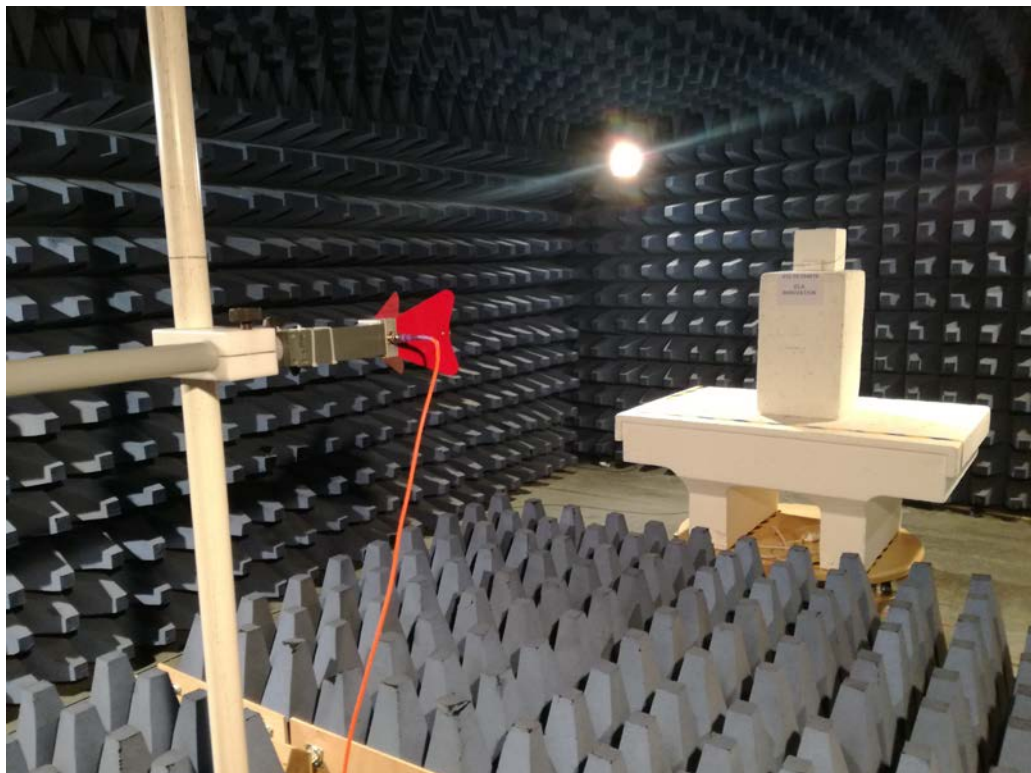

BAND-EDGE - TABULATED RESULTS					
Frequency (MHz)	Polarization	Level Peak (dB μ V/m)	Limit Avg (dB μ V/m)	Limit Peak (dB μ V/m)	Margin dB
2399.961	Vertical	66.10	N/A	78.33	12.23
2399.989	Horizontal	71.32	N/A	78.33	7.01
2483.506	Vertical	42.28	54	74	11.72
2489.219	Vertical	42.52	54	74	11.48
2483.580	Horizontal	47.42	54	74	6.58
2484.126	Horizontal	45.68	54	74	8.32
2484.468	Horizontal	43.71	54	74	10.29
2484.752	Horizontal	44.19	54	74	9.81
2488.757	Horizontal	47.43	54	74	6.57
2489.019	Horizontal	46.99	54	74	7.01
2489.259	Horizontal	48.76	54	74	5.24

Spurious which has more than 20 dB of margin compared to the applicable limit is not necessarily reported.

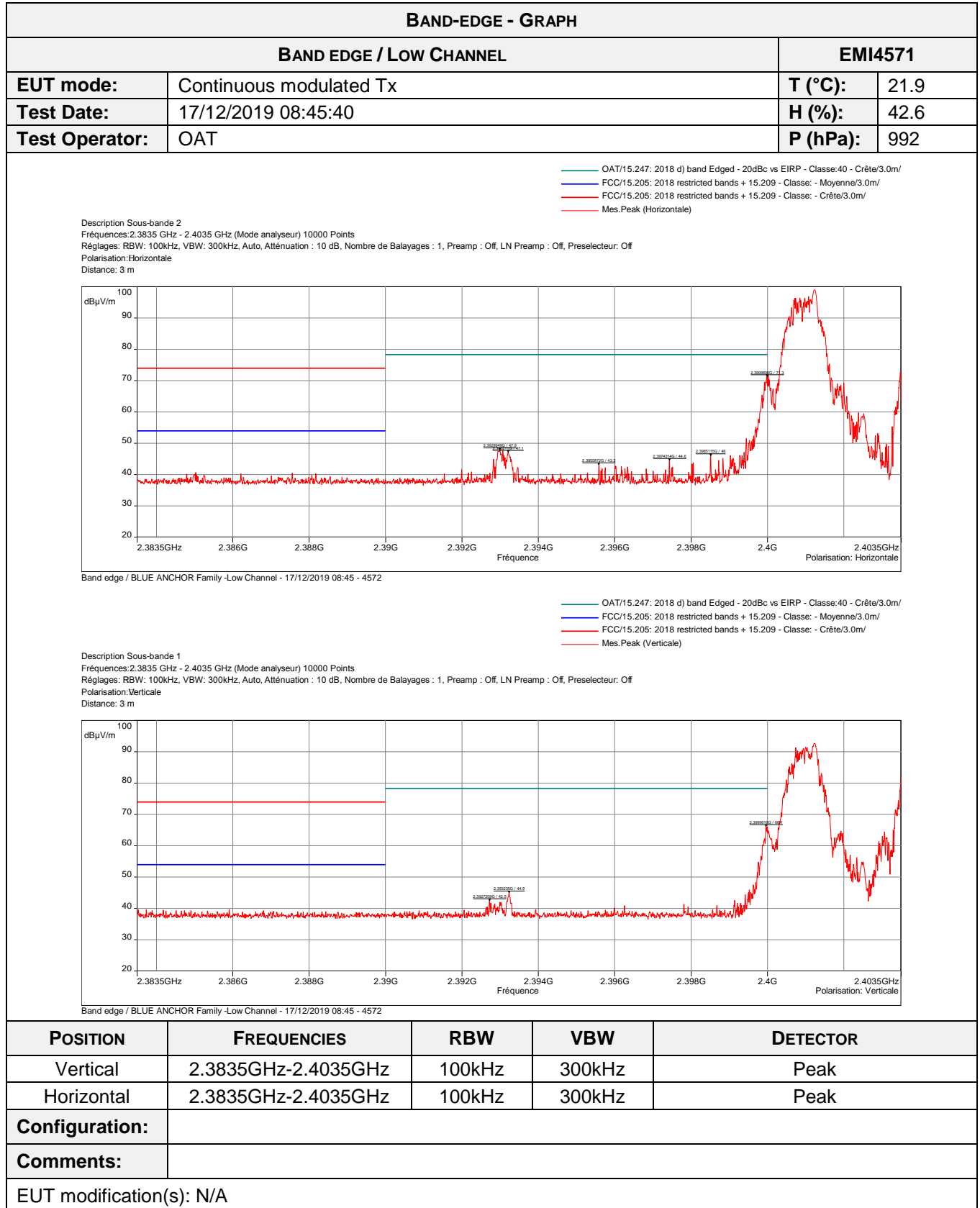

BAND-EDGE - TABULATED RESULTS					
BAND EDGE / LOW CHANNEL				EMI4571	
Frequency (MHz)	Polarization	Level Peak (dB μ V/m)	Limit Avg (dB μ V/m)	Limit Peak (dB μ V/m)	Margin dB
2399.961	Vertical	66.10	N/A	78.33	12.23
2399.989	Horizontal	71.32	N/A	78.33	7.01

Spurious which has more than 20 dB of margin compared to the applicable limit is not necessarily reported

BAND-EDGE - GRAPH			
BAND EDGE / HIGH CHANNEL			EMI4570
EUT mode:	Continuous modulated Tx		T (°C): 21.9
Test Date:	17/12/2019 08:51:47		H (%): 42.6
Test Operator:	OAT		P (hPa): 992

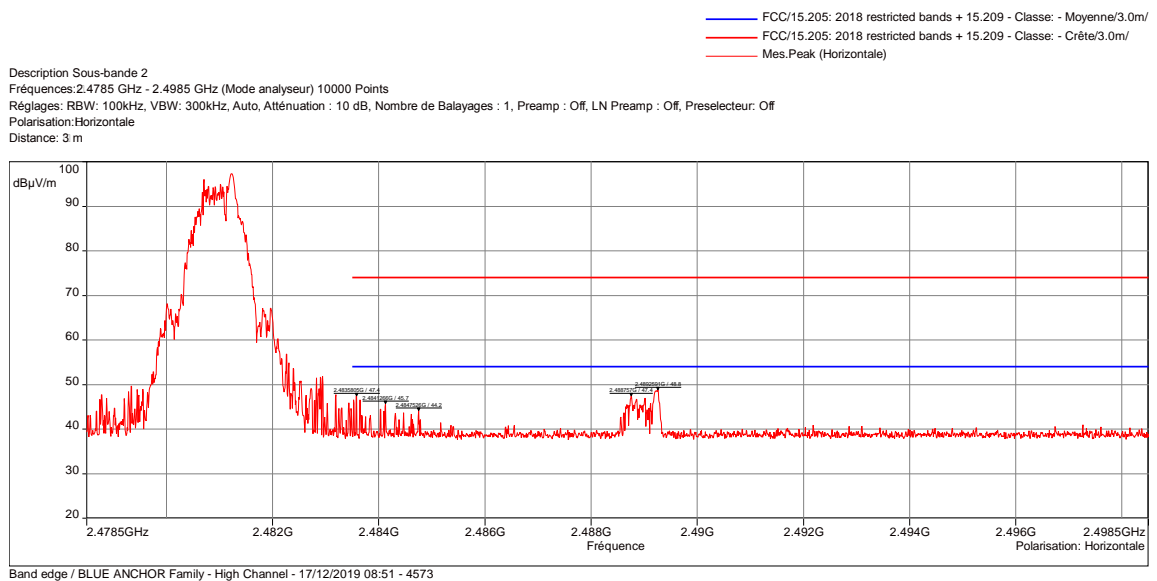
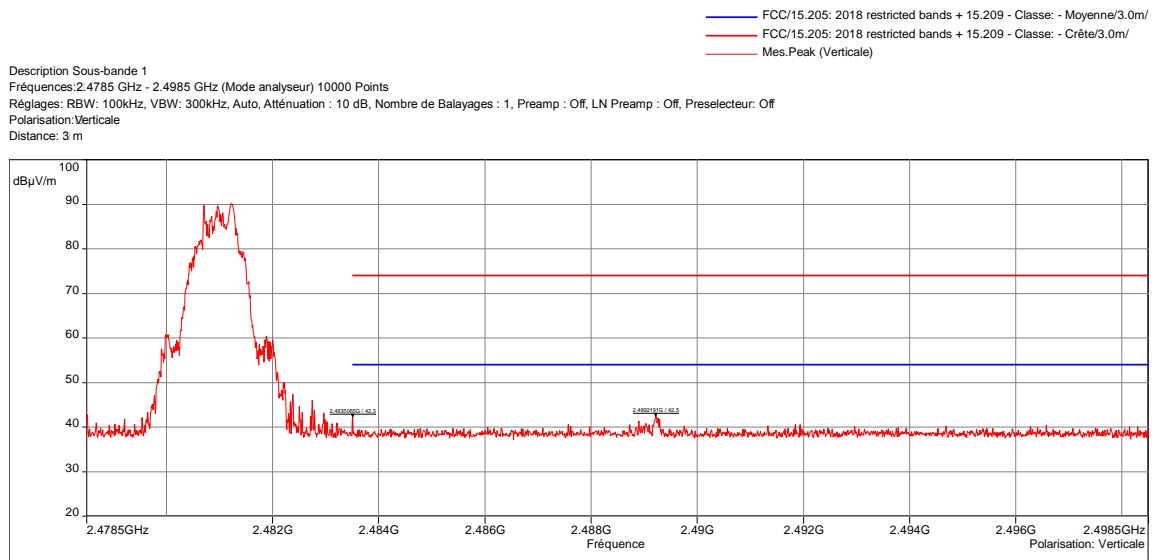

POSITION	FREQUENCIES	RBW	VBW	DETECTOR
Vertical	2.4785GHz-2.4985GHz	100kHz	300kHz	Peak
Horizontal	2.4785GHz-2.4985GHz	100kHz	300kHz	Peak
Configuration:				
Comments:				
EUT modification(s): N/A				

BAND-EDGE - TABULATED RESULTS					
BAND EDGE / HIGH CHANNEL				EMI4570	
Frequency (MHz)	Polarization	Level Peak (dB μ V/m)	Limit Avg (dB μ V/m)	Limit Peak (dB μ V/m)	Margin dB
2483.506	Vertical	42.28	54	74	11.72
2489.219	Vertical	42.52	54	74	11.48
2483.580	Horizontal	47.42	54	74	6.58
2484.126	Horizontal	45.68	54	74	8.32
2484.468	Horizontal	43.71	54	74	10.29
2484.752	Horizontal	44.19	54	74	9.81
2488.757	Horizontal	47.43	54	74	6.57
2489.019	Horizontal	46.99	54	74	7.01
2489.259	Horizontal	48.76	54	74	5.24

Spurious which has more than 20 dB of margin compared to the applicable limit is not necessarily reported

9.5. Maximum peak conducted power of the intentional radiator

a) NORMAL TESTS CONDITIONS

Reference standard:	FCC part 15 Radio part 15.247 and RSS-247
Test method:	ANSI C63.10: 2013
<p>Test description: EUT is set on an insulating support at 150cm above the ground reference plane. Measurement are done on a normalized test site by the substitution method.</p> <p>The test antenna is oriented in the two polarizations (vertical and horizontal), and the product is rotated at 360° in the horizontal plane (See photo(s) for initial position of the EUT(0°)). If applicable the test antenna was raised and lowered through the specified range of height until a maximum signal level is detected.</p> <p>For portable equipments a research of maximum level is done on the 3 axes. Only the highest levels are recorded.</p>	

TESTED CONFIGURATION	PARAMETER	SEVERITY	RESULT TAB.	VERDICT
EIRP - Low Channel	2.4GHz-2.402GHz	1W (30dBm)	EMI4544	PASS
EIRP - Mid Channel	2.44GHz-2.442GHz	1W (30dBm)	EMI4546	PASS
EIRP - High Channel	2.48GHz-2.482GHz	1W (30dBm)	EMI4545	PASS

LABORATORY PARAMETERS:	REQUIRED PRIOR TO THE TEST	DURING THE TEST
Ambient Temperature	15 to 35 °C	See Graph(es)
Relative Humidity	20 to 75 %	See Graph(es)
Atmospheric pressure	N/A	See Graph(es)
<p>Test method deviation: EUT has its dedicated internal PCB antenna, due to this, this measurement was done in radiated by the substitution method as described in Annex G of ANSI C63.10.</p>		
Supplementary information: N/A		

TEST EQUIPMENT USED					
CATEGORY	BRAND	TYPE	IDENTIFIER	CAL. DATE	CAL. DUE
Antenna	ETS-Lindgren	3117	5456	24/07/2019	24/09/2022
Attenuator	EMITECH	SUB.V2-H	14495	25/09/2019	25/11/2020
Attenuator	EMITECH	SUB.V2-V	14496	25/09/2019	25/11/2020
Cable	MegaPhase	N-3m	14852	29/10/2018	29/12/2020
Cable	MegaPhase	N-5m	14855	12/02/2018	12/04/2020
Cable	Huber + Suhner	SF102K	16041	28/02/2019	28/04/2021
Cable	MegaPhase	TM18-N1N1-118	12842	09/05/2018	09/07/2020
Receiver	Rohde & Schwarz	FSW43	14830	28/12/2018	28/02/2020
Shielded enclosure	RAY PROOF	C.V2	1423		
Software	Nexio		0000		
Thermohygrometer	Testo	608-H1	7562	25/01/2019	25/03/2021
Thermohygrometer	Bioblock Scientific	Météostar	0963	25/01/2019	25/03/2021

BAT-EMC software version: V3.18.0.26

Blank cells = Permanent validity

TEST SETUP PHOTO(S)

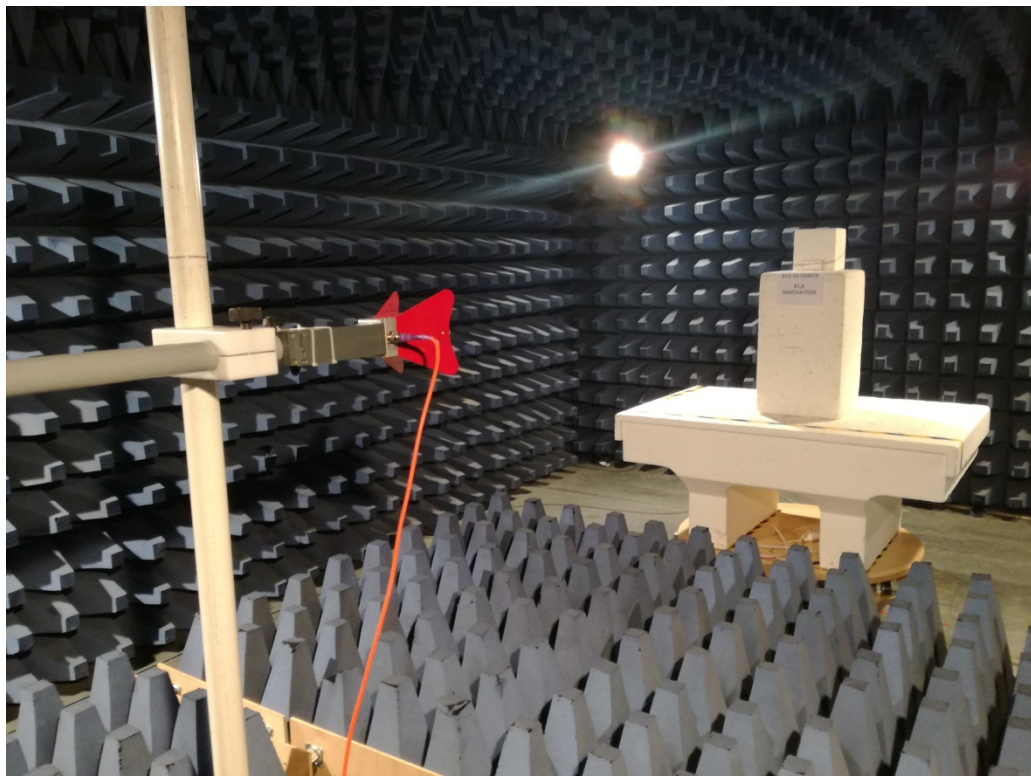

EFFECTIVE ISOTROPIC RADIATED POWER - GRAPH				
EIRP - LOW CHANNEL			EMI4544	
EUT mode:	Continous modulated Tx		T (°C):	22.2
Test Date:	16/12/2019 10:15:28		H (%):	44.5
Test Operator:	OAT		P (hPa):	998

Description Sous-bande 1
 Fréquences: 2.4 GHz - 2.402 GHz (Mode analyseur) 10000 Points
 Réglages: RBW: 1MHz, VBW: 3MHz, Auto, Atténuation : Auto, Nombre de Balayages : 1, Preamp : Off, LN Preamp : Off, Preselecteur: Off
 Polarisation: Verticale
 Distance: 3 m

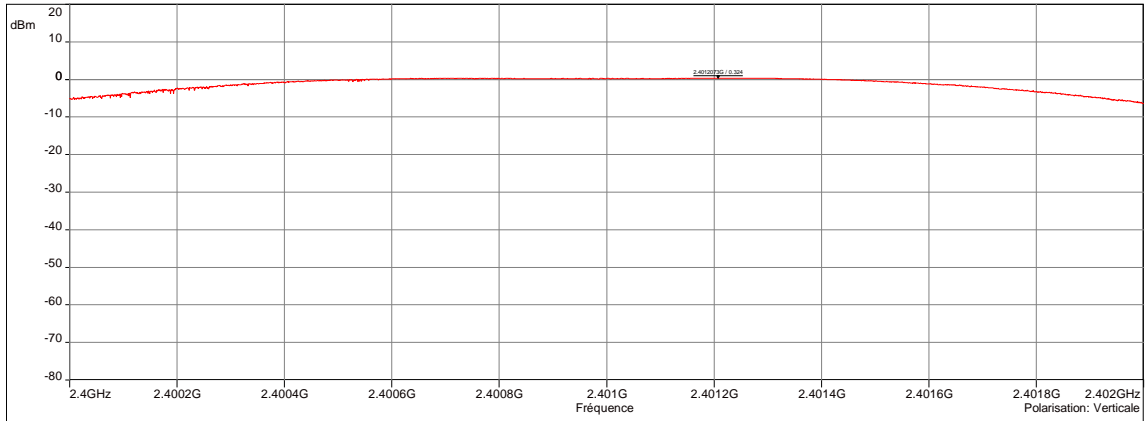

EIRP - BLUE ANCHOR Family - Low Channel - 16/12/2019 10:15 - 4547

Description Sous-bande 2
 Fréquences: 2.4 GHz - 2.402 GHz (Mode analyseur) 10000 Points
 Réglages: RBW: 1MHz, VBW: 3MHz, Auto, Atténuation : Auto, Nombre de Balayages : 1, Preamp : Off, LN Preamp : Off, Preselecteur: Off
 Polarisation: Horizontale
 Distance: 3 m

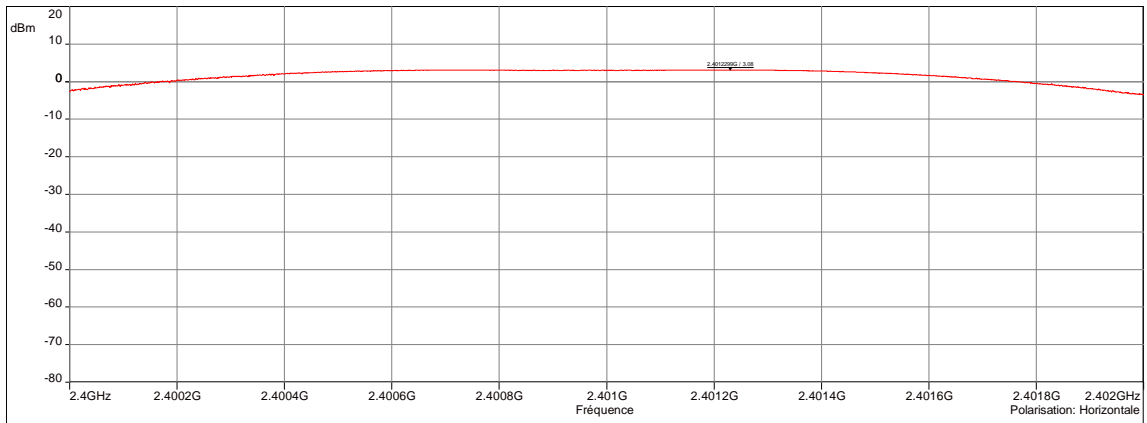

EIRP - BLUE ANCHOR Family - Low Channel - 16/12/2019 10:15 - 4547

POSITION	FREQUENCIES	RBW	VBW	DETECTOR
Vertical	2.4GHz-2.402GHz	1MHz	3MHz	Peak
Horizontal	2.4GHz-2.402GHz	1MHz	3MHz	Peak

EUT modification(s): N/A

EFFECTIVE ISOTROPIC RADIATED POWER - TABULATED RESULTS			
EIRP - LOW CHANNEL			EMI4544
Frequency (MHz)	Polarization	Level (dBm)	Limit (dBm)
2401	Vertical	0.324	30
2401	Horizontal	3.08	30

EFFECTIVE ISOTROPIC RADIATED POWER - GRAPH			
EIRP - MID CHANNEL			EMI4546
EUT mode:	Continous modulated Tx		T (°C): 22.2
Test Date:	16/12/2019 10:25:29		H (%): 44.5
Test Operator:	OAT		P (hPa): 998

Description Sous-bande 1
 Fréquences: 2.44 GHz - 2.442 GHz (Mode analyseur) 10000 Points
 Réglages: RBW: 1MHz, VBW: 3MHz, Auto, Atténuation : Auto, Nombre de Balayages : 1, Preamp : Off, LN Preamp : Off, Preselecteur: Off
 Polarisation: Verticale
 Distance: 3 m

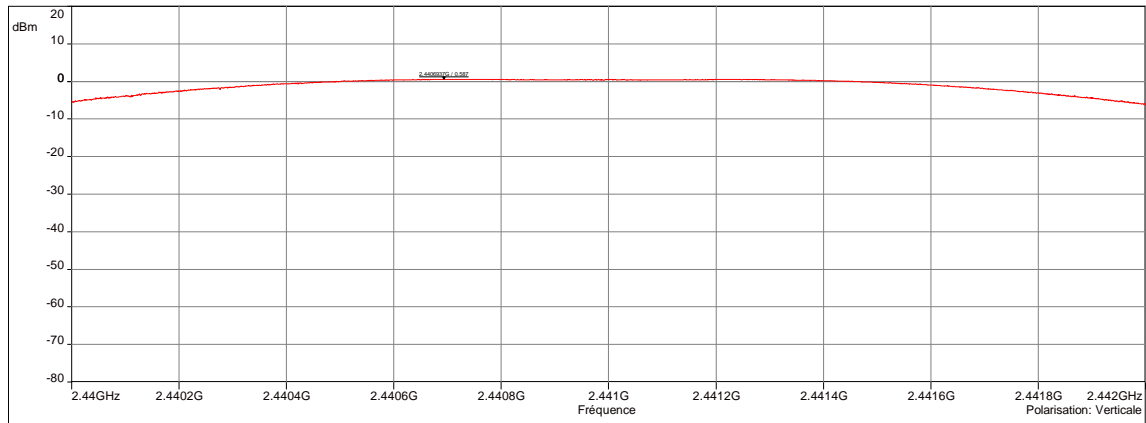

EIRP - BLUE ANCHOR Family - Mid Channel - 16/12/2019 10:25 - 4548

Description Sous-bande 2
 Fréquences: 2.44 GHz - 2.442 GHz (Mode analyseur) 10000 Points
 Réglages: RBW: 1MHz, VBW: 3MHz, Auto, Atténuation : Auto, Nombre de Balayages : 1, Preamp : Off, LN Preamp : Off, Preselecteur: Off
 Polarisation: Horizontale
 Distance: 3 m

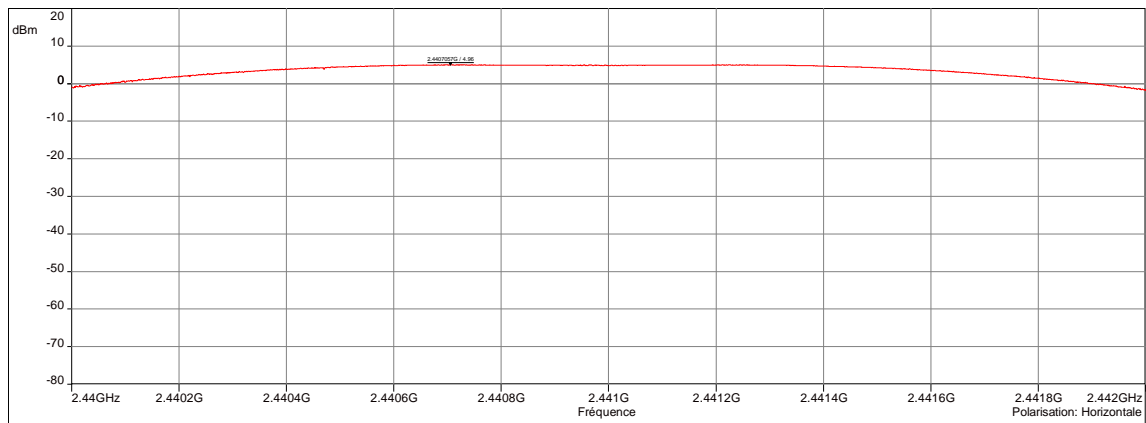

EIRP - BLUE ANCHOR Family - Mid Channel - 16/12/2019 10:25 - 4548

POSITION	FREQUENCIES	RBW	VBW	DETECTOR
Vertical	2.44GHz-2.442GHz	1MHz	3MHz	Peak
Horizontal	2.44GHz-2.442GHz	1MHz	3MHz	Peak

EUT modification(s): N/A

EFFECTIVE ISOTROPIC RADIATED POWER - TABULATED RESULTS			
EIRP - MID CHANNEL			EMI4546
Frequency (MHz)	Polarization	Level (dBm)	Limit (dBm)
2441	Vertical	0.587	30
2441	Horizontal	4.96	30

EFFECTIVE ISOTROPIC RADIATED POWER - GRAPH			
EIRP - HIGH CHANNEL			EMI4545
EUT mode:	Continous modulated Tx		T (°C): 22.2
Test Date:	16/12/2019 10:35:20		H (%): 44.5
Test Operator:	OAT		P (hPa): 998

Description Sous-bande 1
 Fréquences: 2.48 GHz - 2.482 GHz (Mode analyseur) 10000 Points
 Réglages: RBW: 1MHz, VBW: 3MHz, Auto, Atténuation : Auto, Nombre de Balayages : 1, Preamp : Off, LN Preamp : Off, Preselecteur: Off
 Polarisation: Verticale
 Distance: 3 m

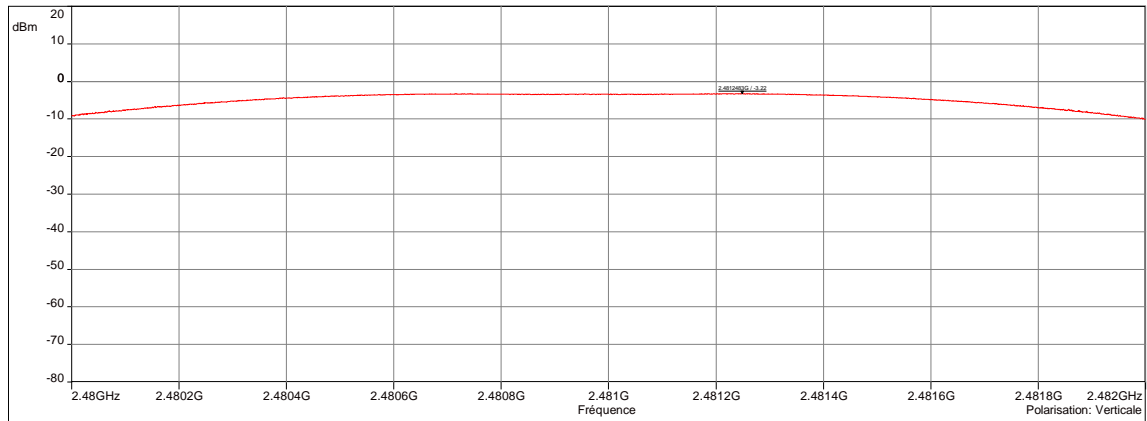

Description Sous-bande 2
 Fréquences: 2.48 GHz - 2.482 GHz (Mode analyseur) 10000 Points
 Réglages: RBW: 1MHz, VBW: 3MHz, Auto, Atténuation : Auto, Nombre de Balayages : 1, Preamp : Off, LN Preamp : Off, Preselecteur: Off
 Polarisation: Horizontale
 Distance: 3 m

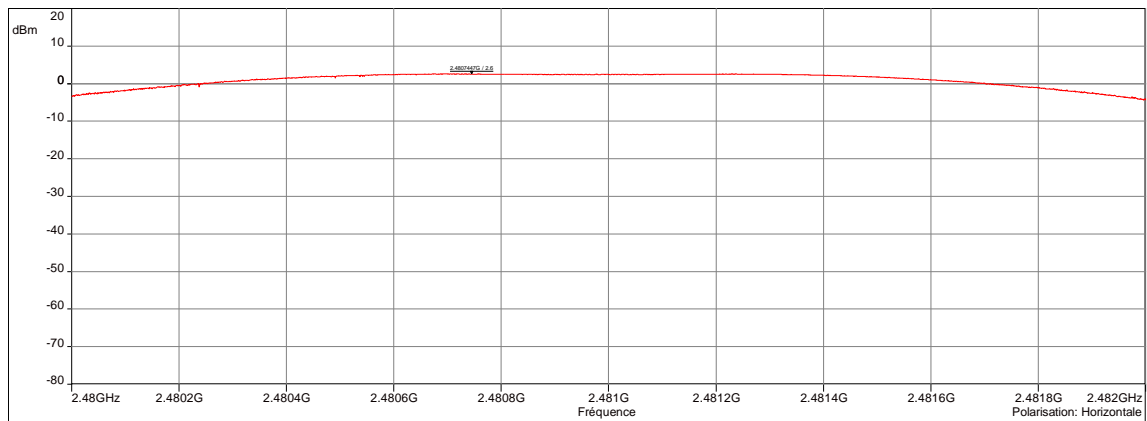

POSITION	FREQUENCIES	RBW	VBW	DETECTOR
Vertical	2.48GHz-2.482GHz	1MHz	3MHz	Peak
Horizontal	2.48GHz-2.482GHz	1MHz	3MHz	Peak

EUT modification(s): N/A

EFFECTIVE ISOTROPIC RADIATED POWER - TABULATED RESULTS			
EIRP - HIGH CHANNEL			EMI4545
Frequency (MHz)	Polarization	Level (dBm)	Limit (dBm)
2481	Vertical	-3.22	30
2481	Horizontal	2.6	30

b) EXTREMES TESTS CONDITIONS

Reference standard:	FCC part 15 Radio part 15.247 and RSS-247
Test method:	ANSI C63.10: 2013
General test setup: EUT is set inside the climatic enclosure. EIRP measurements are repeated in extreme test conditions with the power levels correlated with the maximum effective radiated power measured in normal conditions.	

TEST CASE	EUT MODE	SEVERITY	RESULT TAB.	VERDICT
Low channel / 25°C / 3.6Vdc	Tx-CW	1W (30dBm)	EMI4499	PASS
Low channel / 25°C / 3.0Vdc	Tx-CW	1W (30dBm)	EMI4500	PASS
Mid channel / 25°C / 3.6Vdc	Tx-CW	1W (30dBm)	EMI4501	PASS
Mid channel / 25°C / 3.0Vdc	Tx-CW	1W (30dBm)	EMI4601	PASS
High channel / 25°C / 3.0dc	Tx-CW	1W (30dBm)	EMI4602	PASS
High channel / 25°C / 3.0Vdc	Tx-CW	1W (30dBm)	EMI4603	PASS
Low channel / -40°C / 3.6Vdc	Tx-CW	1W (30dBm)	EMI4604	PASS
Low channel / -40°C / 3.0Vdc	Tx-CW	1W (30dBm)	EMI4605	PASS
Mid channel / -40°C / 3.6Vdc	Tx-CW	1W (30dBm)	EMI4606	PASS
Mid channel / -40°C / 3.0Vdc	Tx-CW	1W (30dBm)	EMI4710	PASS
High channel / -40°C / 3.6Vdc	Tx-CW	1W (30dBm)	EMI4711	PASS
High channel / -40°C / 3.0Vdc	Tx-CW	1W (30dBm)	EMI4712	PASS
Low channel / 85°C / 3.6Vdc	Tx-CW	1W (30dBm)	EMI4713	PASS
Low channel / 85°C / 3.0Vdc	Tx-CW	1W (30dBm)	EMI4714	PASS
Mid channel / 85°C / 3.6Vdc	Tx-CW	1W (30dBm)	EMI4715	PASS
Mid channel / 85°C / 3.0Vdc	Tx-CW	1W (30dBm)	EMI4716	PASS
High channel / 85°C / 3.6Vdc	Tx-CW	1W (30dBm)	EMI4717	PASS
High channel / 85°C / 3.0Vdc	Tx-CW	1W (30dBm)	EMI4718	PASS

LABORATORY PARAMETERS:	REQUIRED PRIOR TO THE TEST	DURING THE TEST
Ambient Temperature	15 to 35 °C	24.1 °C
Relative Humidity	20 to 75 %	51.5 %
Atmospheric pressure	N/A	1002 hPa
Test method deviation: N/A		
Supplementary information: EUT power supply is replaced by a stabilized power supply.		

TEST EQUIPMENT USED					
CATEGORY	BRAND	TYPE	IDENTIFIER	CAL. DATE	CAL. DUE
Attenuator	Radiall	R412710124	16491	25/06/2019	25/08/2021
Cable	N	3m	16426	04/05/2019	04/07/2021
Cable	Huber + Suhner	SF102K	16041	28/02/2019	28/04/2021
Climatic enclosure	CLIMATS	EXCAL 7714-HA	14261	19/09/2019	19/11/2020
Multimeter	FLUKE	8808A	12446	20/07/2019	20/09/2020
Power supply	TTi	TSX-1820P	4365		
Spectrum analyzer	Rohde & Schwarz	FSW43	14830	28/12/2018	28/02/2020
Thermohygrometer	Testo	608-H2	12268	27/11/2017	27/01/2020
Thermometer contactless	GHM Greisinger	GMH 3710	12968	11/02/2019	11/04/2020

Blank cells = Permanent validity

TEST SETUP PHOTO(S)

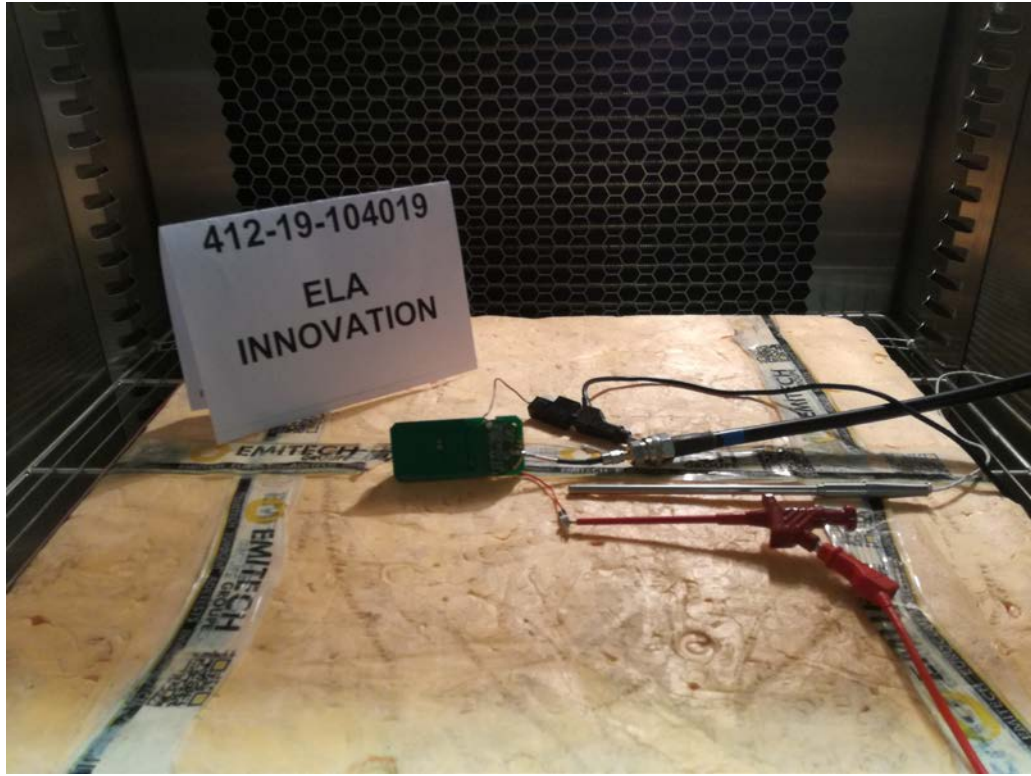

EFFECTIVE ISOTROPIC RADIATED POWER - TABULATED RESULTS				
TEST CASE	FREQUENCY	LEVEL (dBm)	LIMIT	RESULT TAB.
Low channel / 25°C / 3.6Vdc	2401 MHz	3.08	1W (30dBm)	EMI4499
Low channel / 25°C / 3.0Vdc	2401 MHz	3.07	1W (30dBm)	EMI4500
Mid channel / 25°C / 3.6Vdc	2441 MHz	4.96	1W (30dBm)	EMI4501
Mid channel / 25°C / 3.0Vdc	2441 MHz	4.97	1W (30dBm)	EMI4601
High channel / 25°C / 3.0dc	2481 MHz	2.60	1W (30dBm)	EMI4602
High channel / 25°C / 3.0Vdc	2481 MHz	2.60	1W (30dBm)	EMI4603
Low channel / -40°C / 3.6Vdc	2401 MHz	5.01	1W (30dBm)	EMI4604
Low channel / -40°C / 3.0Vdc	2401 MHz	5.05	1W (30dBm)	EMI4605
Mid channel / -40°C / 3.6Vdc	2441 MHz	6.62	1W (30dBm)	EMI4606
Mid channel / -40°C / 3.0Vdc	2441 MHz	6.66	1W (30dBm)	EMI4710
High channel / -40°C / 3.6Vdc	2481 MHz	4.18	1W (30dBm)	EMI4711
High channel / -40°C / 3.0Vdc	2481 MHz	4.23	1W (30dBm)	EMI4712
Low channel / 85°C / 3.6Vdc	2401 MHz	1.86	1W (30dBm)	EMI4713
Low channel / 85°C / 3.0Vdc	2401 MHz	1.86	1W (30dBm)	EMI4714
Mid channel / 85°C / 3.6Vdc	2441 MHz	3.76	1W (30dBm)	EMI4715
Mid channel / 85°C / 3.0Vdc	2441 MHz	3.75	1W (30dBm)	EMI4716
High channel / 85°C / 3.6Vdc	2481 MHz	1.07	1W (30dBm)	EMI4717
High channel / 85°C / 3.0Vdc	2481 MHz	1.07	1W (30dBm)	EMI4718

EUT MODIFICATIONS	OPERATOR	TEST DATE	RESULT TAB.
N/A	OAT	18/12/2019	-

9.6. 20dB & 6dB Bandwidth For Digitally Modulation Systems

Reference standard:	FCC part 15 Radio part 15.247 and RSS-247
Test method:	ANSI C63.10: 2013
Test description: Systems using digital modulation techniques may operate in the 902-928 MHz, 2400-2483.5 MHz, and 5725-5850 MHz bands. The minimum 6 dB bandwidth shall be at least 500 kHz. EUT is connected to the measuring receiver via 50Ω attenuator(s). Tests are done in max-hold mode in order to capture all channels.	

TESTED CHANNEL	RESULT	SEVERITY	RESULT TAB.	VERDICT
6dB Bandwidth - Low channel	689.3kHz	>500kHz	EMI4567	PASS
6dB Bandwidth - Mid channel	677.3kHz	>500kHz	EMI4568	PASS
6dB Bandwidth - High channel	674.3kHz	>500kHz	EMI4569	PASS
20dB Bandwidth - Low channel	1.223MHz	>500kHz	EMI4467	PASS
20dB Bandwidth - Mid channel	1.226MHz	>500kHz	EMI4468	PASS
20dB Bandwidth - High channel	1.220MHz	>500kHz	EMI4469	PASS

LABORATORY PARAMETERS:	REQUIRED PRIOR TO THE TEST	DURING THE TEST
Ambient Temperature	15 to 35 °C	24.1 °C
Relative Humidity	20 to 75 %	51.5 %
Atmospheric pressure	N/A	1002 hpa
TEST METHOD DEVIATION: N/A		
Supplementary information: EUT power supply is replaced by a stabilized power supply.		

TEST EQUIPMENT USED					
CATEGORY	BRAND	TYPE	IDENTIFIER	CAL. DATE	CAL. DUE
Attenuator	Radiall	R412710124	16491	25/06/2019	25/08/2021
Cable	N	3m	16426	04/05/2019	04/07/2021
Cable	Huber + Suhner	SF102K	16041	28/02/2019	28/04/2021
Multimeter	FLUKE	8808A	12446	20/07/2019	20/09/2020
Power supply	TTi	TSX-1820P	4365		
Spectrum analyzer	Rohde & Schwarz	FSW43	14830	28/12/2018	28/02/2020
Thermohygrometer	Testo	608-H2	12268	27/11/2017	27/01/2020

Blank cells = Permanent validity

TEST SETUP PHOTO(S)

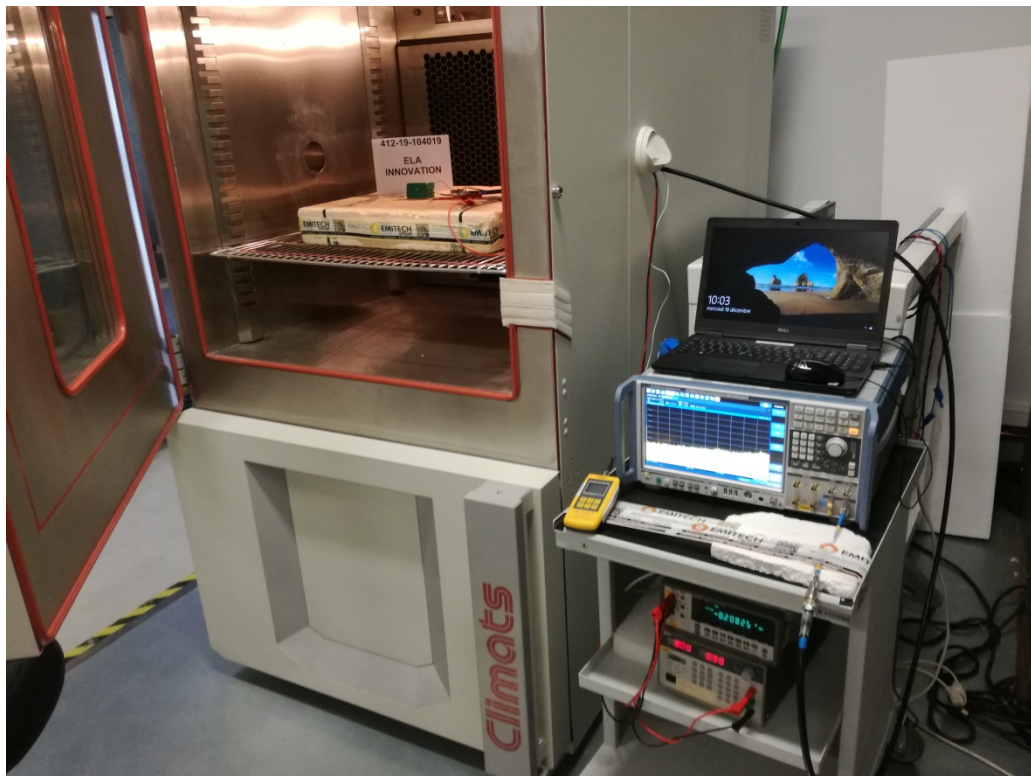
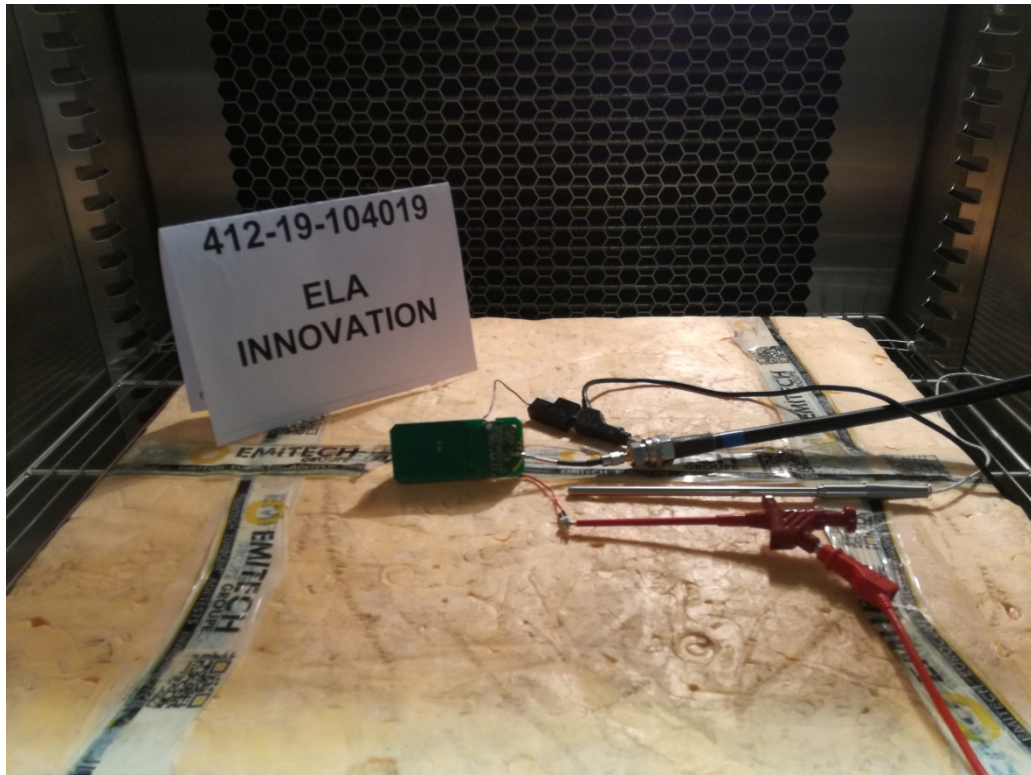

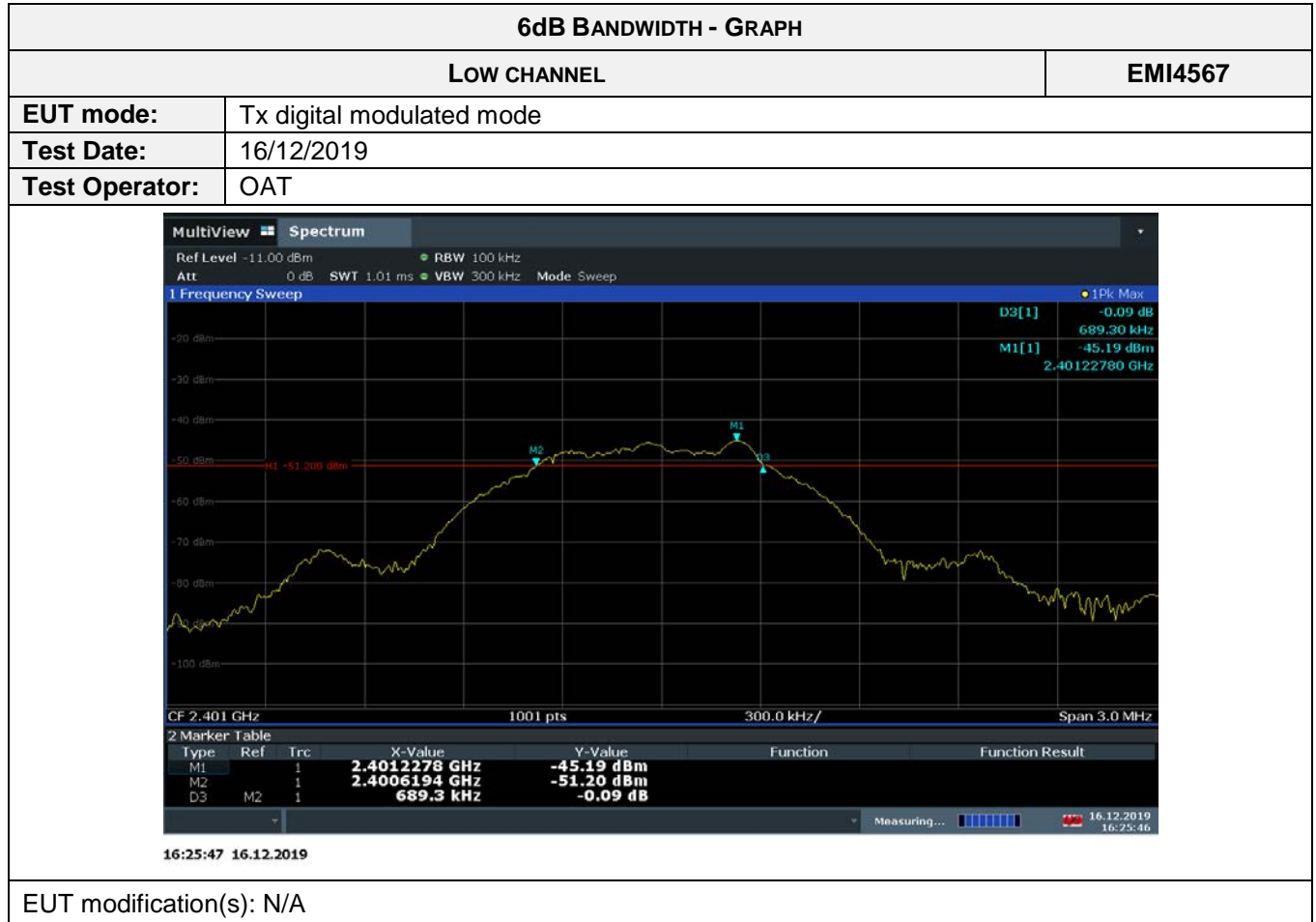

6dB BANDWIDTH - TABULATED RESULTS			
LOW CHANNEL			EMI4567
U_{Start} (start of the test):	3.6Vdc	U_{End} (end of the test):	3.6Vdc
Voltage drop:	0%	Limit:	+/- 1%
f_{Low} (MHz)	f_{High} (MHz)	Result (f_{high}-f_{low})	Limit
-	-	689.3kHz	>500kHz

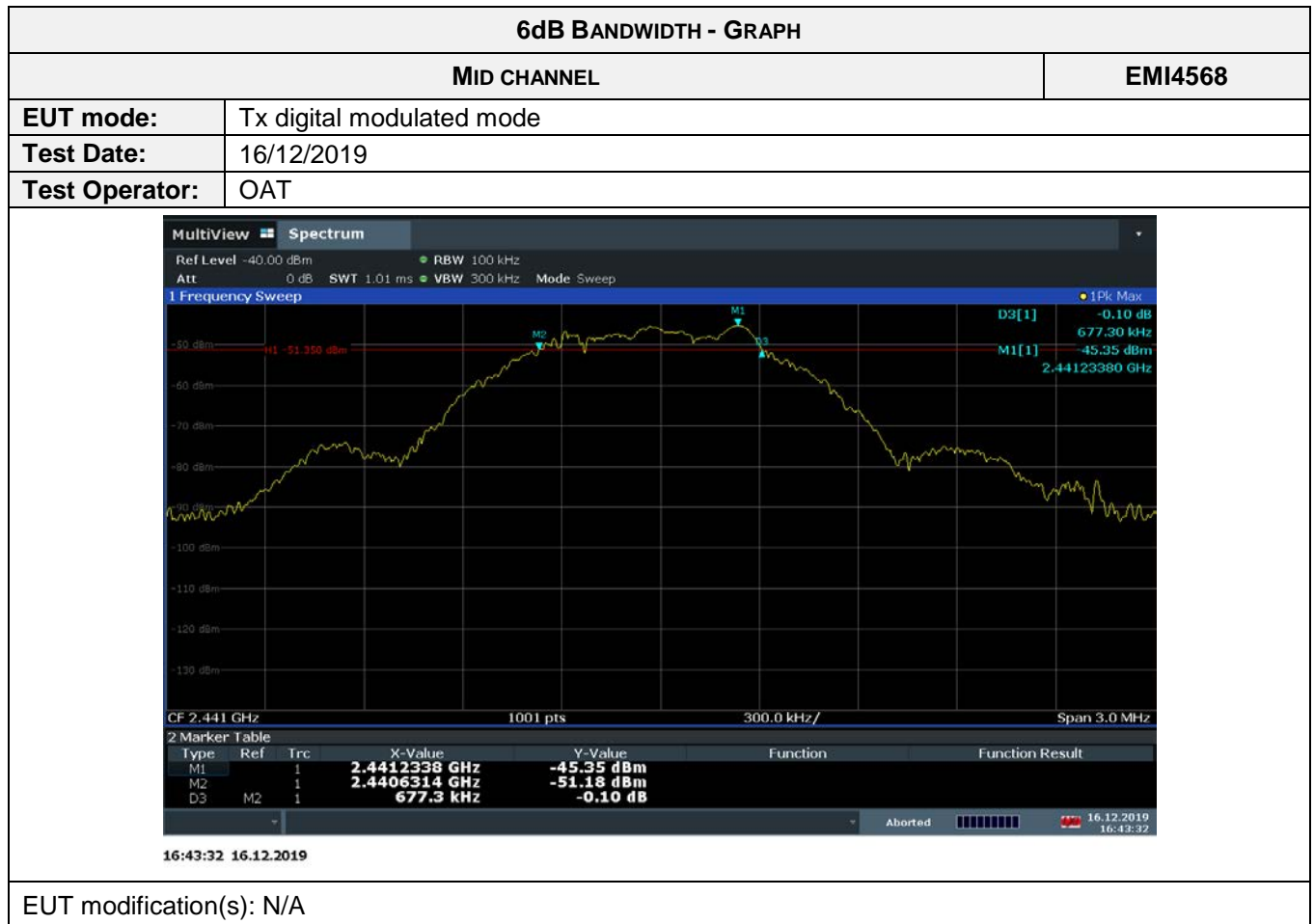

6dB BANDWIDTH - TABULATED RESULTS			
MID CHANNEL			EMI4568
U_{Start} (start of the test):	3.6Vdc	U_{End} (end of the test):	3.6Vdc
Voltage drop:	0%	Limit:	+/- 1%
f_{Low}	f_{High}	Result (f_{high}-f_{low})	Limit
-	-	677.3kHz	>500kHz

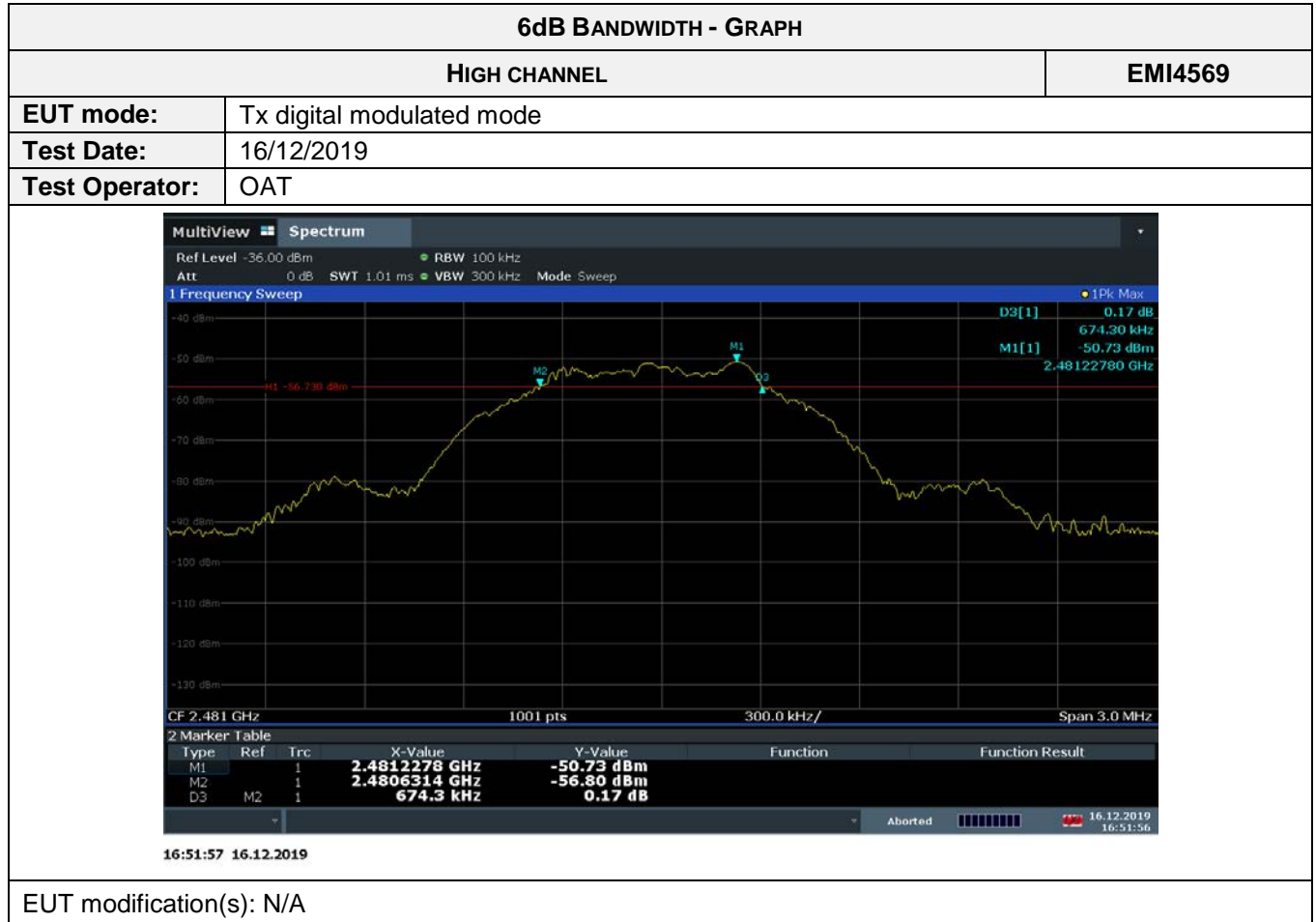

6dB BANDWIDTH - TABULATED RESULTS			
HIGH CHANNEL			EMI4569
U_{Start} (start of the test):	3.6Vdc	U_{End} (end of the test):	3.6Vdc
Voltage drop:	0%	Limit:	+/- 1%
f_{Low}	f_{High}	Result (f_{high}-f_{low})	Limit
-	-	674.3kHz	>500kHz

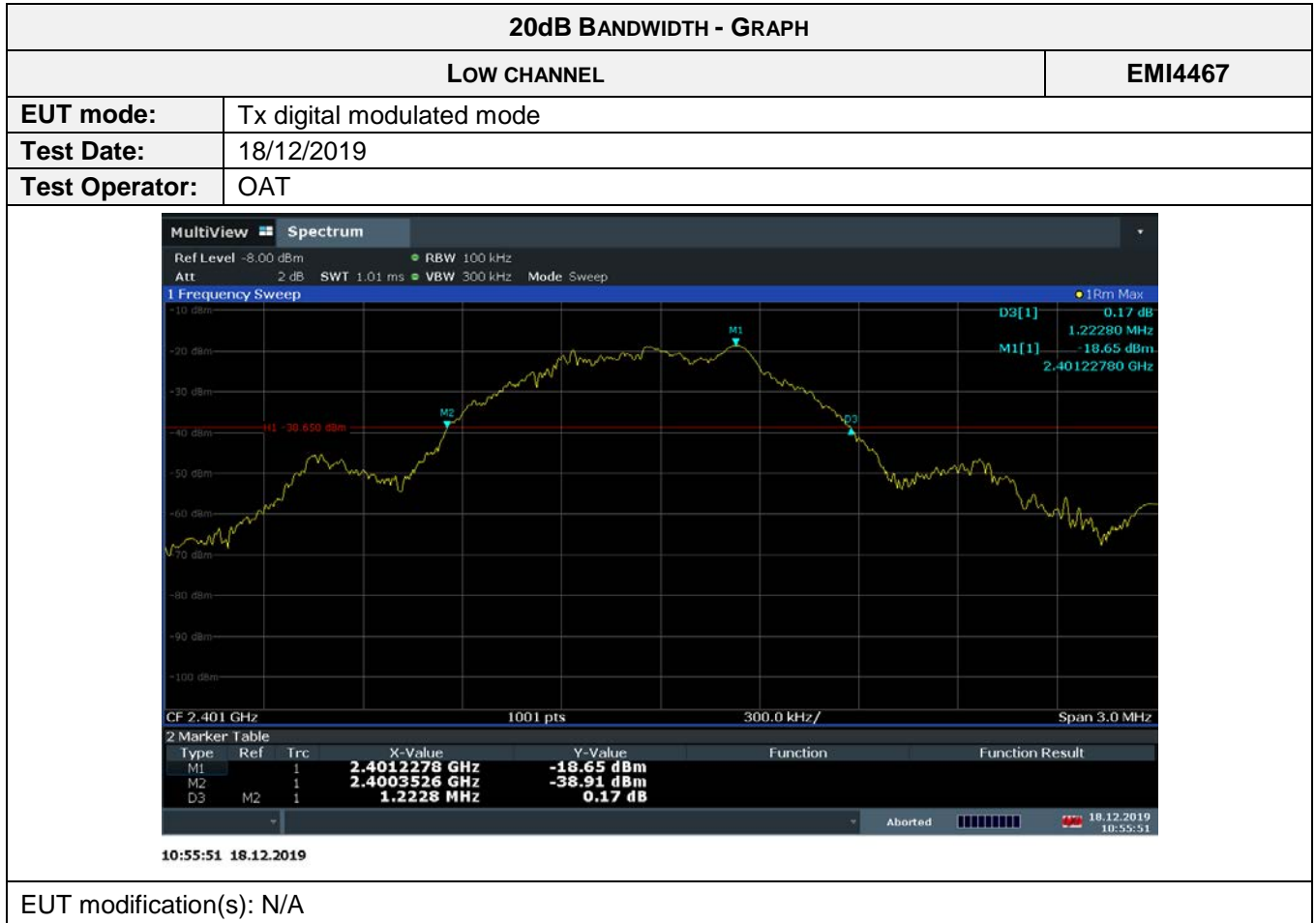

20dB BANDWIDTH - TABULATED RESULTS			
LOW CHANNEL			EMI4467
U_{Start} (start of the test):	3.6Vdc	U_{End} (end of the test):	3.6Vdc
Voltage drop:	0%	Limit:	+/- 1%
f_{Low} (MHz)	f_{High} (MHz)	Result (f_{high}-f_{low})	Limit
-	-	1.223 MHz	>500kHz

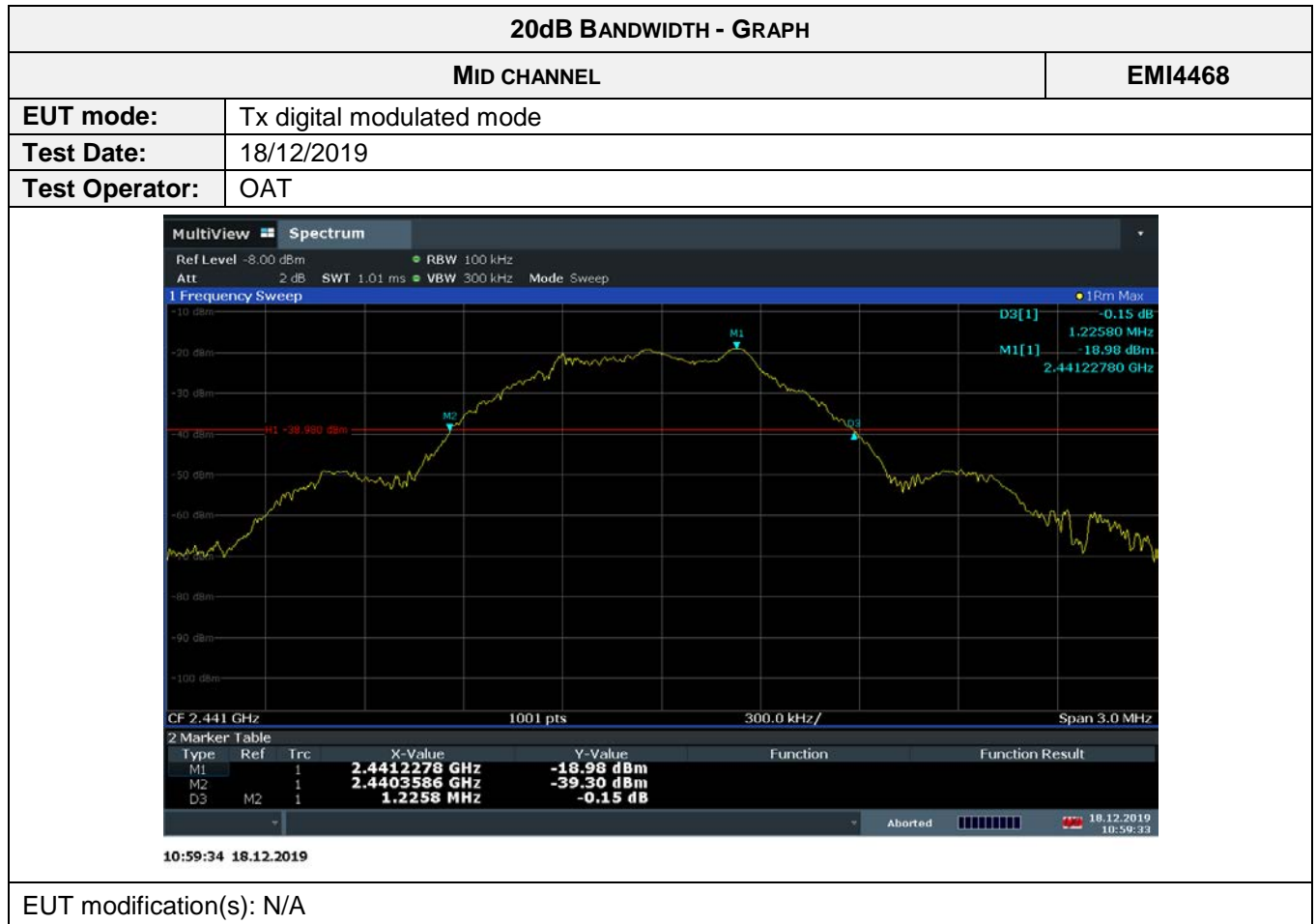

20dB BANDWIDTH - TABULATED RESULTS			
MID CHANNEL			EMI4468
U_{Start} (start of the test):	3.6Vdc	U_{End} (end of the test):	3.6Vdc
Voltage drop:	0%	Limit:	+/- 1%
f_{Low}	f_{High}	Result (f_{high}-f_{low})	Limit
-	-	1.226 MHz	>500kHz

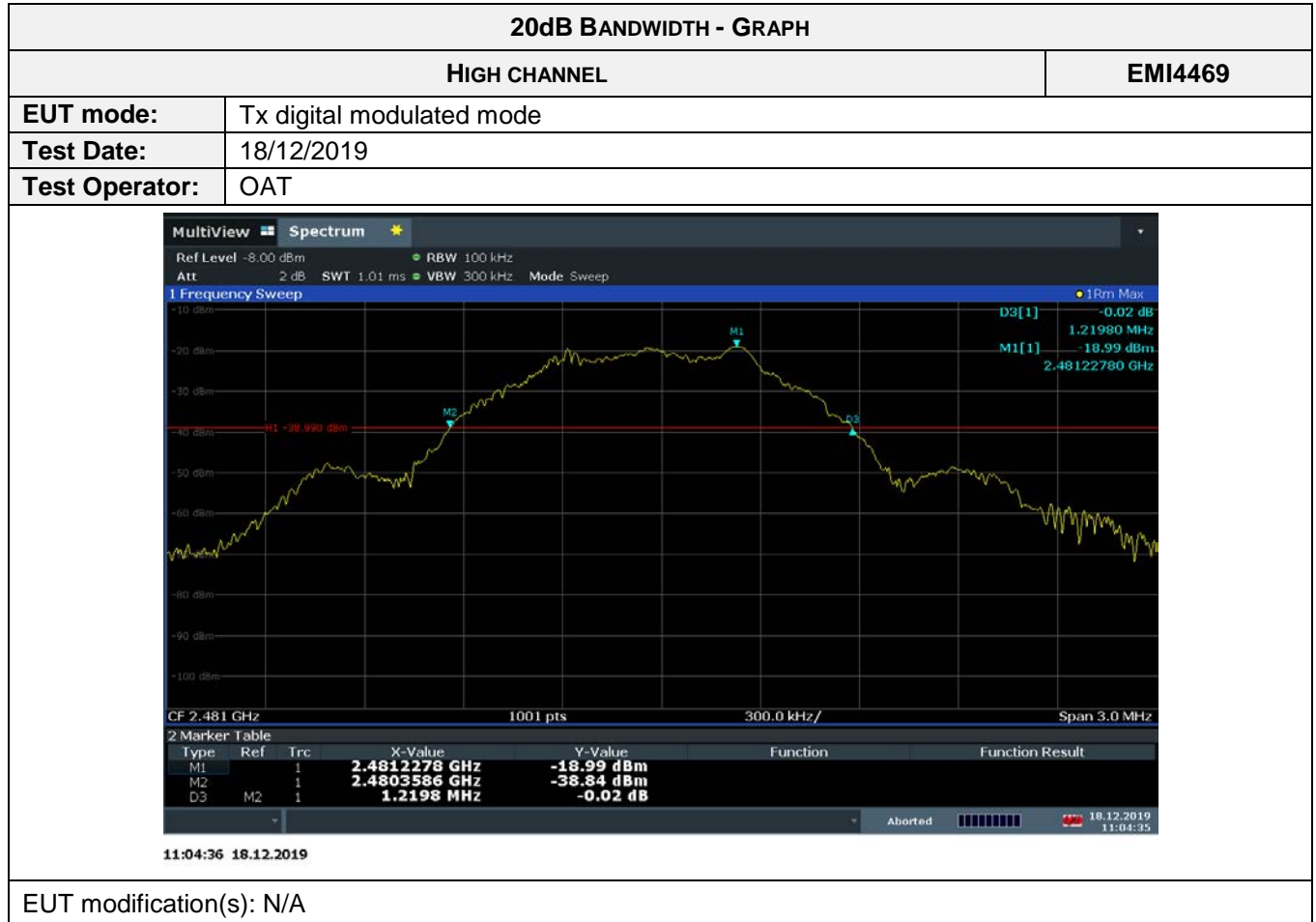

20dB BANDWIDTH - TABULATED RESULTS			
HIGH CHANNEL			EMI4469
U_{Start} (start of the test):	3.6Vdc	U_{End} (end of the test):	3.6Vdc
Voltage drop:	0%	Limit:	+/- 1%
f_{Low}	f_{High}	Result (f_{high}-f_{low})	Limit
-	-	1.220 MHz	>500kHz

9.7. Power spectral density

Reference standard:	FCC part 15 Radio part 15.247 and RSS-247
Test method:	FCC part 15.247 and RSS-247
Test description: e) For digitally modulated systems, the power spectral density conducted from the intentional radiator to the antenna shall not be greater than 8 dBm in any 3 kHz band during any time interval of continuous transmission. This power spectral density shall be determined in accordance with the provisions of paragraph (b) of this section. The same method of determining the conducted output power shall be used to determine the power spectral density. EUT is set on an insulating support at 150cm above the ground reference plane. Measurement are done on a normalized test site by the substitution method. The test antenna is oriented in the two polarizations (vertical and horizontal), and the product is rotated at 360° in the horizontal plane (See photo(s) for initial position of the EUT(0°)). If applicable the test antenna was raised and lowered through the specified range of height until a maximum signal level is detected. For portable equipments a research of maximum level is done on the 3 axes. Only the highest levels are recorded.	

TESTED CHANNEL	RESULT	SEVERITY	RESULT TAB.	VERDICT
PSD/3KHz - Low Channel	-0.488dBm/3kHz	8dBm/3kHz	EMI4559	PASS
PSD/3KHz - Mid Channel	0.467dBm/3kHz	8dBm/3kHz	EMI4556	PASS
PSD/3KHz - High Channel	-5.25dBm/3kHz	8dBm/3kHz	EMI4558	PASS

LABORATORY PARAMETERS:	REQUIRED PRIOR TO THE TEST	DURING THE TEST
Ambient Temperature	15 to 35 °C	See Graph(es)
Relative Humidity	20 to 75 %	See Graph(es)
Atmospheric pressure	N/A	See Graph(es)
Test method deviation: N/A		
Supplementary information: N/A		

TEST EQUIPMENT USED					
CATEGORY	BRAND	TYPE	IDENTIFIER	CAL. DATE	CAL. DUE
Antenna	ETS-Lindgren	3117	5456	24/07/2019	24/09/2022
Attenuator	EMITECH	SUB.V2-H	14495	25/09/2019	25/11/2020
Attenuator	EMITECH	SUB.V2-V	14496	25/09/2019	25/11/2020
Cable	MegaPhase	N-3m	14852	29/10/2018	29/12/2020
Cable	MegaPhase	N-5m	14855	12/02/2018	12/04/2020
Cable	Huber + Suhner	SF102K	16041	28/02/2019	28/04/2021
Cable	MegaPhase	TM18-N1N1-118	12842	09/05/2018	09/07/2020
Receiver	Rohde & Schwarz	FSW43	14830	28/12/2018	28/02/2020
Shielded enclosure	RAY PROOF	C.V2	1423		
Software	Nexio		0000		
Thermohygrometer	Testo	608-H1	7562	25/01/2019	25/03/2021
Thermohygrometer	Bioblock Scientific	Météostar	0963	25/01/2019	25/03/2021

BAT-EMC software version: V3.18.0.26

Blank cells = Permanent validity

TEST SETUP PHOTO(S)

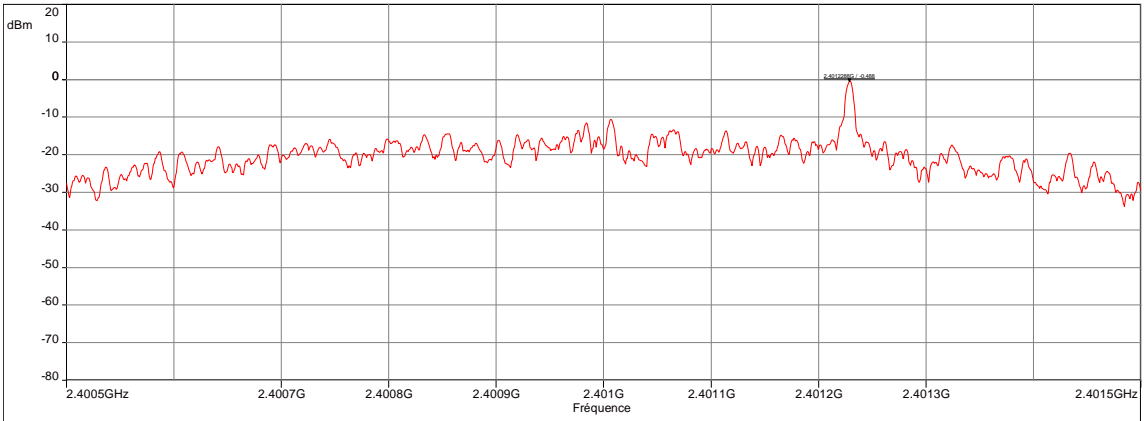

POWER SPECTRAL DENSITY - GRAPH					
PSD/3KHz - LOW CHANNEL				EMI4559	
EUT mode:	Continuous modulated Tx			T (°C):	22.2
Test Date:	16/12/2019 16:26:34			H (%):	44.5
Test Operator:	OAT			P (hPa):	998
Description Sous-bande 1 Fréquences: 2.4005 GHz - 2.4015 GHz (Mode analyseur) 10000 Points Réglages: RBW: 3kHz, VBW: 10kHz, Auto, Atténuation : Auto, Nombre de Balayages : 1, Preamp : Off, LN Preamp : Off, Preselecteur: Off Polarisation: Horizontale Distance: 3 m					
					
PSD/3KHz - BLUE ANCHOR Family - Low Channel - 16/12/2019 16:26 - 4560					
POSITION	FREQUENCIES	RBW	VBW	DETECTOR	
Vertical	2.4005GHz-2.4015GHz	3kHz	10kHz	Peak	
Configuration:					
Comments:					
EUT modification(s): N/A					

POWER SPECTRAL DENSITY - TABULATED RESULTS			
PSD/3KHz - LOW CHANNEL			EMI4559
U_{Start} (start of the test):	N/P	U_{End} (end of the test):	N/P
Voltage drop:	N/P	Limit:	+/- 5%
Frequency (MHz)	Polarization	Level	Limit
2401	Horizontal	-0.488dBm/3kHz	8dBm/3kHz

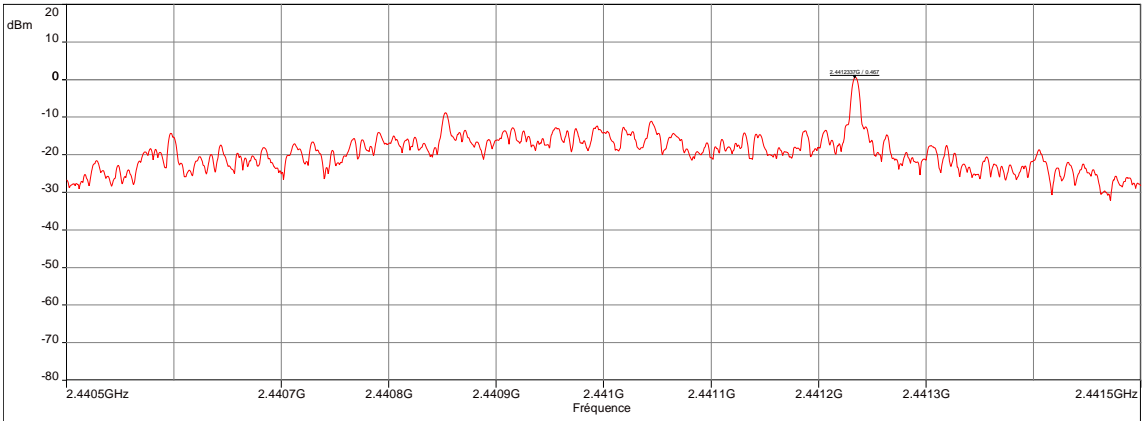
POWER SPECTRAL DENSITY - GRAPH					
PSD/3KHZ - MID CHANNEL				EMI4556	
EUT mode:	Continuous modulated Tx			T (°C):	22.2
Test Date:	16/12/2019 16:40:14			H (%):	44.5
Test Operator:	OAT			P (hPa):	998
<p>Description Sous-bande 1 Fréquences: 2.4405 GHz - 2.4415 GHz (Mode analyseur) 10000 Points Réglages: RBW: 3kHz, VBW: 10kHz, Auto, Atténuation : Auto, Nombre de Balayages : 1, Preamp : Off, LN Preamp : Off, Preselecteur: Off Polarisation: Horizontale Distance: 3 m</p> <p style="text-align: right;">— Mes. Peak (Horizontale)</p>  <p>PSD/3KHz - BLUE ANCHOR Family - Mid Channel - 07/01/2020 09:56 - 4562</p>					
POSITION	FREQUENCIES	RBW	VBW	DETECTOR	
Vertical	2.4405GHz-2.4415GHz	3kHz	10kHz	Peak	
Configuration:					
Comments:					
EUT modification(s): N/A					

POWER SPECTRAL DENSITY - TABULATED RESULTS			
PSD/3KHZ - MID CHANNEL			EMI4556
U_{Start} (start of the test):	N/P	U_{End} (end of the test):	N/P
Voltage drop:	N/P	Limit:	+/- 5%
Frequency (MHz)	Polarization	Level	Limit
2441	Horizontal	0.467dBm/3kHz	8dBm/3kHz

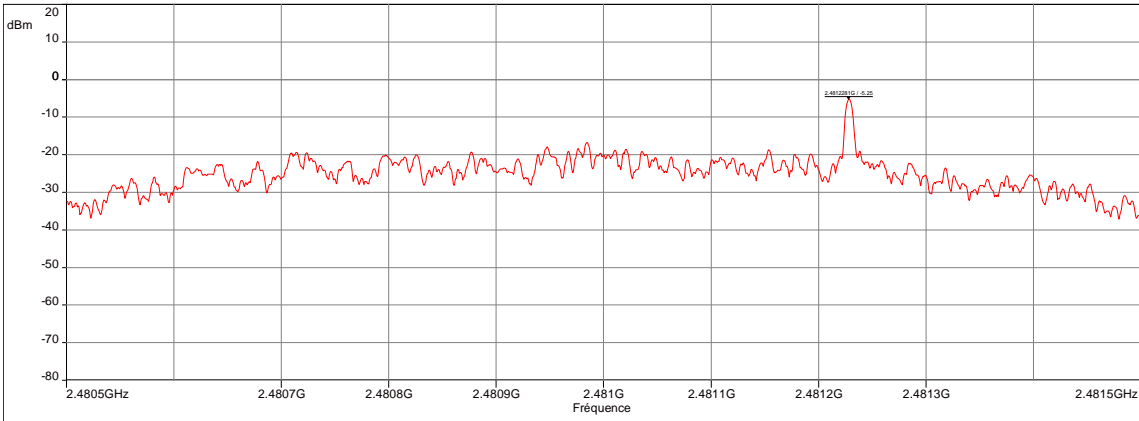
POWER SPECTRAL DENSITY - GRAPH				
PSD/3KHz - HIGH CHANNEL				EMI4558
EUT mode:	Continuous modulated Tx			T (°C): 22.2
Test Date:	16/12/2019 16:50:55			H (%): 44.5
Test Operator:	OAT			P (hPa): 998
<p>Description Sous-bande 1 Fréquences: 2.4805 GHz - 2.4815 GHz (Mode analyseur) 10000 Points Réglages: RBW: 3kHz, VBW: 10kHz, Auto, Atténuation : Auto, Nombre de Balayages : 1, Preamp : Off, LN Preamp : Off, Preselecteur: Off Polarisation: Horizontale Distance: 3 m</p> <p style="text-align: right;">— Mes. Peak (Horizontale)</p>  <p>PSD/3KHz - BLUE ANCHOR Family - High Channel - 16/12/2019 16:50 - 4563</p>				
POSITION	FREQUENCIES	RBW	VBW	DETECTOR
Vertical	2.4805GHz-2.4815GHz	3kHz	10kHz	Peak
Configuration:				
Comments:				
EUT modification(s): N/A				

POWER SPECTRAL DENSITY - TABULATED RESULTS			
PSD/3KHz - HIGH CHANNEL			EMI4558
U_{Start} (start of the test):	N/P	U_{End} (end of the test):	N/P
Voltage drop:	N/P	Limit:	+/- 5%
Frequency (MHz)	Polarization	Level	Limit
2481	Horizontal	-5.25dBm/3kHz	8dBm/3kHz

9.8. Occupied Bandwidth

Reference standard:	FCC part 15 Radio part 15.247 and RSS-247
Test method:	ANSI C63.10: 2013
<p>Test description: The occupied bandwidth (OBW) is the Frequency Range in which 99 % of the total mean power of a given emission falls. The residual part of the total power being denoted as β, which, in cases of symmetrical spectra, splits up into $\beta/2$ on each side of the spectrum. Unless otherwise specified, $\beta/2$ is taken as 0,5 %.</p> <p>The maximum occupied bandwidth includes all associated side bands above the appropriate emissions level and the frequency error or drift under extreme test conditions.</p> <p>EUT is connected to the measuring receiver via 50Ω attenuator(s).</p>	

TESTED CHANNEL	OBW	SEVERITY	RESULT TAB.	VERDICT
Low channel	1.073MHz	> 500kHz	EMI4502	PASS
Mid channel	1.059MHz	> 500kHz	EMI4610	PASS
High channel	1.061MHz	> 500kHz	EMI4609	PASS

LABORATORY PARAMETERS:	REQUIRED PRIOR TO THE TEST	DURING THE TEST
Ambient Temperature	15 to 35 °C	24.1 °C
Relative Humidity	20 to 75 %	51.5 %
Atmospheric pressure	N/A	1002 hPa
Test method deviation: N/A		
Supplementary information: EUT power supply is replaced by a stabilized power supply.		

TEST EQUIPMENT USED					
CATEGORY	BRAND	TYPE	IDENTIFIER	CAL. DATE	CAL. DUE
Attenuator	Radiall	R412710124	16491	25/06/2019	25/08/2021
Cable	N	3m	16426	04/05/2019	04/07/2021
Cable	Huber + Suhner	SF102K	16041	28/02/2019	28/04/2021
Climatic enclosure	CLIMATS	EXCAL 7714-HA	14261	19/09/2019	19/11/2020
Multimeter	FLUKE	8808A	12446	20/07/2019	20/09/2020
Power supply	TTi	TSX-1820P	4365		
Receiver	Rohde & Schwarz	FSW43	14830	28/12/2018	28/02/2020
Thermohygrometer	Testo	608-H2	12268	27/11/2017	27/01/2020
Thermometer contactless	GHM Greisinger	GMH 3710	12968	11/02/2019	11/04/2020

Blank cells = Permanent validity

TEST SETUP PHOTO(S)

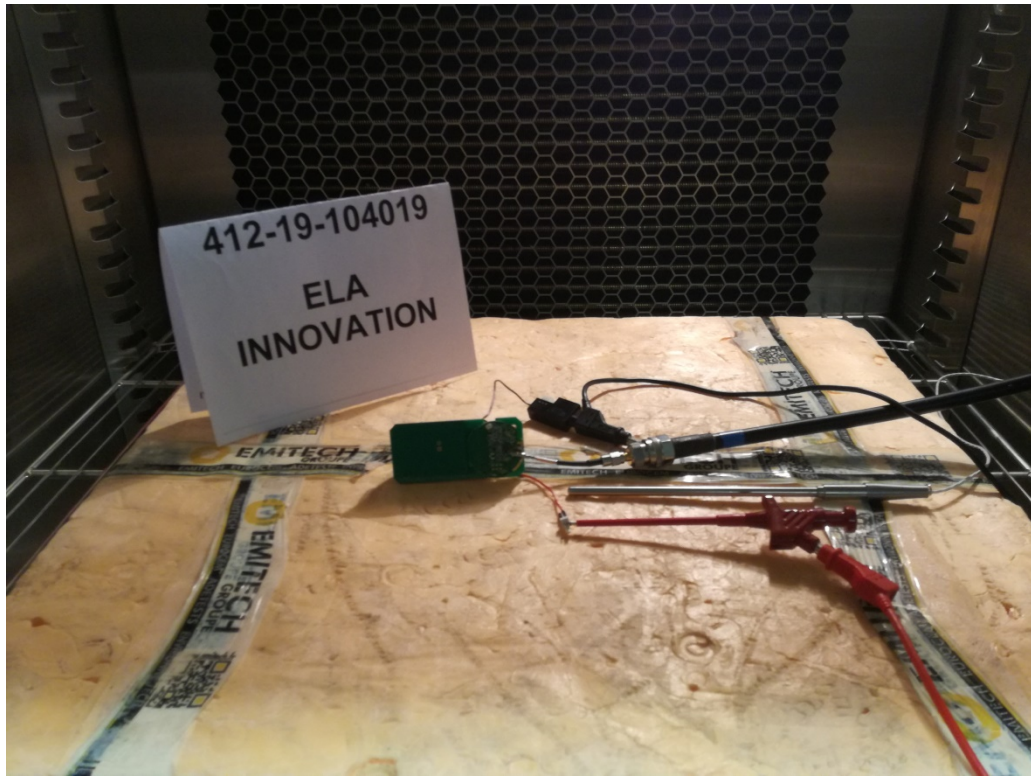

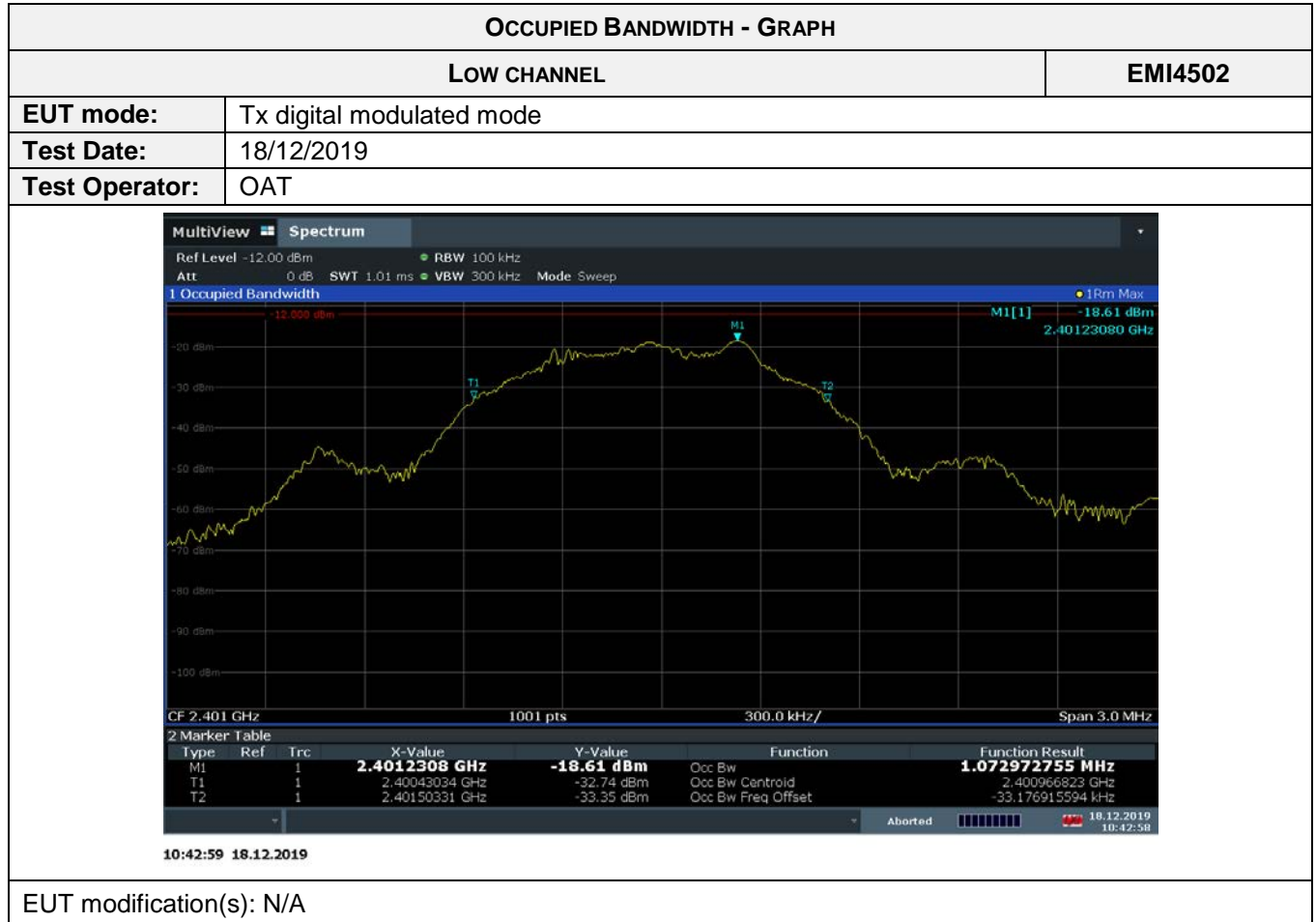

OCCUPIED BANDWIDTH - TABULATED RESULTS			
LOW CHANNEL			EMI4502
U_{Start} (start of the test):	3.6Vdc	U_{End} (end of the test):	3.6Vdc
Voltage drop:	0%	Limit:	+/- 1%
f_{Low} (MHz)	f_{High} (MHz)	OBW (f_{high}-f_{low})	Limit
2400.430	2401.503	1.073MHz	>500kHz

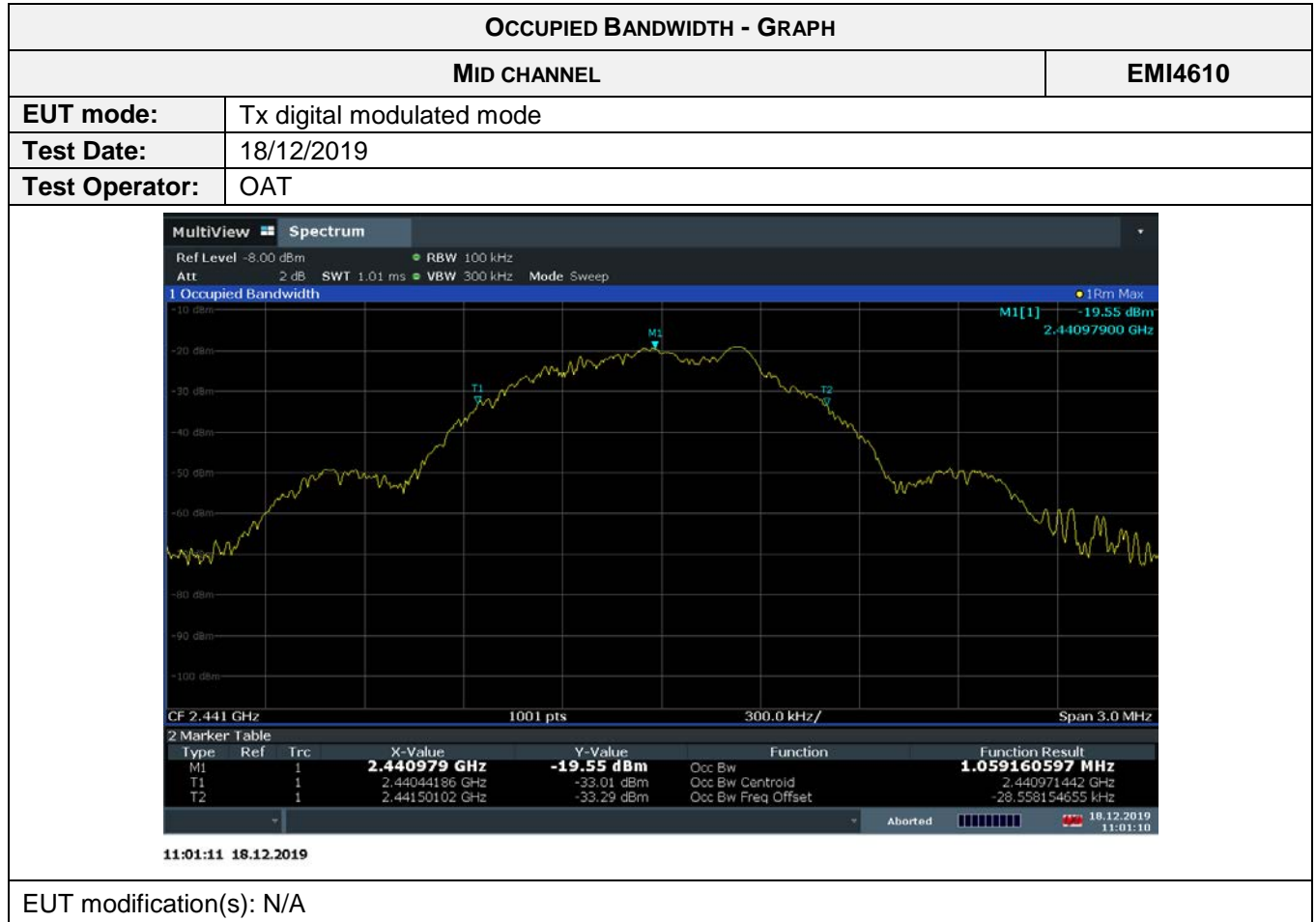

OCCUPIED BANDWIDTH - TABULATED RESULTS			
MID CHANNEL			EMI4610
U_{Start} (start of the test):	3.6Vdc	U_{End} (end of the test):	3.6Vdc
Voltage drop:	0%	Limit:	+/- 1%
f_{Low} (MHz)	f_{High} (MHz)	OBW (f_{high}-f_{low})	Limit
2440.442	2441.501	1.059MHz	>500kHz

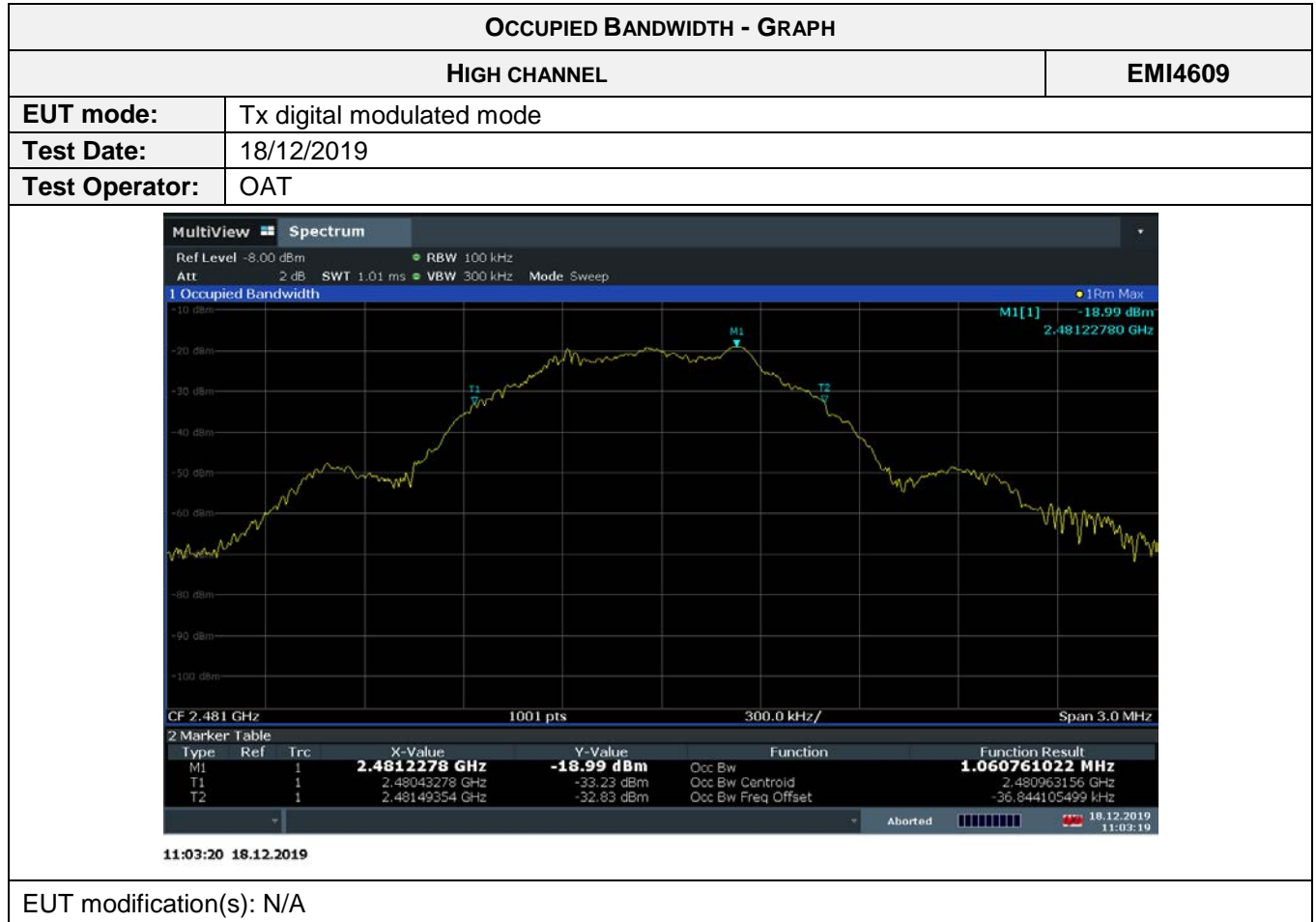

OCCUPIED BANDWIDTH - TABULATED RESULTS			
HIGH CHANNEL			EMI4609
U_{Start} (start of the test):	3.6Vdc	U_{End} (end of the test):	3.6Vdc
Voltage drop:	0%	Limit:	+/- 1%
f_{Low} (MHz)	f_{High} (MHz)	OBW (f_{high}-f_{low})	Limit
2480.433	2481.494	1.061MHz	>500kHz

9.9. Measurement of Frequency Stability

Reference standard:	FCC part 15 Radio part 15.215 c)
Test method:	FCC part 15 Radio part 15.215 c) and RSS Gen
<p>Test description: The requirement to contain the designated bandwidth of the emission within the specified frequency band includes the effects from frequency sweeping, frequency hopping and other modulation techniques that may be employed as well as the frequency stability of the transmitter over expected variations in temperature and supply voltage. If frequency stability is not specified in the regulations, it is recommended that the fundamental emission be kept within at least the central 80% of the permitted band in order to minimize the possibility of out-of-band operation.</p> <p>EUT is set inside the climatic enclosure. It is connected to the measuring receiver via 50Ω attenuator(s). RBW=100Hz</p>	

TEST CASE	EUT MODE	SEVERITY	RESULT TAB.	VERDICT
Low channel / 25°C/ 3.6Vdc	Tx-CW	2400MHz <F< 2483.5MHz	EMI4503	PASS
Low channel / 25°C/ 3.0Vdc	Tx-CW		EMI4504	PASS
Low channel / -40°C/ 3.6Vdc	Tx-CW		EMI4611	PASS
Low channel / -40°C/ 3.0Vdc	Tx-CW		EMI4612	PASS
Low channel / 85°C/ 3.6Vdc	Tx-CW		EMI4613	PASS
Low channel / 85°C/ 3.0Vdc	Tx-CW		EMI4614	PASS
High channel / 25°C/ 3.6Vdc	Tx-CW		EMI4616	PASS
High channel / 25°C/ 3.0Vdc	Tx-CW		EMI4617	PASS
High channel / -40°C/ 3.6Vdc	Tx-CW		EMI4618	PASS
High channel / -40°C/ 3.0Vdc	Tx-CW		EMI4619	PASS
High channel / 85°C/ 3.6Vdc	Tx-CW		EMI4620	PASS
High channel / 85°C/ 3.0Vdc	Tx-CW		EMI4621	PASS

LABORATORY PARAMETERS:	REQUIRED PRIOR TO THE TEST	DURING THE TEST
Ambient Temperature	15 to 35 °C	24.1 °C
Relative Humidity	20 to 75 %	51.5 %
Atmospheric pressure	N/A	1002 hPa
Test method deviation: N/A		
Supplementary information: EUT power supply is replaced by a stabilized power supply.		

TEST EQUIPMENT USED					
CATEGORY	BRAND	TYPE	IDENTIFIER	CAL. DATE	CAL. DUE
Attenuator	Radiall	R412710124	16491	25/06/2019	25/08/2021
Cable	N	3m	16426	04/05/2019	04/07/2021
Cable	Huber + Suhner	SF102K	16041	28/02/2019	28/04/2021
Climatic enclosure	CLIMATS	EXCAL 7714-HA	14261	19/09/2019	19/11/2020
Multimeter	FLUKE	8808A	12446	20/07/2019	20/09/2020
Power supply	TTi	TSX-1820P	4365		
Spectrum analyzer	Rohde & Schwarz	FSW43	14830	28/12/2018	28/02/2020
Thermohygrometer	Testo	608-H2	12268	27/11/2017	27/01/2020
Thermometer contactless	GHM Greisinger	GMH 3710	12968	11/02/2019	11/04/2020

Blank cells = Permanent validity

TEST SETUP PHOTO(S)

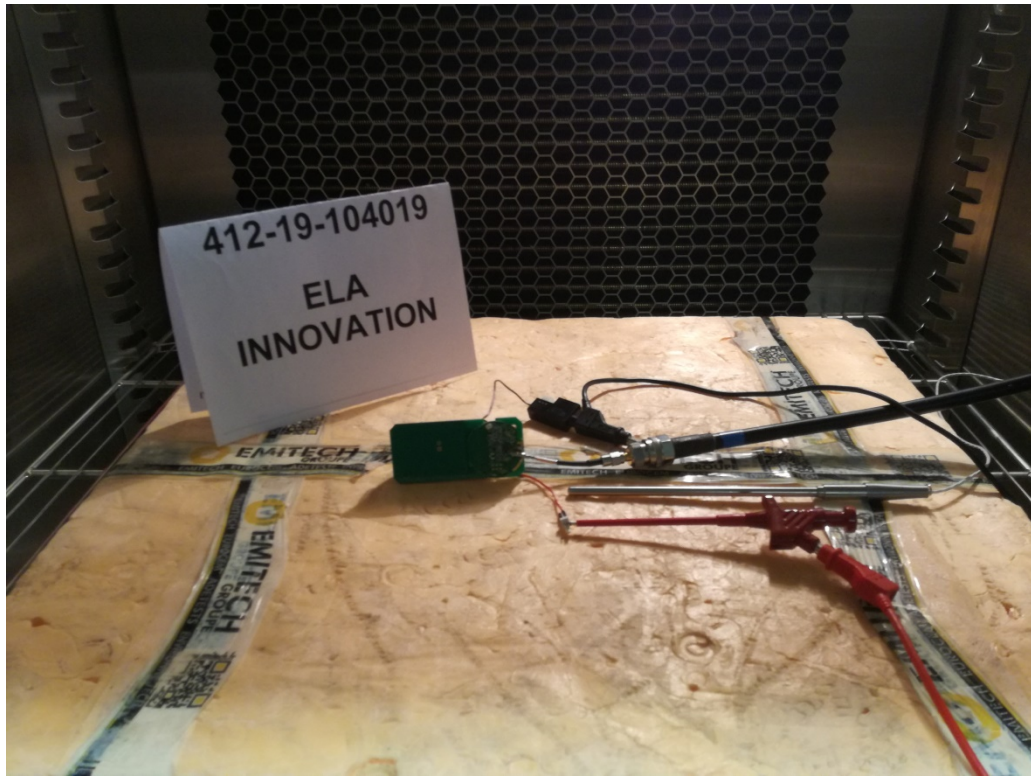

FREQUENCY ERROR - TABULATED RESULTS				
TEST CASE	FREQUENCY (MHz)	FREQUENCY ERROR (kHz)	LIMIT	RESULT TAB.
Low channel / 25°C/ 3.6Vdc	2400.969360	N/A	2400MHz <F< 2483.5MHz	EMI4503
Low channel / 25°C/ 3.0Vdc	2400.969075	-0.285		EMI4504
Low channel / -40°C/ 3.6Vdc	2400.947329	-22.031		EMI4611
Low channel / -40°C/ 3.0Vdc	2400.947529	-21.831		EMI4612
Low channel / 85°C/ 3.6Vdc	2400.981669	12.309		EMI4613
Low channel / 85°C/ 3.0Vdc	2400.981689	12.329		EMI4614
High channel / 25°C/ 3.6Vdc	2480.968335	N/A		EMI4616
High channel / 25°C/ 3.0Vdc	2480.968110	-0.2249		EMI4617
High channel / -40°C/ 3.6Vdc	2480.946604	-21.7309		EMI4618
High channel / -40°C/ 3.0Vdc	2480.946454	-21.8809		EMI4619
High channel / 85°C/ 3.6Vdc	2480.981610	13.2751		EMI4620
High channel / 85°C/ 3.0Vdc	2480.981475	13.1401		EMI4621

EUT MODIFICATIONS	OPERATOR	TEST DATE	RESULT TAB.
N/A	OAT	18/12/2019	-

End of test report