



Shenzhen Huaxia Testing Technology Co., Ltd

1F., Block A of Tongsheng Technology Building, Huahui Road, Dalang Street, Longhua District, Shenzhen, China

Telephone: +86-755-26648640
Fax: +86-755-26648637
Website: www.cqa-cert.com

Report Template Version: V03
Report Template Revision Date: Mar.1st, 2017

FCC Test Report

Applicant: SHENZHEN ZIJIANG ELECTRONICS CO., LTD

Address of Applicant: Area A, 4/F, No. 20, Tongfucun Industrial Zone, Dalang Community, Dalang Street, LongHua New District, Shenzhen City, Guangdong Province, P.R. China

Manufacturer: SHENZHEN ZIJIANG ELECTRONICS CO., LTD

Address of Manufacturer: Area A, 4/F, No. 20, Tongfucun Industrial Zone, Dalang Community, Dalang Street, LongHua New District, Shenzhen City, Guangdong Province, P.R. China

Factory: SHENZHEN ZIJIANG ELECTRONICS CO., LTD

Address of Factory: Area A, 4/F, No. 20, Tongfucun Industrial Zone, Dalang Community, Dalang Street, LongHua New District, Shenzhen City, Guangdong Province, P.R. China

Equipment Under Test (EUT):

Product: Portable Thermal Printer

Model No.: ZJ-5807LN, ZJ-5807DD, POS-5807LN, POS-5807DD

Test Model No.: ZJ-5807DD

Brand Name: **Zjiang**[®]

FCC ID: RVUZJ-5807DD

Standards: 47 CFR Part 15, Subpart C

Date of Test: 2017-05-27 to 2017-06-10

Date of Issue: 2017-06-10

Report No. : CQASZ170501347EW-02

Test Result : **PASS***

Tested By:



(Aaron Ma)

Reviewed By:



(Owen Zhou)

Approved By:

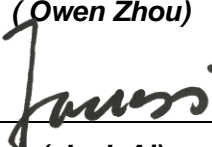

(Jack Ai)



* In the configuration tested, the EUT complied with the standards specified above.

2 Version

Revision History Of Report

Report No.	Version	Description	Issue Date
CQASZ170501347EW-02	Rev.01	Initial report	2017-06-10

3 Test Summary

Test Item	Test Requirement	Test method	Result
Antenna Requirement	47 CFR Part 15, Subpart C Section 15.203/15.247 (c)	ANSI C63.10 2013	PASS
AC Power Line Conducted Emission	47 CFR Part 15, Subpart C Section 15.207	ANSI C63.10 2013	PASS
Conducted Peak Output Power	47 CFR Part 15, Subpart C Section 15.247 (b)(3)	ANSI C63.10 2013	PASS
6dB Occupied Bandwidth	47 CFR Part 15, Subpart C Section 15.247 (a)(2)	ANSI C63.10 2013	PASS
Power Spectral Density	47 CFR Part 15, Subpart C Section 15.247 (e)	ANSI C63.10 2013	PASS
Band-edge for RF Conducted Emissions	47 CFR Part 15, Subpart C Section 15.247(d)	ANSI C63.10 2013	PASS
RF Conducted Spurious Emissions	47 CFR Part 15, Subpart C Section 15.247(d)	ANSI C63.10 2013	PASS
Radiated Spurious Emissions	47 CFR Part 15, Subpart C Section 15.205/15.209	ANSI C63.10 2013	PASS
Restricted bands around fundamental frequency (Radiated Emission)	47 CFR Part 15, Subpart C Section 15.205/15.209	ANSI C63.10 2013	PASS

4 Contents

	Page
1 COVER PAGE	1
2 VERSION	2
3 TEST SUMMARY	3
4 CONTENTS	4
5 GENERAL INFORMATION	5
5.1 CLIENT INFORMATION	5
5.2 GENERAL DESCRIPTION OF EUT	5
5.3 TEST ENVIRONMENT	7
5.4 DESCRIPTION OF SUPPORT UNITS	7
5.5 STATEMENT OF THE MEASUREMENT UNCERTAINTY	7
5.6 TEST LOCATION	7
5.7 TEST FACILITY	8
5.8 DEVIATION FROM STANDARDS	8
5.9 ABNORMALITIES FROM STANDARD CONDITIONS	8
5.10 OTHER INFORMATION REQUESTED BY THE CUSTOMER	8
5.11 EQUIPMENT LIST	9
6 TEST RESULTS AND MEASUREMENT DATA	10
6.1 ANTENNA REQUIREMENT	10
6.2 CONDUCTED EMISSIONS	11
6.3 CONDUCTED PEAK OUTPUT POWER	14
6.4 6dB OCCUPY BANDWIDTH	17
6.5 POWER SPECTRAL DENSITY	20
6.6 BAND-EDGE FOR RF CONDUCTED EMISSIONS	23
6.7 SPURIOUS RF CONDUCTED EMISSIONS	25
6.8 RADIATED SPURIOUS EMISSION	32
6.8.1 <i>Spurious Emissions</i>	32
6.9 RESTRICTED BANDS AROUND FUNDAMENTAL FREQUENCY	39
7 PHOTOGRAPHS - EUT TEST SETUP	42
7.1 CONDUCTED EMISSION	42
7.2 RADIATED SPURIOUS EMISSION	42
8 PHOTOGRAPHS - EUT CONSTRUCTIONAL DETAILS	44

5 General Information

5.1 Client Information

Applicant:	SHENZHEN ZIJIANG ELECTRONICS CO., LTD
Address of Applicant:	Area A, 4/F, No. 20, Tongfucun Industrial Zone, Dalang Community, Dalang Street, LongHua New District, Shenzhen City, Guangdong Province, P.R. China
Manufacturer:	SHENZHEN ZIJIANG ELECTRONICS CO., LTD
Address of Manufacturer:	Area A, 4/F, No. 20, Tongfucun Industrial Zone, Dalang Community, Dalang Street, LongHua New District, Shenzhen City, Guangdong Province, P.R. China
Factory:	SHENZHEN ZIJIANG ELECTRONICS CO., LTD
Address of Factory:	Area A, 4/F, No. 20, Tongfucun Industrial Zone, Dalang Community, Dalang Street, LongHua New District, Shenzhen City, Guangdong Province, P.R. China

5.2 General Description of EUT

Product Name:	Portable Thermal Printer
Model No.:	ZJ-5807LN, ZJ-5807DD, POS-5807LN, POS-5807DD
Test Model No.:	ZJ-5807DD
Trade Mark:	
Hardware Version:	V1.0
Software Version:	V1.0
Operation Frequency:	2402MHz~2480MHz
Bluetooth Version:	V4.0 BLE
Modulation Type:	GFSK
Number of Channel:	40
Sample Type:	Portable production
Test Software of EUT:	RF Test (manufacturer declare)
Antenna Type:	PCB Antenna
Antenna Gain:	0dBi
Power Supply:	AC ADAPTER: MODEL: ZL-A015W0901500 INPUT: 100-200V ~50/60Hz 0.5 Max, OUTPUT: DC9V 1.5A Li-ion Battery: Model: 58LYDD-ZJ, Vol: 7.4V/1500mAh/11.1Wh

Note: Only the model ZJ-5807DD was tested, since the electrical circuit design, layout, components used and internal wiring were identical for the above models, with difference being color of appearance and model name.

Operation Frequency each of channel							
Channel	Frequency	Channel	Frequency	Channel	Frequency	Channel	Frequency
0	2402MHz	10	2422MHz	20	2442MHz	30	2462MHz
1	2404MHz	11	2424MHz	21	2444MHz	31	2464MHz
2	2406MHz	12	2426MHz	22	2446MHz	32	2466MHz
3	2408MHz	13	2428MHz	23	2448MHz	33	2468MHz
4	2410MHz	14	2430MHz	24	2450MHz	34	2470MHz
5	2412MHz	15	2432MHz	25	2452MHz	35	2472MHz
6	2414MHz	16	2434MHz	26	2454MHz	36	2474MHz
7	2416MHz	17	2436MHz	27	2456MHz	37	2476MHz
8	2418MHz	18	2438MHz	28	2458MHz	38	2478MHz
9	2420MHz	19	2440MHz	29	2460MHz	39	2480MHz

Note:

In section 15.31(m), regards to the operating frequency range over 10 MHz, the lowest frequency, the middle frequency, and the highest frequency of channel were selected to perform the test, and the selected channel see below:

Channel	Frequency
The lowest channel (CH0)	2402MHz
The middle channel (CH19)	2440MHz
The highest channel (CH39)	2480MHz

5.3 Test Environment

Operating Environment:	
Temperature:	25.0 °C
Humidity:	53 % RH
Atmospheric Pressure:	1010mbar
Test Mode:	Use test software (RF test) to set the lowest frequency, the middle frequency and the highest frequency keep transmitting of the EUT. Note: In the process of transmitting of EUT, the duty cycle >98%.

5.4 Description of Support Units

The EUT has been tested with associated equipment below.

Description	Manufacturer	Model No.	Remark	FCC certification
Adapter	UPRITE	ZL-A015W0901500	Provide by client	Verification

5.5 Statement of the measurement uncertainty

The data and results referenced in this document are true and accurate.

The reader is cautioned that there may be errors within the calibration limits of the equipment and facilities.

The measurement uncertainty was calculated for all measurements listed in this test report acc. to CISPR 16 - 4 „Specification for radio disturbance and immunity measuring apparatus and methods – Part 4: Uncertainty in EMC Measurements“ and is documented in the **Shenzhen Tongce Testing Lab** quality system acc. to DIN EN ISO/IEC 17025.

Furthermore, component and process variability of devices similar to that tested may result in additional deviation. The manufacturer has the sole responsibility of continued compliance of the device.

Hereafter the best measurement capability for **TCT** laboratory is reported:

Test	Range	Uncertainty	Notes
Radiated Emission	Below 1GHz	±3.92dB	(1)
Radiated Emission	Above 1GHz	±4.28dB	(1)
Conducted Disturbance	0.15~30MHz	±2.56dB	(1)

(1) This uncertainty represents an expanded uncertainty expressed at approximately the 95% confidence level using a coverage factor of k=2.

5.6 Test Location

Shenzhen Tongce Testing Lab,

1F, Leinuo Watch Building, Fuyong Town, Baoan Dist, Shenzhen, China

5.7 Test Facility

The test facility is recognized, certified, or accredited by the following organizations:

FCC – Registration No.: 572331

Shenzhen Tongce Testing Lab has been registered and fully described in a report filed with the (FCC) Federal Communications Commission. The acceptance letter from the FCC is maintained in our files. Registration 572331

5.8 Deviation from Standards

None.

5.9 Abnormalities from Standard Conditions

None.

5.10 Other Information Requested by the Customer

None.

5.11 Equipment List

Item	Test Equipment	Manufacturer	Model No.	Serial No.	Calibration Due Date
1	EMI Test Receiver	R&S	ESVD	100008	2017/08/11
2	Spectrum Analyzer	R&S	FSEM	848597/001	2017/08/11
3	Spectrum Analyzer	Agilent	N9020A	MY49100060	2017/08/12
4	Pre-amplifier	EM Electronics Corporation CO.,LTD	EM30265	07032613	2017/08/11
5	Pre-amplifier	HP	8447D	2727A05017	2017/08/11
6	Loop antenna	ZHINAN	ZN30900A	12024	2017/08/13
7	Broadband Antenna	R&S	VULB9163	340	2017/08/13
8	Horn Antenna	R&S	BBHA 9120D	631	2017/08/13
9	Horn Antenna	R&S	BBHA 9170	373	2017/08/13
10	Antenna Mast	CCS	CC-A-4M	N/A	N/A
11	Coax cable (9KHz~40GHz)	TCT	RE-low-01	N/A	2017/08/11
12	Coax cable (9KHz~40GHz)	TCT	RE-high-02	N/A	2017/08/11
13	Coax cable (9KHz~40GHz)	TCT	RE-low-02	N/A	2017/08/11
14	Coax cable (9KHz~40GHz)	TCT	RE-high-04	N/A	2017/08/11
15	Spectrum Analyzer	R&S	FSU	200054	2017/08/11
16	Antenna Connector	TCT	RFC-01	N/A	2017/08/12
17	RF cable(9KHz~40GHz)	TCT	RE-06	N/A	2017/08/12

Note:

The temporary antenna connector is soldered on the PCB board in order to perform conducted tests and this temporary antenna connector is listed in the equipment list.

6 Test results and Measurement Data

6.1 Antenna Requirement

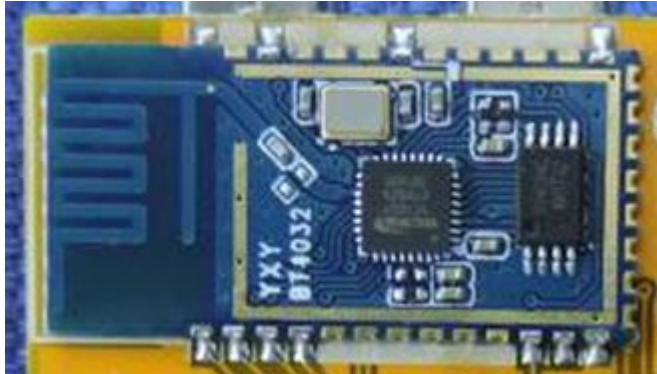
Standard requirement:	47 CFR Part 15C Section 15.203 /247(c)
<p>15.203 requirement: An intentional radiator shall be designed to ensure that no antenna other than that furnished by the responsible party shall be used with the device. The use of a permanently attached antenna or of an antenna that uses a unique coupling to the intentional radiator, the manufacturer may design the unit so that a broken antenna can be replaced by the user, but the use of a standard antenna jack or electrical connector is prohibited.</p> <p>15.247(b) (4) requirement: The conducted output power limit specified in paragraph (b) of this section is based on the use of antennas with directional gains that do not exceed 6 dBi. Except as shown in paragraph (c) of this section, if transmitting antennas of directional gain greater than 6 dBi are used, the conducted output power from the intentional radiator shall be reduced below the stated values in paragraphs (b)(1), (b)(2), and (b)(3) of this section, as appropriate, by the amount in dB that the directional gain of the antenna exceeds 6 dBi.</p>	
EUT Antenna:	
<p>The antenna is integrated on the main PCB and no consideration of replacement. The best case gain of the antenna is 0dBi.</p>	

6.2 Conducted Emissions

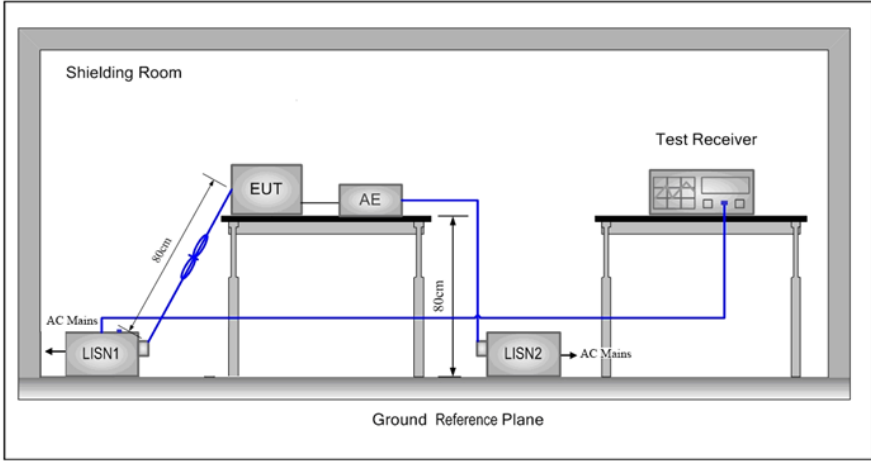
Test Requirement:	47 CFR Part 15C Section 15.207														
Test Method:	ANSI C63.10: 2013														
Test Frequency Range:	150kHz to 30MHz														
Limit:	<table border="1"> <thead> <tr> <th rowspan="2">Frequency range (MHz)</th> <th colspan="2">Limit (dBuV)</th> </tr> <tr> <th>Quasi-peak</th> <th>Average</th> </tr> </thead> <tbody> <tr> <td>0.15-0.5</td> <td>66 to 56*</td> <td>56 to 46*</td> </tr> <tr> <td>0.5-5</td> <td>56</td> <td>46</td> </tr> <tr> <td>5-30</td> <td>60</td> <td>50</td> </tr> </tbody> </table> <p>* Decreases with the logarithm of the frequency.</p>	Frequency range (MHz)	Limit (dBuV)		Quasi-peak	Average	0.15-0.5	66 to 56*	56 to 46*	0.5-5	56	46	5-30	60	50
Frequency range (MHz)	Limit (dBuV)														
	Quasi-peak	Average													
0.15-0.5	66 to 56*	56 to 46*													
0.5-5	56	46													
5-30	60	50													
Test Procedure:	<ol style="list-style-type: none"> 1) The mains terminal disturbance voltage test was conducted in a shielded room. 2) The EUT was connected to AC power source through a LISN 1 (Line Impedance Stabilization Network) which provides a $50\Omega/50\mu\text{H} + 5\Omega$ linear impedance. The power cables of all other units of the EUT were connected to a second LISN 2, which was bonded to the ground reference plane in the same way as the LISN 1 for the unit being measured. A multiple socket outlet strip was used to connect multiple power cables to a single LISN provided the rating of the LISN was not exceeded. 3) The tabletop EUT was placed upon a non-metallic table 0.8m above the ground reference plane. And for floor-standing arrangement, the EUT was placed on the horizontal ground reference plane. 4) The test was performed with a vertical ground reference plane. The rear of the EUT shall be 0.4 m from the vertical ground reference plane. The vertical ground reference plane was bonded to the horizontal ground reference plane. The LISN 1 was placed 0.8 m from the boundary of the unit under test and bonded to a ground reference plane for LISNs mounted on top of the ground reference plane. This distance was between the closest points of the LISN 1 and the EUT. All other units of the EUT and associated equipment was at least 0.8 m from the LISN 2. 5) In order to find the maximum emission, the relative positions of equipment and all of the interface cables must be changed according to ANSI C63.10: 2013 on conducted measurement. 														
Test Setup:															
Test Mode:	Transmitting with GFSK modulation. Charge +Transmitting mode.														
Final Test Mode:	Found the Charge + Transmitting mode (The highest channel:2480MHz) which it is worse case. Only the worst case is recorded in the report.														

Instruments Used:	Refer to section 5.10 for details.
Test Voltage:	AC 120V/60Hz
Test Results:	Pass

Measurement Data

An initial pre-scan was performed on the live and neutral lines with peak detector.

Quasi-Peak and Average measurement were performed at the frequencies with maximized peak emission were detected.

Live line:

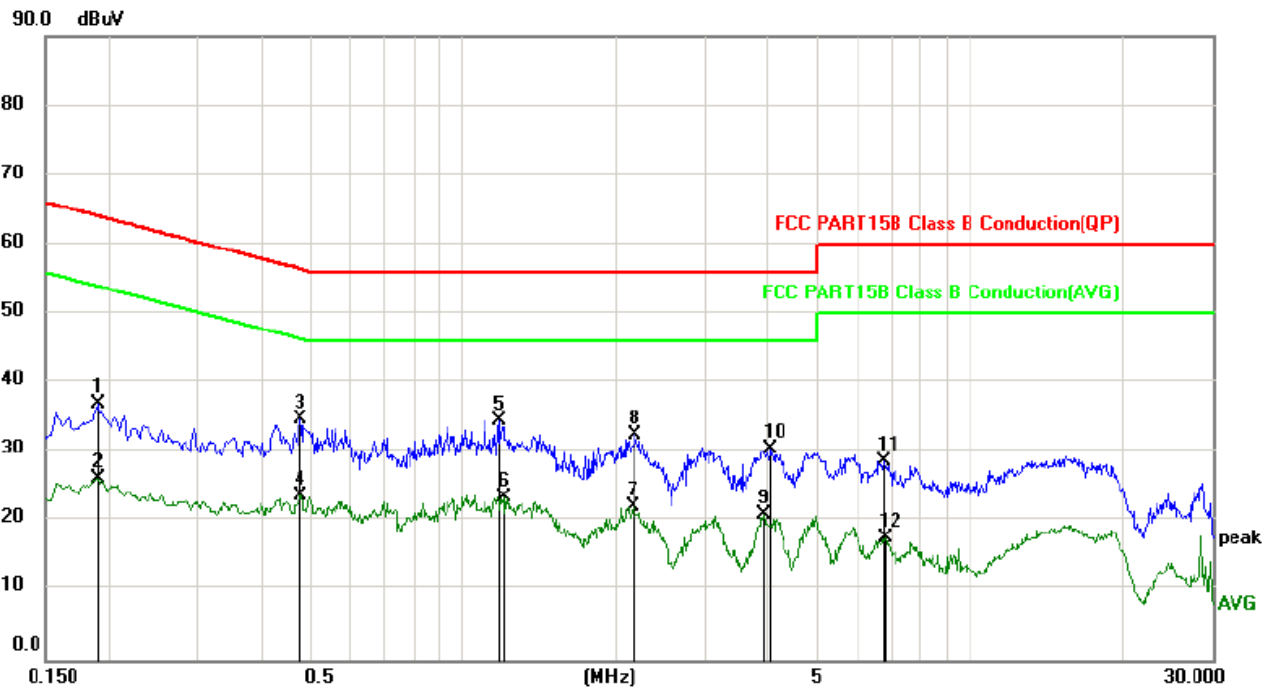

No.	Mk.	Freq. MHz	Reading Level dBuV	Correct Factor dB	Measure- ment dBuV	Limit dBuV	Over dB	Detector
1		0.1900	27.18	9.74	36.92	64.04	-27.12	peak
2		0.1900	16.51	9.74	26.25	54.04	-27.79	AVG
3		0.4779	24.98	9.74	34.72	56.38	-21.66	peak
4		0.4779	14.03	9.74	23.77	46.38	-22.61	AVG
5	*	1.1739	24.84	9.75	34.59	56.00	-21.41	peak
6		1.2019	13.66	9.75	23.41	46.00	-22.59	AVG
7		2.1579	12.50	9.76	22.26	46.00	-23.74	AVG
8		2.1819	22.72	9.76	32.48	56.00	-23.52	peak
9		3.9180	11.24	9.78	21.02	46.00	-24.98	AVG
10		4.0300	20.68	9.78	30.46	56.00	-25.54	peak
11		6.7579	18.90	9.80	28.70	60.00	-31.30	peak
12		6.7819	7.78	9.80	17.58	50.00	-32.42	AVG

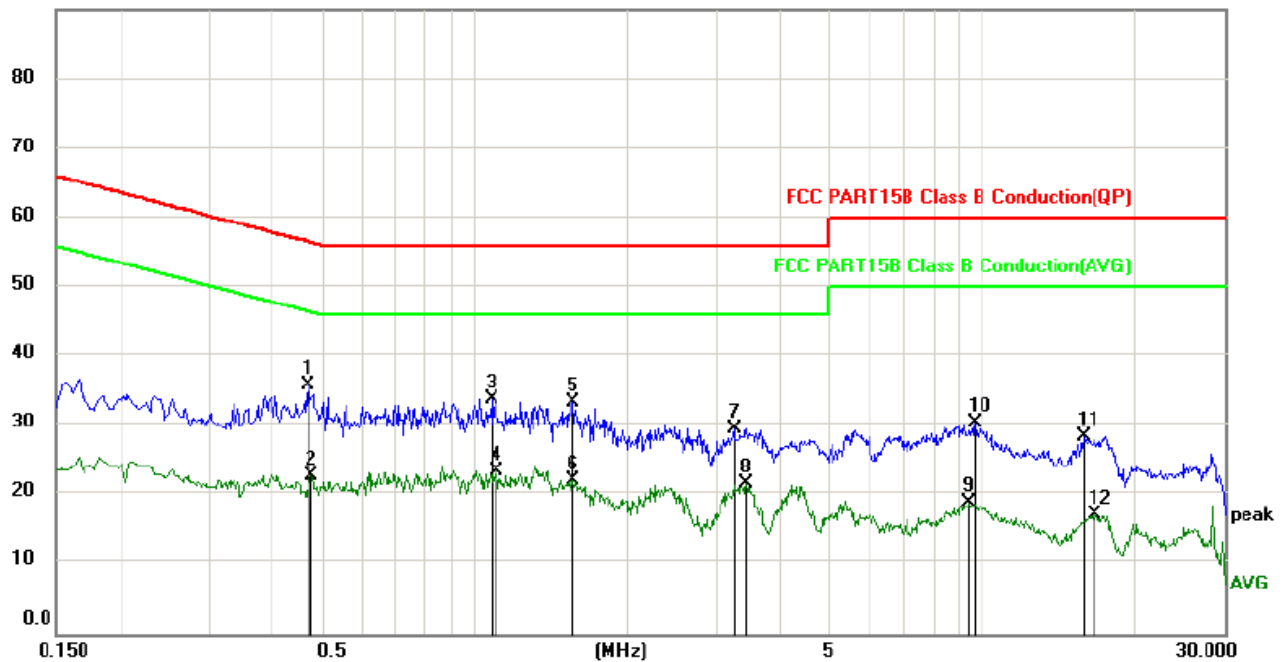
Neutral line:
 90.0 dBuV

No.	Mk.	Freq. MHz	Reading Level dBuV	Correct Factor dB	Measure- ment dBuV	Limit dBuV	Over dB	Detector
1	*	0.4700	26.02	9.80	35.82	56.51	-20.69	peak
2		0.4778	13.00	9.80	22.80	46.38	-23.58	AVG
3		1.0820	23.97	9.82	33.79	56.00	-22.21	peak
4		1.1100	13.66	9.82	23.48	46.00	-22.52	AVG
5		1.5660	23.49	9.85	33.34	56.00	-22.66	peak
6		1.5660	12.31	9.85	22.16	46.00	-23.84	AVG
7		3.2418	19.82	9.84	29.66	56.00	-26.34	peak
8		3.4300	11.78	9.83	21.61	46.00	-24.39	AVG
9		9.4219	9.18	9.87	19.05	50.00	-30.95	AVG
10		9.7018	20.57	9.88	30.45	60.00	-29.55	peak
11		15.8018	18.68	9.88	28.56	60.00	-31.44	peak
12		16.7337	7.26	9.88	17.14	50.00	-32.86	AVG

Notes:

1. The following Quasi-Peak and Average measurements were performed on the EUT:
2. Final Test Level = Receiver Reading + LISN Factor + Cable Loss.

6.3 Conducted Peak Output Power

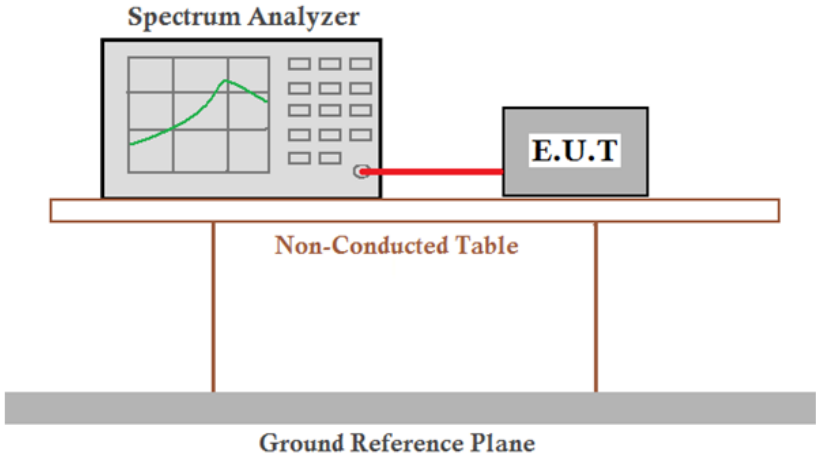
Test Requirement:	47 CFR Part 15C Section 15.247 (b)(1)
Test Method:	ANSI C63.10 2013
Test Setup:	 <p><i>Remark:</i> Offset the High-Frequency cable loss 1.5dB in the spectrum analyzer.</p>
Limit:	30dBm
Test Mode:	Transmitting with GFSK modulation.
Instruments Used:	Refer to section 5.10 for details.
Test Results:	Pass

Measurement Data

GFSK mode			
Test channel	Peak Output Power (dBm)	Limit (dBm)	Result
Lowest	0.27	30.00	Pass
Middle	0.81	30.00	Pass
Highest	1.09	30.00	Pass

Test plot as follows:

Test mode:	GFSK	Test channel:	Lowest
------------	------	---------------	--------

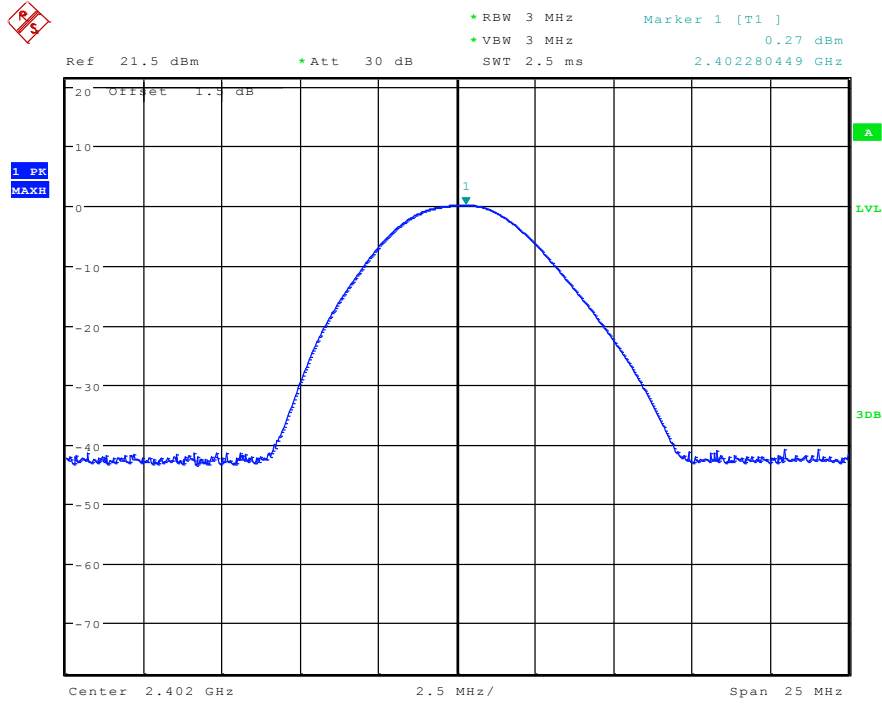

Test mode:	GFSK	Test channel:	Middle
------------	------	---------------	--------

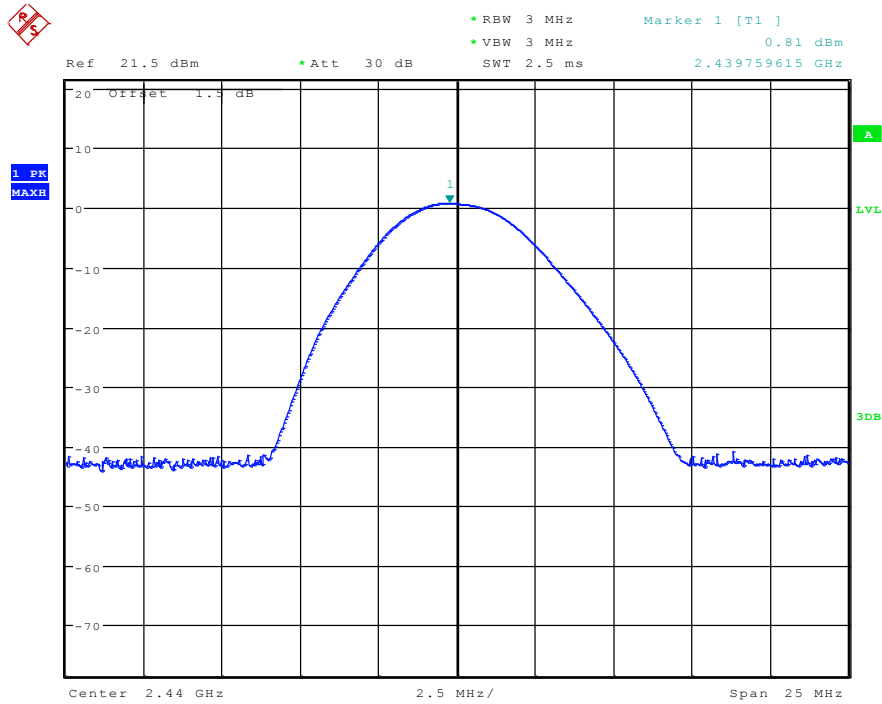

Test mode:	GFSK	Test channel:	Highest
------------	------	---------------	---------



* RBW 3 MHz
 * VBW 3 MHz
 * Att 30 dB
 SWT 2.5 ms
 Marker 1 [T1]
 1.09 dBm
 2.479679487 GHz

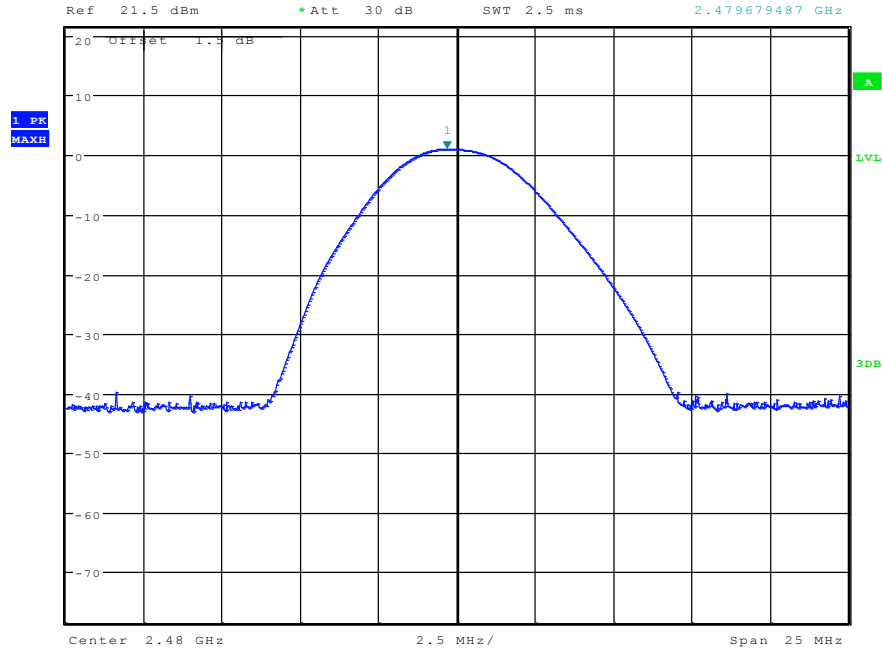

6.4 6dB Occupy Bandwidth

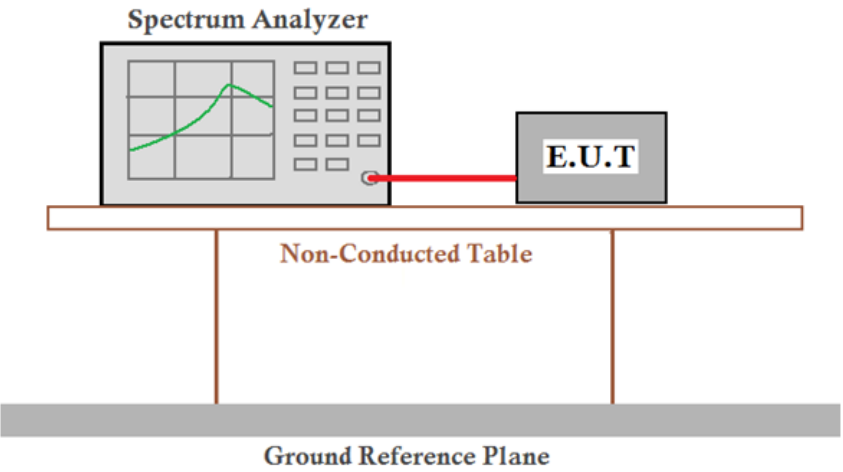
Test Requirement:	47 CFR Part 15C Section 15.247 (a)(2)
Test Method:	ANSI C63.10 2013
Test Setup:	 <p>The diagram shows a Spectrum Analyzer on the left and an E.U.T. on the right, connected by a red cable. They are both on a table labeled 'Non-Conducted Table'. Below the table is a 'Ground Reference Plane'.</p>
Limit:	≥ 500 kHz
Test Mode:	Transmitting with GFSK modulation.
Instruments Used:	Refer to section 5.10 for details.
Test Results:	Pass

Measurement Data

GFSK mode			
Test channel	6dB Occupy Bandwidth (MHz)	Limit (kHz)	Result
Lowest	0.697	≥ 500	Pass
Middle	0.687	≥ 500	Pass
Highest	0.702	≥ 500	Pass

Test plot as follows:

Test mode:	GFSK	Test channel:	Lowest
------------	------	---------------	--------

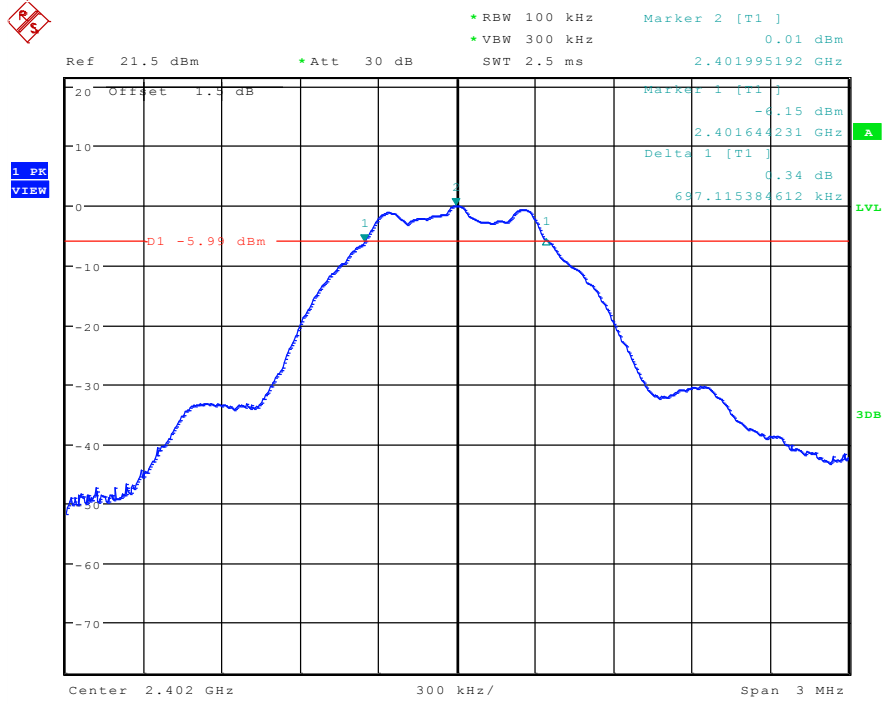

Test mode:	GFSK	Test channel:	Middle
------------	------	---------------	--------

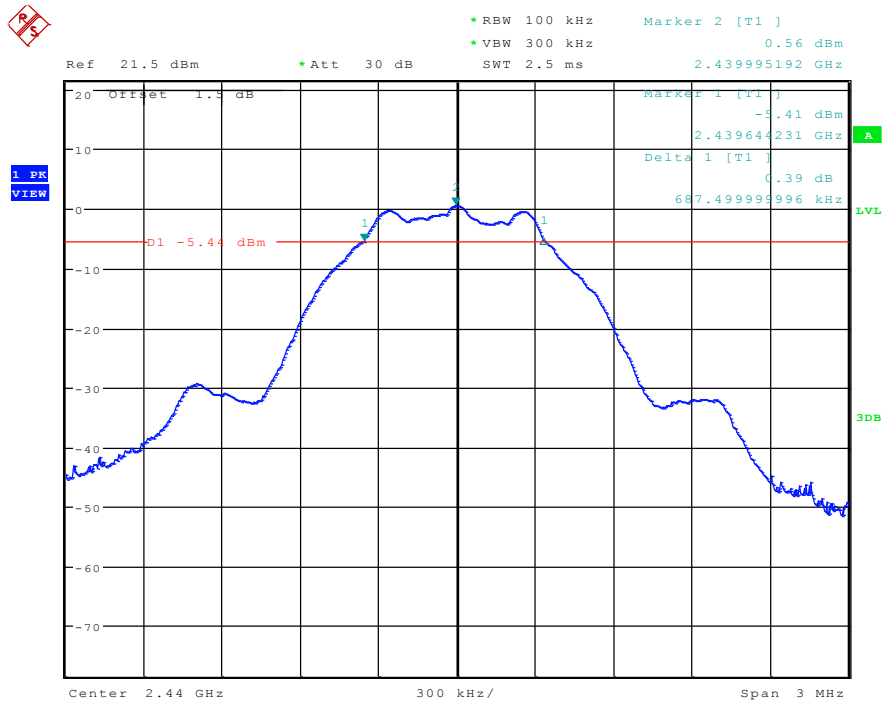

Test mode:	GFSK	Test channel:	Highest
------------	------	---------------	---------

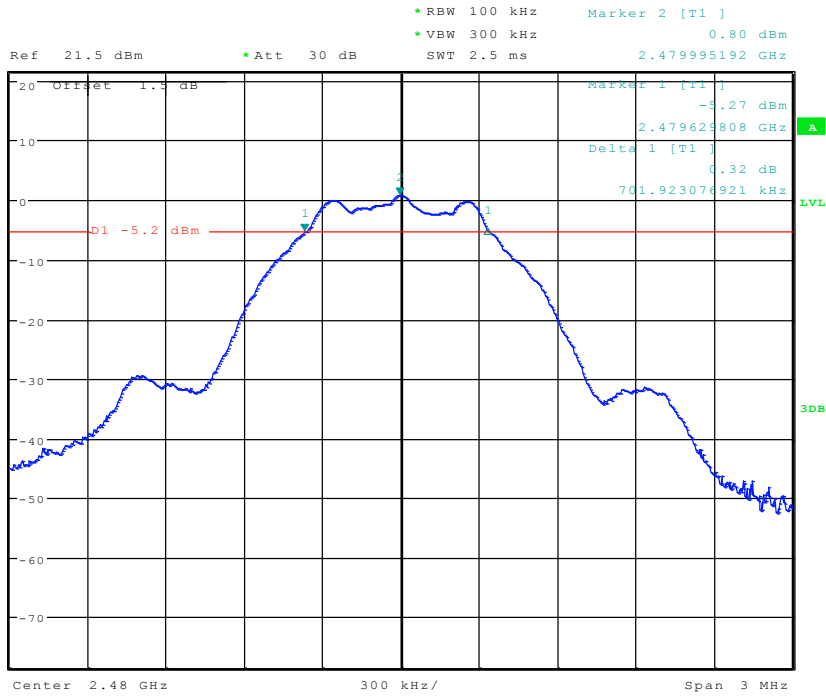

6.5 Power Spectral Density

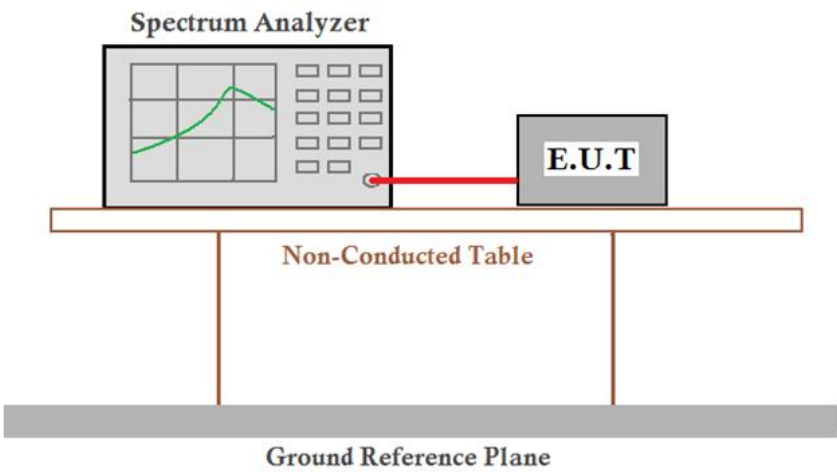
Test Requirement:	47 CFR Part 15C Section 15.247 (e)
Test Method:	ANSI C63.10 2013
Test Setup:	 <p>The diagram shows a Spectrum Analyzer on the left and an E.U.T. on the right, connected by a red cable. They are both on a table labeled 'Non-Conducted Table'. Below the table is a 'Ground Reference Plane'.</p>
Limit:	$\leq 8.00 \text{ dBm/3kHz}$
Test Mode:	Transmitting with GFSK modulation.
Instruments Used:	Refer to section 5.10 for details.
Test Results:	Pass

Measurement Data

GFSK mode			
Test channel	Power Spectral Density (dBm/3kHz)	Limit (dBm/3kHz)	Result
Lowest	-15.65	≤ 8.00	Pass
Middle	-15.02	≤ 8.00	Pass
Highest	-14.72	≤ 8.00	Pass

Test plot as follows:

Test mode:	GFSK	Test channel:	Lowest
------------	------	---------------	--------

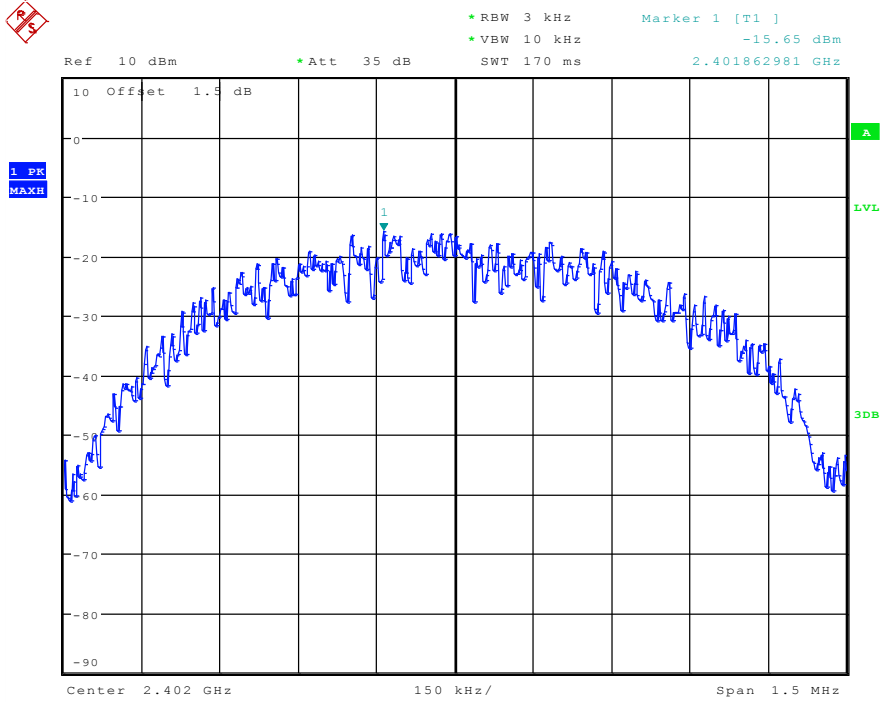

Test mode:	GFSK	Test channel:	Middle
------------	------	---------------	--------

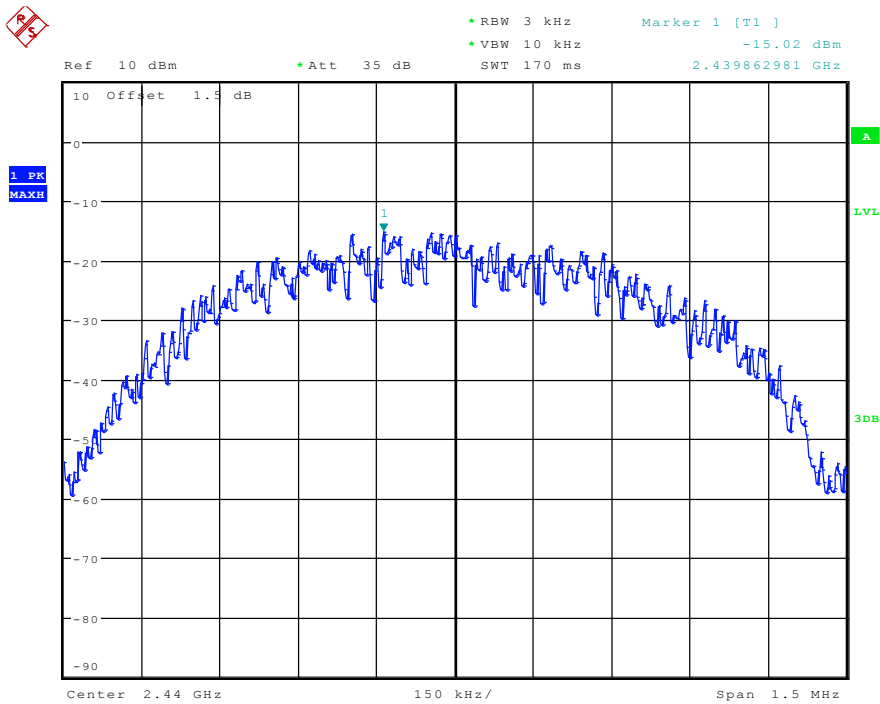

6.6 Band-edge for RF Conducted Emissions

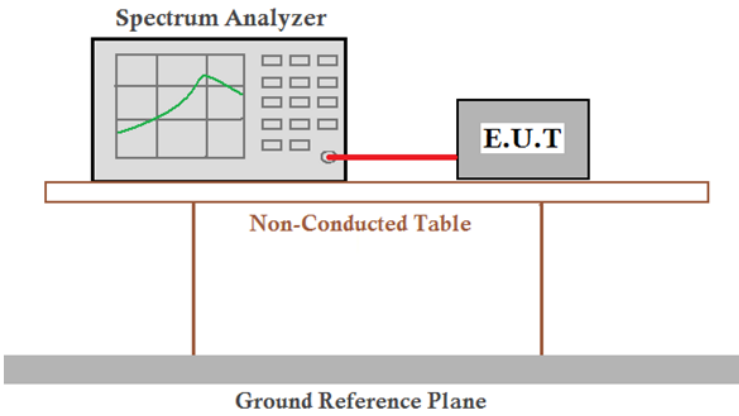
Test Requirement:	47 CFR Part 15C Section 15.247 (d)
Test Method:	ANSI C63.10 2013
Test Setup:	 <p>Remark: Offset the High-Frequency cable loss 1.5dB in the spectrum analyzer.</p>
Limit:	In any 100 kHz bandwidth outside the frequency band in which the spread spectrum intentional radiator is operating, the radio frequency power that is produced by the intentional radiator shall be at least 20 dB below that in the 100 kHz bandwidth within the band that contains the highest level of the desired power, based on either an RF conducted or a radiated measurement.
Test Mode:	Transmitting with GFSK modulation.
Instruments Used:	Refer to section 5.10 for details.
Test Results:	Pass

GFSK mode				
Test channel	Frequency(MHz)	Emission Level(dBm)	Limit(dBm)	Result
Lowest	2400	-50.86	-19.96	Pass
Highest	2483.5	-53.33	-19.21	Pass

Test plot as follows:

Test mode:	GFSK	Test channel:	Lowest
------------	------	---------------	--------

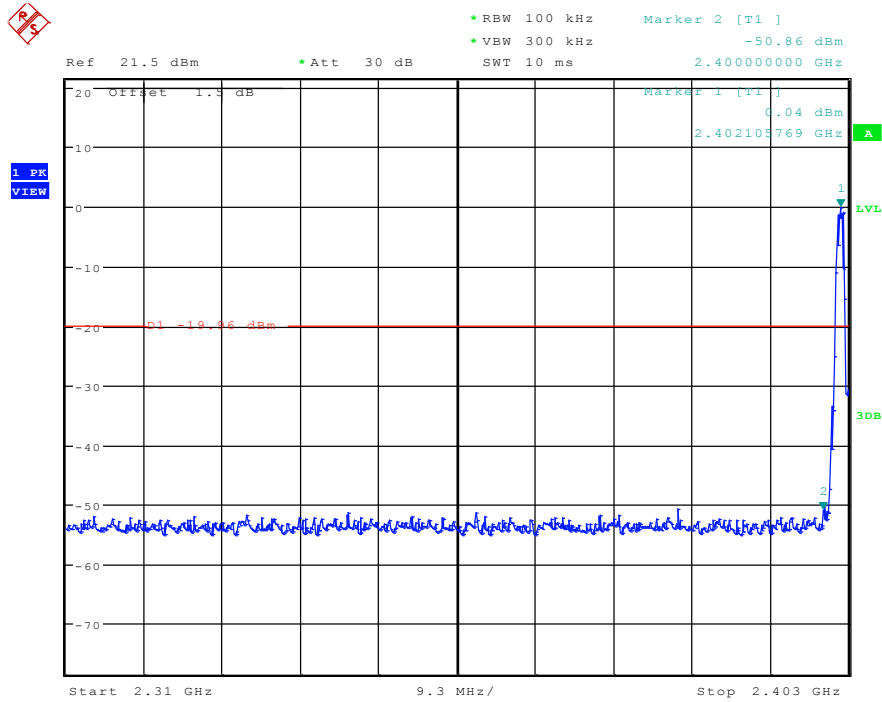

Test mode:	GFSK	Test channel:	Highest
------------	------	---------------	---------

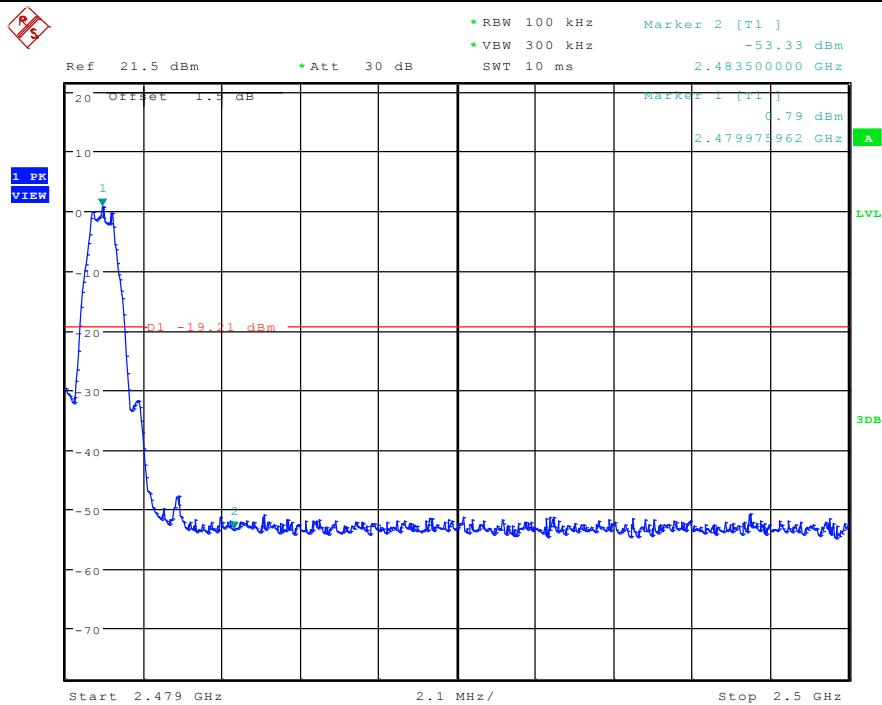

6.7 Spurious RF Conducted Emissions

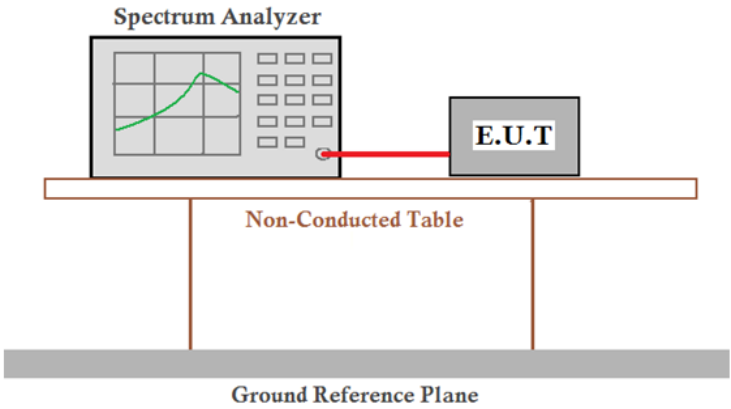
Test Requirement:	47 CFR Part 15C Section 15.247 (d)
Test Method:	ANSI C63.10 2013
Test Setup:	 <p>Remark: Offset the High-Frequency cable loss 1.5dB in the spectrum analyzer.</p>
Limit:	In any 100 kHz bandwidth outside the frequency band in which the spread spectrum intentional radiator is operating, the radio frequency power that is produced by the intentional radiator shall be at least 20 dB below that in the 100 kHz bandwidth within the band that contains the highest level of the desired power, based on either an RF conducted or a radiated measurement.
Test Mode:	Transmitting with GFSK modulation.
Instruments Used:	Refer to section 5.10 for details.
Test Results:	Pass

Test plot as follows:

Test mode:	GFSK	Test channel:	Lowest
------------	------	---------------	--------

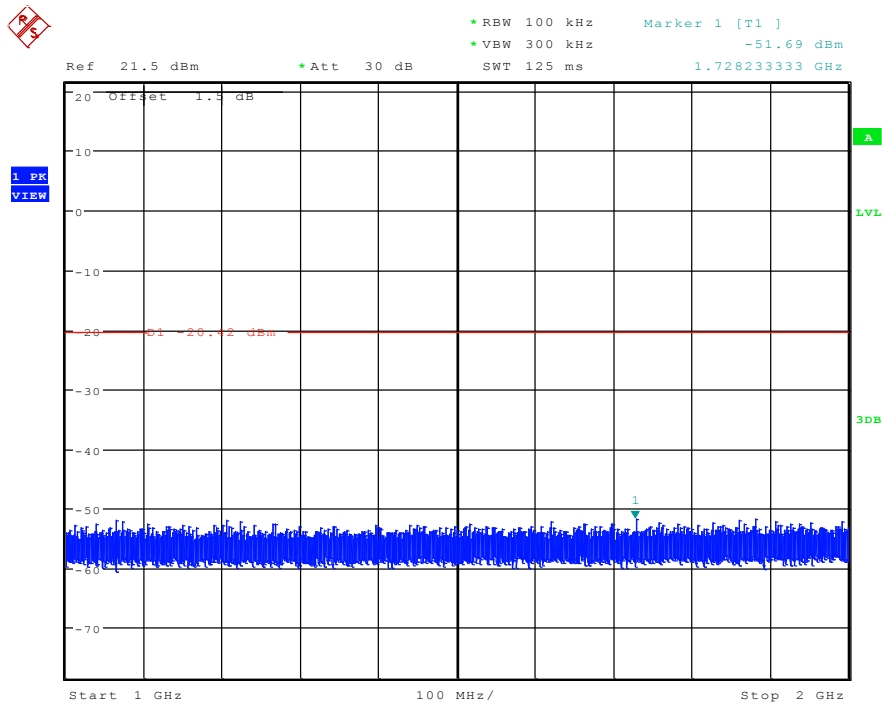
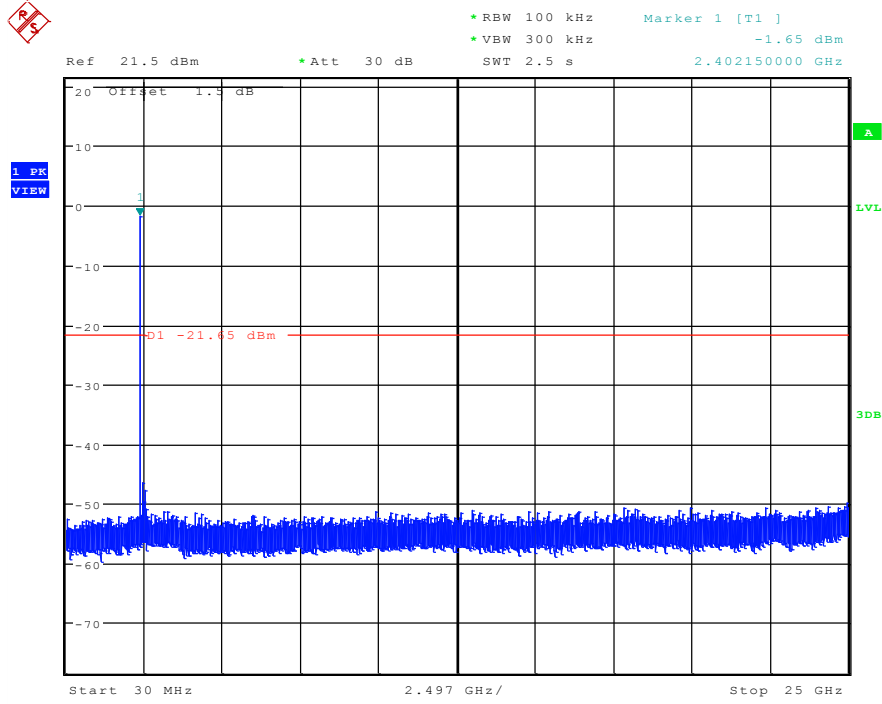

Test mode:	GFSK	Test channel:	Middle
------------	------	---------------	--------

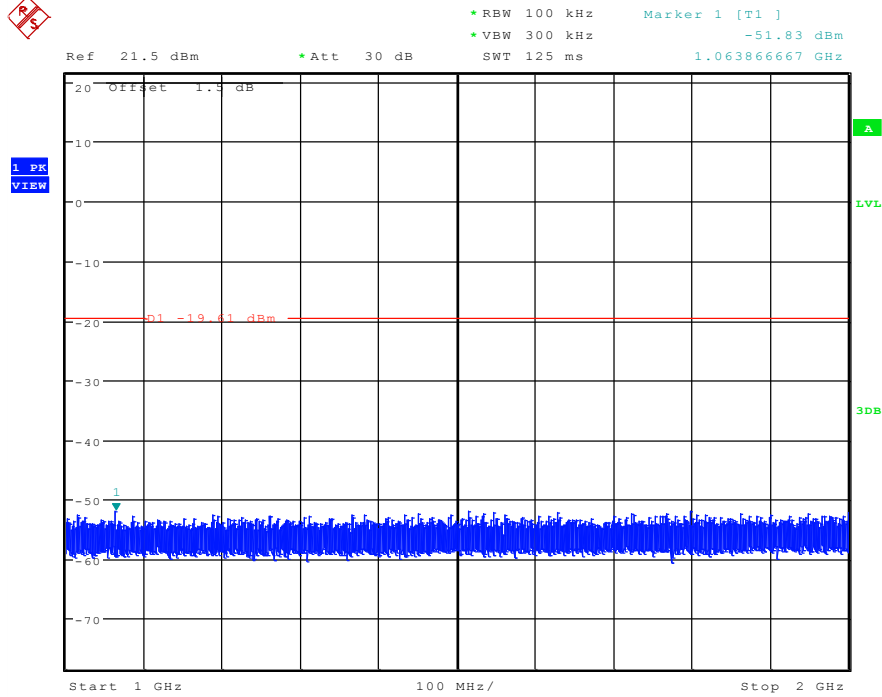
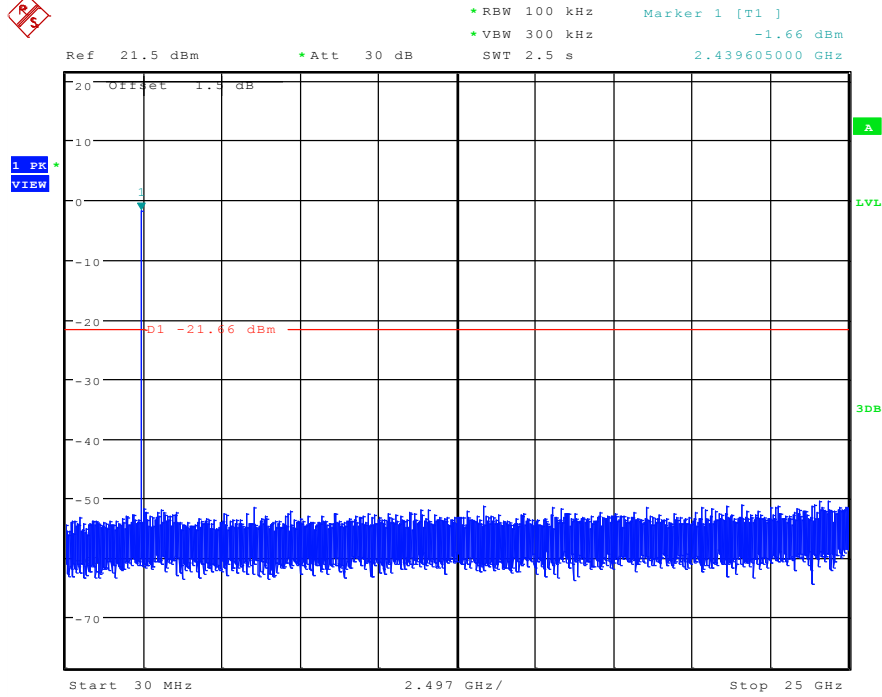



Ref 21.5 dBm *Att 30 dB *RBW 100 kHz Marker 1 [T1] 0.39 dBm
*VBW 300 kHz 2.439966667 GHz
SWT 125 ms

1 PK
VIEW

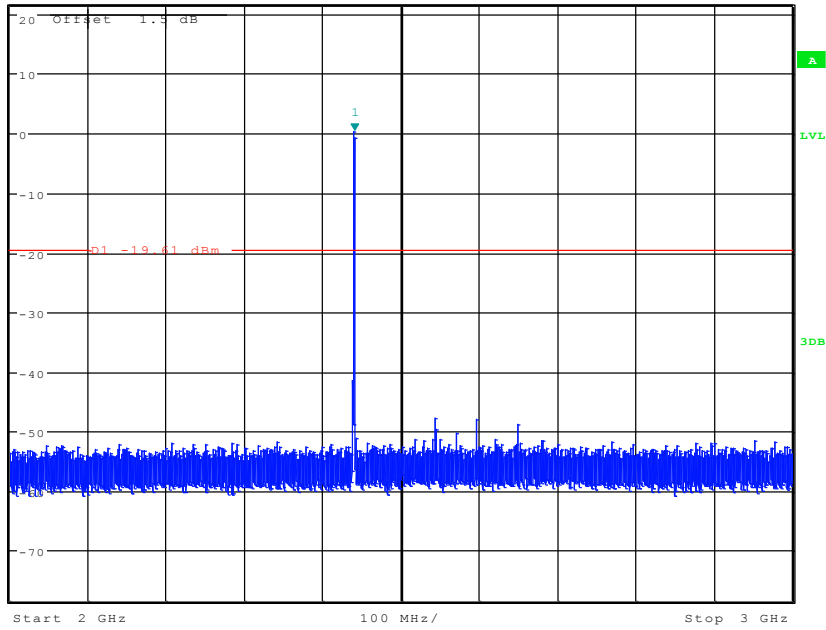

Ref 21.5 dBm *Att 30 dB *RBW 100 kHz Marker 1 [T1] -50.77 dBm
*VBW 300 kHz 4.592033333 GHz
SWT 125 ms

1 PK
VIEW

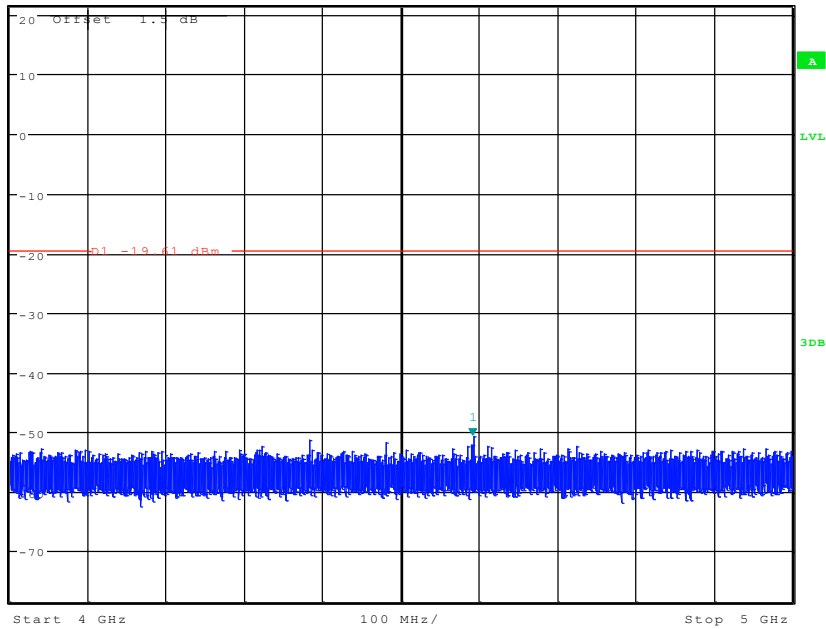

Test mode:	GFSK	Test channel:	Highest
------------	------	---------------	---------

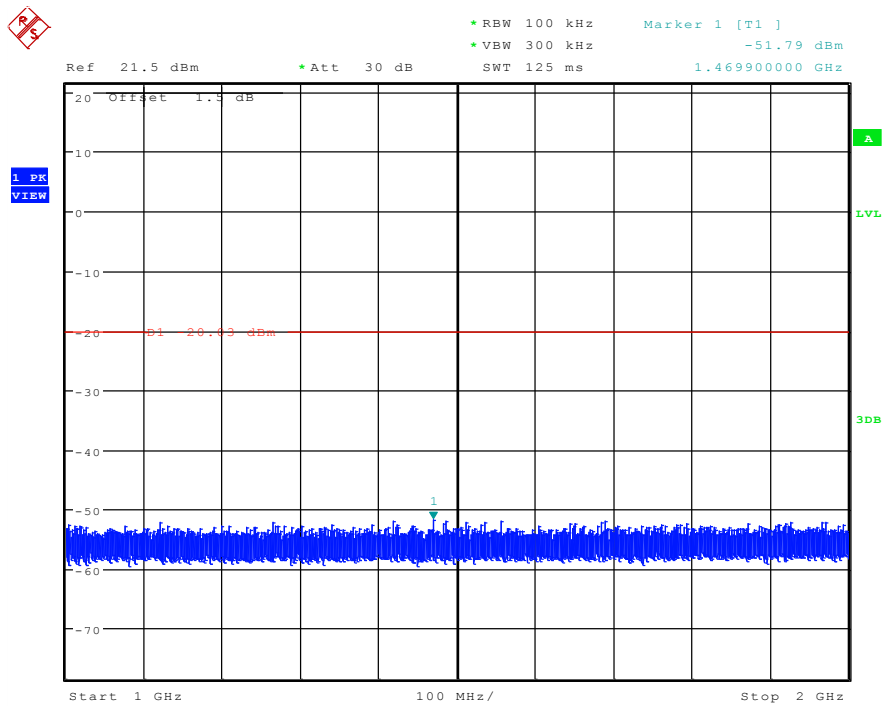
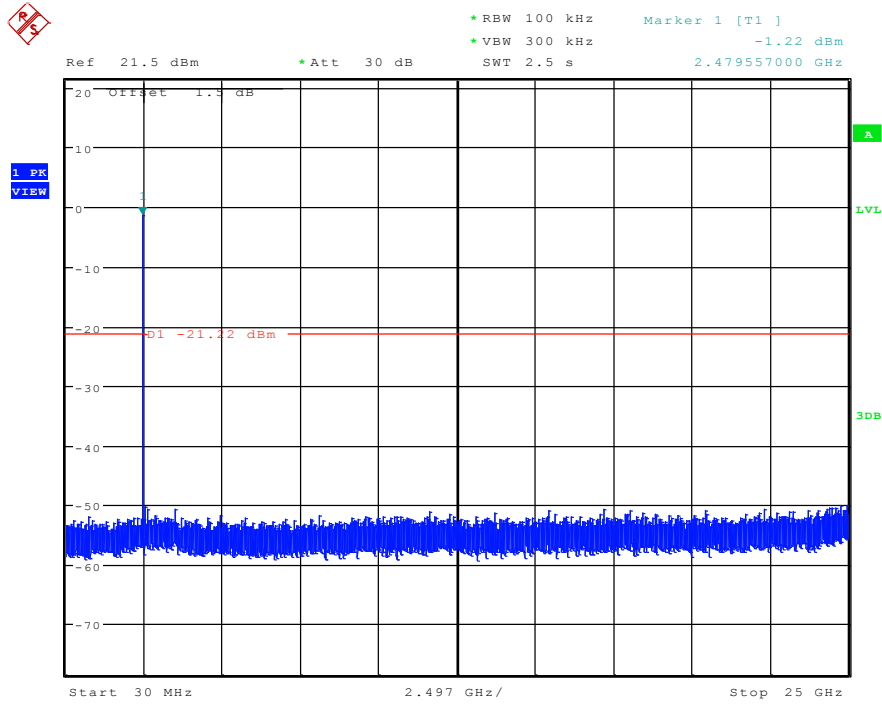

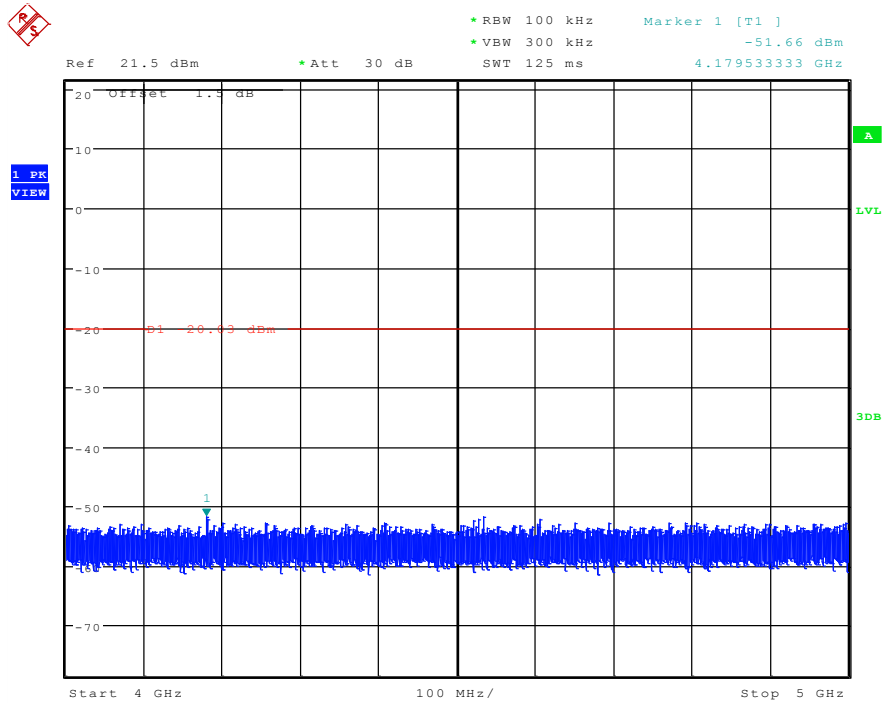
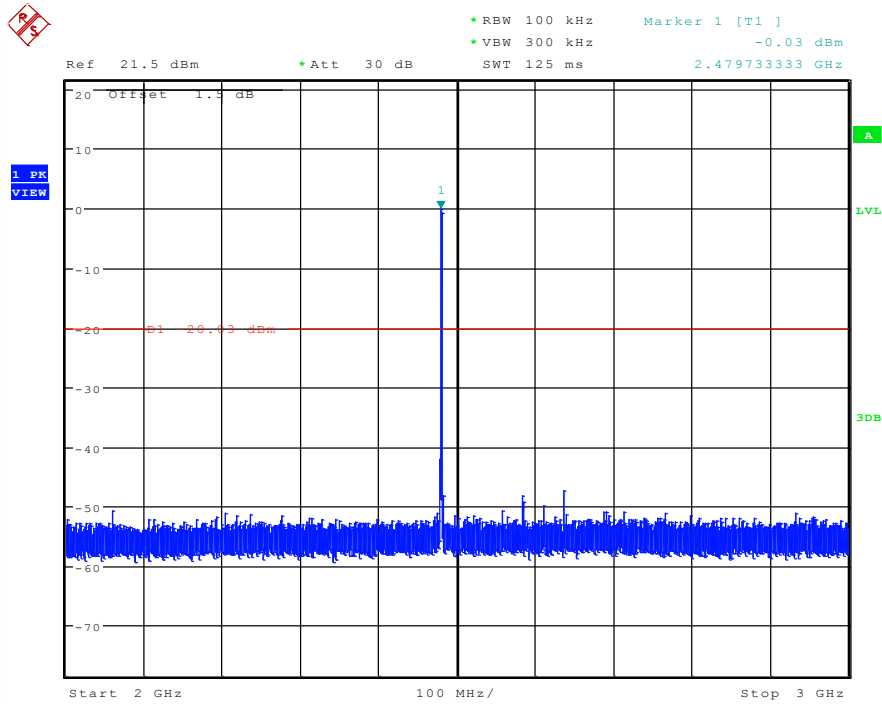

Remark:

Pretest 9kHz to 25GHz, find the highest point when testing, so only the worst data were shown in the test report. Per FCC Part 15.33 (a) and 15.31 (o) ,The amplitude of spurious emissions from intentional radiators which are attenuated more than 20 dB below the permissible value need not be reported unless specifically required elsewhere in this part.

6.8 Radiated Spurious Emission

6.8.1 Spurious Emissions

Test Requirement:	47 CFR Part 15C Section 15.209 and 15.205				
Test Method:	ANSI C63.10 2013				
Test Site:	Measurement Distance: 3m (Semi-Anechoic Chamber)				
Receiver Setup:	Frequency	Detector	RBW	VBW	Remark
	0.009MHz-0.090MHz	Peak	10kHz	30kHz	Peak
	0.009MHz-0.090MHz	Average	10kHz	30kHz	Average
	0.090MHz-0.110MHz	Quasi-peak	10kHz	30kHz	Quasi-peak
	0.110MHz-0.490MHz	Peak	10kHz	30kHz	Peak
	0.110MHz-0.490MHz	Average	10kHz	30kHz	Average
	0.490MHz -30MHz	Quasi-peak	10kHz	30kHz	Quasi-peak
	30MHz-1GHz	Quasi-peak	100 kHz	300kHz	Quasi-peak
	Above 1GHz	Peak	1MHz	3MHz	Peak
		Peak	1MHz	10Hz	Average
Limit:	Frequency	Field strength (microvolt/meter)	Limit (dBuV/m)	Remark	Measurement distance (m)
	0.009MHz-0.490MHz	2400/F(kHz)	-	-	300
	0.490MHz-1.705MHz	24000/F(kHz)	-	-	30
	1.705MHz-30MHz	30	-	-	30
	30MHz-88MHz	100	40.0	Quasi-peak	3
	88MHz-216MHz	150	43.5	Quasi-peak	3
	216MHz-960MHz	200	46.0	Quasi-peak	3
	960MHz-1GHz	500	54.0	Quasi-peak	3
	Above 1GHz	500	54.0	Average	3
Note: 15.35(b), Unless otherwise specified, the limit on peak radio frequency emissions is 20dB above the maximum permitted average emission limit applicable to the equipment under test. This peak limit applies to the total peak emission level radiated by the device.					

Test Setup:

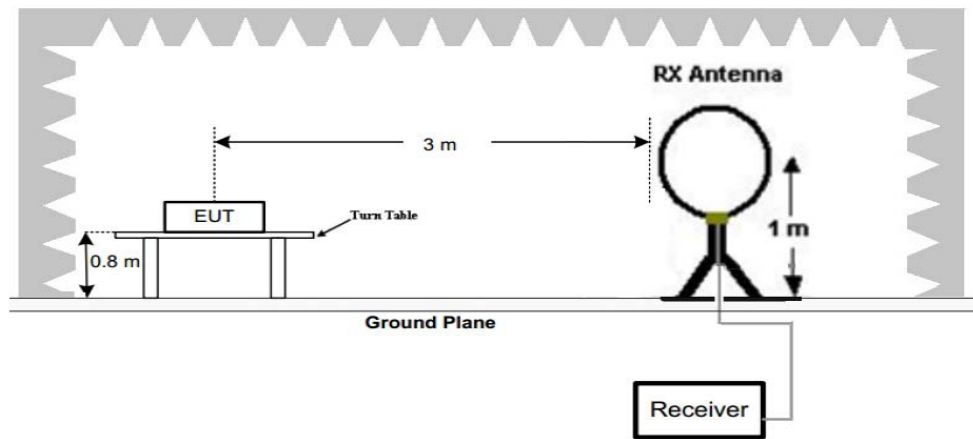

Figure 1. Below 30MHz

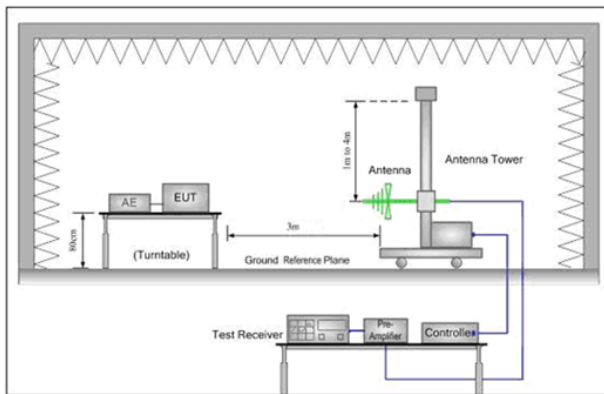

Figure 2. 30MHz to 1GHz

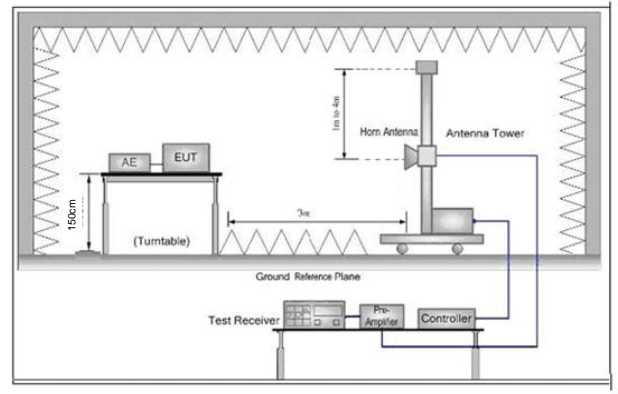

Figure 3. Above 1 GHz

Test Procedure:

- a. 1) Below 1G: The EUT was placed on the top of a rotating table 0.8 meters above the ground at a 3 meter semi-anechoic chamber. The table was rotated 360 degrees to determine the position of the highest radiation.
 - 2) Above 1G: The EUT was placed on the top of a rotating table 1.5 meters above the ground at a 3 meter semi-anechoic chamber. The table was rotated 360 degrees to determine the position of the highest radiation.
- Note: For the radiated emission test above 1GHz:
- Place the measurement antenna away from each area of the EUT determined to be a source of emissions at the specified measurement distance, while keeping the measurement antenna aimed at the source of emissions at each frequency of significant emissions, with polarization oriented for maximum response. The measurement antenna may have to be higher or lower than the EUT, depending on the radiation pattern of the emission and staying aimed at the emission source for receiving the maximum signal. The final measurement antenna elevation shall be that which maximizes the emissions. The measurement antenna elevation for maximum emissions shall be restricted to a range of heights of from 1 m to 4 m above the ground or reference ground plane.
- b. The EUT was set 3 meters away from the interference-receiving antenna, which was mounted on the top of a variable-height antenna tower.
 - c. The antenna height is varied from one meter to four meters above the ground to determine the maximum value of the field strength. Both horizontal and vertical polarizations of the antenna are set to make the measurement.
 - d. For each suspected emission, the EUT was arranged to its worst case

	<p>and then the antenna was tuned to heights from 1 meter to 4 meters (for the test frequency of below 30MHz, the antenna was tuned to heights 1 meter) and the rotatable table was turned from 0 degrees to 360 degrees to find the maximum reading.</p> <p>e. The test-receiver system was set to Peak Detect Function and Specified Bandwidth with Maximum Hold Mode.</p> <p>f. If the emission level of the EUT in peak mode was 10dB lower than the limit specified, then testing could be stopped and the peak values of the EUT would be reported. Otherwise the emissions that did not have 10dB margin would be re-tested one by one using peak, quasi-peak or average method as specified and then reported in a data sheet.</p> <p>g. Test the EUT in the lowest channel (2402MHz),the middle channel (2440MHz),the Highest channel (2480MHz)</p> <p>h. The radiation measurements are performed in X, Y, Z axis positioning for Transmitting mode, and found the X axis positioning which it is the worst case.</p> <p>i. Repeat above procedures until all frequencies measured was complete.</p>
Exploratory Test Mode:	Transmitting with GFSK modulation. Transmitting mode.
Final Test Mode:	Transmitting with GFSK modulation. Pretest the EUT at Transmitting mode, found the Transmitting mode which it is worse case. For below 1GHz part, through pre-scan, the worst case is the lowest channel. Only the worst case is recorded in the report.
Instruments Used:	Refer to section 5.10 for details.
Test Results:	Pass

Radiated Emission below 1GHz		
30MHz~1GHz		
Test mode:	Transmitting mode	Vertical

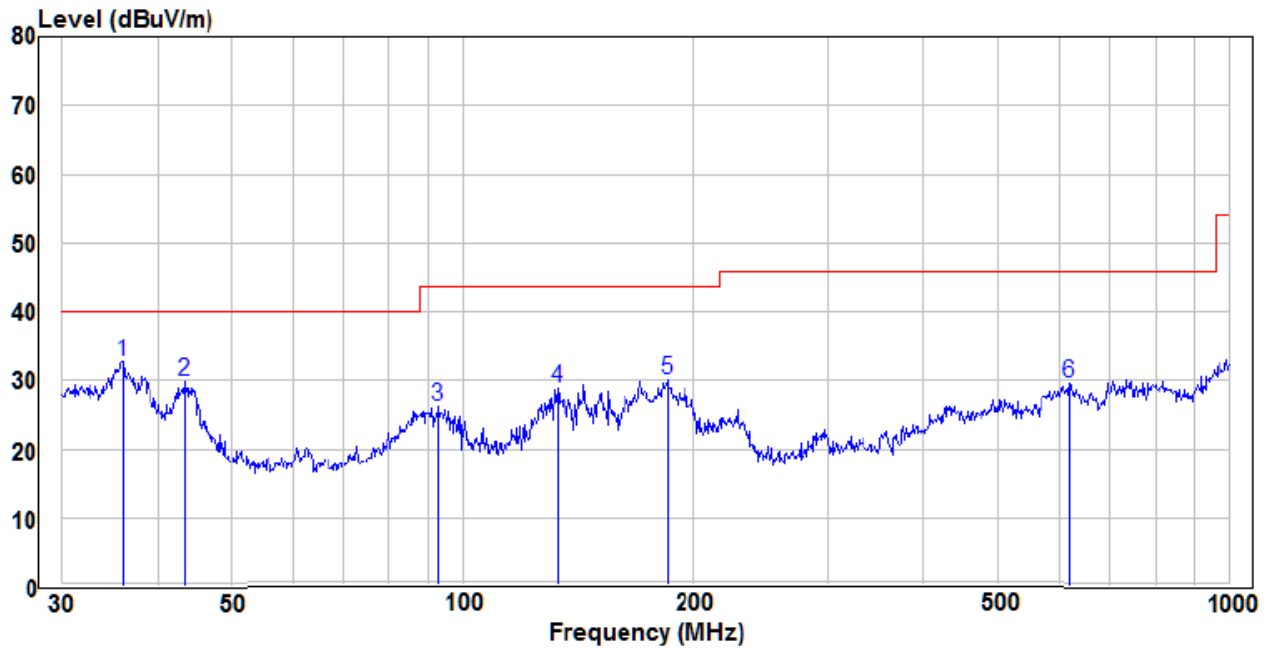

	Read Freq	Read Level	Factor	Level	Limit Line	Over Limit	Remark	Pol/Phase
	MHz	dBuV	dB/m	dBuV/m	dBuV/m	dB		
1 pp	36.00	14.79	17.80	32.59	40.00	-7.41	Peak	VERTICAL
2	43.35	16.88	12.92	29.80	40.00	-10.20	Peak	VERTICAL
3	92.79	15.98	10.24	26.22	43.50	-17.28	Peak	VERTICAL
4	132.69	19.17	9.65	28.82	43.50	-14.68	Peak	VERTICAL
5	184.49	21.69	8.23	29.92	43.50	-13.58	Peak	VERTICAL
6	618.54	10.90	18.65	29.55	46.00	-16.45	Peak	VERTICAL

Test mode:	Transmitting mode	Horizontal
------------	-------------------	------------

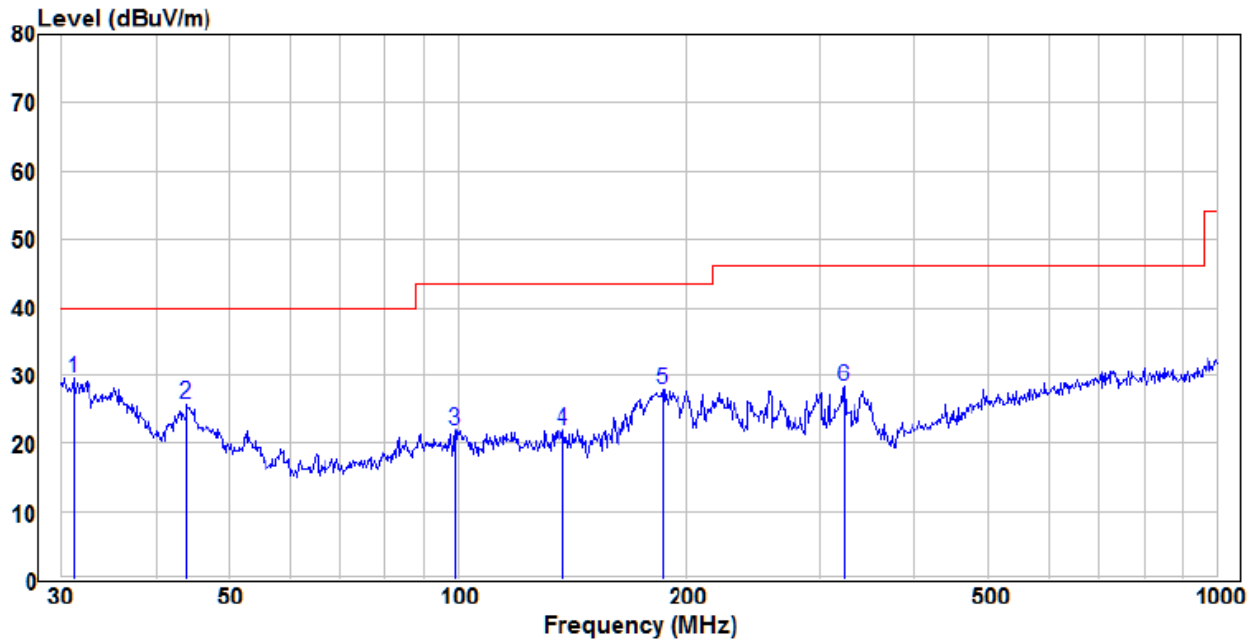

	Read Freq	Read Level	Read Factor	Limit Level	Limit Line	Over Limit	Remark	Pol/Phase
	MHz	dBuV	dB/m	dBuV/m	dBuV/m	dB		
1	pp	31.07	10.79	18.82	29.61	40.00	-10.39 Peak	HORIZONTAL
2		43.81	13.09	12.64	25.73	40.00	-14.27 Peak	HORIZONTAL
3		99.18	11.43	10.52	21.95	43.50	-21.55 Peak	HORIZONTAL
4		137.42	13.19	8.80	21.99	43.50	-21.51 Peak	HORIZONTAL
5		185.79	19.72	8.17	27.89	43.50	-15.61 Peak	HORIZONTAL
6		322.19	16.36	11.92	28.28	46.00	-17.72 Peak	HORIZONTAL

Transmitter Emission above 1GHz

Worse case mode:	GFSK	Test channel:	Lowest
------------------	------	---------------	--------

Frequency (MHz)	Meter Reading (dB μ V)	Factor (dB)	Emission Level (dB μ V/m)	Limits (dB μ V/m)	Over (dB)	Detector Type	Ant. Pol. H/V
4804	49.32	-5.18	44.14	74	-29.86	peak	H
4804	38.58	-5.18	33.40	54	-20.60	AVG	H
7206	48.61	-6.45	42.16	74	-31.84	peak	H
7206	35.97	-6.45	29.52	54	-24.48	AVG	H
4804	49.02	-5.18	43.84	74	-30.16	peak	V
4804	37.66	-5.18	32.48	54	-21.52	AVG	V
7206	48.72	-6.45	42.27	74	-31.73	peak	V
7206	35.21	-6.45	28.76	54	-25.24	AVG	V

Worse case mode:	GFSK	Test channel:	Middle
------------------	------	---------------	--------

Frequency (MHz)	Meter Reading (dB μ V)	Factor (dB)	Emission Level (dB μ V/m)	Limits (dB μ V/m)	Over (dB)	Detector Type	Ant. Pol. H/V
4880	49.79	-5.19	44.60	74	-29.40	peak	H
4880	36.28	-5.19	31.09	54	-22.91	AVG	H
7320	49.85	-6.47	43.38	74	-30.62	peak	H
7320	36.15	-6.47	29.68	54	-24.32	AVG	H
4880	49.33	-5.19	44.14	74	-29.86	peak	V
4880	37.32	-5.19	32.13	54	-21.87	AVG	V
7320	49.06	-6.47	42.59	74	-31.41	peak	V
7320	35.32	-6.47	28.85	54	-25.15	AVG	V

Worse case mode:	GFSK	Test channel:	Highest
------------------	------	---------------	---------

Frequency (MHz)	Meter Reading (dB μ V)	Factor (dB)	Emission Level (dB μ V/m)	Limits (dB μ V/m)	Over (dB)	Detector Type	Ant. Pol. H/V
4960	49.33	-5.2	44.13	74	-29.87	peak	H
4960	37.28	-5.2	32.08	54	-21.92	AVG	H
7440	49.48	-6.47	43.01	74	-30.99	peak	H
7440	37.15	-6.47	30.68	54	-23.32	AVG	H
4960	49.77	-5.2	44.57	74	-29.43	peak	V
4960	38.49	-5.2	33.29	54	-20.71	AVG	V
7440	49.53	-6.47	43.06	74	-30.94	peak	V
7440	37.28	-6.47	30.81	54	-23.19	AVG	V

Remark:

- 1) The field strength is calculated by adding the Antenna Factor, Cable Factor & Preamplifier. The basic equation with a sample calculation is as follows:
 Final Test Level = Receiver Reading + Antenna Factor + Cable Factor – Preamplifier Factor
- 2) Scan from 9kHz to 25GHz, the disturbance above 13GHz and below 30MHz was very low, and the above harmonics were the highest point could be found when testing, so only the above harmonics had been displayed. The amplitude of spurious emissions from the radiator which are attenuated more than 20dB below the limit need not be reported.

6.9 Restricted bands around fundamental frequency

Test Requirement:	47 CFR Part 15C Section 15.209 and 15.205		
Test Method:	ANSI C63.10 2013		
Test Site:	Measurement Distance: 3m (Semi-Anechoic Chamber)		
Limit:	Frequency	Limit (dBuV/m @3m)	Remark
	30MHz-88MHz	40.0	Quasi-peak Value
	88MHz-216MHz	43.5	Quasi-peak Value
	216MHz-960MHz	46.0	Quasi-peak Value
	Above 1GHz	54.0	Average Value
		74.0	Peak Value
Test Setup:			

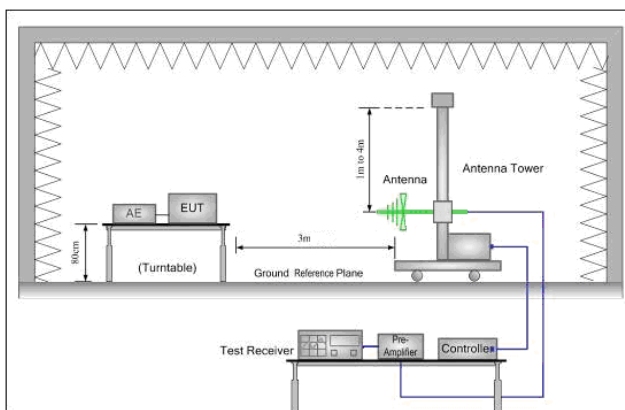

Figure 1. 30MHz to 1GHz

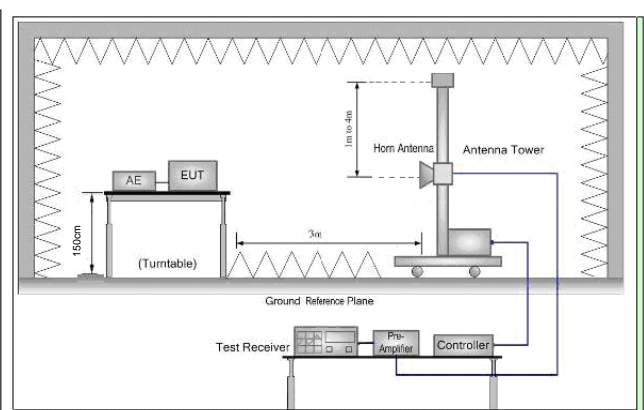

Figure 2. Above 1 GHz

Test Procedure:

- a.
 - 1) Below 1G: The EUT was placed on the top of a rotating table 0.8 meters above the ground at a 3 meter semi-anechoic chamber. The table was rotated 360 degrees to determine the position of the highest radiation.
 - 2) Above 1G: The EUT was placed on the top of a rotating table 1.5 meters above the ground at a 3 meter semi-anechoic chamber. The table was rotated 360 degrees to determine the position of the highest radiation.

Note: For the radiated emission test above 1GHz:
Place the measurement antenna away from each area of the EUT determined to be a source of emissions at the specified measurement distance, while keeping the measurement antenna aimed at the source of emissions at each frequency of significant emissions, with polarization oriented for maximum response. The measurement antenna may have to be higher or lower than the EUT, depending on the radiation pattern of the emission and staying aimed at the emission source for receiving the maximum signal. The final measurement antenna elevation shall be that which maximizes the emissions. The measurement antenna elevation for maximum emissions shall be restricted to a range of heights of from 1 m to 4 m above the ground or reference ground plane. The EUT was set 3 meters away from the interference-receiving antenna, which was mounted on the top of a variable-height antenna tower.
- b. The antenna height is varied from one meter to four meters above the ground to determine the maximum value of the field strength. Both horizontal and vertical polarizations of the antenna are set to make the measurement.
- c. For each suspected emission, the EUT was arranged to its worst case

	<p>and then the antenna was tuned to heights from 1 meter to 4 meters and the rotatable table was turned from 0 degrees to 360 degrees to find the maximum reading.</p> <ul style="list-style-type: none"> d. The test-receiver system was set to Peak Detect Function and Specified Bandwidth with Maximum Hold Mode. e. Place a marker at the end of the restricted band closest to the transmit frequency to show compliance. Also measure any emissions in the restricted bands. Save the spectrum analyzer plot. Repeat for each power and modulation for lowest and highest channel f. Test the EUT in the lowest channel , the Highest channel g. The radiation measurements are performed in X, Y, Z axis positioning for Transmitting mode, and found the X axis positioning which it is the worst case. h. Repeat above procedures until all frequencies measured was complete.
Exploratory Test Mode:	<p>Transmitting with GFSK modulation. Transmitting mode.</p>
Final Test Mode:	<p>Transmitting with GFSK modulation. Pretest the EUT at Transmitting mode, found the Transmitting mode which it is worse case. Only the worst case is recorded in the report.</p>
Instruments Used:	<p>Refer to section 5.10 for details.</p>
Test Results:	<p>Pass</p>

Worse case mode:	GFSK	Test channel:	Lowest
------------------	------	---------------	--------

Frequency (MHz)	Meter Reading (dB μ V)	Factor (dB)	Emission Level (dB μ V/m)	Limits (dB μ V/m)	Over (dB)	Detector Type	Ant. Pol. H/V
2390	48.73	-4.36	44.37	74	-29.63	peak	H
2390	35.13	-4.36	30.77	54	-23.23	AVG	H
2400	53.21	-4.36	48.85	74	-25.15	peak	H
2400	40.36	-4.36	36.00	54	-18.00	AVG	H
2390	46.00	-4.36	41.64	74	-32.36	peak	V
2390	36.24	-4.36	31.88	54	-22.12	AVG	V
2400	54.37	-4.36	50.01	74	-23.99	peak	V
2400	40.34	-4.36	35.98	54	-18.02	AVG	V

Worse case mode:	GFSK	Test channel:	Highest
------------------	------	---------------	---------

Frequency (MHz)	Meter Reading (dB μ V)	Factor (dB)	Emission Level (dB μ V/m)	Limits (dB μ V/m)	Over (dB)	Detector Type	Ant. Pol. H/V
2483.5	60.69	-4.22	56.47	74	-17.53	peak	H
2483.5	46.66	-4.22	42.44	54	-11.56	AVG	H
2483.5	59.89	-4.22	55.67	74	-18.33	peak	V
2483.5	46.36	-4.22	42.14	54	-11.86	AVG	V

Note:

The field strength is calculated by adding the Antenna Factor, Cable Factor & Preamplifier. The basic equation with a sample calculation is as follows:

Final Test Level = Receiver Reading + Antenna Factor + Cable Factor – Preamplifier Factor

7 Photographs - EUT Test Setup

7.1 Conducted Emission



7.2 Radiated Spurious Emission

9KHz~30MHz:



30MHz~1GHz:

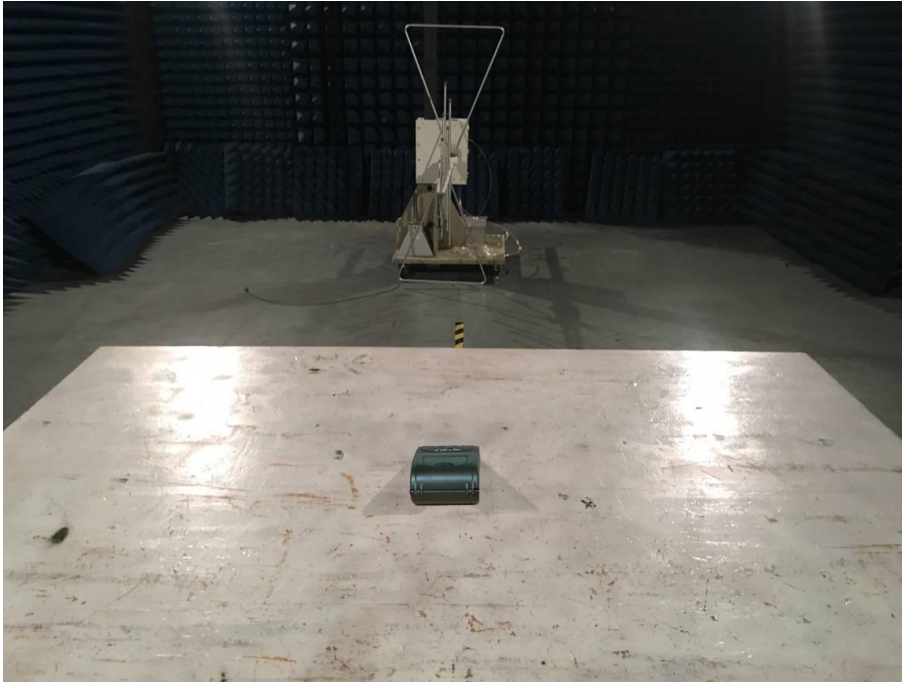

Above 1GHz:

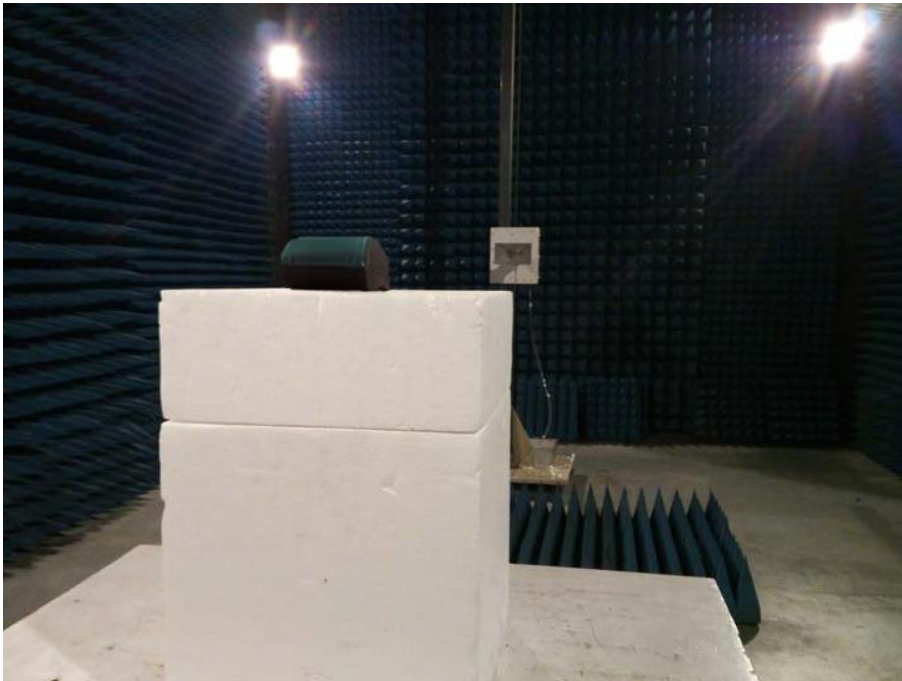

8 Photographs - EUT Constructional Details



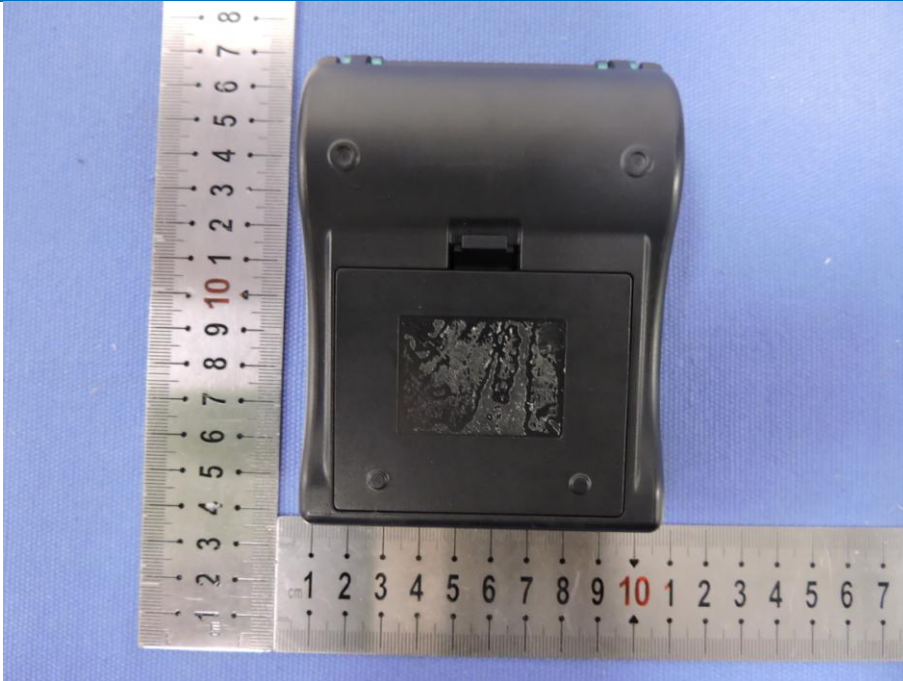







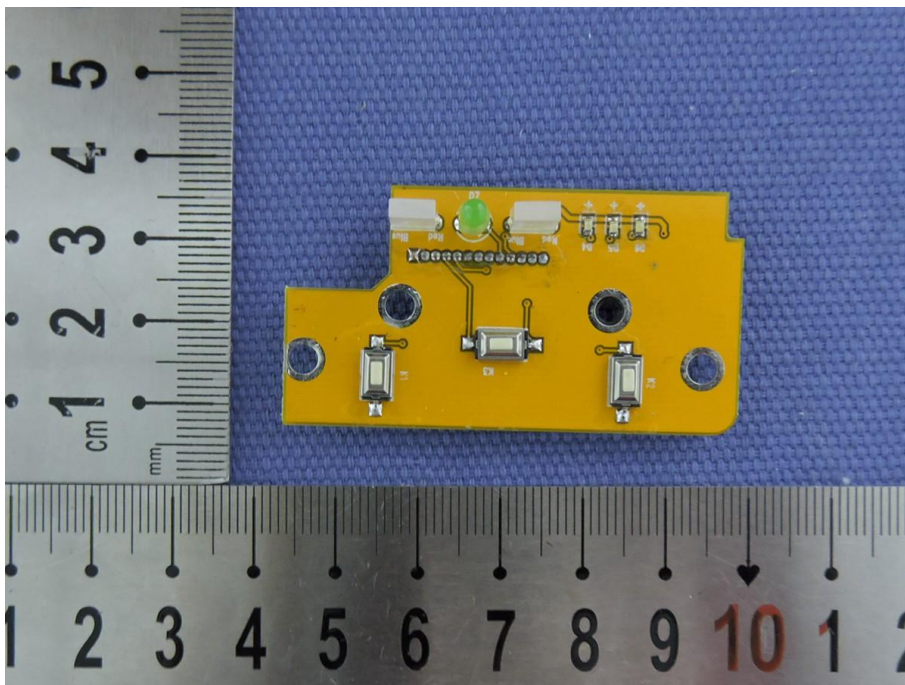
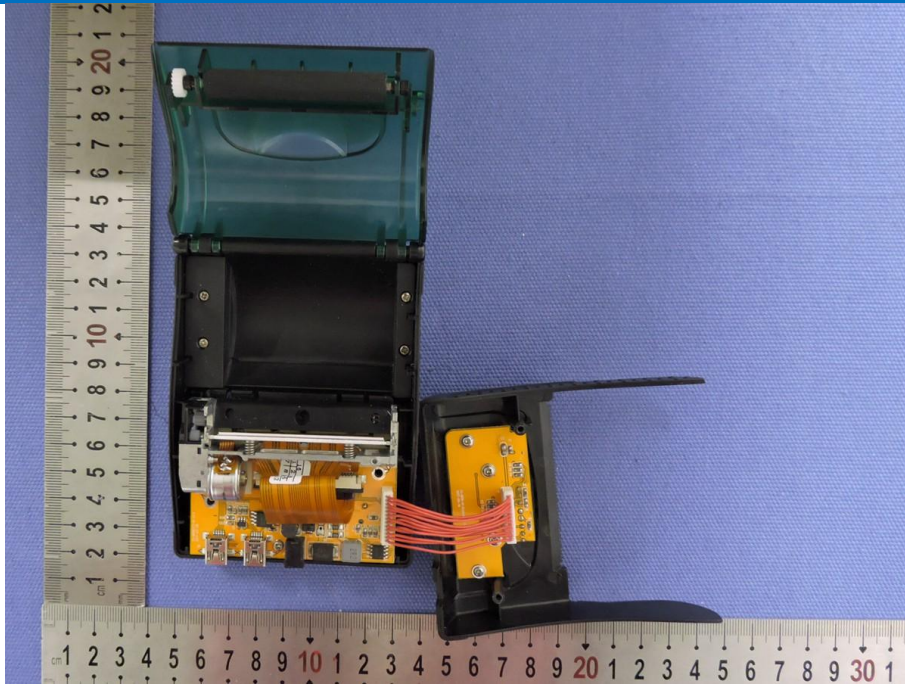

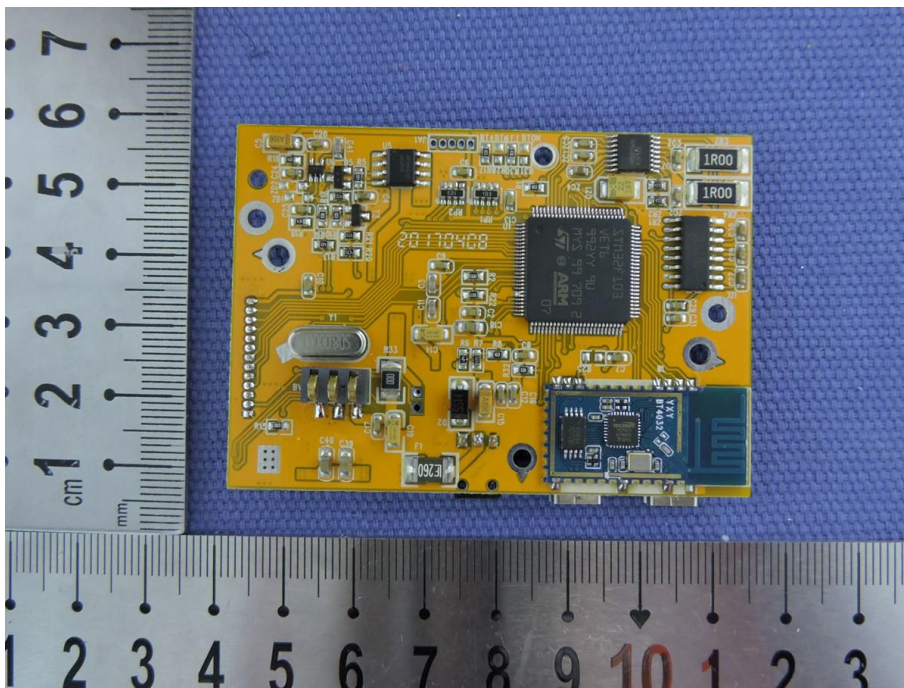
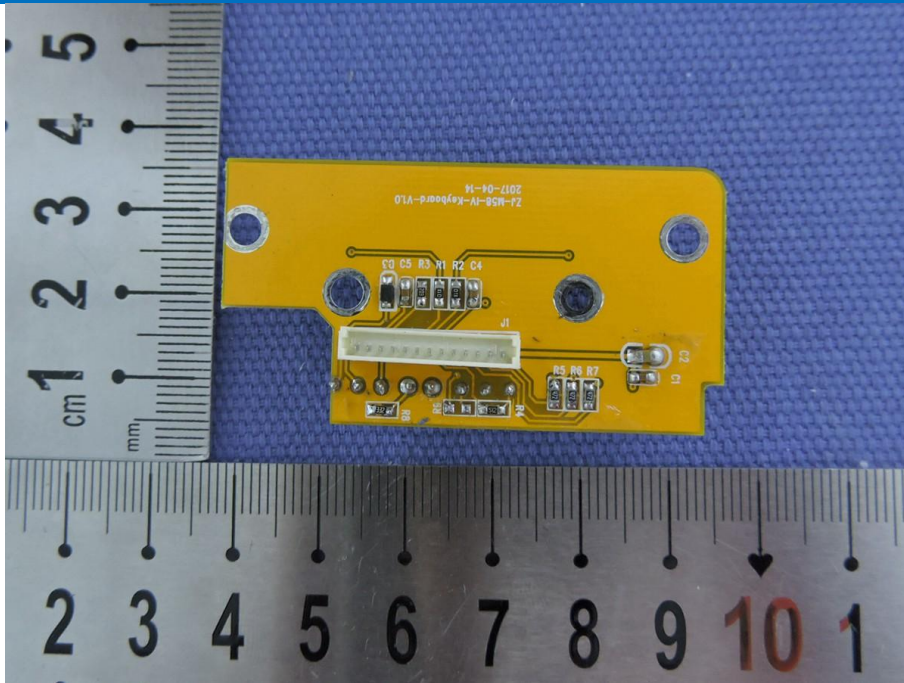

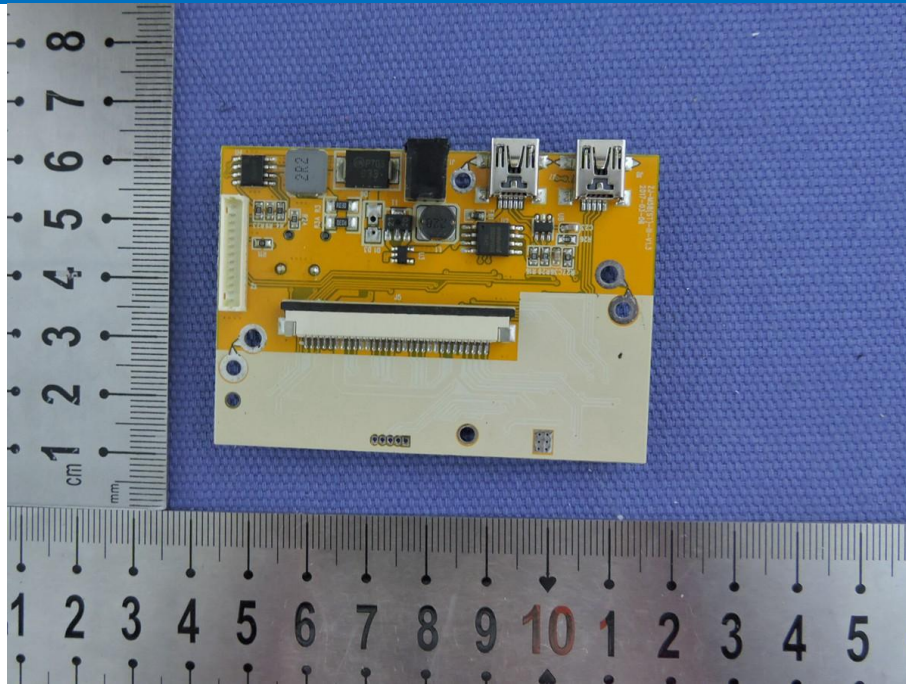

END OF THE REPORT