



Shenzhen Huaxia Testing Technology Co., Ltd

1F., Block A of Tongsheng Technology Building, Huahui Road, Dalang Street, Longhua District, Shenzhen, China

Telephone: +86-755-26648640
Fax: +86-755-26648637
Website: www.cqa-cert.com

Report Template Version: V03
Report Template Revision Date: Mar.1st, 2017

FCC Test Report

Applicant: SHENZHEN ZIJIANG ELECTRONICS CO., LTD

Address of Applicant: Area A, 4/F, No. 20, Tongfucun Industrial Zone, Dalang Community, Dalang Street, LongHua New District, Shenzhen City, Guangdong Province, P.R. China

Manufacturer: SHENZHEN ZIJIANG ELECTRONICS CO., LTD

Address of Manufacturer: Area A, 4/F, No. 20, Tongfucun Industrial Zone, Dalang Community, Dalang Street, LongHua New District, Shenzhen City, Guangdong Province, P.R. China

Factory: SHENZHEN ZIJIANG ELECTRONICS CO., LTD

Address of Factory: Area A, 4/F, No. 20, Tongfucun Industrial Zone, Dalang Community, Dalang Street, LongHua New District, Shenzhen City, Guangdong Province, P.R. China

Equipment Under Test (EUT):

Product: Portable Thermal Printer

Model: ZJ-5807LN, ZJ-5807DD, POS-5807LN, POS-5807DD

Test Model No.: ZJ-5807DD

Brand Name: **Zjiang®**

FCC ID: RVUZJ-5807DD

Standards: 47 CFR Part 15, Subpart C

Date of Test: 2017-05-27 to 2017-06-10

Date of Issue: 2017-06-10

Report No. : CQASZ170501347EW-01

Test Result : **PASS***

Tested By:

(Aaron Ma)

Reviewed By:

(Owen Zhou)

Approved By:

(Jack Ai)



* In the configuration tested, the EUT complied with the standards specified above.

1 Version

Revision History Of Report

Report No.	Version	Description	Issue Date
CQASZ170501347EW-01	Rev.01	Initial report	2017-06-10

2 Test Summary

Test Item	Test Requirement	Test method	Result
Antenna Requirement	47 CFR Part 15, Subpart C Section 15.203/15.247 (c)	ANSI C63.10 (2013)	PASS
AC Power Line Conducted Emission	47 CFR Part 15, Subpart C Section 15.207	ANSI C63.10 (2013)	PASS
Conducted Peak Output Power	47 CFR Part 15, Subpart C Section 15.247 (b)(1)	ANSI C63.10 (2013)	PASS
20dB Occupied Bandwidth	47 CFR Part 15, Subpart C Section 15.247 (a)(1)	ANSI C63.10 (2013)	PASS
Carrier Frequencies Separation	47 CFR Part 15, Subpart C Section 15.247 (a)(1)	ANSI C63.10 (2013)	PASS
Hopping Channel Number	47 CFR Part 15, Subpart C Section 15.247 (a)(1)	ANSI C63.10 (2013)	PASS
Dwell Time	47 CFR Part 15, Subpart C Section 15.247 (a)(1)	ANSI C63.10 (2013)	PASS
Pseudorandom Frequency Hopping Sequence	47 CFR Part 15, Subpart C Section 15.247(b)(4)&TCB Exclusion List (7 July 2002)	ANSI C63.10 (2013)	PASS
Band-edge for RF Conducted Emissions	47 CFR Part 15, Subpart C Section 15.247(d)	ANSI C63.10 (2013)	PASS
RF Conducted Spurious Emissions	47 CFR Part 15, Subpart C Section 15.247(d)	ANSI C63.10 (2013)	PASS
Radiated Spurious emissions	47 CFR Part 15, Subpart C Section 15.205/15.209	ANSI C63.10 (2013)	PASS
Restricted bands around fundamental frequency (Radiated Emission)	47 CFR Part 15, Subpart C Section 15.205/15.209	ANSI C63.10 (2013)	PASS

3 Contents

	Page
COVER PAGE	1
1 VERSION	2
2 TEST SUMMARY	3
3 CONTENTS	4
4 GENERAL INFORMATION	5
4.1 CLIENT INFORMATION	5
4.2 GENERAL DESCRIPTION OF EUT	5
4.3 TEST ENVIRONMENT	7
4.4 DESCRIPTION OF SUPPORT UNITS	7
4.5 STATEMENT OF THE MEASUREMENT UNCERTAINTY	7
4.6 TEST LOCATION	7
4.7 TEST FACILITY	8
4.8 ABNORMALITIES FROM STANDARD CONDITIONS	8
4.9 OTHER INFORMATION REQUESTED BY THE CUSTOMER	8
4.10 EQUIPMENT LIST	9
5 TEST RESULTS AND MEASUREMENT DATA	10
5.1 ANTENNA REQUIREMENT	10
5.2 CONDUCTED EMISSIONS	11
5.3 CONDUCTED PEAK OUTPUT POWER	14
5.4 20dB OCCUPY BANDWIDTH	21
5.5 CARRIER FREQUENCIES SEPARATION	27
5.6 HOPPING CHANNEL NUMBER	34
5.7 DWELL TIME	37
5.8 BAND-EDGE FOR RF CONDUCTED EMISSIONS	43
5.9 SPURIOUS RF CONDUCTED EMISSIONS	51
5.10 OTHER REQUIREMENTS FREQUENCY HOPPING SPREAD SPECTRUM SYSTEM	61
5.11 RADIATED SPURIOUS EMISSION	63
5.11.1 <i>Radiated Emission below 1GHz</i>	66
5.11.2 <i>Transmitter Emission above 1GHz</i>	68
5.12 RESTRICTED BANDS AROUND FUNDAMENTAL FREQUENCY	70
6 PHOTOGRAPHS - EUT TEST SETUP	73
6.1 CONDUCTED EMISSION	73
6.2 RADIATED EMISSION	73
7 PHOTOGRAPHS - EUT CONSTRUCTIONAL DETAILS	75

4 General Information

4.1 Client Information

Applicant:	SHENZHEN ZIJIANG ELECTRONICS CO., LTD
Address of Applicant:	Area A, 4/F, No. 20, Tongfucun Industrial Zone, Dalang Community, Dalang Street, LongHua New District, Shenzhen City, Guangdong Province, P.R. China
Manufacturer:	SHENZHEN ZIJIANG ELECTRONICS CO., LTD
Address of Manufacturer:	Area A, 4/F, No. 20, Tongfucun Industrial Zone, Dalang Community, Dalang Street, LongHua New District, Shenzhen City, Guangdong Province, P.R. China
Factory:	SHENZHEN ZIJIANG ELECTRONICS CO., LTD
Address of Factory:	Area A, 4/F, No. 20, Tongfucun Industrial Zone, Dalang Community, Dalang Street, LongHua New District, Shenzhen City, Guangdong Province, P.R. China

4.2 General Description of EUT

Product Name:	Portable Thermal Printer
Model No.:	ZJ-5807LN, ZJ-5807DD, POS-5807LN, POS-5807DD
Test Model No.:	ZJ-5807DD
Trade Mark:	
Hardware Version:	V1.0
Software Version:	V1.0
Operation Frequency:	2402MHz~2480MHz
Bluetooth Version:	V3.0
Modulation Technique:	Frequency Hopping Spread Spectrum(FHSS)
Modulation Type:	GFSK, $\pi/4$ DQPSK, 8DPSK
Number of Channel:	79
Hopping Channel Type:	Adaptive Frequency Hopping systems
Sample Type:	portable production
Test Software of EUT:	RF test (manufacturer declare)
Antenna Type:	PCB antenna
Antenna Gain:	0 dBi
Power Supply:	AC ADAPTER: MODEL: ZL-A015W0901500 INPUT: 100-200V ~50/60Hz 0.5 Max, OUTPUT: DC9V 1.5A Li-ion Battery: Model: 58LYDD-ZJ, Vol: 7.4V/2000mAh/11.1Wh

Note: Only the model ZJ-5807DD was tested, since the electrical circuit design, layout, components used and internal wiring were identical for the above models, with difference being color of appearance and model name.

Operation Frequency each of channel							
Channel	Frequency	Channel	Frequency	Channel	Frequency	Channel	Frequency
0	2402MHz	20	2422MHz	40	2442MHz	60	2462MHz
1	2403MHz	21	2423MHz	41	2443MHz	61	2463MHz
2	2404MHz	22	2424MHz	42	2444MHz	62	2464MHz
3	2405MHz	23	2425MHz	43	2445MHz	63	2465MHz
4	2406MHz	24	2426MHz	44	2446MHz	64	2466MHz
5	2407MHz	25	2427MHz	45	2447MHz	65	2467MHz
6	2408MHz	26	2428MHz	46	2448MHz	66	2468MHz
7	2409MHz	27	2429MHz	47	2449MHz	67	2469MHz
8	2410MHz	28	2430MHz	48	2450MHz	68	2470MHz
9	2411MHz	29	2431MHz	49	2451MHz	69	2471MHz
10	2412MHz	30	2432MHz	50	2452MHz	70	2472MHz
11	2413MHz	31	2433MHz	51	2453MHz	71	2473MHz
12	2414MHz	32	2434MHz	52	2454MHz	72	2474MHz
13	2415MHz	33	2435MHz	53	2455MHz	73	2475MHz
14	2416MHz	34	2436MHz	54	2456MHz	74	2476MHz
15	2417MHz	35	2437MHz	55	2457MHz	75	2477MHz
16	2418MHz	36	2438MHz	56	2458MHz	76	2478MHz
17	2419MHz	37	2439MHz	57	2459MHz	77	2479MHz
18	2420MHz	38	2440MHz	58	2460MHz	78	2480MHz
19	2421MHz	39	2441MHz	59	2461MHz		

Note:

In section 15.31(m), regards to the operating frequency range over 10 MHz, the Lowest frequency, the middle frequency, and the highest frequency of channel were selected to perform the test, and the selected channel see below:

Channel	Frequency
The Lowest channel	2402MHz
The Middle channel	2441MHz
The Highest channel	2480MHz

4.3 Test Environment

Operating Environment:	
Temperature:	25.0 °C
Humidity:	53 % RH
Atmospheric Pressure:	995mbar
Test Mode:	Use test software (RF Test) to set the lowest frequency, the middle frequency and the highest frequency keep transmitting of the EUT.

4.4 Description of Support Units

The EUT has been tested with associated equipment below.

Description	Manufacturer	Model No.	Remark	FCC certification
Adapter	UPRITE	ZL-A015W0901500	Provide by client	Verification

4.5 Statement of the measurement uncertainty

The data and results referenced in this document are true and accurate.

The reader is cautioned that there may be errors within the calibration limits of the equipment and facilities.

The measurement uncertainty was calculated for all measurements listed in this test report acc. to CISPR 16 - 4 „Specification for radio disturbance and immunity measuring apparatus and methods – Part 4: Uncertainty in EMC Measurements“ and is documented in the **Shenzhen Tongce Testing Lab** quality system acc. to DIN EN ISO/IEC 17025.

Furthermore, component and process variability of devices similar to that tested may result in additional deviation. The manufacturer has the sole responsibility of continued compliance of the device.

Hereafter the best measurement capability for **TCT** laboratory is reported:

Test	Range	Uncertainty	Notes
Radiated Emission	Below 1GHz	±3.92dB	(1)
Radiated Emission	Above 1GHz	±4.28dB	(1)
Conducted Disturbance	0.15~30MHz	±2.56dB	(1)

(1) This uncertainty represents an expanded uncertainty expressed at approximately the 95% confidence level using a coverage factor of k=2.

4.6 Test Location

Shenzhen Tongce Testing Lab,

1F, Leinuo Watch Building, Fuyong Town, Baoan Dist, Shenzhen, China

4.7 Test Facility

The test facility is recognized, certified, or accredited by the following organizations:

FCC – Registration No.: 572331

Shenzhen Tongce Testing Lab has been registered and fully described in a report filed with the (FCC) Federal Communications Commission. The acceptance letter from the FCC is maintained in our files. Registration 572331

4.8 Abnormalities from Standard Conditions

None.

4.9 Other Information Requested by the Customer

None.

4.10 Equipment List

Item	Test Equipment	Manufacturer	Model No.	Serial No.	Calibration Due Date
1	ESPI Test Receiver	R&S	ESVD	100008	2017/08/11
2	Spectrum Analyzer	R&S	FSEM	848597/001	2017/08/11
3	Spectrum Analyzer	Agilent	N9020A	MY49100060	2017/08/12
4	Pre-amplifier	EM Electronics Corporation CO.,LTD	EM30265	07032613	2017/08/11
5	Pre-amplifier	HP	8447D	2727A05017	2017/08/11
6	Loop antenna	ZHINAN	ZN30900A	12024	2017/08/13
7	Broadband Antenna	R&S	VULB9163	340	2017/08/13
8	Horn Antenna	R&S	BBHA 9120D	631	2017/08/13
9	Horn Antenna	R&S	BBHA 9170	373	2017/08/13
10	Antenna Mast	CCS	CC-A-4M	N/A	N/A
11	Coax cable (9KHz~40GHz)	TCT	RE-low-01	N/A	2017/08/11
12	Coax cable (9KHz~40GHz)	TCT	RE-high-02	N/A	2017/08/11
13	Coax cable (9KHz~40GHz)	TCT	RE-low-02	N/A	2017/08/11
14	Coax cable (9KHz~40GHz)	TCT	RE-high-04	N/A	2017/08/11
15	Spectrum Analyzer	R&S	FSU	200054	2017/08/11
16	Antenna Connector	TCT	RFC-01	N/A	2017/08/12
17	RF cable(9KHz~40GHz)	TCT	RE-06	N/A	2017/08/12
18	LISN	R&S	NSLK 8126	8126453	2017/08/16

Note:

The temporary antenna connector is soldered on the PCB board in order to perform conducted tests and this temporary antenna connector is listed in the equipment list.

5 Test results and Measurement Data

5.1 Antenna Requirement

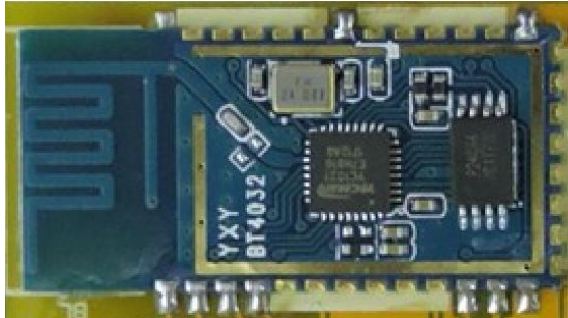
Standard requirement:	47 CFR Part 15C Section 15.203 /247(c)
<p>15.203 requirement: An intentional radiator shall be designed to ensure that no antenna other than that furnished by the responsible party shall be used with the device. The use of a permanently attached antenna or of an antenna that uses a unique coupling to the intentional radiator, the manufacturer may design the unit so that a broken antenna can be replaced by the user, but the use of a standard antenna jack or electrical connector is prohibited.</p> <p>15.247(b) (4) requirement: The conducted output power limit specified in paragraph (b) of this section is based on the use of antennas with directional gains that do not exceed 6 dBi. Except as shown in paragraph (c) of this section, if transmitting antennas of directional gain greater than 6 dBi are used, the conducted output power from the intentional radiator shall be reduced below the stated values in paragraphs (b)(1), (b)(2), and (b)(3) of this section, as appropriate, by the amount in dB that the directional gain of the antenna exceeds 6 dBi.</p>	
EUT Antenna:	
<p>The antenna is integrated on the main PCB and no consideration of replacement. The best case gain of the antenna is 0dBi.</p>	

5.2 Conducted Emissions

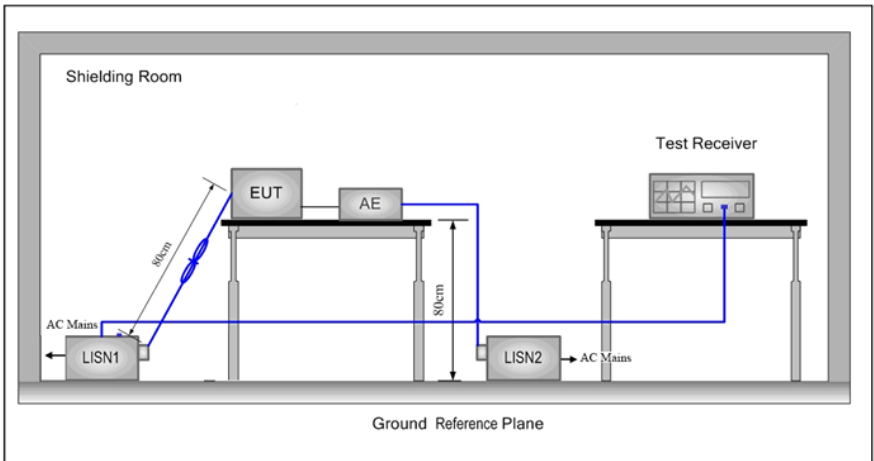
Test Requirement:	47 CFR Part 15C Section 15.207														
Test Method:	ANSI C63.10: 2013														
Test Frequency Range:	150kHz to 30MHz														
Limit:	<table border="1"> <thead> <tr> <th rowspan="2">Frequency range (MHz)</th> <th colspan="2">Limit (dBuV)</th> </tr> <tr> <th>Quasi-peak</th> <th>Average</th> </tr> </thead> <tbody> <tr> <td>0.15-0.5</td> <td>66 to 56*</td> <td>56 to 46*</td> </tr> <tr> <td>0.5-5</td> <td>56</td> <td>46</td> </tr> <tr> <td>5-30</td> <td>60</td> <td>50</td> </tr> </tbody> </table> <p>* Decreases with the logarithm of the frequency.</p>	Frequency range (MHz)	Limit (dBuV)		Quasi-peak	Average	0.15-0.5	66 to 56*	56 to 46*	0.5-5	56	46	5-30	60	50
Frequency range (MHz)	Limit (dBuV)														
	Quasi-peak	Average													
0.15-0.5	66 to 56*	56 to 46*													
0.5-5	56	46													
5-30	60	50													
Test Procedure:	<ol style="list-style-type: none"> 1) The mains terminal disturbance voltage test was conducted in a shielded room. 2) The EUT was connected to AC power source through a LISN 1 (Line Impedance Stabilization Network) which provides a $50\Omega/50\mu\text{H} + 5\Omega$ linear impedance. The power cables of all other units of the EUT were connected to a second LISN 2, which was bonded to the ground reference plane in the same way as the LISN 1 for the unit being measured. A multiple socket outlet strip was used to connect multiple power cables to a single LISN provided the rating of the LISN was not exceeded. 3) The tabletop EUT was placed upon a non-metallic table 0.8m above the ground reference plane. And for floor-standing arrangement, the EUT was placed on the horizontal ground reference plane, 4) The test was performed with a vertical ground reference plane. The rear of the EUT shall be 0.4 m from the vertical ground reference plane. The vertical ground reference plane was bonded to the horizontal ground reference plane. The LISN 1 was placed 0.8 m from the boundary of the unit under test and bonded to a ground reference plane for LISNs mounted on top of the ground reference plane. This distance was between the closest points of the LISN 1 and the EUT. All other units of the EUT and associated equipment was at least 0.8 m from the LISN 2. 5) In order to find the maximum emission, the relative positions of equipment and all of the interface cables must be changed according to ANSI C63.10: 2013 on conducted measurement. 														
Test Setup:															

Exploratory Test Mode:	Non-hopping transmitting mode with all kind of modulation and all kind of data type at the lowest, middle, high channel.
Final Test Mode:	Through Pre-scan, find the DH1 of data type and GFSK modulation at the lowest channel is the worst case. Only the worst case is recorded in the report.
Instruments Used:	Refer to section 5.10 for details
Test Voltage:	AC 120V/60Hz
Test Results:	Pass

Measurement Data

An initial pre-scan was performed on the live and neutral lines with peak detector.

Quasi-Peak and Average measurement were performed at the frequencies with maximized peak emission were detected.

Live line:

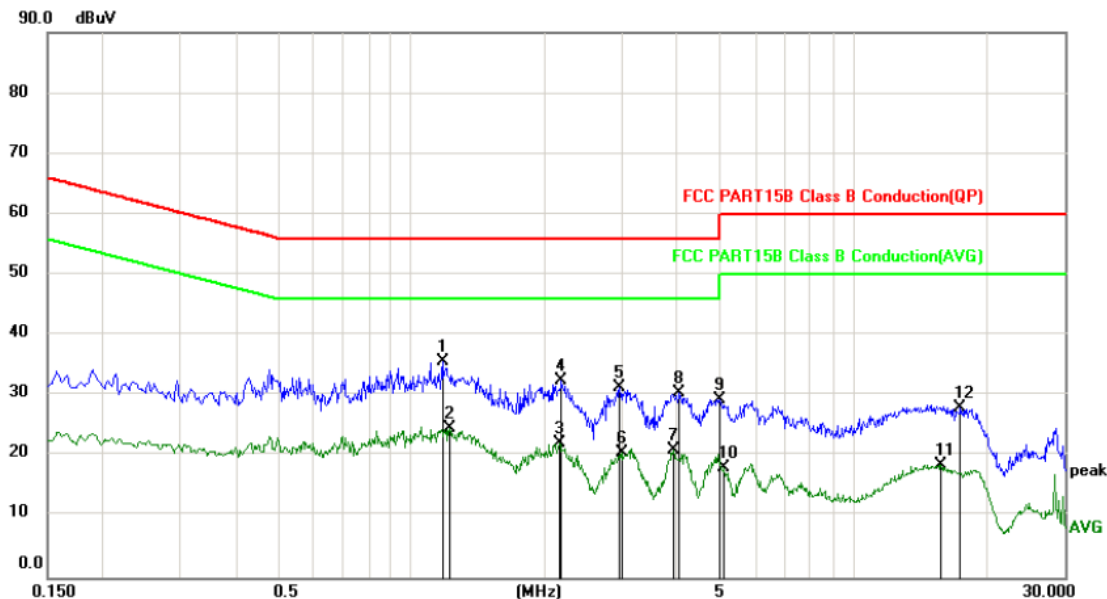

No. Mk.	Freq.	Reading Level	Correct Factor	Measurement	Limit	Over	Detector
	MHz	dBuV	dB	dBuV	dBuV	dB	
1 *	1.1740	25.84	9.75	35.59	56.00	-20.41	peak
2	1.2220	14.98	9.75	24.73	46.00	-21.27	AVG
3	2.1580	12.50	9.76	22.26	46.00	-23.74	AVG
4	2.1820	22.72	9.76	32.48	56.00	-23.52	peak
5	2.9500	21.55	9.77	31.32	56.00	-24.68	peak
6	3.0059	10.86	9.77	20.63	46.00	-25.37	AVG
7	3.9180	11.24	9.78	21.02	46.00	-24.98	AVG
8	4.0300	20.68	9.78	30.46	56.00	-25.54	peak
9	4.9820	19.63	9.79	29.42	56.00	-26.58	peak
10	5.1060	8.39	9.79	18.18	50.00	-31.82	AVG
11	15.7460	8.64	9.84	18.48	50.00	-31.52	AVG
12	17.3900	18.17	9.86	28.03	60.00	-31.97	peak

Neutral line:

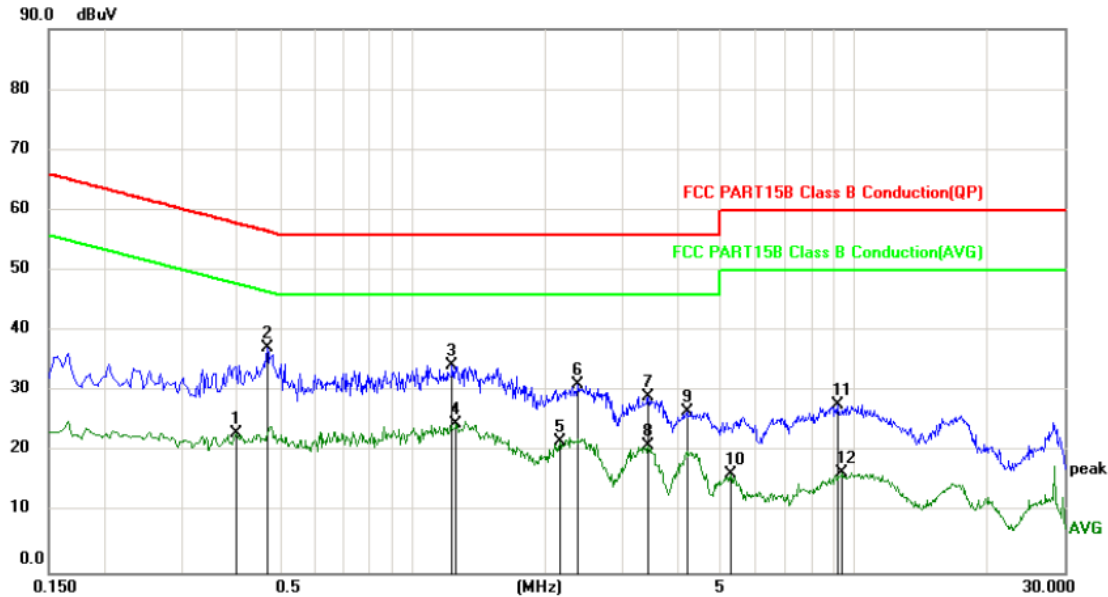

No.	Mk.	Freq.	Reading Level	Correct Factor	Measurement	Limit	Over	Detector
		MHz	dBuV	dB	dBuV	dBuV	dB	
1		0.3980	13.33	9.80	23.13	47.90	-24.77	AVG
2	*	0.4700	27.52	9.80	37.32	56.51	-19.19	peak
3		1.2340	24.48	9.83	34.31	56.00	-21.69	peak
4		1.2620	14.85	9.83	24.68	46.00	-21.32	AVG
5		2.1580	11.92	9.87	21.79	46.00	-24.21	AVG
6		2.3740	21.29	9.87	31.16	56.00	-24.84	peak
7		3.4300	19.24	9.83	29.07	56.00	-26.93	peak
8		3.4300	11.28	9.83	21.11	46.00	-24.89	AVG
9		4.1820	16.87	9.81	26.68	56.00	-29.32	peak
10		5.2660	6.53	9.83	16.36	50.00	-33.64	AVG
11		9.1860	17.91	9.87	27.78	60.00	-32.22	peak
12		9.4220	6.68	9.87	16.55	50.00	-33.45	AVG

Remark:

1. The following Quasi-Peak and Average measurements were performed on the EUT:
2. Final Test Level = Receiver Reading + LISN Factor + Cable Loss.

5.3 Conducted Peak Output Power

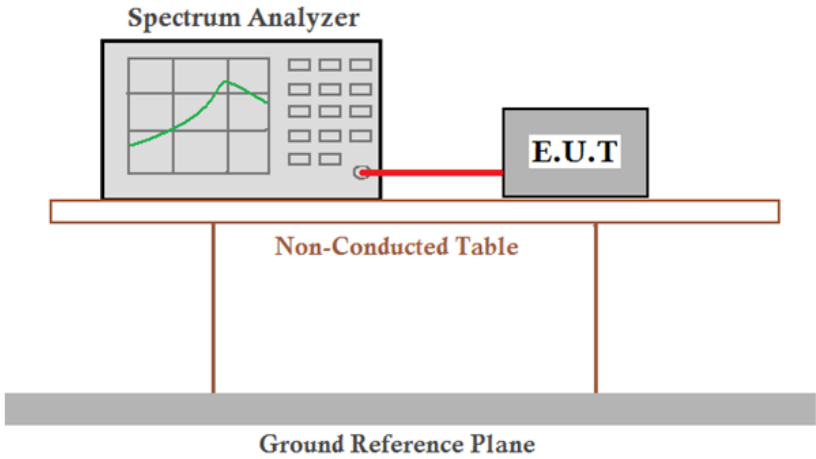
Test Requirement:	47 CFR Part 15C Section 15.247 (b)(1)
Test Method:	ANSI C63.10:2013
Test Setup:	 <p style="text-align: center;">Spectrum Analyzer</p> <p style="text-align: center;">E.U.T</p> <p style="text-align: center;">Non-Conducted Table</p> <p style="text-align: center;">Ground Reference Plane</p> <p><i>Remark:</i> Factor: the High-Frequency cable loss 1.5dB in the spectrum analyzer.</p>
Limit:	21dBm
Exploratory Test Mode:	Non-hopping transmitting with all kind of modulation and all kind of data type
Final Test Mode:	Through Pre-scan, find the DH1 of data type is the worst case of GFSK modulation type, 2-DH1 of data type is the worst case of $\pi/4$ DQPSK modulation type, 3-DH1 of data type is the worst case of 8DPSK modulation type.
Instruments Used:	Refer to section 5.10 for details
Test Results:	Pass

Measurement Data

GFSK mode			
Test channel	Peak Output Power (dBm)	Limit (dBm)	Result
Lowest	1.46	21.00	Pass
Middle	1.71	21.00	Pass
Highest	1.65	21.00	Pass
$\pi/4$ DQPSK mode			
Test channel	Peak Output Power (dBm)	Limit (dBm)	Result
Lowest	2.05	21.00	Pass
Middle	2.68	21.00	Pass
Highest	2.86	21.00	Pass
8DPSK mode			
Test channel	Peak Output Power (dBm)	Limit (dBm)	Result
Lowest	3.01	21.00	Pass
Middle	2.85	21.00	Pass
Highest	2.77	21.00	Pass

Test plot as follows:

Test mode:	GFSK	Test channel:	Lowest
------------	------	---------------	--------

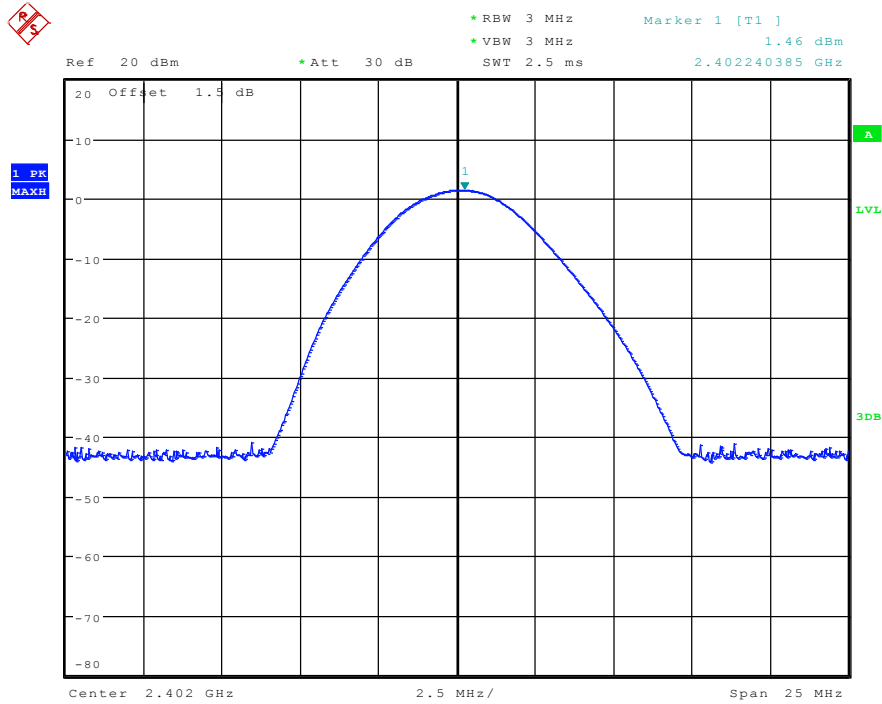

Test mode:	GFSK	Test channel:	Middle
------------	------	---------------	--------

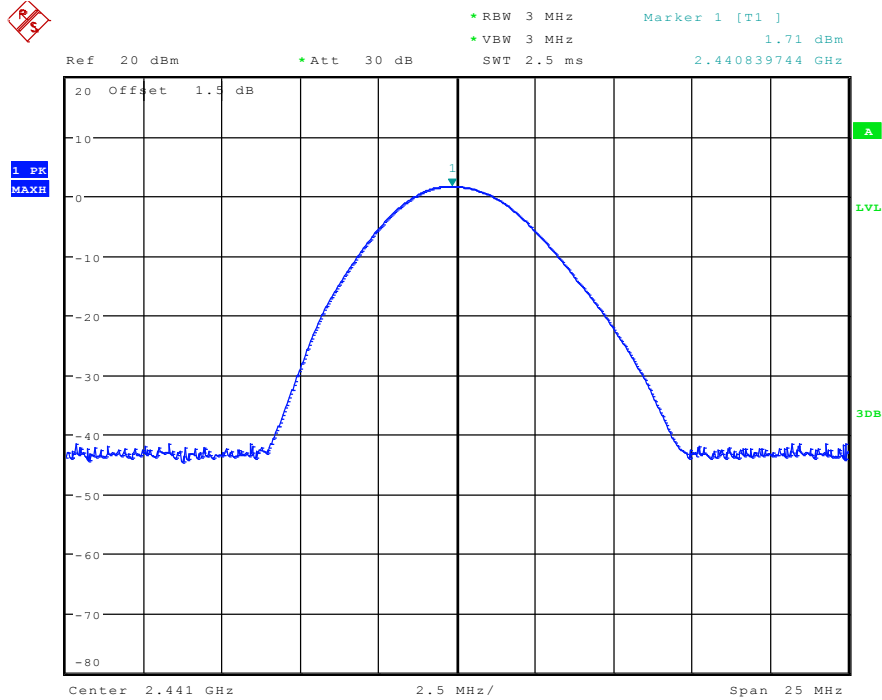

Test mode:	GFSK	Test channel:	Highest
------------	------	---------------	---------



Ref 20 dBm * Att 30 dB * RBW 3 MHz Marker 1 [T1] 1.65 dBm
 * VBW 3 MHz SWT 2.5 ms 2.479759615 GHz

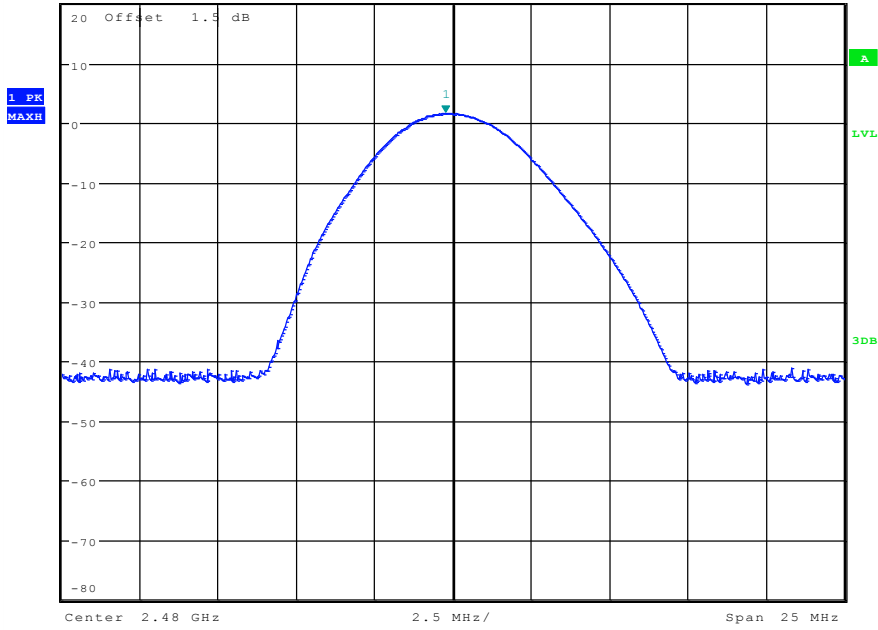

Test mode:	$\pi/4$ DQPSK	Test channel:	Lowest
------------	---------------	---------------	--------



Ref 20 dBm * Att 30 dB * RBW 3 MHz Marker 1 [T1] 2.05 dBm
 * VBW 3 MHz SWT 2.5 ms 2.401719551 GHz

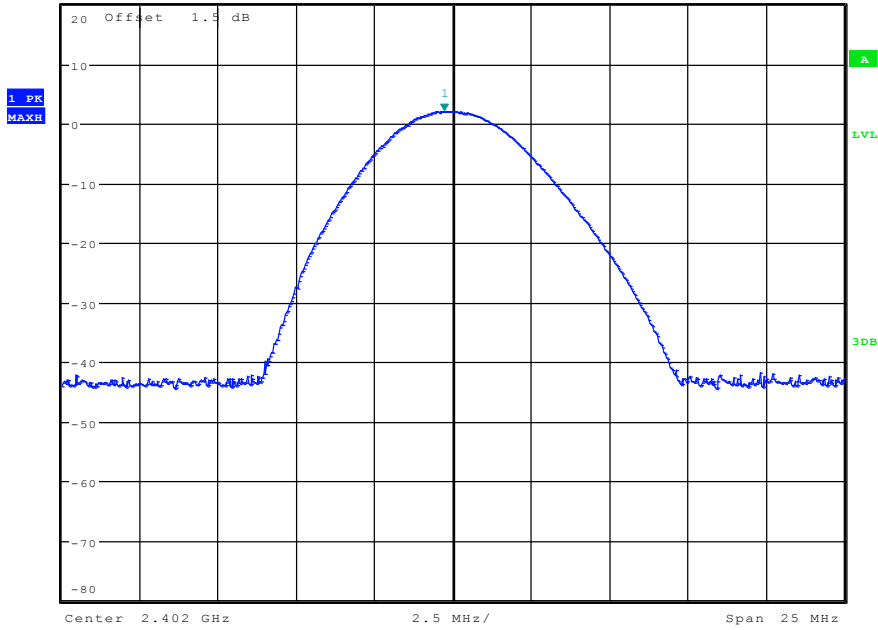

Test mode:	$\pi/4$ DQPSK	Test channel:	Middle
------------	---------------	---------------	--------

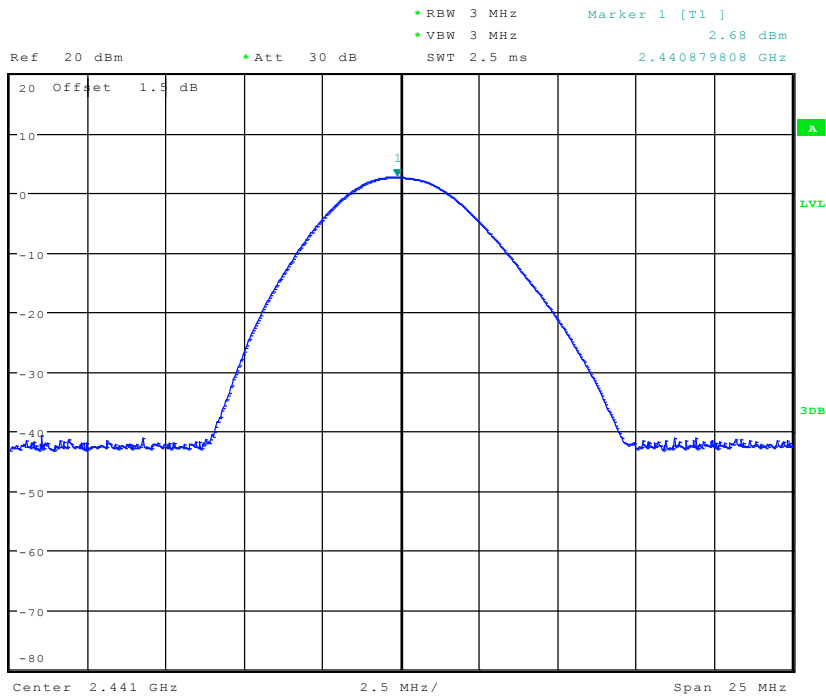

Test mode:	$\pi/4$ DQPSK	Test channel:	Highest
------------	---------------	---------------	---------

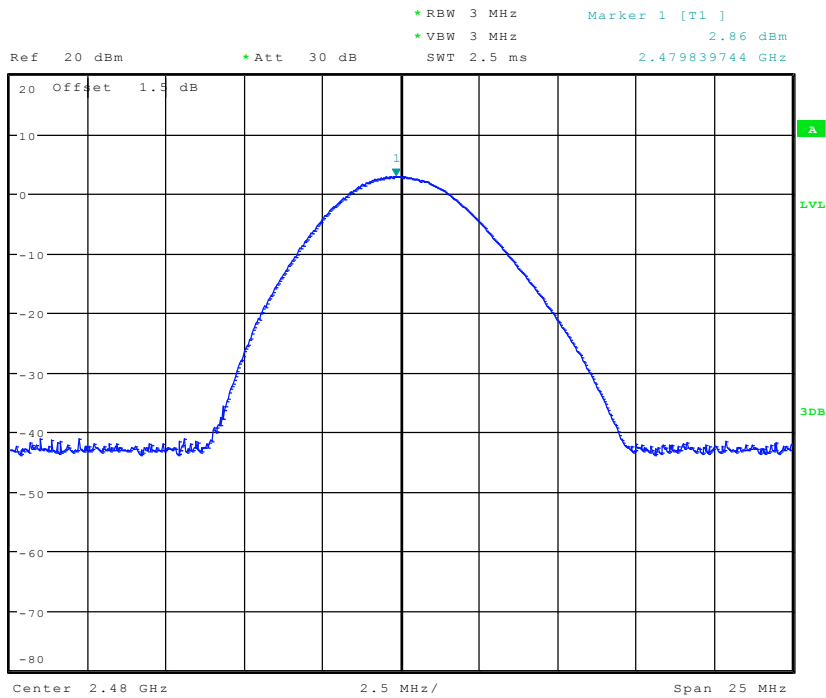

Test mode:	8DPSK	Test channel:	Lowest
------------	-------	---------------	--------

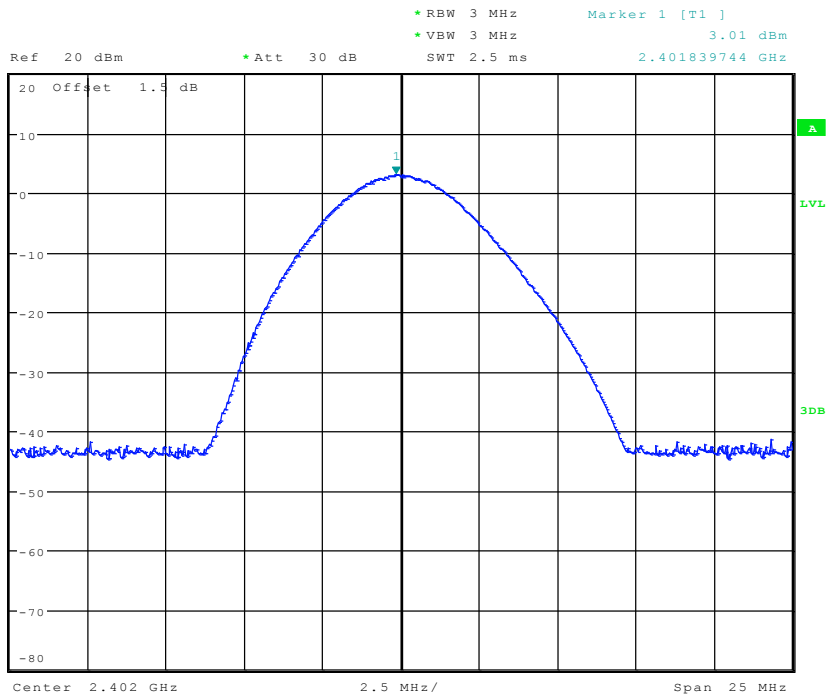

Test mode:	8DPSK	Test channel:	Middle
------------	-------	---------------	--------

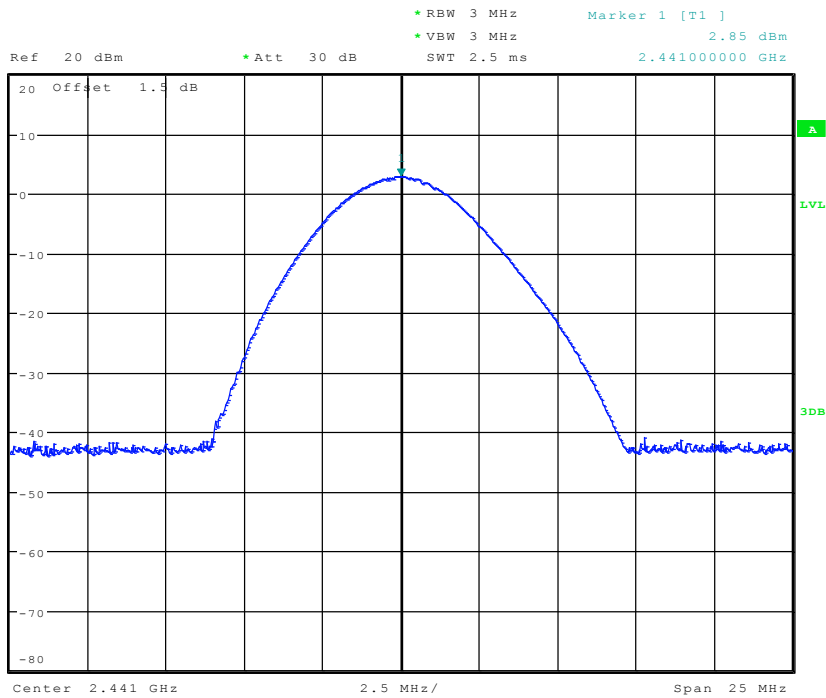

Test mode:	8DPSK	Test channel:	Highest
------------	-------	---------------	---------



Ref 20 dBm * Att 30 dB * RBW 3 MHz * VBW 3 MHz Marker 1 [T1] 2.77 dBm
SWT 2.5 ms 2.480040064 GHz

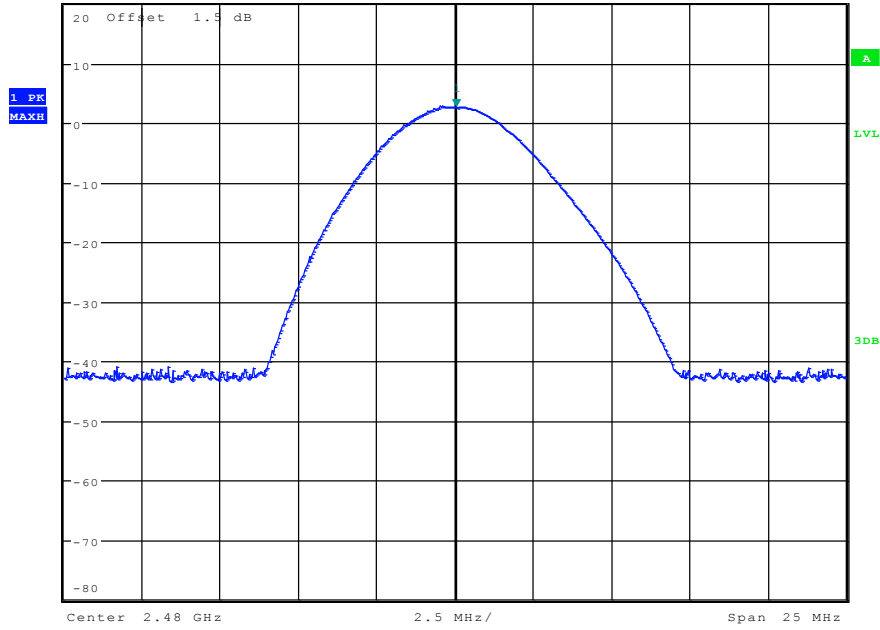

5.4 20dB Occupy Bandwidth

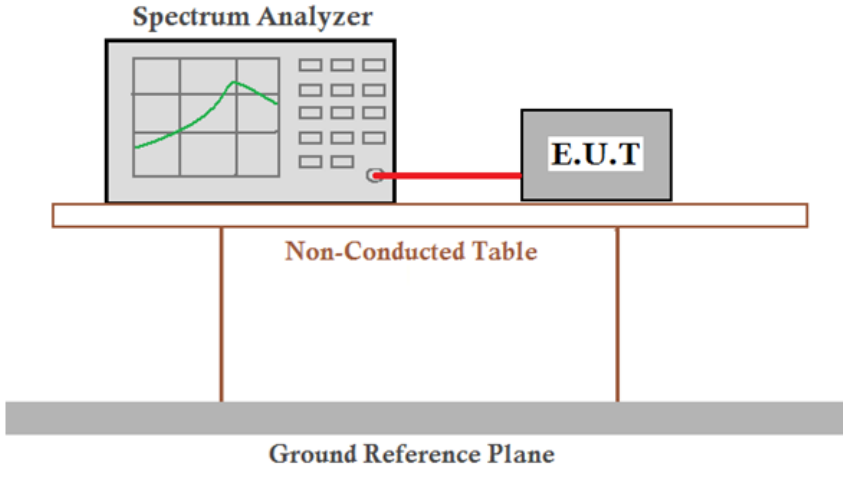
Test Requirement:	47 CFR Part 15C Section 15.247 (a)(1)
Test Method:	ANSI C63.10:2013
Test Setup:	 <p>The diagram illustrates the test setup. A Spectrum Analyzer is connected to an E.U.T. (Equipment Under Test) via a red cable. Both are placed on a Non-Conducted Table, which is supported by a Ground Reference Plane.</p>
Limit:	NA
Exploratory Test Mode:	Non-hopping transmitting with all kind of modulation and all kind of data type
Final Test Mode:	Through Pre-scan, find the DH1 of data type is the worst case of GFSK modulation type, 2-DH1 of data type is the worst case of $\pi/4$ DQPSK modulation type, 3-DH1 of data type is the worst case of 8DPSK modulation type.
Instruments Used:	Refer to section 5.10 for details
Test Results:	Pass

Measurement Data

Test channel	20dB Occupy Bandwidth (kHz)		
	GFSK	$\pi/4$ DQPSK	8DPSK
Lowest	908.65	1221.15	1221.15
Middle	894.23	1216.35	1216.35
Highest	894.23	1221.15	1221.15

Test plot as follows:

Test mode:	GFSK	Test channel:	Lowest
------------	------	---------------	--------

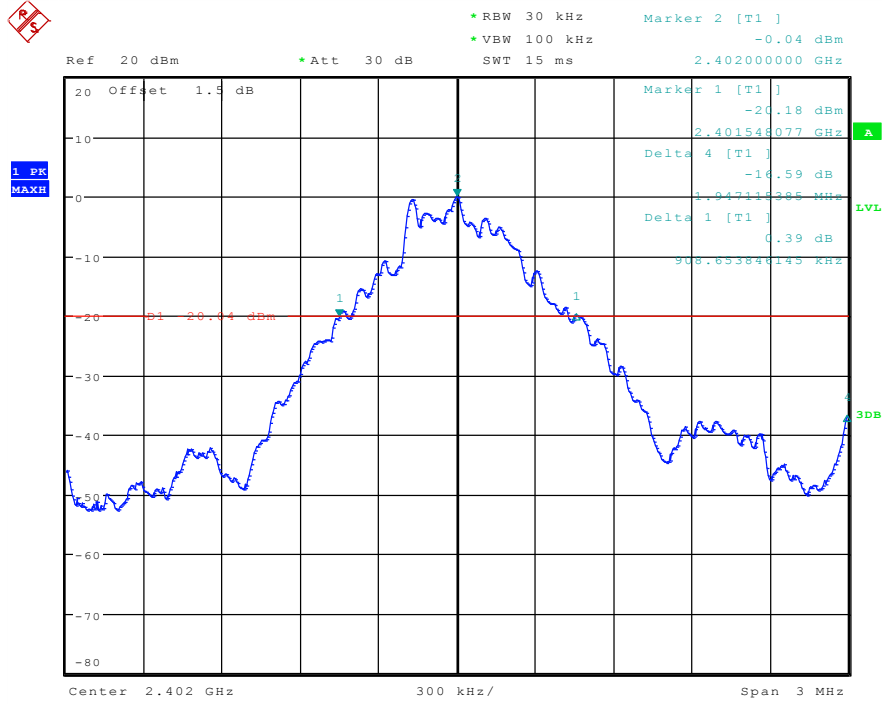

Test mode:	GFSK	Test channel:	Middle
------------	------	---------------	--------

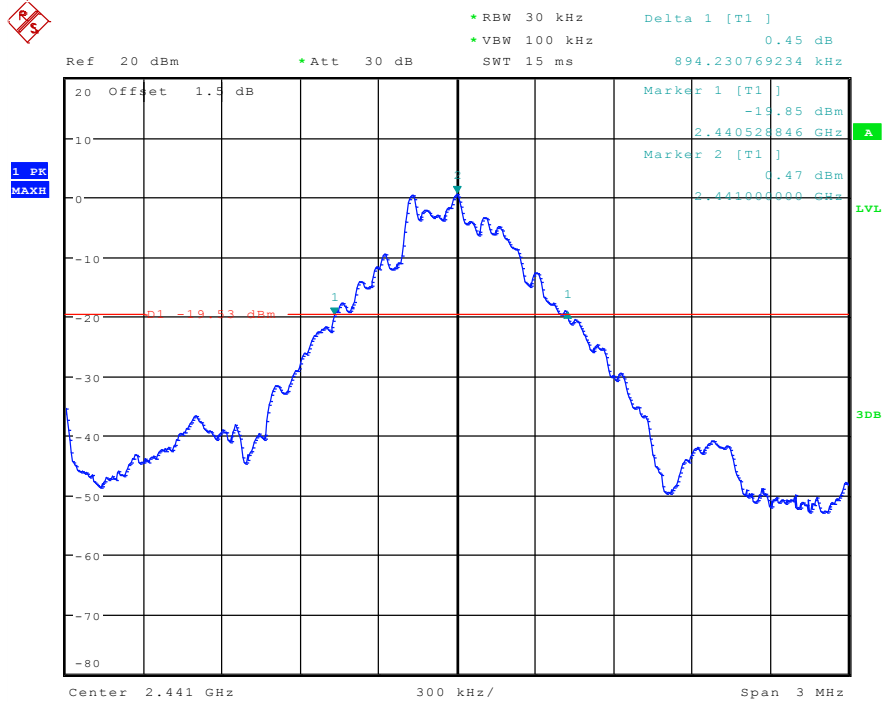

Test mode:	GFSK	Test channel:	Highest
------------	------	---------------	---------

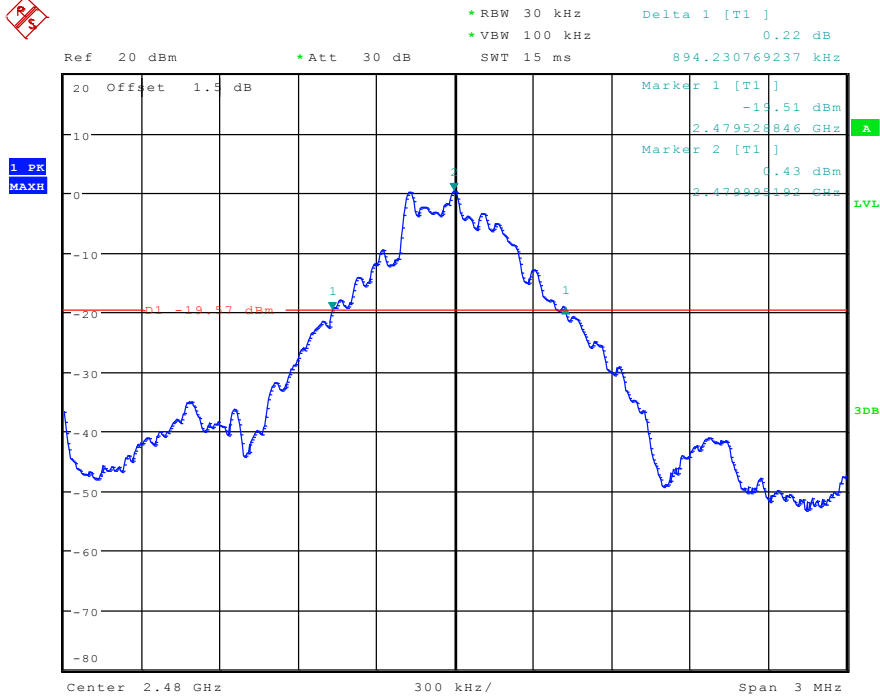

Test mode:	$\pi/4$ DQPSK	Test channel:	Lowest
------------	---------------	---------------	--------

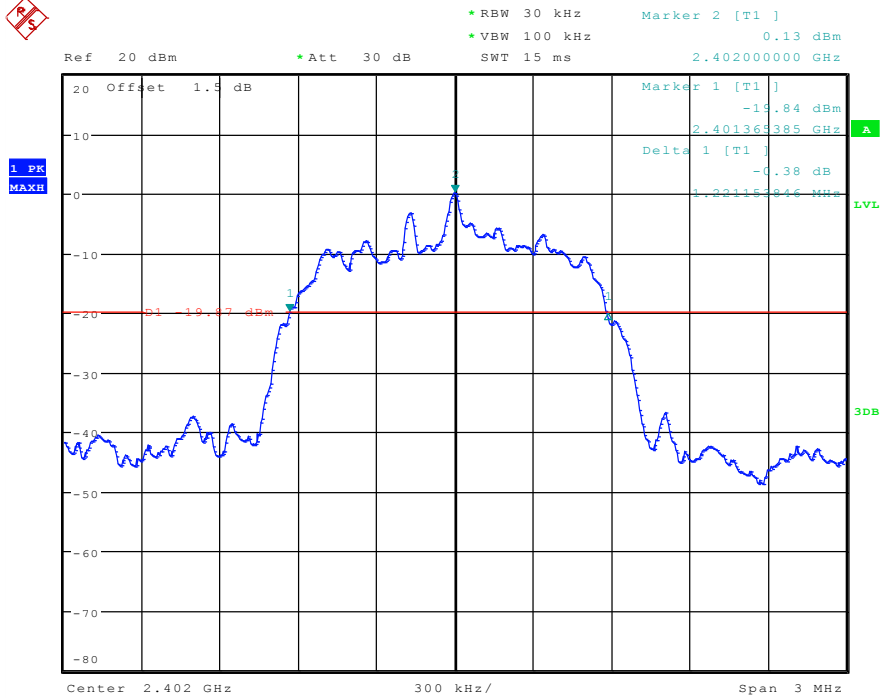

Test mode:	$\pi/4$ DQPSK	Test channel:	Middle
------------	---------------	---------------	--------

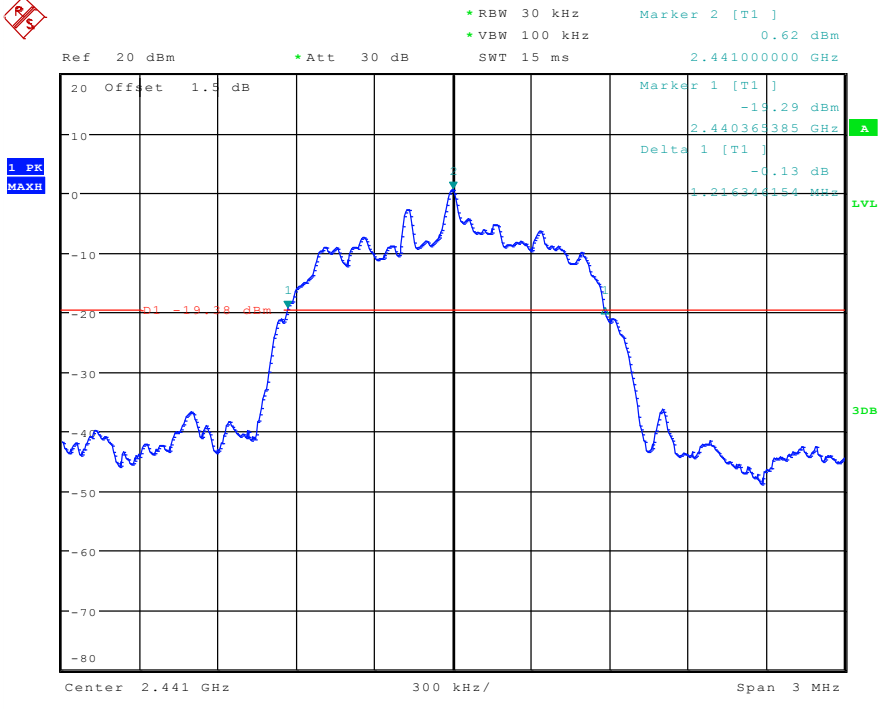

Test mode:	$\pi/4$ DQPSK	Test channel:	Highest
------------	---------------	---------------	---------

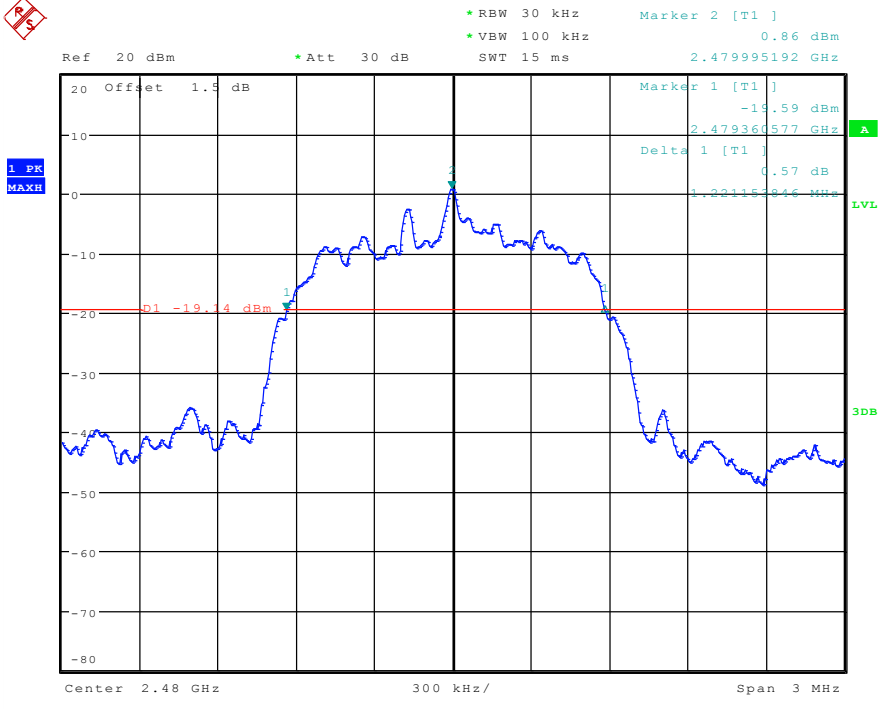

Test mode:	8DPSK	Test channel:	Lowest
------------	-------	---------------	--------

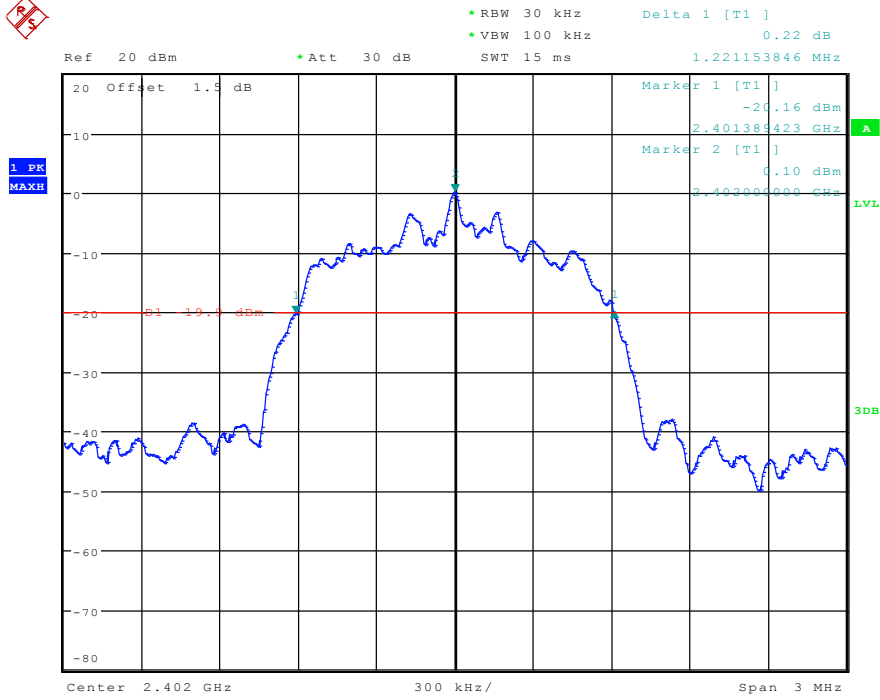

Test mode:	8DPSK	Test channel:	Middle
------------	-------	---------------	--------

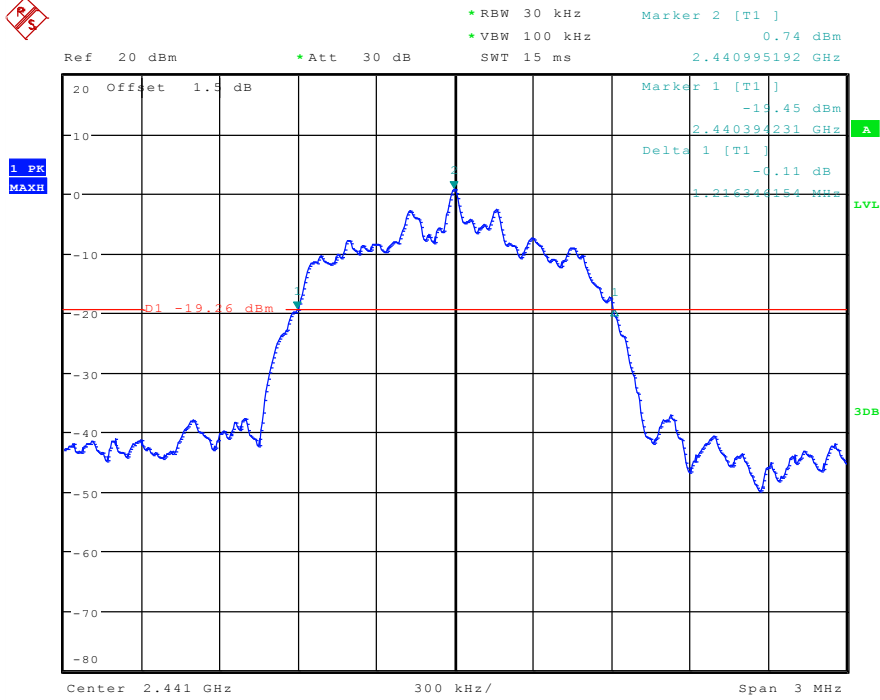

Test mode:	8DPSK	Test channel:	Highest
------------	-------	---------------	---------

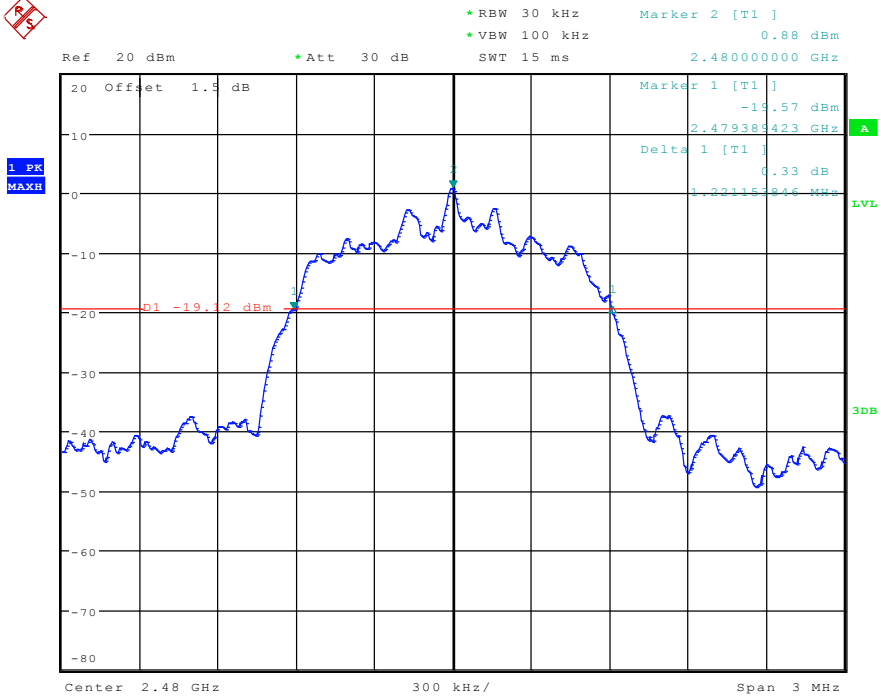

5.5 Carrier Frequencies Separation

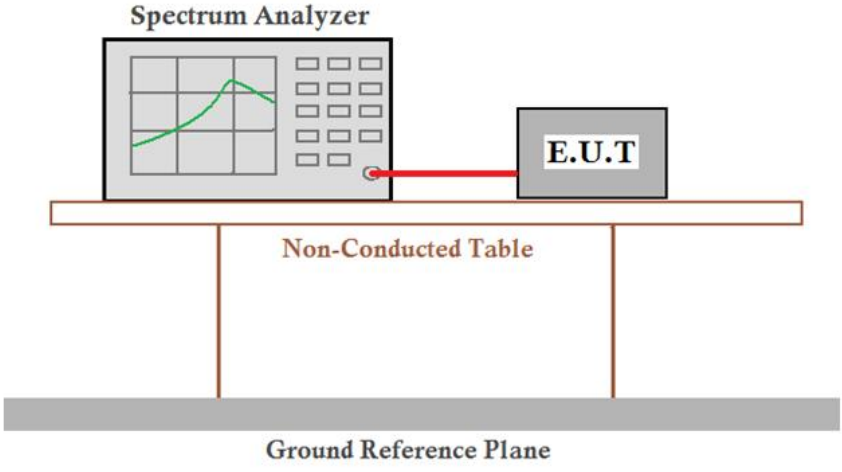
Test Requirement:	47 CFR Part 15C Section 15.247 (a)(1)
Test Method:	ANSI C63.10:2013
Test Setup:	 <p>The diagram illustrates the test setup. A Spectrum Analyzer is connected to an E.U.T. (Equipment Under Test) via a red cable. Both are placed on a Non-Conducted Table, which sits on a Ground Reference Plane.</p>
Limit:	2/3 of the 20dB bandwidth Remark: the transmission power is less than 0.125W.
Exploratory Test Mode:	Hopping transmitting with all kind of modulation and all kind of data type
Final Test Mode:	Through Pre-scan, find the DH1 of data type is the worst case of GFSK modulation type, 2-DH1 of data type is the worst case of $\pi/4$ DQPSK modulation type, 3-DH1 of data type is the worst case of 8DPSK modulation type.
Instruments Used:	Refer to section 5.10 for details
Test Results:	Pass

Measurement Data

GFSK mode			
Test channel	Carrier Frequencies Separation (kHz)	Limit (kHz)	Result
Lowest	997.6	≥605.77	Pass
Middle	1005.6	≥605.77	Pass
Highest	1001.6	≥605.77	Pass
π/4DQPSK mode			
Test channel	Carrier Frequencies Separation (kHz)	Limit (kHz)	Result
Lowest	997.6	≥814.10	Pass
Middle	997.6	≥814.10	Pass
Highest	1001.6	≥814.10	Pass
8DPSK mode			
Test channel	Carrier Frequencies Separation (kHz)	Limit (kHz)	Result
Lowest	1001.6	≥814.10	Pass
Middle	1001.6	≥814.10	Pass
Highest	1001.6	≥814.10	Pass

Note: According to section 6.4,

Mode	20dB bandwidth (kHz) (worse case)	Limit (kHz) (Carrier Frequencies Separation)
GFSK	908.65	605.77
π/4DQPSK	1221.15	814.10
8DPSK	1221.15	814.10

Test plot as follows:

Test mode:	GFSK	Test channel:	Lowest
------------	------	---------------	--------

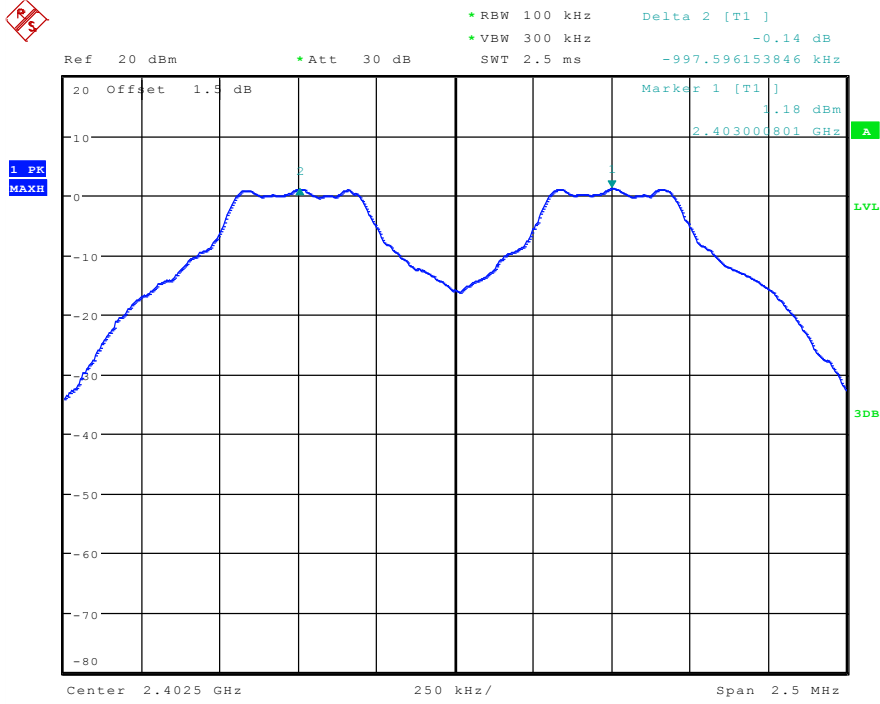

Test mode:	GFSK	Test channel:	Middle
------------	------	---------------	--------

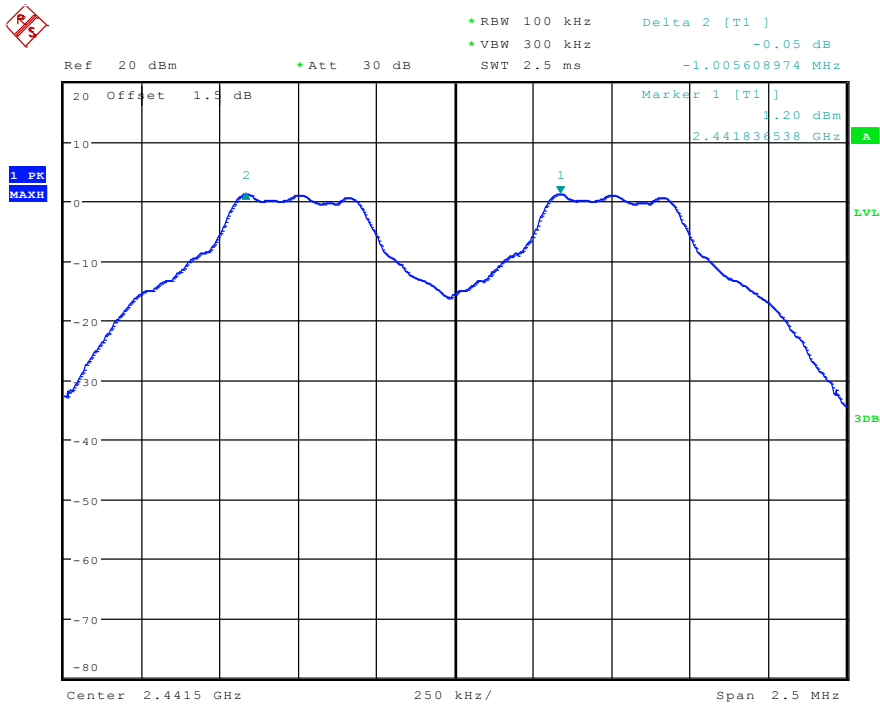

Test mode:	GFSK	Test channel:	Highest
------------	------	---------------	---------

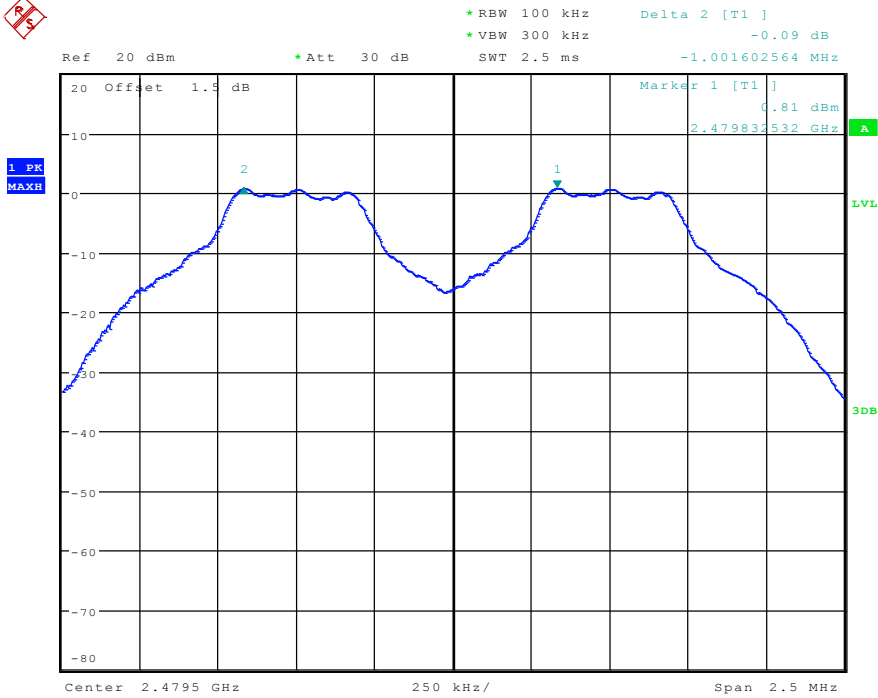

Test mode:	$\pi/4$ DQPSK	Test channel:	Lowest
------------	---------------	---------------	--------

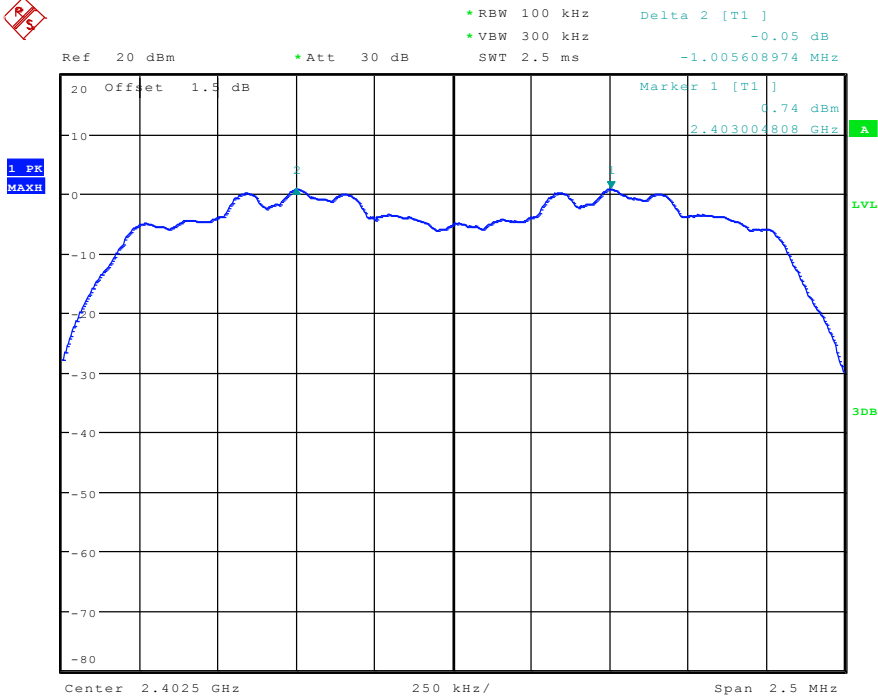

Test mode:	$\pi/4$ DQPSK	Test channel:	Middle
------------	---------------	---------------	--------

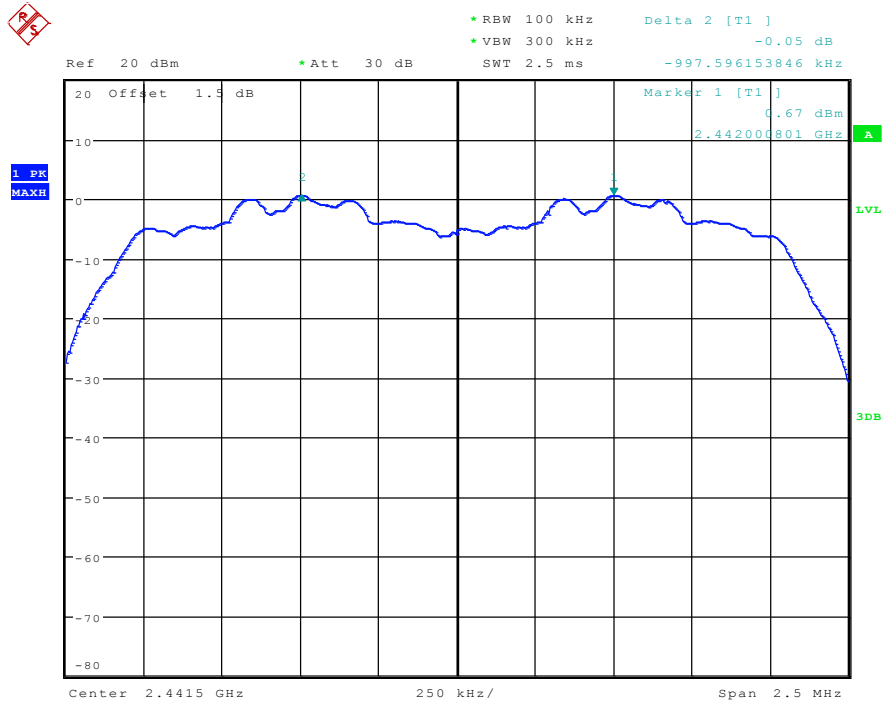

Test mode:	$\pi/4$ DQPSK	Test channel:	Highest
------------	---------------	---------------	---------

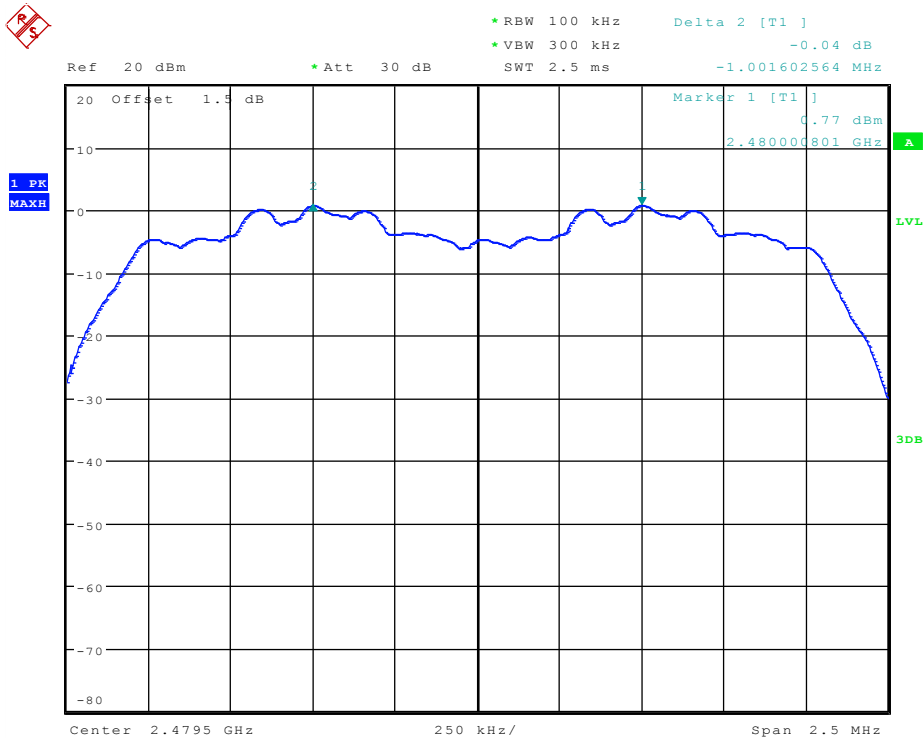

Test mode:	8DPSK	Test channel:	Lowest
------------	-------	---------------	--------

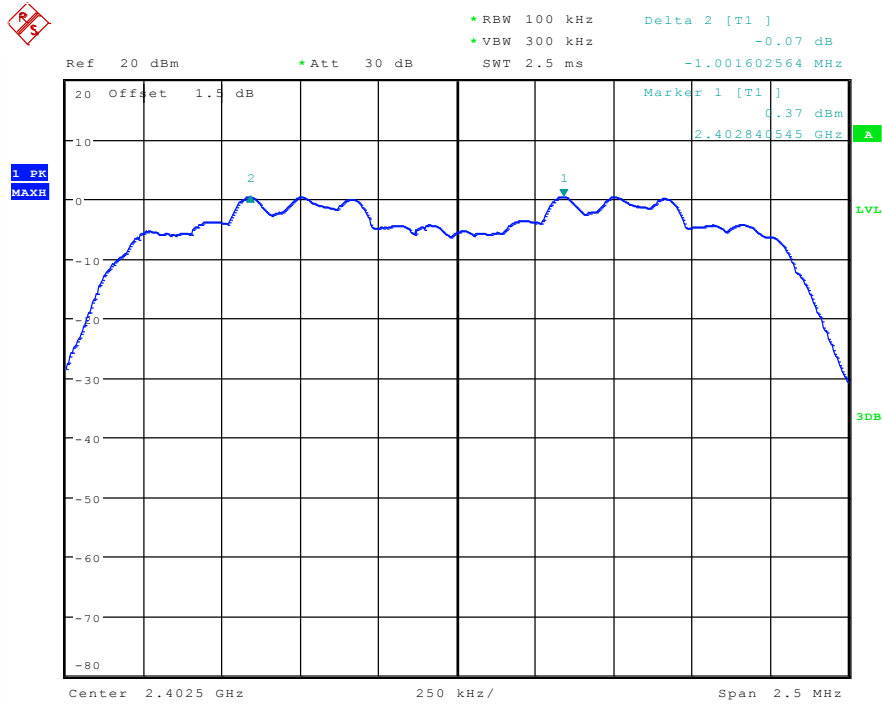

Test mode:	8DPSK	Test channel:	Middle
------------	-------	---------------	--------

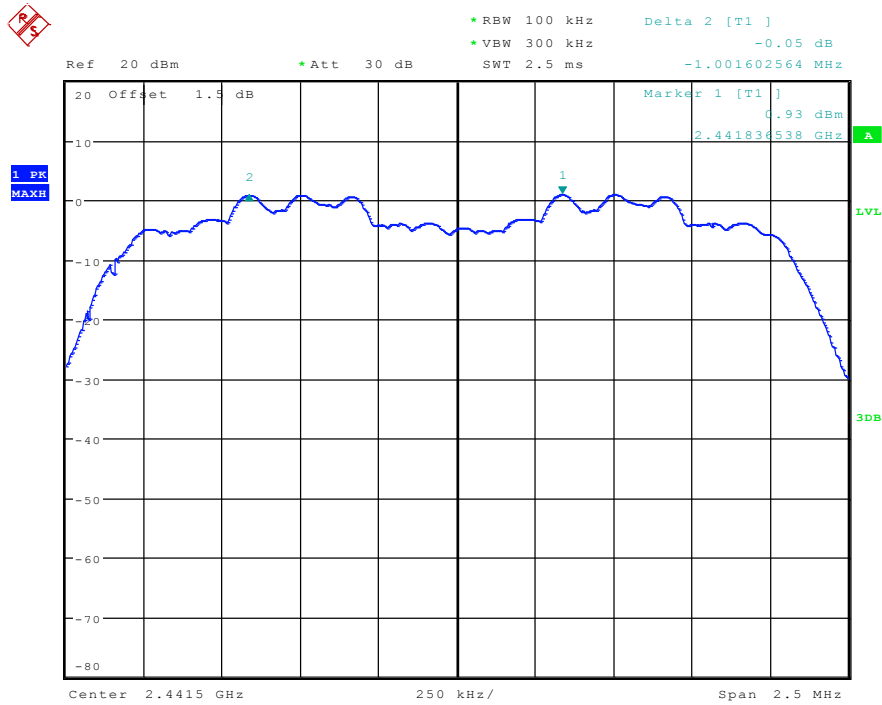

5.6 Hopping Channel Number

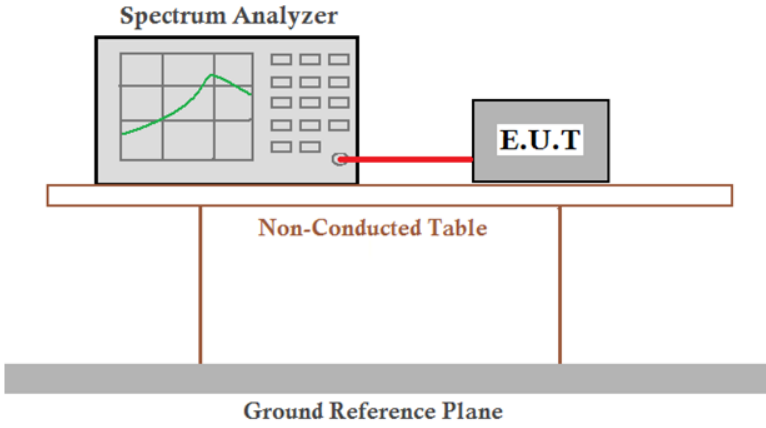
Test Requirement:	47 CFR Part 15C Section 15.247 (a)(1)
Test Method:	ANSI C63.10:2013
Test Setup:	 <p>The diagram illustrates the test setup. A Spectrum Analyzer is connected to an E.U.T. (Equipment Under Test) via a red cable. Both are placed on a Non-Conducted Table, which is supported by a Ground Reference Plane.</p>
Limit:	At least 15 channels
Test Mode:	Hopping transmitting with all kind of modulation
Instruments Used:	Refer to section 5.10 for details
Test Results:	Pass

Measurement Data

Mode	Hopping channel numbers	Limit
GFSK	79	≥15
$\pi/4$ DQPSK	79	≥15
8DPSK	79	≥15

5.7 Dwell Time

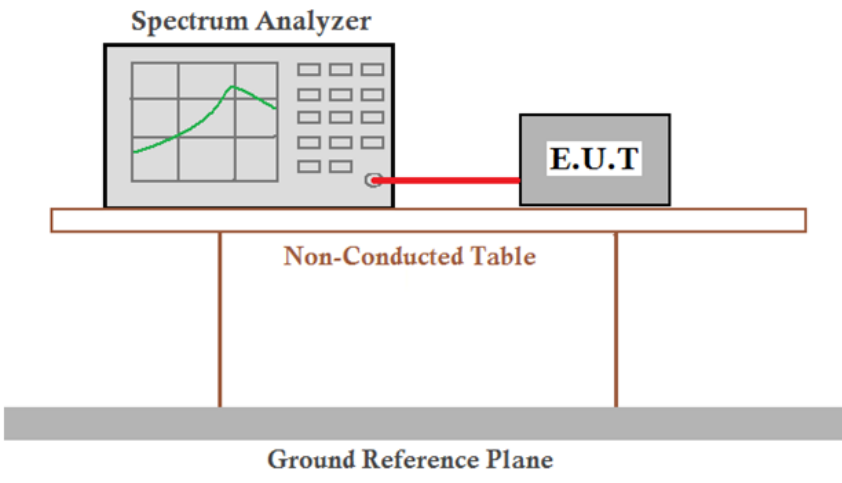
Test Requirement:	47 CFR Part 15C Section 15.247 (a)(1)
Test Method:	ANSI C63.10:2013
Test Setup:	
Instruments Used:	Refer to section 5.10 for details
Test Mode:	Hopping transmitting with all kind of modulation and all kind of data type.
Limit:	0.4 Second
Test Results:	Pass

Measurement Data

Mode	Packet	Dwell time (second)	Limit (second)
GFSK	DH1	0.119	≤0.4
	DH3	0.262	≤0.4
	DH5	0.306	≤0.4
π/4DQPSK	2-DH1	0.124	≤0.4
	2-DH3	0.262	≤0.4
	2-DH5	0.308	≤0.4
8DPSK	3-DH1	0.122	≤0.4
	3-DH3	0.261	≤0.4
	3-DH5	0.306	≤0.4

Test Result:

The test period: $T = 0.4 \text{ Second/Channel} \times 79 \text{ Channel} = 31.6 \text{ s}$

The lowest channel (2402MHz), middle channel (2441MHz), highest channel (2480MHz) as below

DH1 time slot = $0.373(\text{ms}) \times (1600 / (2 \times 79)) \times 31.6 = 119 \text{ ms}$

DH3 time slot = $1.635(\text{ms}) \times (1600 / (4 \times 79)) \times 31.6 = 262 \text{ ms}$

DH5 time slot = $2.873(\text{ms}) \times (1600 / (6 \times 79)) \times 31.6 = 306 \text{ ms}$

Test plot as follows:

Test Packet:	DH1
--------------	-----

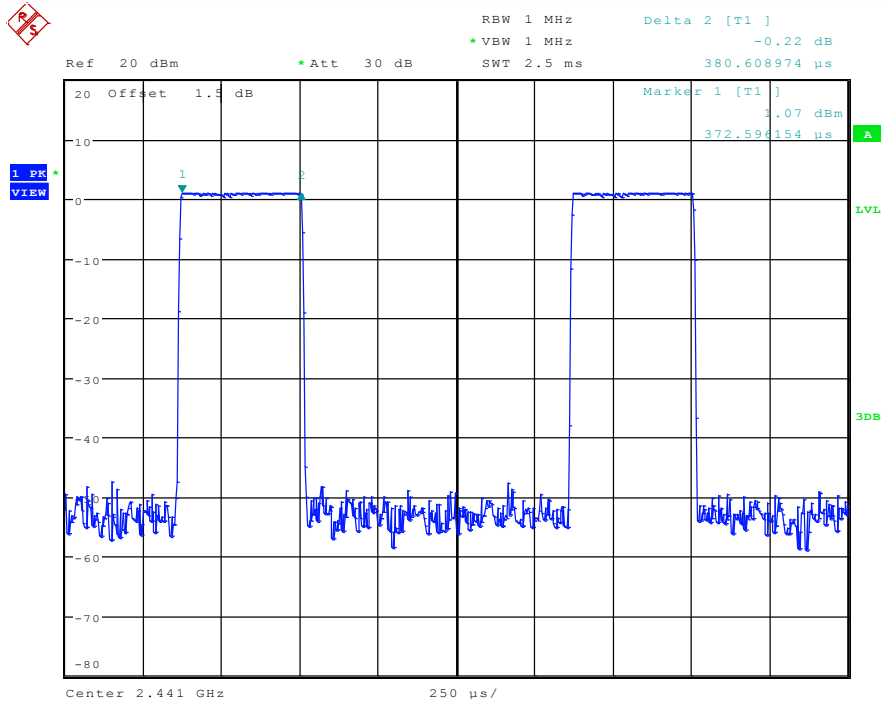

Test Packet:	DH3
--------------	-----

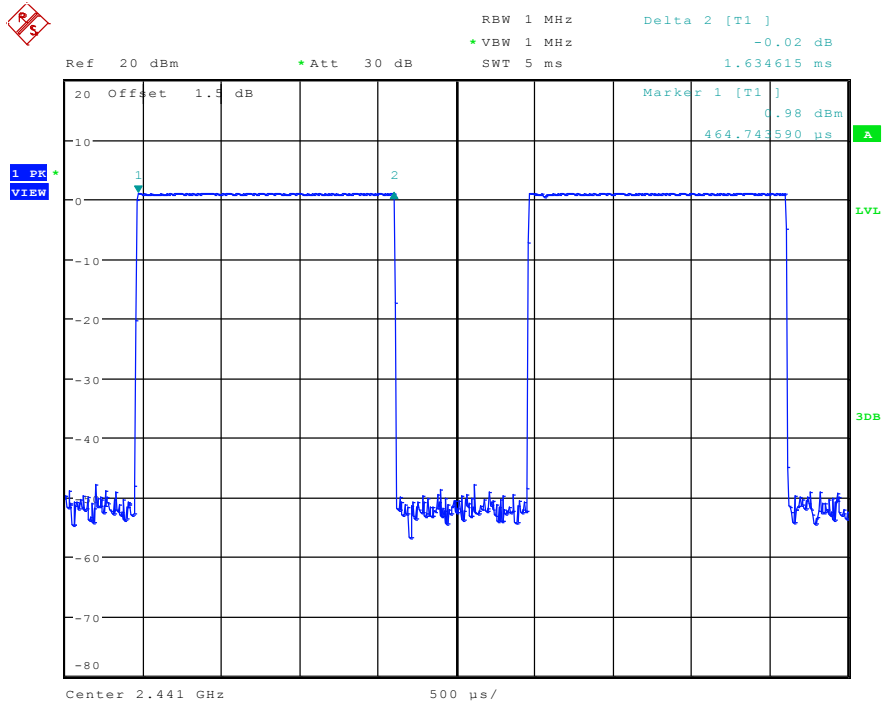

Test Packet:	DH5
--------------	-----



Ref 20 dBm * Att 30 dB RBW 1 MHz Delta 2 [T1] -0.06 dB
 * VBW 1 MHz SWT 7.5 ms 2.872596 ms

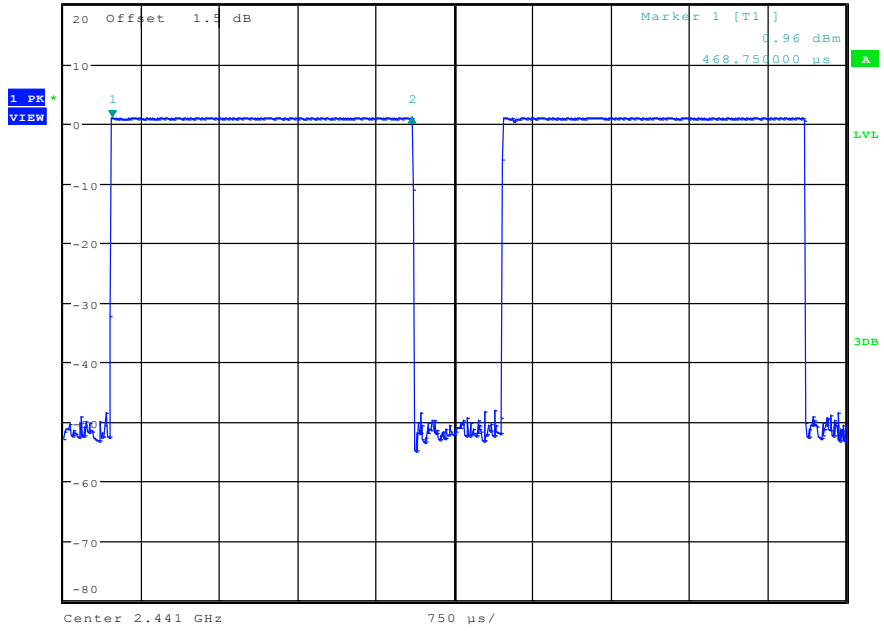

Test Packet:	2-DH1
--------------	-------



Ref 20 dBm * Att 30 dB RBW 1 MHz Delta 2 [T1] -0.53 dB
 * VBW 1 MHz SWT 2.5 ms 388.621795 μs

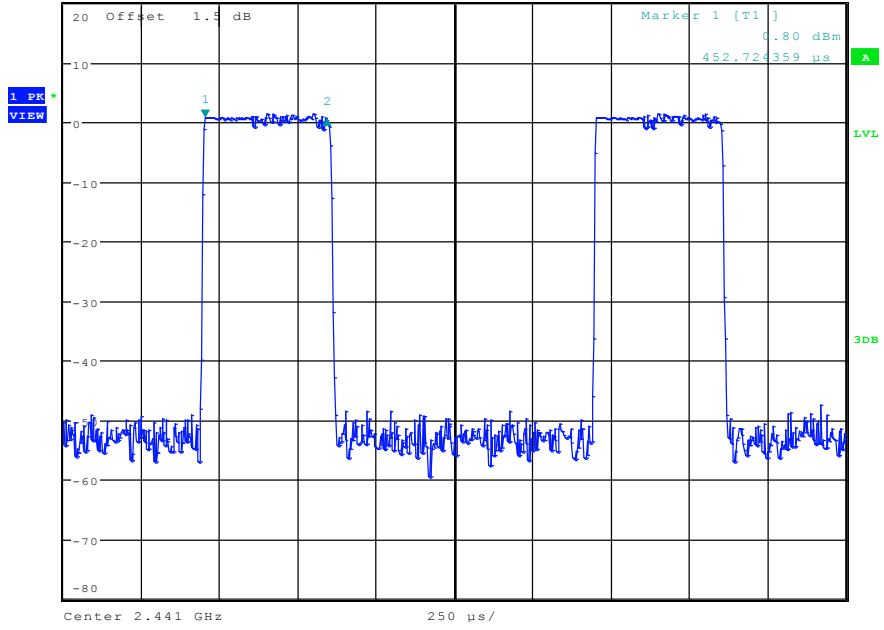

Test Packet:	2-DH3
--------------	-------

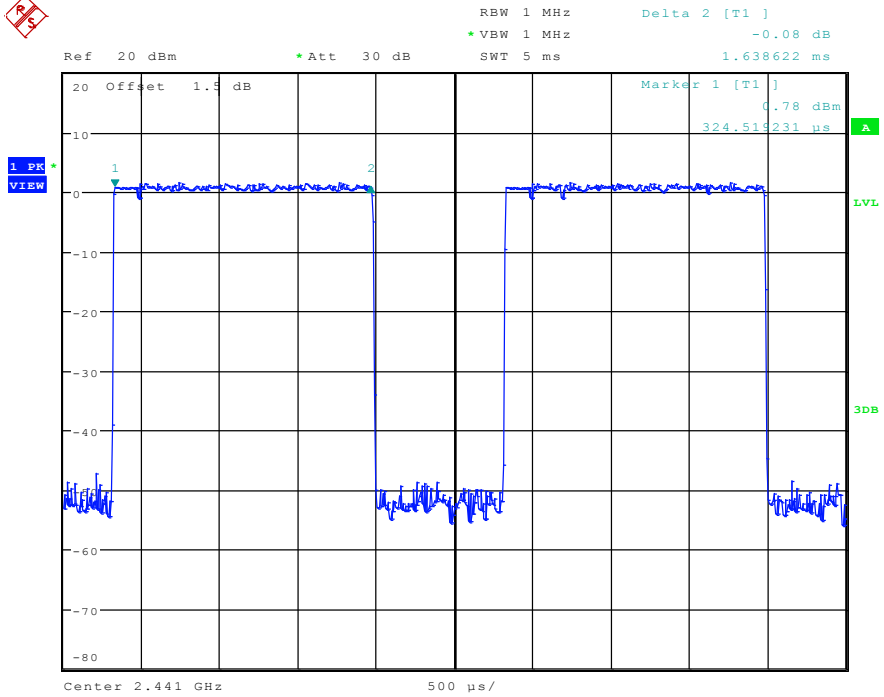

Test Packet:	2-DH5
--------------	-------

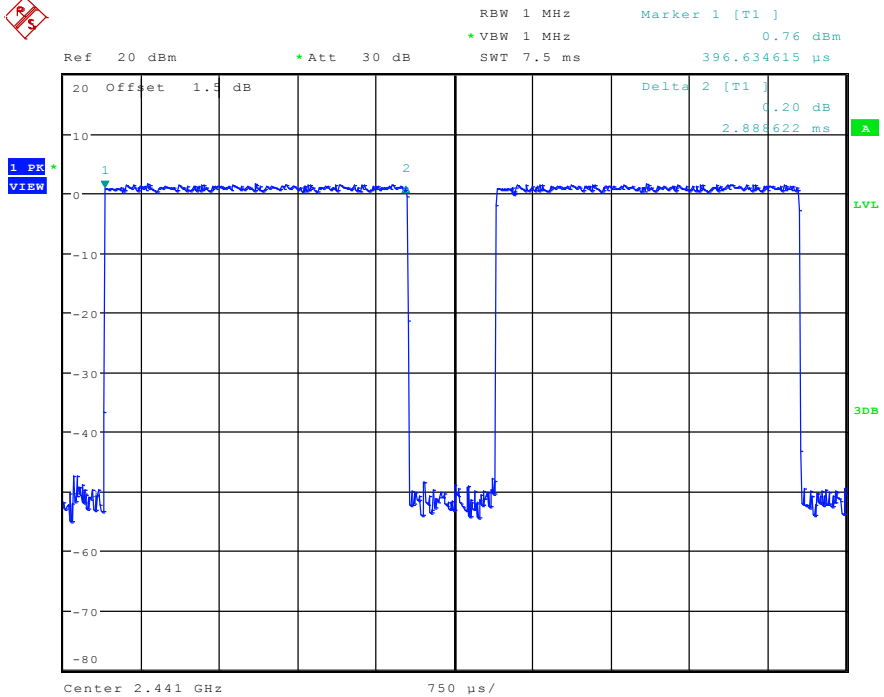

Test Packet:	3-DH1
--------------	-------

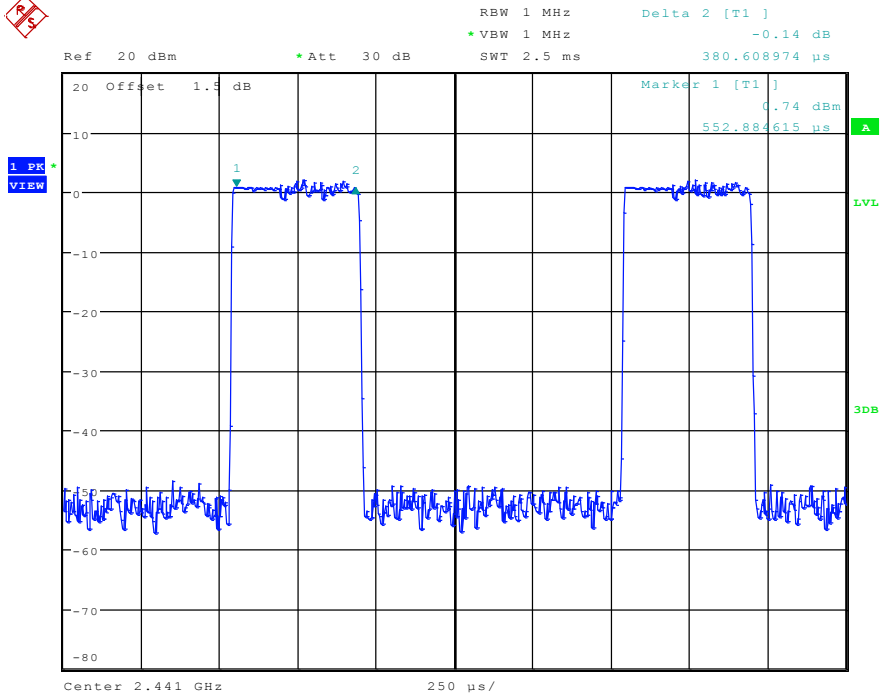

Test Packet:	3-DH3
--------------	-------

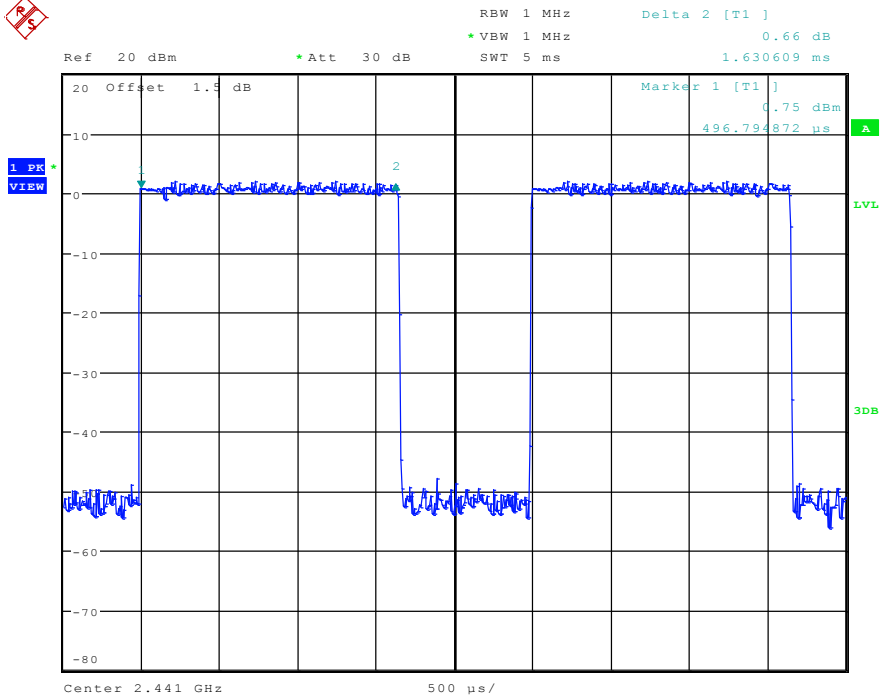

Test Packet:	3-DH5
--------------	-------

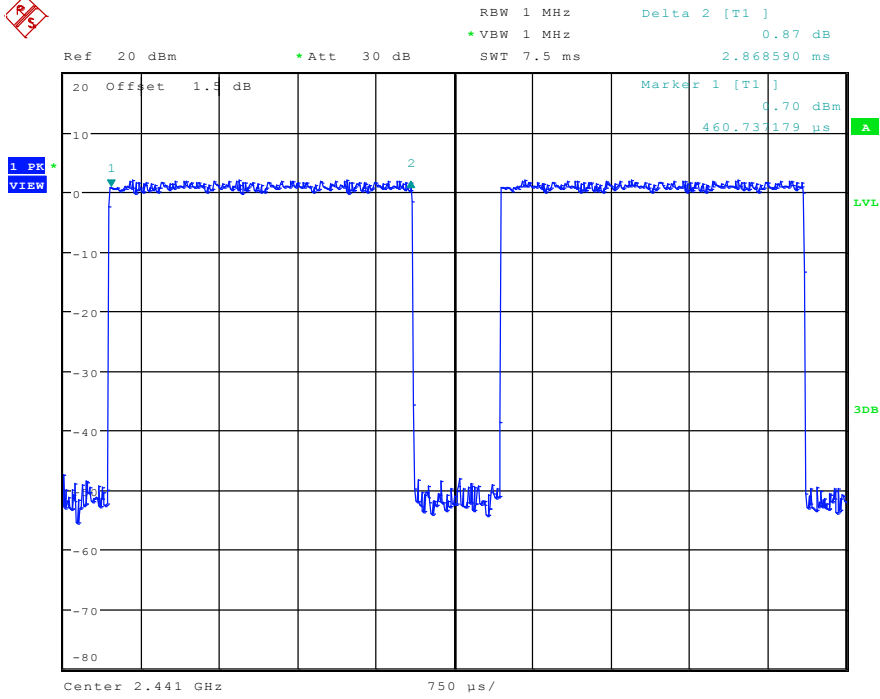

5.8 Band-edge for RF Conducted Emissions

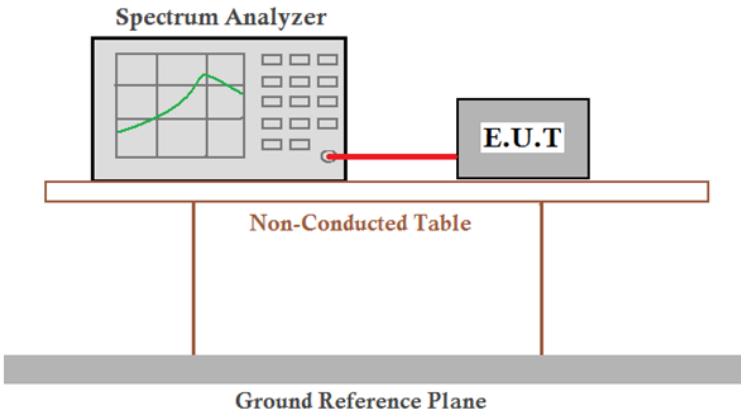
Test Requirement:	47 CFR Part 15C Section 15.247 (d)
Test Method:	ANSI C63.10:2013
Test Setup:	 <p>Remark: Factor: the High-Frequency cable loss 1.5dB in the spectrum analyzer.</p>
Limit:	In any 100 kHz bandwidth outside the frequency band in which the spread spectrum intentional radiator is operating, the radio frequency power that is produced by the intentional radiator shall be at least 20 dB below that in the 100 kHz bandwidth within the band that contains the highest level of the desired power, based on either an RF conducted or a radiated measurement.
Exploratory Test Mode:	Hopping and Non-hopping transmitting with all kind of modulation and all kind of data type
Final Test Mode:	Through Pre-scan, find the DH1 of data type is the worst case of GFSK modulation type, 2-DH1 of data type is the worst case of $\pi/4$ DQPSK modulation type, 3-DH1 of data type is the worst case of 8DPSK modulation type.
Instruments Used:	Refer to section 5.10 for details
Test Results:	Pass

No-hopping mode

GFSK mode				
Test channel	Frequency(MHz)	Emission Level(dBm)	Limit(dBm)	Result
Lowest	2400	-45.79	-18.97	Pass
Highest	2483.5	-53.30	-18.74	Pass
$\pi/4$ DQPSK mode				
Test channel	Frequency(MHz)	Emission Level(dBm)	Limit(dBm)	Result
Lowest	2400	-39.83	-19.33	Pass
Highest	2483.5	-52.25	-18.56	Pass
8DPSK mode				
Test channel	Frequency(MHz)	Emission Level(dBm)	Limit(dBm)	Result
Lowest	2400	-40.23	-19.26	Pass
Highest	2483.5	-53.36	-18.85	Pass

Hopping mode

GFSK mode				
Test channel	Frequency(MHz)	Emission Level(dBm)	Limit(dBm)	Result
Lowest	2400	-48.08	-18.93	Pass
Highest	2483.5	-53.65	-18.96	Pass
$\pi/4$ DQPSK mode				
Test channel	Frequency(MHz)	Emission Level(dBm)	Limit(dBm)	Result
Lowest	2400	-43.48	-18.91	Pass
Highest	2483.5	-52.60	-18.72	Pass
8DPSK mode				
Test channel	Frequency(MHz)	Emission Level(dBm)	Limit(dBm)	Result
Lowest	2400	-44.47	-19.12	Pass
Highest	2483.5	-52.78	-19.36	Pass

Test mode:	GFSK	Test channel:	Highest
------------	------	---------------	---------

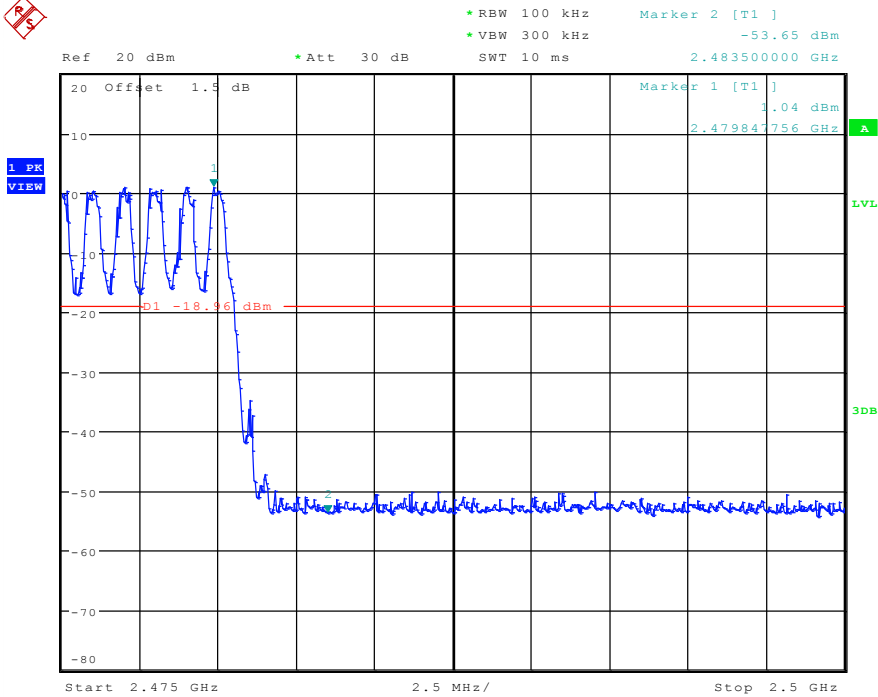
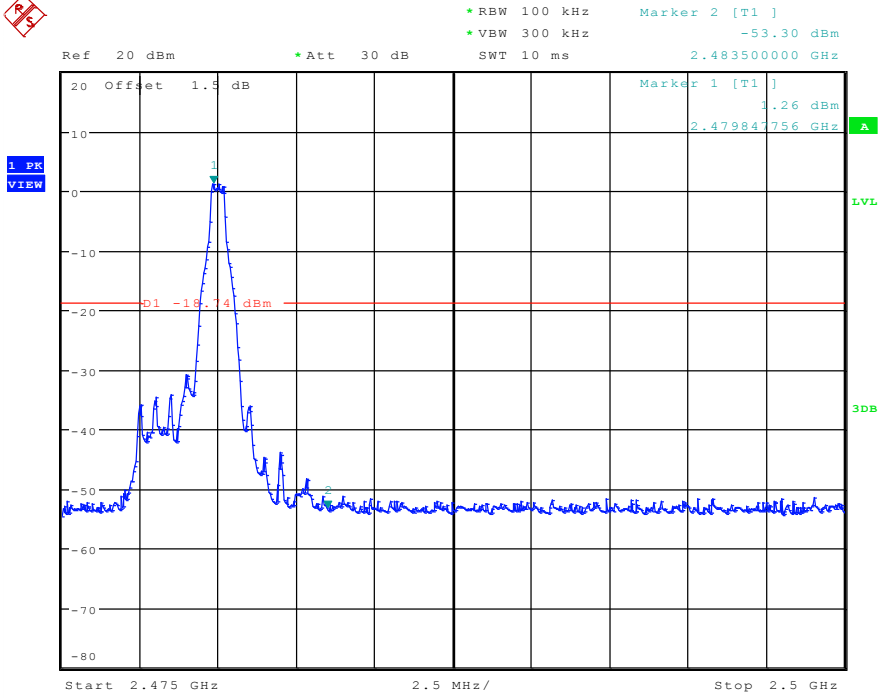

Test mode:	$\pi/4$ DQPSK	Test channel:	Lowest
------------	---------------	---------------	--------

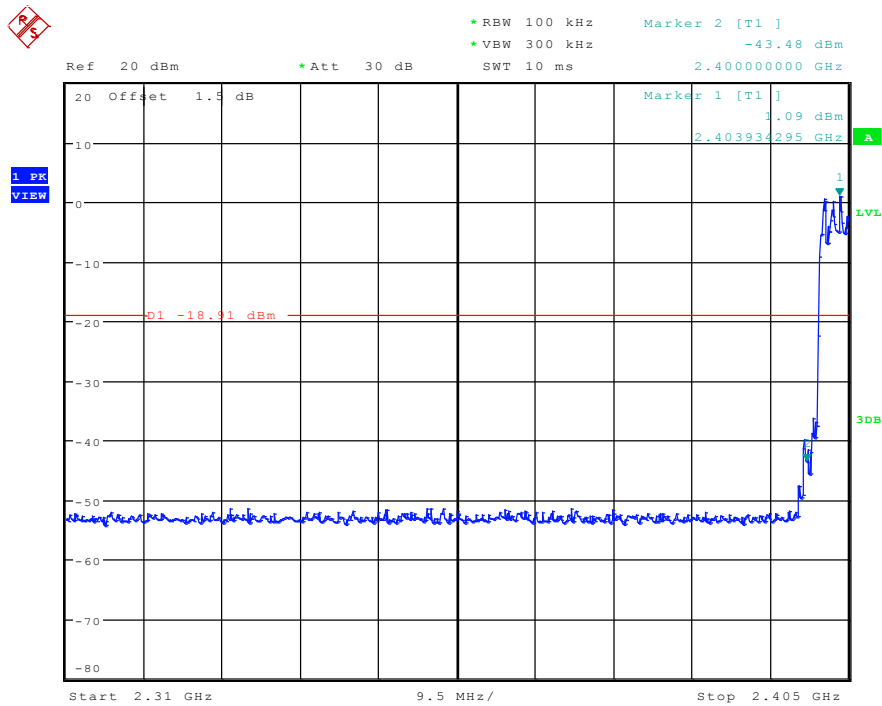
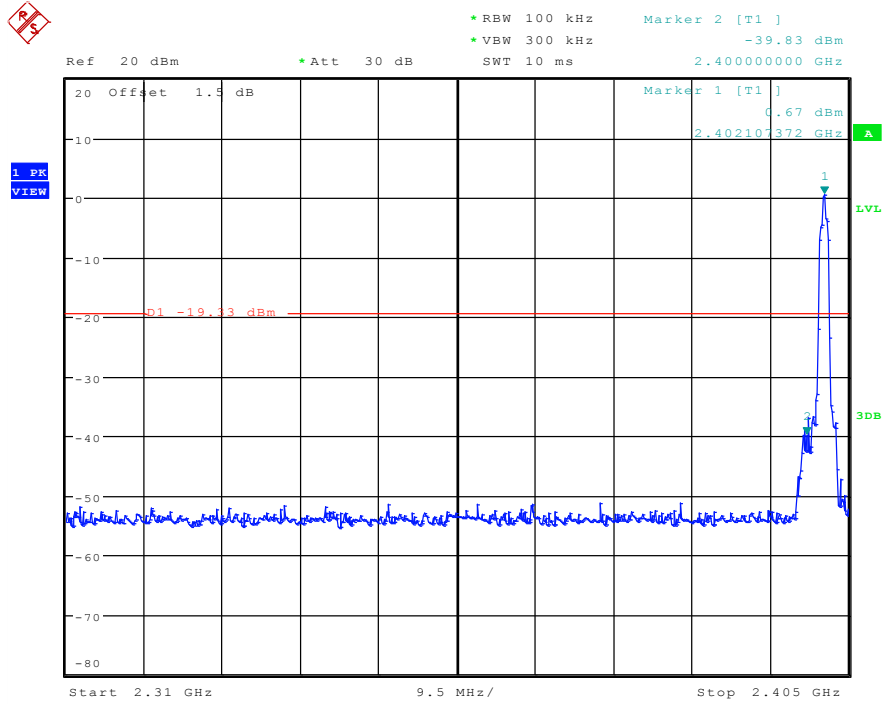

Test mode:	$\pi/4$ DQPSK	Test channel:	Highest
------------	---------------	---------------	---------

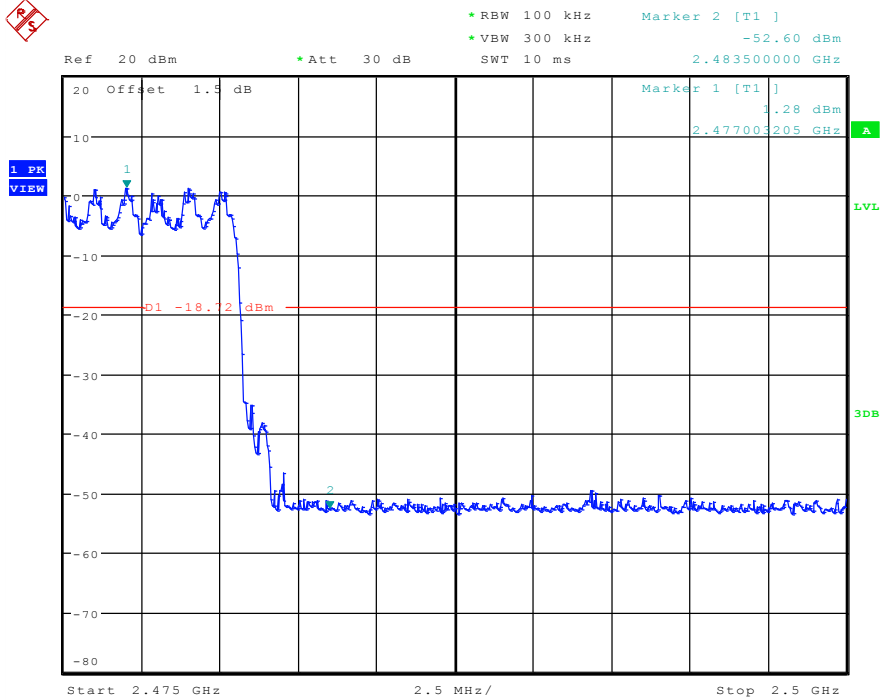
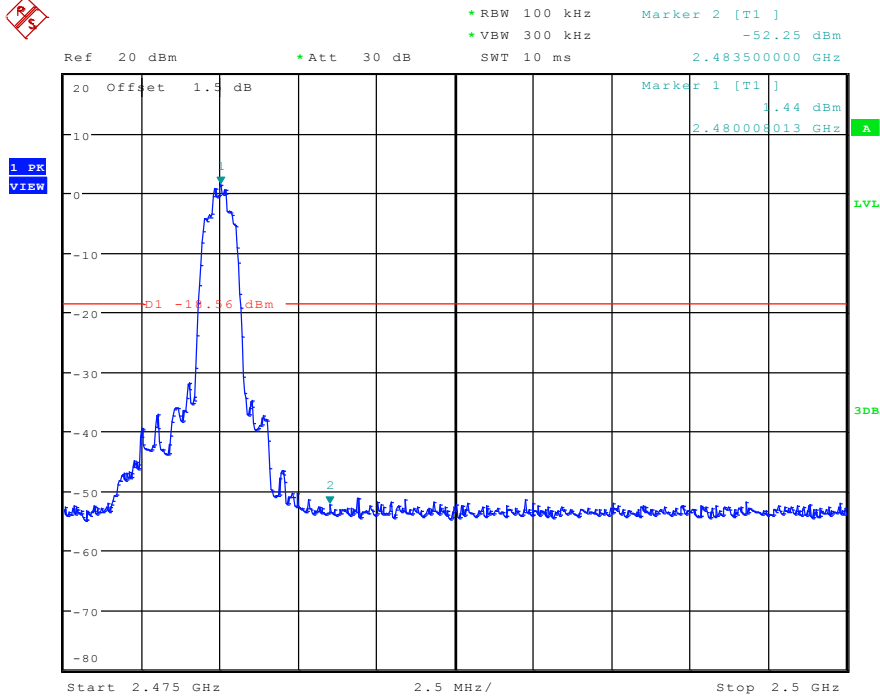

Test mode:	8DPSK	Test channel:	Lowest
------------	-------	---------------	--------

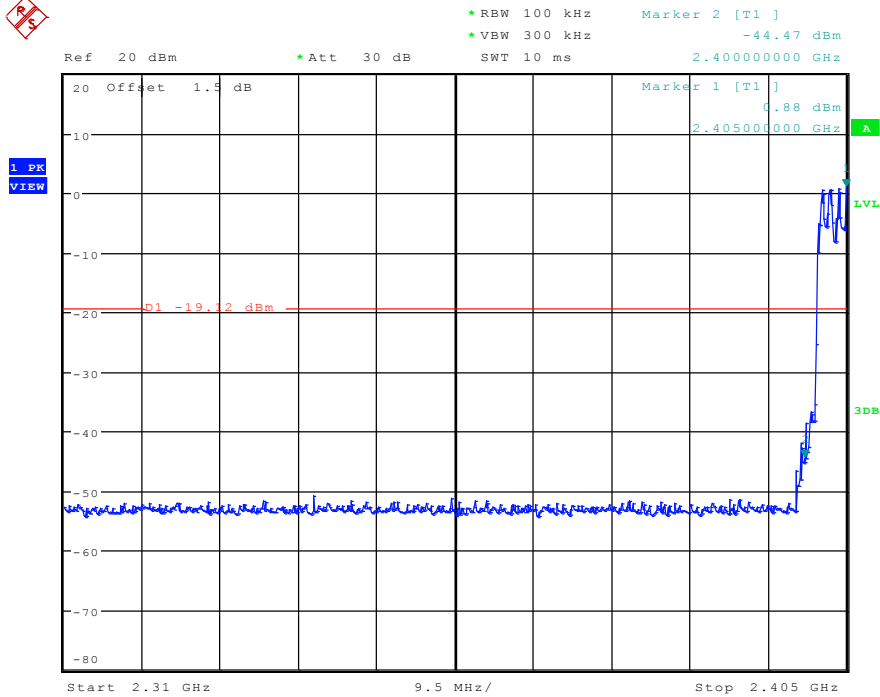
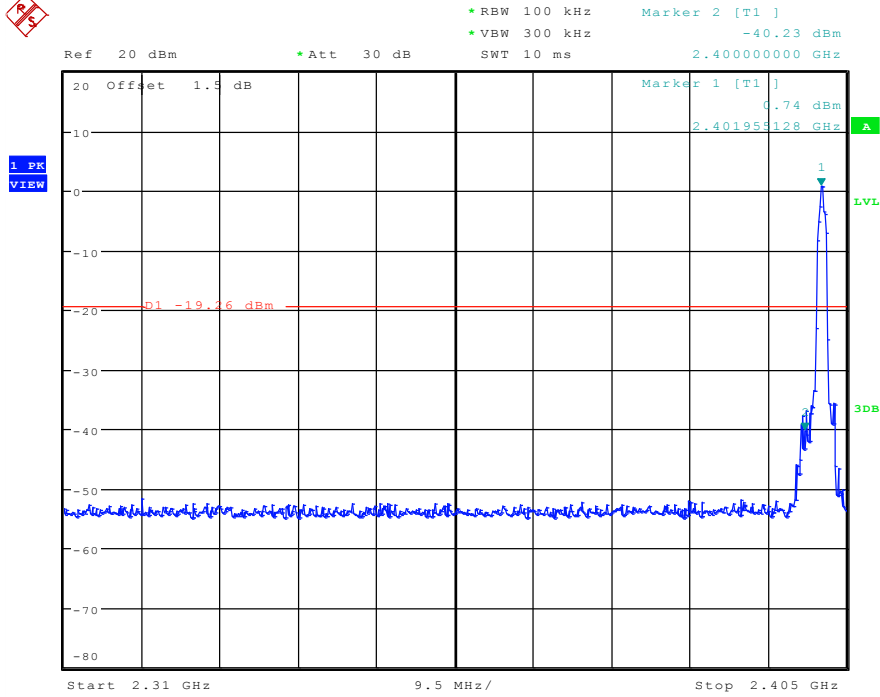

Test mode:	8DPSK	Test channel:	Highest
------------	-------	---------------	---------

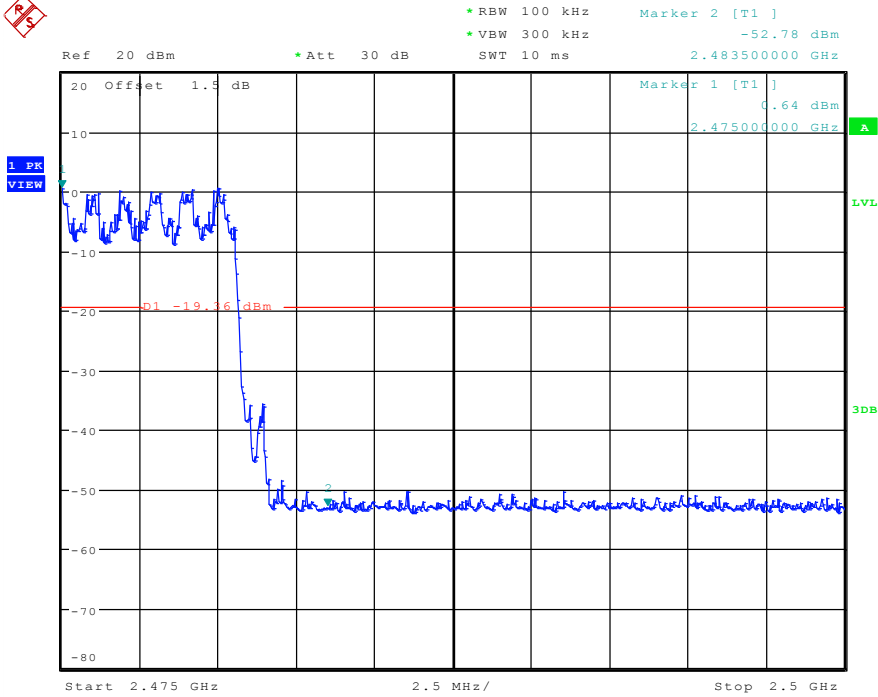
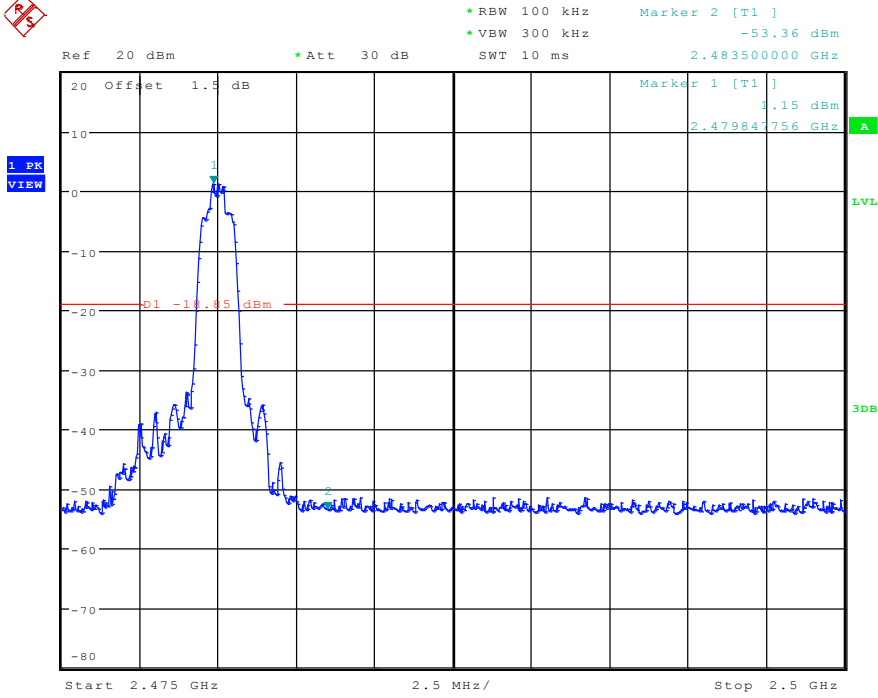

5.9 Spurious RF Conducted Emissions

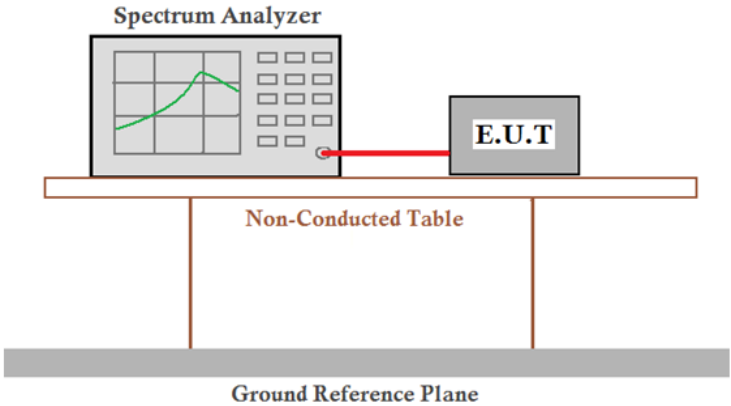
Test Requirement:	47 CFR Part 15C Section 15.247 (d)
Test Method:	ANSI C63.10:2013
Test Setup:	 <p>Remark: Factor: the High-Frequency cable loss 1.5dB in the spectrum analyzer.</p>
Limit:	In any 100 kHz bandwidth outside the frequency band in which the spread spectrum intentional radiator is operating, the radio frequency power that is produced by the intentional radiator shall be at least 20 dB below that in the 100 kHz bandwidth within the band that contains the highest level of the desired power, based on either an RF conducted or a radiated measurement.
Exploratory Test Mode:	Non-hopping transmitting with all kind of modulation and all kind of data type
Final Test Mode:	Through Pre-scan, find the DH1 of data type is the worst case of GFSK modulation type, 2-DH1 of data type is the worst case of $\pi/4$ DQPSK modulation type, 3-DH1 of data type is the worst case of 8DPSK modulation type.
Instruments Used:	Refer to section 5.10 for details
Test Results:	Pass

Test mode:	GFSK	Test channel:	Lowest
------------	------	---------------	--------

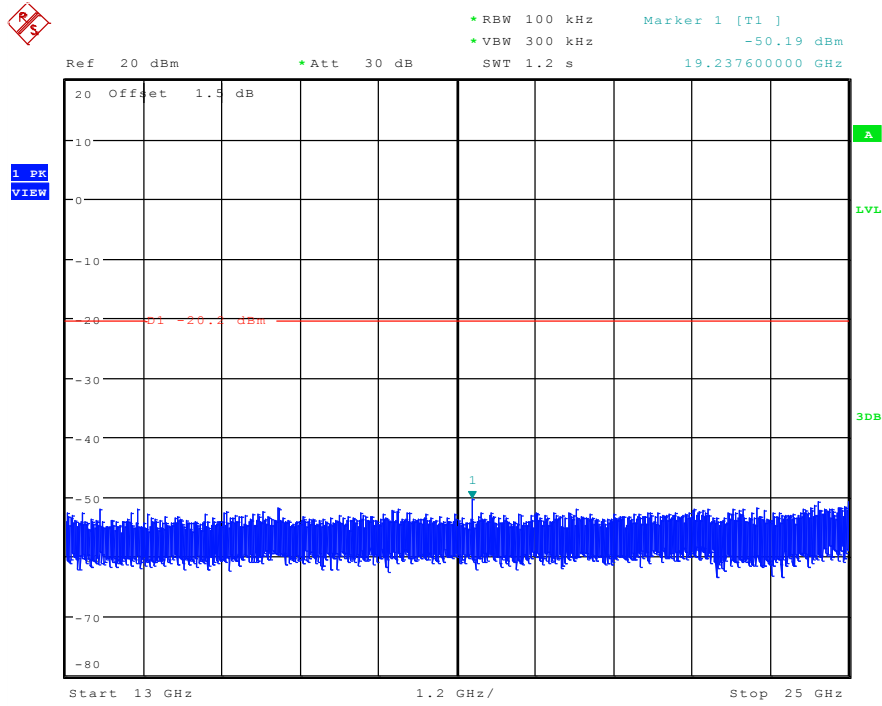
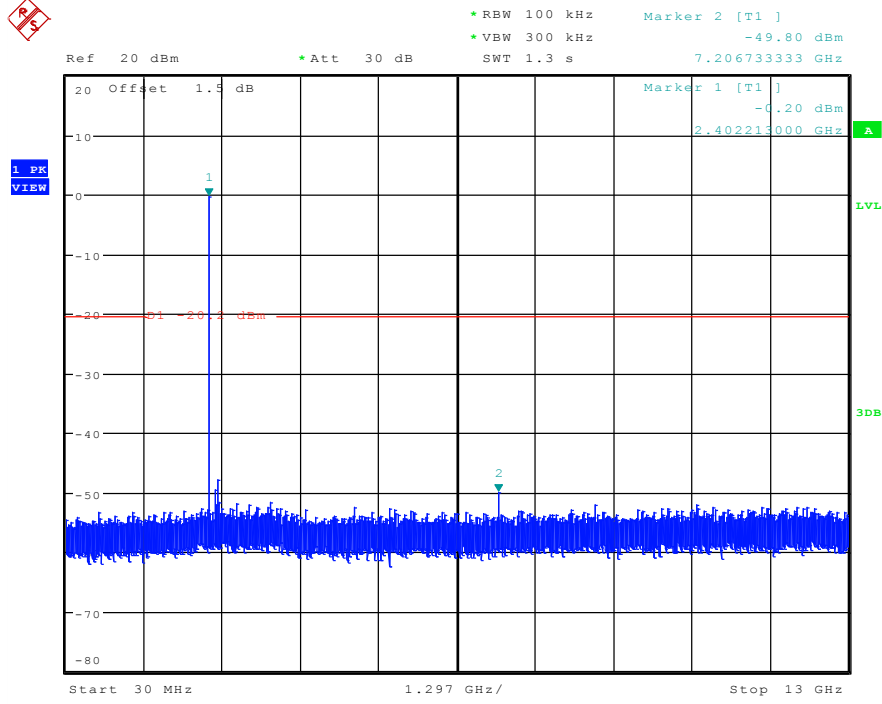

Test mode:	GFSK	Test channel:	Highest
------------	------	---------------	---------



Ref 20 dBm *Att 30 dB *RBW 100 kHz Marker 1 [T1] -0.23 dBm
 *VBW 300 kHz SWT 1.3 s 2.479600667 GHz

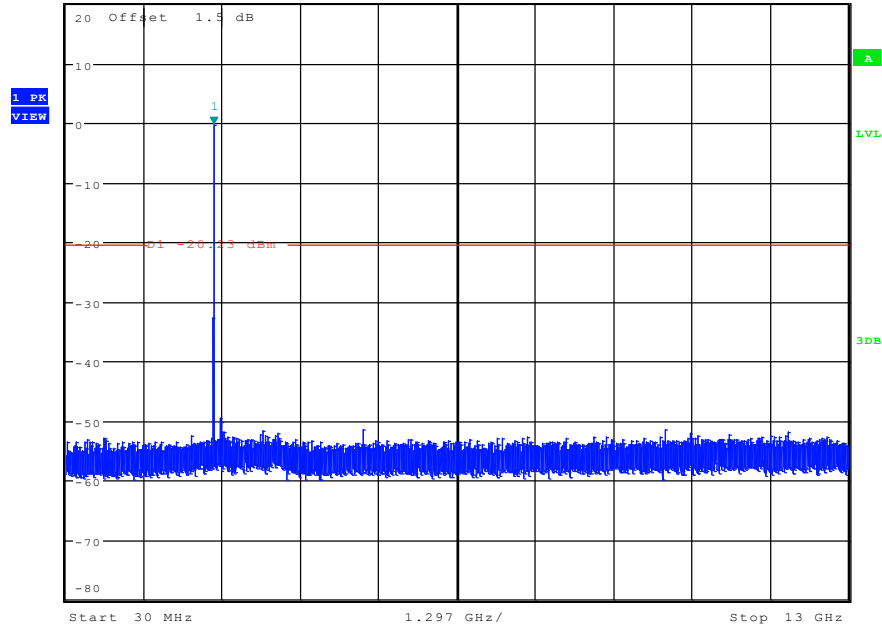

Ref 20 dBm *Att 30 dB *RBW 100 kHz Marker 1 [T1] -51.33 dBm
 *VBW 300 kHz SWT 1.2 s 17.196000000 GHz

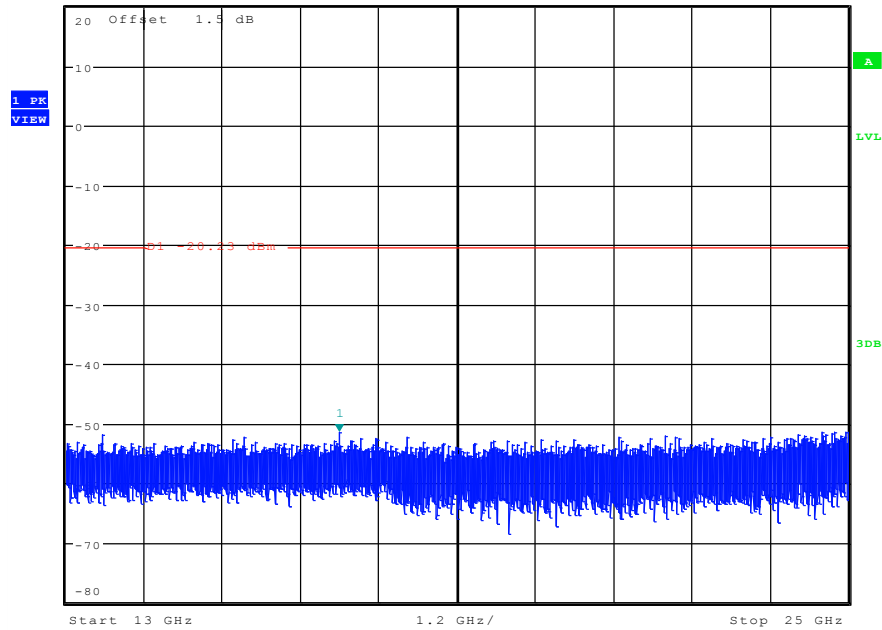

Test mode:	$\pi/4$ DQPSK	Test channel:	Highest
------------	---------------	---------------	---------



* RBW 100 kHz Marker 1 [T1] 0.05 dBm
 * VBW 300 kHz
 Ref 20 dBm * Att 30 dB SWT 1.3 s 2.480033000 GHz

1 PK
VIEW

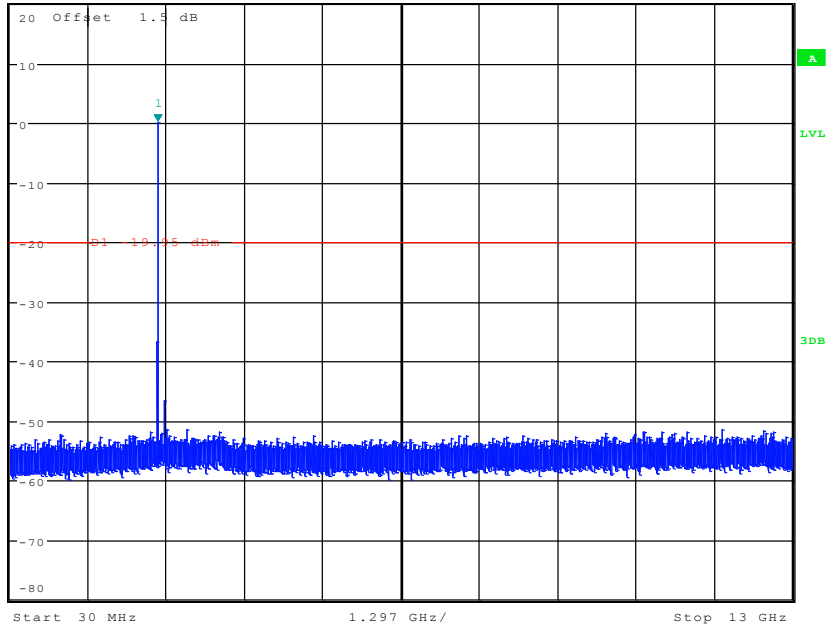

* RBW 100 kHz Marker 1 [T1] -50.95 dBm
 * VBW 300 kHz
 Ref 20 dBm * Att 30 dB SWT 1.2 s 22.520800000 GHz

1 PK
VIEW

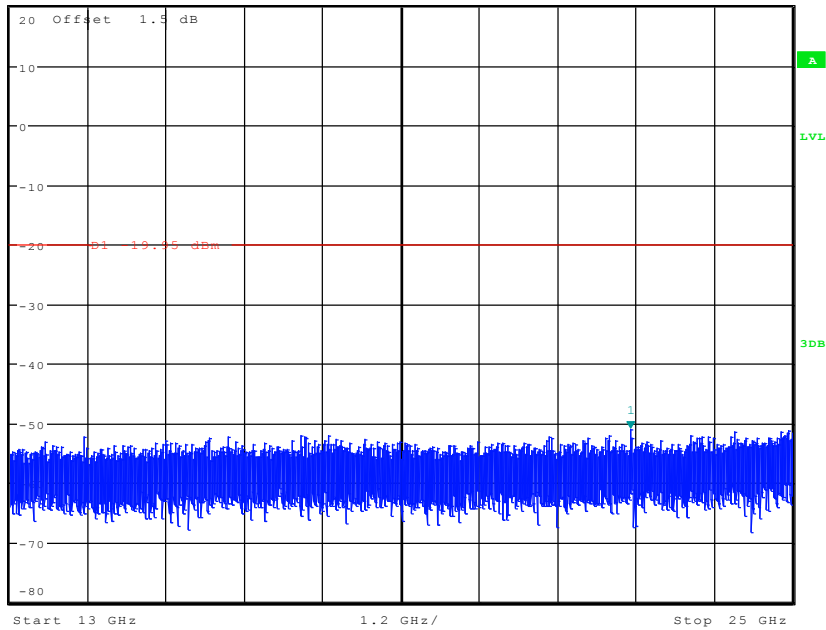

Test mode:	8DPSK	Test channel:	Lowest
------------	-------	---------------	--------

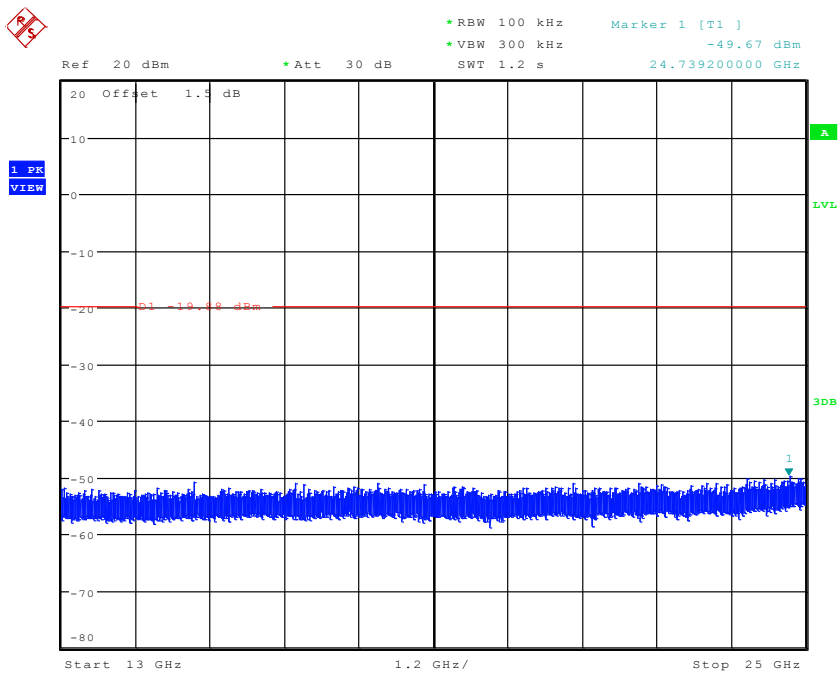
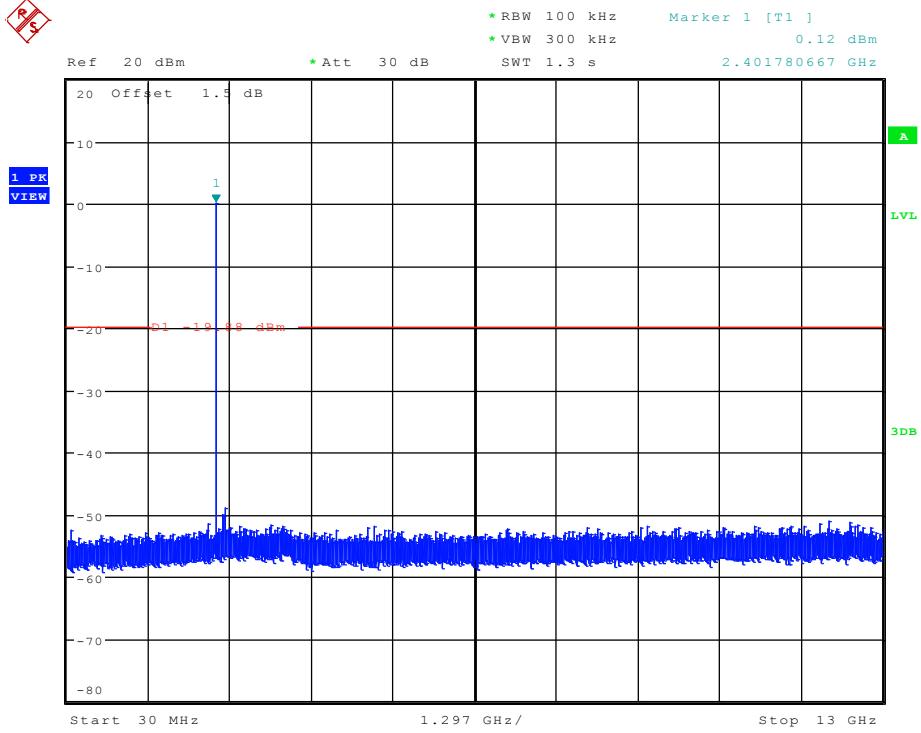

Test mode:	8DPSK	Test channel:	Middle
------------	-------	---------------	--------

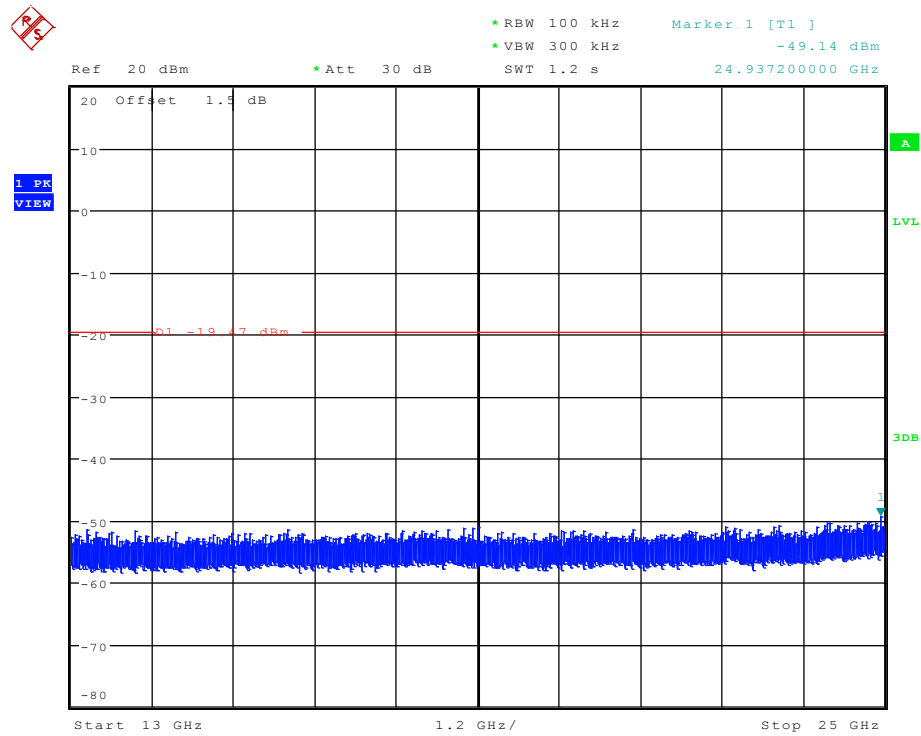
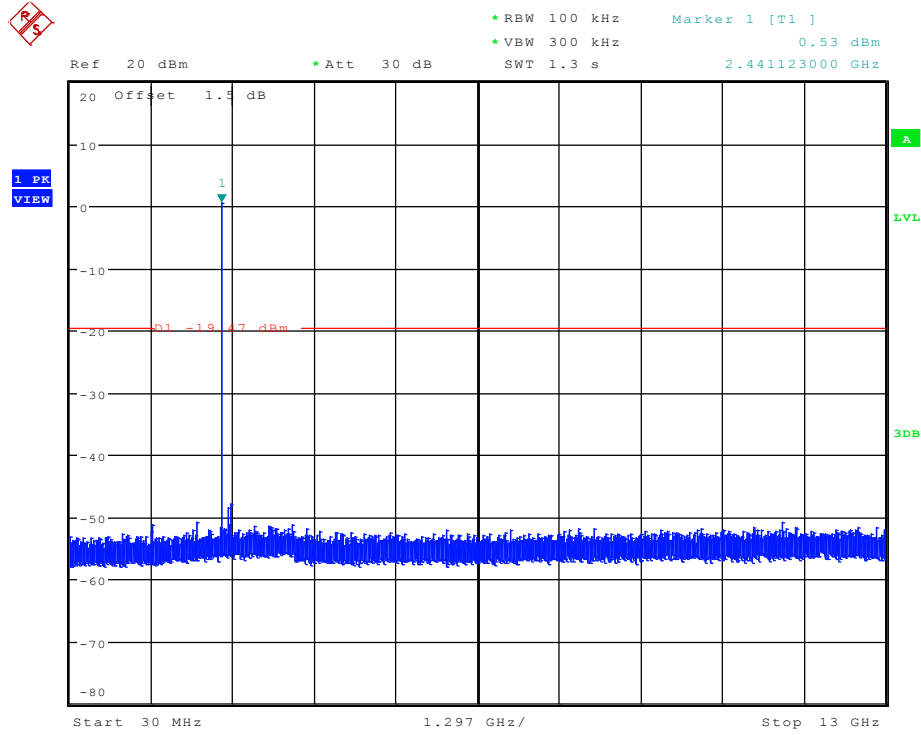

Test mode:	8DPSK	Test channel:	Highest
------------	-------	---------------	---------

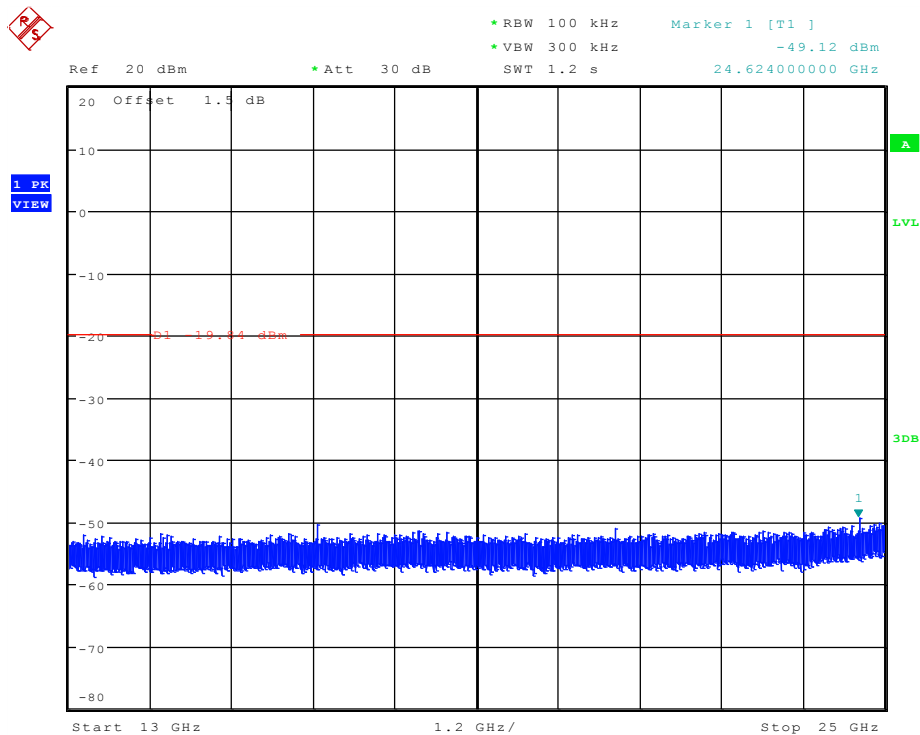
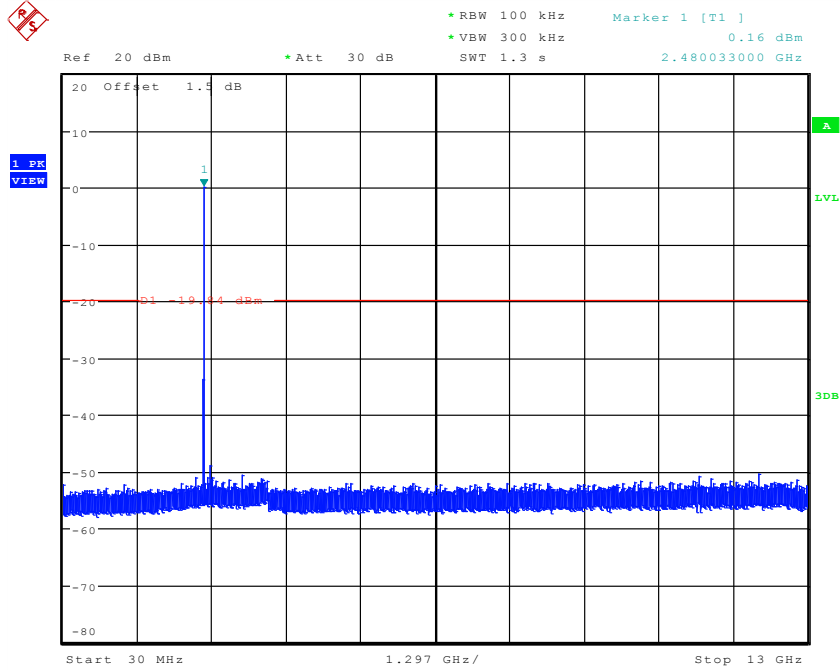

Pre test 9kHz to 25GHz, find the highest point when testing, so only the worst data were shown in the test report. Per FCC Part 15.33 (a) and 15.31 (o), The amplitude of spurious emissions from intentional radiators which are attenuated more than 20 dB below the permissible value need not be reported unless specifically required elsewhere in this part.

5.10 Other requirements Frequency Hopping Spread Spectrum System

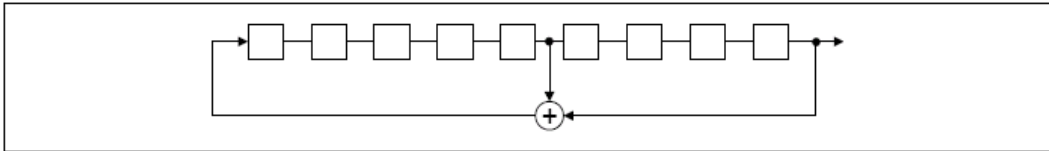
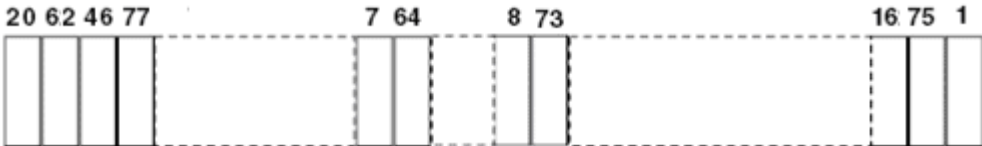
Test Requirement:	47 CFR Part 15C Section 15.247 (a)(1), (h) requirement:
	<p>The system shall hop to channel frequencies that are selected at the system hopping rate from a Pseudorandom ordered list of hopping frequencies. Each frequency must be used equally on the average by each transmitter. The system receivers shall have input bandwidths that match the hopping channel bandwidths of their corresponding transmitters and shall shift frequencies in synchronization with the transmitted signals.</p> <p>Frequency hopping spread spectrum systems are not required to employ all available hopping channels during each transmission. However, the system, consisting of both the transmitter and the receiver, must be designed to comply with all of the regulations in this section should the transmitter be presented with a continuous data (or information) stream. In addition, a system employing short transmission bursts must comply with the definition of a frequency hopping system and must distribute its transmissions over the minimum number of hopping channels specified in this section.</p> <p>The incorporation of intelligence within a frequency hopping spread spectrum system that permits the system to recognize other users within the spectrum band so that it individually and independently chooses and adapts its hopsets to avoid hopping on occupied channels is permitted. The coordination of frequency hopping systems in any other manner for the express purpose of avoiding the simultaneous occupancy of individual hopping frequencies by multiple transmitters is not permitted.</p>
	<p>Compliance for section 15.247(a)(1)</p>
	<p>According to Bluetooth Core Specification, the pseudorandom sequence may be generated in a nine-stage shift register whose 5th and 9th stage outputs are added in a modulo-two addition stage. And the result is fed back to the input of the first stage. The sequence begins with the first ONE of 9 consecutive ONES; i.e. the shift register is initialized with nine ones.</p> <ul style="list-style-type: none"> • Number of shift register stages: 9 • Length of pseudo-random sequence: $2^9 - 1 = 511$ bits • Longest sequence of zeros: 8 (non-inverted signal) <div data-bbox="301 1377 1355 1527" data-label="Diagram">  </div> <p style="text-align: center;"><i>Linear Feedback Shift Register for Generation of the PRBS sequence</i></p> <p>An example of Pseudorandom Frequency Hopping Sequence as follow:</p> <div data-bbox="276 1626 1262 1771" data-label="Diagram">  </div> <p>Each frequency used equally on the average by each transmitter.</p> <p>According to Bluetooth Core Specification, Bluetooth receivers are designed to have input and IF bandwidths that match the hopping channel bandwidths of any Bluetooth transmitters and shift frequencies in synchronization with the transmitted signals.</p>
	<p>Compliance for section 15.247(g)</p>
	<p>According to Bluetooth Core Specification, the Bluetooth system transmits the packet with the pseudorandom hopping frequency with a continuous data and the short burst transmission from the Bluetooth system is also transmitted under the frequency hopping system with the pseudorandom hopping frequency system.</p>

Compliance for section 15.247(h)

According to Bluetooth Core specification, the Bluetooth system incorporates with an adaptive system to detect other user within the spectrum band so that it individually and independently to avoid hopping on the occupied channels.

According to the Bluetooth Core specification, the Bluetooth system is designed not have the ability to coordinated with other FHSS System in an effort to avoid the simultaneous occupancy of individual hopping frequencies by multiple transmitter.

5.11 Radiated Spurious Emission

Test Requirement:	47 CFR Part 15C Section 15.209 and 15.205				
Test Method:	ANSI C63.10: 2013				
Test Site:	Measurement Distance: 3m (Semi-Anechoic Chamber)				
Receiver Setup:	Frequency	Detector	RBW	VBW	Remark
	0.009MHz-0.090MHz	Peak	10kHz	30kHz	Peak
	0.009MHz-0.090MHz	Average	10kHz	30kHz	Average
	0.090MHz-0.110MHz	Quasi-peak	10kHz	30kHz	Quasi-peak
	0.110MHz-0.490MHz	Peak	10kHz	30kHz	Peak
	0.110MHz-0.490MHz	Average	10kHz	30kHz	Average
	0.490MHz -30MHz	Quasi-peak	10kHz	30kHz	Quasi-peak
	30MHz-1GHz	Peak	100 kHz	300kHz	Peak
	Above 1GHz	Peak	1MHz	3MHz	Peak
Peak		1MHz	10Hz	Average	
Limit:	Frequency	Field strength (microvolt/meter)	Limit (dBuV/m)	Remark	Measurement distance (m)
	0.009MHz-0.490MHz	2400/F(kHz)	-	-	300
	0.490MHz-1.705MHz	24000/F(kHz)	-	-	30
	1.705MHz-30MHz	30	-	-	30
	30MHz-88MHz	100	40.0	Quasi-peak	3
	88MHz-216MHz	150	43.5	Quasi-peak	3
	216MHz-960MHz	200	46.0	Quasi-peak	3
	960MHz-1GHz	500	54.0	Quasi-peak	3
	Above 1GHz	500	54.0	Average	3
	Note: 15.35(b), Unless otherwise specified, the limit on peak radio frequency emissions is 20dB above the maximum permitted average emission limit applicable to the equipment under test. This peak limit applies to the total peak emission level radiated by the device.				

Test Setup:

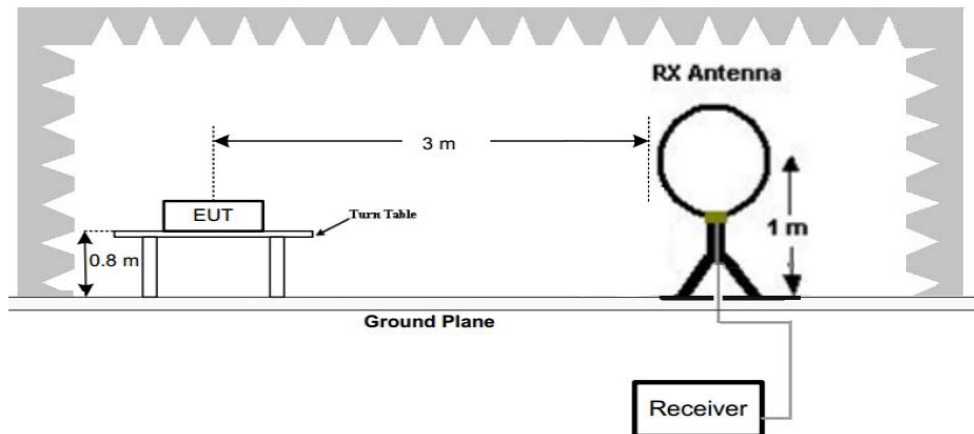

Figure 1. Below 30MHz

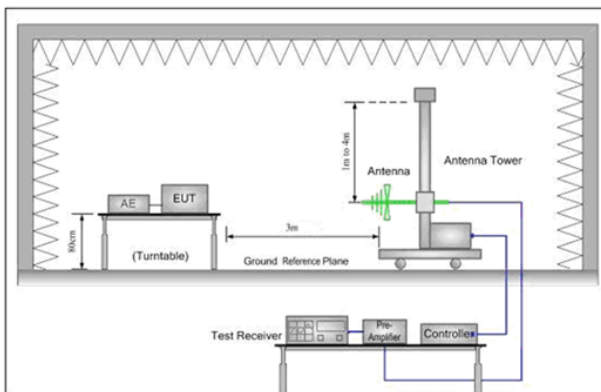

Figure 2. 30MHz to 1GHz

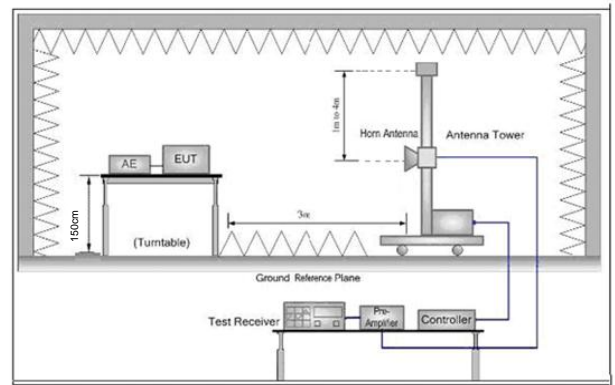

Figure 3. Above 1 GHz

Test Procedure:

- a.
 - 1) Below 1G: The EUT was placed on the top of a rotating table 0.8 meters above the ground at a 3 meter semi-anechoic chamber. The table was rotated 360 degrees to determine the position of the highest radiation.
 - 2) Above 1G: The EUT was placed on the top of a rotating table 1.5 meters above the ground at a 3 meter semi-anechoic chamber. The table was rotated 360 degrees to determine the position of the highest radiation.

Note: For the radiated emission test above 1GHz:
Place the measurement antenna away from each area of the EUT determined to be a source of emissions at the specified measurement distance, while keeping the measurement antenna aimed at the source of emissions at each frequency of significant emissions, with polarization oriented for maximum response. The measurement antenna may have to be higher or lower than the EUT, depending on the radiation pattern of the emission and staying aimed at the emission source for receiving the maximum signal. The final measurement antenna elevation shall be that which maximizes the emissions. The measurement antenna elevation for maximum emissions shall be restricted to a range of heights of from 1 m to 4 m above the ground or reference ground plane.
- b. The EUT was set 3 meters away from the interference-receiving antenna, which was mounted on the top of a variable-height antenna tower.
- c. The antenna height is varied from one meter to four meters above the ground to determine the maximum value of the field strength. Both horizontal and vertical polarizations of the antenna are set to make the measurement.

	<p>d. For each suspected emission, the EUT was arranged to its worst case and then the antenna was tuned to heights from 1 meter to 4 meters (for the test frequency of below 30MHz, the antenna was tuned to heights 1 meter) and the rotatable table was turned from 0 degrees to 360 degrees to find the maximum reading.</p> <p>e. The test-receiver system was set to Peak Detect Function and Specified Bandwidth with Maximum Hold Mode.</p> <p>f. If the emission level of the EUT in peak mode was 10dB lower than the limit specified, then testing could be stopped and the peak values of the EUT would be reported. Otherwise the emissions that did not have 10dB margin would be re-tested one by one using peak, quasi-peak or average method as specified and then reported in a data sheet.</p> <p>g. Test the EUT in the lowest channel (2402MHz), the middle channel (2441MHz), the Highest channel (2480MHz)</p> <p>h. The radiation measurements are performed in X, Y, Z axis positioning for Transmitting mode, and found the X axis positioning which it is the worst case.</p> <p>i. Repeat above procedures until all frequencies measured was complete.</p>
Exploratory Test Mode:	Non-hopping transmitting mode with all kind of modulation and all kind of data type
Final Test Mode:	Through Pre-scan, find the DH1 of data type and GFSK modulation is the worst case. Pretest the EUT at Transmitting mode, For below 1GHz part, through pre-scan, the worst case is the lowest channel. Only the worst case is recorded in the report.
Instruments Used:	Refer to section 5.10 for details
Test Results:	Pass

5.11.1 Radiated Emission below 1GHz

30MHz~1GHz (PEAK)		
Test mode:	Transmitting	Vertical

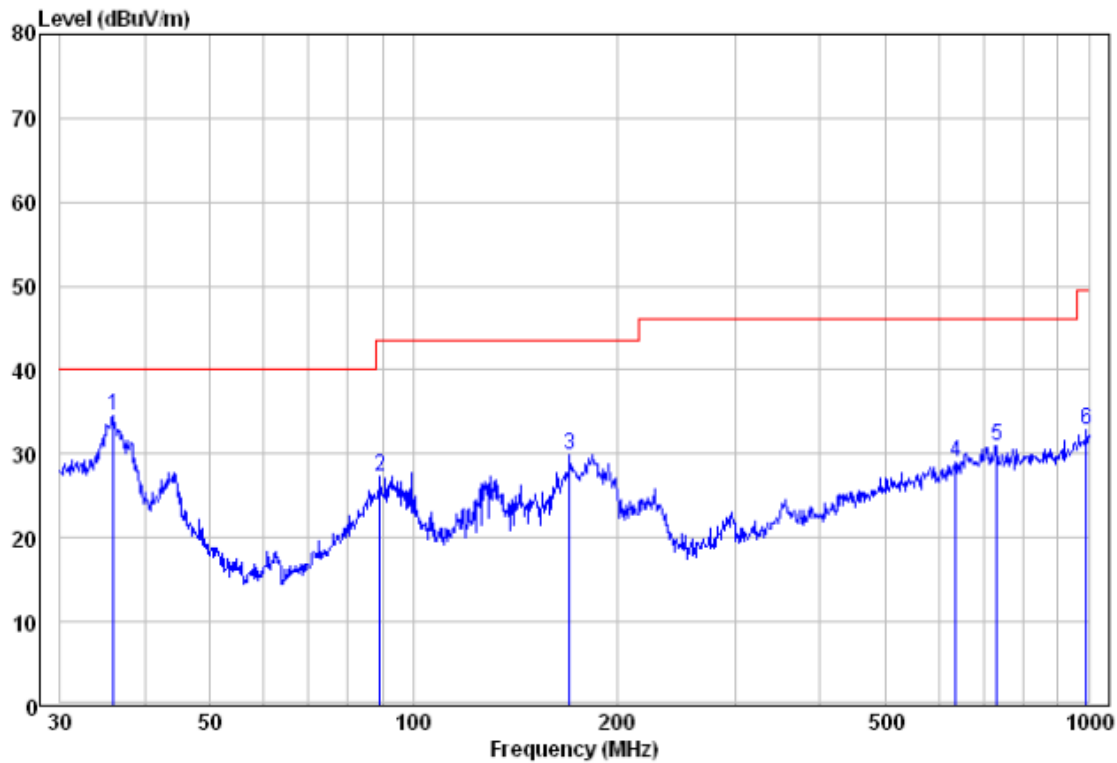

	Freq	Read Level	Factor	Level	Limit Line	Over Limit	Remark	Pol/Phase
	MHz	dBuV	dB/m	dBuV/m	dBuV/m	dB		
1 pp	36.00	16.79	17.80	34.59	40.00	-5.41	Peak	VERTICAL
2	89.28	17.17	10.11	27.28	43.50	-16.22	Peak	VERTICAL
3	170.19	22.17	7.64	29.81	43.50	-13.69	Peak	VERTICAL
4	636.13	9.87	19.09	28.96	46.00	-17.04	Peak	VERTICAL
5	731.92	10.94	20.03	30.97	46.00	-15.03	Peak	VERTICAL
6	993.01	10.13	22.72	32.85	49.50	-16.65	Peak	VERTICAL

Test mode:	Transmitting	Horizontal
------------	--------------	------------

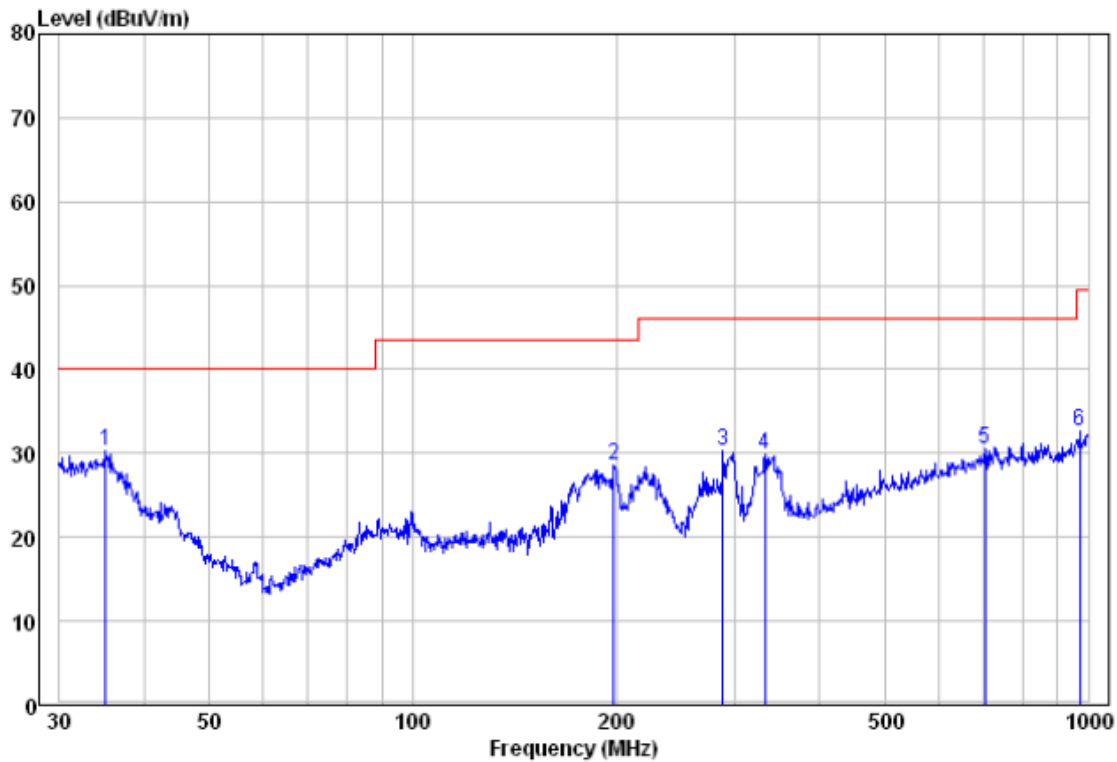

	Read Freq	Read Level	Factor	Level	Limit Line	Over Limit	Remark	Pol/Phase
	MHz	dBuV	dB/m	dBuV/m	dBuV/m	dB		
1 pp	35.13	11.79	18.41	30.20	40.00	-9.80	Peak	HORIZONTAL
2	198.59	20.23	8.33	28.56	43.50	-14.94	Peak	HORIZONTAL
3	287.99	20.00	10.21	30.21	46.00	-15.79	Peak	HORIZONTAL
4	332.52	17.84	12.01	29.85	46.00	-16.15	Peak	HORIZONTAL
5	704.23	10.79	19.73	30.52	46.00	-15.48	Peak	HORIZONTAL
6	972.34	10.48	22.08	32.56	49.50	-16.94	Peak	HORIZONTAL

5.11.2 Transmitter Emission above 1GHz

Worse case mode:	GFSK(DH1)	Test channel:	Lowest
------------------	-----------	---------------	--------

Frequency (MHz)	Meter Reading (dB μ V)	Factor (dB)	Emission Level (dB μ V/m)	Limits (dB μ V/m)	Over (dB)	Detector Type	Ant. Pol. H/V
4804	48.58	-5.18	43.40	74	-30.60	peak	H
4804	38.89	-5.18	33.71	54	-20.29	AVG	H
7206	49.36	-6.45	42.91	74	-31.09	peak	H
7206	35.71	-6.45	29.26	54	-24.74	AVG	H
4804	49.99	-5.18	44.81	74	-29.19	peak	V
4804	36.67	-5.18	31.49	54	-22.51	AVG	V
7206	49.88	-6.45	43.43	74	-30.57	peak	V
7206	35.04	-6.45	28.59	54	-25.41	AVG	V

Worse case mode:	GFSK(DH1)	Test channel:	Middle
------------------	-----------	---------------	--------

Frequency (MHz)	Meter Reading (dB μ V)	Factor (dB)	Emission Level (dB μ V/m)	Limits (dB μ V/m)	Over (dB)	Detector Type	Ant. Pol. H/V
4882	49.08	-5.19	43.89	74	-30.11	peak	H
4882	36.36	-5.19	31.17	54	-22.83	AVG	H
7323	48.28	-6.47	41.81	74	-32.19	peak	H
7323	36.68	-6.47	30.21	54	-23.79	AVG	H
4882	48.60	-5.19	43.41	74	-30.59	peak	V
4882	37.07	-5.19	31.88	54	-22.12	AVG	V
7323	49.25	-6.47	42.78	74	-31.22	peak	V
7323	35.00	-6.47	28.53	54	-25.47	AVG	V

Worse case mode:	GFSK(DH1)	Test channel:	Highest
------------------	-----------	---------------	---------

Frequency (MHz)	Meter Reading (dB μ V)	Factor (dB)	Emission Level (dB μ V/m)	Limits (dB μ V/m)	Over (dB)	Detector Type	Ant. Pol. H/V
4960	50.02	-5.2	44.82	74	-29.18	peak	H
4960	37.86	-5.2	32.66	54	-21.34	AVG	H
7440	50.30	-6.47	43.83	74	-30.17	peak	H
7440	37.85	-6.47	31.38	54	-22.62	AVG	H
4960	51.21	-5.2	46.01	74	-27.99	peak	V
4960	37.78	-5.2	32.58	54	-21.42	AVG	V
7440	50.78	-6.47	44.31	74	-29.69	peak	V
7440	37.55	-6.47	31.08	54	-22.92	AVG	V

Remark:

- 1) The field strength is calculated by adding the Antenna Factor, Cable Factor & Preamplifier. The basic equation with a sample calculation is as follows:
 Final Test Level = Receiver Reading + Antenna Factor + Cable Factor – Preamplifier Factor
- 2) Scan from 9kHz to 25GHz, the disturbance above 13GHz and below 30MHz was very low, and the above harmonics were the highest point could be found when testing, so only the above harmonics had been displayed. The amplitude of spurious emissions from the radiator which are attenuated more than 20dB below the limit need not be reported.

5.12 Restricted bands around fundamental frequency

Test Requirement:	47 CFR Part 15C Section 15.209 and 15.205		
Test Method:	ANSI C63.10: 2013		
Test Site:	Measurement Distance: 3m (Semi-Anechoic Chamber)		
Limit:	Frequency	Limit (dBuV/m @3m)	Remark
	30MHz-88MHz	40.0	Quasi-peak Value
	88MHz-216MHz	43.5	Quasi-peak Value
	216MHz-960MHz	46.0	Quasi-peak Value
	Above 1GHz	54.0	Average Value
		74.0	Peak Value
Test Setup:			

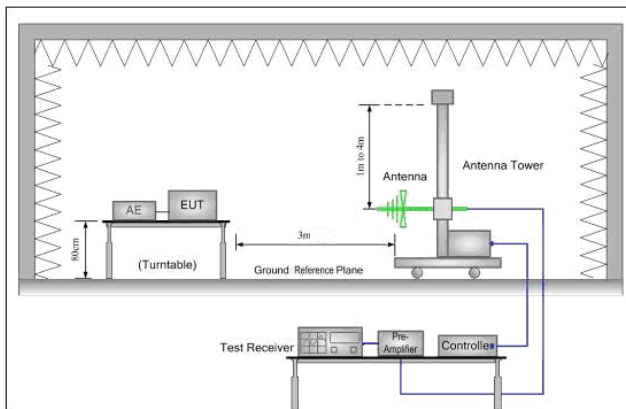

Figure 1. 30MHz to 1GHz

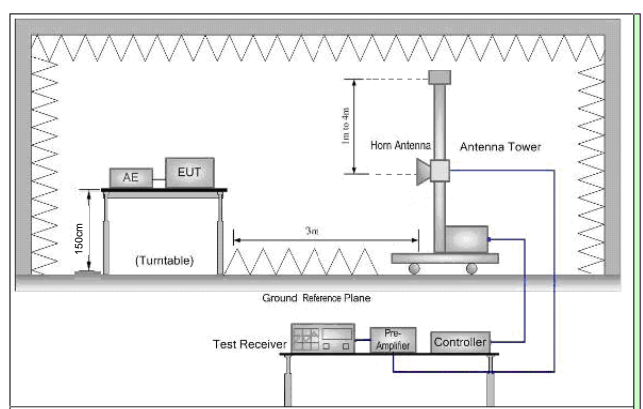

Figure 2. Above 1 GHz

<p>Test Procedure:</p>	<p>a. 1) Below 1G: The EUT was placed on the top of a rotating table 0.8 meters above the ground at a 3 meter semi-anechoic chamber. The table was rotated 360 degrees to determine the position of the highest radiation. 2) Above 1G: The EUT was placed on the top of a rotating table 1.5 meters above the ground at a 3 meter semi-anechoic chamber. The table was rotated 360 degrees to determine the position of the highest radiation. Note: For the radiated emission test above 1GHz: Place the measurement antenna away from each area of the EUT determined to be a source of emissions at the specified measurement distance, while keeping the measurement antenna aimed at the source of emissions at each frequency of significant emissions, with polarization oriented for maximum response. The measurement antenna may have to be higher or lower than the EUT, depending on the radiation pattern of the emission and staying aimed at the emission source for receiving the maximum signal. The final measurement antenna elevation shall be that which maximizes the emissions. The measurement antenna elevation for maximum emissions shall be restricted to a range of heights of from 1 m to 4 m above the ground or reference ground plane.</p> <p>b. The EUT was set 3 meters away from the interference-receiving antenna, which was mounted on the top of a variable-height antenna tower.</p> <p>c. The antenna height is varied from one meter to four meters above the ground to determine the maximum value of the field strength. Both horizontal and vertical polarizations of the antenna are set to make the measurement.</p> <p>d. For each suspected emission, the EUT was arranged to its worst case and then the antenna was tuned to heights from 1 meter to 4 meters and the rotatable table was turned from 0 degrees to 360 degrees to find the maximum reading.</p> <p>e. The test-receiver system was set to Peak Detect Function and Specified Bandwidth with Maximum Hold Mode.</p> <p>f. Place a marker at the end of the restricted band closest to the transmit frequency to show compliance. Also measure any emissions in the restricted bands. Save the spectrum analyzer plot. Repeat for each power and modulation for lowest and highest channel</p> <p>g. Test the EUT in the lowest channel , the Highest channel</p> <p>h. The radiation measurements are performed in X, Y, Z axis positioning for Transmitting mode, and found the X axis positioning which it is the worst case.</p> <p>i. Repeat above procedures until all frequencies measured was complete.</p>
<p>Exploratory Test Mode:</p>	<p>Non-hopping transmitting mode with all kind of modulation and all kind of data type</p>
<p>Final Test Mode:</p>	<p>Through Pre-scan, find the DH5 of data type and GFSK modulation is the worst case. Pretest the EUT at Transmitting mode, found the Transmitting mode which it is worse case Only the worst case is recorded in the report.</p>
<p>Instruments Used:</p>	<p>Refer to section 5.10 for details</p>
<p>Test Results:</p>	<p>Pass</p>

Worse case mode:	GFSK(DH5)	Test channel:	Lowest
------------------	-----------	---------------	--------

Frequency (MHz)	Meter Reading (dB μ V)	Factor (dB)	Emission Level (dB μ V/m)	Limits (dB μ V/m)	Over (dB)	Detector Type	Ant. Pol. H/V
2390	49.03	-4.36	44.67	74	-29.33	peak	H
2390	35.34	-4.36	30.98	54	-23.02	AVG	H
2400	53.02	-4.36	48.66	74	-25.34	peak	H
2400	40.11	-4.36	35.75	54	-18.25	AVG	H
2390	46.45	-4.36	42.09	74	-31.91	peak	V
2390	34.77	-4.36	30.41	54	-23.59	AVG	V
2400	53.31	-4.36	48.95	74	-25.05	peak	V
2400	42.00	-4.36	37.64	54	-16.36	AVG	V

Worse case mode:	GFSK(DH5)	Test channel:	Highest
------------------	-----------	---------------	---------

Frequency (MHz)	Meter Reading (dB μ V)	Factor (dB)	Emission Level (dB μ V/m)	Limits (dB μ V/m)	Over (dB)	Detector Type	Ant. Pol. H/V
2483.5	61.35	-4.22	57.13	74	-16.87	peak	H
2483.5	47.42	-4.22	43.20	54	-10.80	AVG	H
2483.5	59.92	-4.22	55.70	74	-18.30	peak	V
2483.5	46.35	-4.22	42.13	54	-11.87	AVG	V

Note:

The field strength is calculated by adding the Antenna Factor, Cable Factor & Preamplifier. The basic equation with a sample calculation is as follows:

Final Test Level = Receiver Reading + Antenna Factor + Cable Factor – Preamplifier Factor

6 Photographs - EUT Test Setup

6.1 Conducted Emission



6.2 Radiated Emission

9KHz~30MHz:



30MHz~1GHz:

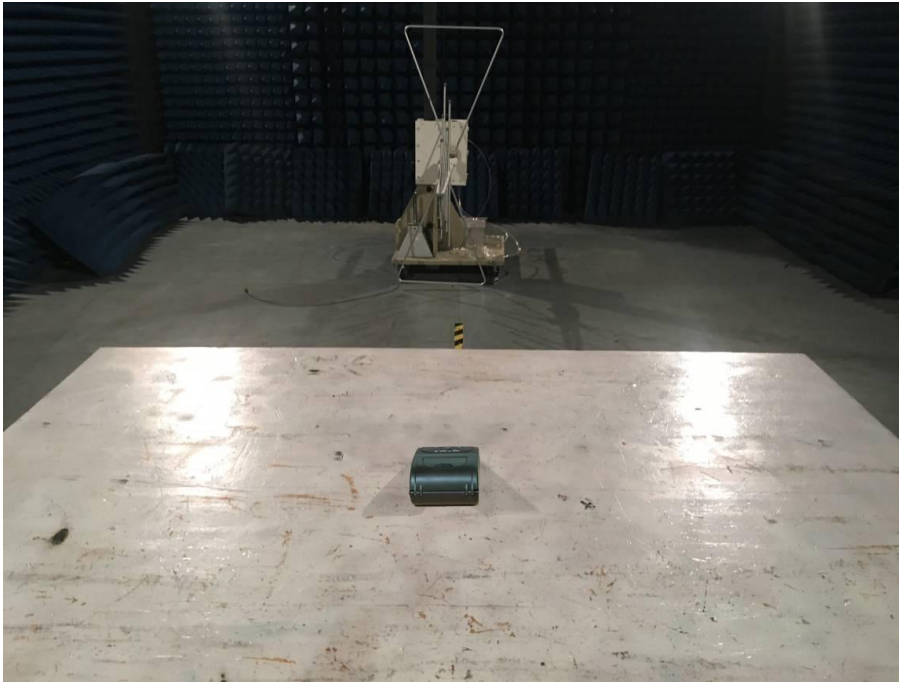

Above 1GHz:



7 Photographs - EUT Constructional Details



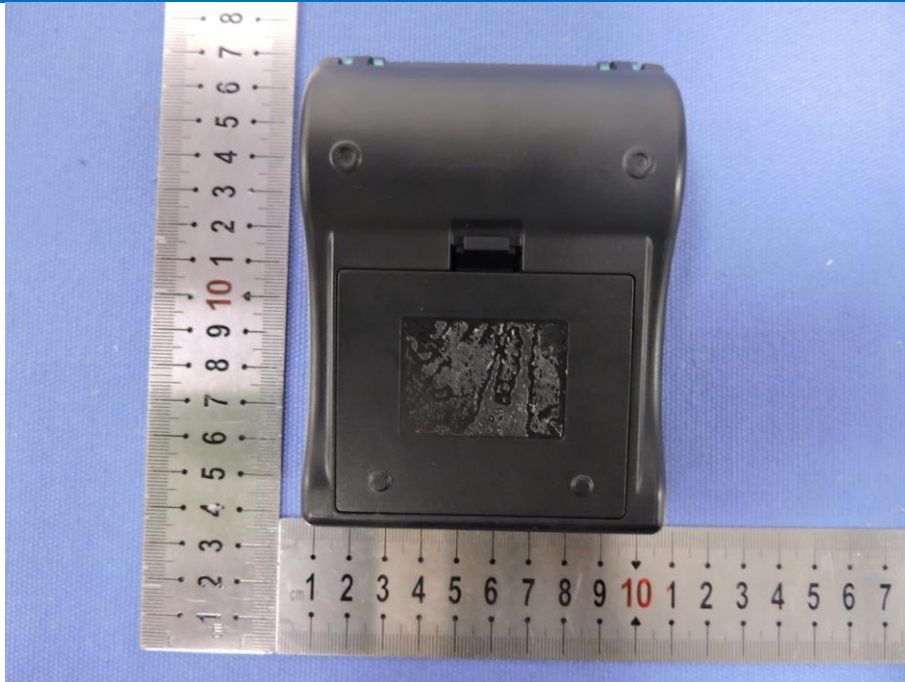

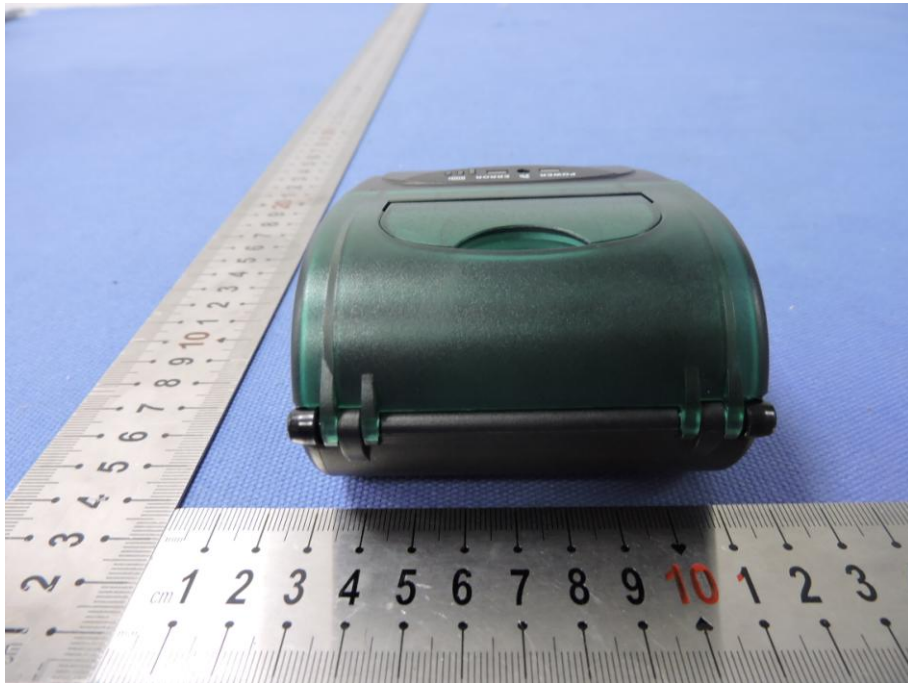





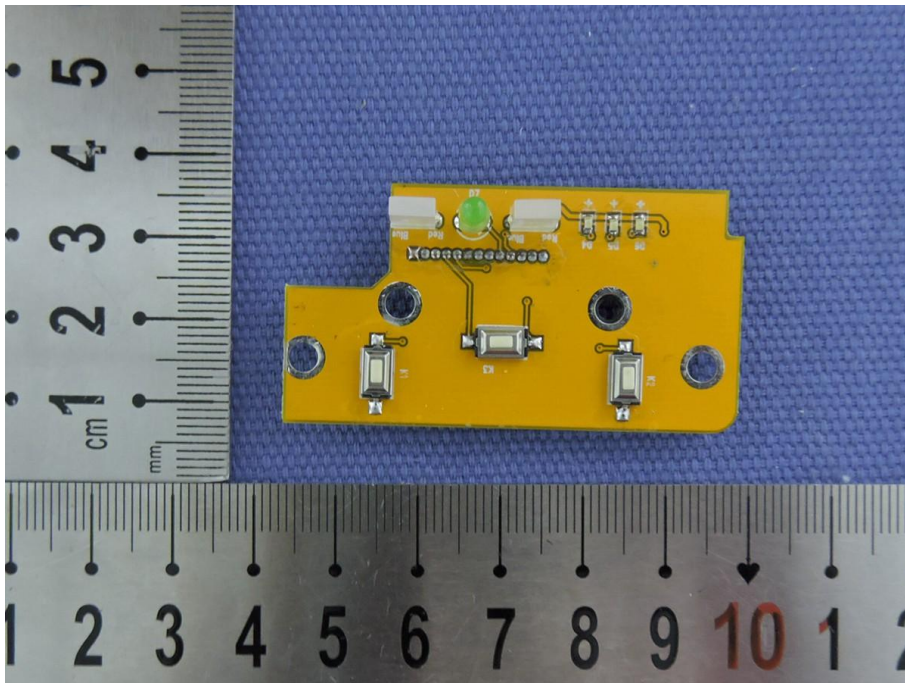
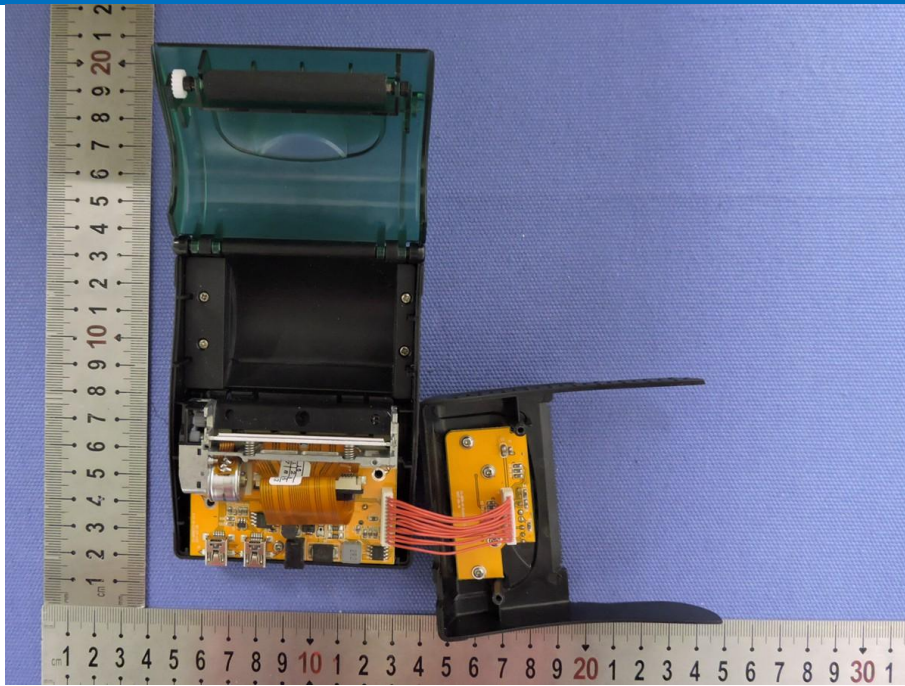

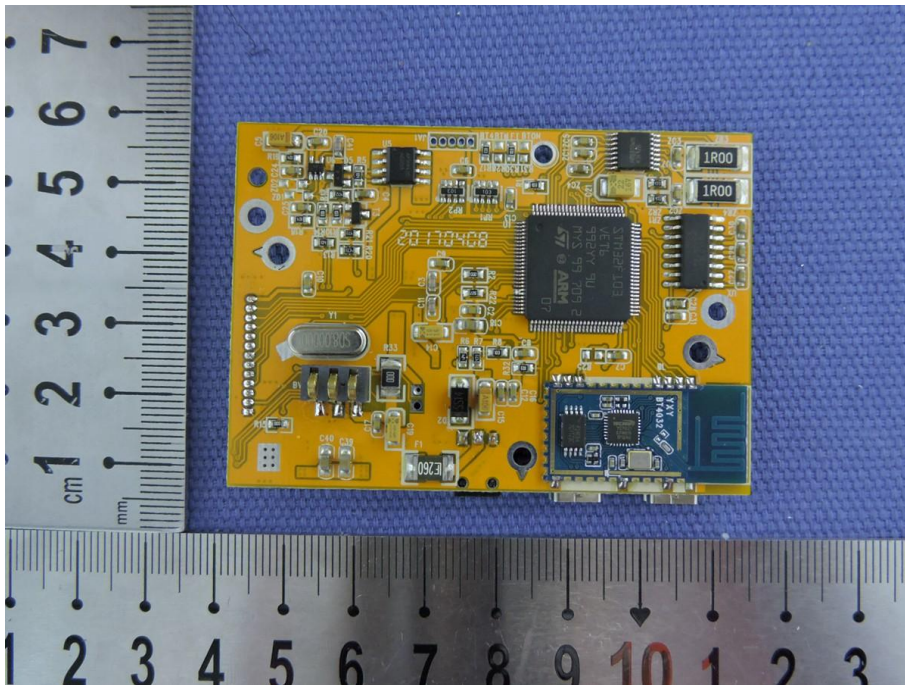
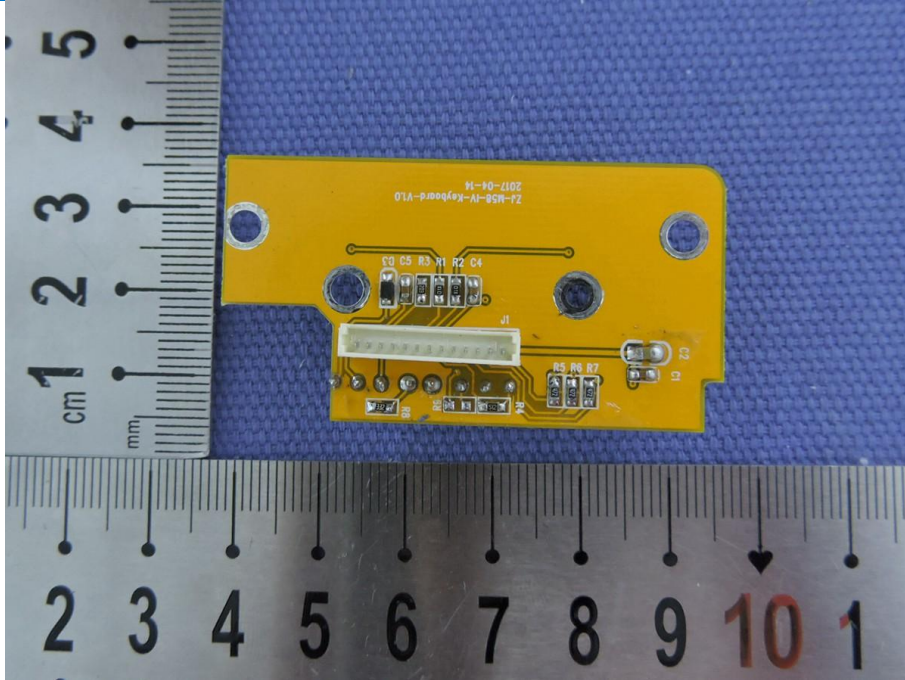

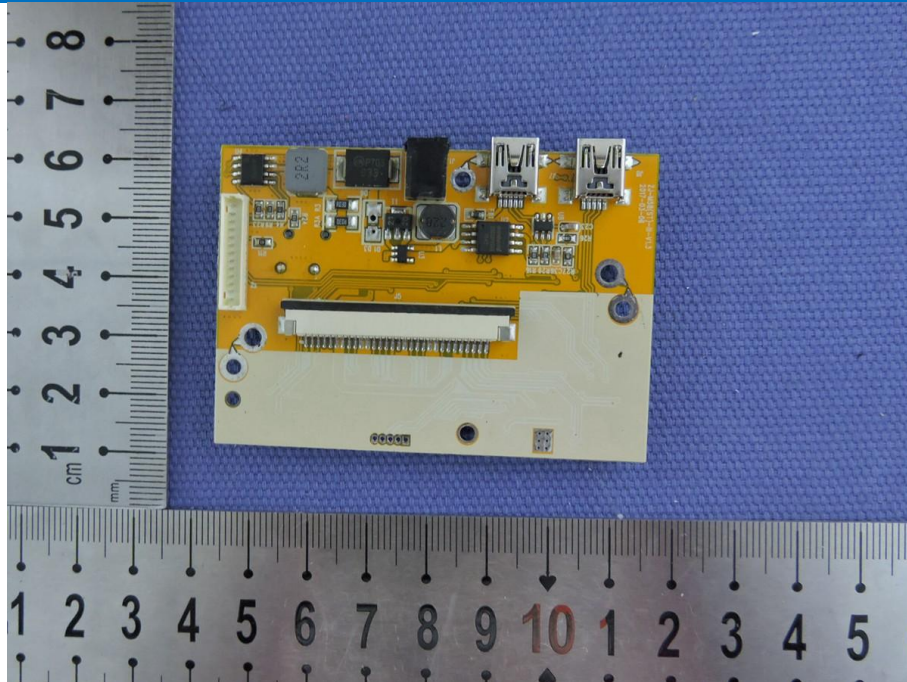

END OF THE REPORT