



**FCC CFR47 PART 15 SUBPART E
INDUSTRY CANADA RSS-210 ISSUE 7
CERTIFICATION TEST REPORT**

FOR
802.11 BASED, SINGLE BAND FIXED WIRELESS NODE
MODEL NUMBER: SP-4300
FCC ID: RV7-SC4121
IC: 5550A-SC4121
REPORT NUMBER: 07U11219-4
ISSUE DATE: FEBRUARY 08, 2008

Prepared for
SKYPILOT NETWORKS INC.
2055 LAURELWOOD ROAD 2nd FLOOR
SANTA CLARA, CA 95054-2747

Prepared by
COMPLIANCE CERTIFICATION SERVICES
47173 BENICIA STREET
FREMONT, CA 94538, U.S.A.
TEL: (510) 771-1000
FAX: (510) 661-0888



NVLAP LAB CODE 200065-0

Revision History

<u>Rev.</u>	<u>Issue Date</u>	<u>Revisions</u>	<u>Revised By</u>
--	02/08/08	Initial Issue	T. Chan

TABLE OF CONTENTS

1. ATTESTATION OF TEST RESULTS	5
2. TEST METHODOLOGY	6
3. FACILITIES AND ACCREDITATION	6
4. CALIBRATION AND UNCERTAINTY	6
4.1. <i>MEASURING INSTRUMENT CALIBRATION</i>	6
4.2. <i>MEASUREMENT UNCERTAINTY</i>	6
5. EQUIPMENT UNDER TEST	7
5.1. <i>DESCRIPTION OF EUT</i>	7
5.2. <i>MAXIMUM OUTPUT POWER</i>	7
5.3. <i>DESCRIPTION OF AVAILABLE ANTENNAS</i>	7
5.4. <i>SOFTWARE AND FIRMWARE</i>	7
5.5. <i>WORST-CASE CONFIGURATION AND MODE</i>	7
5.6. <i>DESCRIPTION OF TEST SETUP</i>	8
6. TEST AND MEASUREMENT EQUIPMENT	10
6.1. <i>802.11a MODE IN THE 5.2 GHz BAND</i>	11
6.1.1. 26 dB and 99% BANDWIDTH	11
6.1.2. OUTPUT POWER	15
6.1.3. AVERAGE POWER	20
6.1.4. PEAK POWER SPECTRAL DENSITY	21
6.1.5. CONDUCTED SPURIOUS EMISSIONS.....	26
7. RADIATED TEST RESULTS	33
7.1. <i>LIMITS AND PROCEDURE</i>	33
7.2. <i>RADIATED EMISSIONS</i>	35
7.2.1. TRANSMITTER RADIATED SPURIOUS EMISSIONS	35
7.2.2. TRANSMITTER ABOVE 1 GHz FOR 5250 TO 5350 MHz BAND	38
7.2.3. RECEIVER ABOVE 1 GHz FOR 20 MHz BANDWIDTH IN THE 5 GHz BAND ..	57
7.2.4. WORST-CASE RADIATED EMISSIONS BELOW 1 GHz.....	58
8. DYNAMIC FREQUENCY SELECTION	60
8.1. <i>OVERVIEW</i>	60
8.1.1. LIMITS.....	60

8.1.2.	TEST AND MEASUREMENT SYSTEM.....	63
8.1.3.	DESCRIPTION OF EUT.....	67
8.2.	5250-5350 MHz BAND.....	69
8.2.1.	TEST CHANNEL AND METHOD.....	69
8.2.2.	PLOTS OF RADAR WAVEFORM, AND WLAN TRAFFIC.....	69
8.2.3.	SLAVE DEVICE CONFIGURATION - CHANNEL MOVE TIME AND CHANNEL CLOSING TRANSMISSION TIME.....	71
8.2.4.	NON-OCCUPANCY PERIOD.....	78
9.	AC POWER LINE CONDUCTED EMISSIONS	80
10.	MAXIMUM PERMISSIBLE EXPOSURE	84
11.	SETUP PHOTOS	88

1. ATTESTATION OF TEST RESULTS

COMPANY NAME: SKYPILOT NETWORKS INC.
2055 LAURELWOOD ROAD 2nd FLOOR
SANTA CLARA, CA 95054-2747

EUT DESCRIPTION: 802.11BASED, FIXED WIRELESS NODE

MODEL: SP-4300

SERIAL NUMBER: F0000007

DATE TESTED: OCTOBER 29-31, 2007

APPLICABLE STANDARDS	
STANDARD	TEST RESULTS
CFR 47 Part 15 Subpart E	No Non-Compliance Noted
RSS-210 Issue 7 Annex 9 and RSS-GEN Issue 2	No Non-Compliance Noted

Compliance Certification Services, Inc. tested the above equipment in accordance with the requirements set forth in the above standards. The test results show that the equipment tested is capable of demonstrating compliance with the requirements as documented in this report.

Note: The results documented in this report apply only to the tested sample, under the conditions and modes of operation as described herein. This document may not be altered or revised in any way unless done so by Compliance Certification Services and all revisions are duly noted in the revisions section. Any alteration of this document not carried out by Compliance Certification Services will constitute fraud and shall nullify the document. No part of this report may be used to claim product certification, approval, or endorsement by NVLAP, NIST, or any government agency.

Approved & Released For CCS By:



THU CHAN
EMC SUPERVISOR
COMPLIANCE CERTIFICATION SERVICES

Tested By:



CHIN PANG
EMC ENGINEER
COMPLIANCE CERTIFICATION SERVICES

2. TEST METHODOLOGY

The tests documented in this report were performed in accordance with ANSI C63.4-2003, FCC CFR 47 Part 2, FCC CFR 47 Part 15, RSS-GEN Issue 2, and RSS-210 Issue 7.

3. FACILITIES AND ACCREDITATION

The test sites and measurement facilities used to collect data are located at 47173 Benicia Street, Fremont, California, USA.

CCS is accredited by NVLAP, Laboratory Code 200065-0. The full scope of accreditation can be viewed at <http://www.ccsemc.com>.

4. CALIBRATION AND UNCERTAINTY

4.1. MEASURING INSTRUMENT CALIBRATION

The measuring equipment utilized to perform the tests documented in this report has been calibrated in accordance with the manufacturer's recommendations, and is traceable to recognized national standards.

4.2. MEASUREMENT UNCERTAINTY

Where relevant, the following measurement uncertainty levels have been estimated for tests performed on the apparatus:

PARAMETER	UNCERTAINTY
Radiated Emission, 30 to 200 MHz	+/- 3.3 dB
Radiated Emission, 200 to 1000 MHz	+4.5 / -2.9 dB
Radiated Emission, 1000 to 2000 MHz	+4.5 / -2.9 dB
Power Line Conducted Emission	+/- 2.9 dB

Uncertainty figures are valid to a confidence level of 95%.

5. EQUIPMENT UNDER TEST

5.1. DESCRIPTION OF EUT

This device is a Single band WLAN radio operating in the 5.26 to 5.32GHz band and using a 802.11a Phy layer radio and a proprietary mesh protocol

The radio module is manufactured by SkyPilot.

5.2. MAXIMUM OUTPUT POWER

The transmitter has a maximum peak conducted output power as follows:

5250 to 5350 MHz Authorized Band

Frequency Range (MHz)	Mode	Output Power (dBm)	Output Power (mW)
5270 - 5320	802.11a	11.36	13.68

5.3. DESCRIPTION OF AVAILABLE ANTENNAS

The radio utilizes a panel antenna with a maximum gain of 16.5 dBi. It is used for point-to-point operation.

5.4. SOFTWARE AND FIRMWARE

The test utility software used during testing was SpCpeSw, Ver.4. This embedded software provides for the discovery protocol, link management (including modulation selection) and management software.

5.5. WORST-CASE CONFIGURATION AND MODE

The worst-case channel is determined as the channel with the highest output power. The highest measured output power was at 5280 MHz.

The worst-case data rate for this channel is determined to be 6 Mb/s, based on previous experience with WLAN product design architectures.

5.6. DESCRIPTION OF TEST SETUP

SUPPORT EQUIPMENT

PERIPHERAL SUPPORT EQUIPMENT LIST				
Description	Manufacturer	Model	Serial Number	FCC ID
Laptop PC	QuickNote	A929	GAYR22190154	DoC
PC AC Adapter	Lite-on Electronics	PA-1900-05	250109400C	N/A
EUT AC Adapter	UNIFIVE	UIB336-24	1567	N/A
Mouse	Logitech	MUB48	LTC95102432	N/A
POE Adapter	SkyPilot	POE	640-00009-01	N/A

I/O CABLES

I/O CABLE LIST						
Cable No.	Port	# of Identical Ports	Connector Type	Cable Type	Cable Length	Remarks
1	AC	1	US115	Unshielded	1.2m	N/A
2	DC	1	DC	Unshielded	1m	N/A
3	Data In	1	RJ45	Unshielded	1.2m	N/A
4	Data out	1	RJ45	Unshielded	1.8m	N/A

TEST SETUP

The test software was utilized to controls the EUT.

SETUP DIAGRAM FOR TESTS

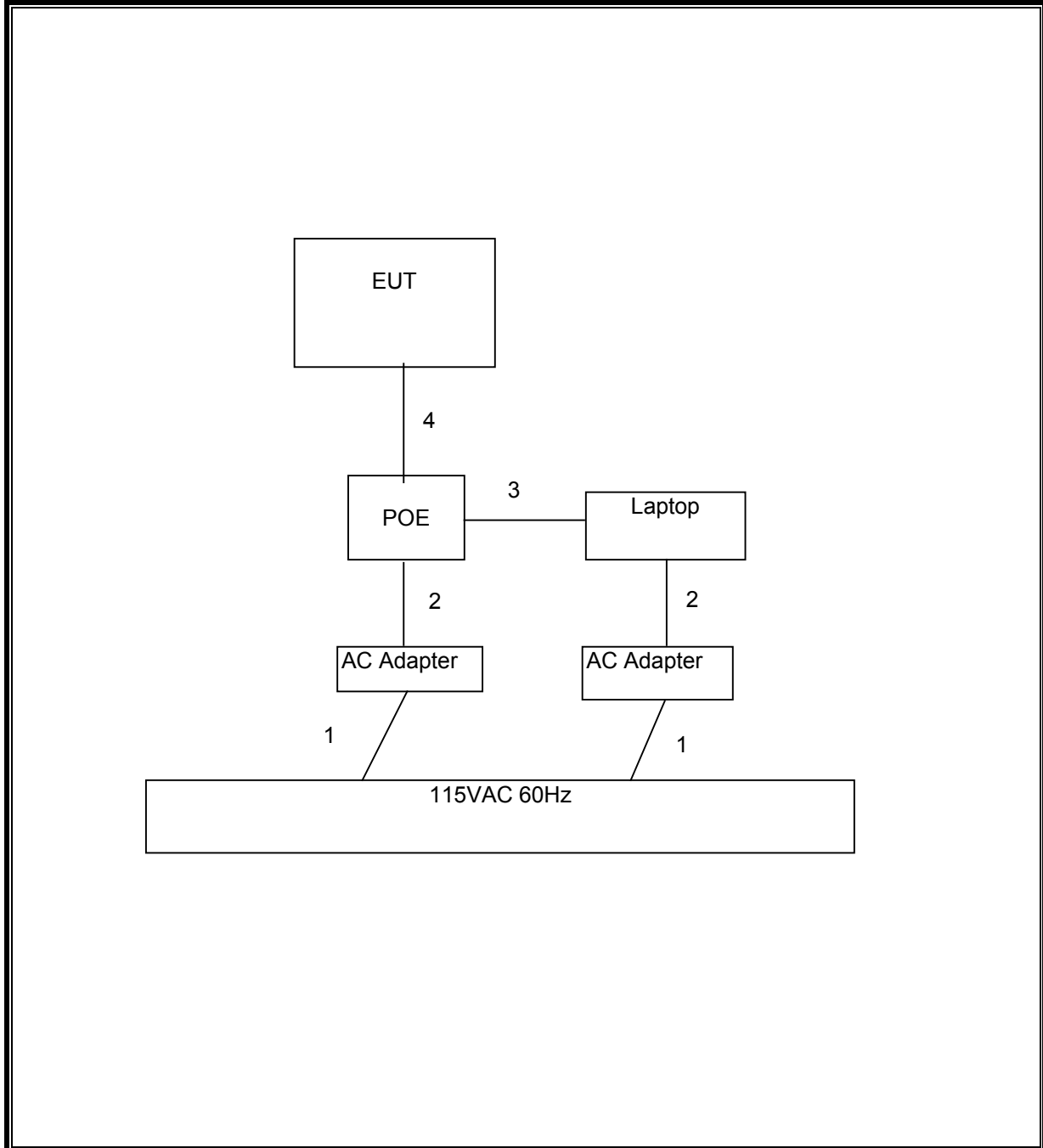

6. TEST AND MEASUREMENT EQUIPMENT

The following test and measurement equipment was utilized for the tests documented in this report:

TEST EQUIPMENT LIST				
Description	Manufacturer	Model	Asset	Cal Due
Spectrum Analyzer, 44 GHz	Agilent / HP	E4446A	C01012	8/7/2008
Antenna, Horn, 26.5 GHz	ARA	MWH-1826/B	C00589	9/28/2008
Horn	EMCO	3115	C00872	4/15/2008
Preamplifier, 26.5 GHz	Agilent / HP	8449B	C01063	9/27/2008
Spectrum Analyzer, 44 GHz	Agilent / HP	E4446A	C01012	8/7/2008
Antenna, Horn, 26.5 GHz	ARA	MWH-1826/B	C00589	9/28/2008
Preamplifier, 26.5 GHz	Agilent / HP	8449B	C01063	9/27/2008
EMI Test Receiver, 30 MHz	R & S	ESHS 20	N02396	1/27/2008
LISN, 30 MHz	FCC	LISN-50/250-25-2	N02625	10/25/2008
Antenna, Bilog, 2 GHz	Sunol Sciences	JB1	C01016	9/29/2008
Preamplifier, 1300 MHz	Agilent / HP	8447D	NA	5/9/2008
EMI Receiver, 2.9 GHz	Agilent / HP	8542E	C00957	6/12/2008
RF Filter Section, 2.9 GHz	Agilent / HP	85420E	C00958	6/12/2008
Antenna, Horn, 26.5 GHz	ARA	MWH-1826/B	C00980	9/28/2008
7.6 GHz High Pass Filter	Micro Tronics	HPM13350	1	CNR

6.1. 802.11a MODE IN THE 5.2 GHz BAND

6.1.1. 26 dB and 99% BANDWIDTH

LIMITS

None; for reporting purposes only.

TEST PROCEDURE

The transmitter output is connected to the spectrum analyzer. The RBW is set to 1% to 3% of the measured bandwidth. The VBW is set to 3 times the RBW. The sweep time is coupled. The spectrum analyzer internal bandwidth function is utilized.

RESULTS

Channel	Frequency (MHz)	26 dB Bandwidth (MHz)	99% Bandwidth (MHz)
Low	5270	18.385	16.3323
Middle	5280	21.113	16.4938
High	5320	20.626	16.4961

26 dB and 99% BANDWIDTH

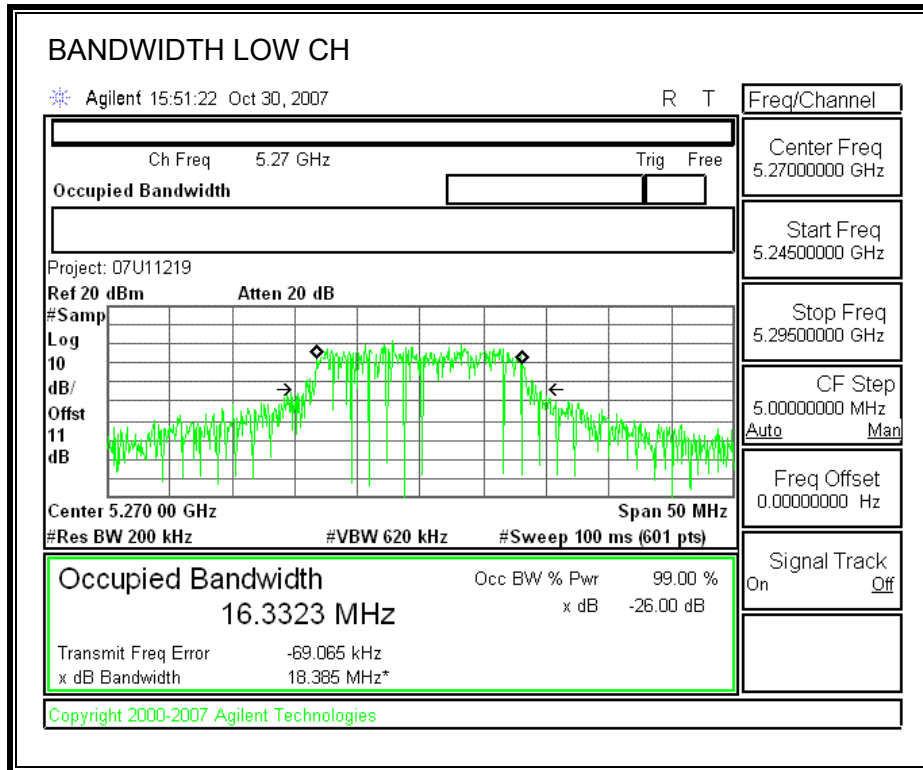

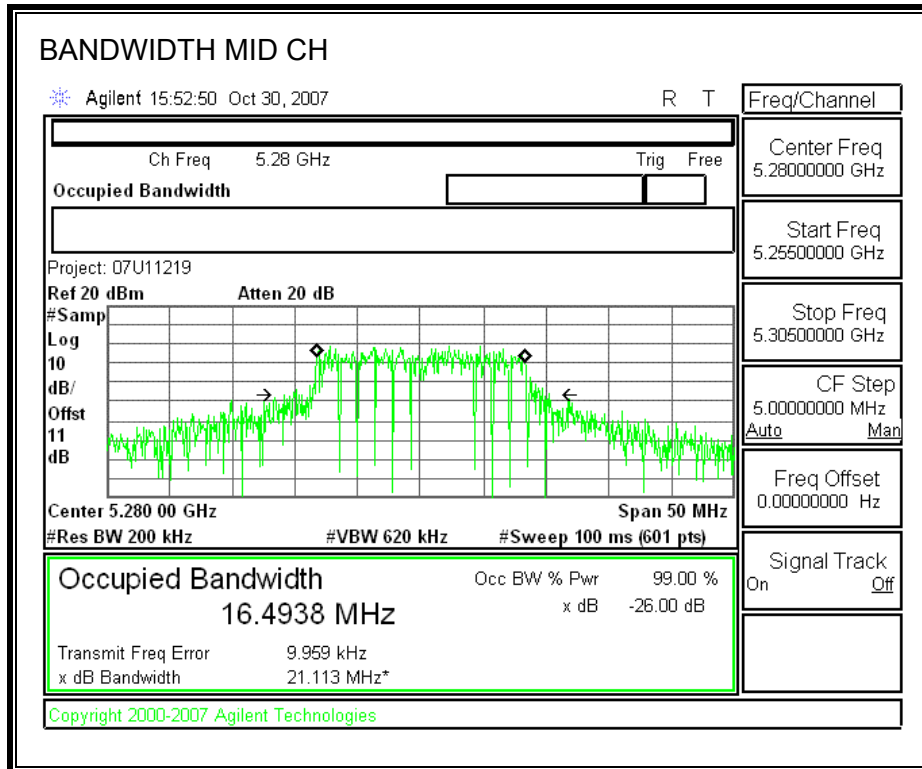

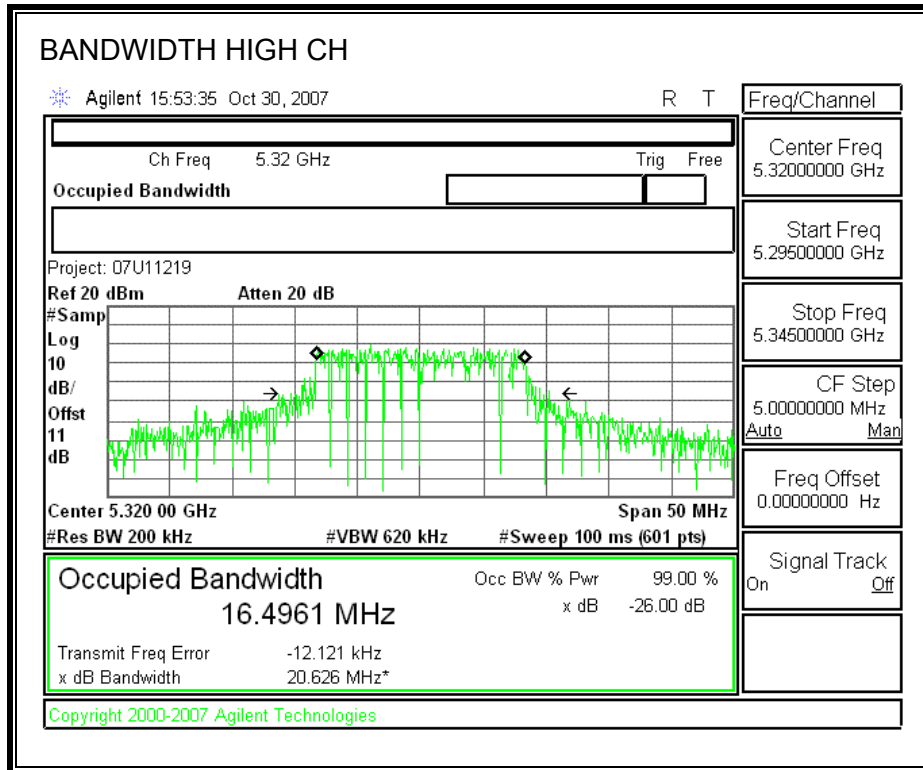

6.1.2. OUTPUT POWER

LIMITS

FCC §15.407 (a) (1 & 2)

IC RSS-210 A9.2 (1 & 2)

For the 5.25-5.35 GHz band, the maximum conducted output power over the frequency band of operation shall not exceed the lesser of 250 mW or $11 \text{ dBm} + 10 \log B$, where B is the 26-dB emission bandwidth in MHz.

If transmitting antennas of directional gain greater than 6 dBi are used, both the peak transmit power and the peak power spectral density shall be reduced by the amount in dB that the directional gain of the antenna exceeds 6 dBi.

The antenna gain is 16.5dBi, so the limit is $24\text{dBm} - (16.5 - 6.0) = 13.5\text{dBm}$

TEST PROCEDURE

The test is performed in accordance with FCC Public Notice: APPENDIX A Guidelines for Assessing Unlicensed National Information Infrastructure (U-NII) Devices – Part 15, Subpart E, August 2002.

The transmitter output operates continuously therefore Method # 1 is used.

RESULTS

Limit in 5250 to 5350 MHz Band

Channel	Frequency (MHz)	Fixed Limit (dBm)	B (MHz)	11 + 10 Log B Limit (dBm)	Antenna Gain (dBi)	Limit (dBm)
Low	5270	24	16.3323	23.13	16.50	12.63
Mid	5280	24	16.4938	23.17	16.50	12.67
High	5320	24	16.4961	23.17	16.50	12.67

Results

Channel	Frequency (MHz)	Power (dBm)	Limit (dBm)	Margin (dB)
Low	5270	11.22	12.63	-1.41
Mid	5280	11.36	12.67	-1.31
High	5320	11.12	12.67	-1.55

OUTPUT POWER

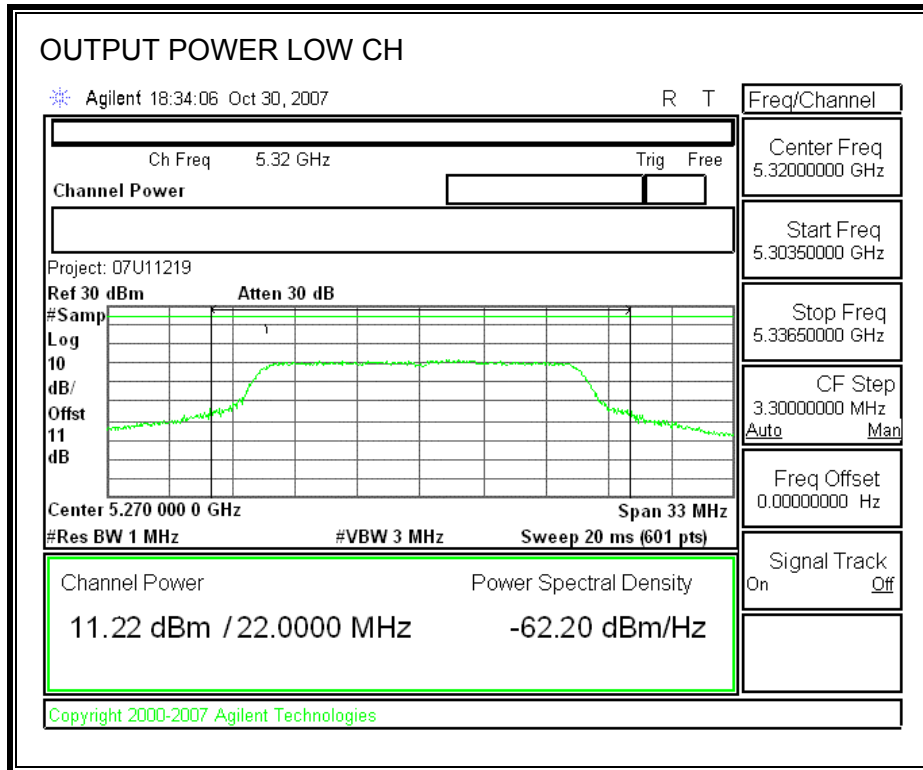

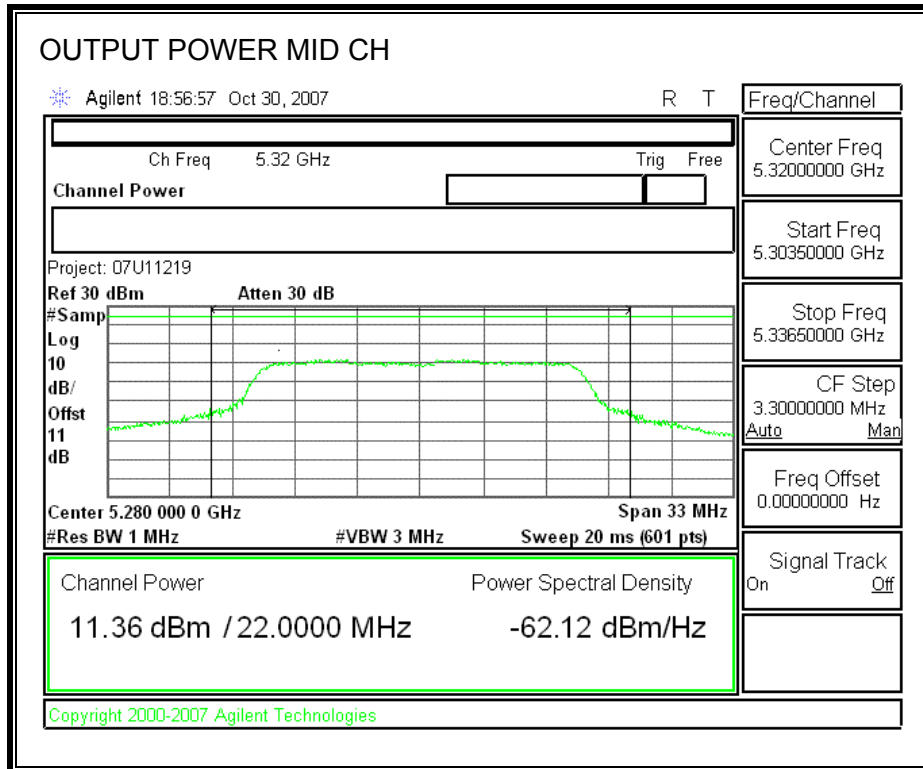

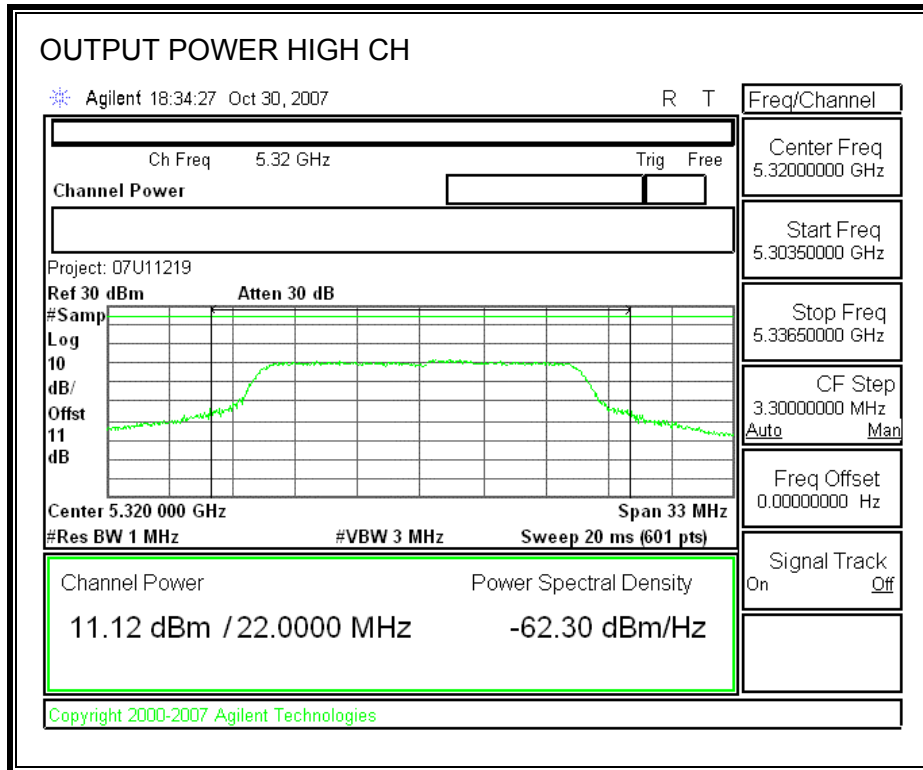

6.1.3. AVERAGE POWER

AVERAGE POWER LIMIT

None; for reporting purposes only.

TEST PROCEDURE

The transmitter output is connected to a power meter.

RESULTS

No non-compliance noted:

The cable assembly insertion loss of 10.5 dB (including 10 dB pad and 1 dB cable) was entered as an offset in the power meter to allow for direct reading of power.

802.11a Mode

Channel	Frequency (MHz)	Average Power (dBm)
Low	5270	11.20
Middle	5280	11.34
High	5320	11.17

6.1.4. PEAK POWER SPECTRAL DENSITY

LIMITS

FCC §15.407 (a) (1 & 2)

IC RSS-210 A9.2 (1 & 2)

For the 5.25–5.35 GHz band, the peak power spectral density shall not exceed 11 dBm in any 1 MHz band.

If transmitting antennas of directional gain greater than 6 dBi are used, both the peak transmit power and the peak power spectral density shall be reduced by the amount in dB that the directional gain of the antenna exceeds 6 dBi.

The antenna gain is 16.5dBi, so the limit is $11\text{dBm} - (16.5 - 6.0) = 0.5\text{dBm}$.

TEST PROCEDURE

The test is performed in accordance with FCC Public Notice: APPENDIX A Guidelines for Assessing Unlicensed National Information Infrastructure (U-NII) Devices – Part 15, Subpart E, August 2002. PPSD method #2 was used.

RESULTS

No non-compliance noted:

Channel	Frequency (MHz)	PPSD (dBm)	Limit (dBm)	Margin (dB)
Low	5270	6.97	11	-4.03
Middle	5280	7.07	11	-3.93
High	5320	6.69	11	-4.31

PEAK POWER SPECTRAL DENSITY (802.11a MODE)

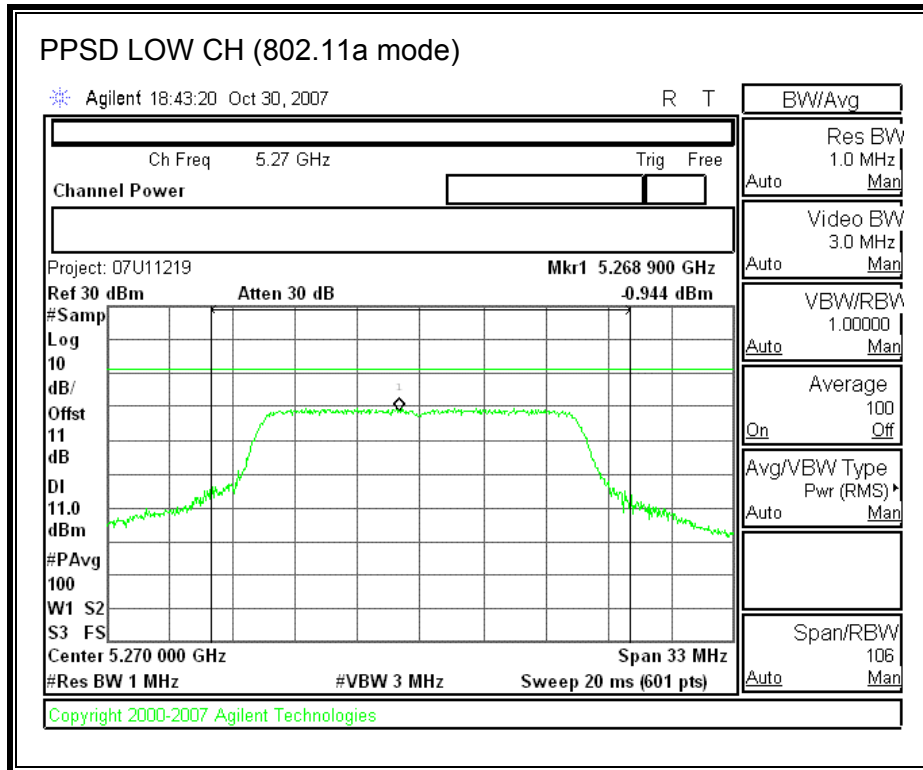

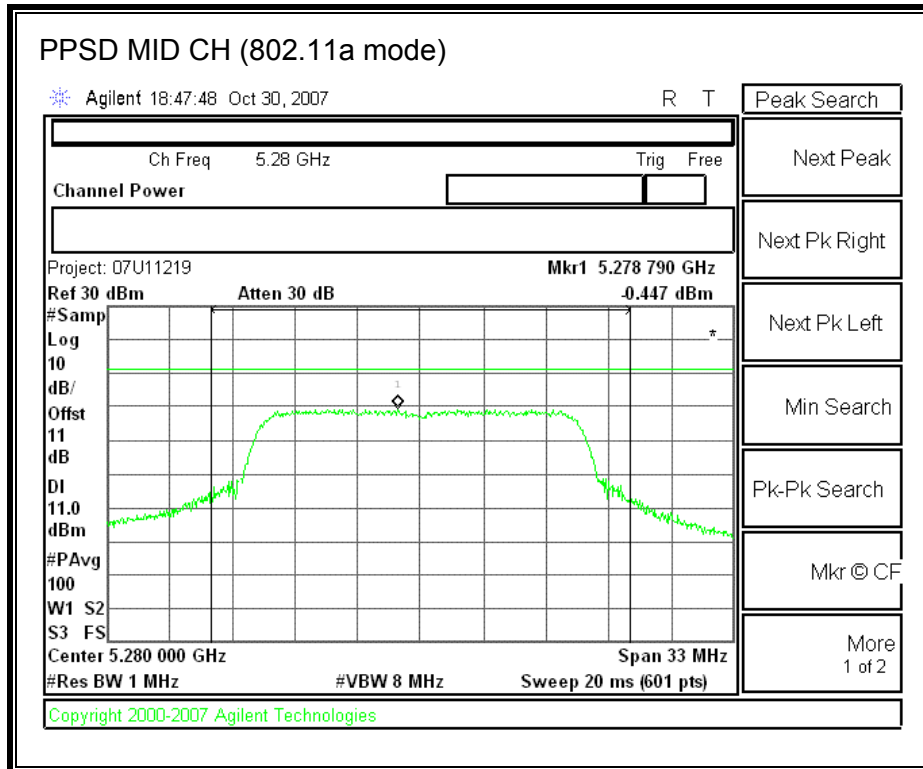

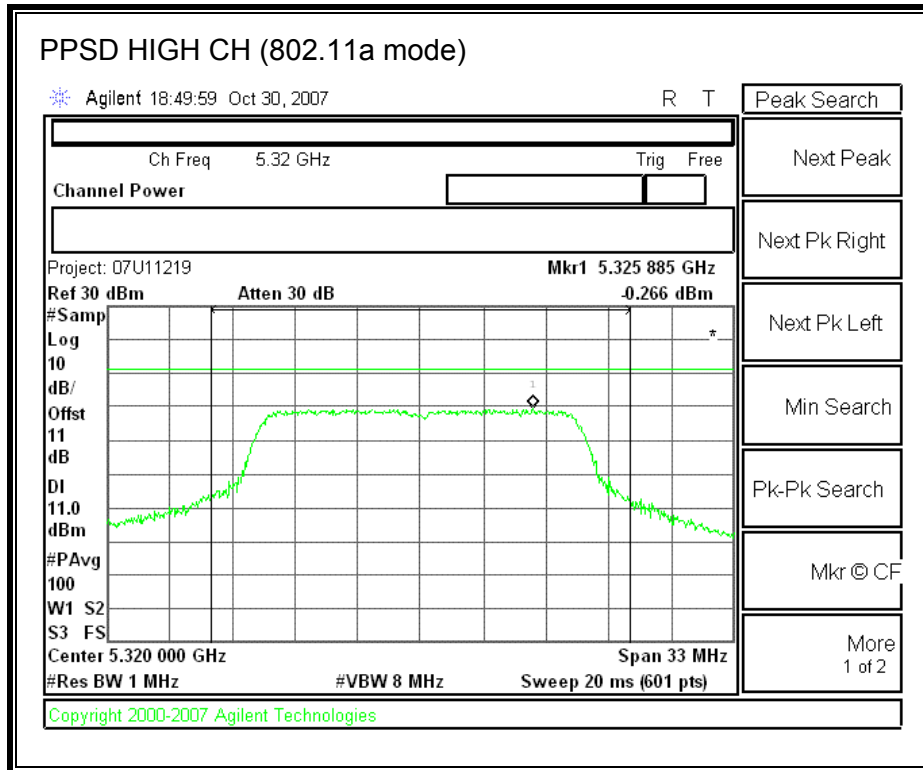

6.1.5. CONDUCTED SPURIOUS EMISSIONS

LIMITS

FCC §15.407 (b) (1)

IC RSS-210 A9.3 (1)

For transmitters operating in the 5.15-5.25 GHz band: all emissions outside of the 5.15-5.35 GHz band shall not exceed an EIRP of -27 dBm / MHz.

The antenna gain is 16.5dBi, so the EIRP limit is -43.5dBm.

TEST PROCEDURE

Conducted RF measurements of the transmitter output are made to confirm that the EUT antenna port conducted emissions meet the specified limit and to identify any spurious signals that require further investigation or measurements on the radiated emissions site.

The transmitter output is connected to the spectrum analyzer. The resolution bandwidth is set to 1 MHz. The video bandwidth is set to 1 MHz. Peak detection measurements are compared to the average EIRP limit, adjusted for the maximum antenna gain. If necessary, additional average detection measurements are made.

Measurements are made over the 30 MHz to 40 GHz range with the transmitter set to the lowest, middle, and highest channels.

RESULTS

SPURIOUS EMISSIONS

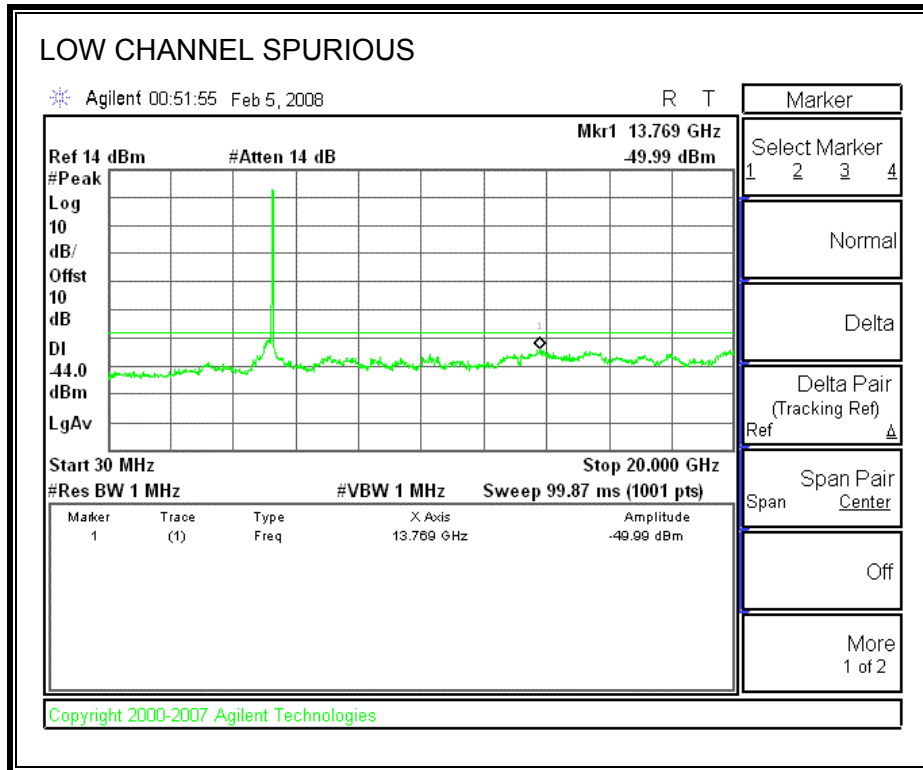

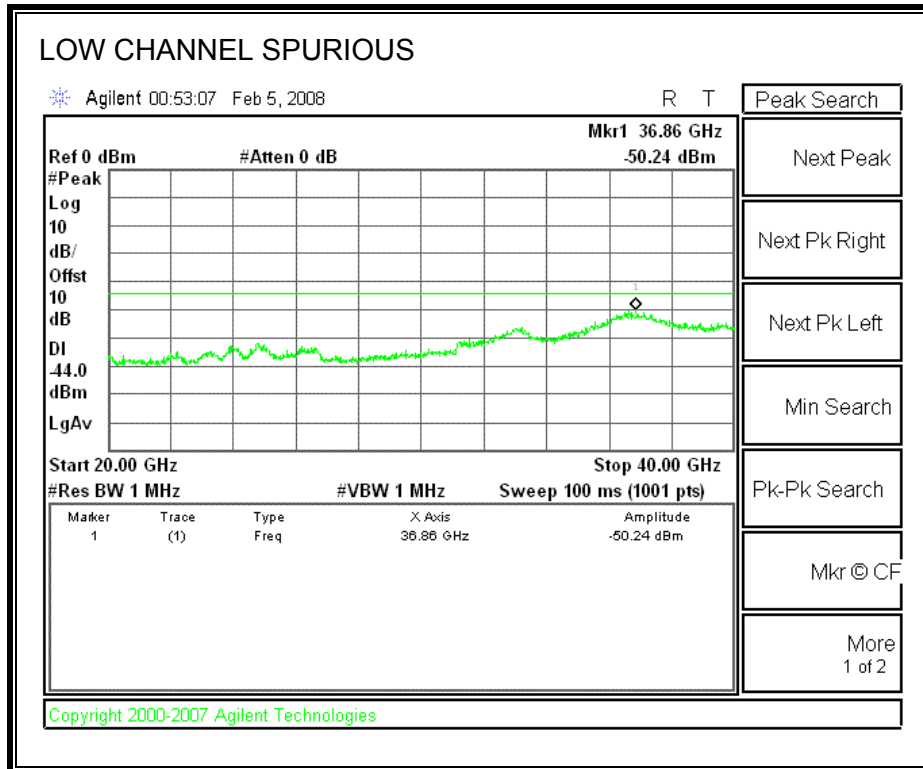

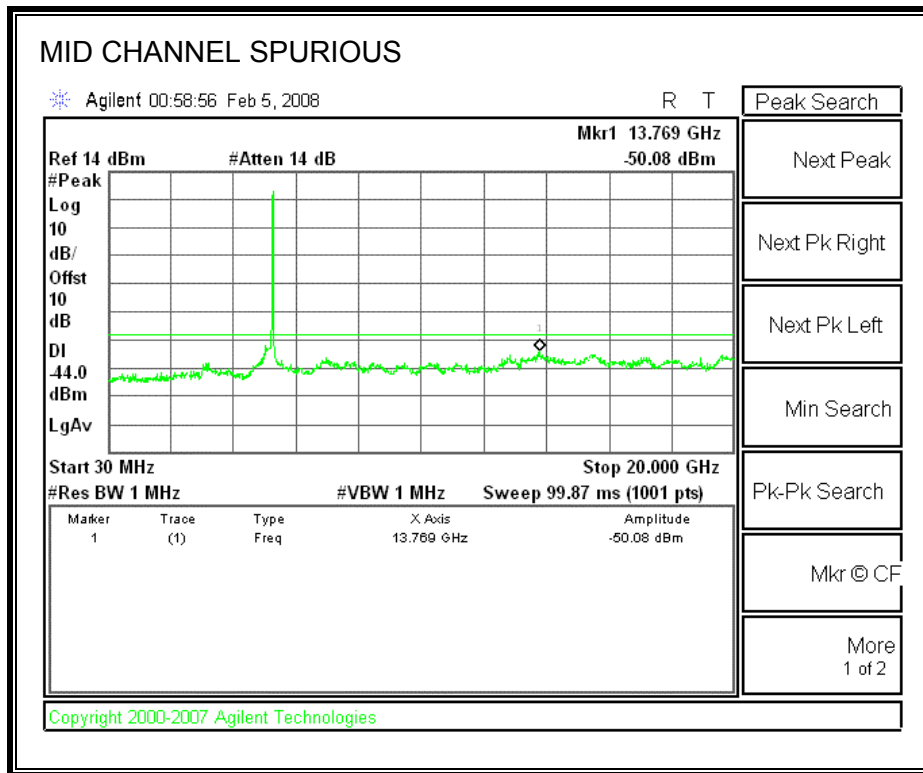

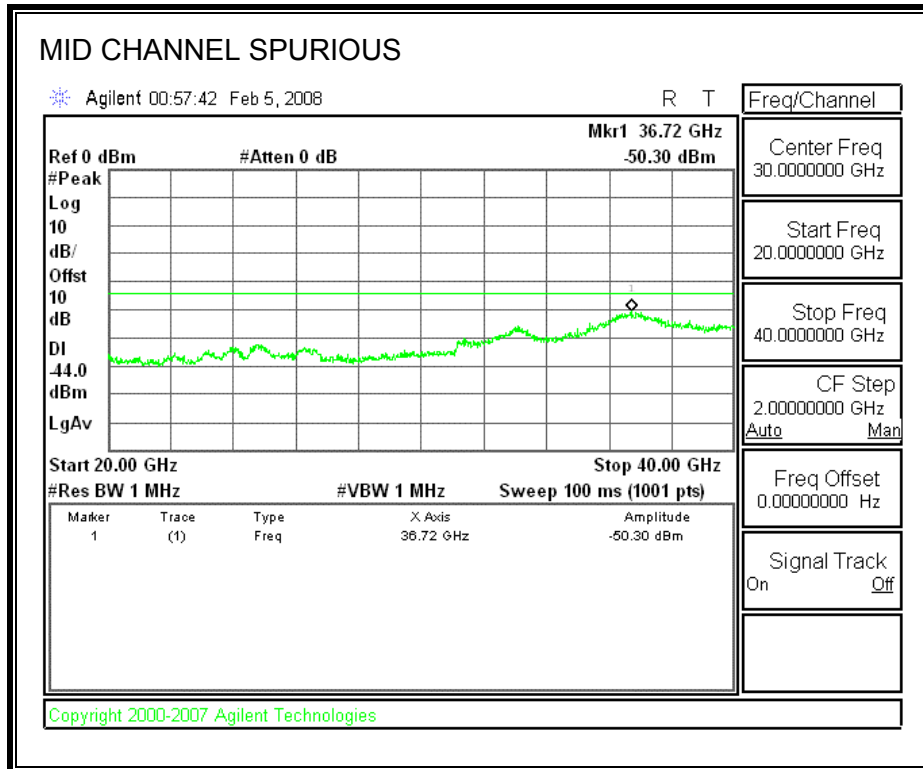

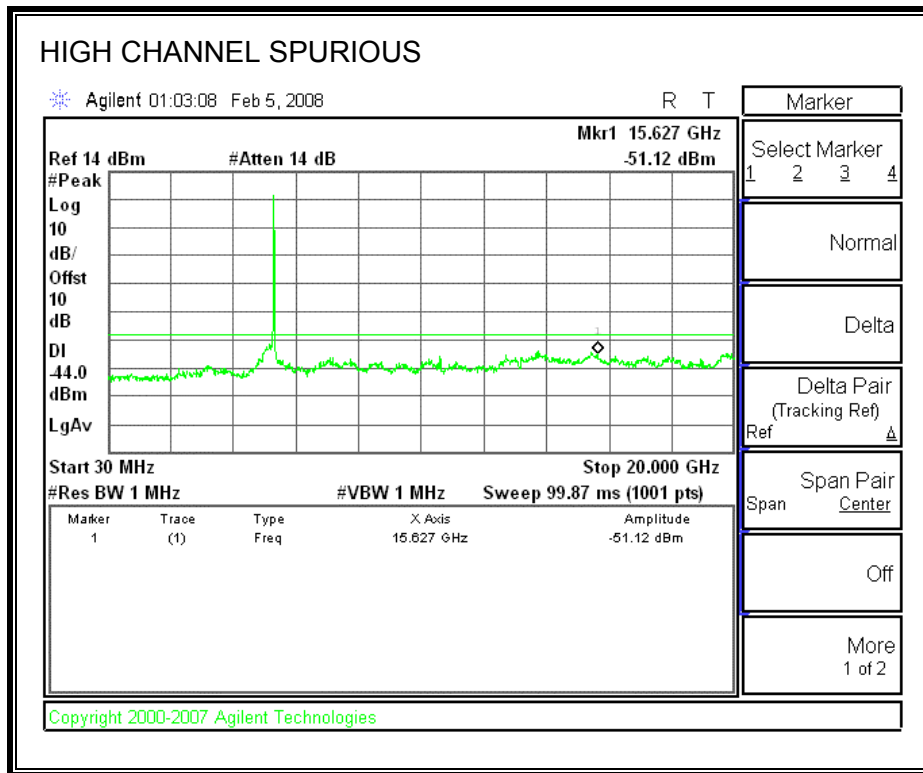

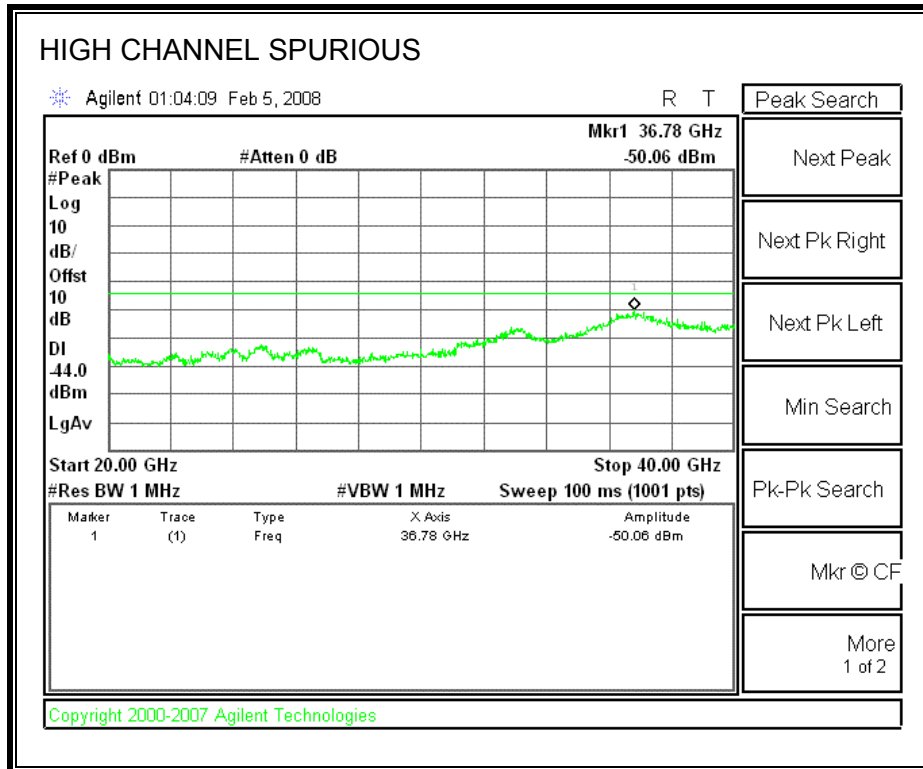

7. RADIATED TEST RESULTS

7.1. LIMITS AND PROCEDURE

LIMITS

FCC §15.205 and §15.209

IC RSS-210 Clause 2.6 (Transmitter)

IC RSS-GEN Clause 6 (Receiver)

Frequency Range (MHz)	Field Strength Limit ($\mu\text{V}/\text{m}$) at 3 m	Field Strength Limit (dB $\mu\text{V}/\text{m}$) at 3 m
30 - 88	100	40
88 - 216	150	43.5
216 - 960	200	46
Above 960	500	54

TEST PROCEDURE

The EUT is placed on a non-conducting table 80 cm above the ground plane. The antenna to EUT distance is 3 meters. The EUT is configured in accordance with ANSI C63.4. The EUT is set to transmit in a continuous mode.

For measurements below 1 GHz the resolution bandwidth is set to 100 kHz for peak detection measurements or 120 kHz for quasi-peak detection measurements. Peak detection is used unless otherwise noted as quasi-peak.

For measurements above 1 GHz the resolution bandwidth is set to 1 MHz, then the video bandwidth is set to 1 MHz for peak measurements and 10 Hz for average measurements.

The spectrum from 30 MHz to 26 GHz is investigated with the transmitter set to the lowest, middle, and highest channels in the 2.4 GHz band.

The frequency range of interest is monitored at a fixed antenna height and EUT azimuth. The EUT is rotated through 360 degrees to maximize emissions received. The antenna is scanned from 1 to 4 meters above the ground plane to further maximize the emission. Measurements are made with the antenna polarized in both the vertical and the horizontal positions.

7.2. RADIATED EMISSIONS

7.2.1. TRANSMITTER RADIATED SPURIOUS EMISSIONS

LIMITS

§15.205 (a) Except as shown in paragraph (d) of this section, only spurious emissions are permitted in any of the frequency bands listed below:

MHz	MHz	MHz	GHz
0.090 - 0.110	16.42 - 16.423	399.9 - 410	4.5 - 5.15
¹ 0.495 - 0.505	16.69475 - 16.69525	608 - 614	5.35 - 5.46
2.1735 - 2.1905	16.80425 - 16.80475	960 - 1240	7.25 - 7.75
4.125 - 4.128	25.5 - 25.67	1300 - 1427	8.025 - 8.5
4.17725 - 4.17775	37.5 - 38.25	1435 - 1626.5	9.0 - 9.2
4.20725 - 4.20775	73 - 74.6	1645.5 - 1646.5	9.3 - 9.5
6.215 - 6.218	74.8 - 75.2	1660 - 1710	10.6 - 12.7
6.26775 - 6.26825	108 - 121.94	1718.8 - 1722.2	13.25 - 13.4
6.31175 - 6.31225	123 - 138	2200 - 2300	14.47 - 14.5
8.291 - 8.294	149.9 - 150.05	2310 - 2390	15.35 - 16.2
8.362 - 8.366	156.52475 - 156.52525	2483.5 - 2500	17.7 - 21.4
8.37625 - 8.38675	156.7 - 156.9	2655 - 2900	22.01 - 23.12
8.41425 - 8.41475	162.0125 - 167.17	3260 - 3267	23.6 - 24.0
12.29 - 12.293	167.72 - 173.2	3332 - 3339	31.2 - 31.8
12.51975 - 12.52025	240 - 285	3345.8 - 3358	36.43 - 36.5
12.57675 - 12.57725	322 - 335.4	3600 - 4400	(²)
13.36 - 13.41			

¹ Until February 1, 1999, this restricted band shall be 0.490-0.510 MHz.

² Above 38.6

§15.205 (b) Except as provided in paragraphs (d) and (e), the field strength of emissions appearing within these frequency bands shall not exceed the limits shown in Section 15.209. At frequencies equal to or less than 1000 MHz, compliance with the limits in Section 15.209 shall be demonstrated using measurement instrumentation employing a CISPR quasi-peak detector.

Above 1000 MHz, compliance with the emission limits in Section 15.209 shall be demonstrated based on the average value of the measured emissions. The provisions in Section 15.35 apply to these measurements.

§15.209 (a) Except as provided elsewhere in this Subpart, the emissions from an intentional radiator shall not exceed the field strength levels specified in the following table:

Frequency (MHz)	Field Strength (microvolts/meter)	Measurement Distance (meters)
30 - 88	100 **	3
88 - 216	150 **	3
216 - 960	200 **	3
Above 960	500	3

** Except as provided in paragraph (g), fundamental emissions from intentional radiators operating under this Section shall not be located in the frequency bands 54-72 MHz, 76-88 MHz, 174-216 MHz or 470-806 MHz. However, operation within these frequency bands is permitted under other sections of this Part, e.g., Sections 15.231 and 15.241.

§15.209 (b) In the emission table above, the tighter limit applies at the band edges.

TEST PROCEDURE

The EUT is placed on a non-conducting table 80 cm above the ground plane. The antenna to EUT distance is 3 meters. The EUT is configured in accordance with ANSI C63.4. The EUT is set to transmit in a continuous mode.

For measurements below 1 GHz the resolution bandwidth is set to 100 kHz for peak detection measurements or 120 kHz for quasi-peak detection measurements. Peak detection is used unless otherwise noted as quasi-peak.

For measurements above 1 GHz the resolution bandwidth is set to 1 MHz, then the video bandwidth is set to 1 MHz for peak measurements and 10 Hz for average measurements.

The spectrum from 30 MHz to 40 GHz is investigated with the transmitter set to the lowest, middle, and highest channels in each band.

The frequency range of interest is monitored at a fixed antenna height and EUT azimuth. The EUT is rotated through 360 degrees to maximize emissions received. The antenna is scanned from 1 to 4 meters above the ground plane to further maximize the emission. Measurements are made with the antenna polarized in both the vertical and the horizontal positions.

7.2.2. TRANSMITTER ABOVE 1 GHZ FOR 5250 TO 5350 MHz BAND

5270MHz

RESTRICTED BANDEDGE (802.11a MODE, LOW CHANNEL, HORIZONTAL)

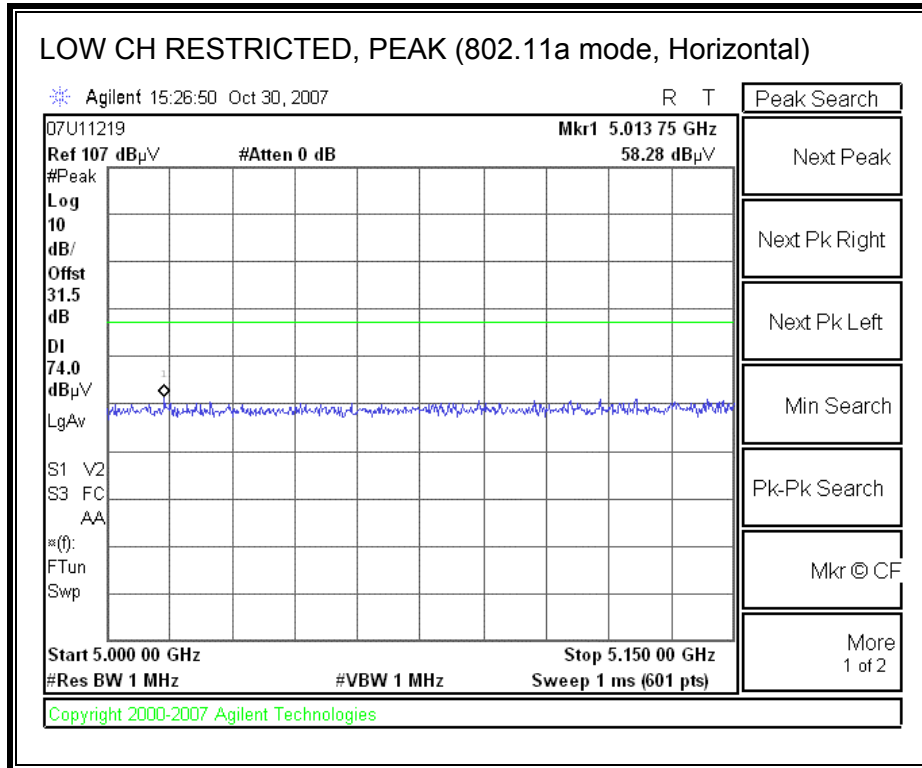

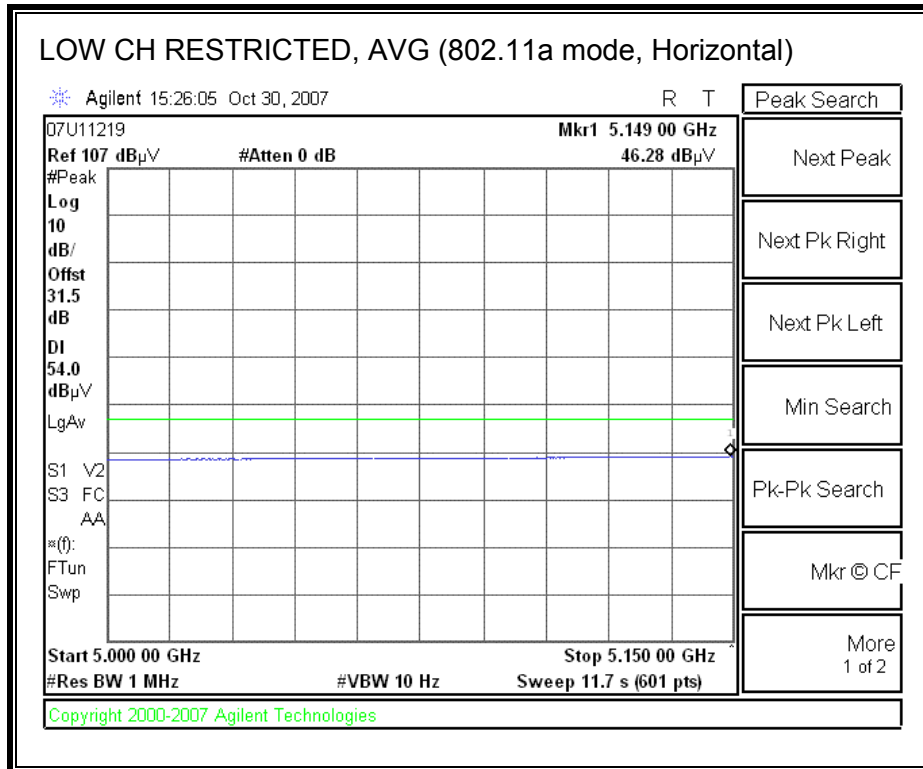

RESTRICTED BANDEDGE (802.11a MODE, LOW CHANNEL, VERTICAL)

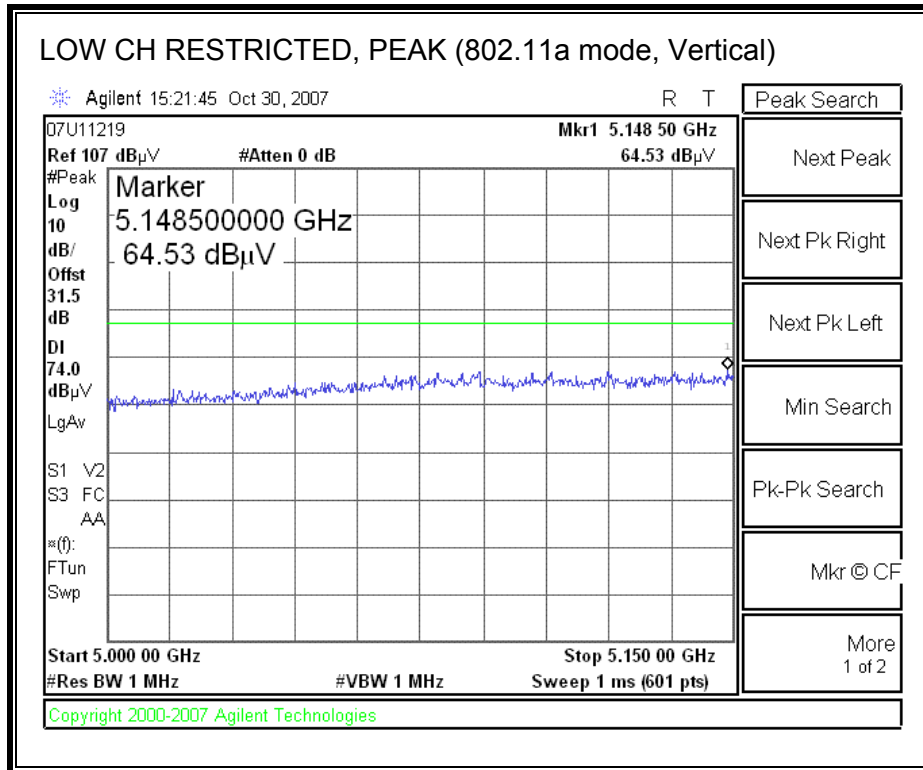

5270MHz OUT OF BAND (Worst Case Vertical)

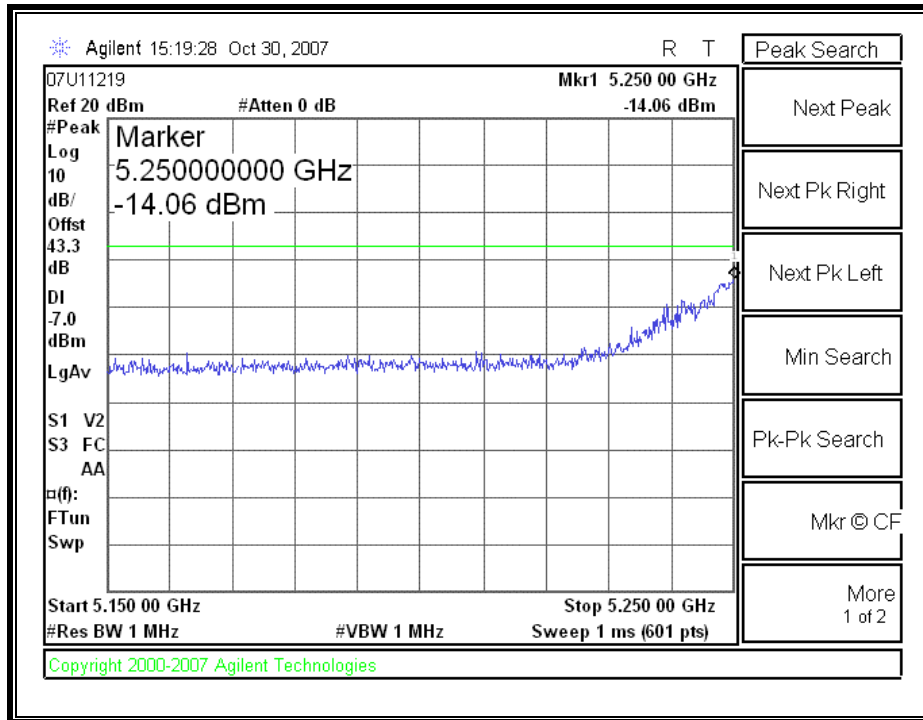

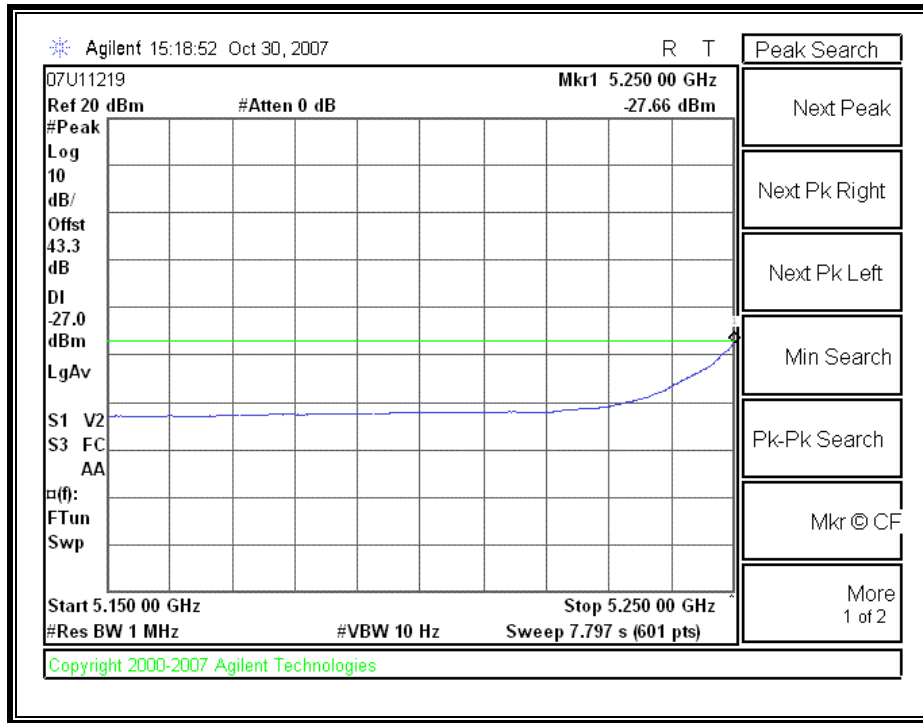

5280MHz

LOW RESTRICTED BANDEDGE (802.11a MODE, HORIZONTAL)

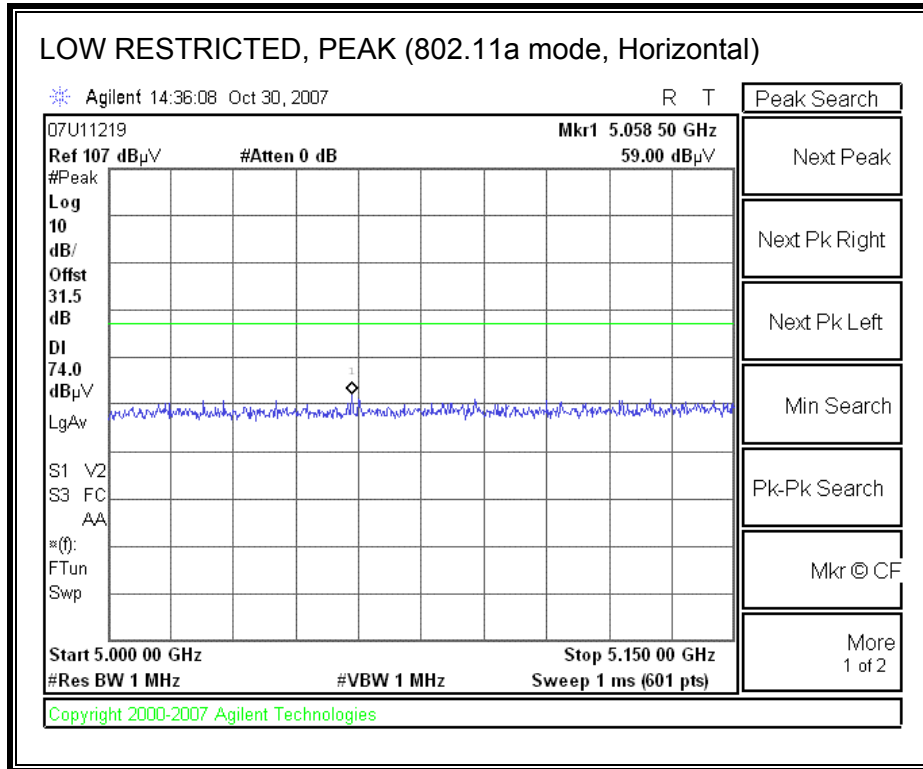

RESTRICTED BANDEDGE (802.11a MODE, HIGH CHANNEL, VERTICAL)

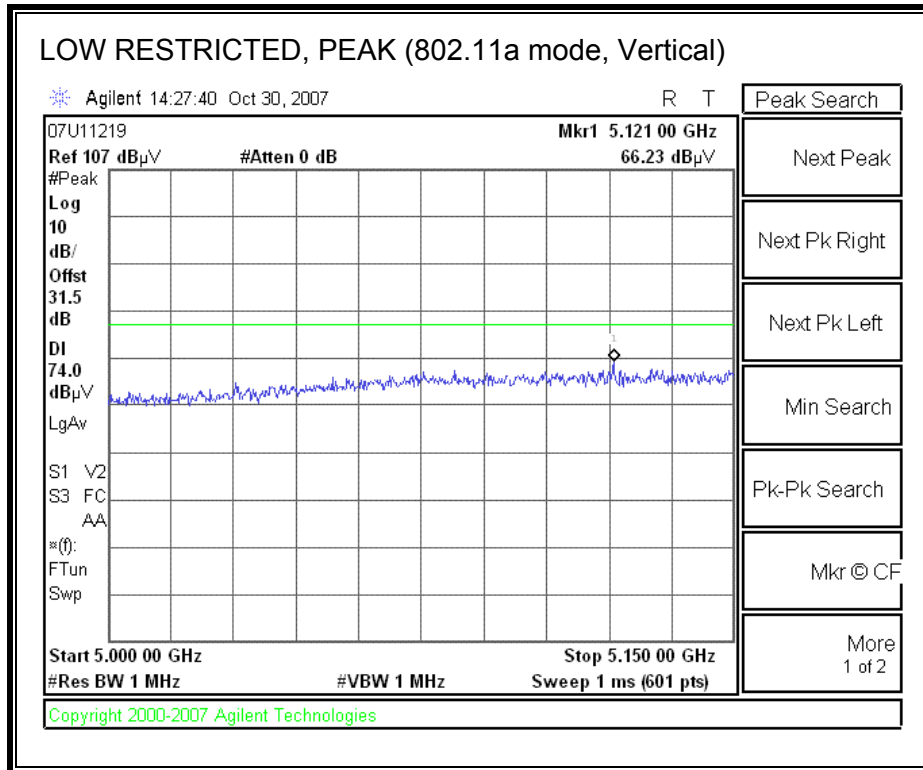

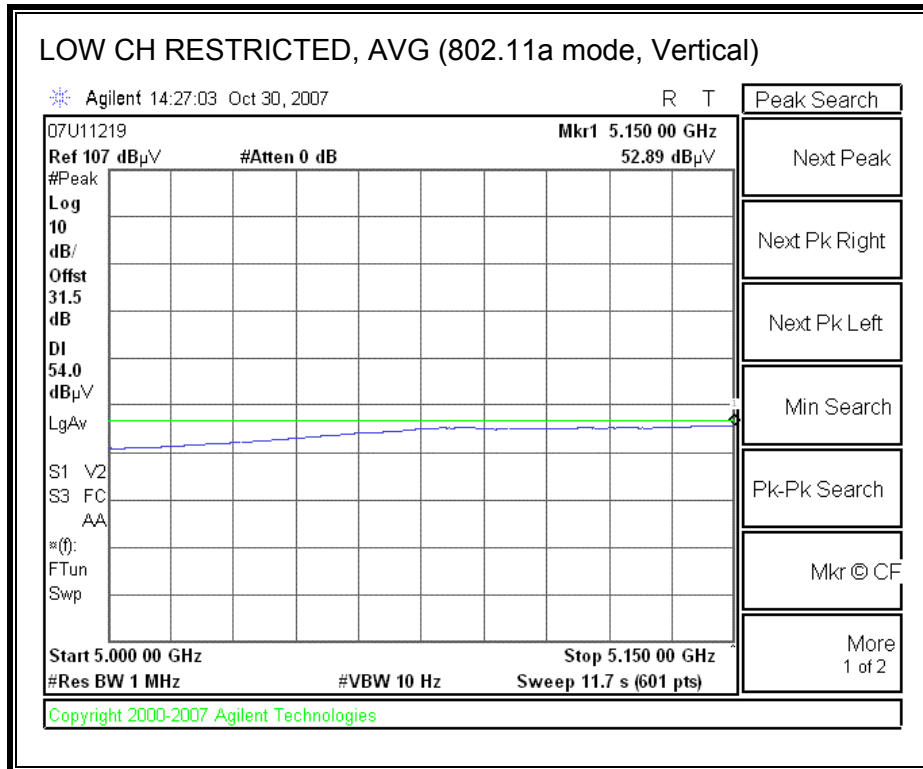

5280MHz

HIGH RESTRICTED BANDEDGE (802.11a MODE, HORIZONTAL)

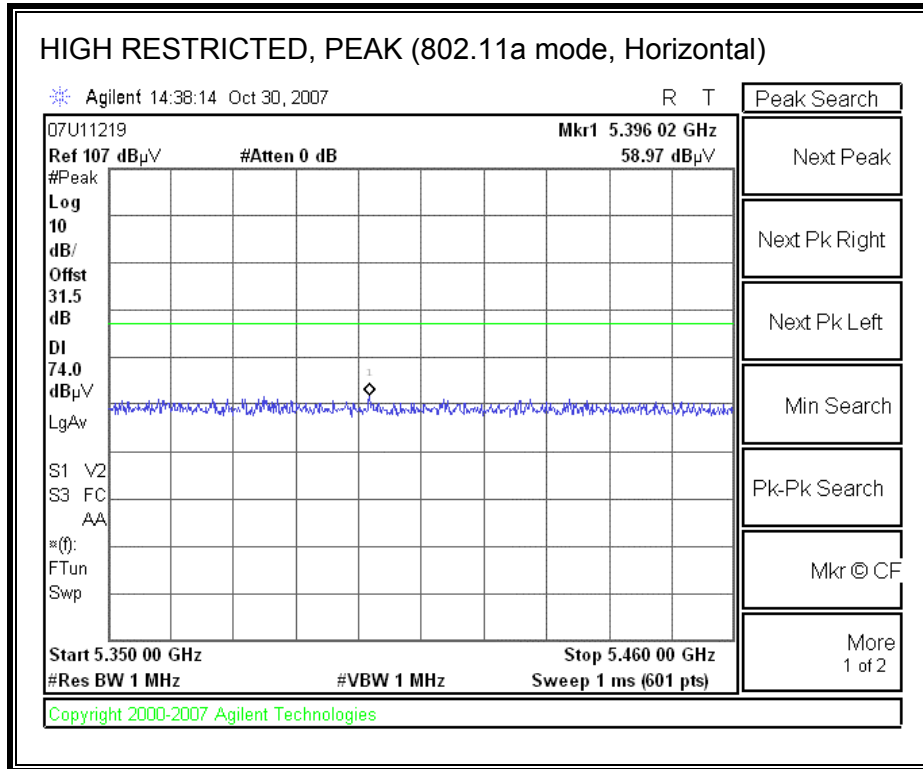

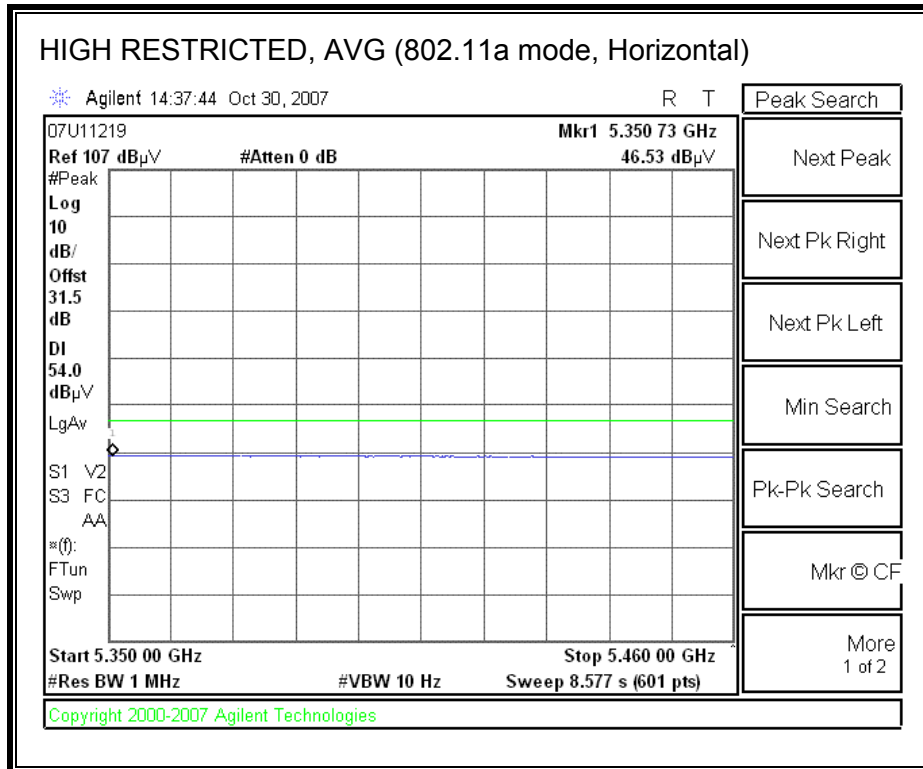

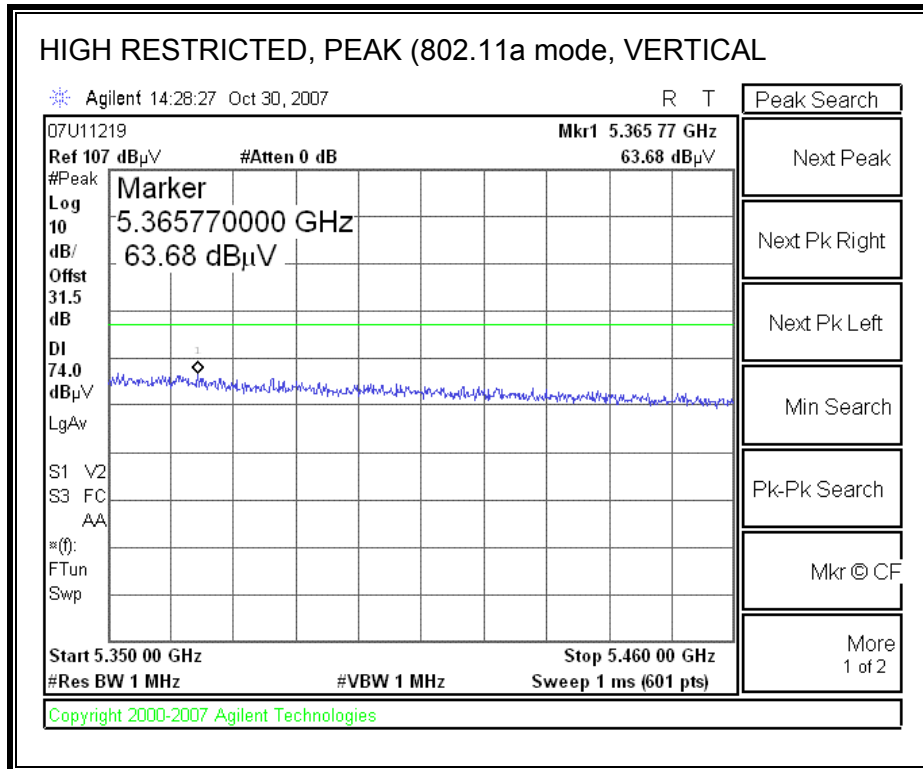

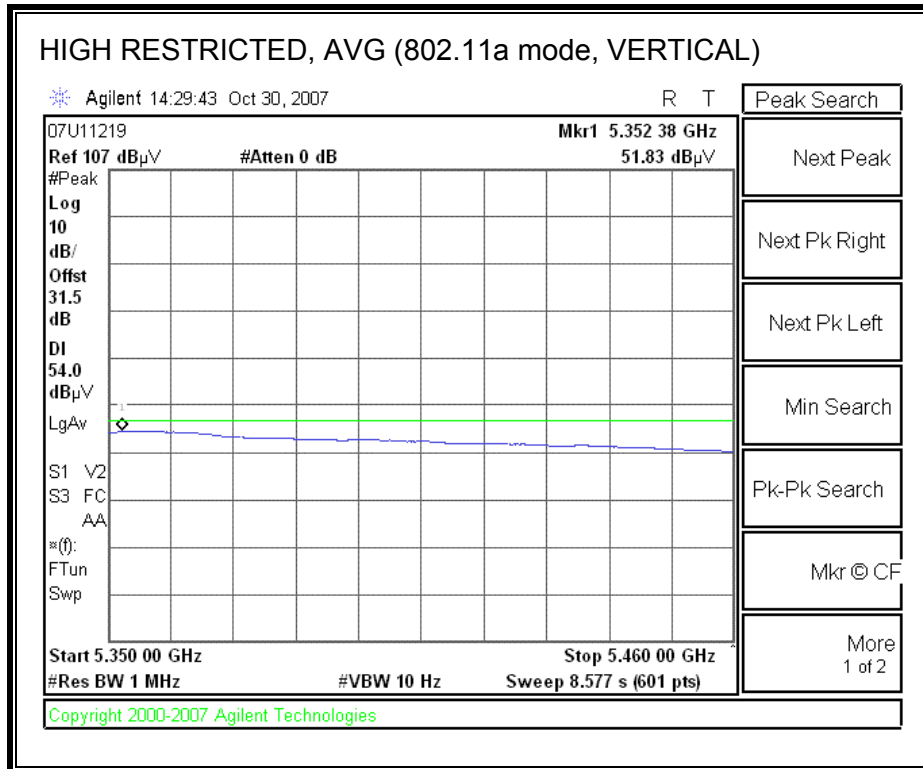

5320MHz

RESTRICTED BANDEDGE (802.11a MODE, HIGH CHANNEL, HORIZONTAL)

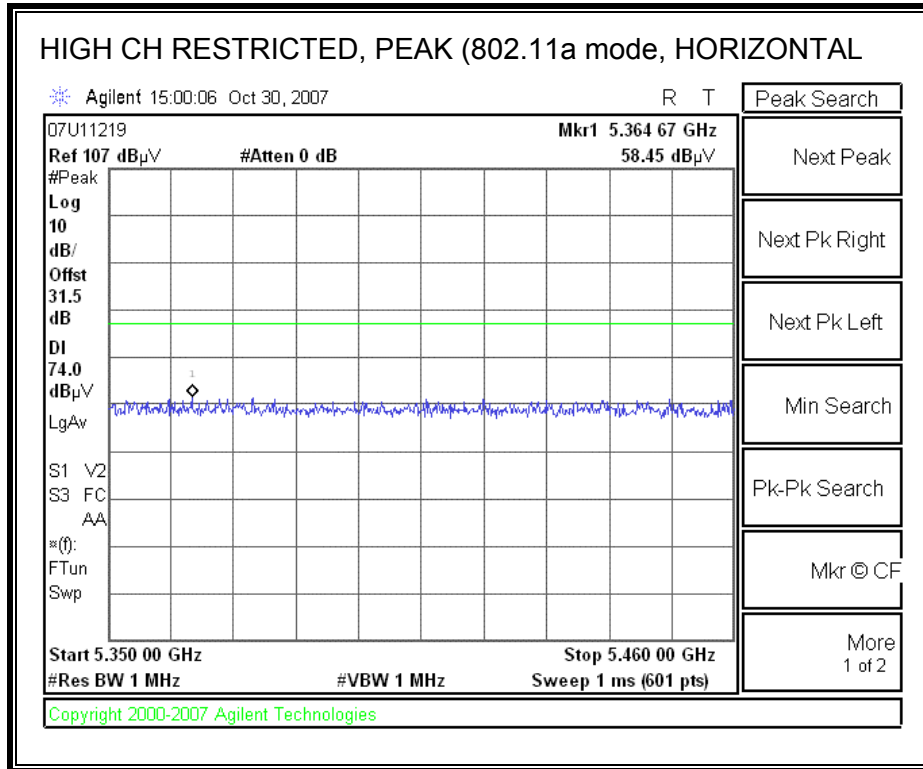

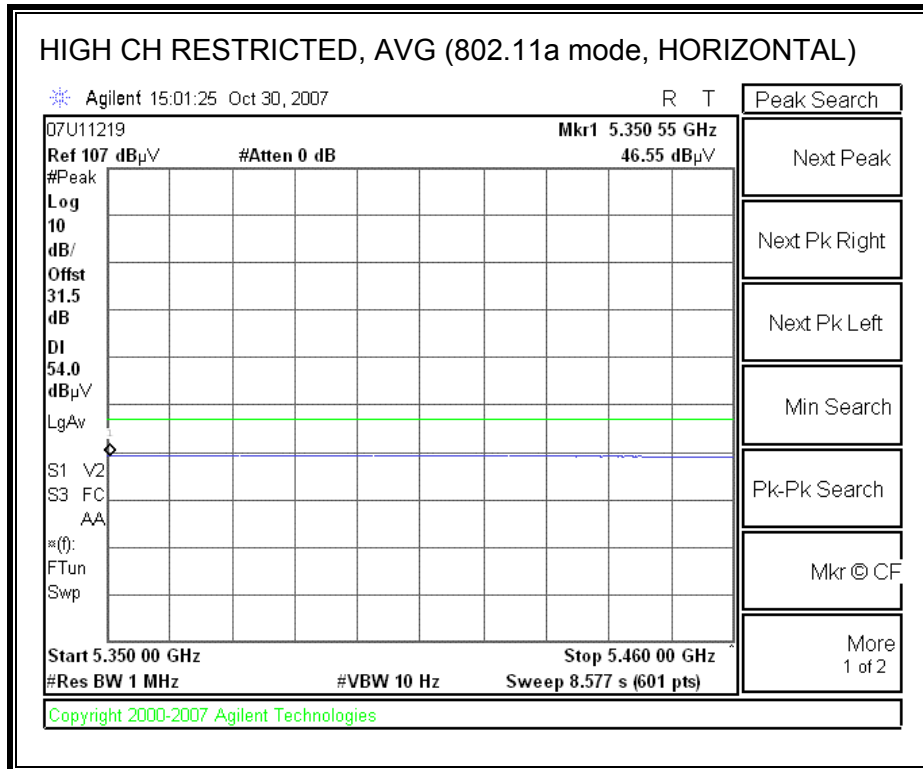

RESTRICTED BANDEDGE (802.11a MODE, HIGH CHANNEL, VERTICAL)

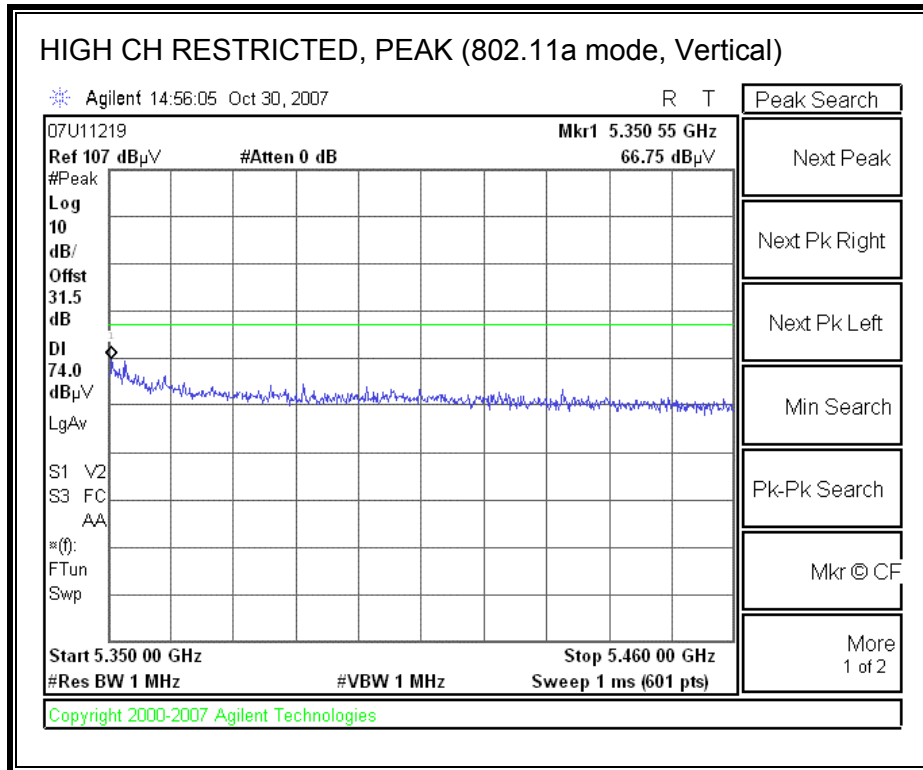

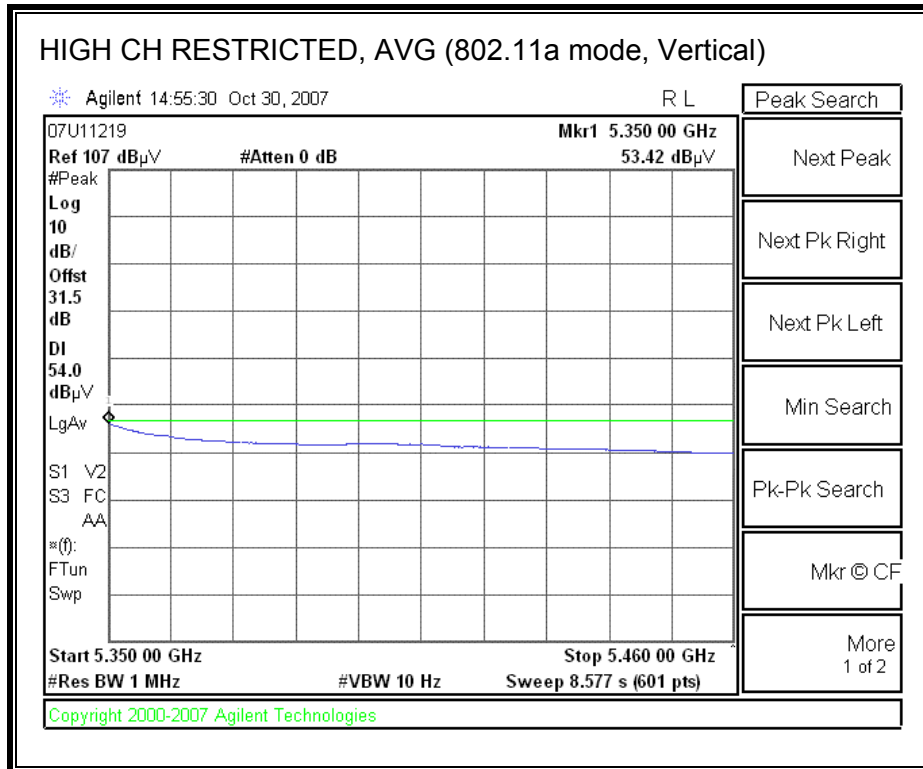

HARMONICS AND SPURIOUS EMISSIONS (802.11a MODE)

High Frequency Measurement
 Compliance Certification Services, Fremont 5m Chamber

Company: Skypilot
 Project #: 07U11219
 Date: 10/30/2007
 Test Engineer: Chin Pang
 Configuration: EUT?Laptop
 Mode: TX, 5.2GHz Band

Test Equipment:

Horn 1-18GHz	Pre-amplifier 1-26GHz	Pre-amplifier 26-40GHz	Horn > 18GHz	Limit
T60; S/N: 2238 @3m	T144 Miteq 3008A00931	T88 Miteq 26-40GHz	T39; ARA 18-26GHz; S/N:1013	FCC 15.209

Hi Frequency Cables

2 foot cable	3 foot cable	12 foot cable	HPF	Reject Filter	Peak Measurements RBW=VBW=1MHz
		A-5m Chamber	HPF_7.6GHz		Average Measurements RBW=1MHz; VBW=10Hz

f GHz	Dist (m)	Read Pk dBuV	Read Avg. dBuV	AF dB/m	CL dB	Amp dB	D Corr dB	Filtr dB	Peak dBuV/m	Avg dBuV/m	Pk Lim dBuV/m	Avg Lim dBuV/m	Pk Mar dB	Avg Mar dB	Notes (V/H)
Low Ch, 5270MHz															
10.540	3.0	46.0	31.0	37.4	10.6	-36.7	0.0	0.8	58.1	43.1	74	54	-15.9	-10.9	Y
15.826	3.0	44.0	29.5	37.9	12.8	-34.6	0.0	0.7	60.8	46.3	74	54	-13.2	-7.7	Y
10.540	3.0	49.1	35.3	37.4	10.6	-36.7	0.0	0.8	61.2	47.4	74	54	-12.8	-6.6	H
15.826	3.0	43.0	29.3	37.9	12.8	-34.6	0.0	0.7	59.8	46.1	74	54	-14.2	-7.9	H
Mid Ch, 5280MHz															
10.560	3.0	44.2	30.5	37.4	10.6	-36.6	0.0	0.8	56.3	42.6	74	54	-17.7	-11.4	Y
15.840	3.0	43.0	29.0	37.9	12.8	-34.6	0.0	0.7	59.8	45.8	74	54	-14.2	-8.2	Y
10.560	3.0	45.0	32.2	37.4	10.6	-36.6	0.0	0.8	57.1	44.3	74	54	-16.9	-9.7	H
15.840	3.0	42.9	29.0	37.9	12.8	-34.6	0.0	0.7	59.7	45.8	74	54	-14.3	-8.2	H
High Ch, 5320MHz															
10.640	3.0	45.1	31.0	37.3	10.7	-36.6	0.0	0.8	57.4	43.3	74	54	-16.6	-10.7	Y
15.960	3.0	42.0	28.8	37.8	12.8	-34.5	0.0	0.7	58.9	45.7	74	54	-15.1	-8.3	Y
10.640	3.0	48.7	34.5	37.3	10.7	-36.6	0.0	0.8	61.0	46.8	74	54	-13.0	-7.2	H
15.960	3.0	43.0	29.0	37.8	12.8	-34.5	0.0	0.7	59.9	45.9	74	54	-14.1	-8.1	H

Rev. 4127
Note: No other emissions were detected above the system noise floor.

f	Measurement Frequency	Amp	Preamp Gain	Avg Lim	Average Field Strength Limit
Dist	Distance to Antenna	D Corr	Distance Correct to 3 meters	Pk Lim	Peak Field Strength Limit
Read	Analyzer Reading	Avg	Average Field Strength @ 3 m	Avg Mar	Margin vs. Average Limit
AF	Antenna Factor	Peak	Calculated Peak Field Strength	Pk Mar	Margin vs. Peak Limit
CL	Cable Loss	HPF	High Pass Filter		

7.2.3. RECEIVER ABOVE 1 GHz FOR 20 MHz BANDWIDTH IN THE 5 GHz BAND

Note: No emissions were found within above 1GHz of 20dB below the system noise.

7.2.4. WORST-CASE RADIATED EMISSIONS BELOW 1 GHz

SPURIOUS EMISSIONS 30 TO 1000 MHz (WORST-CASE CONFIGURATION, HORIZONTAL)

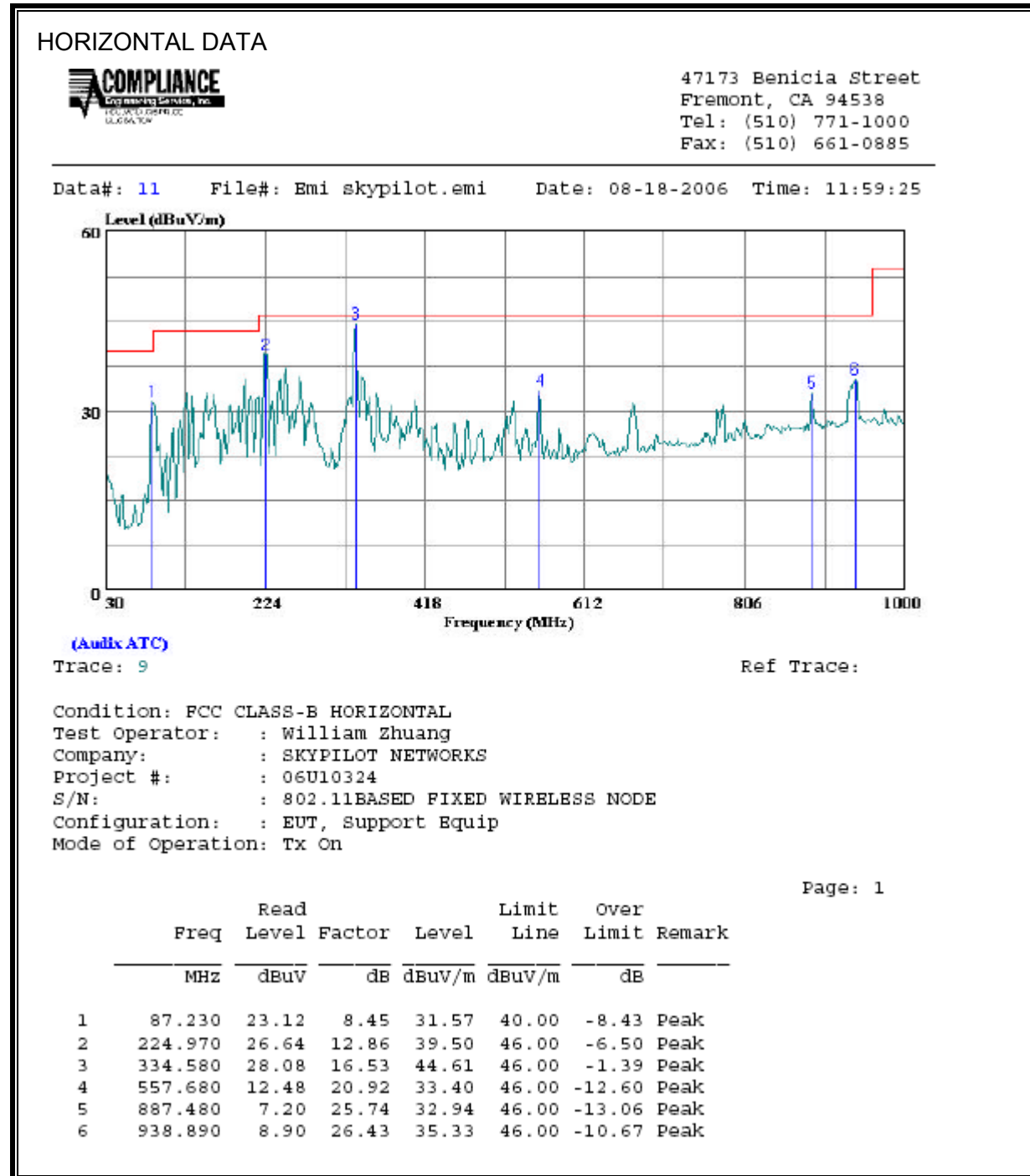

SPURIOUS EMISSIONS 30 TO 1000 MHz (WORST-CASE CONFIGURATION, VERTICAL)

VERTICAL DATA



47173 Benicia Street
 Fremont, CA 94538
 Tel: (510) 771-1000
 Fax: (510) 661-0885

Data#: 10 File#: Emi skypilot.emi Date: 08-18-2006 Time: 11:55:19

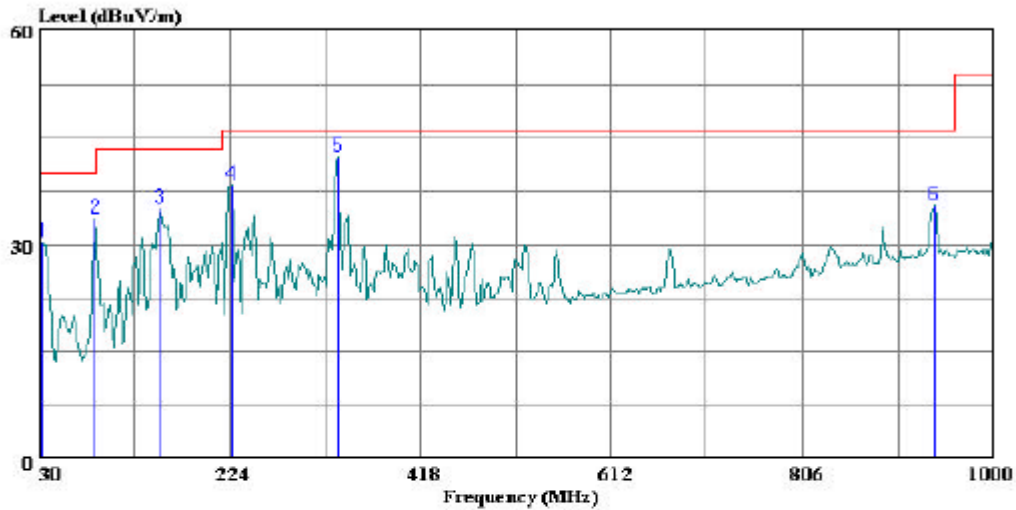

(Auxil ATC)

Trace: 8

Ref Trace:

Condition: FCC CLASS-B VERTICAL
 Test Operator: : William Zhuang
 Company: : SKYPILOT NETWORKS
 Project #: : 06U10324
 S/N: : 802.11BASED FIXED WIRELESS NODE
 Configuration: : EUT, Support Equip
 Mode of Operation: Tx On

Page: 1

	Read	Limit	Over			
Freq	Level	Factor	Level	Line	Limit	Remark
MHz	dBuV	dB	dBuV/m	dBuV/m	dB	
1	33.880	11.17	19.05	30.22	40.00	-9.78 Peak
2	87.230	25.12	8.45	33.57	40.00	-6.43 Peak
3	153.190	21.03	14.03	35.06	43.50	-8.44 Peak
4	225.940	25.44	12.91	38.35	46.00	-7.65 Peak
5	334.580	25.85	16.53	42.38	46.00	-3.62 Peak
6	938.890	9.02	26.43	35.45	46.00	-10.55 Peak

8. DYNAMIC FREQUENCY SELECTION

8.1. OVERVIEW

8.1.1. LIMITS

§15.407 (h) and FCC 06-96 APPENDIX "COMPLIANCE MEASUREMENT PROCEDURES FOR UNLICENSED-NATIONAL INFORMATION INFRASTRUCTURE DEVICES OPERATING IN THE 5250-5350 MHz AND 5470-5725 MHz BANDS INCORPORATING DYNAMIC FREQUENCY SELECTION".

Table 1: Applicability of DFS requirements prior to use of a channel

Requirement	Operational Mode		
	Master	Client (without radar detection)	Client (with radar detection)
<i>Non-Occupancy Period</i>	Yes	Not required	Yes
<i>DFS Detection Threshold</i>	Yes	Not required	Yes
<i>Channel Availability Check Time</i>	Yes	Not required	Not required
<i>Uniform Spreading</i>	Yes	Not required	Not required

Table 2: Applicability of DFS requirements during normal operation

Requirement	Operational Mode		
	Master	Client (without DFS)	Client (with DFS)
<i>DFS Detection Threshold</i>	Yes	Not required	Yes
<i>Channel Closing Transmission Time</i>	Yes	Yes	Yes
<i>Channel Move Time</i>	Yes	Yes	Yes

Table 3: Interference Threshold values, Master or Client incorporating In-Service Monitoring

Maximum Transmit Power	Value (see note)
≥ 200 milliwatt	-64 dBm
< 200 milliwatt	-62 dBm
Note 1: This is the level at the input of the receiver assuming a 0 dBi receive antenna Note 2: Throughout these test procedures an additional 1 dB has been added to the amplitude of the test transmission waveforms to account for variations in measurement equipment. This will ensure that the test signal is at or above the detection threshold level to trigger a DFS response.	

Table 4: DFS Response requirement values

Parameter	Value
<i>Non-occupancy period</i>	30 minutes
<i>Channel Availability Check Time</i>	60 seconds
<i>Channel Move Time</i>	10 seconds
<i>Channel Closing Transmission Time</i>	200 milliseconds + approx. 60 milliseconds over remaining 10 second period
<p>The instant that the <i>Channel Move Time</i> and the <i>Channel Closing Transmission Time</i> begins is as follows:</p> <ul style="list-style-type: none"> • For the Short pulse radar Test Signals this instant is the end of the <i>Burst</i>. • For the Frequency Hopping radar Test Signal, this instant is the end of the last radar burst generated. • For the Long Pulse radar Test Signal this instant is the end of the 12 second period defining the radar transmission. <p>The Channel Closing Transmission Time is comprised of 200 milliseconds starting at the beginning of the Channel Move Time plus any additional intermittent control signals required to facilitate channel changes (an aggregate of approximately 60 milliseconds) during the remainder of the 10 second period. The aggregate duration of control signals will not count quiet periods in between transmissions.</p>	

Table 5 – Short Pulse Radar Test Waveforms

Radar Type	Pulse Width (Microseconds)	PRI (Microseconds)	Pulses	Minimum Percentage of Successful Detection	Minimum Trials
1	1	1428	18	60%	30
2	1-5	150-230	23-29	60%	30
3	6-10	200-500	16-18	60%	30
4	11-20	200-500	12-16	60%	30
Aggregate (Radar Types 1-4)				80%	120

Table 6 – Long Pulse Radar Test Signal

Radar Waveform	Bursts	Pulses per Burst	Pulse Width (µsec)	Chirp Width (MHz)	PRI (µsec)	Minimum Percentage of Successful Detection	Minimum Trials
5	8-20	1-3	50-100	5-20	1000-2000	80%	30

Table 7 – Frequency Hopping Radar Test Signal

Radar Waveform	Pulse Width (µsec)	PRI (µsec)	Burst Length (ms)	Pulses per Hop	Hopping Rate (kHz)	Minimum Percentage of Successful Detection	Minimum Trials
6	1	333	300	9	.333	70%	30

8.1.2. TEST AND MEASUREMENT SYSTEM

CONDUCTED METHOD SYSTEM BLOCK DIAGRAM

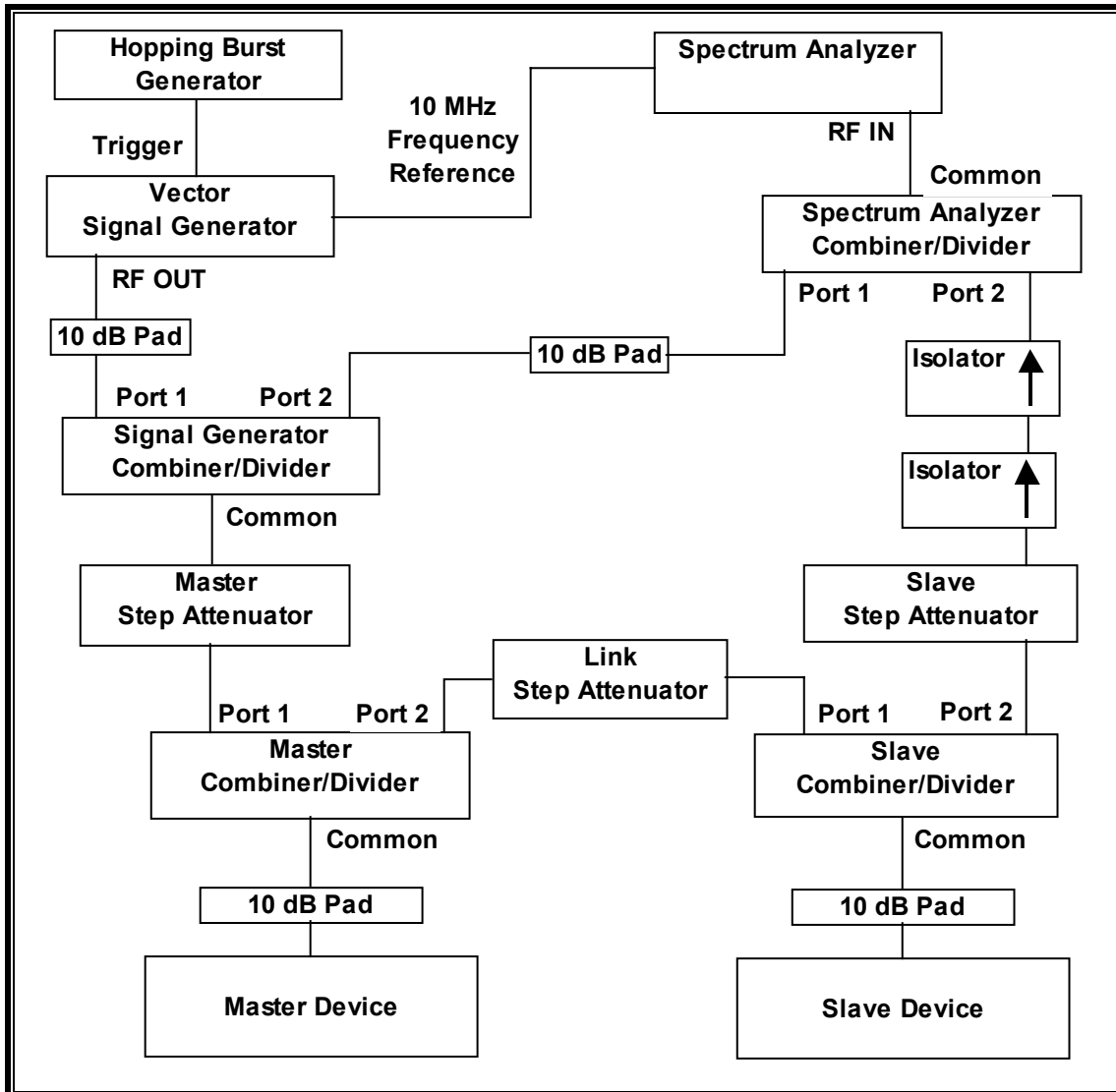

SYSTEM OVERVIEW

The short pulse and long pulse signal generating system utilizes the NTIA software. The Vector Signal Generator has been validated by the NTIA. The hopping signal generating system utilizes the CCS simulated hopping method and system, which has been validated by the DoD, FCC and NTIA. The software selects waveform parameters from within the bounds of the signal type on a random basis using uniform distribution.

The short pulse types 2, 3 and 4, and the long pulse type 5 parameters are randomized at run-time.

The hopping type 6 pulse parameters are fixed while the hopping sequence is based on the August 2005 NTIA Hopping Frequency List. The initial starting point randomized at run-time and each subsequent starting point is incremented by 475. Each frequency in the 100-length segment is compared to the boundaries of the EUT Detection Bandwidth and the software creates a hopping burst pattern in accordance with Section 7.4.1.3 Method #2 Simulated Frequency Hopping Radar Waveform Generating Subsystem of FCC 06-96 APPENDIX. The frequency of the signal generator is incremented in 1 MHz steps from F_L to F_H for each successive trial. This incremental sequence is repeated as required to generate a minimum of 30 total trials and to maintain a uniform frequency distribution over the entire Detection Bandwidth.

The signal monitoring equipment consists of a spectrum analyzer set to display 8001 bins on the horizontal axis. The time-domain resolution is 2 msec / bin with a 16 second sweep time, meeting the 10 second short pulse reporting criteria. The aggregate ON time is calculated by multiplying the number of bins above a threshold during a particular observation period by the dwell time per bin, with the analyzer set to peak detection and max hold.

Should multiple RF ports be utilized for the Master and/or Slave devices (for example, for diversity or MIMO implementations), additional combiner/dividers are inserted between the Master Combiner/Divider and the pad connected to the Master Device (and/or between the Slave Combiner/Divider and the pad connected to the Slave Device). Additional pads are utilized such that there is one pad at each RF port on each EUT.

SYSTEM CALIBRATION

A 50 ohm load is connected in place of the spectrum analyzer, and the spectrum analyzer is connected in place of the master device and the signal generator is set to CW mode. The amplitude of the signal generator is adjusted to yield a level of -64 dBm as measured on the spectrum analyzer.

Without changing any of the instrument settings, the spectrum analyzer is reconnected to the Common port of the Spectrum Analyzer Combiner/Divider. Measure the amplitude and calculate the difference from -64 dBm. Adjust the Reference Level Offset of the spectrum analyzer to this difference.

The spectrum analyzer displays the level of the signal generator as received at the antenna ports of the Master Device. The interference detection threshold may be varied from the calibrated value of -64 dBm and the spectrum analyzer will still indicate the level as received by the Master Device.

Set the signal generator to produce a radar waveform, trigger a burst manually and measure the level on the spectrum analyzer. Readjust the amplitude of the signal generator as required so that the peak level of the waveform is at a displayed level equal to the required or desired interference detection threshold. Separate signal generator amplitude settings are determined as required for each radar type.

ADJUSTMENT OF DISPLAYED TRAFFIC LEVEL

Establish a link between the Master and Slave, adjusting the Link Step Attenuator as needed to provide a suitable received level at the Master and Slave devices. Stream the video test file to generate WLAN traffic. Confirm that the WLAN traffic level, as displayed on the spectrum analyzer, is at lower amplitude than the radar detection threshold. For Master Device testing confirm that the displayed traffic does not include Slave Device traffic. For Slave Device testing confirm that the displayed traffic does not include Master Device traffic.

If a different setting of the Master Step Attenuator is required to meet the above conditions, perform a new System Calibration for the new Master Step Attenuator setting.

TEST AND MEASUREMENT EQUIPMENT

The following test and measurement equipment was utilized for the DFS tests documented in this report:

TEST EQUIPMENT LIST				
Description	Manufacturer	Model	Serial Number	Cal Due
Spectrum Analyzer 26.5 GHz	Agilent / HP	E4407B	US41444322	11/1/2008
Vector Signal Generator 20GHz	Agilent / HP	E8267C	US43320336	11/16/2009

CONDUCTED METHOD EUT TEST SETUP

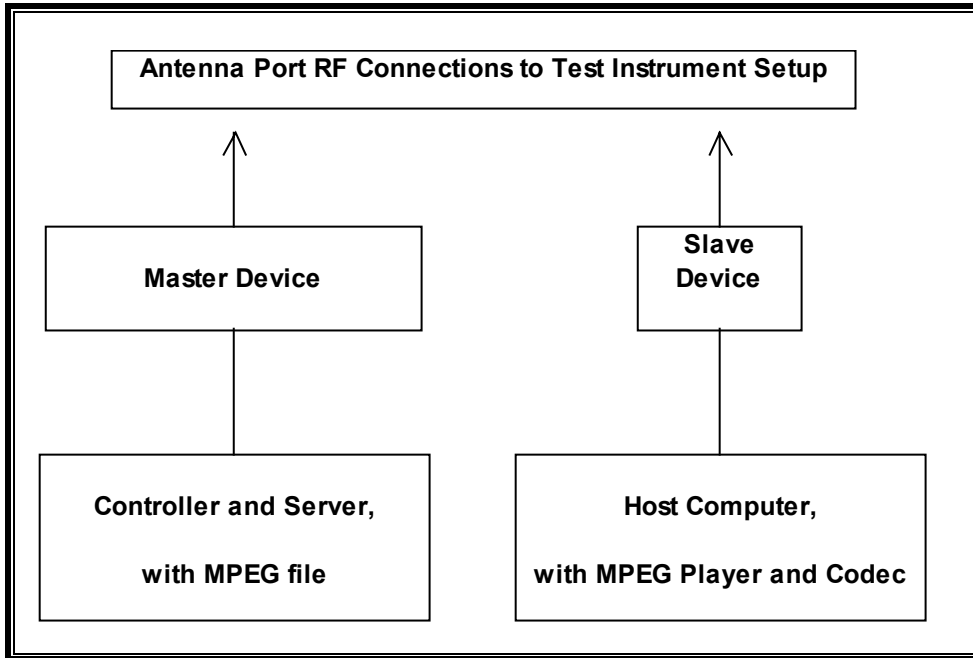

SUPPORT EQUIPMENT

The following test and measurement equipment was utilized for the DFS tests documented in this report:

PERIPHERAL SUPPORT EQUIPMENT LIST				
Description	Manufacturer	Model	Serial Number	FCC ID
AC Adapter	DELL	AA20031	CN-09364-16291-1BN-0FYT	DoC
Laptop	DELL	Inspiron 8100	CN-03N642-12961-21E-8194	DoC
AC Adapter	Compaq	PPP012L	565BC0ALL0J1BE	DoC
Laptop	Compaq	Presario 3000	CNU327025L	DoC

8.1.3. DESCRIPTION OF EUT

The EUT operates over the 5250-5350 MHz range.

The EUT is a Slave Device without radar detection.

The highest power level within these bands is 30 dBm EIRP.

The antenna assembly utilized with the EUT has a gain of 16.5 dBi.

The EUT uses one transmitter connected to a 50-ohm coaxial antenna port. The antenna port is connected to the test system to perform conducted tests.

WLAN traffic is generated by streaming the video file TestFile.mp2 "6 ½ Magic Hours" from the Master to the Slave in full motion video mode using the media player with the V2.61 Codec package.

TPC is required since the maximum EIRP is greater than 500 mW (27 dBm).

The EUT utilizes the 802.11a architecture. One nominal channel bandwidth, 20 MHz, is implemented.

OVERVIEW OF MASTER DEVICE WITH RESPECT TO §15.407 (h) REQUIREMENTS

The Master Device is a SkyExtender Access Point, FCC ID:RV7-SD1085. The DFS software installed in the Master Device is revision 1.5P2. The minimum antenna gain for the Master Device is 18 dBi.

The rated output power of the Master unit is > 18 dBm (EIRP). Therefore the required interference threshold level is -64 dBm. After correction for antenna gain and procedural adjustments, the required conducted threshold at the antenna port is $-64 + 18 + 1 = -45$ dBm.

The calibrated conducted DFS Detection Threshold level is set to -45 dBm.

MANUFACTURER'S STATEMENT REGARDING TPC

This statement is in a separate document.

8.2. 5250-5350 MHz BAND

8.2.1. TEST CHANNEL AND METHOD

All tests were performed at a channel center frequency of 5300 MHz. Measurements were performed using conducted test methods.

8.2.2. PLOTS OF RADAR WAVEFORM, AND WLAN TRAFFIC

PLOTS OF RADAR WAVEFORMS

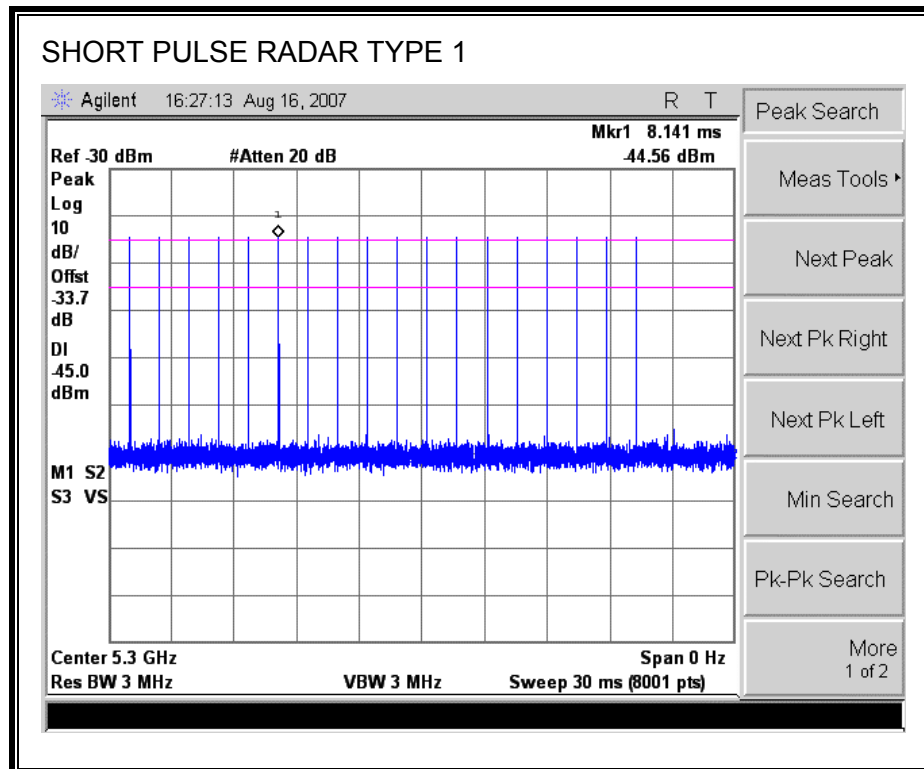

PLOT OF WLAN TRAFFIC FROM SLAVE

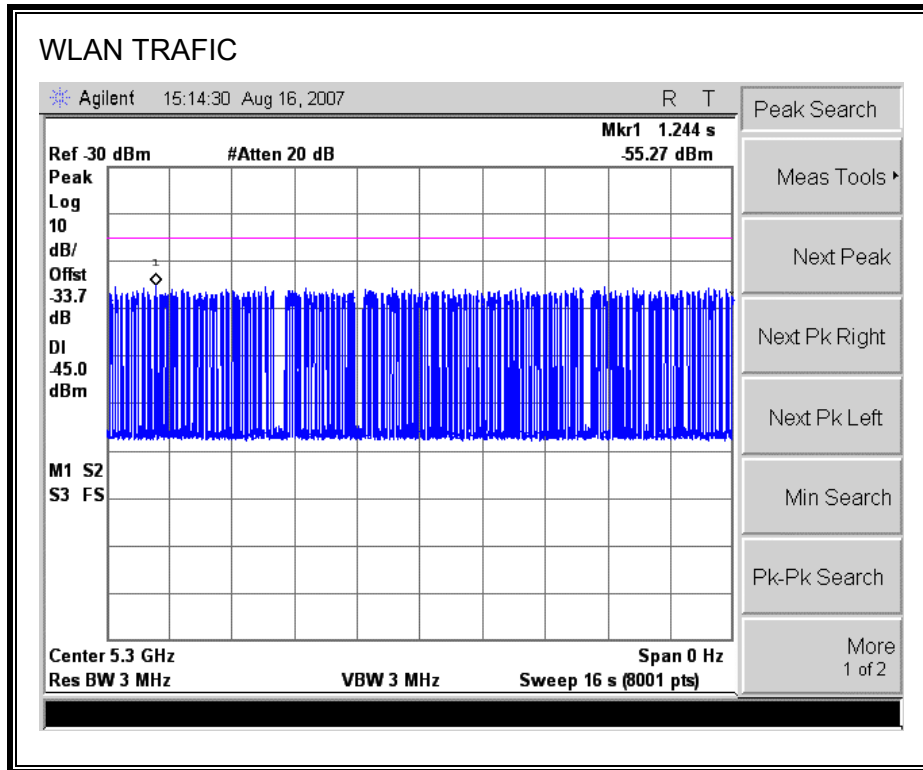

8.2.3. SLAVE DEVICE CONFIGURATION - CHANNEL MOVE TIME AND CHANNEL CLOSING TRANSMISSION TIME

REPORTING NOTES

The reference marker is set at the end of last radar pulse.

The delta marker is set at the end of the last WLAN transmission following the radar pulse. This delta is the channel move time.

The aggregate channel closing transmission time is calculated as follows:

Aggregate Transmission Time =
(Number of analyzer bins showing transmission) * (dwell time per bin)

FCC

The observation period over which the aggregate time is calculated

Begins at (Reference Marker + 200 msec)

and

Ends no earlier than (Reference Marker + 10 sec).

IC

The observation period over which the aggregate time is calculated

Begins at (Reference Marker)

and

Ends no earlier than (Reference Marker + 10 sec).

CHANNEL MOVE TIME RESULTS

No non-compliance noted:

Channel Move Time (s)	Limit (s)
0.000	10

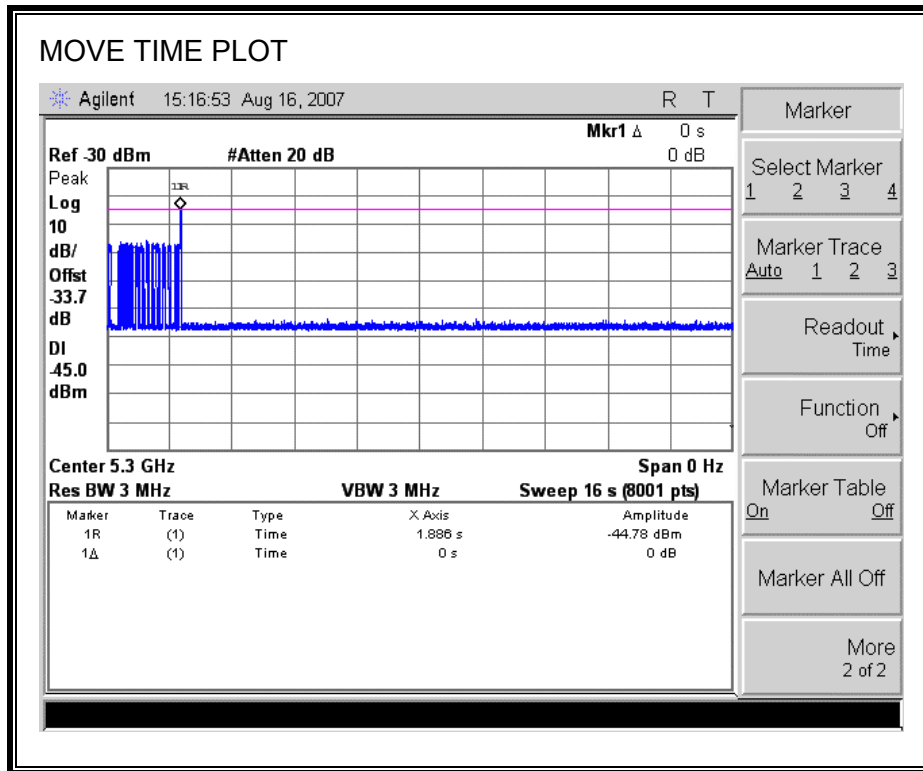

CHANNEL CLOSING TIME RESULTS

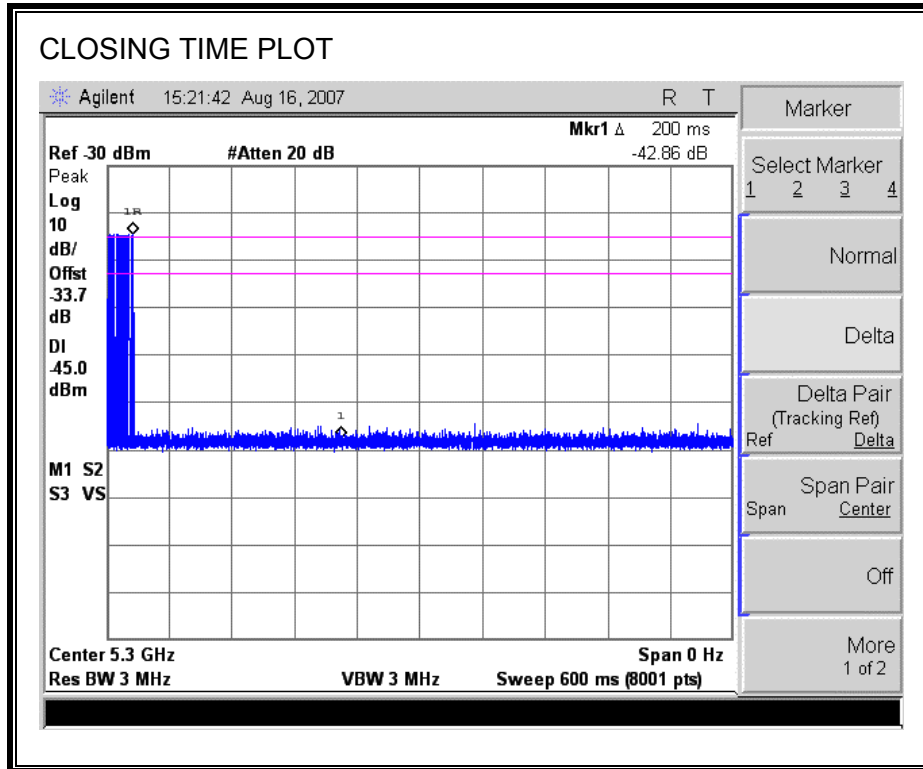

FCC AGGREGATE CHANNEL CLOSING TRANSMISSION TIME RESULTS

No non-compliance noted:

Aggregate Transmission Time (ms)	Limit (ms)	Margin (ms)
0.00	60	60.00

No transmissions are observed during the aggregate monitoring period.

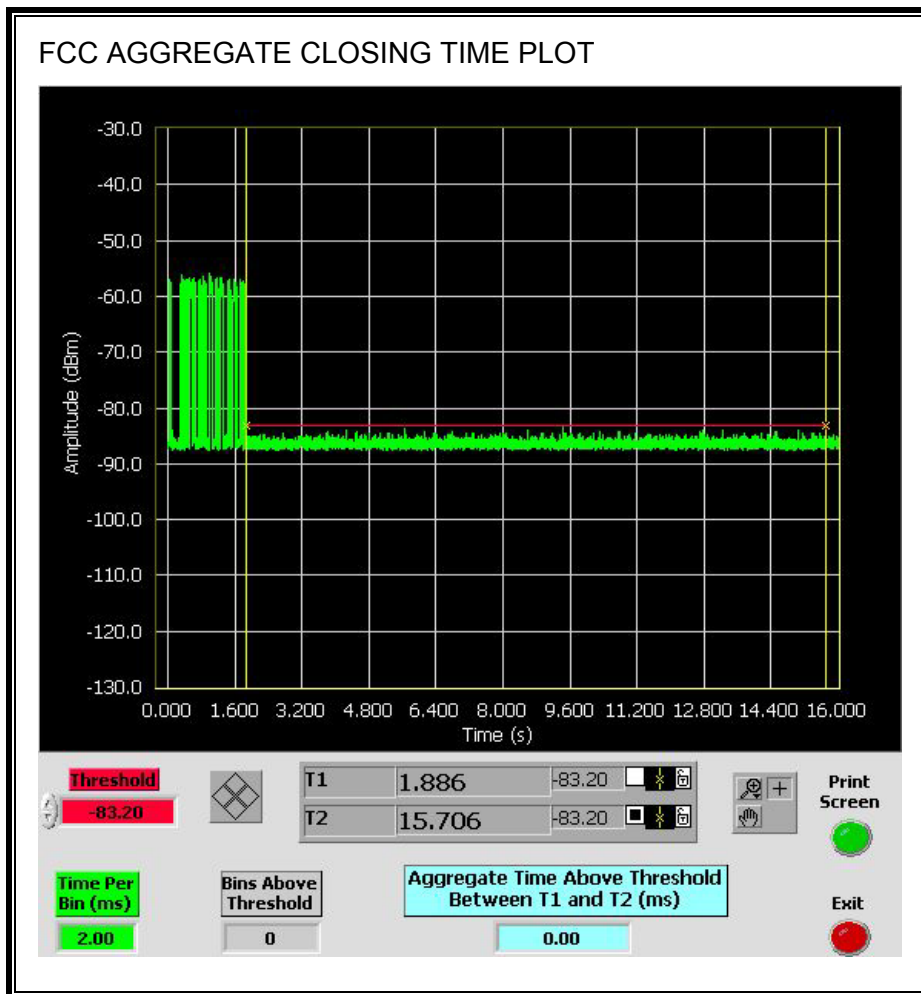

IC AGGREGATE CHANNEL CLOSING TRANSMISSION TIME RESULTS

No non-compliance noted:

Aggregate Transmission Time (ms)	Limit (ms)	Margin (ms)
0.00	260	260.00

Only intermittent transmissions are observed during the aggregate monitoring period.

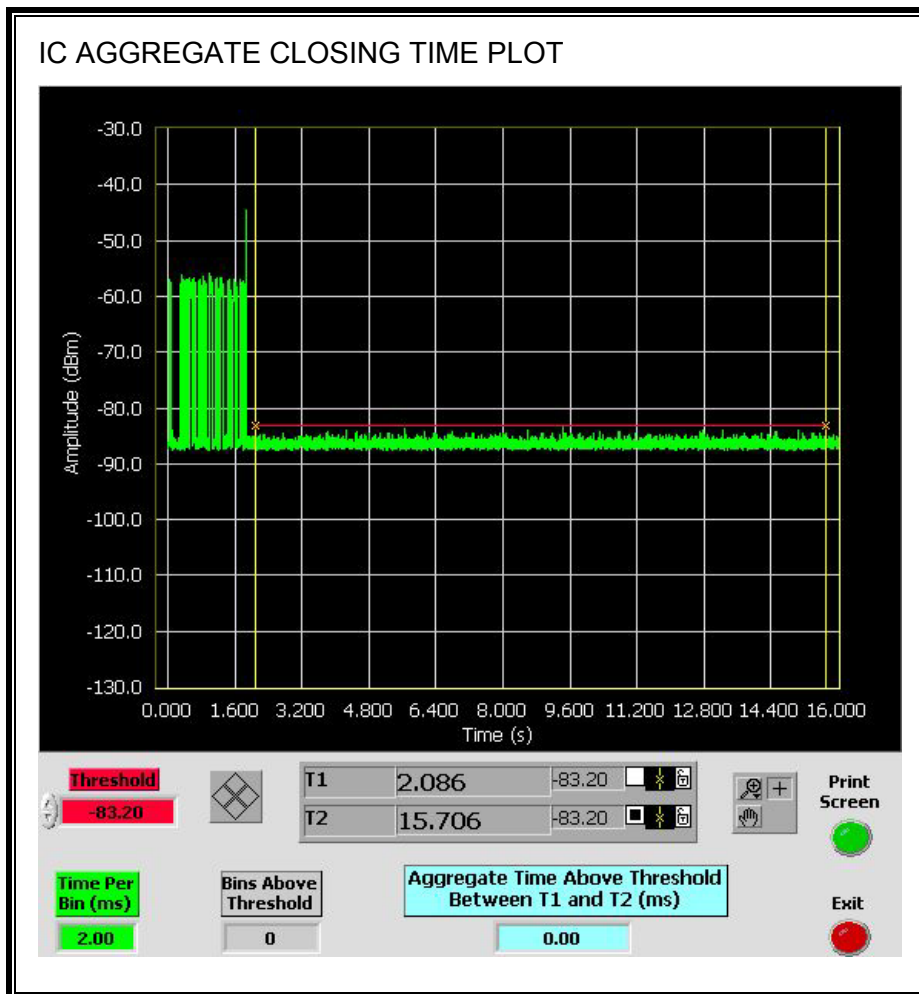

8.2.4. NON-OCCUPANCY PERIOD

ASSOCIATED TEST RESULTS

No EUT transmissions were observed on the test channel during the 30-minute observation time.

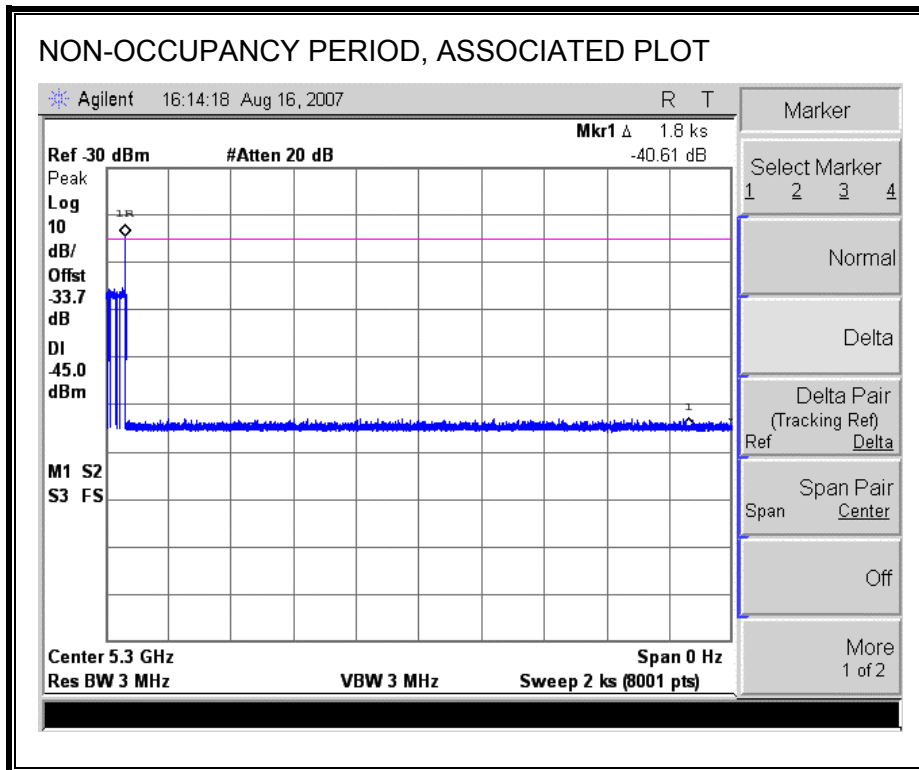

NON-ASSOCIATED TEST RESULTS

No EUT transmissions were observed on the test channel during the 30-minute observation time.

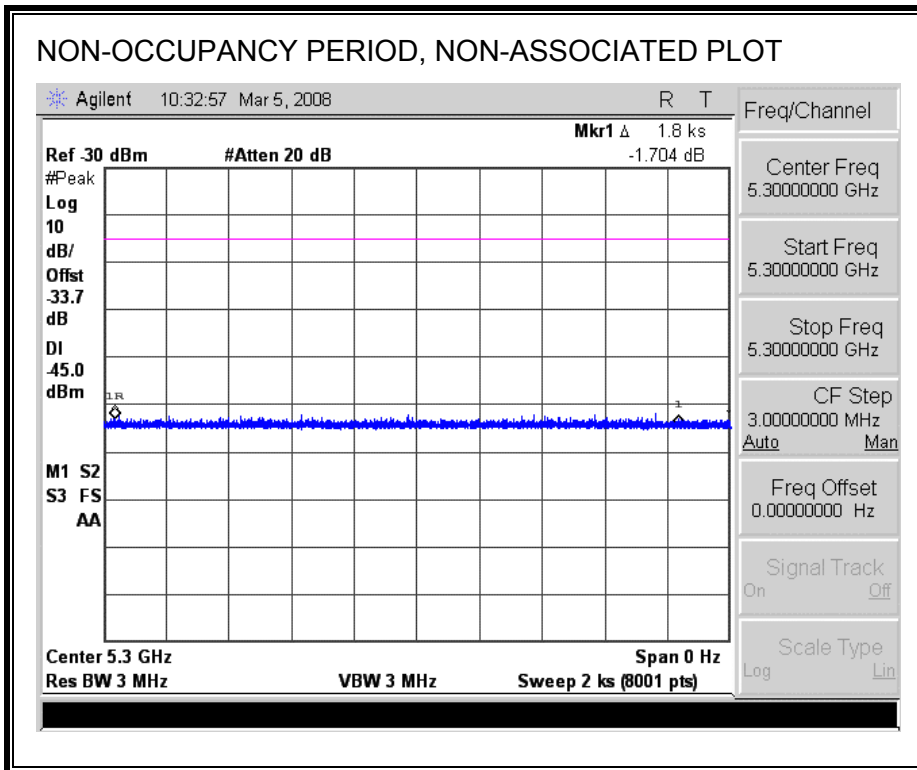

9. AC POWER LINE CONDUCTED EMISSIONS

LIMITS

FCC §15.207 (a)

RSS-Gen 7.2.2

Frequency of Emission (MHz)	Conducted Limit (dBuV)	
	Quasi-peak	Average
0.15-0.5	66 to 56*	56 to 46*
0.5-5	56	46
5-30	60	50

*Decreases with the logarithm of the frequency.

TEST PROCEDURE

The EUT is placed on a non-conducting table 40 cm from the vertical ground plane and 80 cm above the horizontal ground plane. The EUT is configured in accordance with ANSI C63.4.

The receiver is set to a resolution bandwidth of 9 kHz. Peak detection is used unless otherwise noted as quasi-peak or average.

Line conducted data is recorded for both NEUTRAL and HOT lines.

RESULTS

6 WORST EMISSIONS

CONDUCTED EMISSIONS DATA (115VAC 60Hz)										
Freq. (MHz)	Reading			Class (dB)	Limit QP	EN B		Margin		Remark L1 / L2
	PK (dBuV)	QP (dBuV)	AV (dBuV)			AV	QP (dB)	AV (dB)		
0.16	54.60		44.33	0.00	65.73	55.73	-65.73	-11.40	L1	
0.42	42.26		38.82	0.00	57.43	47.43	-57.43	-8.61	L1	
0.47	40.57		37.26	0.00	56.50	46.50	-56.50	-9.24	L1	
0.16	53.81		41.23	0.00	65.67	55.67	-65.67	-14.44	L2	
0.42	45.98		37.24	0.00	57.47	47.47	-57.47	-10.23	L2	
0.47	45.08		35.78	0.00	56.50	46.50	-56.50	-10.72	L2	
6 Worst Data										

LINE 1 RESULTS

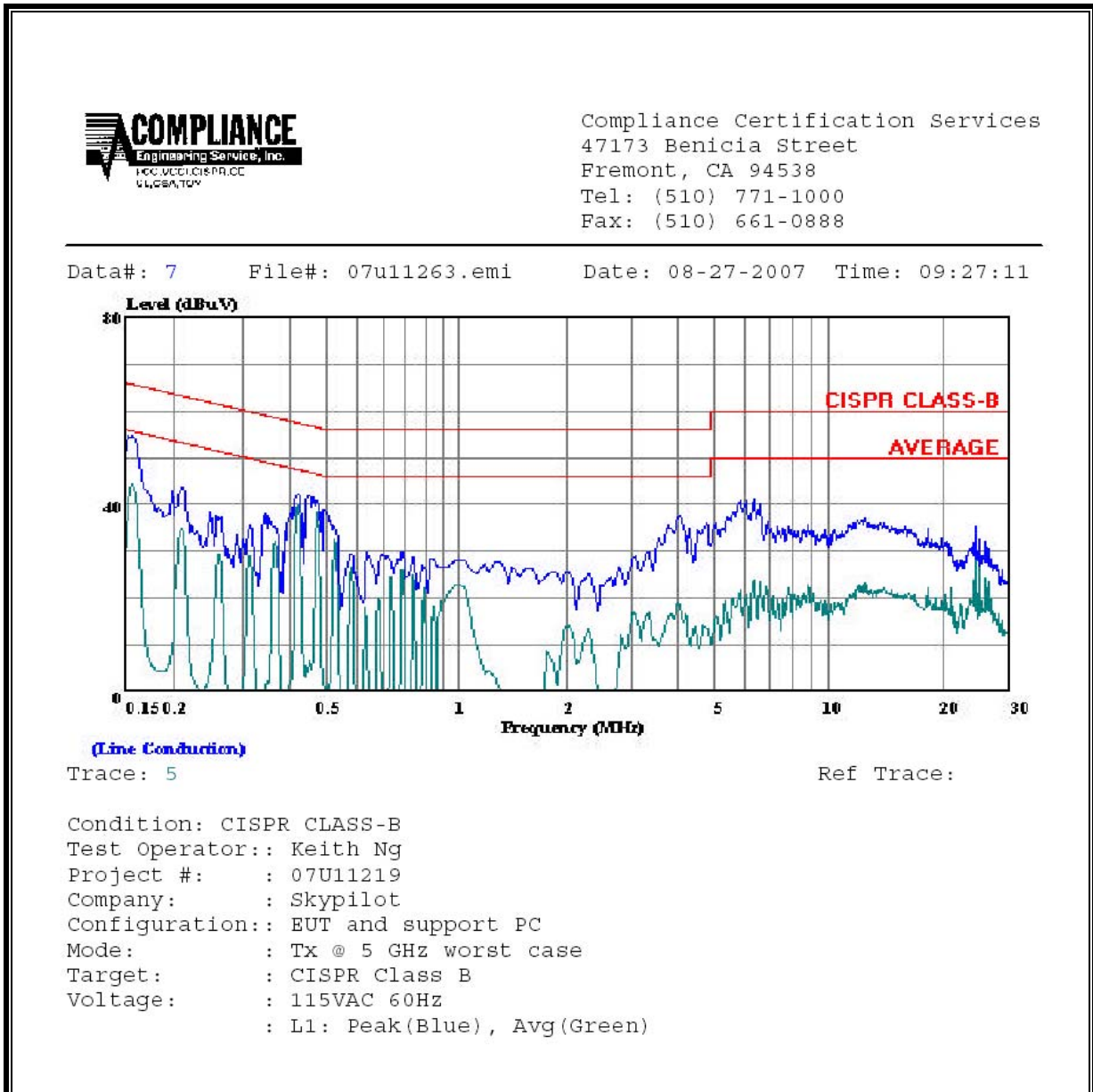

LINE 2 RESULTS

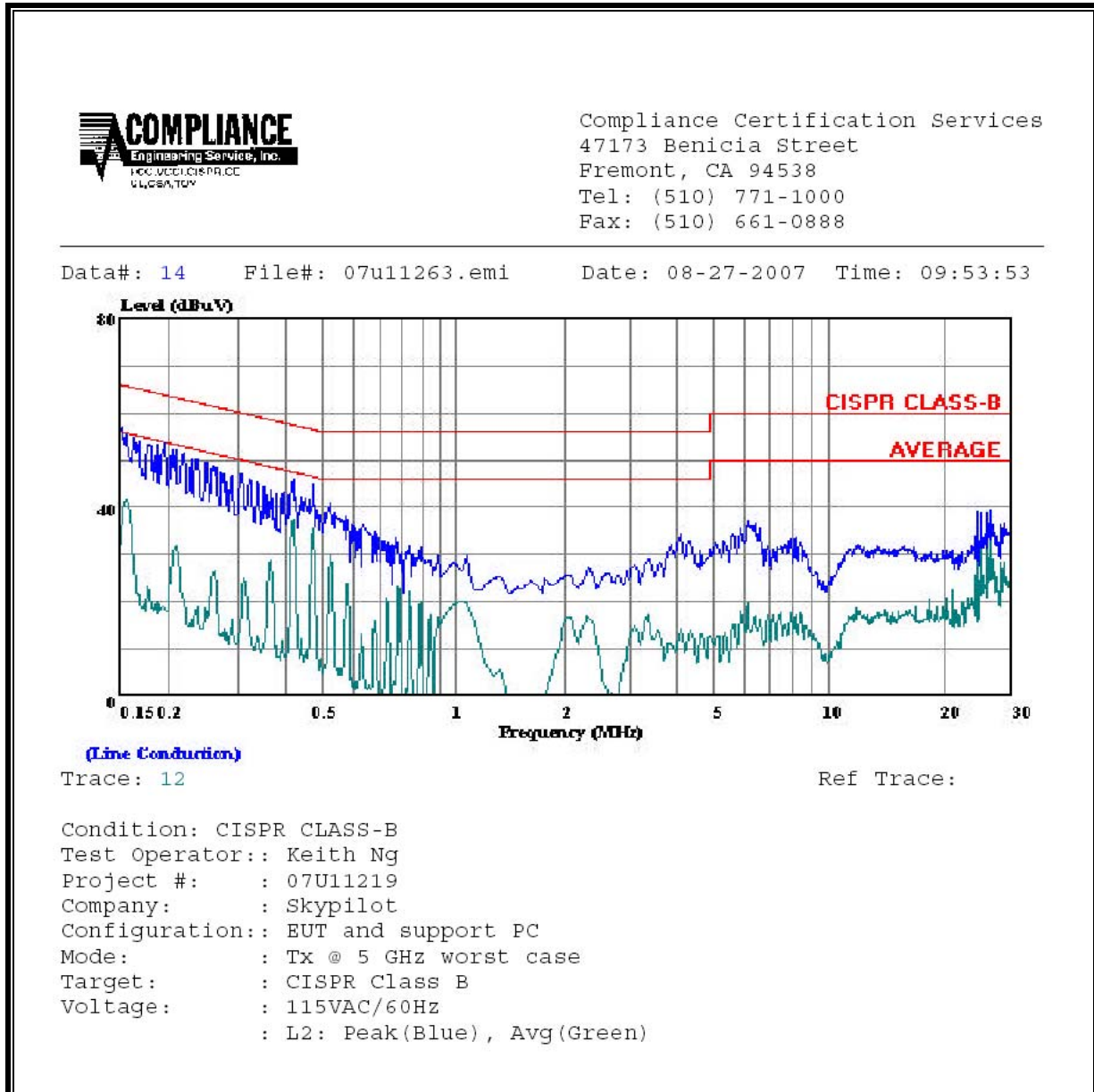

10. MAXIMUM PERMISSIBLE EXPOSURE

FCC RULES

§1.1310 The criteria listed in Table 1 shall be used to evaluate the environmental impact of human exposure to radio-frequency (RF) radiation as specified in §1.1307(b), except in the case of portable devices which shall be evaluated according to the provisions of §2.1093 of this chapter.

TABLE 1—LIMITS FOR MAXIMUM PERMISSIBLE EXPOSURE (MPE)

Frequency range (MHz)	Electric field strength (V/m)	Magnetic field strength (A/m)	Power density (mW/cm ²)	Averaging time (minutes)
(A) Limits for Occupational/Controlled Exposures				
0.3–3.0	614	1.63	*(100)	6
3.0–30	1842/f	4.89/f	*(900/f ²)	6
30–300	61.4	0.163	1.0	6
300–1500	f/300	6
1500–100,000	5	6
(B) Limits for General Population/Uncontrolled Exposure				
0.3–1.34	614	1.63	*(100)	30
1.34–30	824/f	2.19/f	*(180/f ²)	30

TABLE 1—LIMITS FOR MAXIMUM PERMISSIBLE EXPOSURE (MPE)—Continued

Frequency range (MHz)	Electric field strength (V/m)	Magnetic field strength (A/m)	Power density (mW/cm ²)	Averaging time (minutes)
30–300	27.5	0.073	0.2	30
300–1500	f/1500	30
1500–100,000	1.0	30

f = frequency in MHz

* = Plane-wave equivalent power density

NOTE 1 TO TABLE 1: Occupational/controlled limits apply in situations in which persons are exposed as a consequence of their employment provided those persons are fully aware of the potential for exposure and can exercise control over their exposure. Limits for occupational/controlled exposure also apply in situations when an individual is transient through a location where occupational/controlled limits apply provided he or she is made aware of the potential for exposure.

NOTE 2 TO TABLE 1: General population/uncontrolled exposures apply in situations in which the general public may be exposed, or in which persons that are exposed as a consequence of their employment may not be fully aware of the potential for exposure or can not exercise control over their exposure.

IC RULES

IC Safety Code 6, Section 2.2.1 (a) A person other than an RF and microwave exposed worker shall not be exposed to electromagnetic radiation in a frequency band listed in Column 1 of Table 5, if the field strength exceeds the value given in Column 2 or 3 of Table 5, when averaged spatially and over time, or if the power density exceeds the value given in Column 4 of Table 5, when averaged spatially and over time.

**Table 5
 Exposure Limits for Persons Not Classed As RF and Microwave Exposed Workers (Including the General Public)**

1 Frequency (MHz)	2 Electric Field Strength; rms (V/m)	3 Magnetic Field Strength; rms (A/m)	4 Power Density (W/m ²)	5 Averaging Time (min)
0.003–1	280	2.19		6
1–10	280/ <i>f</i>	2.19/ <i>f</i>		6
10–30	28	2.19/ <i>f</i>		6
30–300	28	0.073	2*	6
300–1 500	1.585 <i>f</i> ^{0.5}	0.0042 <i>f</i> ^{0.5}	<i>f</i> /150	6
1 500–15 000	61.4	0.163	10	6
15 000–150 000	61.4	0.163	10	616 000 / <i>f</i> ^{1.2}
150 000–300 000	0.158 <i>f</i> ^{0.5}	4.21 x 10 ⁻⁴ <i>f</i> ^{0.5}	6.67 x 10 ⁻⁵ <i>f</i>	616 000 / <i>f</i> ^{1.2}

* Power density limit is applicable at frequencies greater than 100 MHz.

- Notes:**
1. Frequency, *f*, is in MHz.
 2. A power density of 10 W/m² is equivalent to 1 mW/cm².
 3. A magnetic field strength of 1 A/m corresponds to 1.257 microtesla (μT) or 12.57 milligauss (mG).

CALCULATIONS

Given

$$E = \sqrt{(30 * P * G) / d}$$

and

$$S = E^2 / 3770$$

where

E = Field Strength in Volts/meter

P = Power in Watts

G = Numeric antenna gain

d = Distance in meters

S = Power Density in milliwatts/square centimeter

Combining equations, rearranging the terms to express the distance as a function of the remaining variables, changing to units of Power to mW and Distance to cm, and substituting the logarithmic form of power and gain yields:

$$d = 0.282 * 10^{((P + G) / 20)} / \sqrt{S}$$

where

d = MPE distance in cm

P = Power in dBm

G = Antenna Gain in dBi

S = Power Density Limit in mW/cm²

Rearranging terms to calculate the power density at a specific distance yields

$$S = 0.0795 * 10^{((P + G) / 10)} / (d^2)$$

The power density in units of mW/cm² is converted to units of W/m² by multiplying by a factor of 10.

LIMITS

From FCC §1.1310 Table 1 (B), the maximum value of S = 1.0 mW/cm²

From IC Safety Code 6, Section 2.2 Table 5 Column 4, S = 10 W/m²

RESULTS

Mode	Band	MPE Distance (cm)	Output Power (dBm)	Antenna Gain (dBi)	FCC Power Density (mW/cm ²)	IC Power Density (W/m ²)
WLAN	5 GHz	20.0	11.36	16.50	0.12	1.21

NOTE: For mobile or fixed location transmitters, the minimum separation distance is 20 cm, even if calculations indicate that the MPE distance would be less.

11. SETUP PHOTOS

ANTENNA PORT CONDUCTED RF MEASUREMENT SETUP

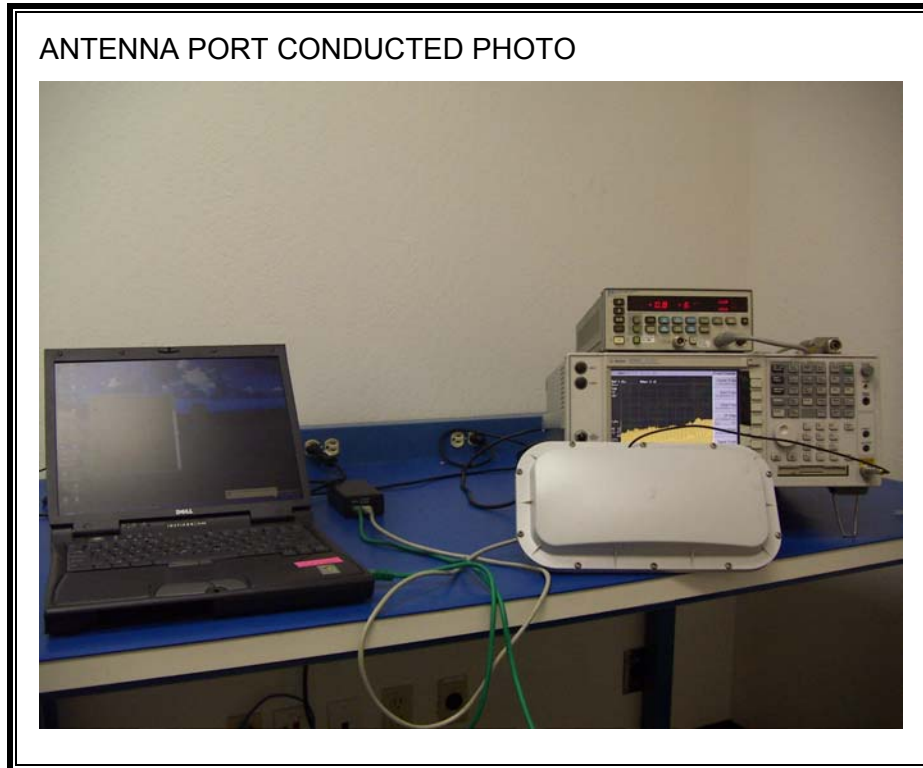

RADIATED RF MEASUREMENT SETUP

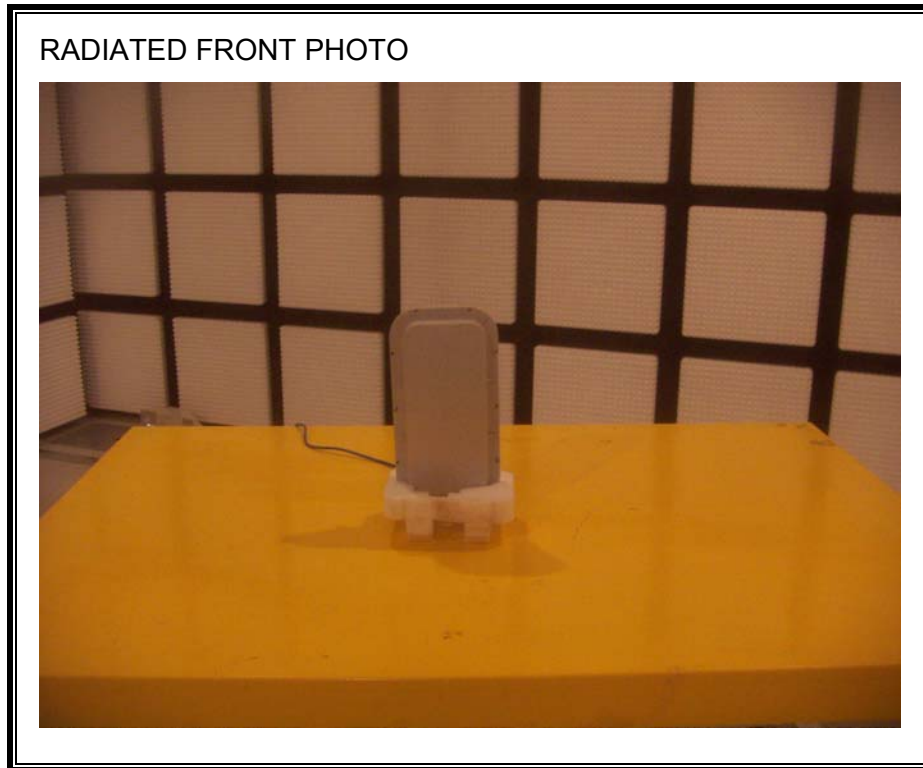

RADIATED BACK PHOTO

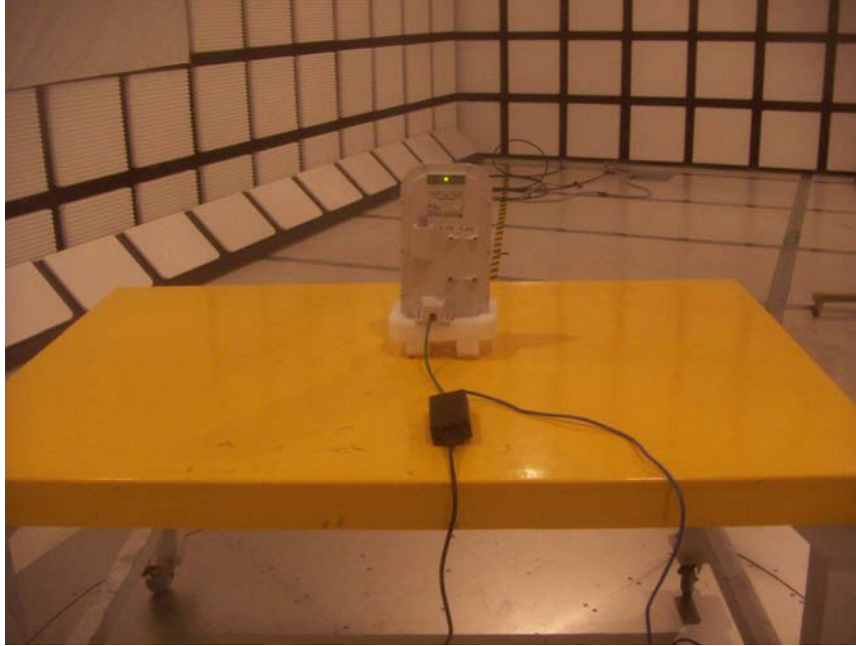

DFS MEASUREMENT SETUP

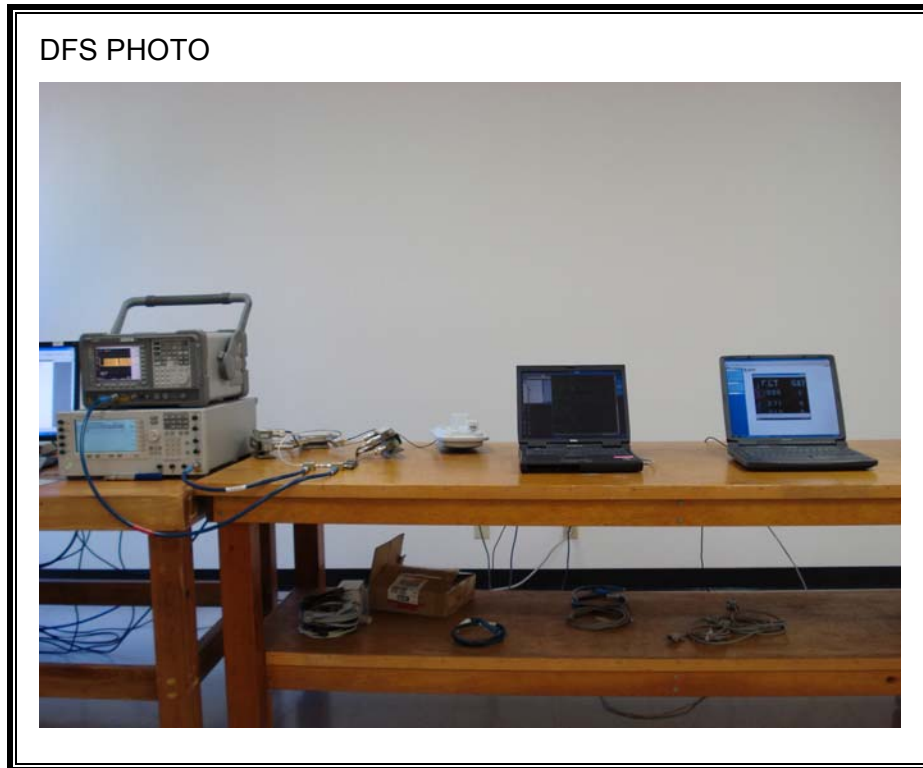

POWERLINE CONDUCTED EMISSIONS MEASUREMENT SETUP



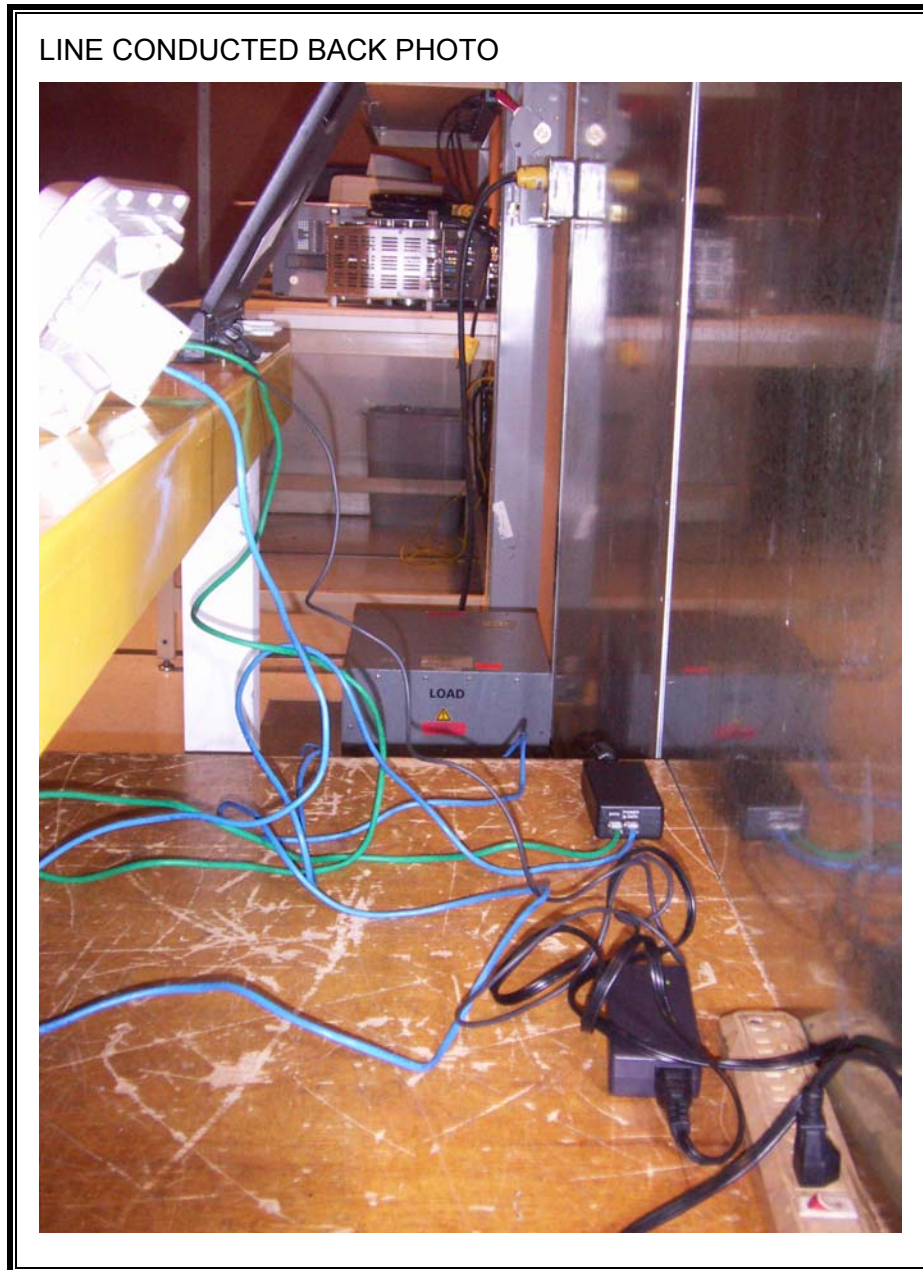

END OF REPORT