

PROPOSED FCC ID LABEL AND LOCATION

SKYPILOT NETWORK INC.

FCC ID: RV7-SC1010

This device complies with Part 15 of the FCC Rules. Operation is subject to the following two conditions: (1) this device may not cause harmful interference, and (2) this device must accept any interference received, including interference that may cause undesired operation.

FC ID LABEL
LOCATION

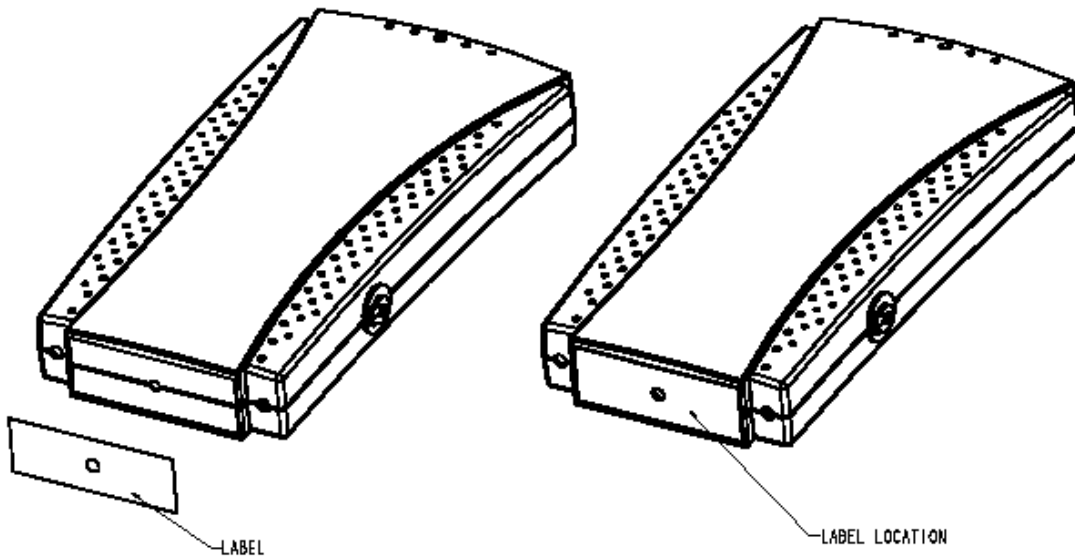

Indoor Unit

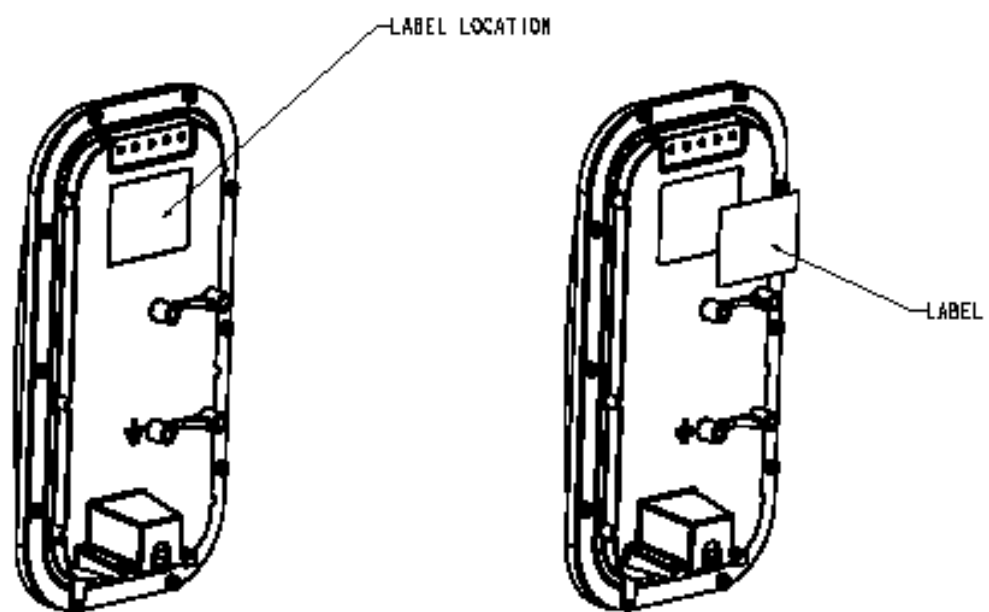

Outdoor Unit