



MET Laboratories, Inc. *Safety Certification - EMI - Telecom Environmental Simulation*
33439 WESTERN AVENUE ! UNION CITY, CALIFORNIA 94587 ! PHONE (510) 489-6300 ! FAX (510) 489-6372

April 4, 2007

SkyPilot Networks
2055 Laurelwood Road, 2nd Fl
Santa Clara, CA 95054

Dear Bill Olsen,

Enclosed is the EMC test report for compliance testing of the SkyPilot Networks, RV7-DBE101005R as tested to the requirements of Title 47 of the CFR, Ch. 1 (10-1-06 ed.), Part 15, Subpart B & ICES-003 Issue 4, February 2004 for a Class A Digital Device and Part 15 Subpart C & RSS-210 Issue 6, September 2005 for Intentional Radiators.

Thank you for using the services of MET Laboratories, Inc. If you have any questions regarding these results or if MET can be of further service to you, please feel free to contact me.

Sincerely yours,
MET LABORATORIES, INC.

Jennifer Sanchez
Documentation Department

Reference: (\SkyPilot Networks\EMCS21813-FCC247)

Certificates and reports shall not be reproduced except in full, without the written permission of MET Laboratories, Inc. While use of the National Voluntary Laboratory Accreditation Program (NVLAP) letters or the NVLAP Logo, the Standards Council of Canada Logo, or the Nationally Recognized Testing Laboratory (NRTL) Letters in this report reflects MET Accreditation under these programs, these letters, logo, or statements do not claim product endorsement by NVLAP or any Agency of the U.S. Government. This letter of transmittal is not a part of the attached report.



The Nation's First Licensed Nationally Recognized Testing Laboratory

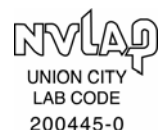



Electromagnetic Compatibility Criteria Test Report

for the

**SkyPilot Networks
Model RV7-DBE101005R**

Tested under
the FCC Certification Rules
contained in
Title 47 of the CFR, Parts 15 Subpart B & ICES-003
for Class A Digital Devices
&
15.247 Subpart C & RSS-210, Issue 6, September 2005
for Intentional Radiators

MET Report: EMC21813-FCC247

April 4, 2007

Prepared For:

**SkyPilot Networks
2055 Laurelwood Road, 2nd Fl
Santa Clara, CA 95054**

Prepared By:
MET Laboratories, Inc.
4855 Patrick Henry Dr., Building 6
Santa Clara, CA 95054



Electromagnetic Compatibility Criteria Test Report

for the

SkyPilot Networks
Model RV7-DBE101005R

Tested Under

the FCC Certification Rules
contained in
Title 47 of the CFR, Parts 15 Subpart B & ICES-003
for Class A Digital Devices
&
15.247 Subpart C & RSS-210, Issue 6, September 2005
for Intentional Radiators

Shawn McMillen, Project Engineer
Electromagnetic Compatibility Lab

Jennifer Sanchez
Documentation Department

Engineering Statement: The measurements shown in this report were made in accordance with the procedures indicated, and the emissions from this equipment were found to be within the limits applicable. I assume full responsibility for the accuracy and completeness of these measurements, and for the qualifications of all persons taking them. It is further stated that upon the basis of the measurements made, the equipment tested is capable of operation in accordance with the requirements of Part 15.B & ICES-003 & 15.247 & RSS-210, of the FCC & Industry Canada Rules under normal use and maintenance.

Tony Permsombut, Manager
Electromagnetic Compatibility Lab



Report Status Sheet

Revision	Report Date	Reason for Revision
Ø	April 4, 2007	Initial Issue.



Table of Contents

I.	Executive Summary	1
	A. Purpose of Test	2
	B. Executive Summary	2
II.	Equipment Configuration	3
	A. Overview	4
	B. References	5
	C. Test Site	6
	D. Description of Test Sample	6
	E. Equipment Configuration	9
	F. Support Equipment	9
	G. Ports and Cabling Information	10
	H. Mode of Operation	11
	I. Method of Monitoring EUT Operation	11
	J. Modifications	11
	a) Modifications to EUT	11
	b) Modifications to Test Standard	11
	K. Disposition of EUT	11
III.	Electromagnetic Compatibility Criteria for Unintentional Radiators	12
	§ 15.107(a) Conducted Emissions Limits	13
	§ 15.109(a) Radiated Emission Limits	17
	§ 15.09(a) Radiated Emissions Limits	17
IV.	Electromagnetic Compatibility Criteria for Intentional Radiators	21
	§ 15.203 Antenna Requirement	22
	§ 15.207(a) & RSS-210 Section 7.2.2 Conducted Emissions Limits	23
	§ 15.247(a), A8.1(2)(3)(4)(5), A8.4(4) 6 dB and 99% Bandwidth	26
	§ 15.247(b), A8.4(1), A8.5 Peak Power Output and RF Exposure	30
	§ 15.247(d) Spurious Emissions Requirements – Radiated and RF Conducted	33
	§ 15.247(e), A8.2(2) Peak Power Spectral Density	43
V.	Test Equipment	46
VI.	Certification & User’s Manual Information	48
	A. Certification Information	49
	B. Label and User’s Manual Information	53
VII.	ICES-003 Procedural & Labeling Requirements	55



List of Tables

Table 1. Executive Summary of EMC Part 15.247 & RSS-210 Compliance Testing	2
Table 2. Executive Summary of EMC Part 15B & ICES-003 Compliance Testing	2
Table 3. Frequency Allocation for 802.11a	5
Table 4. Equipment Configuration	9
Table 5. Support Equipment	9
Table 6. Ports and Cabling Information (Conducted Measurement)	10
Table 7. Ports and Cabling Information (Radiated Measurement)	10
Table 8. Conducted Limits for Radio Frequency Devices calculated from FCC Part 15 Section 15.107(a) (b)	13
Table 9. Conducted Emissions - Voltage, AC Power, Phase Line (110 VAC, 60 Hz)	14
Table 10. Conducted Emissions - Voltage, AC Power, Neutral Line (110 VAC, 60 Hz)	14
Table 11. Radiated Emissions Limits calculated from FCC Part 15, §15.109 (a) (b)	17
Table 12. Radiated Emissions Limits Test Results, 30 MHz – 1 GHz	18
Table 13. Radiated Emissions Test Results, 1GHz – 2GHz	19
Table 14. Conducted Limits for Intentional Radiators from FCC Part 15 § 15.207(a) & RSS-210 Section 7.2.2	23
Table 15. Conducted Emissions Test Results, Phase Line	24
Table 16. Conducted Emissions Test Results, Neutral Line	24
Table 17. Output Power Requirements from §15.247 & RSS-210	30
Table 18. RF Output Power Test Results	31
Table 19. Restricted Bands of Operation	33

List of Figures

Figure 1. Block Diagram of Test Configuration	7
Figure 2. Block Diagram of Test Configuration (Radiated Measurement)	8

List of Photographs

Photograph 1. SkyPilot Networks RV7-DBE101005R	6
Photograph 2. Conducted Emissions Test Setup	16
Photograph 3. Radiated Emission Test Setup 30 MHz - 1 GHz	20
Photograph 4. Test Equipment and setup for various Radiated Measurements	35



List of Terms and Abbreviations

AC	Alternating Current
ACF	Antenna Correction Factor
Cal	Calibration
<i>d</i>	Measurement Distance
dB	Decibels
dB μ A	Decibels above one microamp
dB μ V	Decibels above one microvolt
dB μ A/m	Decibels above one microamp per meter
dB μ V/m	Decibels above one microvolt per meter
DC	Direct Current μ
E	Electric Field
DSL	Digital Subscriber Line
ESD	Electrostatic Discharge
EUT	Equipment Under Test
<i>f</i>	Frequency
FCC	Federal Communications Commission
GR-1089-CORE	(GR) General Requirement(s) imposed by the NEBS standard, (CORE) Central Office Recovery Express (AT&T), (1089) specifies various parts of the General Requirements under Bellcore Technical Standard, Requirements for Electromagnetic Compatibility and Electrical Safety - Generic Criteria for Network Telecommunications Equipment
GRP	Ground Reference Plane
H	Magnetic Field
HCP	Horizontal Coupling Plane
Hz	Hertz
IEC	International Electrotechnical Commission
kHz	kilohertz
kPa	kilopascal
kV	kilovolt
LISN	Line Impedance Stabilization Network
MHz	Megahertz
μ H	microhenry
μ	microfarad
μ s	microseconds
NEBS	Network Equipment-Building System
PRF	Pulse Repetition Frequency
RF	Radio Frequency
RMS	Root-Mean-Square
TWT	Traveling Wave Tube
V/m	Volts per meter
VCP	Vertical Coupling Plane



I. Executive Summary



A. Purpose of Test

An EMC evaluation was performed to determine compliance of the SkyPilot Networks RV7-DBE101005R, with the requirements of Part 15B, ICES-003, §15.247 & RSS-210, Issue 6, September 2005. All references are to the most current version of Title 47 of the Code of Federal Regulations in effect. In accordance with §2.1033, the following data is presented in support of the Certification of the RV7-DBE101005R. SkyPilot Networks should retain a copy of this document which should be kept on file for at least two years after the manufacturing of the RV7-DBE101005R, has been **permanently** discontinued

B. Executive Summary

The following tests were conducted on a sample of the equipment for the purpose of demonstrating compliance with Part 15B, ICES-003, §15.247 & RSS-210, Issue 6, September 2005 in accordance with SkyPilot Networks, purchase order number 5345. All tests were conducted using measurement procedure ANSI C63.4-2003.

FCC Reference	RSS-210 and RSS-GEN	Description	Results
Transmitter Mode (TX)			
§15.207	6.6	AC Power Line Conducted Emissions	Compliant
§15.203/15.247(c)	A8.4	Antenna Requirement	Compliant
§15.247(a)(3)	A8.1/A8.2	6dB Occupied Bandwidth	Compliant
§15.247(b)(3)	A8.4	Maximum Peak Conducted Output Power	Compliant
§15.247(d), §15.205, §15.209	A8.5	Spurious Radiated and Conducted Emissions	Compliant
§15.247(e)	A8.2/RSS-102	Peak Power Spectral Density and RF Exposure	Compliant

Table 1 Executive Summary of EMC Part 15.247 & RSS-210 Compliance Testing

Specification	Test Description	Compliance
15.107 (a) & ICES-003, Issue 4, February 2004	Conducted Emissions – Voltage – Class A	Compliant
15.109 (a) & ICES-003, Issue 4, February 2004	Radiated Emissions – Class A	Compliant

Table 2. Executive Summary of EMC Part 15B & ICES-003 Compliance Testing



II. Equipment Configuration



A. Overview

MET Laboratories, Inc. was contracted by SkyPilot Networks to perform testing on the RV7-DBE101005R, under SkyPilot Networks's purchase order number 5345.

This document describes the test setups, test methods, required test equipment, and the test limit criteria used to perform compliance testing of the SkyPilot Networks, RV7-DBE101005R.

The results obtained relate only to the item(s) tested.

Model(s) Tested:	RV7-DBE101005R	
Model(s) Covered:	RV7-DBE101005R	
EUT Specifications:	Primary Power: 24VDC	
	FCC ID: RV7-DBE101005R IC: 5550A-DBE101005	
	Type of Modulations:	OFDM
	Emission Designators:	16M7D7D
	Equipment Code:	DTS
	Peak RF Output Power:	29.71 dBm
	EUT Frequency Ranges:	5470 – 5850MHz
Analysis:	The results obtained relate only to the item(s) tested.	
Environmental Test Conditions:	Temperature (15-35° C)	
	Relative Humidity (30-60%)	
	Barometric Pressure (860-1060 mbar)	
Evaluated by:	Shawn McMillen	
Date(s):	April 4, 2007	



Channel Number	Frequency (MHz)
149	5745
153	5765
157	5785
161	5805
165	5825

Table 3. Frequency Allocation for 802.11a

B. References

CFR 47, Part 15, Subpart C	Federal Communication Commission, Code of Federal Regulations, Title 47, Part 15: General Rules and Regulations, Allocation, Assignment, and Use of Radio Frequencies
RSS-210, Issue 6, September 2005	Low-power Licence-exempt Radiocommunications Devices (All Frequency Bands): Category I Equipment
CFR 47, Part 15, Subpart B	Electromagnetic Compatibility: Criteria for Radio Frequency Devices
ICES-003 Issue 4, February 2004	Electromagnetic Compatibility: Criteria for Radio Frequency Devices
ANSI C63.4:2003	Methods and Measurements of Radio-Noise Emissions from Low-Voltage Electrical And Electronic Equipment in the Range of 9 kHz to 40 GHz
ANSI/NCSL Z540-1-1994	Calibration Laboratories and Measuring and Test Equipment - General Requirements
ANSI/ISO/IEC 17025:2000	General Requirements for the Competence of Testing and Calibration Laboratories

C. Test Site

All testing was performed at MET Laboratories, Inc., 4855 Patrick Henry Dr., Building 6, Santa Clara, CA 95054. All equipment used in making physical determinations is accurate and bears recent traceability to the National Institute of Standards and Technology.

Radiated Emissions measurements were performed in a semi-anechoic chamber (equivalent to an Open Area Test Site). In accordance with §2.948(a)(3), a complete site description is contained at MET Laboratories. In accordance with §2.948(d), MET Laboratories has been accredited by A2LA (Certificate Number 591.02).

D. Description of Test Sample

The SkyPilot Networks RV7-DBE101005R, is an unique integrated solution that provides both long-range Mesh Backhaul capability (see SkyExtender Dual-Band datasheet for more information).



Photograph 1. SkyPilot Networks RV7-DBE101005R

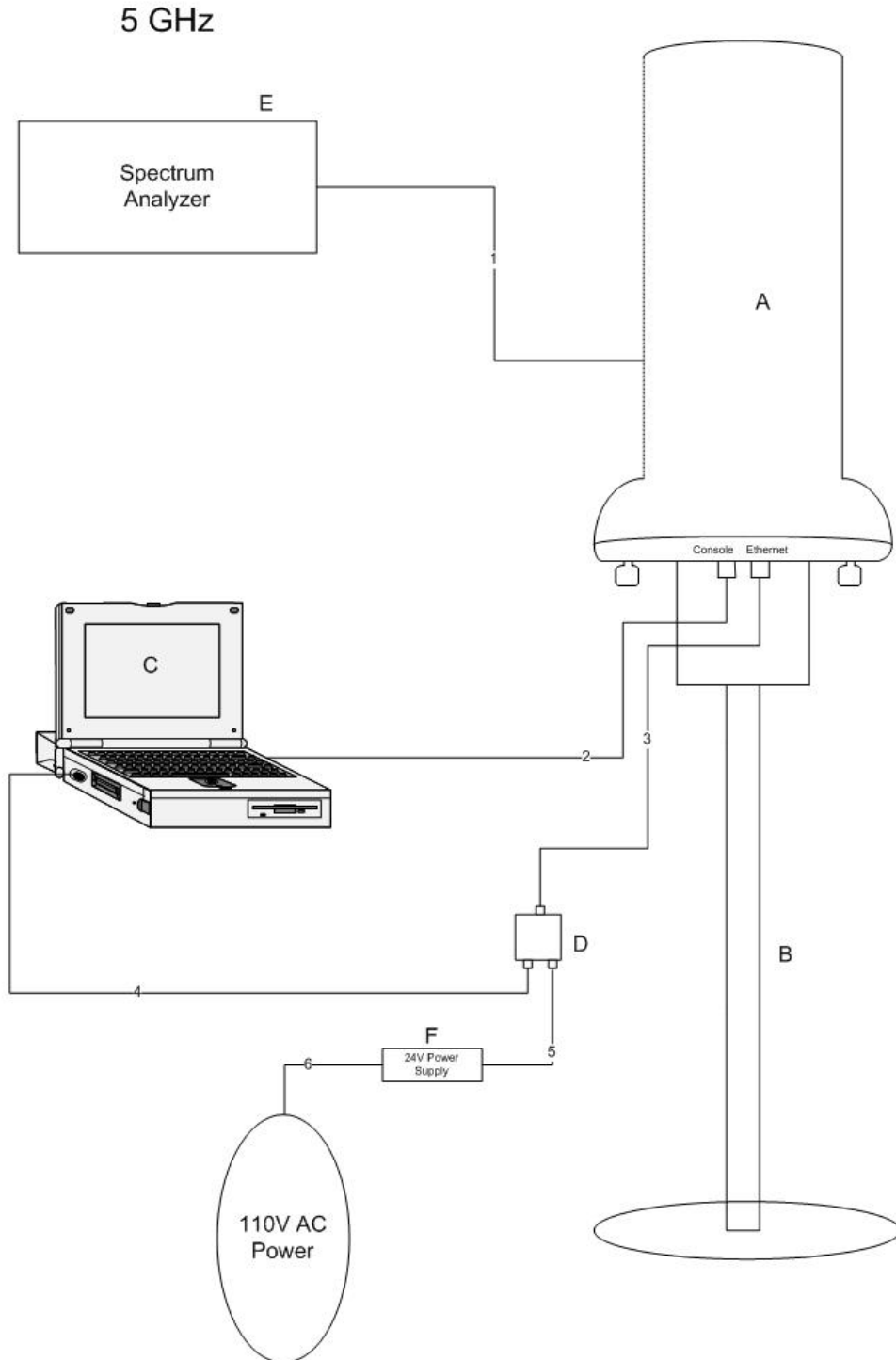

Figure 1. Block Diagram of Test Configuration

Radiated Measurement

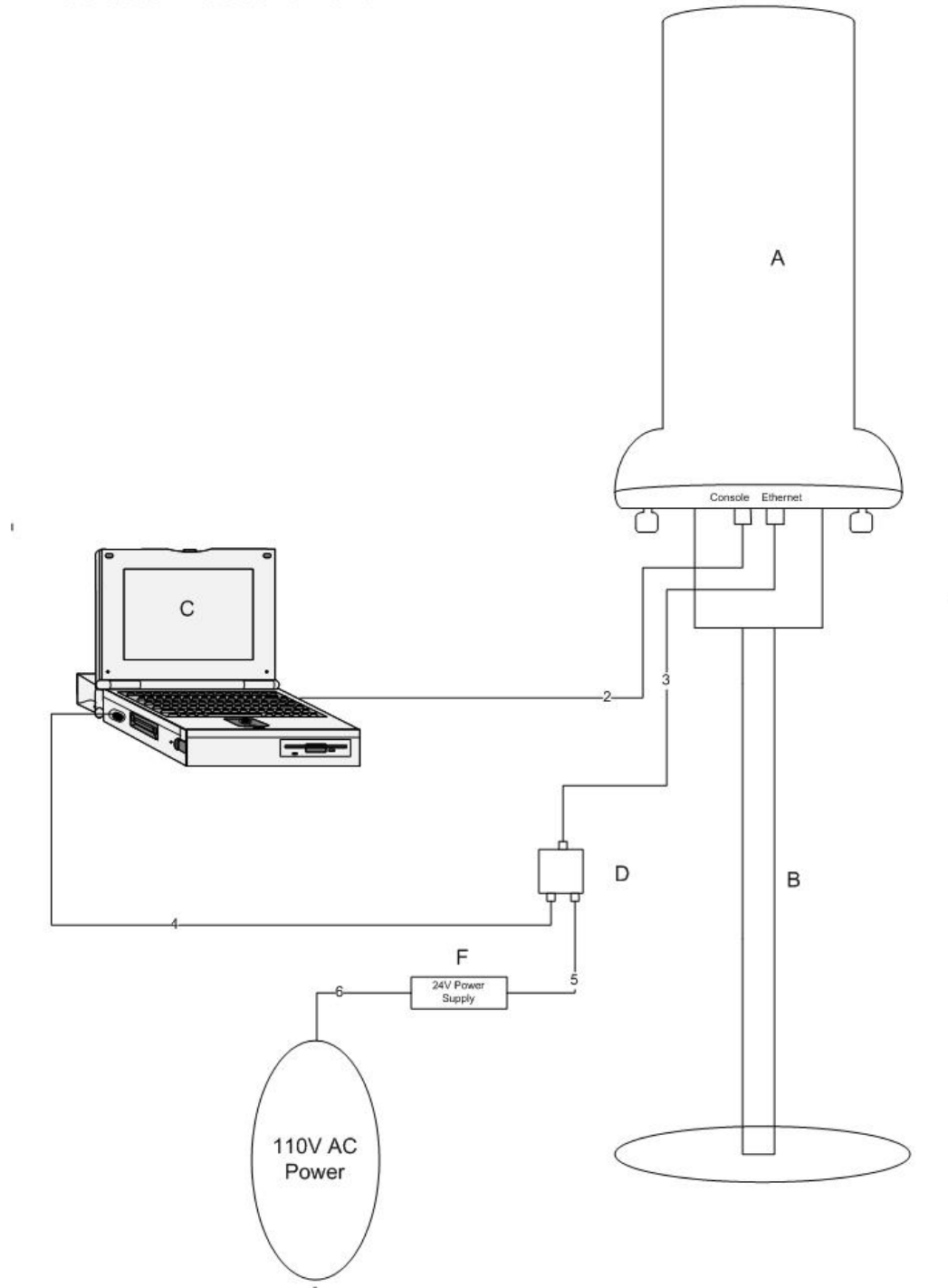

Figure 2. Block Diagram of Test Configuration (Radiated Measurement)



E. Equipment Configuration

The EUT was set up as outlined in Figure 1, Block Diagram of Test Setup. All cards, racks, etc., incorporated as part of the EUT is included in the following list.

Ref. ID	Name / Description	Model Number	Serial Number
A	SkyExtender DualBand	710-001212-041	F20787027

Table 4. Equipment Configuration

F. Support Equipment

SkyPilot Networks supplied support equipment necessary for the operation and testing of the RV7-DBE101005R. All support equipment supplied is listed in the following Support Equipment List.

Ref. ID	Name / Description	Manufacturer	Model Number
B	Stand	-	SKYWHI-03-010
C	Laptop	IBM	T43
D	Ethernet power adapter	-	640-0009-01
E	Spectrum Analyzer	Agilent	E4407B
F	Power Converter	CVI INC	3A-621DN24

Table 5. Support Equipment



G. Ports and Cabling Information

Ref. ID	Port name on EUT	Cable Description or reason for no cable	Qty.	Length (m)	Shielded (Yes/No)	Termination Box ID & Port ID
Conducted Measurements						
1	A (Inside the cover), Coax	Coaxial	1	2	no	Spectrum Analyzer
2	A, Console	Ethernet-USB Serial	1	1.5	Yes	C
3	A, Frame Lock	Ethernet	1	2	Yes	D, Frame Lock
4	D, Computer	Frame Lock	1		Yes	C
5	D, Power	AC Power	1	1	no	F
6	F ,Power Converter	AC Power	1	1	no	110V AC Power Supply

Table 6. Ports and Cabling Information (Conducted Measurement)

Ref. ID	Port name on EUT	Cable Description or reason for no cable	Qty.	Length (m)	Shielded (Yes/No)	Termination Box ID & Port ID
Radiated Measurements						
2	A, Console	Ethernet-USB Serial	1	1.5	Yes	C
3	A, Frame Lock	Ethernet	1	2	Yes	D, Frame Lock
4	D, Computer	Frame Lock	1		Yes	C
5	D, Power	AC Power	1	1	no	F
6	F ,Power Converter	AC Power	1	1	no	110V AC Power Supply

Table 7. Ports and Cabling Information (Radiated Measurement)



H. Mode of Operation

5GHz Mesh Backhaul

I. Method of Monitoring EUT Operation

Ping EUT through either the wired Ethernet port (RJ-45) or the WiFi (5.8GHz) link.

J. Modifications

- a) **Modifications to EUT**
No modifications were made to the EUT.
- b) **Modifications to Test Standard**
No modifications were made to the test standard.

K. Disposition of EUT

The test sample including all support equipment submitted to the Electro-Magnetic Compatibility Lab for testing was returned to SkyPilot Networks upon completion of testing.



III. Electromagnetic Compatibility Criteria for Unintentional Radiators



Electromagnetic Compatibility Criteria for Unintentional Radiators

§ 15.107 Conducted Emissions Limits

Test Requirement(s): **15.107 (a)** “Except for Class A digital devices, for equipment that is designed to be connected to the public utility (AC) power line, the radio frequency voltage that is conducted back onto the AC power line on any frequency or frequencies within the band 150 kHz to 30 MHz shall not exceed the limits in Table 8. Compliance with this provision shall be based on the measurement of the radio frequency voltage between each power line and ground at the power terminals.”

15.107 (b) “For a Class A digital device that is designed to be connected to the public utility (AC) power line, the radio frequency voltage that is conducted back onto the AC power line on any frequency or frequencies within the band 150 kHz to 30 MHz shall not exceed the limits in Table 8. Compliance with this provision shall be based on the measurement of the radio frequency voltage between each power line and ground at the power terminals. The lower limit applies at the band edges.”

Frequency range (MHz)	15.107(b), Class A Limits (dBµV)		15.107(a), Class B Limits (dBµV)	
	Quasi-Peak	Average	Quasi-Peak	Average
0.15- 0.5	79	66	66 - 56	56 - 46
0.5 – 5.0	73	60	56	46
5.0 - 30	73	60	60	50

Note 1 — The lower limit shall apply at the transition frequencies.

Table 8. Conducted Limits for Radio Frequency Devices calculated from FCC Part 15 Section 15.107(a) (b)

Test Procedures: The EUT was placed on a 0.8m-high wooden table inside a semi-anechoic chamber. The method of testing, test conditions, and test procedures of ANSI C63.4 were used. The EUT was powered through a 50Ω/50µH LISN. An EMI receiver, connected to the measurement port of the LISN, scanned the frequency range from 150 kHz to 30 MHz in order to find the peak conducted emissions. All peak emissions within 6 dB of the limit were measured using a quasi-peak and/or average detector as appropriate.

Test Results: The EUT was found compliant with the Class A requirement(s) of this section. Measured emissions were below applicable limits.

Test Engineer(s): Mihn Ly

Test Date(s): February 20, 2007



Conducted Emissions - Voltage, AC Power, Phase Line (110 VAC, 60 Hz)

FREQ. (MHz)	Corrected Amplitude (dBuV) QP	Limit (dBuV) QP	Results QP	Margin (dB) QP	Corrected Amplitude (dBuV) AVG	Limit (dBuV) AVG	Results AVG	Margin (dB) AVG
0.422	51.44	79	PASS	-27.56	51.25	66	PASS	-14.75
0.704	48.17	73	PASS	-24.83	47.88	60	PASS	-12.12
1.2682	48.08	73	PASS	-24.92	47.55	60	PASS	-12.45
3.24	47.05	73	PASS	-25.95	41.75	60	PASS	-18.25
0.325	47.82	79	PASS	-31.18	47.26	66	PASS	-18.74

Table 9. Conducted Emissions - Voltage, AC Power, Phase Line (110 VAC, 60 Hz)

Conducted Emissions - Voltage, AC Power, Neutral Line (110 VAC, 60 Hz)

FREQ. (MHz)	Corrected Amplitude (dBuV) QP	Limit (dBuV) QP	Results QP	Margin (dB) QP	Corrected Amplitude (dBuV) AVG	Limit (dBuV) AVG	Results AVG	Margin (dB) AVG
0.355	47.54	79	PASS	-31.46	46.99	66	PASS	-19.01
0.422	50.74	79	PASS	-28.26	50.6	66	PASS	-15.4
0.704	47.87	73	PASS	-25.13	47.66	60	PASS	-12.34
1.268	47.91	73	PASS	-25.09	47.37	60	PASS	-12.63

Table 10. Conducted Emissions - Voltage, AC Power, Neutral Line (110 VAC, 60 Hz)



Conducted Emissions - Voltage, Worst Case Emissions, AC Power, (110 VAC, 60 Hz)

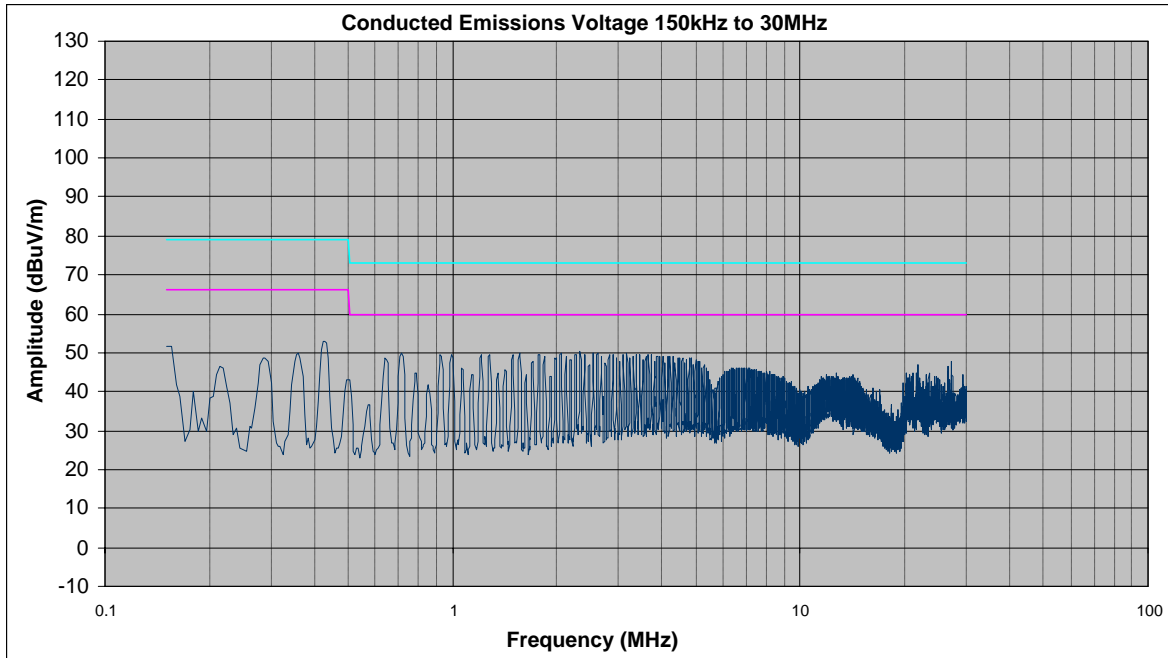

Conducted Emission, Phase Line Plots

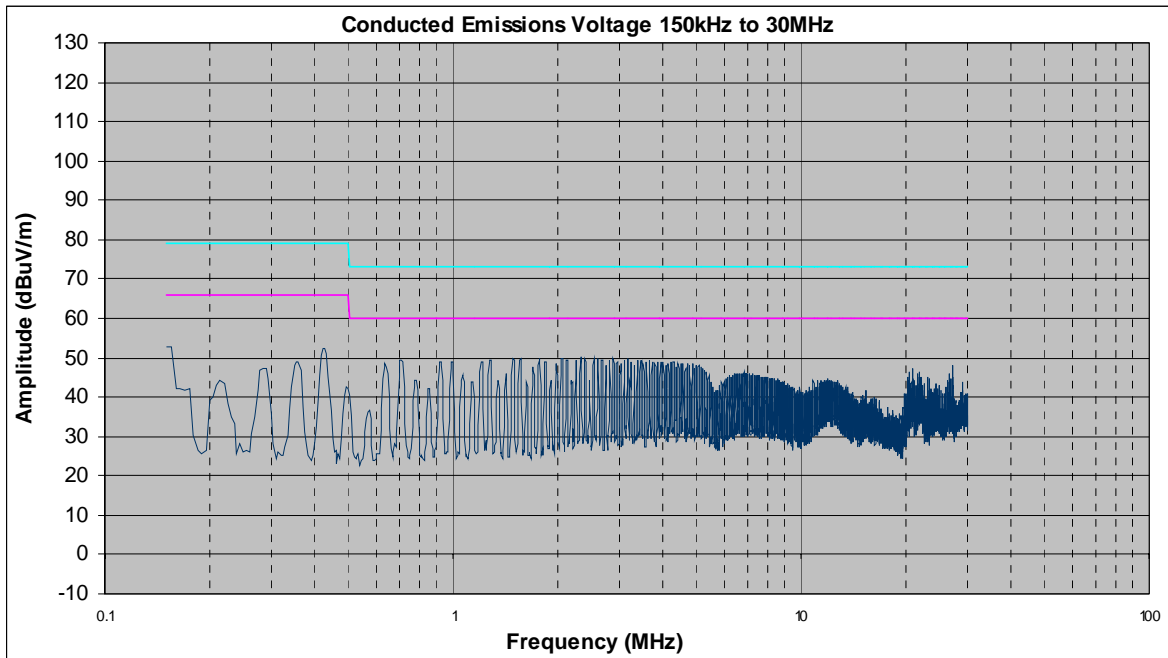

Conducted Emission, Neutral Line Plots



Conducted Emission Limits Test Setup



Photograph 2. Conducted Emissions Test Setup



Radiated Emission Limits

§ 15.109 Radiated Emissions Limits

Test Requirement(s): **15.109 (a)** Except for Class A digital devices, the field strength of radiated emissions from unintentional radiators at a distance of 3 meters shall not exceed the Class B limits expressed in Table 11.

15.109 (b) The field strength of radiated emissions from a Class A digital device, as determined at a distance of 10 meters, shall not exceed the Class A limits expressed in Table 11.

Frequency (MHz)	Field Strength (dB μ V/m)	
	§15.109 (b), Class A Limit (dB μ V) @ 10m	§15.109 (a), Class B Limit (dB μ V) @ 3m
30 - 88	39.00	40.00
88 - 216	43.50	43.50
216 - 960	46.40	46.00
Above 960	49.50	54.00

Table 11. Radiated Emissions Limits calculated from FCC Part 15, §15.109 (a) (b)

Test Procedures: The EUT was placed on a 0.8m-high wooden table inside a semi-anechoic chamber. The method of testing and test conditions of ANSI C63.4 were used. An antenna was located 10 m from the EUT on an adjustable mast. A pre-scan was first performed in order to find prominent radiated emissions. For final emissions measurements at each frequency of interest, the EUT was rotated and the antenna height was varied between 1 m and 4 m in order to maximize the emission. Measurements in both horizontal and vertical polarities were made and the data was recorded. Unless otherwise specified, measurements were made using a quasi-peak detector with a 120 kHz bandwidth.

Test Results: The EUT was found Compliant with the Class A requirement(s) of this section. Measured emissions were below applicable limits



Radiated Emissions Limits Test Results, Class A

Frequency (MHz)	Antenna Polarity (H/V)	EUT Azimuth (Degrees)	Antenna Height (m)	Uncorrected Amplitude QP Detector (dBuv)	Antenna Correction Factor (dB/m) (+)	Cable Loss (dB) (+)	Corrected Amplitude (dBuV/m)	Limit (dBuV/m)	Margin (dB)
165	V	11	1	25.49	9.80	2.33	37.62	43.50	-5.88
176	V	159	1	22.13	9.98	2.39	34.50	43.50	-9.00
208.32	H	294	2.84	8.01	9.20	2.54	19.75	43.50	-23.75
395.88	H	89	2.44	9.05	15.55	3.48	28.08	46.40	-18.32
653.4	H	71	1.1	7.86	19.20	4.82	31.88	46.40	-14.52
47.8	V	244	1	17.86	8.72	1.12	27.70	39.00	-11.30
306.2	V	109	1	13.26	13.12	2.96	29.35	46.40	-17.05

Table 12. Radiated Emissions Limits Test Results, 30 MHz – 1 GHz

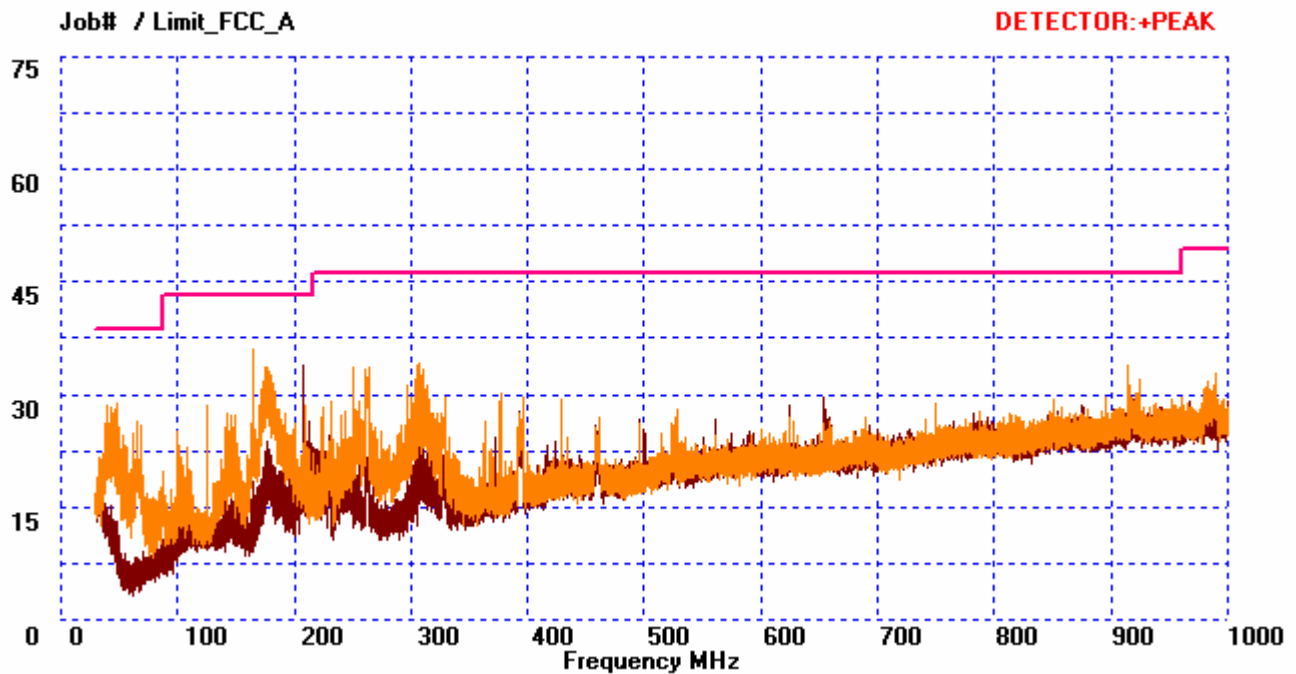

Radiated Emissions Limits Test Results, 30 MHz – 1 GHz, Class A



Radiated Emissions Limits Test Results, 1GHz – 2GHz

Frequency (GHz)	Azimuth Degrees)	Antenna Polarity (H/V)	Height (m)	Raw Amp. @ 3m(Avg)	P.Amp (dB)	Ant.Cor. Factor (dB/m)	Cable Loss (dB)	Dist.Cor Factor (dB)	EUT Field Strength Final Amp. (dBuV/m)	Limit per FCC pt 15 @ 3m (dBuV/m)	Delta (dB)
1	195	H	2.1	41.47	35.12	24.20	2.14	10.46	22.23	49.5	-27.27
1	178	V	1.4	48.45	35.12	24.09	2.14	10.46	29.10	49.5	-20.41
1.125	6	H	1.4	46.23	35.21	24.38	2.22	10.46	27.15	49.5	-22.35
1.25	198	V	2.3	38.47	35.23	24.53	2.31	10.46	19.61	49.5	-29.89
1.3	291	H	1.8	40.19	35.23	24.73	2.35	10.46	21.58	49.5	-27.92
1.375	310	H	2.2	41.35	35.19	24.92	2.42	10.46	23.04	49.5	-26.46
1.5	148	H	1.6	35.67	35.12	25.30	2.55	10.46	17.94	49.5	-31.56
1.583	80	H	1.4	49.15	35.16	25.60	2.65	10.46	31.79	49.5	-17.71
1.68	50	V	1.8	40.39	35.22	25.95	2.79	10.46	23.45	49.5	-26.05
2	1	H	1	37.68	35.14	27.45	3.25	10.46	22.78	49.5	-26.72
2	0	V	1	33.31	35.14	27.34	3.25	10.46	18.30	49.5	-31.20

Table 13. Radiated Emissions Test Results, 1GHz – 2GHz

Radiated Emission Limits Test Setup

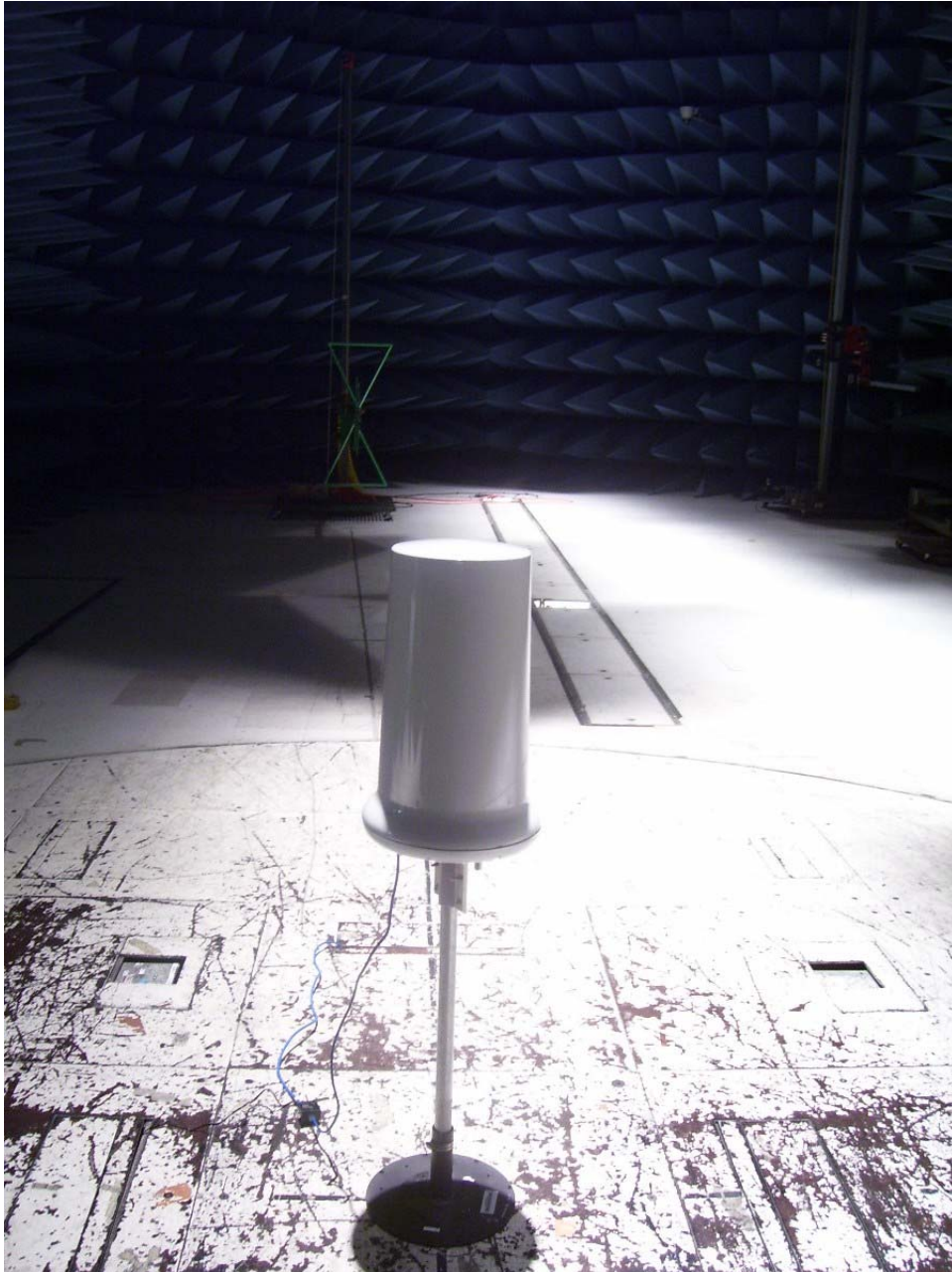

Photograph 3. Radiated Emission Test Setup 30 MHz - 1 GHz



IV. Electromagnetic Compatibility Criteria for Intentional Radiators



Electromagnetic Compatibility Criteria for Intentional Radiators

§ 15.203 Antenna Requirement

Test Requirement:

§ 15.203: An intentional radiator shall be designed to ensure that no antenna other than that furnished by the responsible party shall be used with the device. The use of a permanently attached antenna or of an antenna that uses a unique coupling to the intentional radiator shall be considered sufficient to comply with the provisions of this section. The manufacturer may design the unit so that a broken antenna can be replaced by the user, but the use of a standard antenna jack or electrical connector is prohibited.

The structure and application of the EUT were analyzed to determine compliance with Section 15.203 of the Rules. Section 15.203 states that the subject device must meet at least one of the following criteria:

- a.) Antenna must be permanently attached to the unit.
- b.) Antenna must use a unique type of connector to attach to the EUT.
- c.) Unit must be professionally installed. Installer shall be responsible for verifying that the correct antenna is employed with the unit.

Results:

The EUT as tested meets the criteria of this rule by virtue of having professionally installed. The EUT is therefore compliant with §15.203.

Gain	Manufacturer
18dBi	Skypilot

Test Engineer(s):

Shawn McMillen



Electromagnetic Compatibility Criteria for Intentional Radiators

§ 15.207 & RSS-210 Section 7.2.2 Conducted Emissions Limits

Test Requirement(s): § 15.207 (a) & RSS-210 Section 7.2.2: For an intentional radiator that is designed to be connected to the public utility (AC) power line, the radio frequency voltage that is conducted back onto the AC power line on any frequency or frequencies, within the band 150 kHz to 30MHz, shall not exceed the limits in the following table, as measured using a 50 μ H/50 Σ line impedance stabilization network (LISN). Compliance with the provisions of this paragraph shall be based on the measurement of the radio frequency voltage between each power line and ground at the power terminal. The lower limit applies at the boundary between the frequency ranges.

Frequency range (MHz)	§ 15.207(a), Conducted Limit (dB μ V)	
	Quasi-Peak	Average
* 0.15- 0.45	66 - 56	56 - 46
0.45 - 0.5	56	46
0.5 - 30	60	50

Table 14. Conducted Limits for Intentional Radiators from FCC Part 15 § 15.207(a) & RSS-210 Section 7.2.2

Test Procedure: The EUT was placed on a 0.8 m-high wooden table inside a semi-anechoic chamber. The EUT was situated such that the back of the EUT was 0.4 m from one wall of the vertical ground plane, and the remaining sides of the EUT were no closer than 0.8 m from any other conductive surface. The EUT was powered from a 50 Ω /50 μ H Line Impedance Stabilization Network (LISN). The EMC receiver scanned the frequency range from 150 kHz to 30 MHz. Conducted Emissions measurements were made in accordance with *ANSI C63.4-1992 "Methods and Measurements of Radio-Noise Emissions from Low-Voltage Electrical and Electronic Equipment in the Range of 9kHz to 40 GHz"*. The measurements were performed over the frequency range of 0.15 MHz to 30 MHz using a 50 Ω /50 μ H LISN as the input transducer to an EMC/field intensity meter. The tests were conducted in a RF-shielded enclosure.

Test Results: The EUT was found compliant with the requirement(s) of this section. Measured emissions were below applicable limits.

Test Engineer(s): Mihn Ly

Test Date(s): February 20, 2007



Conducted Emissions - Voltage, AC Power, (110 VAC, 60 Hz)

FREQ. (MHz)	Corrected Amplitude (dBuV) QP	Limit (dBuV) QP	Results QP	Margin (dB) QP	Corrected Amplitude (dBuV) AVG	Limit (dBuV) AVG	Results AVG	Margin (dB) AVG
0.423	47.5	57.39	PASS	-9.89	43.32	47.39	PASS	-4.07
0.916	43.3	56	PASS	-12.7	40.94	46	PASS	-5.06
6.067	41.29	60	PASS	-18.71	33.37	50	PASS	-16.63

Table 15. Conducted Emissions Test Results, Phase Line

FREQ. (MHz)	Corrected Amplitude (dBuV) QP	Limit (dBuV) QP	Results QP	Margin (dB) QP	Corrected Amplitude (dBuV) AVG	Limit (dBuV) AVG	Results AVG	Margin (dB) AVG
0.423	47.51	57.39	PASS	-9.88	42.55	47.39	PASS	-4.84
0.916	42.31	56	PASS	-13.69	39.05	46	PASS	-6.95
6.065	39.99	60	PASS	-20.01	32.61	50	PASS	-17.39

Table 16. Conducted Emissions Test Results, Neutral Line



Conducted Emissions - Voltage, AC Power, (110 VAC, 60 Hz)

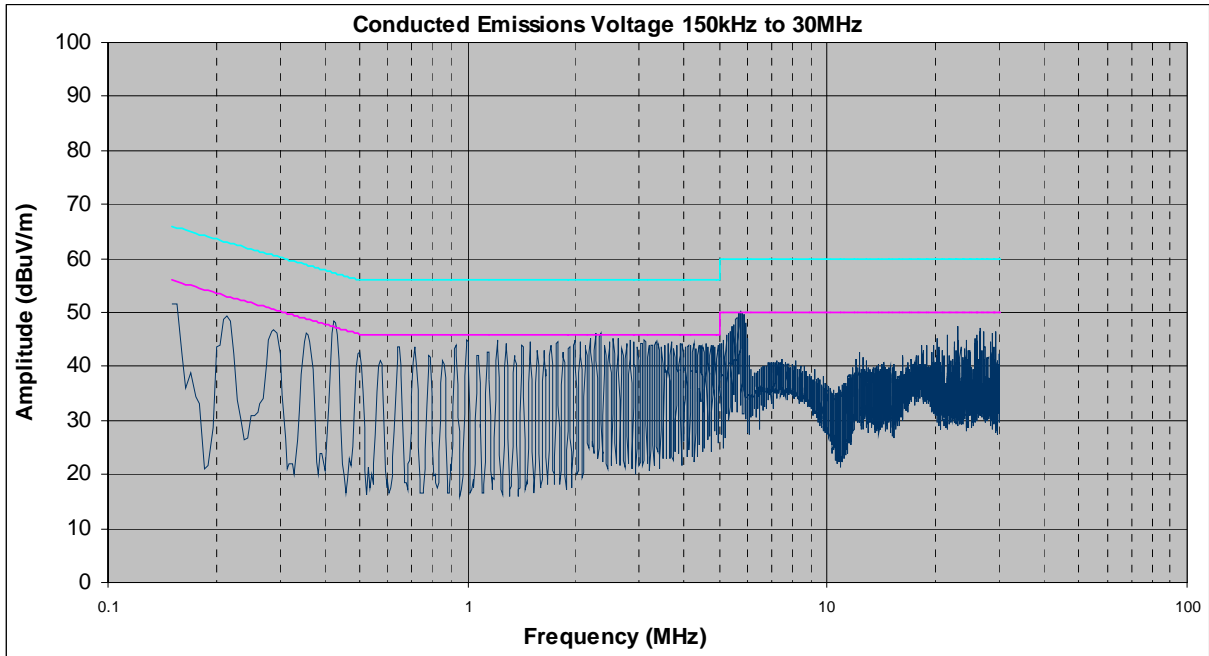

Plot 1. Conducted Emissions, Phase Line Plot

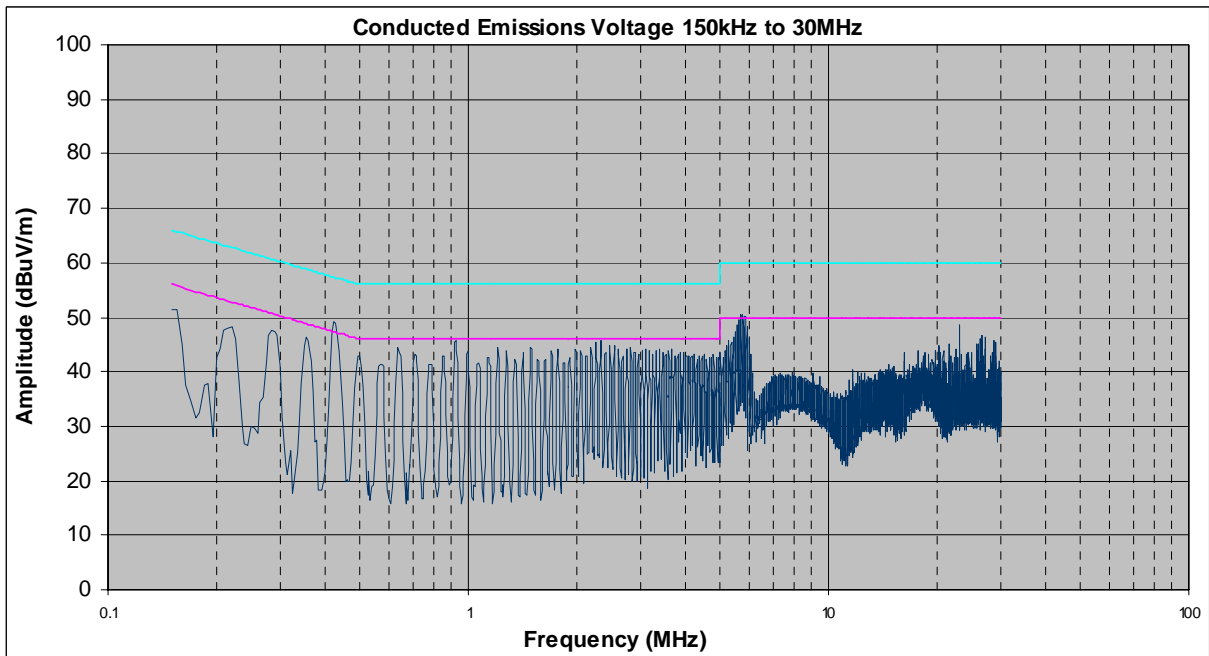

Plot 2. Conducted Emissions, Neutral Line Plot



Electromagnetic Compatibility Criteria for Intentional Radiators

§ 15.247(a), A8.1(2)(3)(4)(5), A8.4(4) 6 dB and 99% Bandwidth

Test Requirements: § 15.247(a), A8.1(2)(3)(4)(5), A8.4(4): Operation under the provisions of this section is limited to frequency hopping and digitally modulated intentional radiators that comply with the following provisions:

For systems using digital modulation techniques, the EUT may operate in the 5725-5850 MHz bands. The minimum 6dB bandwidth shall be at least 500 kHz.

Test Procedure: The transmitter was set to the mid channel at the highest output power and connected to the spectrum analyzer through an attenuator. The bandwidth of the fundamental frequency was measured with the spectrum analyzer using a RBW approximately equal to 1% of the total emission bandwidth, VBW > RBW. The 6 dB Bandwidth was measured and recorded. The measurements were repeated at the low and high channels.

Test Results Equipment complies with § 15.247 (a), A8.1(2)(3)(4)(5) & A8.4(4). The 6 dB and 99% Bandwidth was determined from the plots on the following pages.

802.11a mode			
Carrier Channel	Frequency (MHz)	Measured 6 dB Bandwidth (MHz)	Measured 99% Bandwidth (MHz)
Low	5745	16.67	17.80
Mid	5785	16.75	17.67
High	5825	16.58	17.00

Test Engineer(s): Shawn McMillen

Test Date(s): March 7, 2007

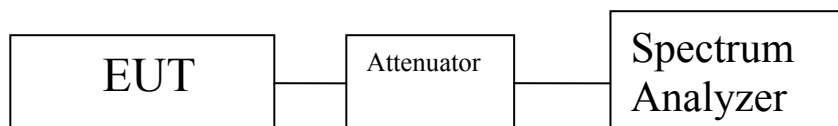

Block Diagram 1. Occupied Bandwidth Test Setup



Electromagnetic Compatibility Criteria for Intentional Radiators

§ 15.247(b) & A8.4(1), A8.5 Peak Power Output and RF Exposure

Test Requirements: §15.247(b) & A8.4(1): The maximum peak output power of the intentional radiator shall not exceed the following:

Digital Transmission Systems (MHz)	Output Limit (Watts)
5725– 5850	1.000

Table 17. Output Power Requirements from §15.247 & RSS-210

§15.247(c) & A8.5: if transmitting antennas of directional gain greater than 6 dBi are used the peak output power from the intentional radiator shall be reduced below the stated values in the Table 17, as appropriate, by the amount in dB that the directional gain of the antenna exceeds 6 dBi.

Systems operating in the 5725 – 5850 MHz band that are used exclusively for fixed, point-to-point operations may employ transmitting antennas with directional gain greater than 6 dBi without any corresponding reduction in transmitter peak output power.

Fixed, point-to-point operation excludes the use of point-to-multipoint systems, omnidirectional applications, and multiple co-located intentional radiators transmitting the same information. The operator of the spread spectrum intentional radiator or, if the equipment is professionally installed, the installer is responsible for ensuring that the system is used exclusively for fixed, point-to-point operations. The instruction manual furnished with the intentional radiator shall contain language in the installation instructions informing the operator and the installer of this responsibility.

Test Procedure: The transmitter was connected to a calibrated Peak Power Meter. The EUT was measured at the low, mid and high channels of each band at a data rate which gave the maximum power level.



Test Results: Equipment complies with the Peak Power Output limits of § 15.247(b) & A8.4(1).

802.11a			
Carrier Channel	Frequency (MHz)	Measured Peak Output Power dBm (mW)	Measured Average Output Power dBm (mW)
Low	5745	29.43	17.89
Mid	5785	29.57	21.04
High	5825	29.71	21.17

Table 18. RF Output Power Test Results

Test Engineer(s): Shawn McMillen

Test Date(s): March 1, 2007

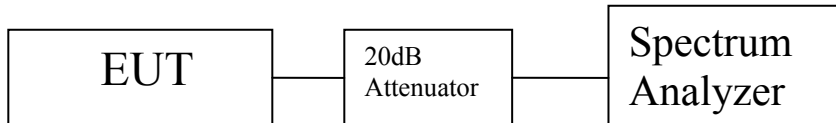

Block Diagram 2. Peak Power Output Test Setup



Electromagnetic Compatibility Criteria for Intentional Radiators

§ 15.247(b), A8.5 Peak Power Output and RF Exposure

- RF Exposure Requirements:** §1.1307(b)(1) and §1.1307(b)(2): Systems operating under the provisions of this section shall be operated in a manner that ensures that the public is not exposed to radio frequency energy levels in excess of the Commission's guidelines.
- RF Radiation Exposure Limit:** §1.1310: As specified in this section, the Maximum Permissible Exposure (MPE) Limit shall be used to evaluate the environmental impact of human exposure to radiofrequency (RF) radiation as specified in Sec. 1.1307(b), except in the case of portable devices which shall be evaluated according to the provisions of Sec. 2.1093 of this chapter.

MPE Limit Calculation: EUT's operating frequencies @ 5725 - 5850 MHz; highest conducted power = 29.71dBm (peak) therefore, **Limit for Uncontrolled exposure: 1 mW/cm² or 10 W/m²**

EUT maximum antenna gain = 18 dBi.

Equation from page 18 of OET 65, Edition 97-01

$$S = PG / 4\pi R^2 \quad \text{or} \quad R = \sqrt{PG / 4\pi S}$$

where, S = Power Density (1 mW/cm²)
P = Power Input to antenna (935mW)
G = Antenna Gain (63.0 numeric)

$R = (935 * 63.0 / 4 * 3.14 * 1.0)^{1/2} = (58905 / 12.56)^{1/2} = 68.4\text{cm}$ separation required in order to comply with the limit of **1 mW/cm²** for Uncontrolled Exposure.



Electromagnetic Compatibility Criteria for Intentional Radiators

§ 15.247(d) Harmonic Emissions – Radiated and Conducted

Test Requirements: §15.247(d); §15.205: Emissions outside the frequency band.

§15.247(d): In any 100 kHz bandwidth outside the frequency band in which the spread spectrum or digitally modulated intentional radiator is operating, the radio frequency power that is produced by the intentional radiator shall be at least 20 dB below that in the 100 kHz bandwidth within the band that contains the highest level of the desired power, based on either an RF conducted or a radiated measurement. Attenuation below the general limits specified in § 15.209(a) is not required. In addition, radiated emissions which fall in the restricted bands, as defined in § 15.205(a), must also comply with the radiated emission limits specified in § 15.209(a).

§15.205(a): Except as shown in paragraph (d) of this section, only spurious emissions are permitted in any of the frequency bands listed below:

MHz	MHz	MHz	GHz
0.090–0.110-----	16.42–16.423	399.9–410	4.5–5.15
¹ 0.495–0.505-----	16.69475–16.69525	608–614	5.35–5.46
2.1735–2.1905-----	16.80425–16.80475	960–1240	7.25–7.75
4.125–4.128-----	25.5–25.67	1300–1427	8.025–8.5
4.17725–4.17775-----	37.5–38.25	1435–1626.5	9.0–9.2
4.20725–4.20775-----	73–74.6	1645.5–1646.5	9.3–9.5
6.215–6.218-----	74.8–75.2	1660–1710	10.6–12.7
6.26775–6.26825-----	108–121.94	1718.8–1722.2	13.25–13.4
6.31175–6.31225-----	123–138	2200–2300	14.47–14.5
8.291–8.294-----	149.9–150.05	2310–2390	15.35–16.2
8.362–8.366-----	156.52475–156.52525	2483.5–2500	17.7–21.4
8.37625–8.38675-----	156.7–156.9	2655–2900	22.01–23.12
8.41425–8.41475-----	162.0125–167.17	3260–3267	23.6–24.0
12.29–12.293-----	167.72–173.2	3332–3339	31.2–31.8
12.51975–12.52025-----	240–285	3345.8–3358.36	43–36.5
12.57675–12.57725-----	322–335.4	3600–4400	(²)

Table 19. Restricted Bands of Operation

¹ Until February 1, 1999, this restricted band shall be 0.490 – 0.510 MHz.

² Above 38.6



Electromagnetic Compatibility Criteria for Intentional Radiators

§ 15.247(d) Harmonic Emissions Requirements – Radiated (802.11a)

Frequency (MHz)	Receive Antenna Polarity (H/V)	Uncorrected Field strength (dBµV)@ 3m	Preamp (dB)	Antenna Factor (dB)	Cable Loss (dB)	Corrected Field Strength @ 3m (dBµV)	Limit @ 3m (dBµV)	Margin (dB)	Measurement Type
11490	V	58.4	34.7	39	9.4	72.1	74	-1.9	pk
11490	V	38.5	34.7	39	9.4	52.2	54	-1.8	avg
17235	V	46.6	33.0	44.5	11.8	69.9	74	-4.1	pk
Low Channel 5745 MHz									
Frequency (MHz)	Receive Antenna Polarity (H/V)	Uncorrected Field strength (dBµV)@ 3m	Preamp (dB)	Antenna Factor (dB)	Cable Loss (dB)	Corrected Field Strength @ 3m (dBµV)	Limit @ 3m (dBµV)	Margin (dB)	Measurement Type
11570	V	58.2	34.7	39	9.4	71.9	74	-2.1	pk
11570	V	39.2	34.7	39	9.4	52.9	54	-1.1	avg
17355	V	48.1	33.0	44.5	11.8	71.4	74	-2.6	pk
Mid Channel 5785 MHz									
Frequency (MHz)	Receive Antenna Polarity (H/V)	Uncorrected Field strength (dBµV)@ 3m	Preamp (dB)	Antenna Factor (dB)	Cable Loss (dB)	Corrected Field Strength @ 3m (dBµV)	Limit @ 3m (dBµV)	Margin (dB)	Measurement Type
11650	V	57.4	34.7	39	9.4	71.1	74	-2.9	pk
11650	V	38.4	34.7	39	9.4	52.1	54	-1.9	avg
17475	V	43.1	33.0	44.5	11.8	66.4	74	-7.6	pk
High Channel 5825 MHz									

Note: All other emissions were measured at the noise floor of the spectrum analyzer



Photograph 4. Test Equipment and setup for various Radiated Measurements



Electromagnetic Compatibility Criteria for Intentional Radiators

§ 15.247(d) Spurious Emissions Requirements –RF Conducted

Test Procedure: For intentional radiators with a digital device portion which operates below 10 GHz, the spectrum was investigated as per §15.33(a)(1) and §15.33(a)(4); i.e., the lowest RF signal generated or used in the device up to the 10th harmonic of the highest fundamental frequency or to 40 GHz, whichever is lower.

For frequencies 1-18GHz, measurements were made at coupler port of a 20dB directional coupler. The output of the coupler was terminated by a 50Ω load. For frequencies 18-40GHz a HP11970A and HP11970K harmonic mixer was used. Each harmonic mixer was fed with a SMA to wave guide adapter.

Test Results: Equipment complies with the Spurious Emissions Requirements – Radiated and RF Conducted limits of § 15.247 (c). For Radiated Emissions result, refer to section “§15.209: Radiated Emission Limits”. See following pages for detailed test results with RF Conducted Spurious Emissions and §15.205.

Test Engineer(s): Shawn McMillen

Test Date(s): February 28, 2007

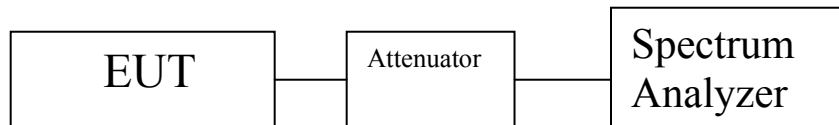

Block Diagram 3. Spurious Conducted Emissions Test Setup



Electromagnetic Compatibility Criteria for Intentional Radiators

§ 15.247(e), A8.2(2) Peak Power Spectral Density

Test Requirements: §15.247(e), A8.2, A8.2(2): For digitally modulated systems, the peak power spectral density conducted from the intentional radiator to the antenna shall not be greater than 8dBm in any 3 kHz band during any time interval of continuous transmission.

Test Procedure: The transmitter was connected directly to a Spectrum Analyzer through a directional coupler. The power was monitored at the coupler port with a Peak Power Meter. The power level was set to the maximum level. The RBW and VBW were set to 3 kHz and a SPAN of 3.0 MHz with a 100 second sweep to the Spectrum Analyzer. Measurements were carried out at the low, mid and high channels.

Test Results: Equipment complies with the peak power spectral density limits of § 15.247 (e), A8.2(2). The peak power spectral density was determined from plots on the following page(s).

802.11a				
Carrier Channel	Frequency (MHz)	Measured PPSD (dBm)	Limit (dBm)	Margin (dB)
Low	5745	-4.30	8	3.7
Mid	5785	-2.80	8	5.2
High	5825	-1.97	8	6.03

Test Engineer: Shawn McMillen

Test Date: February 28, 2007



IV. Test Equipment



Test Equipment

Calibrated test equipment utilized during testing was maintained in a current state of calibration per the requirements of ANSI/NCSL Z540-1-1994 and ANSI/ISO/IEC 17025:2000.

MET Asset #	Equipment	Manufacturer	Model	Last Cal Date	Cal Due Date
1S2421	EMI RECEIVER	ROHDE&SCHWARZ	ESIB 7	3/23/2007	3/23/2008
1S2184	BILOG ANTENNA	CHASE	CBL6112A	1/3/2007	1/3/2008
1S2121	PRE-AMPLIFIER	HEWLETT PACKARD	8449B	11/28/2006	11/28/2007
1S2198	ANTENNA, HORN	EMCO	3115	8/17/2006	8/17/2007
1S2202	ANTENNA, HORN, 1 METER	EMCO	3116	3/23/2004	3/23/2007
N/A	HIGH PASS FILTER	MICRO-TRONICS	HPM13146	SEE NOTE	
1S2263	CHAMBER, 10 METER	RANTEC	N2-14	8/15/2006	8/15/2007
1S2034	COUPLER, DIRECTIONAL 1-20 GHz	KRYTAR	101020020	SEE NOTE	
1S2041	COUPLER, BI DIRECTIONAL COAXIAL	NARDA	N/A	SEE NOTE	
1S2460	Analyzer, Spectrum 9 kHz-40GHz	Agilent	E4407B	07/06/2005	07/06/2008
1S2430	WIDEBAND POWER METER	ANRITSU COMPANY	ML2488A	1/12/2007	1/12/2008
1S2432	WIDEBAND POWER SENSOR	ANRITSU COMPANY	MA2491A	1/12/2007	1/12/2008
1S2034	COUPLER, DIRECTIONAL 1-20 GHz	KRYTAR	101020020	SEE NOTE	
1S2041	COUPLER, BI DIRECTIONAL COAXIAL	NARDA	N/A	SEE NOTE	
1S2128	Harmonic Mixer	Hewlett Packard	11970A	10/26/2006	10/26/2009
1S2129	Harmonic Mixer	Hewlett Packard	11970K	10/26/2006	10/26/2009

Note: Functionally tested equipment is verified using calibrated instrumentation at the time of testing.



V. Certification & User's Manual Information



Certification & User's Manual Information

A. Certification Information

The following is extracted from Title 47 of the Code of Federal Regulations, Part 2, Subpart I — Marketing of Radio frequency devices:

§ 2.801 Radio-frequency device defined.

As used in this part, a radio-frequency device is any device which in its operation is capable of Emitting radio-frequency energy by radiation, conduction, or other means. Radio- frequency devices include, but are not limited to:

- (a) The various types of radio communication transmitting devices described throughout this chapter.
- (b) *The incidental, unintentional and intentional radiators defined in Part 15 of this chapter.*
- (c) The industrial, scientific, and medical equipment described in Part 18 of this chapter.
- (d) Any part or component thereof which in use emits radio-frequency energy by radiation, conduction, or other means.

§ 2.803 Marketing of radio frequency devices prior to equipment authorization.

- (a) Except as provided elsewhere in this chapter, no person shall sell or lease, or offer for sale or lease (including advertising for sale or lease), or import, ship or distribute for the purpose of selling or leasing or offering for sale or lease, any radio frequency device unless:
 - (1) In the case of a device subject to certification, such device has been authorized by the Commission in accordance with the rules in this chapter and is properly identified and labeled as required by §2.925 and other relevant sections in this chapter; or
 - (2) In the case of a device that is not required to have a grant of equipment authorization issued by the Commission, but which must comply with the specified technical standards prior to use, such device also complies with all applicable administrative (including verification of the equipment or authorization under a Declaration of Conformity, where required), technical, labeling and identification requirements specified in this chapter.
- (d) Notwithstanding the provisions of paragraph (a) of this section, the offer for sale solely to business, commercial, industrial, scientific or medical users (but not an offer for sale to other parties or to end users located in a residential environment) of a radio frequency device that is in the conceptual, developmental, design or pre-production stage is permitted prior to equipment authorization or, for devices not subject to the equipment authorization requirements, prior to a determination of compliance with the applicable technical requirements *provided* that the prospective buyer is advised in writing at the time of the offer for sale that the equipment is subject to the FCC rules and that the equipment will comply with the appropriate rules before delivery to the buyer or to centers of distribution.



- (e)(1) Notwithstanding the provisions of paragraph (a) of this section, prior to equipment authorization or determination of compliance with the applicable technical requirements any radio frequency device may be operated, but not marketed, for the following purposes and under the following conditions:
- (i) *Compliance testing;*
 - (ii) Demonstrations at a trade show provided the notice contained in paragraph (c) of this section is displayed in a conspicuous location on, or immediately adjacent to, the device;
 - (iii) Demonstrations at an exhibition conducted at a business, commercial, industrial, scientific or medical location, but excluding locations in a residential environment, provided the notice contained in paragraphs (c) or (d) of this section, as appropriate, is displayed in a conspicuous location on, or immediately adjacent to, the device;
 - (iv) Evaluation of product performance and determination of customer acceptability, provided such operation takes place at the manufacturer's facilities during developmental, design or pre-production states; or
 - (v) Evaluation of product performance and determination of customer acceptability where customer acceptability of a radio frequency device cannot be determined at the manufacturer's facilities because of size or unique capability of the device, provided the device is operated at a business, commercial, industrial, scientific or medical user's site, but not at a residential site, during the development, design or pre-production stages.
- (e)(2) For the purpose of paragraphs (e)(1)(iv) and (e)(1)(v) of this section, the term *manufacturer's facilities* includes the facilities of the party responsible for compliance with the regulations and the manufacturer's premises, as well as the facilities of other entities working under the authorization of the responsible party in connection with the development and manufacture, but not the marketing, of the equipment.
- (f) For radio frequency devices subject to verification and sold solely to business, commercial, industrial, scientific and medical users (excluding products sold to other parties or for operation in a residential environment), parties responsible for verification of the devices shall have the option of ensuring compliance with the applicable technical specifications of this chapter at each end user's location after installation, provided that the purchase or lease agreement includes a proviso that such a determination of compliance be made and is the responsibility of the party responsible for verification of the equipment.



Certification & User's Manual Information

The following is extracted from Title 47 of the Code of Federal Regulations, Part 2, Subpart J — Equipment Authorization Procedures:

§ 2.901 Basis and Purpose

- (a) In order to carry out its responsibilities under the Communications Act and the various treaties and international regulations, and in order to promote efficient use of the radio spectrum, the Commission has developed technical standards for radio frequency equipment and parts or components thereof. The technical standards applicable to individual types of equipment are found in that part of the rules governing the service wherein the equipment is to be operated.¹ *In addition to the technical standards provided, the rules governing the service may require that such equipment be verified by the manufacturer or importer, be authorized under a Declaration of Conformity, or receive an equipment authorization from the Commission by one of the following procedures: certification or registration.*
- (b) The following sections describe the verification procedure, the procedure for a Declaration of Conformity, and the procedures to be followed in obtaining certification from the Commission and the conditions attendant to such a grant.

§ 2.907 Certification.

- (a) Certification is an equipment authorization issued by the Commission, based on representation and test data submitted by the applicant.
- (b) Certification attaches to all units subsequently marketed by the grantee which are identical (see Section 2.908) to the sample tested except for permissive changes or other variations authorized by the Commission pursuant to Section 2.1043.

¹ In this case, the equipment is subject to the rules of Part 15. More specifically, the equipment falls under Subpart B (of Part 15), which deals with unintentional radiators.



Certification & User's Manual Information

§ 2.948 Description of measurement facilities.

- (a) Each party making measurements of equipment that is subject to an equipment authorization under Part 15 or Part 18 of this chapter, regardless of whether the measurements are filed with the Commission or kept on file by the party responsible for compliance of equipment marketed within the U.S. or its possessions, shall compile a description of the measurement facilities employed.
 - (1) If the measured equipment is subject to the verification procedure, the description of the measurement facilities shall be retained by the party responsible for verification of the equipment.
 - (i) *If the equipment is verified through measurements performed by an independent laboratory, it is acceptable for the party responsible for verification of the equipment to rely upon the description of the measurement facilities retained by or placed on file with the Commission by that laboratory. In this situation, the party responsible for the verification of the equipment is not required to retain a duplicate copy of the description of the measurement facilities.*
 - (ii) If the equipment is verified based on measurements performed at the installation site of the equipment, no specific site calibration data is required. It is acceptable to retain the description of the measurement facilities at the site at which the measurements were performed.
 - (2) If the equipment is to be authorized by the Commission under the certification procedure, the description of the measurement facilities shall be filed with the Commission's Laboratory in Columbia, Maryland. The data describing the measurement facilities need only be filed once but must be updated as changes are made to the measurement facilities or as otherwise described in this section. At least every three years, the organization responsible for filing the data with the Commission shall certify that the data on file is current.



Certification & User's Manual Information

Label and User's Manual Information

The following is extracted from Title 47 of the Code of Federal Regulations, Part 15, Subpart A — General:

§ 15.19 Labeling requirements.

(a) *In addition to the requirements in Part 2 of this chapter, a device subject to certification or verification shall be labeled as follows:*

- (1) Receivers associated with the operation of a licensed radio service, e.g., FM broadcast under Part 73 of this chapter, land mobile operation under Part 90, etc., shall bear the following statement in a conspicuous location on the device:

This device complies with Part 15 of the FCC Rules. Operation is subject to the condition that this device does not cause harmful interference.

- (2) A stand-alone cable input selector switch, shall bear the following statement in a conspicuous location on the device:

This device is verified to comply with Part 15 of the FCC Rules for use with cable television service.

- (3) All other devices shall bear the following statement in a conspicuous location on the device:

This device complies with Part 15 of the FCC Rules. Operation is subject to the following two conditions: (1) This device may not cause harmful interference, and (2) this device must accept any interference received, including interference that may cause undesired operation.

- (4) Where a device is constructed in two or more sections connected by wires and marketed together, the statement specified under paragraph (a) of this section is required to be affixed only to the main control unit.

- (5) When the device is so small or for such use that it is not practicable to place the statement specified under paragraph (a) of this section on it, the information required by this paragraph shall be placed in a prominent location in the instruction manual or pamphlet supplied to the user or, alternatively, shall be placed on the container in which the device is marketed. However, the FCC identifier or the unique identifier, as appropriate, must be displayed on the device.

§ 15.21 Information to user.

The users manual or instruction manual for an intentional or unintentional radiator shall caution the user that changes or modifications not expressly approved by the party responsible for compliance could void the user's authority to operate the equipment.



Verification & User's Manual Information

The following is extracted from Title 47 of the Code of Federal Regulations, Part 15, Subpart B — Unintentional Radiators:

§ 15.105 Information to the user.

- (a) For a Class A digital device or peripheral, the instructions furnished the user shall include the following or similar statement, placed in a prominent location in the text of the manual:

Note: This equipment has been tested and found to comply with the limits for a Class A digital device, pursuant to Part 15 of the FCC Rules. These limits are designed to provide reasonable protection against harmful interference when the equipment is operated in a commercial environment. This equipment generates, uses, and can radiate radio frequency energy and, if not installed and used in accordance with the instruction manual, may cause harmful interference to radio communications. Operation of this equipment in a residential area is likely to cause harmful interference in which case the user will be required to correct the interference at own expense.

- (b) For a Class B digital device or peripheral, the instructions furnished the user shall include the following or similar statement, placed in a prominent location in the text of the manual:

Note: This equipment has been tested and found to comply with the limits for a Class B digital device, pursuant to Part 15 of the FCC Rules. These limits are designed to provide reasonable protection against harmful interference when the equipment is operated in a residential environment. This equipment generates, uses, and can radiate radio frequency energy and, if not installed and used in accordance with the instruction manual, may cause harmful interference to radio communications. However, there is no guarantee that interference will not occur in a particular installation. If this equipment does cause harmful interference to radio or television reception, which can be determined by turning the equipment off and on, the user is encouraged to try to correct the interference by one or more of the following measures:

- Reorient or relocate the receiving antenna.
- Increase the separation between the equipment and receiver.
- Connect the equipment into an outlet on a circuit different from that to which the receiver is connected.
- Consult the dealer or an experienced radio/TV technician for help.



ICES-003 Procedural & Labeling Requirements

From the Industry Canada Electromagnetic Compatibility Advisory Bulletin entitled, "Implementation and Interpretation of the Interference-Causing Equipment Standard for Digital Apparatus, ICES-003" (EMCAB-3, Issue 2, July 1995):

"At present, CISPR 22: 2002 and ICES technical requirements are essentially equivalent. Therefore, if you have CISPR 22: 2002 approval by meeting CISPR Publication 22, the only additional requirements are: to attach a note to the report of the test results for compliance, indicating that these results are deemed satisfactory evidence of compliance with ICES-003 of the Canadian Interference-Causing Equipment Regulations; to maintain these records on file for the requisite five year period; and to provide the device with a notice of compliance in accordance with ICES-003."

Procedural Requirements:

According to Industry Canada's Interference Causing Equipment Standard for Digital Apparatus ICES-003 Issue 4, February 2004:

- Section 6.1: A record of the measurements and results, showing the date that the measurements were completed, shall be retained by the manufacturer or importer for a period of at least five years from the date shown in the record and made available for examination on the request of the Minister.
- Section 6.2: A written notice indicating compliance must accompany each unit of digital apparatus to the end user. The notice shall be in the form of a label that is affixed to the apparatus. Where because of insufficient space or other constraints it is not feasible to affix a label to the apparatus, the notice may be in the form of a statement in the user's manual.

Labeling Requirements:

The suggested text for the notice, in English and in French, is provided below, from the Annex of ICES-003:

This Class [²] digital apparatus complies with Canadian ICES-003.

Cet appareil numérique de la classe [¹] est conforme à la norme NMB-003 du Canada.

² Insert either A or B but not both as appropriate for the equipment requirements.



End of Report