

Test of SP-4700-A

This covers the following Product Series:

SP-4700, SP-3800

To: FCC 47 CFR Part 15.407 & IC RSS-210

Test Report Serial No.: TRIL05-U4b Rev A



TEST REPORT

FROM



Test of SP-4700-A

This covers the following Product Series:
SP-4700, SP-3800

To FCC 47 CFR Part 15.407 & IC RSS-210

Test Report Serial No.: TRIL05-U4b Rev A

Note: this report contains data with regard to the 5,150 to 5,350 MHz and 5470 to 5725 MHz bands for the SkyPilot SP-4700-A Wireless LAN Access Point. 5.8 GHz test data is reported in MiCOM Labs test report TRIL05-U2.

This report supersedes None

Applicant: Trilliant Networks, Inc
1100 Island Drive
Redwood City
CA 94065

Product Function: SkyPilot by Trilliant Wireless WAN
5 GHz Mesh Backhaul

Copy No: pdf Issue Date: 23rd May 2012

This Test Report is Issued Under the Authority of:

MiCOM Labs, Inc.

440 Boulder Court, Suite 200

Pleasanton, CA 94566 USA

Phone: +1 (925) 462-0304

Fax: +1 (925) 462-0306

www.micomlabs.com



TEST CERTIFICATE #2381.01

MiCOM Labs is an ISO 17025 Accredited Testing Laboratory



Title: SP-4700-A
To: FCC 47 CFR Part 15.407 & IC RSS-210
Serial #: TRIL05-U4b Rev A
Issue Date: 23rd May 2012
Page: 3 of 122

This page has been left intentionally blank

This test report may be reproduced in full only. The document may only be updated by MiCOM Labs personnel. Any changes will be noted in the Document History section of the report.



TABLE OF CONTENTS

ACCREDITATION, LISTINGS & RECOGNITION	5
TESTING ACCREDITATION	5
RECOGNITION.....	6
PRODUCT CERTIFICATION.....	7
1. TEST RESULT CERTIFICATE	9
2. REFERENCES AND MEASUREMENT UNCERTAINTY	10
2.1. Normative References	10
2.2. Test and Uncertainty Procedures	11
3. PRODUCT DETAILS AND TEST CONFIGURATIONS	12
3.1. Technical Details	12
3.2. Scope of Test Program.....	13
3.3. Equipment Model(s) and Serial Number(s)	15
3.4. Antenna Details	15
3.5. Cabling and I/O Ports	15
3.6. Test Configurations.....	16
3.7. Equipment Modifications.....	17
3.8. Deviations from the Test Standard	17
3.9. Subcontracted Testing or Third Party Data	17
4. TEST SUMMARY	18
5. TEST RESULTS	20
5.1. Device Characteristics	20
5.1.1. <i>26 dB and 99 % Bandwidth</i>	20
5.1.2. <i>Transmit Output Power</i>	31
5.1.3. <i>Peak Power Spectral Density</i>	38
5.1.4. <i>Peak Excursion Ratio</i>	49
5.1.5. <i>Frequency Stability</i>	60
5.1.6. <i>Maximum Permissible Exposure</i>	61
5.1.7. <i>Radiated Emissions</i>	62
5.1.8. <i>AC Wireline Conducted Emissions (150 kHz – 30 MHz)</i>	86
5.1.9. <i>DFS (Dynamic Frequency Selection)</i>	89
5.1.10. <i>Radar Burst at the Beginning of the Channel Availability Check Time:</i>	103
5.1.11. <i>Radar Burst at the End of the Channel Availability Check Time:</i>	105
5.1.12. <i>In-Service Monitoring for Channel Move Time, Channel Closing Transmission Time and Non-Occupancy Period</i>	107
5.1.13. <i>Statistical Performance Check</i>	115
6. PHOTOGRAPHS.....	118
6.1. Radiated Test Setup Below 1 GHz - Test Setup	118
6.2. Radiated Emissions Above 1 GHz - Test Setup	119
6.3. ac Wireline Emissions.....	120
7. TEST EQUIPMENT DETAILS.....	121

This test report may be reproduced in full only. The document may only be updated by MiCOM Labs personnel. Any changes will be noted in the Document History section of the report.



Title: SP-4700-A
To: FCC 47 CFR Part 15.407 & IC RSS-210
Serial #: TRIL05-U4b Rev A
Issue Date: 23rd May 2012
Page: 5 of 122

ACCREDITATION, LISTINGS & RECOGNITION

TESTING ACCREDITATION

MiCOM Labs, Inc. is an accredited Electrical testing laboratory per the international standard EN ISO/IEC 17025. The company is accredited by the American Association for Laboratory Accreditation (A2LA) www.a2la.org test laboratory number 2381.01. MiCOM Labs test schedule is available at the following URL; <http://www.a2la.org/scopepdf/2381-01.pdf>



The American Association for Laboratory Accreditation

World Class Accreditation

Accredited Laboratory

A2LA has accredited

MICOM LABS

Pleasanton, CA

for technical competence in the field of

Electrical Testing

This laboratory is accredited in accordance with the recognized International Standard ISO/IEC 17025:2005 *General Requirements for the Competence of Testing and Calibration Laboratories*. This accreditation demonstrates technical competence for a defined scope and the operation of a laboratory quality management system (refer to joint ISO-ILAC-IAF Communiqué dated 8 January 2009).

Presented this 27th day of March 2012.

President & CEO
For the Accreditation Council
Certificate Number 2381.01
Valid to November 30, 2013



For the tests or types of tests to which this accreditation applies, please refer to the laboratory's Electrical Scope of Accreditation.

This test report may be reproduced in full only. The document may only be updated by MiCOM Labs personnel. Any changes will be noted in the Document History section of the report.



RECOGNITION

MiCOM Labs, Inc has widely recognized Electrical testing capabilities. Our international recognition includes Conformity Assessment Body designation by APEC MRA** countries. Our test reports are widely accepted for global type approvals.

Country	Recognition Body	Status	Phase	Identification No.
USA	Federal Communications Commission (FCC)	TCB	-	Listing #: 102167
Canada	Industry Canada (IC)	FCB	APEC MRA 2	Listing #: 4143A-2
Japan	MIC (Ministry of Internal Affairs and Communication)	CAB	APEC MRA 2	210
	VCCI	--	--	No. 2959
Europe	European Commission	NB	EU MRA	NB 2280
Australia	Australian Communications and Media Authority (ACMA)	CAB	APEC MRA 1	US0159
Hong Kong	Office of the Telecommunication Authority (OFTA)	CAB	APEC MRA 1	
Korea	Ministry of Information and Communication Radio Research Laboratory (RRL)	CAB	APEC MRA 1	
Singapore	Infocomm Development Authority (IDA)	CAB	APEC MRA 1	
Taiwan	National Communications Commission (NCC) Bureau of Standards, Metrology and Inspection (BSMI)	CAB	APEC MRA 1	
Vietnam	Ministry of Communication (MIC)	CAB	APEC MRA 1	

**APEC MRA – Asia Pacific Economic Community Mutual Recognition Agreement.
Is a recognition agreement under which test lab is accredited to regulatory standards of the APEC member countries.

Phase I - recognition for product testing

Phase II – recognition for both product testing and certification

N/A – Not Applicable

**EU MRA – European Union Mutual Recognition Agreement.

Is a recognition agreement under which test lab is accredited to regulatory standards of the EU member countries.

**NB – Notified Body

This test report may be reproduced in full only. The document may only be updated by MiCOM Labs personnel. Any changes will be noted in the Document History section of the report.



Title: SP-4700-A
To: FCC 47 CFR Part 15.407 & IC RSS-210
Serial #: TRIL05-U4b Rev A
Issue Date: 23rd May 2012
Page: 7 of 122

PRODUCT CERTIFICATION

MiCOM Labs, Inc. is an accredited Product Certification Body per the international standard EN ISO/IEC Guide 65. The company is accredited by the American Association for Laboratory Accreditation (A2LA) www.a2la.org test laboratory number 2381.02. MiCOM Labs test schedule is available at the following URL; <http://www.a2la.org/scopepdf/2381-02.pdf>



The American Association for Laboratory Accreditation

"World Class Accreditation"

Accredited Product Certification Body

A2LA has accredited

MICOM LABS

Pleasanton, CA

for technical competence as a

Product Certification Body

This product certification body is accredited in accordance with the recognized International Standard ISO/IEC Guide 65:1996 *General requirements for bodies operating product certification systems*. This accreditation demonstrates technical competence for a defined scope and the operation of a quality management system.

Presented this 27th day of March 2012.



President & CEO
For the Accreditation Council
Certificate Number 2381.02
Valid to November 30, 2013

For the product certification schemes to which this accreditation applies, please refer to the organization's Product Certification Scope of Accreditation

USA Telecommunication Certification Body (TCB) - TCB Identifier – US0159

Industry Canada Certification Body - CAB Identifier – US0159

European Notified Body - Notified Body Identifier - 2280

Japan – Recognized Certification Body (RCB) - RCB Identifier - 210

This test report may be reproduced in full only. The document may only be updated by MiCOM Labs personnel. Any changes will be noted in the Document History section of the report.



Title: SP-4700-A
To: FCC 47 CFR Part 15.407 & IC RSS-210
Serial #: TRIL05-U4b Rev A
Issue Date: 23rd May 2012
Page: 8 of 122

DOCUMENT HISTORY

Document History		
Revision	Date	Comments
Draft		
Rev A	23 rd May 2012	Initial release.

This test report may be reproduced in full only. The document may only be updated by MiCOM Labs personnel. Any changes will be noted in the Document History section of the report.



Title: SP-4700-A
To: FCC 47 CFR Part 15.407 & IC RSS-210
Serial #: TRIL05-U4b Rev A
Issue Date: 23rd May 2012
Page: 9 of 122

1. TEST RESULT CERTIFICATE

Applicant:	Trilliant Networks, Inc 1100 Island Drive Redwood City CA 94065	Tested By:	MiCOM Labs, Inc. 440 Boulder Court Suite 200 Pleasanton California, 94566, USA
EUT:	802.11a Wireless WAN Mesh Node	Tel:	+1 925 462 0304
Model:	SP-4700-A The results of testing reported in this report cover the following Product Series: SP-4700, SP-3800	Fax:	+1 925 462 0306
S/N:	106366557		
Test Date(s):	8th to 10th March 2012	Website:	www.micomlabs.com

STANDARD(S)	TEST RESULTS
FCC 47 CFR Part 15.407 & IC RSS-210	EQUIPMENT COMPLIES

MiCOM Labs, Inc. tested the equipment mentioned in accordance with the requirements set forth in the above standards. Test results indicate that the equipment tested is capable of demonstrating compliance with the requirements as documented within this report.

Notes:

1. This document reports conditions under which testing was conducted and the results of testing performed.
2. Details of test methods used have been recorded and kept on file by the laboratory.
3. Test results apply only to the item(s) tested.

Approved & Released for MiCOM Labs, Inc. by:



TESTING CERTIFICATE #2381.01



Graeme Grieve
Quality Manager MiCOM Labs,

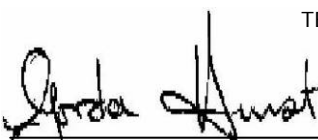

Gordon Hurst
President & CEO MiCOM Labs, Inc.

This test report may be reproduced in full only. The document may only be updated by MiCOM Labs personnel. Any changes will be noted in the Document History section of the report.

2. REFERENCES AND MEASUREMENT UNCERTAINTY

2.1. Normative References

Ref.	Publication	Year	Title
i.	FCC 47 CFR Part 15.407	2010	Code of Federal Regulations
ii.	FCC 06-96	June 2006	Memorandum Opinion and Order
iii.	FCC OET KDB 662911	4 th April 2011	Emissions Testing of Transmitters with Multiple Outputs in the Same Band
iv.	Industry Canada RSS-210	2010	Low Power License-Exempt Radiocommunication Devices (All Frequency Bands): Category 1 Equipment
v.	FCC 47 CFR Part 15, Subpart B	2010	47 CFR Part 15, SubPart B; Unintentional Radiators
vi.	ICES-003	2004	Spectrum Management and Telecommunications Policy Interference-Causing Equipment Standard Digital Apparatus; Issue 4
vii.	ANSI C63.4	2009	American National Standards for Methods of Measurement of Radio-Noise Emissions from Low-Voltage Electrical and Electronic Equipment in the Range of 9 kHz to 40 GHz
viii.	CISPR 22/ EN 55022	2008 2006+A 1:2007	Limits and Methods of Measurements of Radio Disturbance Characteristics of Information Technology Equipment
ix.	M 3003	Edition 1 Dec. 1997	Expression of Uncertainty and Confidence in Measurements
x.	LAB34	Edition 1 Aug 2002	The expression of uncertainty in EMC Testing
xi.	ETSI TR 100 028	2001	Parts 1 and 2 Electromagnetic compatibility and Radio Spectrum Matters (ERM); Uncertainties in the measurement of mobile radio equipment characteristics
xii.	A2LA	March 2012	Reference to A2LA Accreditation Status – A2LA Advertising Policy

This test report may be reproduced in full only. The document may only be updated by MiCOM Labs personnel. Any changes will be noted in the Document History section of the report.



Title: SP-4700-A
To: FCC 47 CFR Part 15.407 & IC RSS-210
Serial #: TRIL05-U4b Rev A
Issue Date: 23rd May 2012
Page: 11 of 122

2.2. Test and Uncertainty Procedures

Conducted and radiated emission measurements were conducted in accordance with American National Standards Institute ANSI C63.4, listed in the Normative References section of this report.

Measurement uncertainty figures are calculated in accordance with ETSI TR 100 028 Parts 1 and 2.

Measurement uncertainties stated are based on a standard uncertainty multiplied by a coverage factor $k = 2$, providing a level of confidence of approximately 95 % in accordance with UKAS document M 3003 listed in the Normative References section of this report.

This test report may be reproduced in full only. The document may only be updated by MiCOM Labs personnel. Any changes will be noted in the Document History section of the report.



Title: SP-4700-A
To: FCC 47 CFR Part 15.407 & IC RSS-210
Serial #: TRIL05-U4b Rev A
Issue Date: 23rd May 2012
Page: 12 of 122

3. PRODUCT DETAILS AND TEST CONFIGURATIONS

3.1. Technical Details

Details	Description
Purpose:	Test of the SP-4700-A in the frequency ranges 5,150 to 5,250 MHz, 5250 to 5350 MHz and 5470 to 5725 MHz to FCC Part 15.407 and Industry Canada RSS-210 regulations.
Applicant:	Trilliant Networks, Inc 1100 Island Drive Redwood City CA 94065
Manufacturer:	Senao Networks, Inc
Laboratory performing the tests:	MiCOM Labs, Inc. 440 Boulder Court, Suite 200 Pleasanton, California 94566 USA
Test report reference number:	TRIL05-U4b Rev A
Date EUT received:	8 th March 2012
Standard(s) applied:	FCC 47 CFR Part 15.407 & IC RSS-210
Dates of test (from - to):	8th to 10th March 2012
No of Units Tested:	One
Type of Equipment:	802.11a Wireless WAN Mesh Node
Product Name:	SkyPilot Connector
Model:	SP-4700-A
Hardware Release	Rev 02
Software Release	2.1
Location for use:	Outdoor only
Declared Frequency Range(s):	5150 - 5250 MHz, 5250 to 5350 MHz and 5470 to 5725 MHz
Type of Modulation:	Per 802.11 –CCK, BPSK, QPSK, DSSS, OFDM
Declared Nominal Average Output Power:	802.11a: Legacy 5150 - 5250 MHz; +4.5 dBm 5250 - 5350 MHz; +12.3 dBm 5470 - 5725 MHz; + 11.3 dBm
EUT Modes of Operation:	Legacy 802.11a
Transmit/Receive Operation:	Half Duplex
Rated Input Voltage and Current:	POE 48 Vdc 0.6 A
Operating Temperature Range:	Declared range -20° to +60°C
ITU Emission Designator:	5150 – 5250 MHz 802.11a 16M8D1D 5250 - 5350 MHz 802.11a 16M9D1D 5470 - 5725 MHz 802.11a 16M8D1D
Equipment Dimensions:	11.0 (W) x 6.5 (H) x 4.5 (D) inches
Weight:	2.5 lbs
Primary function of equipment:	Wireless WAN Mesh Backhaul
No of Units Tested:	One
Type of Equipment:	802.11a Wireless WAN Mesh Node

This test report may be reproduced in full only. The document may only be updated by MiCOM Labs personnel. Any changes will be noted in the Document History section of the report.

3.2. Scope of Test Program

The scope of the test program was to test the SkyPilot by Trilliant Wireless WAN SP-4700-A Mesh Node in the frequency ranges of 5150 to 5250 MHz, 5250 to 5350 MHz and 5470 to 5725 MHz for compliance against FCC 47 CFR Part 15.407 and Industry Canada RSS-210 specifications.

EUT

Trilliant Inc. supplied a SkyPilot SP-4700-A device that contains an 802.11a mesh backhaul radio as being representative of operation in the 5 GHz bands for all of the SkyPilot SP-4700 and SP-3800 Series products.

802.11a Wireless WAN Mesh Node

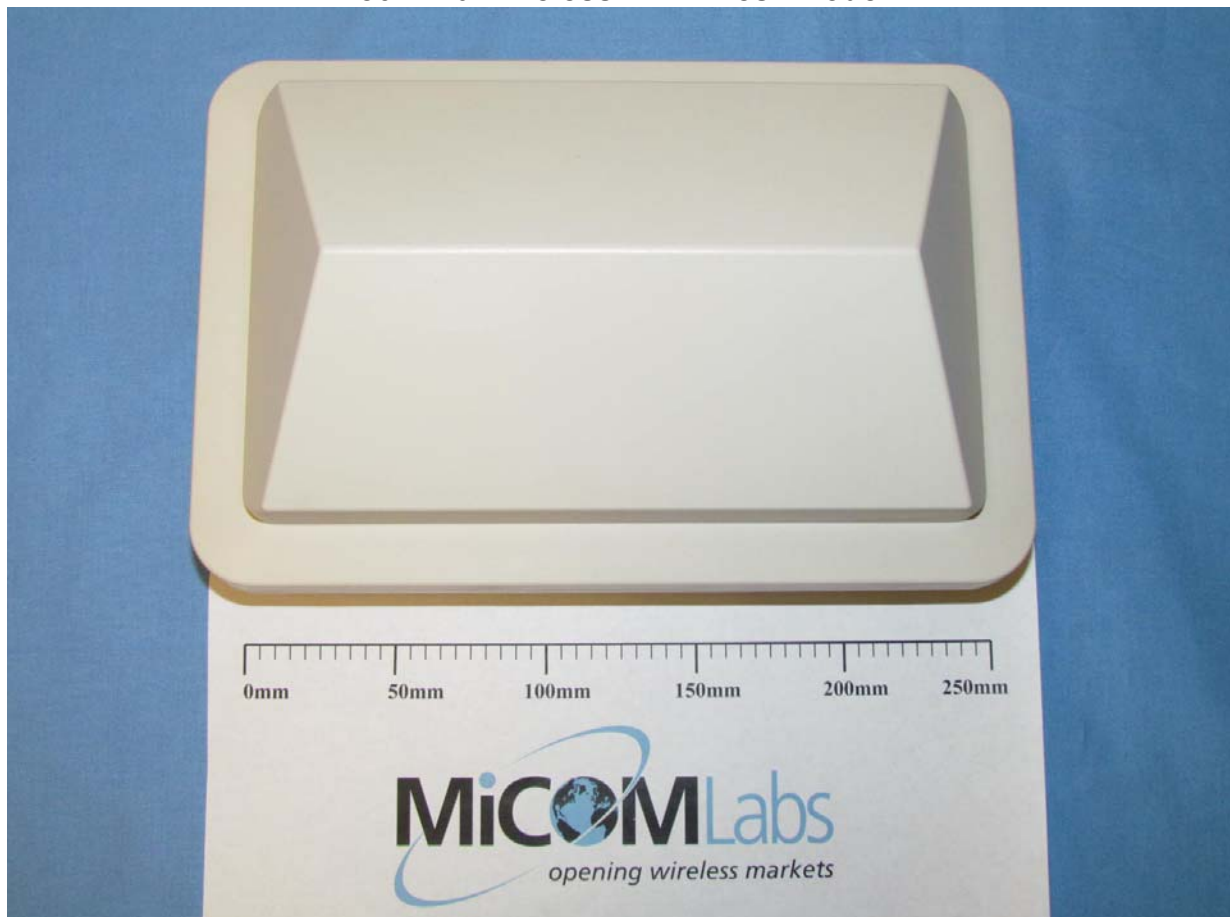

This test report may be reproduced in full only. The document may only be updated by MiCOM Labs personnel. Any changes will be noted in the Document History section of the report.



Title: SP-4700-A
To: FCC 47 CFR Part 15.407 & IC RSS-210
Serial #: TRIL05-U4b Rev A
Issue Date: 23rd May 2012
Page: 14 of 122

The customer supplied the following information about the products that are represented by the radio product.

There are no hardware differences between the 802.11a 5 GHz mesh radios. Differences between models are country specific, regulatory settings that are incorporated in the software.

Summary Table of Model Numbers
Connectors
SP-4700-A SP-4700-R SP-4700-xx
DualBand Connectors
SP-3800-W-A SP-3800-W-N SP-3800-W-E SP-3800-W-xx

Explanation of Model Numbers

Product Name: SkyPilot by Trilliant Wireless WAN Connector Series

Model Numbers: SP-4700 Series.

The SkyPilot by Trilliant Wireless WAN Connector Series consists of the following models:

SP-4700-A, SP-4700-R, SP-4700-XX

(where X is 0 to 9, A to Z or blank)

Product Name: SkyPilot by Trilliant Wireless WAN Connector DualBand Series

Model Numbers: SP-3800-W Series.

The SkyPilot by Trilliant Wireless WAN Connector DualBand Series consists of the following models:

SP-3800-W-A, SP-3800-W-N, SP-3800-W-E, SP-3800-W-XX

(where X is 0 to 9, A to Z or blank)

This test report may be reproduced in full only. The document may only be updated by MiCOM Labs personnel. Any changes will be noted in the Document History section of the report.



Title: SP-4700-A
To: FCC 47 CFR Part 15.407 & IC RSS-210
Serial #: TRIL05-U4b Rev A
Issue Date: 23rd May 2012
Page: 15 of 122

3.3. Equipment Model(s) and Serial Number(s)

Type (EUT/Support)	Equipment Description (Including Brand Name)	Mfr	Model No.	Serial No.
EUT	SkyPilot by Trilliant Wireless WAN	Trilliant Networks	SP-4700-A	106366557
Support	Laptop PC	IBM	Thinkpad	None

3.4. Antenna Details

Model	Gain (dBi)	Frequency Range (MHz)
Integral Panel	17.0	5150 - 5350
	18.5	5470 - 5725

3.5. Cabling and I/O Ports

Number and type of I/O ports

1. RJ-45 10/100/1000 Ethernet & 48 Vdc POE (x1)

This test report may be reproduced in full only. The document may only be updated by MiCOM Labs personnel. Any changes will be noted in the Document History section of the report.



Title: SP-4700-A
To: FCC 47 CFR Part 15.407 & IC RSS-210
Serial #: TRIL05-U4b Rev A
Issue Date: 23rd May 2012
Page: 16 of 122

3.6. Test Configurations

Testing was performed to determine the highest power level versus bit rate. The variant with the highest power was used to exercise the product.

Operational Mode	Variant	Data Rates with Highest Power	Frequencies (MHz)
802.11a	Legacy	6 MBit/s	5,180 / 5,200 / 5,240 5,260 / 5,300 / 5,320 5,500 / 5,580 / 5,700

Spurious Emission and Band-Edge Test Strategy Band 5,150 – 5,250 MHz, 5250 – 5350 MHz and 5470 – 5725 MHz

11a
SE 5180
SE 5200
SE 5240
BE 5150
SE 5260
SE 5300
SE 5320
SE 5500
SE 5580
SE 5700
BE 5350
BE 5460

KEY:-

SE – Spurious Emissions

BE – Band-Edge

PK - Peak Emission

This test report may be reproduced in full only. The document may only be updated by MiCOM Labs personnel. Any changes will be noted in the Document History section of the report.



Title: SP-4700-A
To: FCC 47 CFR Part 15.407 & IC RSS-210
Serial #: TRIL05-U4b Rev A
Issue Date: 23rd May 2012
Page: 17 of 122

3.7. Equipment Modifications

The following modifications were required to bring the equipment into compliance:

1. None.

3.8. Deviations from the Test Standard

The following deviations from the test standard were required in order to complete the test program:

1. NONE

3.9. Subcontracted Testing or Third Party Data

1. NONE

This test report may be reproduced in full only. The document may only be updated by MiCOM Labs personnel. Any changes will be noted in the Document History section of the report.



4. TEST SUMMARY

List of Measurements

The following table represents the list of measurements required under the **FCC CFR47 Part 15.407** and **Industry Canada RSS-210** and **Industry Canada RSS-Gen**.

Section(s)	Test Items	Description	Condition	Result	Test Report Section
15.407(a) A9.2(2) 4.4	26dB and 99% Emission BW	Emission bandwidth measurement	Conducted	Complies	5.1.1
15.407(a) A9.2(2) 4.6	Transmit Output Power	Power Measurement	Conducted	Complies	5.1.2
15.407(a) A9.2(2)	Peak Power Spectral Density	PPSD	Conducted	Complies	5.1.3
15.407(a)(6)	Peak Excursion Ratio	<13dB in any 1MHz bandwidth	Conducted	Complies	5.1.4
15.407(g) 15.31 2.1 4.5	Frequency Stability	Limits: contained within band of operation at all times.	Applicant declaration	Complies	5.1.5
15.407(f) 5.5	Radio Frequency Radiation Exposure	Exposure to radio frequency energy levels, Maximum Permissible Exposure (MPE)	Conducted	Complies	5.1.6

This test report may be reproduced in full only. The document may only be updated by MiCOM Labs personnel. Any changes will be noted in the Document History section of the report.



List of Measurements (continued)

The following table represents the list of measurements required under the **FCC CFR47 Part 15.407** and **Industry Canada RSS-210** and **Industry Canada RSS-Gen**.

Section(s)	Test Items	Description	Condition	Result	Test Report Section
15.407(b)(2) 15.205(a) 15.209(a) 2.2 2.6 A9.3(2) 4.7	Radiated Emissions		Radiated		5.1.7
	Transmitter Radiated Spurious Emissions	Emissions above 1 GHz		Complies	5.1.7.1
	Radiated Band Edge	Band edge results		Complies	5.1.7.1
Industry Canada only RSS-Gen §4.10, §6	Receiver Radiated Spurious Emissions	Emissions above 1 GHz		Complies	5.1.7.2
15.407(b)(6) 15.205(a) 15.209(a) 2.2	Radiated Emissions	Emissions <1 GHz (30M-1 GHz)		Complies	5.1.7.3
15.407(b)(6) 15.207 7.2.2	AC Wireline Conducted Emissions 150 kHz–30 MHz	Conducted Emissions	Conducted	Complies	5.1.8

This test report may be reproduced in full only. The document may only be updated by MiCOM Labs personnel. Any changes will be noted in the Document History section of the report.

5. TEST RESULTS

5.1. Device Characteristics

5.1.1. 26 dB and 99 % Bandwidth

FCC, Part 15 Subpart C §15.407(a)
Industry Canada RSS-210 § A9.2(2)
Industry Canada RSS-Gen 4.4

Test Procedure

The bandwidth at 26 dB and 99 % is measured with a spectrum analyzer connected to the antenna terminal, while EUT is operating in transmission mode at the appropriate center frequency.

Test Measurement Set up

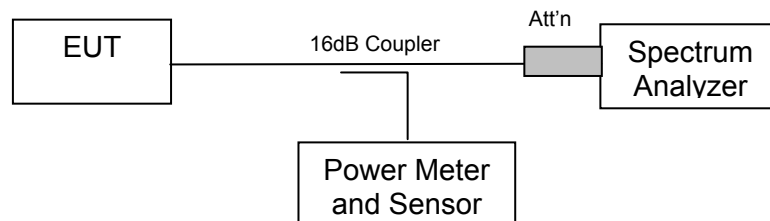

Measurement set up for 26 dB and 99 % bandwidth test

Radio Parameters

Duty Cycle: 100%

Output: Modulated Carrier

Power: Maximum Default Power



Title: SP-4700-A
To: FCC 47 CFR Part 15.407 & IC RSS-210
Serial #: TRIL05-U4b Rev A
Issue Date: 23rd May 2012
Page: 21 of 122

Measurement Results for 26 dB and 99 % Operational Bandwidth(s)

Ambient conditions.

Temperature: 17 to 23 °C Relative humidity: 31 to 57 % Pressure: 999 to 1012 mbar

TABLE OF RESULTS – 802.11a Legacy 5150 – 5250 MHz

Test Conditions:	15.407 (a)	Rel. Humidity (%):	35 to 42
Variant:	802.11a	Ambient Temp. (°C):	19 to 22
TPC:	HIGH	Pressure (mBars):	998 to 1003
Modulation:	ON	Duty Cycle (x):	100
Beam Forming Gain (Y):	N/A dB	Antenna Gain:	17 dBi
Applied Voltage:	48.0 Vdc		
Notes 1:			
Notes 2:			

26 dB Bandwidth

Test Frequency	26 dB Bandwidth				Minimum 6dB Bandwidth Limit		Margin
	MHz				kHz	MHz	
MHz	a	b	c	d			
5180	23.046000	--	--	--	500	0.5	-22.546000
5200	22.745000	--	--	--			-22.245000
5240	22.846000	--	--	--			-22.346000

99% Bandwidth

Test Frequency	99 % Bandwidth						
	MHz						
MHz	a	b	c	d			
5180	16.733000	--	--	--			
5200	16.733000	--	--	--			
5240	16.733000	--	--	--			

Measurement uncertainty:	±2.81 dB
---------------------------------	----------

This test report may be reproduced in full only. The document may only be updated by MiCOM Labs personnel. Any changes will be noted in the Document History section of the report.



Title: SP-4700-A
To: FCC 47 CFR Part 15.407 & IC RSS-210
Serial #: TRIL05-U4b Rev A
Issue Date: 23rd May 2012
Page: 22 of 122

PORT A 5,180 MHz 802.11a Legacy 26 dB and 99 % Bandwidth

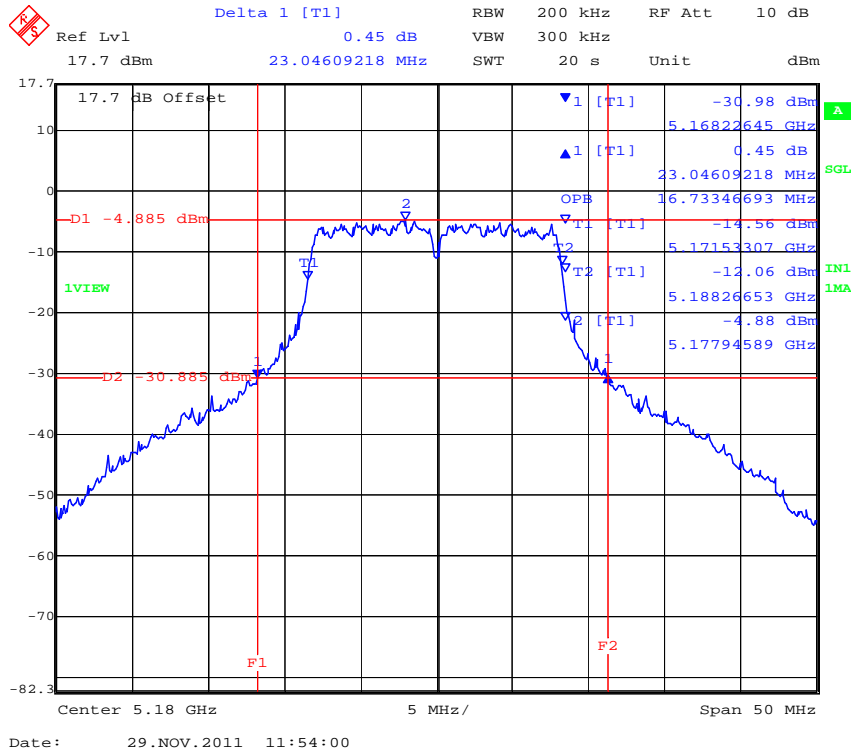

PORT A 5,200 MHz 802.11a Legacy 26 dB and 99 % Bandwidth

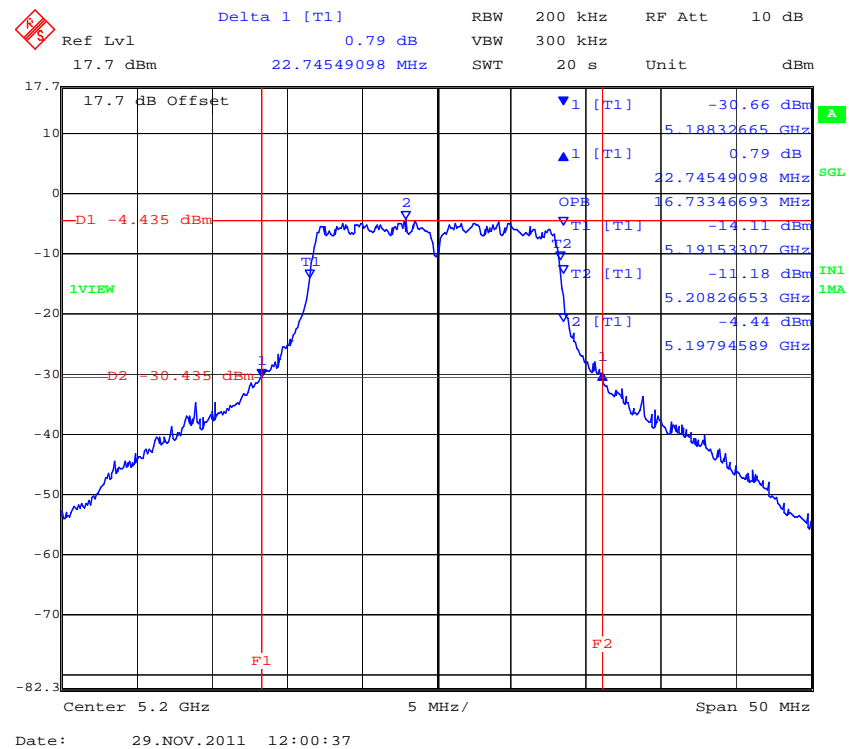

This test report may be reproduced in full only. The document may only be updated by MiCOM Labs personnel. Any changes will be noted in the Document History section of the report.



Title: SP-4700-A
To: FCC 47 CFR Part 15.407 & IC RSS-210
Serial #: TRIL05-U4b Rev A
Issue Date: 23rd May 2012
Page: 23 of 122

PORT A 5,240 MHz 802.11a Legacy 26 dB and 99 % Bandwidth

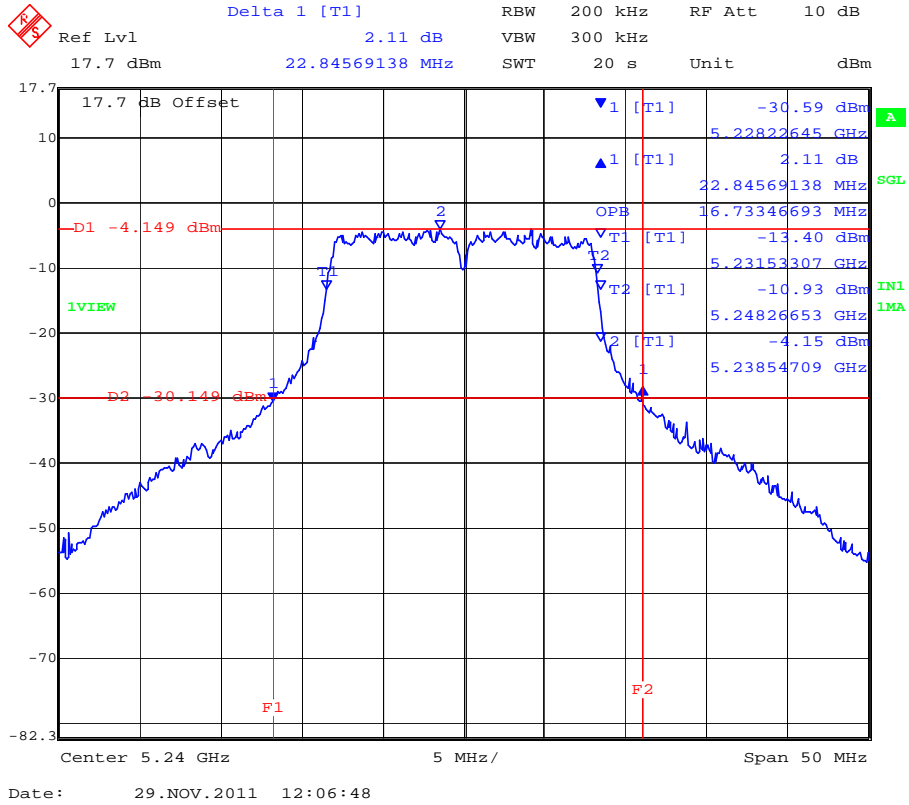

This test report may be reproduced in full only. The document may only be updated by MiCOM Labs personnel. Any changes will be noted in the Document History section of the report.



Title: SP-4700-A
To: FCC 47 CFR Part 15.407 & IC RSS-210
Serial #: TRIL05-U4b Rev A
Issue Date: 23rd May 2012
Page: 24 of 122

TABLE OF RESULTS – 802.11a Legacy 5250 – 5350 MHz

Test Conditions:	15.407	Rel. Humidity (%):	35 to 42
Variant:	802.11a	Ambient Temp. (°C):	19 to 22
TPC:	HIGH	Pressure (mBars):	998 to 1003
Modulation:	ON	Duty Cycle (x):	100
Beam Forming Gain (Y):	N/A dB	Antenna Gain:	17 dBi
Applied Voltage:	48.0 Vdc		
Notes 1:			
Notes 2:			

26 dB Bandwidth

Test Frequency	26 dB Bandwidth				Minimum 6dB Bandwidth Limit		Margin
	MHz				kHz	MHz	MHz
MHz	a	b	c	d			
5260	23.046000	--	--	--	500	0.5	-22.546000
5300	23.146000	--	--	--			-22.646000
5320	23.046000	--	--	--			-22.546000

99% Bandwidth

Test Frequency	99 % Bandwidth						
	MHz						
MHz	a	b	c	d			
5260	16.733000	--	--	--			
5300	16.834000	--	--	--			
5320	16.733000	--	--	--			

Measurement uncertainty:	±2.81 dB
---------------------------------	----------

This test report may be reproduced in full only. The document may only be updated by MiCOM Labs personnel. Any changes will be noted in the Document History section of the report.



Title: SP-4700-A
To: FCC 47 CFR Part 15.407 & IC RSS-210
Serial #: TRIL05-U4b Rev A
Issue Date: 23rd May 2012
Page: 25 of 122

PORT A 5,260 MHz 802.11a Legacy 26 dB and 99 % Bandwidth

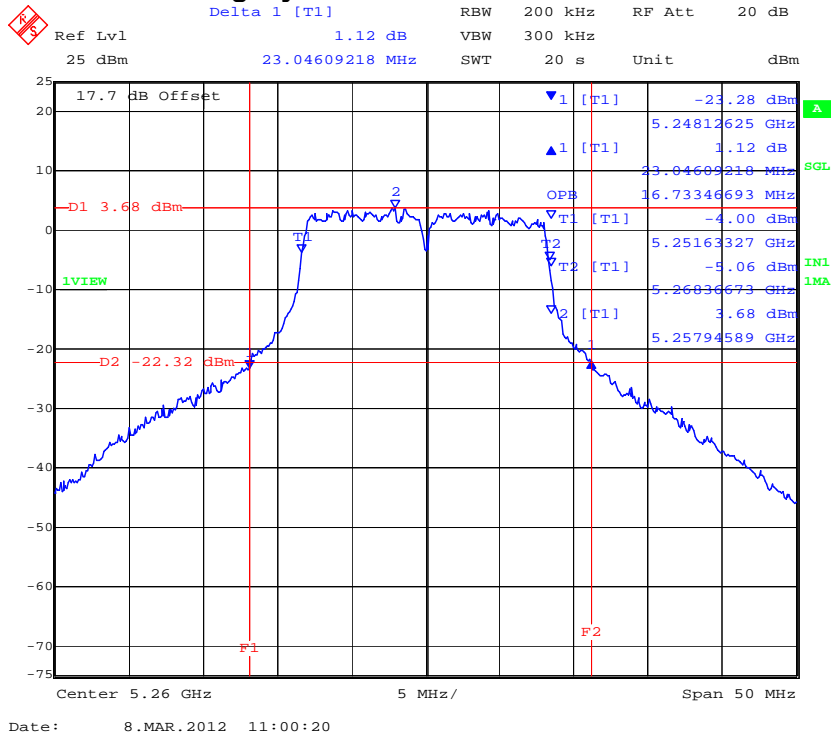

PORT A 5300 MHz 802.11a Legacy 26 dB and 99 % Bandwidth

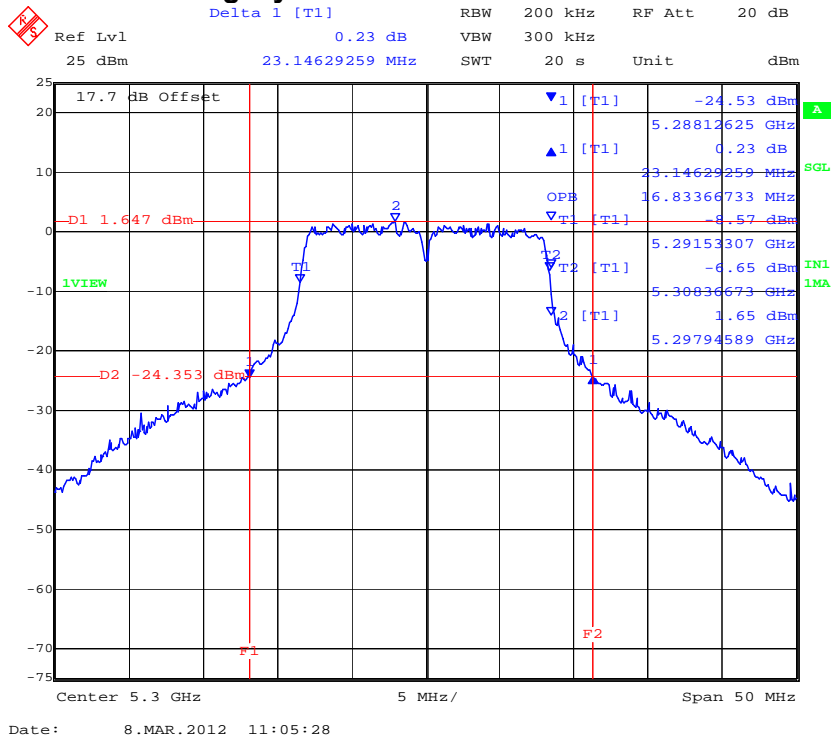

This test report may be reproduced in full only. The document may only be updated by MiCOM Labs personnel. Any changes will be noted in the Document History section of the report.



Title: SP-4700-A
To: FCC 47 CFR Part 15.407 & IC RSS-210
Serial #: TRIL05-U4b Rev A
Issue Date: 23rd May 2012
Page: 26 of 122

PORT A 5,320 MHz 802.11a Legacy 26 dB and 99 % Bandwidth

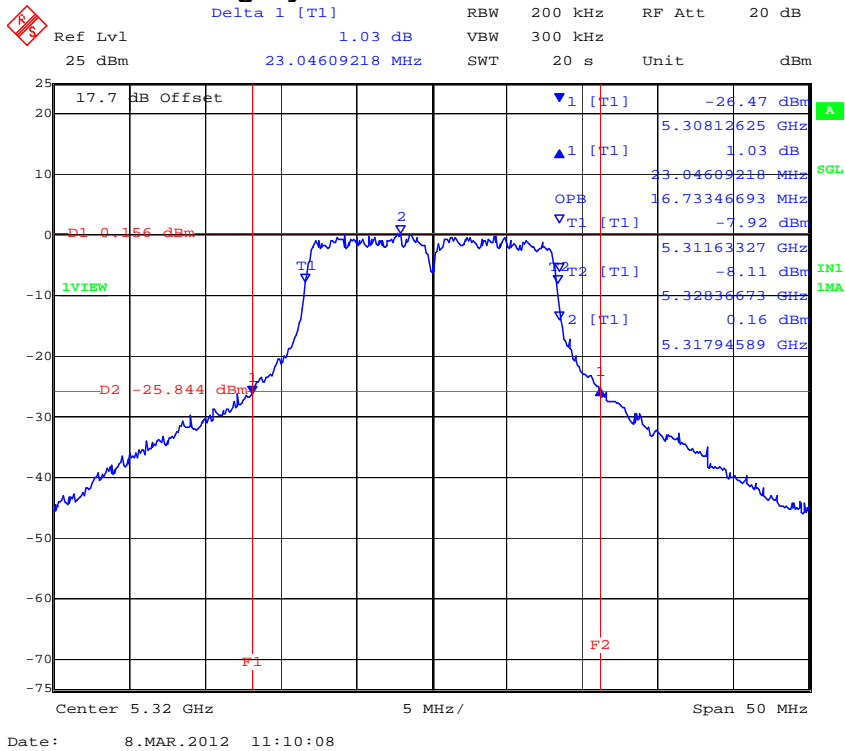

This test report may be reproduced in full only. The document may only be updated by MiCOM Labs personnel. Any changes will be noted in the Document History section of the report.



Title: SP-4700-A
To: FCC 47 CFR Part 15.407 & IC RSS-210
Serial #: TRIL05-U4b Rev A
Issue Date: 23rd May 2012
Page: 27 of 122

TABLE OF RESULTS – 802.11a Legacy 5500 – 5700 MHz

Test Conditions:	15.407	Rel. Humidity (%):	35 to 42
Variant:	802.11a	Ambient Temp. (°C):	19 to 22
TPC:	HIGH	Pressure (mBars):	998 to 1003
Modulation:	ON	Duty Cycle (x):	100
Beam Forming Gain (Y):	N/A dB	Antenna Gain:	18.5 dBi
Applied Voltage:	48.0 Vdc		
Notes 1:			
Notes 2:			

26 dB Bandwidth

Test Frequency	26 dB Bandwidth				Minimum 6dB Bandwidth Limit		Margin
	MHz				kHz	MHz	
MHz	a	b	c	d			
5500	23.948000	--	--	--	500	0.5	-23.448000
5580	23.046000	--	--	--			-22.546000
5700	23.046000	--	--	--			-22.546000

99% Bandwidth

Test Frequency	99 % Bandwidth						
	MHz						
MHz	a	b	c	d			
5500	16.733000	--	--	--			
5580	16.733000	--	--	--			
5700	16.733000	--	--	--			

Measurement uncertainty:	±2.81 dB
---------------------------------	----------

This test report may be reproduced in full only. The document may only be updated by MiCOM Labs personnel. Any changes will be noted in the Document History section of the report.



Title: SP-4700-A
To: FCC 47 CFR Part 15.407 & IC RSS-210
Serial #: TRIL05-U4b Rev A
Issue Date: 23rd May 2012
Page: 28 of 122

PORT A 5,500 MHz 802.11a Legacy 26 dB and 99 % Bandwidth

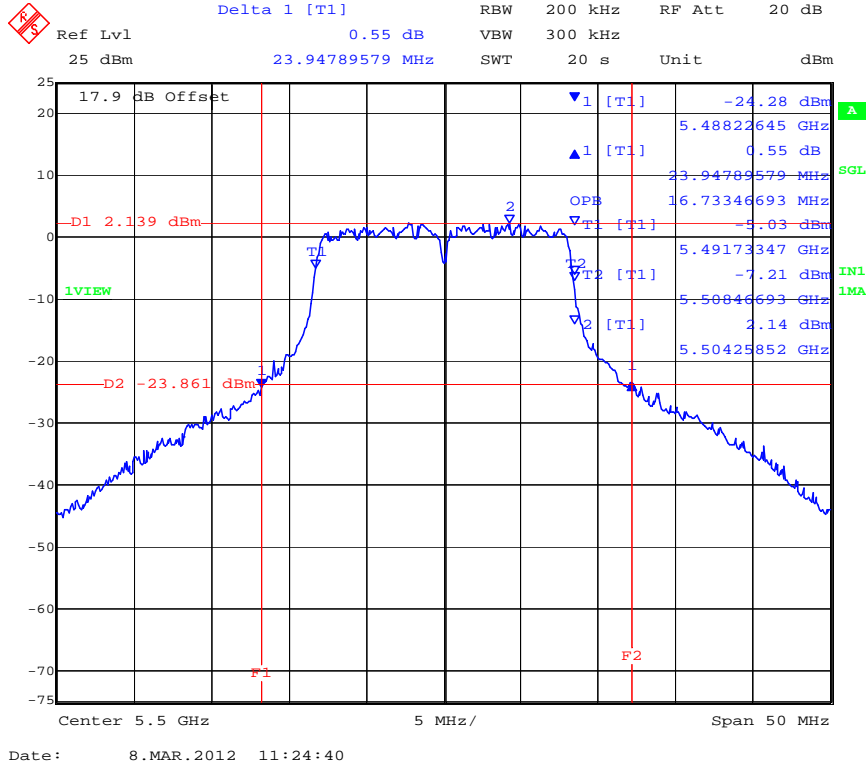

PORT A 5,580 MHz 802.11a Legacy 26 dB and 99 % Bandwidth

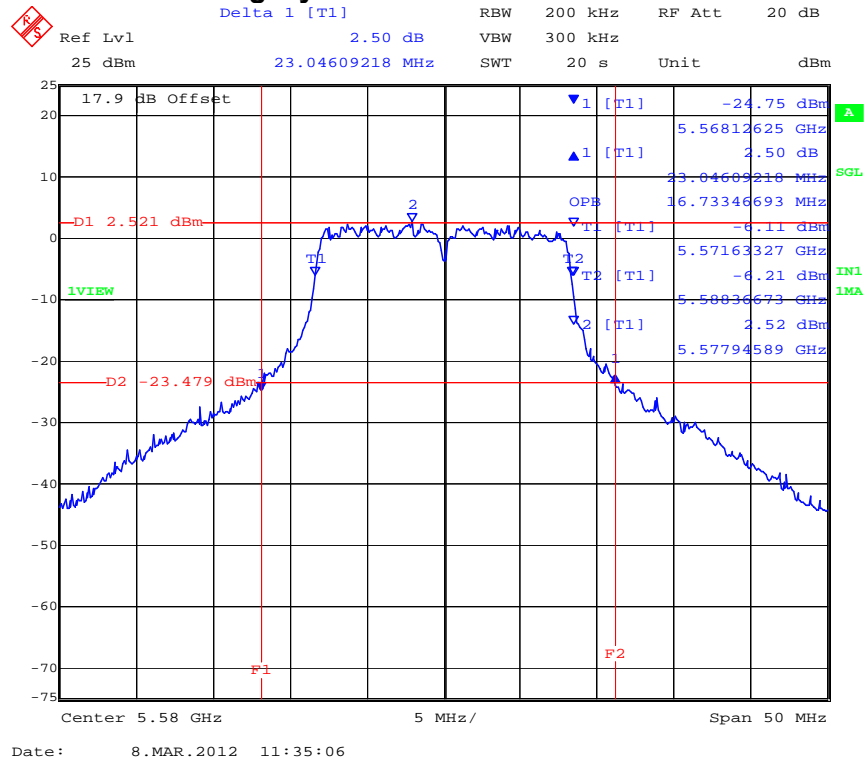

This test report may be reproduced in full only. The document may only be updated by MiCOM Labs personnel. Any changes will be noted in the Document History section of the report.



Title: SP-4700-A
To: FCC 47 CFR Part 15.407 & IC RSS-210
Serial #: TRIL05-U4b Rev A
Issue Date: 23rd May 2012
Page: 29 of 122

PORT A 5,700 MHz 802.11a Legacy 26 dB and 99 % Bandwidth

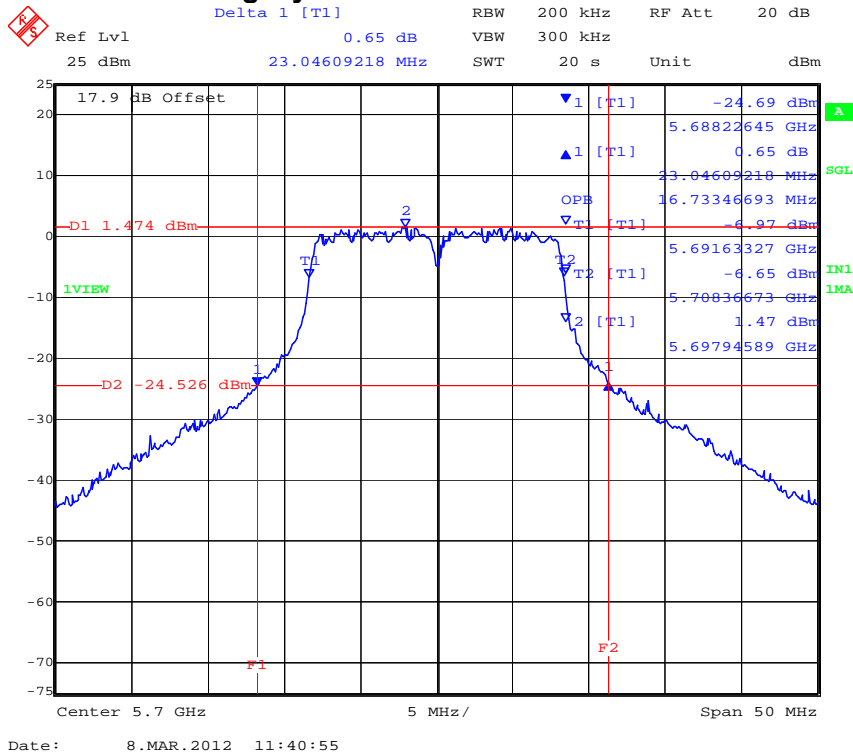

This test report may be reproduced in full only. The document may only be updated by MiCOM Labs personnel. Any changes will be noted in the Document History section of the report.



Title: SP-4700-A
To: FCC 47 CFR Part 15.407 & IC RSS-210
Serial #: TRIL05-U4b Rev A
Issue Date: 23rd May 2012
Page: 30 of 122

Specification

Limits

FCC, Part 15 §15.407 (a)(1), (a)(2) and Industry Canada RSS-210 § A9.2(2)

(a)(1) For the band 5.15-5.25 GHz the maximum conducted output power over the frequency band of operation shall not exceed the lesser of 50 mW or +4 dBm + 10 log B, where B is the 26 dB emission bandwidth in megahertz. In addition, the peak power spectral density shall not exceed +4 dBm in any 1 megahertz band.

(a)(2) For the 5.25-5.35 GHz band the maximum conducted output power over the frequency band of operation shall not exceed the lesser of 250 mW or +11 dBm + 10 log B, where B is the 26 dB emission bandwidth in megahertz. In addition, the peak power spectral density shall not exceed +11 dBm in any 1 megahertz band.

Industry Canada RSS-Gen 4.4

When an occupied bandwidth value is not specified in the applicable RSS, the transmitted signal bandwidth to be reported is to be its 99% emission bandwidth, as calculated or measured.

Laboratory Measurement Uncertainty for Spectrum Measurement

Measurement uncertainty	±2.81 dB
-------------------------	----------

Traceability

Method	Test Equipment Used
Measurements were made per work instruction WI-03 'Measurement of RF Spectrum Mask'	0158, 0287, 0252, 0313, 0314, 0070, 0116, 0117

This test report may be reproduced in full only. The document may only be updated by MiCOM Labs personnel. Any changes will be noted in the Document History section of the report.

5.1.2. Transmit Output Power

FCC, Part 15 Subpart C §15.407(a)
Industry Canada RSS-210 §9.9(2)
Industry Canada RSS-Gen 4.6

Test Procedure

The transmitter terminal of EUT was connected to the input of an average power meter. Measurements were made while EUT was operating in a continuous transmission mode i.e. 100 % duty cycle at the appropriate center frequency. All cable losses and offsets were taken into consideration in the measured result.

Test Measurement Set up

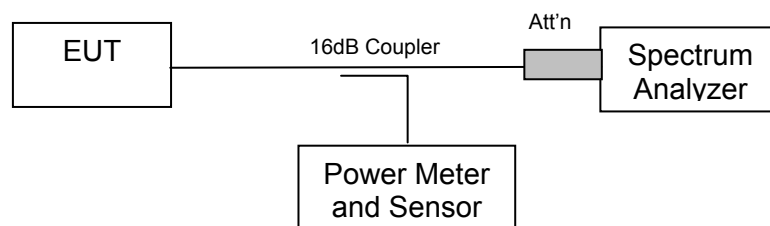

Measurement set up for Transmitter Output Power



Maximum Transmit (Conducted) Power, FCC Limits and Industry Canada Limits

Bands 5150 – 5250 MHz

FCC Limits

Conducted Power Limit lesser of: 50 mW or 4 dBm + 10 log (B) dBm where B is the 26dB bandwidth.

Mode	Frequency Range (MHz)	Maximum 26 dB Bandwidth (MHz)	4 + 10 Log (B) (dBm)	Limit (dBm)
a	5150 – 5250	23.046	+17.62	+17.00

FCC Limits Bands 5250 – 5350 and 5470 – 5725 MHz

Limit lesser of: 250 mW or 11 dBm + 10 log (B) dBm. B is the 26 dB emission bandwidth in MHz.

Mode	Frequency Range (MHz)	Maximum 26 dB Bandwidth (MHz)	11 + 10 Log (B) (dBm)	Limit (dBm)
a	5250 – 5350	23.146	23.64	+24.00

Mode	Frequency Range (MHz)	Maximum 26 dB Bandwidth (MHz)	11 + 10 Log (B) (dBm)	Limit (dBm)
a	5470 – 5725	23.948	23.79	+24.00



Title: SP-4700-A
To: FCC 47 CFR Part 15.407 & IC RSS-210
Serial #: TRIL05-U4b Rev A
Issue Date: 23rd May 2012
Page: 33 of 122

Industry Canada Limits

EIRP Limit 5150 – 5250 MHz: Lesser of 200 mW or $10 + 10 \log(B)$ dBm where B is the 99% bandwidth.

Mode	Frequency Range (MHz)	Maximum 99% Bandwidth (MHz)	$10 + 10 \log(B)$ (dBm)	EIRP Limit (dBm)
a	5150 – 5250	16.733	+22.23	+22.23

Industry Canada Limits

Bands 5250 – 5350 and 5470 – 5600 MHz and 5650 - 5725 MHz

Limit lesser of: 250 mW or $11 \text{ dBm} + 10 \log(B)$ dBm. B is the 99% emission bandwidth in MHz.

Mode	Frequency Range (MHz)	Maximum 26 dB Bandwidth (MHz)	$11 + 10 \log(B)$ (dBm)	Limit (dBm)
a	5250 – 5350	16.834	+23.26	+23.26

Mode	Frequency Range (MHz)	Maximum 26 dB Bandwidth (MHz)	$11 + 10 \log(B)$ (dBm)	Limit (dBm)
a	5470 – 5725	16.733	+23.23	+23.23

This test report may be reproduced in full only. The document may only be updated by MiCOM Labs personnel. Any changes will be noted in the Document History section of the report.



15. 407 a) Power limits:

- (1) **For the band 5.15–5.25 GHz**, the maximum conducted output power over the frequency band of operation shall not exceed the lesser of 50 mW or 4 dBm + 10 log B, where B is the 26–dB emission bandwidth in MHz. In addition, the peak power spectral density shall not exceed 4 dBm in any 1–MHz band. If transmitting antennas of directional gain greater than 6 dBi are used, both the maximum conducted output power and the peak power spectral density shall be reduced by the amount in dB that the directional gain of the antenna exceeds 6 dBi.

Operating Frequency Band 5150-5250 MHz

Antenna	Gain (dBi)	Max. Allowable Conducted Peak Power (dBm)	Maximum EIRP (dBm)
Integral Panel	17.0	+6.0	+23.0

- (2) **For the 5.25–5.35 GHz and 5.47–5.725 GHz bands**, the maximum conducted output power over the frequency bands of operation shall not exceed the lesser of 250 mW or 11 dBm + 10 log B, where B is the 26 dB emission bandwidth in megahertz. In addition, the peak power spectral density shall not exceed 11 dBm in any 1 megahertz band. If transmitting antennas of directional gain greater than 6 dBi are used, both the maximum conducted output power and the peak power spectral density shall be reduced by the amount in dB that the directional gain of the antenna exceeds 6 dBi.

Operating Frequency Bands 5250-5350 MHz and 5470 -5725 MHz

Frequency Band (MHz)	Antenna	Gain (dBi)	Max. Allowable Conducted Peak Power (dBm)	Maximum EIRP (dBm)
5250 – 5350	Integral Panel	17.0	+13.0	+30.0
5470 - 5725	Integral Panel	18.5	+11.5	+30.0

Measurement Results for Transmit Output Power

Ambient conditions.

Temperature: 17 to 23 °C Relative humidity: 31 to 57 % Pressure: 999 to 1012 mbar

EUT parameters.

Power Level: Maximum

Duty Cycle: 100%

Temperature: Ambient

This test report may be reproduced in full only. The document may only be updated by MiCOM Labs personnel. Any changes will be noted in the Document History section of the report.



Title: SP-4700-A
To: FCC 47 CFR Part 15.407 & IC RSS-210
Serial #: TRIL05-U4b Rev A
Issue Date: 23rd May 2012
Page: 35 of 122

TABLE OF RESULTS – 802.11a Legacy

Test Conditions:	15.407 (a)(1)	Rel. Humidity (%):	35	to	42
Variant:	802.11a	Ambient Temp. (°C):	19	to	22
TPC:	HIGH	Pressure (mBars):	998	to	1003
Modulation:	ON	Duty Cycle (x):	100		
Beam Forming Gain (Y):	N/A dB	Antenna Gain:	17		dBi
Applied Voltage:	48.0 Vdc				
Notes 1:					
Notes 2:					

Test Frequency	Measured Peak Power				Total Power (dBm)		Limit	Margin
	RF Port (dBm)				Combined	Calculated		
MHz	a	b	c	d				
5180	4.52	--	--	--	N/A	N/A	17.00	-12.48
5200	4.14	--	--	--	N/A	N/A	17.00	-12.86
5240	4.37	--	--	--	N/A	N/A	17.00	-12.63

Measurement uncertainty:	±1.33 dB
---------------------------------	----------

Test Conditions:	15.407 (a)(1)	Rel. Humidity (%):	35	to	42
Variant:	802.11a	Ambient Temp. (°C):	19	to	22
TPC:	HIGH	Pressure (mBars):	998	to	1003
Modulation:	ON	Duty Cycle (x):	100		
Beam Forming Gain (Y):	N/A dB	Antenna Gain:	17		dBi
Applied Voltage:	48.0 Vdc				
Notes 1:					
Notes 2:					

Test Frequency	Measured Peak Power				Total Power (dBm)		Limit	Margin
	RF Port (dBm)				Combined	Calculated		
MHz	a	b	c	d				
5260	12.27	--	--	--	N/A	N/A	24.00	-11.73
5300	11.14	--	--	--	N/A	N/A	24.00	-12.86
5320	11.38	--	--	--	N/A	N/A	24.00	-12.62

Measurement uncertainty:	±1.33 dB
---------------------------------	----------

The power measured at 5320 MHz is as a result of retesting at this frequency at a higher power setting of 18. (5260 and 5300 MHz were tested at power setting of 16.)

This test report may be reproduced in full only. The document may only be updated by MiCOM Labs personnel. Any changes will be noted in the Document History section of the report.



Title: SP-4700-A
To: FCC 47 CFR Part 15.407 & IC RSS-210
Serial #: TRIL05-U4b Rev A
Issue Date: 23rd May 2012
Page: 36 of 122

Test Conditions:	15.407 (a)(1)	Rel. Humidity (%):	35	to	42
Variant:	802.11a	Ambient Temp. (°C):	19	to	22
TPC:	HIGH	Pressure (mBars):	998	to	1003
Modulation:	ON	Duty Cycle (x):	100		
Beam Forming Gain (Y):	N/A dB	Antenna Gain:	18.5 dBi		
Applied Voltage:	48.0 Vdc				
Notes 1:					
Notes 2:					

Test Frequency	Measured Peak Power				Total Power (dBm)		Limit	Margin
	RF Port (dBm)				Combined	Calculated		
MHz	a	b	c	d			dBm	dB
5500	11.03	--	--	--	N/A	N/A	30.00	-18.97
5580	11.30	--	--	--	N/A	N/A	30.00	-18.70
5700	11.03	--	--	--	N/A	N/A	30.00	-18.97

Measurement uncertainty:	±1.33 dB
---------------------------------	----------

This test report may be reproduced in full only. The document may only be updated by MiCOM Labs personnel. Any changes will be noted in the Document History section of the report.



Specification

Limits

FCC, Part 15 §15.407 (a)(1), (a)(2) and Industry Canada RSS-210 § A9.2(2)

(a)(1) For the band 5.15-5.25 GHz the maximum conducted output power over the frequency band of operation shall not exceed the lesser of 50 mW or $+4 \text{ dBm} + 10 \log B$, where B is the 26 dB emission bandwidth in megahertz. In addition, the peak power spectral density shall not exceed +4 dBm in any 1 megahertz band.

(a)(2) For the 5.25-5.35 and 5470-5725 MHz GHz band the maximum conducted output power over the frequency band of operation shall not exceed the lesser of 250 mW or $+11 \text{ dBm} + 10 \log B$, where B is the 26 dB emission bandwidth in megahertz. In addition, the peak power spectral density shall not exceed +11 dBm in any 1 megahertz band.

Industry Canada RSS-210 §A9.2(2)

For the band 5150-5250 MHz, the maximum equivalent isotropically radiated power (e.i.r.p.) shall not exceed 200 mW or $10 + 10 \log_{10} B$, dBm, whichever power is less. B is the 99% emission bandwidth in MHz. The e.i.r.p. spectral density shall not exceed 10 dBm in any 1.0 MHz band.

For the band 5250-5350 MHz and 5470-5725 MHz, the maximum conducted output power shall not exceed 250 mW or $11 + 10 \log_{10} B$, dBm, whichever power is less. The power spectral density shall not exceed 11 dBm in any 1.0 MHz band. The maximum e.i.r.p. shall not exceed 1.0 W or $17 + 10 \log_{10} B$, dBm, whichever power is less. B is the 99% emission bandwidth in MHz.

Industry Canada RSS-Gen 4.4

When an occupied bandwidth value is not specified in the applicable RSS, the transmitted signal bandwidth to be reported is to be its 99% emission bandwidth, as calculated or measured.

Laboratory Measurement Uncertainty for Power Measurements

Measurement uncertainty	$\pm 1.33 \text{ dB}$
-------------------------	-----------------------

Traceability

Method	Test Equipment Used
Measurements were made per work instruction WI-01 'Measuring RF Output Power'	0158, 0287, 0252, 0313, 0314, 0070, 0116, 0117

This test report may be reproduced in full only. The document may only be updated by MiCOM Labs personnel. Any changes will be noted in the Document History section of the report.

5.1.3. Peak Power Spectral Density

FCC, Part 15 Subpart C §15.407(a)
Industry Canada RSS-210 § A9.2(2)

Test Procedure

The transmitter output was connected to a spectrum analyzer and the peak power spectral density measured. Method 2 Sample Detection and power averaging, specified in FCC document DA 02-2138 (Normative Reference (ix) Section 2.1 “Guidelines for Assessing Unlicensed National Information Infrastructure (U-NII) Devices”) was used to determine the peak power spectral density of the emission. The Peak Power Spectral Density is the highest level found across the emission in a 1 MHz resolution bandwidth.

Test Measurement Set up

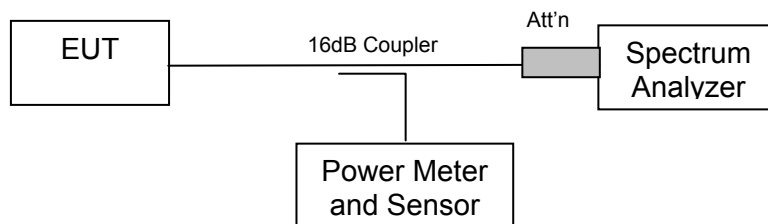

Measurement set up for Peak Power Spectral Density

Measurement Results for Peak Power Spectral Density

Ambient conditions.

Temperature: 17 to 23 °C Relative humidity: 31 to 57 % Pressure: 999 to 1012 mbar

Radio Parameters

Duty Cycle: 100%

Output: Modulated Carrier

Power: Maximum Default Power



Title: SP-4700-A
To: FCC 47 CFR Part 15.407 & IC RSS-210
Serial #: TRIL05-U4b Rev A
Issue Date: 23rd May 2012
Page: 39 of 122

TABLE OF RESULTS – 802.11a Legacy 5150 – 5250 MHz

Test Conditions:	15.407 (a)	Rel. Humidity (%):	35 to 42
Variant:	802.11a	Ambient Temp. (°C):	19 to 22
TPC:	HIGH	Pressure (mBars):	998 to 1003
Modulation:	ON	Duty Cycle (%):	100
Beam Forming Gain (Y):	N/A dB	Antenna Gain:	17 dBi
Applied Voltage:	48.0 Vdc	Antenna Ports (N):	1
Notes 1:			
Notes 2:			

Test Frequency	Measured Peak Power				Correction factor	Peak Power Spectral Density	Limit	Margin
	RF Port (dBm)							
MHz	a	b	c	d	10Log(N)	dBm	dBm	dB
5180	-8.23	--	--	--	0.00	-8.23	4.00	-12.23
5200	-8.61	--	--	--	0.00	-8.61	4.00	-12.61
5240	-8.21	--	--	--	0.00	-8.21	4.00	-12.21

Measurement uncertainty:	±1.33 dB
---------------------------------	----------

This test report may be reproduced in full only. The document may only be updated by MiCOM Labs personnel. Any changes will be noted in the Document History section of the report.



Title: SP-4700-A
To: FCC 47 CFR Part 15.407 & IC RSS-210
Serial #: TRIL05-U4b Rev A
Issue Date: 23rd May 2012
Page: 41 of 122

PORT A 5,240 MHz 802.11a Legacy Power Spectral Density

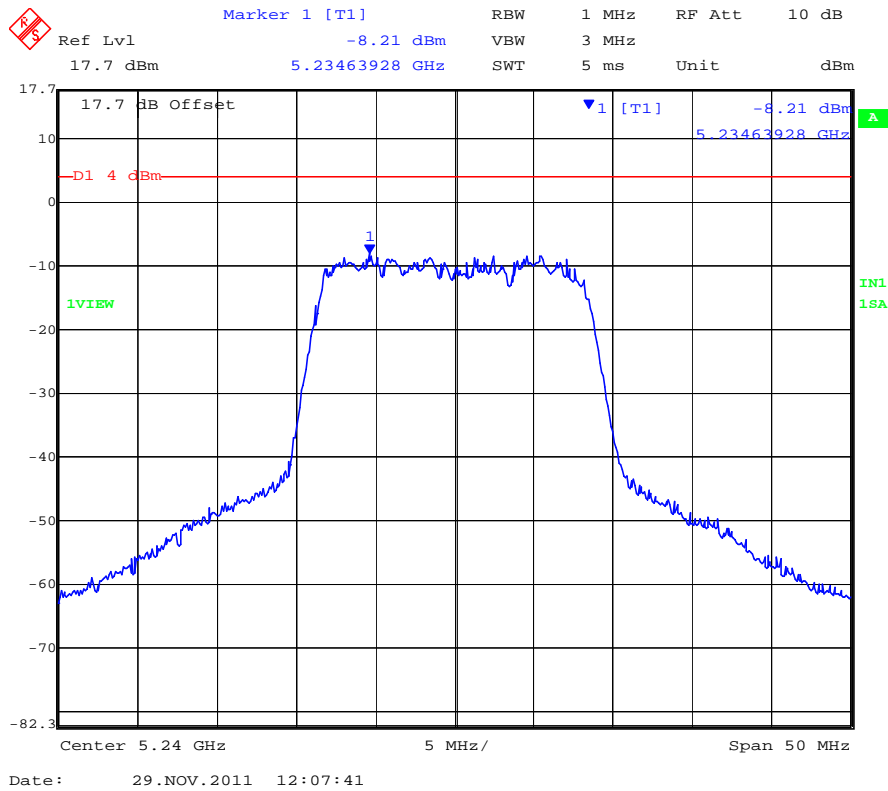

This test report may be reproduced in full only. The document may only be updated by MiCOM Labs personnel. Any changes will be noted in the Document History section of the report.



Title: SP-4700-A
To: FCC 47 CFR Part 15.407 & IC RSS-210
Serial #: TRIL05-U4b Rev A
Issue Date: 23rd May 2012
Page: 42 of 122

TABLE OF RESULTS – 802.11a Legacy 5250 -5350 MHz

Test Conditions:	15.407 (a)	Rel. Humidity (%):	35	to	42
Variant:	802.11a	Ambient Temp. (°C):	19	to	22
TPC:	HIGH	Pressure (mBars):	998	to	1003
Modulation:	ON	Duty Cycle (%):	100		
Beam Forming Gain (Y):	N/A dB	Antenna Gain:	17 dBi		
Applied Voltage:	48.0 Vdc	Antenna Ports (N):	1		
Notes 1:					
Notes 2:					

Test Frequency	Measured Peak Power				Correction factor	Peak Power Spectral Density	Limit	Margin
	RF Port (dBm)							
MHz	a	b	c	d	10Log(N)	dBm	dBm	dB
5260	-0.31	--	--	--	0.00	-0.31	11.00	-11.31
5300	-2.31	--	--	--	0.00	-2.31	11.00	-13.31
5320	-1.87	--	--	--	0.00	-1.87	11.00	-12.87

Measurement uncertainty:	±1.33 dB
---------------------------------	----------

This test report may be reproduced in full only. The document may only be updated by MiCOM Labs personnel. Any changes will be noted in the Document History section of the report.



PORT A 5,260 MHz 802.11a Legacy Power Spectral Density

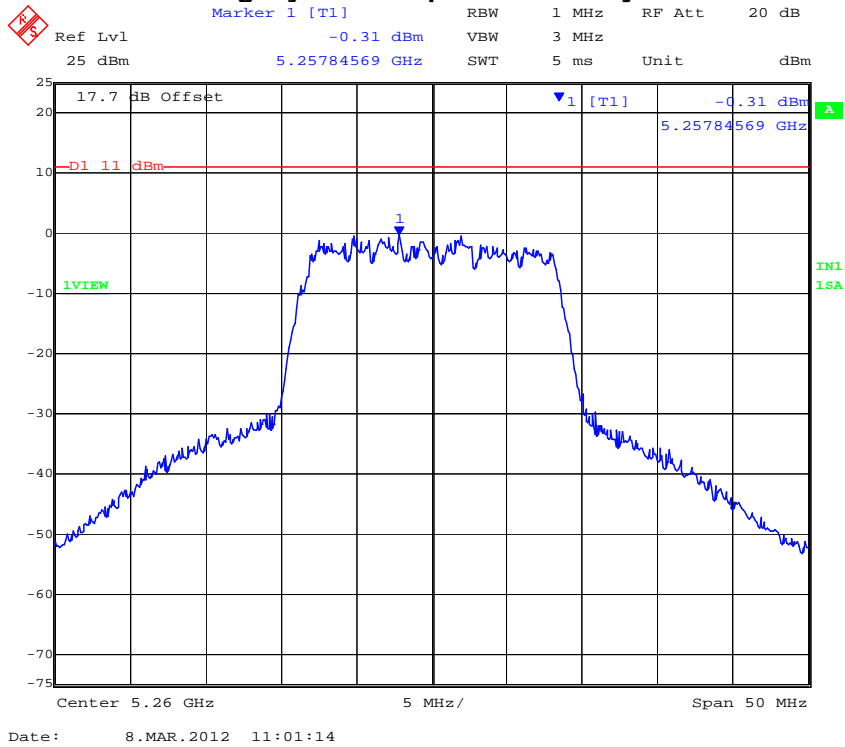

PORT A 5300 MHz 802.11a Legacy Power Spectral Density

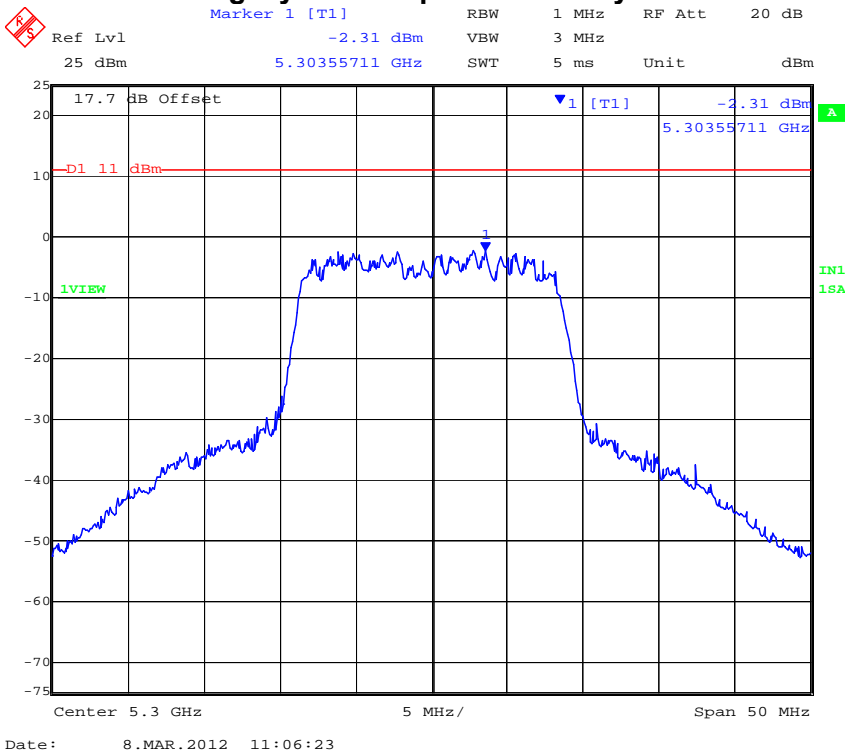

This test report may be reproduced in full only. The document may only be updated by MiCOM Labs personnel. Any changes will be noted in the Document History section of the report.



Title: SP-4700-A
To: FCC 47 CFR Part 15.407 & IC RSS-210
Serial #: TRIL05-U4b Rev A
Issue Date: 23rd May 2012
Page: 44 of 122

PORT A 5,320 MHz 802.11a Legacy Power Spectral Density

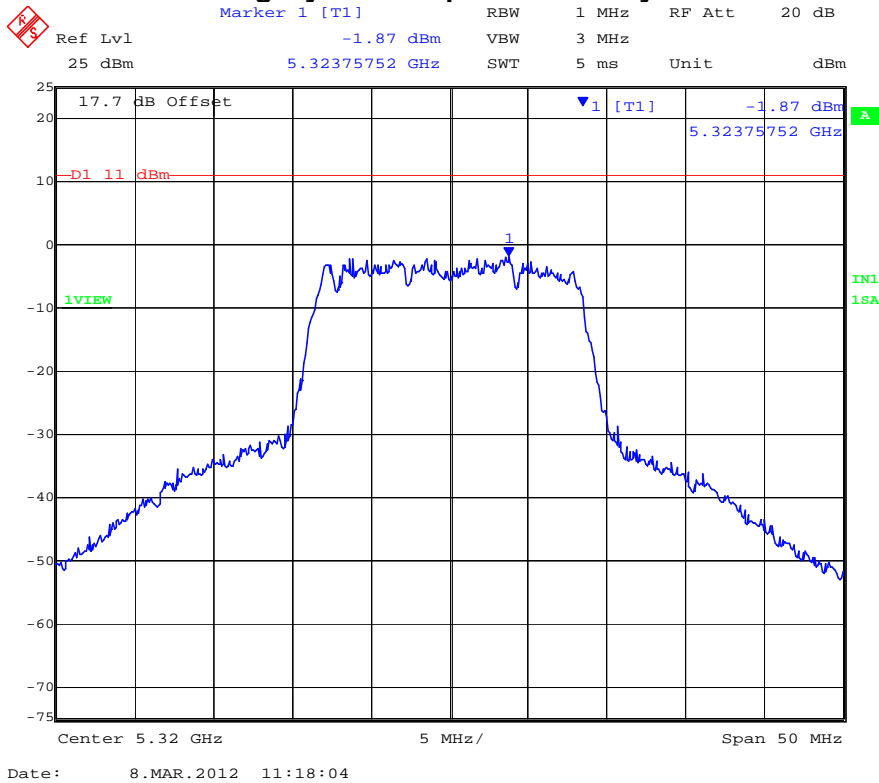

This test report may be reproduced in full only. The document may only be updated by MiCOM Labs personnel. Any changes will be noted in the Document History section of the report.



Title: SP-4700-A
To: FCC 47 CFR Part 15.407 & IC RSS-210
Serial #: TRIL05-U4b Rev A
Issue Date: 23rd May 2012
Page: 45 of 122

TABLE OF RESULTS – 802.11a Legacy 5470 - 5725 MHz

Test Conditions:	15.407 (a)	Rel. Humidity (%):	35	to	42
Variant:	802.11a	Ambient Temp. (°C):	19	to	22
TPC:	HIGH	Pressure (mBars):	998	to	1003
Modulation:	ON	Duty Cycle (%):	100		
Beam Forming Gain (Y):	N/A dB	Antenna Gain:	18.5 dBi		
Applied Voltage:	48.0 Vdc	Antenna Ports (N):	1		
Notes 1:					
Notes 2:					

Test Frequency	Measured Peak Power				Correction factor	Peak Power Spectral Density	Limit	Margin
	RF Port (dBm)							
MHz	a	b	c	d	10Log(N)	dBm	dBm	dB
5500	-0.17	--	--	--	0.00	-0.17	11.00	-11.17
5580	-0.70	--	--	--	0.00	-0.70	11.00	-11.70
5700	-2.34	--	--	--	0.00	-2.34	11.00	-13.34

Measurement uncertainty:	±1.33 dB
---------------------------------	----------

This test report may be reproduced in full only. The document may only be updated by MiCOM Labs personnel. Any changes will be noted in the Document History section of the report.



Title: SP-4700-A
To: FCC 47 CFR Part 15.407 & IC RSS-210
Serial #: TRIL05-U4b Rev A
Issue Date: 23rd May 2012
Page: 46 of 122

PORT A 5,500 MHz 802.11a Legacy Power Spectral Density

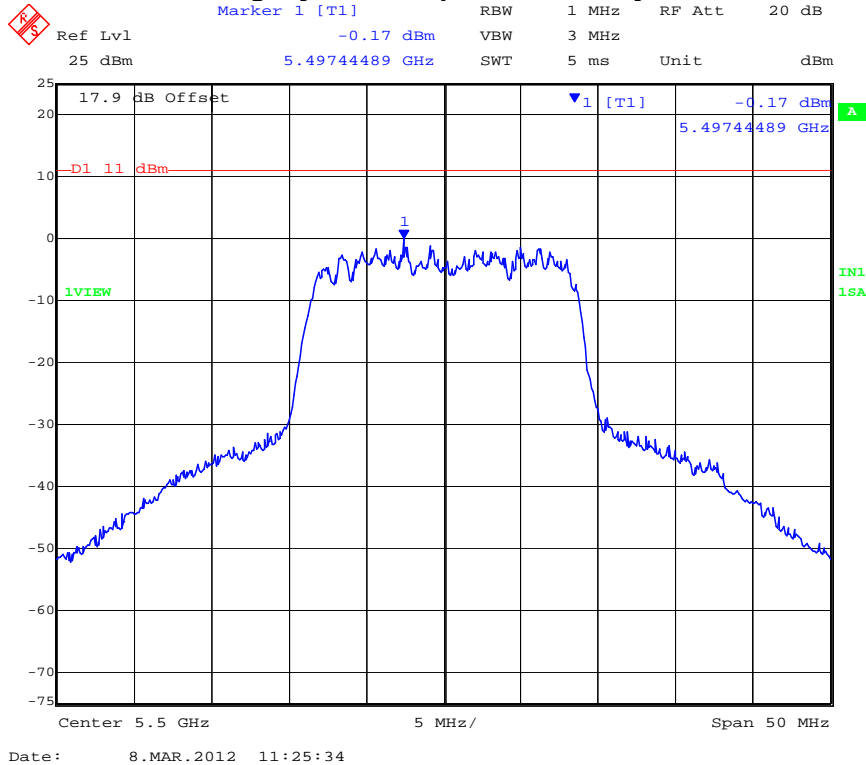

PORT A 5,580 MHz 802.11a Legacy Power Spectral Density

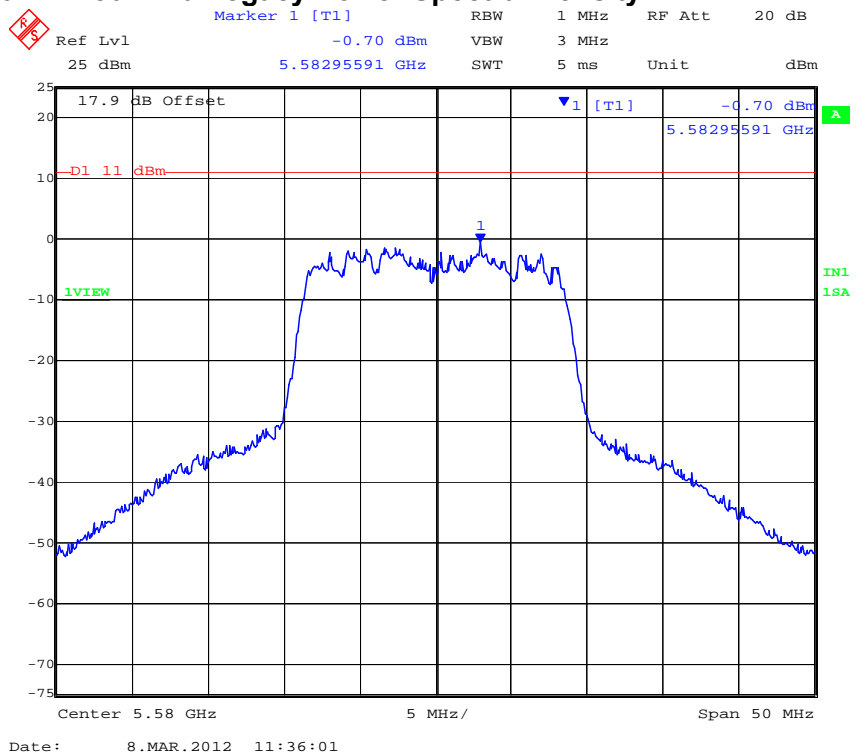

This test report may be reproduced in full only. The document may only be updated by MiCOM Labs personnel. Any changes will be noted in the Document History section of the report.



Title: SP-4700-A
To: FCC 47 CFR Part 15.407 & IC RSS-210
Serial #: TRIL05-U4b Rev A
Issue Date: 23rd May 2012
Page: 47 of 122

PORT A 5,700 MHz 802.11a Legacy Power Spectral Density

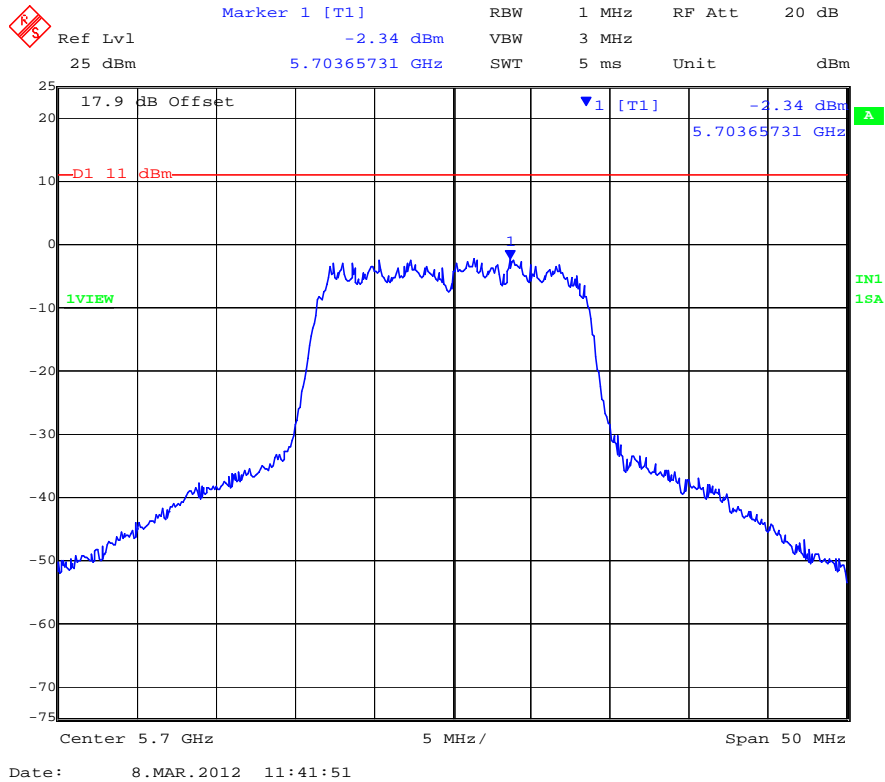

This test report may be reproduced in full only. The document may only be updated by MiCOM Labs personnel. Any changes will be noted in the Document History section of the report.



Title: SP-4700-A
To: FCC 47 CFR Part 15.407 & IC RSS-210
Serial #: TRIL05-U4b Rev A
Issue Date: 23rd May 2012
Page: 48 of 122

Specification

FCC, Part 15 §15.407 (a)(1), (a)(2)

5150 – 5250 MHz

(a)(1) The peak power spectral density shall not exceed +4 dBm in any 1 megahertz band.

5250 – 5350 MHz & 5470 – 5725 MHz

(a)(2) The peak power spectral density shall not exceed +11 dBm in any 1 megahertz band.

Industry Canada RSS-210 § A9.2(1), A9.2(2)

5150 – 5250 MHz

§ A9.2(1) The eirp spectral density shall not exceed +10 dBm in any 1 MHz band

5250 – 5350 MHz & 5470 – 5725 MHz

§ A9.2(2) The power spectral density shall not exceed +11 dBm in any 1 MHz band

Laboratory Measurement Uncertainty for Spectral Density

Measurement uncertainty	±1.33 dB
-------------------------	----------

Traceability

Method	Test Equipment Used
Measurements were made per work instruction WI-01 'Measuring RF Output Power'	0158, 0287, 0252, 0313, 0314, 0070, 0116, 0117

This test report may be reproduced in full only. The document may only be updated by MiCOM Labs personnel. Any changes will be noted in the Document History section of the report.

5.1.4. Peak Excursion Ratio

FCC, Part 15 Subpart C §15.407(a)(6)

Test Procedure

Normative Reference (xi) Section 2.1 Measurement Procedure DA 02-2138 “Measurement Procedure Updated for Peak Transmit Power in the UNII Bands” was implemented to determine the Peak Excursion Ratio. This is a conducted measurement using a spectrum analyzer. The Peak Excursion Ratio is the difference in amplitude (dB) between the two traces.

Test Measurement Set up

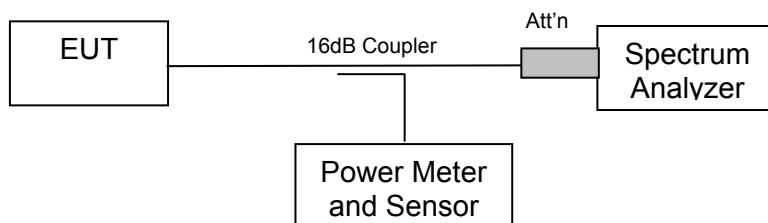

Measurement set up for Peak Excursion Ratio

Measurement Results for Peak Excursion Ratio

Ambient conditions.

Temperature: 17 to 23 °C Relative humidity: 31 to 57% Pressure: 999 to 1012 mbar

Radio Parameters

Duty Cycle: 100%

Output: Modulated Carrier

Power: Maximum Default Power



Title: SP-4700-A
To: FCC 47 CFR Part 15.407 & IC RSS-210
Serial #: TRIL05-U4b Rev A
Issue Date: 23rd May 2012
Page: 50 of 122

TABLE OF RESULTS – 802.11a Legacy 5150 – 5250 MHz

Test Conditions:	15.407 (a)	Rel. Humidity (%):	35	to	42
Variant:	802.11a	Ambient Temp. (°C):	19	to	22
TPC:	HIGH	Pressure (mBars):	998	to	1003
Modulation:	ON	Duty Cycle (%):	100		
Beam Forming Gain (Y):	N/A dB	Antenna Gain:	17 dBi		
Applied Voltage:	48.0 Vdc				
Notes 1:					
Notes 2:					

Test Frequency	Trace Δ Marker				Limit	Margin
	Port A	Port B	Port C	Port D		
MHz	dB	dB	dB	dB	dB	dB
5180	-11.33	--	--	--	-13.00	-1.67
5200	-10.23	--	--	--		-2.77
5240	-9.93	--	--	--		-3.08

Measurement uncertainty:	±1.33 dB
---------------------------------	----------

This test report may be reproduced in full only. The document may only be updated by MiCOM Labs personnel. Any changes will be noted in the Document History section of the report.



PORT A 5,180 MHz 802.11a Legacy Peak Excursion Ratio

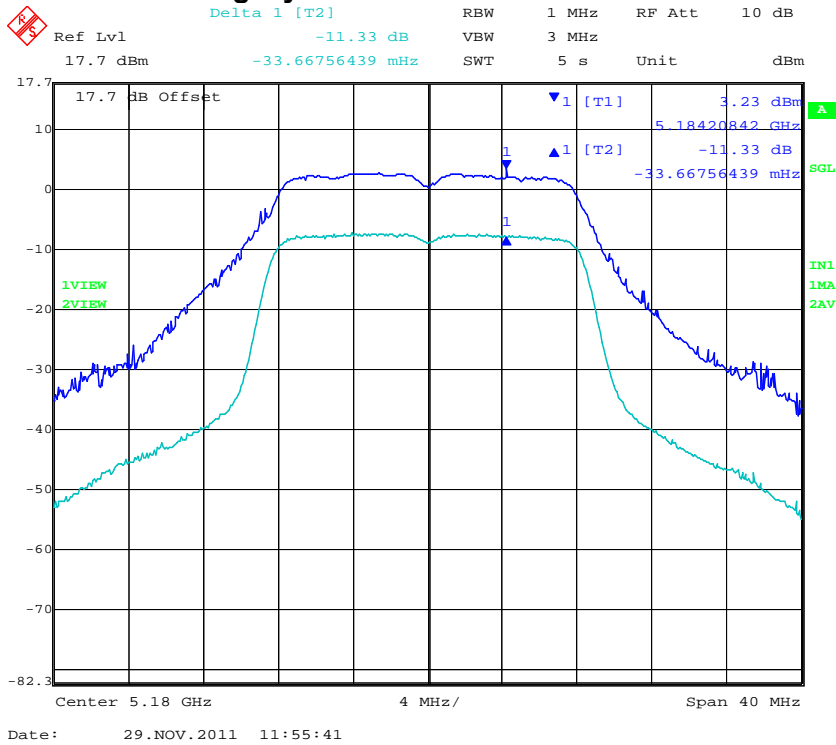

PORT A 5,200 MHz 802.11a Legacy Peak Excursion Ratio

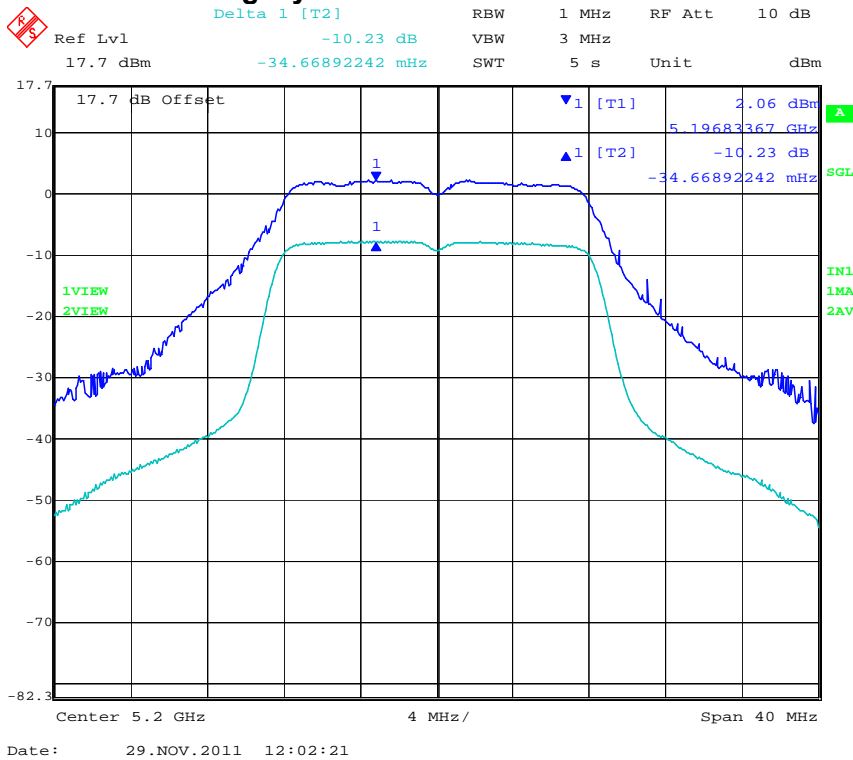

This test report may be reproduced in full only. The document may only be updated by MiCOM Labs personnel. Any changes will be noted in the Document History section of the report.



Title: SP-4700-A
To: FCC 47 CFR Part 15.407 & IC RSS-210
Serial #: TRIL05-U4b Rev A
Issue Date: 23rd May 2012
Page: 52 of 122

PORT A 5,240 MHz 802.11a Legacy Peak Excursion Ratio

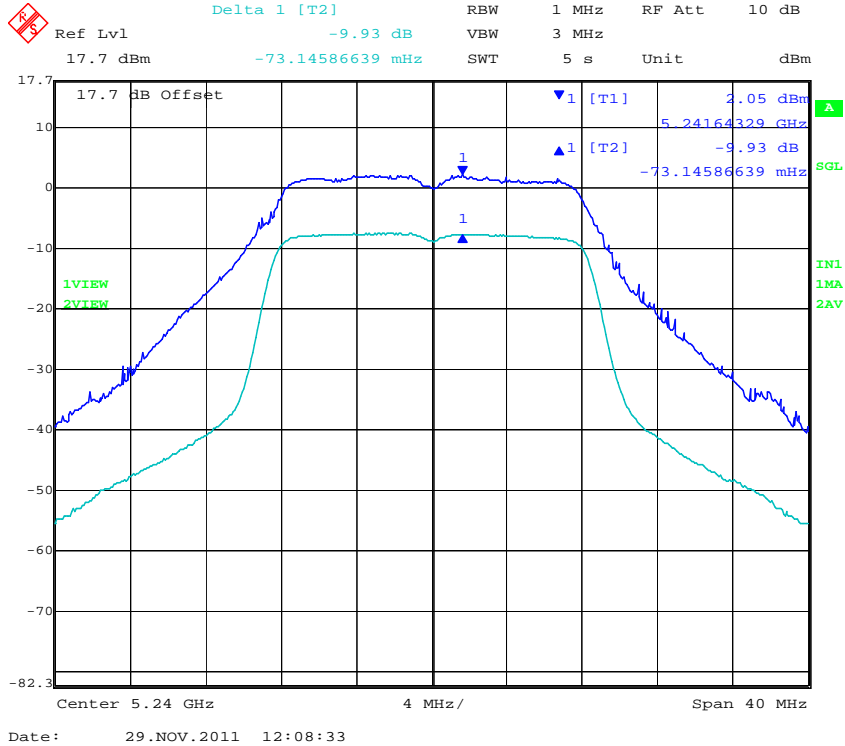

This test report may be reproduced in full only. The document may only be updated by MiCOM Labs personnel. Any changes will be noted in the Document History section of the report.



Title: SP-4700-A
To: FCC 47 CFR Part 15.407 & IC RSS-210
Serial #: TRIL05-U4b Rev A
Issue Date: 23rd May 2012
Page: 53 of 122

TABLE OF RESULTS – 802.11a Legacy 5250 -5350 MHz

Test Conditions:	15.407 (a)	Rel. Humidity (%):	35	to	42
Variant:	802.11a	Ambient Temp. (°C):	19	to	22
TPC:	HIGH	Pressure (mBars):	998	to	1003
Modulation:	ON	Duty Cycle (%):	100		
Beam Forming Gain (Y):	N/A dB	Antenna Gain:	17 dBi		
Applied Voltage:	48.0 Vdc				
Notes 1:					
Notes 2:					

Test Frequency	Trace Δ Marker				Limit	Margin
	Port A	Port B	Port C	Port D		
MHz	dB	dB	dB	dB	dB	dB
5260	-9.70	--	--	--	-13.00	-3.30
5300	-9.75	--	--	--		-3.25
5320	-10.33	--	--	--		-2.67

Measurement uncertainty:	±1.33 dB
---------------------------------	----------

This test report may be reproduced in full only. The document may only be updated by MiCOM Labs personnel. Any changes will be noted in the Document History section of the report.



Title: SP-4700-A
To: FCC 47 CFR Part 15.407 & IC RSS-210
Serial #: TRIL05-U4b Rev A
Issue Date: 23rd May 2012
Page: 54 of 122

PORT A 5,260 MHz 802.11a Legacy Peak Excursion Ratio

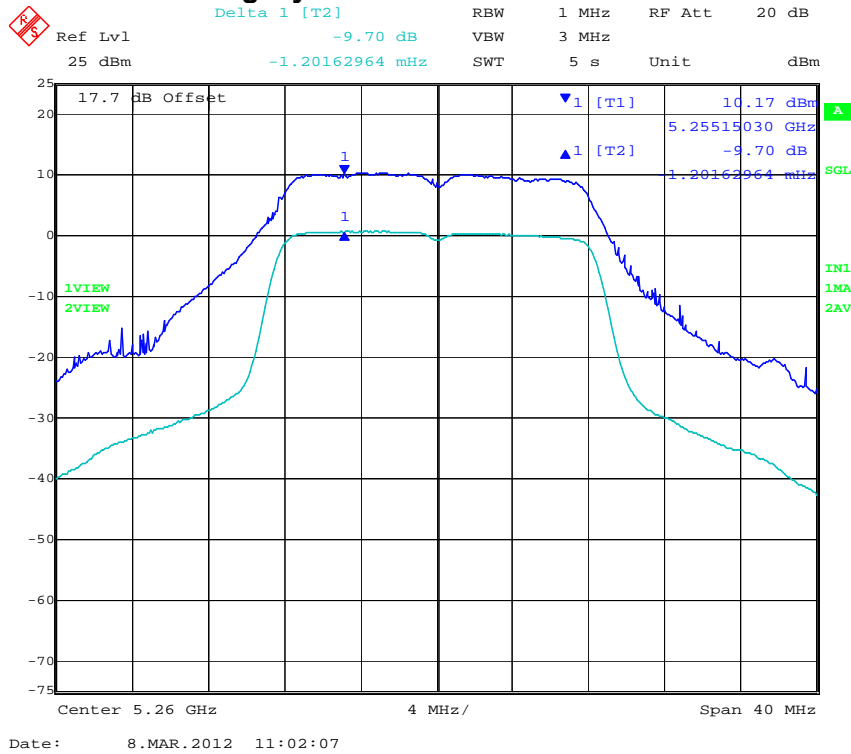

PORT A 5300 MHz 802.11a Legacy Peak Excursion Ratio

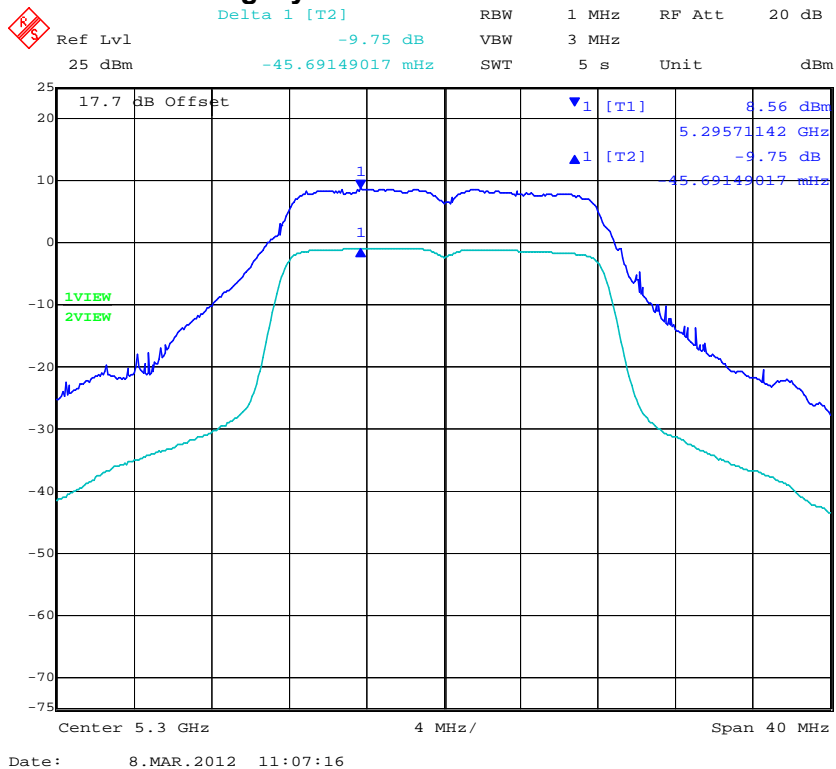

This test report may be reproduced in full only. The document may only be updated by MiCOM Labs personnel. Any changes will be noted in the Document History section of the report.



Title: SP-4700-A
To: FCC 47 CFR Part 15.407 & IC RSS-210
Serial #: TRIL05-U4b Rev A
Issue Date: 23rd May 2012
Page: 55 of 122

PORT A 5,320 MHz 802.11a Legacy Peak Excursion Ratio

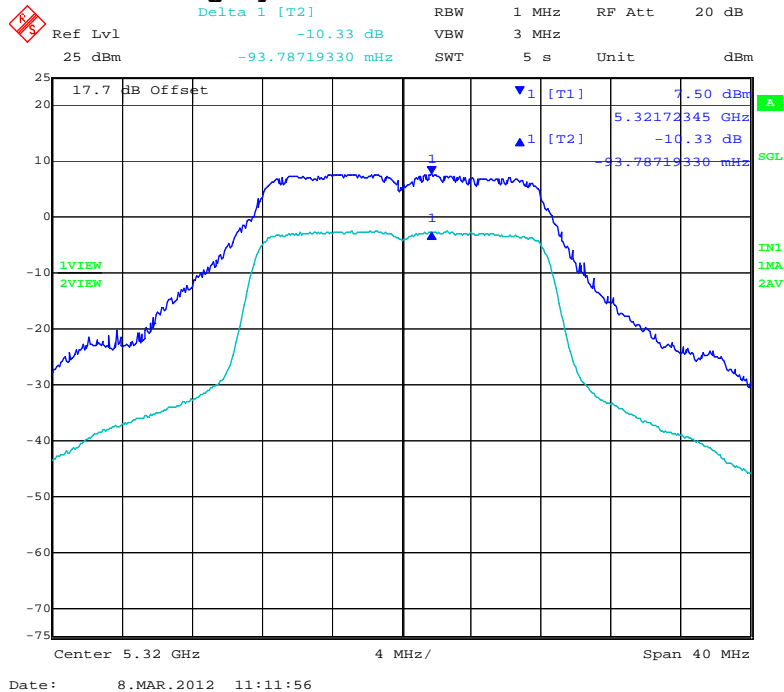

This test report may be reproduced in full only. The document may only be updated by MiCOM Labs personnel. Any changes will be noted in the Document History section of the report.



Title: SP-4700-A
To: FCC 47 CFR Part 15.407 & IC RSS-210
Serial #: TRIL05-U4b Rev A
Issue Date: 23rd May 2012
Page: 56 of 122

TABLE OF RESULTS – 802.11a Legacy 5470 - 5725 MHz

Test Conditions:	15.407 (a)	Rel. Humidity (%):	35	to	42
Variant:	802.11a	Ambient Temp. (°C):	19	to	22
TPC:	HIGH	Pressure (mBars):	998	to	1003
Modulation:	ON	Duty Cycle (%):	100		
Beam Forming Gain (Y):	N/A dB	Antenna Gain:	18.5 dBi		
Applied Voltage:	48.0 Vdc				
Notes 1:					
Notes 2:					

Test Frequency	Trace Δ Marker				Limit	Margin
	Port A	Port B	Port C	Port D		
MHz	dB	dB	dB	dB	dB	dB
5500	-10.08	--	--	--	-13.00	-2.92
5580	-10.17	--	--	--		-2.83
5700	-10.20	--	--	--		-2.80

Measurement uncertainty:	±1.33 dB
---------------------------------	----------

This test report may be reproduced in full only. The document may only be updated by MiCOM Labs personnel. Any changes will be noted in the Document History section of the report.



Title: SP-4700-A
To: FCC 47 CFR Part 15.407 & IC RSS-210
Serial #: TRIL05-U4b Rev A
Issue Date: 23rd May 2012
Page: 57 of 122

PORT A 5,500 MHz 802.11a Legacy Peak Excursion Ratio

Ref Lvl 25 dBm Delta 1 [T2] -10.08 dB RBW 1 MHz RF Att 20 dB
-24.04785156 mHz VBW 3 MHz SWT 5 s Unit dBm

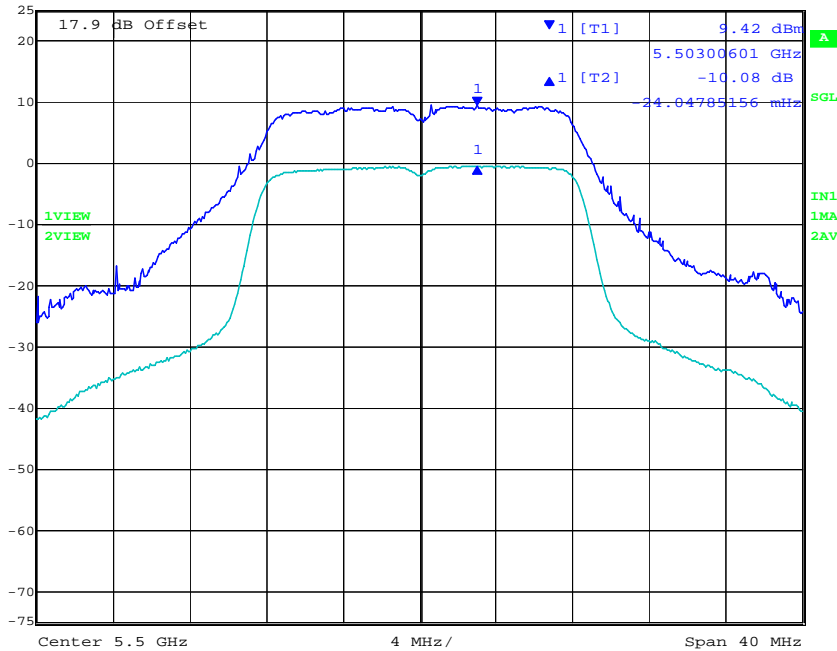

Date: 8.MAR.2012 11:26:28

PORT A 5,580 MHz 802.11a Legacy Peak Excursion Ratio

Ref Lvl 25 dBm Delta 1 [T2] -10.17 dB RBW 1 MHz RF Att 20 dB
-86.97414398 mHz VBW 3 MHz SWT 5 s Unit dBm

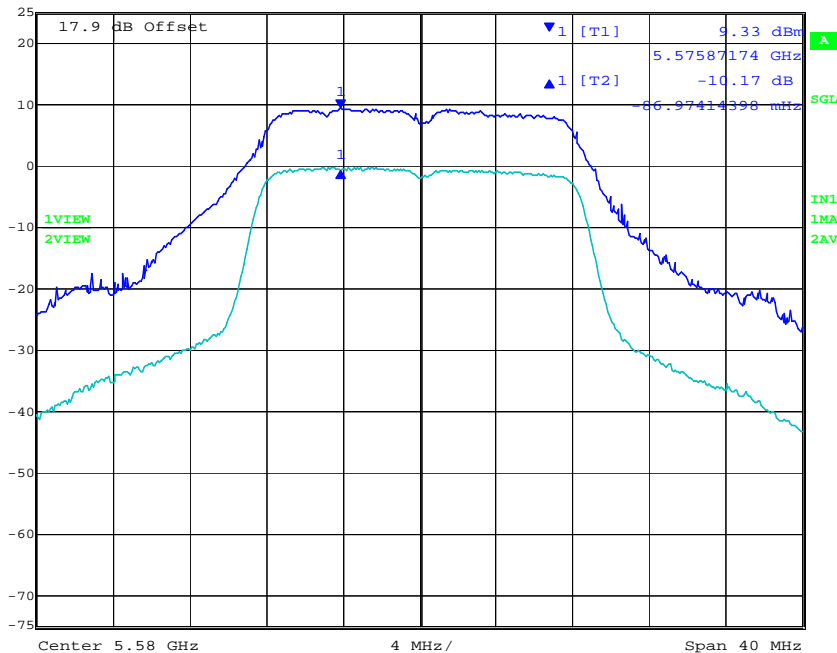

Date: 8.MAR.2012 11:36:54

This test report may be reproduced in full only. The document may only be updated by MiCOM Labs personnel. Any changes will be noted in the Document History section of the report.



Title: SP-4700-A
To: FCC 47 CFR Part 15.407 & IC RSS-210
Serial #: TRIL05-U4b Rev A
Issue Date: 23rd May 2012
Page: 58 of 122

PORT A 5,700 MHz 802.11a Legacy Peak Excursion Ratio

Ref Lvl 25 dBm
Delta 1 [T2] -10.20 dB
-30.46131134 mHz
RBW 1 MHz
RF Att 20 dB
VBW 3 MHz
SWT 5 s
Unit dBm

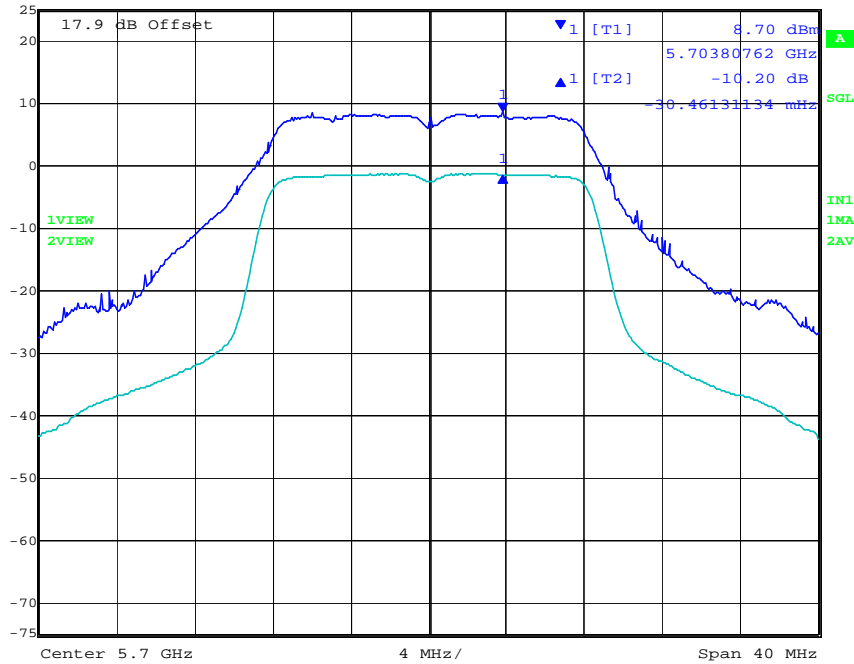

Date: 8.MAR.2012 11:42:45

This test report may be reproduced in full only. The document may only be updated by MiCOM Labs personnel. Any changes will be noted in the Document History section of the report.



Title: SP-4700-A
To: FCC 47 CFR Part 15.407 & IC RSS-210
Serial #: TRIL05-U4b Rev A
Issue Date: 23rd May 2012
Page: 59 of 122

Specification

Limits

§15.407 (a)(6) The ratio of the peak excursion of the modulation envelope (measured using a peak hold function) to the peak transmit power (measured as specified in this paragraph) shall not exceed 13dB across any 1MHz bandwidth or the emission bandwidth whichever is less

Laboratory Measurement Uncertainty for Spectrum Measurement

Measurement uncertainty	$\pm 2.81\text{dB}$
-------------------------	---------------------

Traceability

Method	Test Equipment Used
Measurements were made per work instruction WI-03 'Measurement of RF Spectrum Mask'	0158, 0287, 0252, 0313, 0314, 0070, 0116, 0117

This test report may be reproduced in full only. The document may only be updated by MiCOM Labs personnel. Any changes will be noted in the Document History section of the report.



Title: SP-4700-A
To: FCC 47 CFR Part 15.407 & IC RSS-210
Serial #: TRIL05-U4b Rev A
Issue Date: 23rd May 2012
Page: 60 of 122

5.1.5. Frequency Stability

FCC, Part 15 Subpart C §15.407(g)
Industry Canada RSS-210 §2.1

Test Procedure

The manufacturer of the equipment is responsible for ensuring that the frequency stability is such that emissions are always maintained within the band of operation under all conditions.

Manufacturer Declaration

The frequency stability of the reference oscillator sets the frequency stability of the RF transceiver signals. Therefore all of the RF signals should have ± 20 ppm stability.

This stability accounts for room temp tolerance of the crystal oscillator circuit, frequency variation across temperature, and crystal ageing.

± 20 ppm at 5.250 GHz translates to a maximum frequency shift of ± 105 KHz. As the edge of the channels is at least one MHz from either of the band edges, ± 105 KHz is more than sufficient to guarantee that the intentional emission will remain in the band over the entire operating range of the EUT.

Specification

Limits

§15.407 (g) Manufacturers of U-NII devices are responsible for ensuring frequency stability such that an emission is maintained within the band of operation under all conditions of normal operation as specified in the user's manual.

This test report may be reproduced in full only. The document may only be updated by MiCOM Labs personnel. Any changes will be noted in the Document History section of the report.



5.1.6. Maximum Permissible Exposure

FCC, Part 15 Subpart C §15.407(f)

Industry Canada RSS-Gen §5.5

Calculations for Maximum Permissible Exposure Levels

$$\text{Power Density} = P_d \text{ (mW/cm}^2\text{)} = \text{EIRP}/(4\pi d^2)$$

$$\text{EIRP} = P * G$$

P = Peak output power (mW)

G = Antenna numeric gain (numeric)

d = Separation distance (cm)

$$\text{Numeric Gain} = 10^{(G \text{ (dBi)}/10)}$$

The Trilliant CONNECTOR has a single transmitter.

Because the EUT belongs to the General Population/Uncontrolled Exposure the limit of power density is 1.0 mW/cm²

Freq. Band (MHz)	Antenna Gain (dBi)	Numeric Gain (numeric)	Peak Output Power (dBm)	Peak Output Power (mW)	Calculated Safe Distance @ 1mW/cm ² Limit(cm)	Minimum Separation Distance (cm)
5150 - 5250	17.0	50.1	+4.52	2.83	3.36	20.00
5250 - 5350	17.0	50.1	+12.27	16.87	8.20	20.00
5470 - 5725	18.5	70.8	+11.30	13.49	8.72	20.00

Note: for mobile or fixed location transmitters the minimum separation distance is 20cm, even if calculations indicate the MPE distance to be less.

Specification

Maximum Permissible Exposure Limits

FCC §1.1310 Limit = 1mW / cm² from 1.310 Table 1

RSS-Gen §5.5 Before equipment certification is granted, the application requirements of RSS-102 shall be met.

Laboratory Measurement Uncertainty for Power Measurements

Measurement uncertainty

±1.33 dB



Title: SP-4700-A
To: FCC 47 CFR Part 15.407 & IC RSS-210
Serial #: TRIL05-U4b Rev A
Issue Date: 23rd May 2012
Page: 62 of 122

5.1.7. Radiated Emissions

FCC, Part 15 Subpart C §15.407(b)(2), §15.205(a)/15.209(a)
Industry Canada RSS-210 §A9.3(2); §2.2; §2.6; RSS-Gen §4.7

Test Procedure

Testing was performed in a 3-meter anechoic chamber. Preliminary radiated emissions were measured on every azimuth and with the receiving antenna in both horizontal and vertical polarizations. Preliminary emissions were recorded with in Spectrum Analyzer mode, using a maximum peak detector while in peak hold mode. Depending on the frequency band spanned a notch filter and/or waveguide filter was used to remove the fundamental frequency.

All measurements on any frequency or frequencies over 1 MHz are based on the use of measurement instrumentation employing an average detector function. All measurements above 1 GHz were performed using a minimum resolution bandwidth of 1 MHz.

This test report may be reproduced in full only. The document may only be updated by MiCOM Labs personnel. Any changes will be noted in the Document History section of the report.

Radiated Emission Measurement Setup – Above 1 GHz

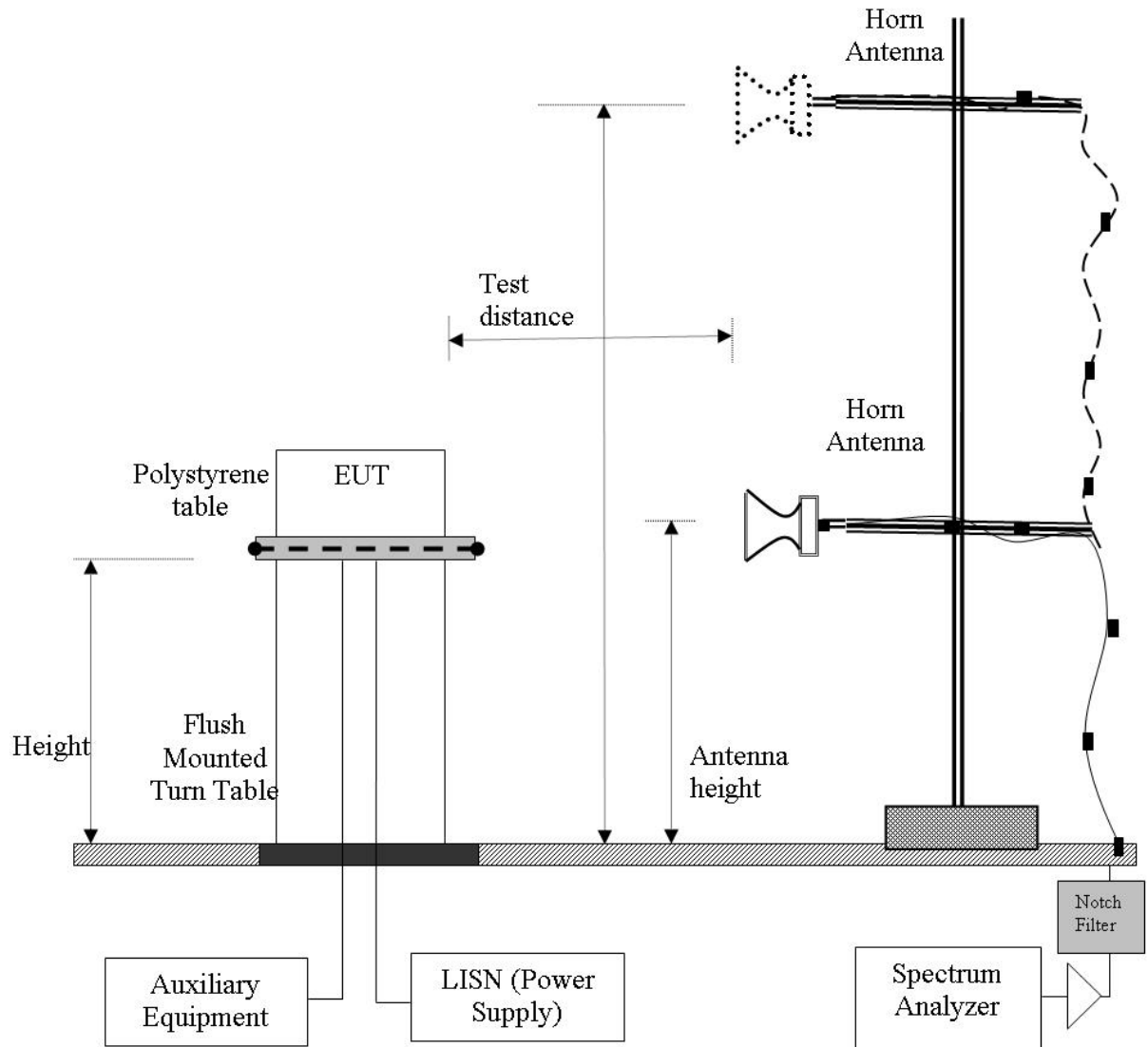

This test report may be reproduced in full only. The document may only be updated by MiCOM Labs personnel. Any changes will be noted in the Document History section of the report.



Title: SP-4700-A
To: FCC 47 CFR Part 15.407 & IC RSS-210
Serial #: TRIL05-U4b Rev A
Issue Date: 23rd May 2012
Page: 64 of 122

Field Strength Calculation

The field strength is calculated by adding the Antenna Factor and Cable Loss, and subtracting Amplifier Gain from the measured reading. All factors are included in the reported data.

$$FS = R + AF + CORR - FO$$

FS = Field Strength

R = Measured Spectrum analyzer Input Amplitude

AF = Antenna Factor

CORR = Correction Factor = CL - AG + NFL

CL = Cable Loss

AG = Amplifier Gain

FO = Distance Falloff Factor

NFL = Notch Filter Loss or Waveguide Loss

Field Strength Calculation Example:

Given receiver input reading of 51.5 dB μ V; Antenna Factor of 8.5 dB; Cable Loss of 1.3 dB; Falloff Factor of 0 dB, an Amplifier Gain of 26 dB and Notch Filter Loss of 1 dB. The Field Strength of the measured emission is:

$$FS = 51.5 + 8.5 + 1.3 - 26.0 + 1 = 36.3 \text{ dB}\mu\text{V/m}$$

Conversion between dB μ V/m (or dB μ V) and μ V/m (or μ V) are done as:

$$\text{Level (dB}\mu\text{V/m)} = 20 * \text{Log (level (\mu\text{V/m}))}$$

$$40 \text{ dB}\mu\text{V/m} = 100 \mu\text{V/m}$$

$$48 \text{ dB}\mu\text{V/m} = 250 \mu\text{V/m}$$

The following formula is used to convert the equipment isotropic radiated power (eirp) to field strength (dB μ V/m);

$$E = 1000000 \times \sqrt{30P} / 3 \mu\text{V/m}$$

where P is the EIRP in Watts

$$\text{Therefore: } -27 \text{ dBm/MHz} = 68.23 \text{ dB}\mu\text{V/m}$$

Note: The data in this Section identifies that the EUT is in compliance with the -27dBm/MHz EIRP limit (68.23 dB μ V/m) for out of band emissions. All out of band emissions are less than 68.23 dB μ V/m.

This test report may be reproduced in full only. The document may only be updated by MiCOM Labs personnel. Any changes will be noted in the Document History section of the report.



Title: SP-4700-A
To: FCC 47 CFR Part 15.407 & IC RSS-210
Serial #: TRIL05-U4b Rev A
Issue Date: 23rd May 2012
Page: 65 of 122

Specification

Radiated Spurious Emissions

15.407 (b)(2). All emissions outside of the 5,150-5,350MHz band shall not exceed an EIRP of -27dBm/MHz.

FCC §15.205 (a) Except as shown in paragraph (d) of 15.205 (a), only spurious emissions are permitted in any of the frequency bands listed.

FCC §15.205 (a) Except as shown in paragraphs (d) and (e) of this section, the field strength of emissions appearing within these frequency bands shall not exceed the limits shown in Section §15.209. At frequencies equal to or less than 1000 MHz, compliance with the limits in Section 15.209 shall be demonstrated using measurement instrumentation employing a CISPR quasi-peak detector. Above 1000 MHz, compliance with the emission limits in Section 15.209 shall be demonstrated based on the average value of the measured emissions. The provisions in Section 15.35 apply to these measurements.

FCC §15.209 (a) Except as provided elsewhere in this subpart, the emissions from an intentional radiator shall not exceed the field strength levels specified in the following table.

RSS-210 §A9.3(2) For transmitters operating in the 5250-5350 MHz band, all emissions outside the 5150-5350 MHz band shall not exceed -27 dBm/MHz e.i.r.p. Devices operating in the 5250-5350 MHz band that generate emissions in the 5150-5250 MHz band shall not exceed out of band emission limit of 27 dBm/MHz e.i.r.p. in the 5150-5250 MHz band in order to operate indoor/outdoor, or alternatively shall comply with the spectral power density for operation within the 5150-5250 MHz band and shall be labeled "for indoor use only".

RSS-Gen §4.7 The search for unwanted emissions shall be from the lowest frequency internally generated or used in the device (local oscillator, intermediate of carrier frequency), or from 30 MHz, whichever is the lowest frequency, to the 5th harmonic of the highest frequency generated without exceeding 40 GHz.

RSS-Gen §6 Receiver Spurious Emission Standard

If a radiated measurement is made, all spurious emissions shall comply with the limits of the following Table. The resolution bandwidth of the spectrum analyzer shall be 100 kHz for spurious emission measurements below 1.0 GHz and 1.0 MHz for measurements above 1.0 GHz

This test report may be reproduced in full only. The document may only be updated by MiCOM Labs personnel. Any changes will be noted in the Document History section of the report.



Title: SP-4700-A
To: FCC 47 CFR Part 15.407 & IC RSS-210
Serial #: TRIL05-U4b Rev A
Issue Date: 23rd May 2012
Page: 66 of 122

Laboratory Measurement Uncertainty for Spectrum Measurement

Measurement Uncertainty	+5.6/ -4.5 dB
--------------------------------	---------------

Traceability:

Method	Test Equipment Used
Work instruction WI-03	0088, 0158, 0134, 0304, 0311, 0315, 0310, 0312

This test report may be reproduced in full only. The document may only be updated by MiCOM Labs personnel. Any changes will be noted in the Document History section of the report.



Title: SP-4700-A
To: FCC 47 CFR Part 15.407 & IC RSS-210
Serial #: TRIL05-U4b Rev A
Issue Date: 23rd May 2012
Page: 67 of 122

5.1.7.1. Integral Antenna

Test Freq.	5180 MHz	Engineer	GMH
Variant	802.11a; 6 Mbs	Temp (°C)	19
Freq. Range	1000 MHz - 18000 MHz	Rel. Hum.(%)	32
Power Setting	8	Press. (mBars)	1009
Antenna	Integral 17 dBi	Duty Cycle (%)	100
Test Notes 1	Model No. Tested: SM CONN DB (Dual Band)		
Test Notes 2			

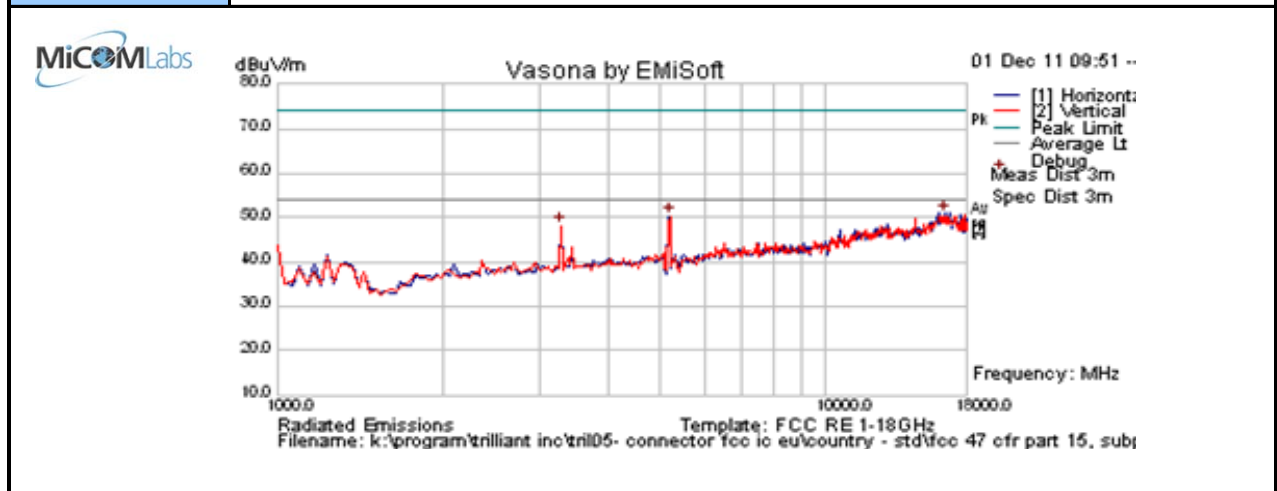

Formally measured emission peaks

Frequency MHz	Raw dBuV	Cable Loss	AF dB	Level dBuV/m	Measurement Type	Pol	Hgt cm	Azt Deg	Limit dBuV/m	Margin dB	Pass /Fail	Comments
16466.934	41.8	8.8	0.3	50.9	Peak [Scan]	H	100	0	54.0	-3.1	Pass	NOISE
5190.380762	55.5	4.6	-9.9	50.2	Peak [Scan]	V						FUND
3282.565	56.5	3.5	-11.8	48.2	Peak [Scan]	V	100	0	54.0	-5.8	Pass	NRB
Legend: TX = Transmitter Emissions; DIG = Digital Emissions; FUND = Fundamental; WB = Wideband Emission NRB = Non-Restricted Band. Limit = 68.23 dBuV/m; RB = Restricted Band. Limits per 15.205												

The above plot shows peak emissions.

This test report may be reproduced in full only. The document may only be updated by MiCOM Labs personnel. Any changes will be noted in the Document History section of the report.



Title: SP-4700-A
To: FCC 47 CFR Part 15.407 & IC RSS-210
Serial #: TRIL05-U4b Rev A
Issue Date: 23rd May 2012
Page: 68 of 122

5150 MHz Band Edge ; Power =8

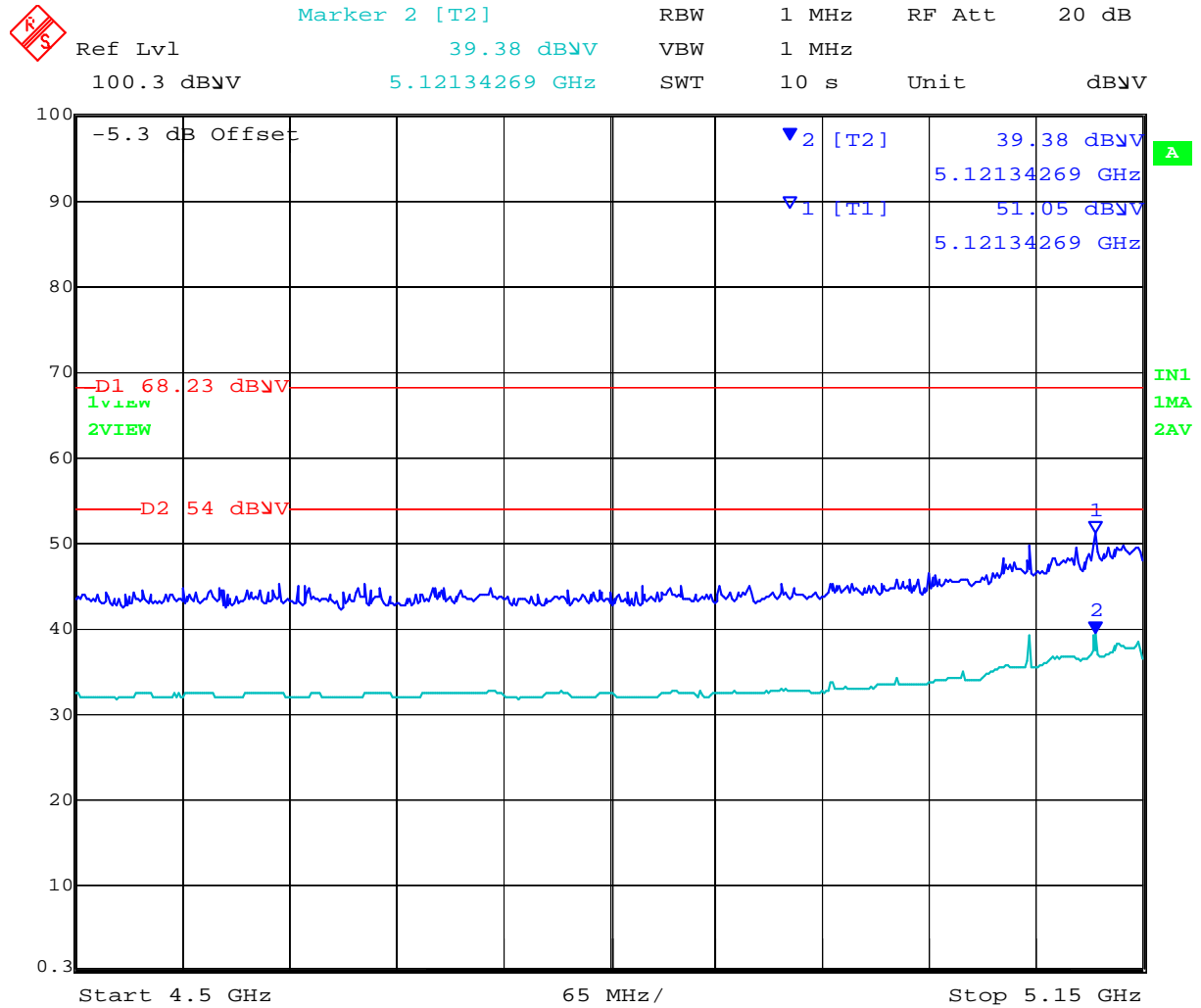

Date: 1.DEC.2011 12:41:30

This test report may be reproduced in full only. The document may only be updated by MiCOM Labs personnel. Any changes will be noted in the Document History section of the report.



Title: SP-4700-A
To: FCC 47 CFR Part 15.407 & IC RSS-210
Serial #: TRIL05-U4b Rev A
Issue Date: 23rd May 2012
Page: 69 of 122

Test Freq.	5200 MHz	Engineer	GMH
Variant	802.11a; 6 Mbs	Temp (°C)	19
Freq. Range	1000 MHz - 18000 MHz	Rel. Hum.(%)	32
Power Setting	8	Press. (mBars)	1009
Antenna	Integral 17 dBi	Duty Cycle (%)	100
Test Notes 1	Model No. Tested: SM CONN DB (Dual Band)		
Test Notes 2			

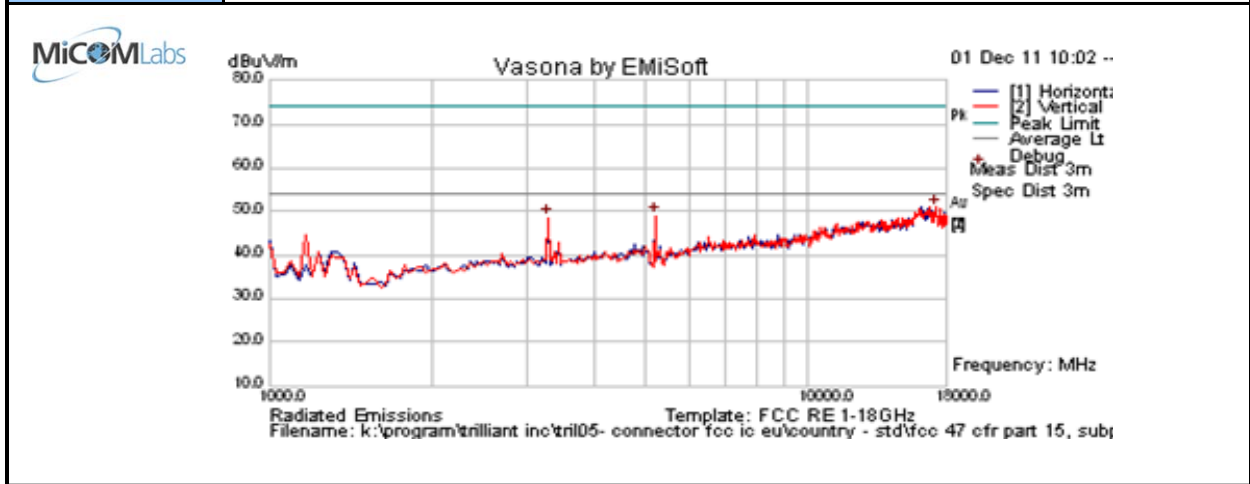

Formally measured emission peaks

Frequency MHz	Raw dBuV	Cable Loss	AF dB	Level dBuV/m	Measurement Type	Pol	Hgt cm	Azt Deg	Limit dBuV/m	Margin dB	Pass /Fail	Comments
17216.433	41.5	8.6	0.9	50.9	Peak [Scan]	V	100	0	54.0	-3.1	Pass	NOISE
5190.380762	54.1	4.6	-9.9	48.9	Peak [Scan]	H						FUND
3282.565	56.9	3.5	-11.8	48.6	Peak [Scan]	V	100	0	54.0	-5.4	Pass	NRB

Legend: TX = Transmitter Emissions; DIG = Digital Emissions; FUND = Fundamental; WB = Wideband Emission
 NRB = Non-Restricted Band. Limit = 68.23 dBuV/m; RB = Restricted Band. Limits per 15.205

The above plot shows peak emissions.

This test report may be reproduced in full only. The document may only be updated by MiCOM Labs personnel. Any changes will be noted in the Document History section of the report.



Title: SP-4700-A
To: FCC 47 CFR Part 15.407 & IC RSS-210
Serial #: TRIL05-U4b Rev A
Issue Date: 23rd May 2012
Page: 70 of 122

Test Freq.	5240 MHz	Engineer	GMH
Variant	802.11a; 6 Mbs	Temp (°C)	19
Freq. Range	1000 MHz - 18000 MHz	Rel. Hum.(%)	32
Power Setting	8	Press. (mBars)	1009
Antenna	Integral 17 dBi	Duty Cycle (%)	100
Test Notes 1	Model No. Tested: SM CONN DB (Dual Band)		
Test Notes 2			

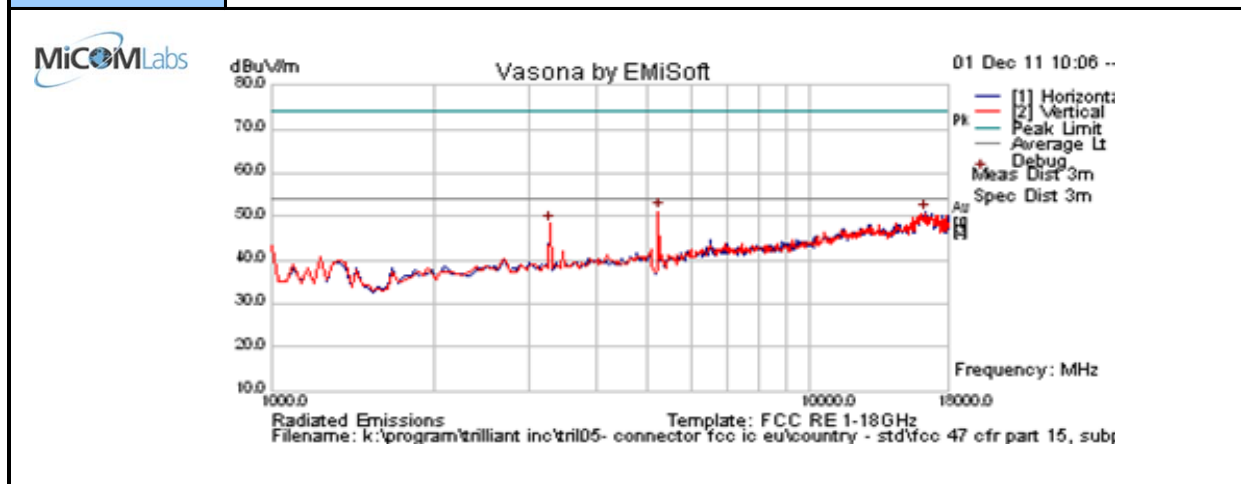

Formally measured emission peaks

Frequency MHz	Raw dBuV	Cable Loss	AF dB	Level dBuV/m	Measurement Type	Pol	Hgt cm	Azt Deg	Limit dBuV/m	Margin dB	Pass /Fail	Comments
5224.449	56.3	4.6	-9.8	51.1	Peak [Scan]	H						FUND
16296.593	41.8	8.9	0.2	50.9	Peak [Scan]	H	100	0	54.0	-3.1	Pass	NOISE
3282.565	56.6	3.5	-11.8	48.3	Peak [Scan]	V	100	0	54.0	-5.7	Pass	NRB

Legend: TX = Transmitter Emissions; DIG = Digital Emissions; FUND = Fundamental; WB = Wideband Emission
 NRB = Non-Restricted Band. Limit = 68.23 dBuV/m; RB = Restricted Band. Limits per 15.205

The above plot shows peak emissions.

This test report may be reproduced in full only. The document may only be updated by MiCOM Labs personnel. Any changes will be noted in the Document History section of the report.



Title: SP-4700-A
To: FCC 47 CFR Part 15.407 & IC RSS-210
Serial #: TRIL05-U4b Rev A
Issue Date: 23rd May 2012
Page: 71 of 122

Test Freq.	5260 MHz	Engineer	GMH
Variant	802.11a; 6 Mbs	Temp (°C)	22
Freq. Range	1000 MHz - 18000 MHz	Rel. Hum.(%)	30
Power Setting	16	Press. (mBars)	1005
Antenna	Integral 17 dBi	Duty Cycle (%)	100
Test Notes 1	Model No. Tested: SM CONN DB (Dual Band)		
Test Notes 2			

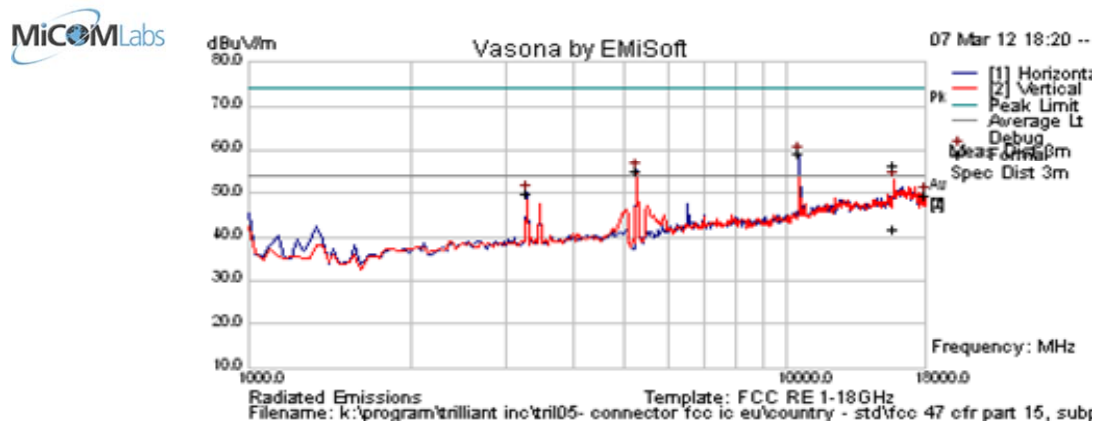

Formally measured emission peaks

Frequency MHz	Raw dBuV	Cable Loss	AF dB	Level dBuV/m	Measurement Type	Pol	Hgt cm	Azt Deg	Limit dBuV/m	Margin dB	Pass /Fail	Comments
15778.863	47.8	8.7	-0.3	56.1	Peak Max	V	108	178	74.0	-17.9	Pass	RB
15778.863	33.5	8.7	-0.3	41.8	Average Max	V	108	178	54.0	-12.2	Pass	RB
10505.010	54.8	6.8	-2.4	59.2	Peak [Scan]	H					Pass	NRB
5258.517	60.4	4.6	-9.7	55.2	Peak [Scan]	H						FUND
3282.565	58.3	3.5	-11.8	50.0	Peak [Scan]	H					Pass	NRB
18000.000	40.1	8.8	0.7	49.7	Peak [Scan]	H	150	0	54	-4.3	Pass	NOISE

Legend: TX = Transmitter Emissions; DIG = Digital Emissions; FUND = Fundamental; WB = Wideband Emission
 NRB = Non-Restricted Band. Limit = 68.23 dBuV/m; RB = Restricted Band. Limits per 15.205

The above plot shows peak emissions.

This test report may be reproduced in full only. The document may only be updated by MiCOM Labs personnel. Any changes will be noted in the Document History section of the report.



Title: SP-4700-A
To: FCC 47 CFR Part 15.407 & IC RSS-210
Serial #: TRIL05-U4b Rev A
Issue Date: 23rd May 2012
Page: 72 of 122

Test Freq.	5300 MHz	Engineer	GMH
Variant	802.11a; 6 Mbs	Temp (°C)	22
Freq. Range	1000 MHz - 18000 MHz	Rel. Hum.(%)	30
Power Setting	16	Press. (mBars)	1005
Antenna	Integral 17 dBi	Duty Cycle (%)	100
Test Notes 1	Model No. Tested: SM CONN DB (Dual Band)		
Test Notes 2			

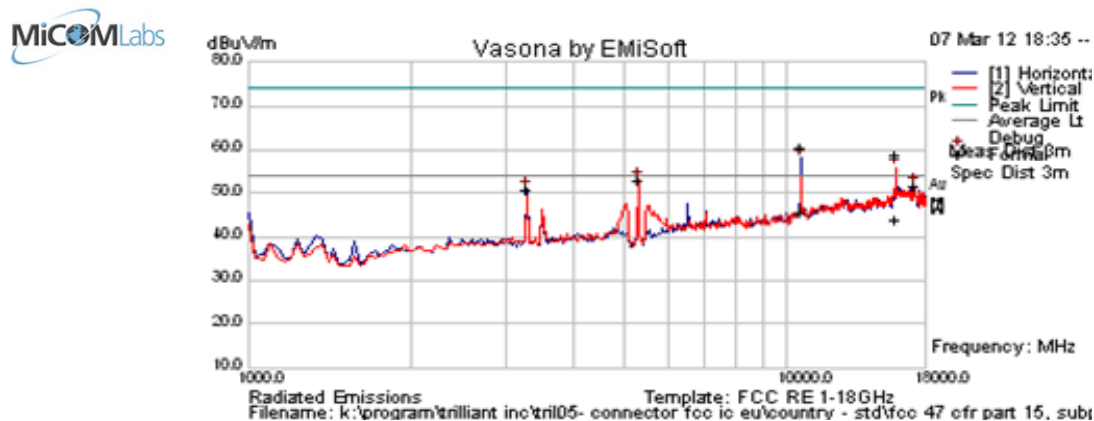

Formally measured emission peaks

Frequency MHz	Raw dBuV	Cable Loss	AF dB	Level dBuV/m	Measurement Type	Pol	Hgt cm	Azt Deg	Limit dBuV/m	Margin dB	Pass /Fail	Comments
10600.335	56.1	6.8	-2.4	60.5	Peak Max	H	151	274	74.0	-13.5	Pass	RB
15900.842	50.1	8.9	-0.2	58.8	Peak Max	V	119	184	74.0	-15.2	Pass	RB
10600.335	41.1	6.8	-2.4	45.4	Average Max	H	151	274	54.0	-8.6	Pass	RB
15900.842	35.2	8.9	-0.2	43.9	Average Max	V	119	184	54.0	-10.1	Pass	RB
5292.585	58.0	4.6	-9.6	53.1	Peak [Scan]	V						FUND
17250.501	42.0	8.6	1.0	51.6	Peak [Scan]	V	100	0	54.0	-2.4	Pass	NOISE
3282.565	59.2	3.5	-11.8	50.9	Peak [Scan]	H					Pass	NRB

Legend: TX = Transmitter Emissions; DIG = Digital Emissions; FUND = Fundamental; WB = Wideband Emission
 NRB = Non-Restricted Band. Limit = 68.23 dBuV/m; RB = Restricted Band. Limits per 15.205

The above plot shows peak emissions.

This test report may be reproduced in full only. The document may only be updated by MiCOM Labs personnel. Any changes will be noted in the Document History section of the report.



Title: SP-4700-A
To: FCC 47 CFR Part 15.407 & IC RSS-210
Serial #: TRIL05-U4b Rev A
Issue Date: 23rd May 2012
Page: 73 of 122

Test Freq.	5320 MHz	Engineer	GMH
Variants	802.11a; 6 Mbs	Temp (°C)	22
Freq. Range	1000 MHz - 18000 MHz	Rel. Hum.(%)	30
Power Setting	16	Press. (mBars)	1005
Antenna	Integral 17 dBi	Duty Cycle (%)	100
Test Notes 1	Model No. Tested: SM CONN DB (Dual Band)		
Test Notes 2			

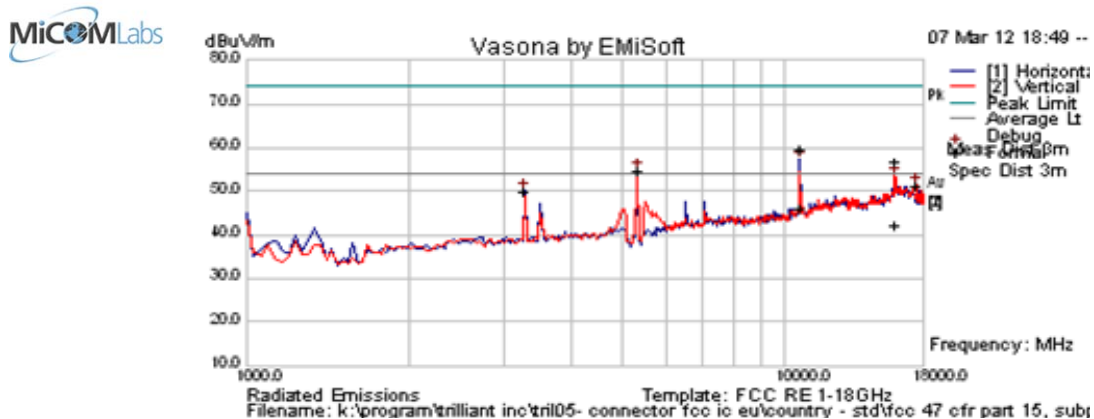

Formally measured emission peaks

Frequency MHz	Raw dBuV	Cable Loss	AF dB	Level dBuV/m	Measurement Type	Pol	Hgt cm	Azt Deg	Limit dBuV/m	Margin dB	Pass /Fail	Comments
10642.065	55.4	6.8	-2.4	59.8	Peak Max	H	148	272	74.0	-14.2	Pass	RB
15961.964	47.9	9.0	0.0	56.9	Peak Max	V	98	184	74.0	-17.2	Pass	RB
10642.065	41.7	6.8	-2.4	46.1	Average Max	H	148	272	54	-7.9	Pass	RB
15961.964	33.2	9.0	0.0	42.2	Average Max	V	98	184	54	-11.8	Pass	RB
5326.653	59.4	4.6	-9.5	54.5	Peak [Scan]	V						FUND
17591.182	41.9	8.8	0.6	51.3	Peak [Scan]	V	200	0	54	-2.7	Pass	NOISE
3282.565	58.3	3.5	-11.8	50.0	Peak [Scan]	H					Pass	NRB

Legend: TX = Transmitter Emissions; DIG = Digital Emissions; FUND = Fundamental; WB = Wideband Emission
 NRB = Non-Restricted Band. Limit = 68.23 dBuV/m; RB = Restricted Band. Limits per 15.205

The above plot shows peak emissions.

This test report may be reproduced in full only. The document may only be updated by MiCOM Labs personnel. Any changes will be noted in the Document History section of the report.



Title: SP-4700-A
To: FCC 47 CFR Part 15.407 & IC RSS-210
Serial #: TRIL05-U4b Rev A
Issue Date: 23rd May 2012
Page: 74 of 122

5350 MHz Band Edge ; Pwr = 12

 Marker 1 [T1] RBW 1 MHz RF Att 20 dB
Ref Lvl 55.77 dBμV VBW 1 MHz
100.6 dBμV 5.35066132 GHz SWT 10 s Unit dBμV

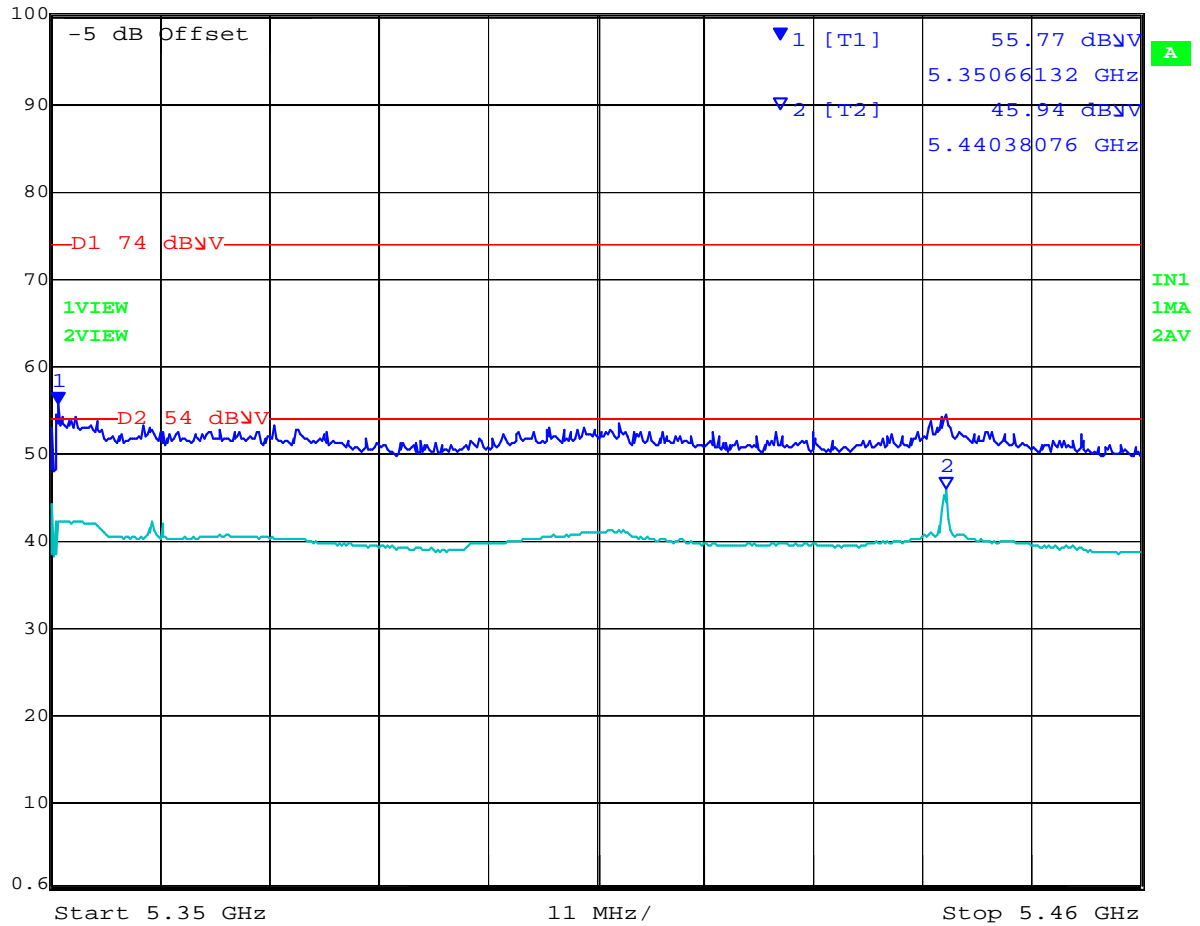

Date: 1.DEC.2011 12:36:53

This test report may be reproduced in full only. The document may only be updated by MiCOM Labs personnel. Any changes will be noted in the Document History section of the report.



Title: SP-4700-A
To: FCC 47 CFR Part 15.407 & IC RSS-210
Serial #: TRIL05-U4b Rev A
Issue Date: 23rd May 2012
Page: 75 of 122

Test Freq.	5500 MHz	Engineer	GMH
Variant	802.11a; 6 Mbs	Temp (°C)	22
Freq. Range	1000 MHz - 18000 MHz	Rel. Hum.(%)	30
Power Setting	16	Press. (mBars)	1006
Antenna	Integral 18.5 dBi	Duty Cycle (%)	100
Test Notes 1			
Test Notes 2			

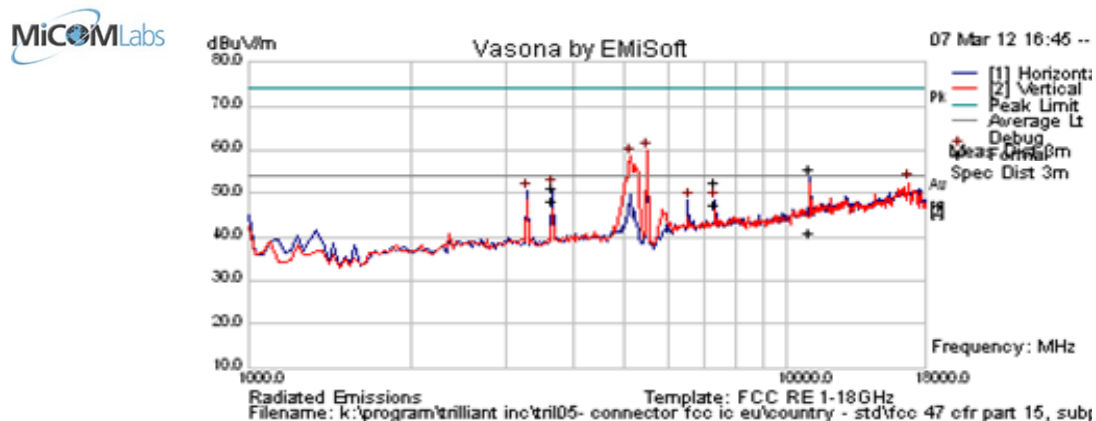

Formally measured emission peaks

Frequency MHz	Raw dBuV	Cable Loss	AF dB	Level dBuV/m	Measurement Type	Pol	Hgt cm	Azt Deg	Limit dBuV/m	Margin dB	Pass /Fail	Comments
11002.004	51.6	7.0	-3.1	55.5	Peak Max	H	136	293	74.0	-18.5	Pass	RB
3666.755	58.7	3.7	-11.3	51.2	Peak Max	H	105	77	74.0	-22.9	Pass	RB
7333.366	52.6	5.5	-5.6	52.4	Peak Max	H	147	263	74	-21.6	Pass	RB
11002.004	37.1	7.0	-3.1	41.0	Average Max	H	136	293	54	-13.0	Pass	RB
3666.755	55.7	3.7	-11.3	48.2	Average Max	H	105	77	54	-5.8	Pass	RB
7333.366	47.6	5.5	-5.6	47.4	Average Max	H	147	263	54	-6.6	Pass	RB
5496.994	64.8	4.6	-9.6	59.8	Peak [Scan]	V						FUND
5122.244	63.9	4.6	-10.0	58.5	Peak [Scan]	V					Pass	BE
16773.547	42.8	8.6	0.9	52.4	Peak [Scan]	V	100	0	54	-1.6	Pass	NOISE
3282.565	58.7	3.5	-11.8	50.4	Peak [Scan]	H					Pass	NRB
6553.106	50.1	5.2	-7.0	48.2	Peak [Scan]	H					Pass	NRB

Legend: TX = Transmitter Emissions; DIG = Digital Emissions; FUND = Fundamental; BE = Band-Edge
 NRB = Non-Restricted Band. Limit = 68.23 dBuV/m; RB = Restricted Band. Limits per 15.205

The above plot shows peak emissions.

This test report may be reproduced in full only. The document may only be updated by MiCOM Labs personnel. Any changes will be noted in the Document History section of the report.



5460 MHz Band Edge ; Pwr=11

 Marker 1 [T1] RBW 1 MHz RF Att 20 dB
Ref Lvl 54.89 dBμV VBW 1 MHz
100.6 dBμV 5.38681363 GHz SWT 10 s Unit dBμV

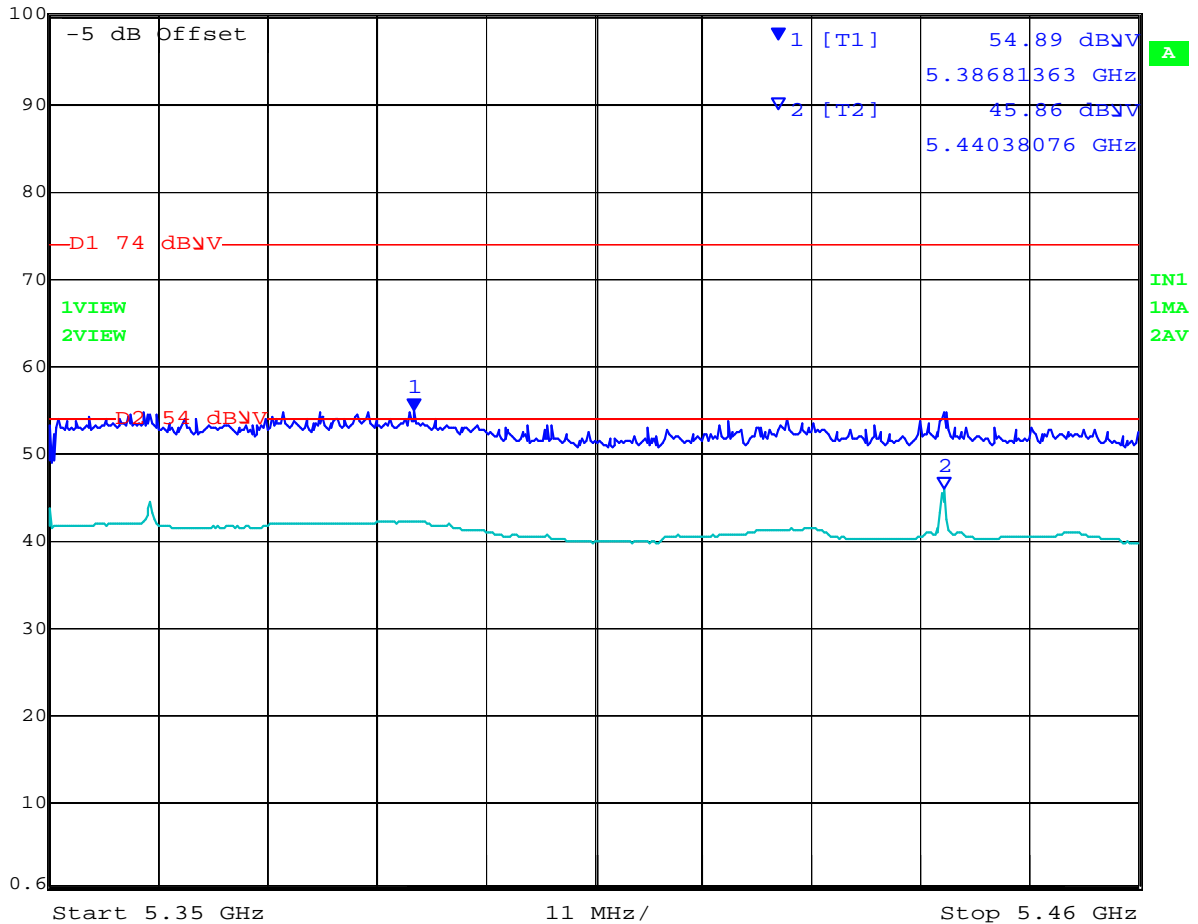

Date: 1.DEC.2011 12:29:56

This test report may be reproduced in full only. The document may only be updated by MiCOM Labs personnel. Any changes will be noted in the Document History section of the report.



Title: SP-4700-A
To: FCC 47 CFR Part 15.407 & IC RSS-210
Serial #: TRIL05-U4b Rev A
Issue Date: 23rd May 2012
Page: 77 of 122

Test Freq.	5580 MHz	Engineer	GMH
Variant	802.11a; 6 Mbs	Temp (°C)	22
Freq. Range	1000 MHz - 18000 MHz	Rel. Hum.(%)	30
Power Setting	16	Press. (mBars)	1006
Antenna	Integral 18.5 dBi	Duty Cycle (%)	100
Test Notes 1			
Test Notes 2			

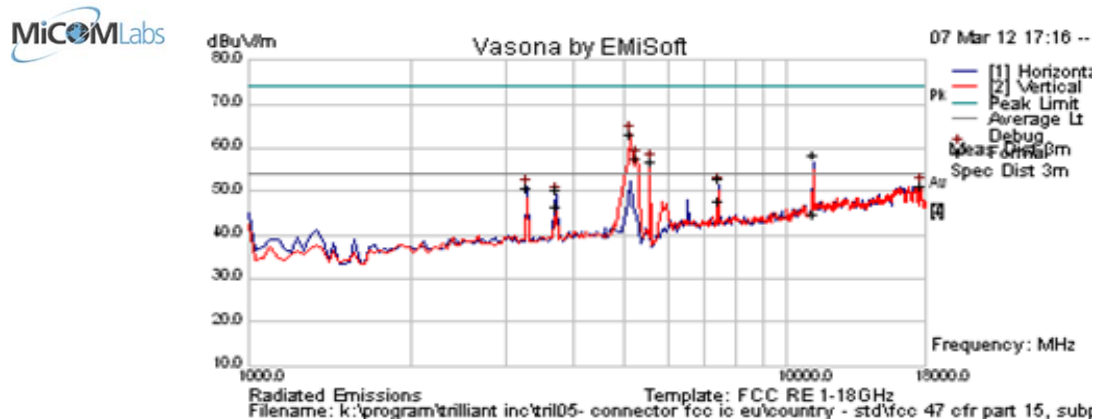

Formally measured emission peaks

Frequency MHz	Raw dBuV	Cable Loss	AF dB	Level dBuV/m	Measurement Type	Pol	Hgt cm	Azt Deg	Limit dBuV/m	Margin dB	Pass /Fail	Comments
11162.089	54.3	6.9	-3.0	58.3	Peak Max	H	145	244	74.0	-15.7	Pass	RB
7440.068	52.7	5.5	-5.4	52.8	Peak Max	H	168	260	74.0	-21.2	Pass	RB
3720.003	57.5	3.7	-11.1	50.2	Peak Max	H	105	78	74	-23.8	Pass	RB
11162.089	40.9	6.9	-3.0	44.8	Average Max	H	145	244	54	-9.2	Pass	RB
7440.068	47.5	5.5	-5.4	47.6	Average Max	H	168	260	54.0	-6.4	Pass	RB
3720.003	53.7	3.7	-11.1	46.3	Average Max	H	105	78	54.0	-7.7	Pass	RB
5122.244489	68.7	4.6	-10.0	63.3	Peak [Scan]	V					Pass	BE
5258.517	62.9	4.6	-9.7	57.8	Peak [Scan]	V					Pass	BE
5565.130	61.9	4.7	-9.7	56.9	Peak [Scan]	V						FUND
17693.387	42.1	8.8	0.3	51.2	Peak [Scan]	V	100	0	54	-2.8	Pass	NOISE
3282.565	59.1	3.5	-11.8	50.8	Peak [Scan]	H					Pass	NRB

Legend: TX = Transmitter Emissions; DIG = Digital Emissions; FUND = Fundamental; BE = Band-Edge
 NRB = Non-Restricted Band. Limit = 68.23 dBuV/m; RB = Restricted Band. Limits per 15.205

The above plot shows peak emissions.

This test report may be reproduced in full only. The document may only be updated by MiCOM Labs personnel. Any changes will be noted in the Document History section of the report.



Title: SP-4700-A
To: FCC 47 CFR Part 15.407 & IC RSS-210
Serial #: TRIL05-U4b Rev A
Issue Date: 23rd May 2012
Page: 78 of 122

Test Freq.	5700 MHz	Engineer	GMH
Variant	802.11a; 6 Mbs	Temp (°C)	22
Freq. Range	1000 MHz - 18000 MHz	Rel. Hum.(%)	30
Power Setting	16	Press. (mBars)	1006
Antenna	Integral 18.5 dBi	Duty Cycle (%)	100
Test Notes 1			
Test Notes 2			

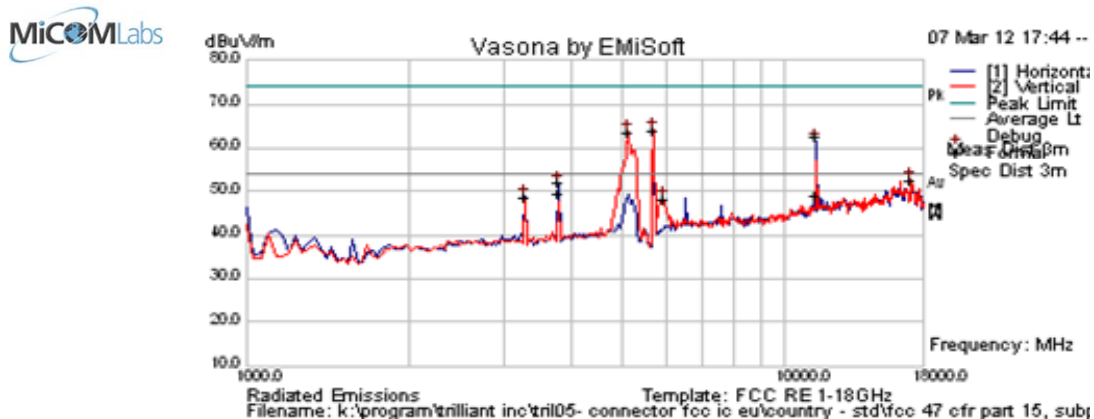

Formally measured emission peaks

Frequency MHz	Raw dBuV	Cable Loss	AF dB	Level dBuV/m	Measurement Type	Pol	Hgt cm	Azt Deg	Limit dBuV/m	Margin dB	Pass /Fail	Comments
11400.602	58.1	6.8	-2.3	62.6	Peak Max	H	158	274	74.0	-11.4	Pass	RB
3800.028	59.3	3.8	-10.9	52.1	Peak Max	H	103	240	74.0	-21.9	Pass	RB
11400.602	44.4	6.8	-2.3	49.0	Average Max	H	158	274	54.0	-5.0	Pass	RB
3800.028	56.5	3.8	-10.9	49.4	Average Max	H	103	240	54.0	-4.6	Pass	RB
5701.403	69.1	4.7	-9.6	64.3	Peak [Scan]	V						FUND
5122.244489	69.0	4.6	-10.0	63.7	Peak [Scan]	V					Pass	BE
17114.228	43.53	8.54	0.45	52.52	Peak [Scan]	V	200	0	54.0	-1.48	Pass	NOISE
3282.56513	57.07	3.51	-11.82	48.75	Peak [Scan]	H	100	0	54.0	-5.25	Pass	NRB
5939.880	52.1	4.9	-8.8	48.1	Peak [Scan]	V	100	0	54.0	-5.9	Pass	NRB

Legend: TX = Transmitter Emissions; DIG = Digital Emissions; FUND = Fundamental; BE = Band-Edge
 NRB = Non-Restricted Band. Limit = 68.23 dBuV/m; RB = Restricted Band. Limits per 15.205

The above plot shows peak emissions.

This test report may be reproduced in full only. The document may only be updated by MiCOM Labs personnel. Any changes will be noted in the Document History section of the report.



Title: SP-4700-A
To: FCC 47 CFR Part 15.407 & IC RSS-210
Serial #: TRIL05-U4b Rev A
Issue Date: 23rd May 2012
Page: 79 of 122

5.1.7.2. Receiver Radiated Spurious Emissions

Receiver Radiated Spurious Emissions

Test Freq.	5180 MHz	Engineer	GMH
Variant	Receive in Test Utility	Temp (°C)	21.5
Freq. Range	1000 MHz - 18000 MHz	Rel. Hum.(%)	31
Power Setting	Not Applicable in Receive Mode	Press. (mBars)	1007

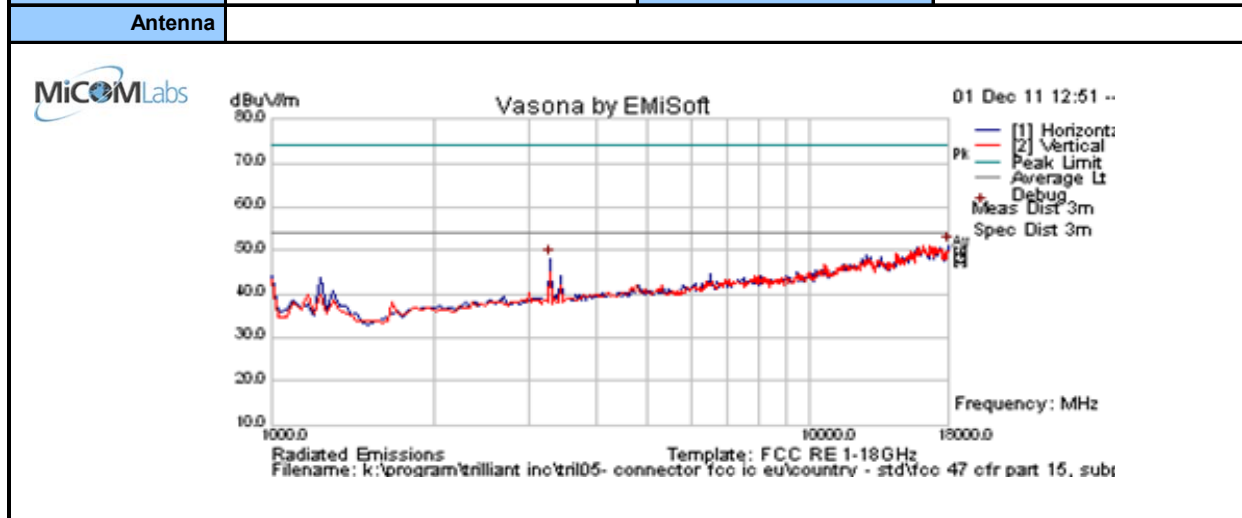

Formally measured emission peaks

Frequency MHz	Raw dBuV	Cable Loss	AF dB	Level dBuV/m	Measurement Type	Pol	Hgt cm	Azt Deg	Limit dBuV/m	Margin dB	Pass /Fail	Comments
18000.0	41.9	8.8	0.7	51.4	Peak [Scan]	H	100	0.0	54.0	-2.6	Pass	
3282.565	56.5	3.5	-11.8	48.1	Peak [Scan]	H	100	0	54	-5.9	Pass	

Legend: RB = Restricted Band; NRB = Non-Restricted Band; FUND = Fundamental Freq.
 BE = Emission in Restricted Band Nearest Transmission Band Edge;

The above plot shows peak emissions.

This test report may be reproduced in full only. The document may only be updated by MiCOM Labs personnel. Any changes will be noted in the Document History section of the report.



Title: SP-4700-A
To: FCC 47 CFR Part 15.407 & IC RSS-210
Serial #: TRIL05-U4b Rev A
Issue Date: 23rd May 2012
Page: 80 of 122

Test Freq.	5300 MHz	Engineer	GMH
Variant	Receive in Test Utility	Temp (°C)	21.5
Freq. Range	1000 MHz - 18000 MHz	Rel. Hum.(%)	31
Power Setting	Not Applicable in Receive Mode	Press. (mBars)	1007
Antenna			

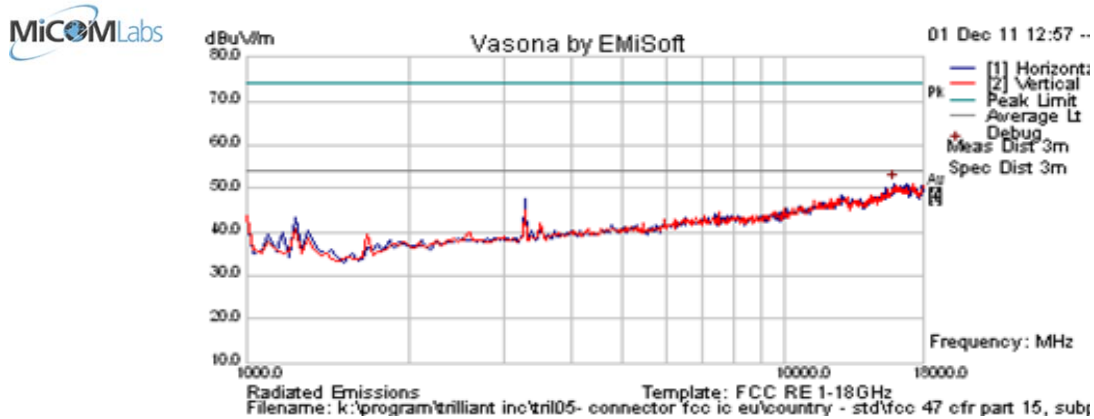

Formally measured emission peaks

Frequency MHz	Raw dBuV	Cable Loss	AF dB	Level dBuV/m	Measurement Type	Pol	Hgt cm	Azt Deg	Limit dBuV/m	Margin dB	Pass /Fail	Comments
15921.844	42.4	8.9	-0.1	51.2	Peak [Scan]	H	150	0	54.000	-2.9	Pass	

Legend: RB = Restricted Band; NRB = Non-Restricted Band; FUND = Fundamental Freq.
 BE = Emission in Restricted Band Nearest Transmission Band Edge;

The above plot shows peak emissions.

This test report may be reproduced in full only. The document may only be updated by MiCOM Labs personnel. Any changes will be noted in the Document History section of the report.



Title: SP-4700-A
To: FCC 47 CFR Part 15.407 & IC RSS-210
Serial #: TRIL05-U4b Rev A
Issue Date: 23rd May 2012
Page: 81 of 122

Test Freq.	5580 MHz	Engineer	GMH
Variant	Receive in Test Utility	Temp (°C)	21.5
Freq. Range	1000 MHz - 18000 MHz	Rel. Hum.(%)	31
Power Setting	Not Applicable in Receive Mode	Press. (mBars)	1007
Antenna			

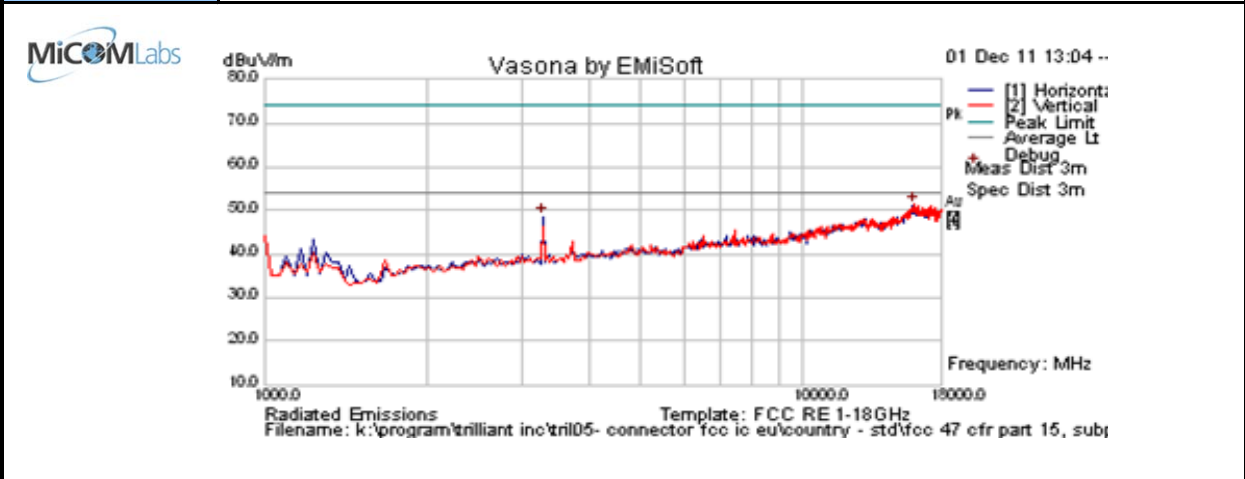

Formally measured emission peaks

Frequency MHz	Raw dBuV	Cable Loss	AF dB	Level dBuV/m	Measurement Type	Pol	Hgt cm	Azt Deg	Limit dBuV/m	Margin dB	Pass /Fail	Comments
16024.048	42.09	9.01	0.24	51.34	Peak [Scan]	V	100	0	54	-2.66	Pass	
3282.565	56.87	3.51	-11.82	48.55	Peak [Scan]	H	100	0	54	-5.45	Pass	

Legend: RB = Restricted Band; NRB = Non-Restricted Band; FUND = Fundamental Freq.
 BE = Emission in Restricted Band Nearest Transmission Band Edge;

The above plot shows peak emissions.

This test report may be reproduced in full only. The document may only be updated by MiCOM Labs personnel. Any changes will be noted in the Document History section of the report.



Title: SP-4700-A
To: FCC 47 CFR Part 15.407 & IC RSS-210
Serial #: TRIL05-U4b Rev A
Issue Date: 23rd May 2012
Page: 82 of 122

5.1.7.3. Radiated Spurious Emissions – 30MHz – 1000MHz

FCC, Part 15 Subpart C §15.205/ §15.209
Industry Canada RSS-210 §2.2

Test Procedure

Testing 30M-1 GHz was performed in a 3-meter anechoic chamber using a CISPR compliant receiver. Preliminary radiated emissions were measured on every azimuth and with the receiving antenna in both horizontal and vertical polarizations. To further maximize emissions the receive antenna was varied between 1 and 4 meters. The emissions are recorded with receiver in peak hold mode. Emissions closest to the limits are measured in the quasi-peak mode with the tuned receiver using a bandwidth of 120 kHz. Only the highest emissions relative to the limit are listed. The anechoic chamber test set-up is identified in Section 6 Test Set-Up Photographs.

The EUT had two methods of powering on ac/dc converter and Power over Ethernet (POE). Both modes were tested for emissions below 1GHz.

Field Strength Calculation

The field strength is calculated by adding the Antenna Factor and Cable Loss, and subtracting Amplifier Gain from the measured reading. In this test facility, the Antenna Factor, Cable Loss, and Amplifier Gains are loaded into the Rohde & Schwarz Receiver and the corrected field strength can be read directly on the receiver.

$$FS = R + AF + CORR$$

where:

FS = Field Strength
R = Measured Receiver Input Amplitude
AF = Antenna Factor
CORR = Correction Factor = CL – AG + NFL
CL = Cable Loss
AG = Amplifier Gain

For example:

Given a Receiver input reading of 51.5dB μ V; Antenna Factor of 8.5dB; Cable Loss of 1.3dB; Falloff Factor of 0dB, an Amplifier Gain of 26dB and Notch Filter Loss of 1dB. The Field Strength of the measured emission is:

$$FS = 51.5 + 8.5 + 1.3 - 26.0 + 1 = 36.3\text{dB}\mu\text{V}/\text{m}$$

Conversion between dB μ V/m (or dB μ V) and μ V/m (or μ V) are done as:

$$\text{Level (dB}\mu\text{V}/\text{m)} = 20 * \text{Log (level (\mu\text{V}/\text{m}))}$$

$$40 \text{ dB}\mu\text{V}/\text{m} = 100\mu\text{V}/\text{m}$$

$$48 \text{ dB}\mu\text{V}/\text{m} = 250\mu\text{V}/\text{m}$$

This test report may be reproduced in full only. The document may only be updated by MiCOM Labs personnel. Any changes will be noted in the Document History section of the report.

Radiated Emission Measurement Setup – Below 1 GHz

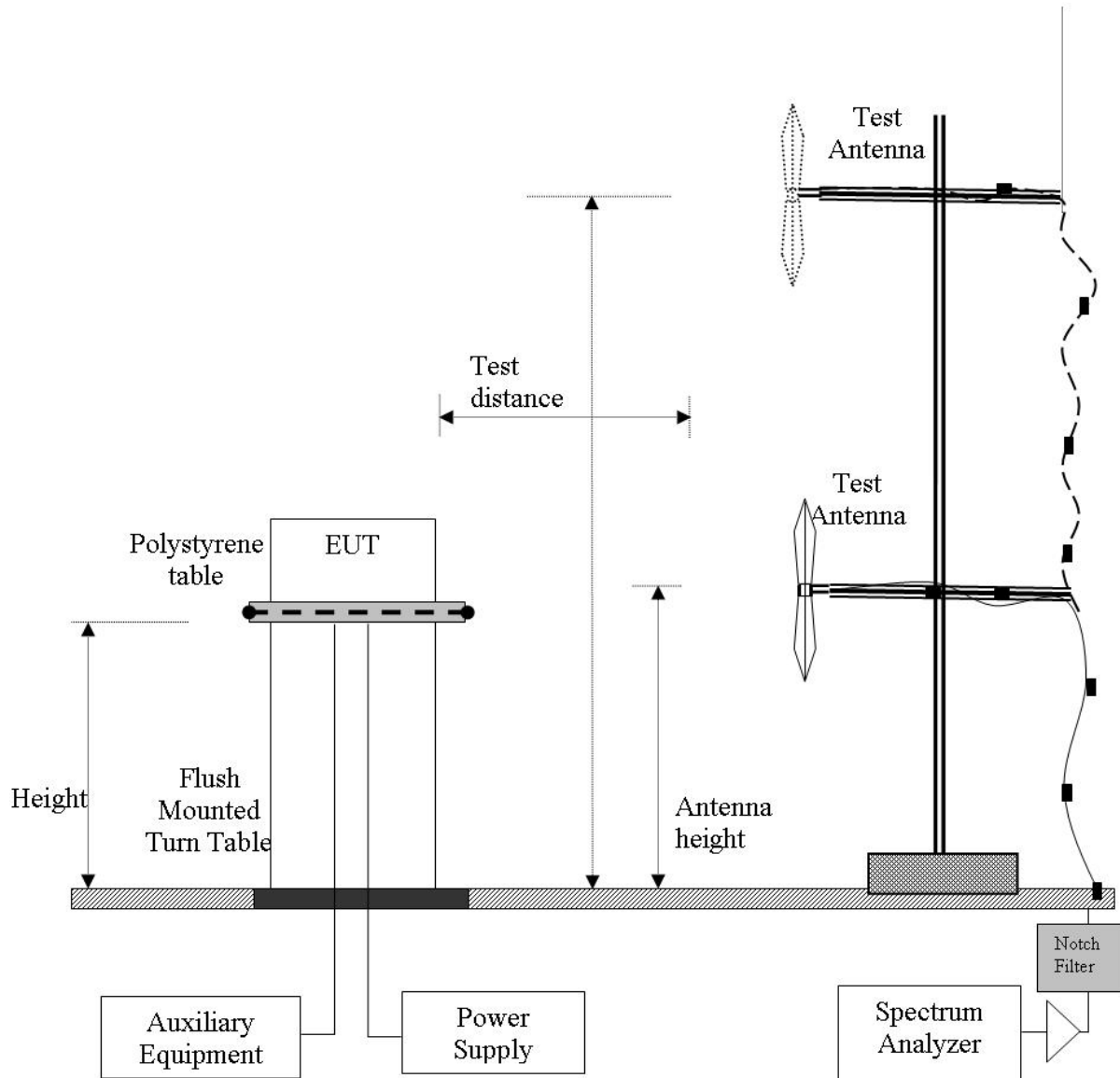

This test report may be reproduced in full only. The document may only be updated by MiCOM Labs personnel. Any changes will be noted in the Document History section of the report.



Title: SP-4700-A
To: FCC 47 CFR Part 15.407 & IC RSS-210
Serial #: TRIL05-U4b Rev A
Issue Date: 23rd May 2012
Page: 84 of 122

Test Freq.	N/A	Engineer	SB
Variant	Digital Emissions	Temp (°C)	19.5
Freq. Range	30 MHz - 1000 MHz	Rel. Hum.(%)	33
Power Setting	Max Power	Press. (mBars)	1005
Antenna			

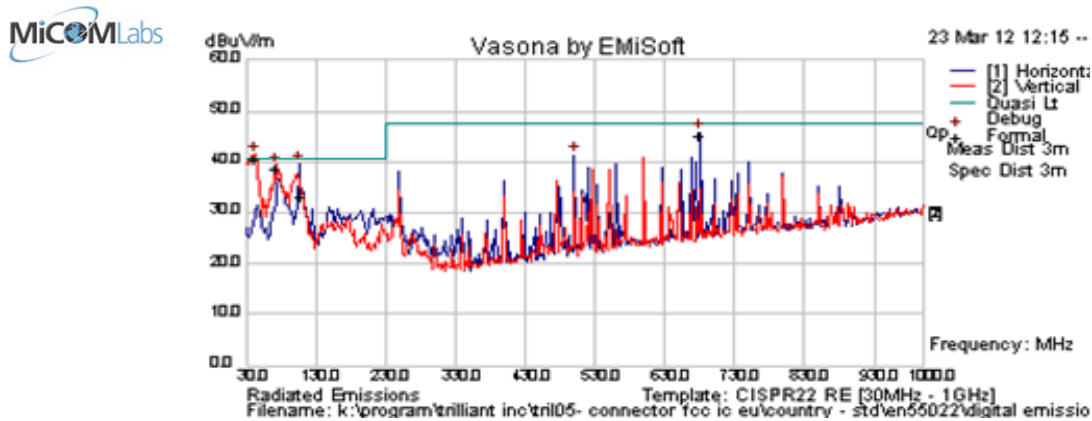

Formally measured emission peaks

Frequency MHz	Raw dBuV	Cable Loss	AF dB	Level dBuV/m	Measurement Type	Pol	Hgt cm	Azt Deg	Limit dBuV/m	Margin dB	Pass /Fail	Comments
42.372	56.2	3.6	-19.3	39.8	Quasi Max	V	98	280	40.5	-0.7	Pass	
109.727	47.9	4.1	-18.9	33.2	Quasi Max	H	169	360	40.5	-7.3	Pass	
73.591	57.8	3.9	-23.1	38.7	Quasi Max	V	98	325	40.5	-1.9	Pass	
679.988	49.2	6.5	-10.5	45.2	Quasi Max	H	98	178	47.5	-2.3	Pass	
500.421	48.6	5.8	-12.8	41.5	Peak [Scan]	H	200	0	47.5	-6.0	Pass	
399.475	44.6	5.5	-14.8	35.3	Peak [Scan]	H	98	280	47.5	-12.2	Pass	

Legend: DIG = Digital Device Emission; TX = Transmitter Emission; FUND = Fundamental Frequency
 NRB = Non-Restricted Band, Limit is 20 dB below Fundamental; RB = Restricted Band

This test report may be reproduced in full only. The document may only be updated by MiCOM Labs personnel. Any changes will be noted in the Document History section of the report.



Title: SP-4700-A
To: FCC 47 CFR Part 15.407 & IC RSS-210
Serial #: TRIL05-U4b Rev A
Issue Date: 23rd May 2012
Page: 85 of 122

Specification

Limits

§15.205 (a) Except as shown in paragraph (d) of 15.205 (a), only spurious emissions are permitted in any of the frequency bands listed.

§15.205 (a) Except as shown in paragraphs (d) and (e) of this section, the field strength of emissions appearing within these frequency bands shall not exceed the limits shown in Section §15.209. At frequencies equal to or less than 1000 MHz, compliance with the limits in Section 15.209 shall be demonstrated using measurement instrumentation employing a CISPR quasi-peak detector. Above 1000 MHz, compliance with the emission limits in Section 15.209 shall be demonstrated based on the average value of the measured emissions. The provisions in Section 15.35 apply to these measurements.

§15.209 (a) Except as provided elsewhere in this subpart, the emissions from an intentional radiator shall not exceed the field strength levels specified in the following table.

§15.209 (a) and RSS-Gen §2.2 Limit Matrix

Frequency(MHz)	Field Strength (μV/m)	Field Strength (dBμV/m)	Measurement Distance (meters)
30-88	100	40.0	3
88-216	150	43.5	3
216-960	200	46.0	3
Above 960	500	54.0	3

Laboratory Measurement Uncertainty for Radiated Emissions

Measurement uncertainty	+5.6/ -4.5 dB
-------------------------	---------------

Traceability

Method	Test Equipment Used
Measurements were made per work instruction WI-03 'Measurement of Radiated Emissions'	0088, 0158, 0134, 0304, 0311, 0315, 0310, 0312

This test report may be reproduced in full only. The document may only be updated by MiCOM Labs personnel. Any changes will be noted in the Document History section of the report.

5.1.8. AC Wireline Conducted Emissions (150 kHz – 30 MHz)

FCC, Part 15 Subpart C §15.207
Industry Canada RSS-Gen §7.2.2

Test Procedure

The EUT is configured in accordance with ANSI C63.4. The conducted emissions are measured in a shielded room with a spectrum analyzer in peak hold in the first instance. Emissions closest to the limit are measured in the quasi-peak mode (QP) with the tuned receiver using a bandwidth of 9 kHz. The emissions are maximized further by cable manipulation. The highest emissions relative to the limit are listed.

Test Measurement Set up

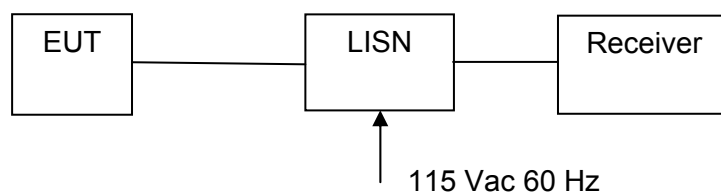

Measurement set up for AC Wireline Conducted Emissions Test

Measurement Results for AC Wireline Conducted Emissions (150 kHz – 30 MHz)

Ambient conditions.

Temperature: 17 to 23 °C Relative humidity: 31 to 57 % Pressure: 999 to 1012 mbar



Title: SP-4700-A
To: FCC 47 CFR Part 15.407 & IC RSS-210
Serial #: TRIL05-U4b Rev A
Issue Date: 23rd May 2012
Page: 87 of 122

Test Freq.	N/A	Engineer	GMH
Variant	AC Line Emissions	Temp (°C)	22
Freq. Range	0.150 MHz - 30 MHz	Rel. Hum.(%)	34
Power Setting	Maximum	Press. (mBars)	1008
Antenna	N/A		
Test Notes 1	Class A		
Test Notes 2			

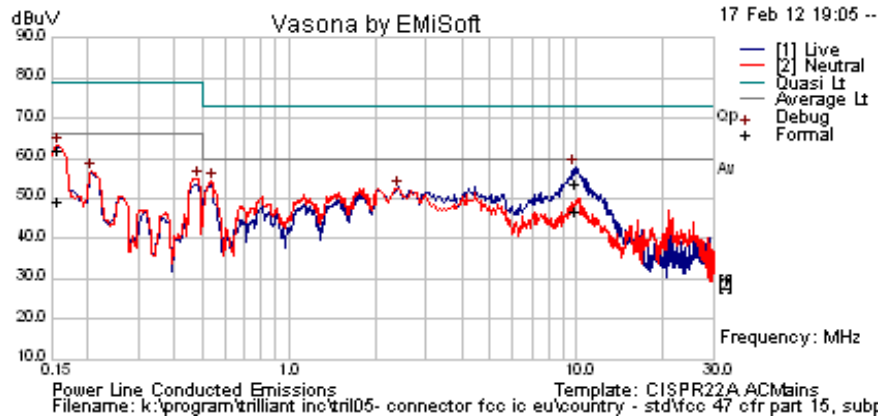

Formally measured emission peaks

Frequency MHz	Raw dBuV	Cable Loss	Factors dB	Level dBuV	Measurement Type	Line	Limit dBuV	Margin dB	Pass /Fail	Comments
0.541	44.1	9.9	0.1	54.1	Peak [Scan]	Neutral	60.0	-5.9	Pass	
0.483	44.8	9.9	0.1	54.8	Peak [Scan]	Neutral	66.0	-11.2	Pass	
2.404	42.2	10.1	0.1	52.4	Peak [Scan]	Neutral	60	-7.7	Pass	
0.206	46.7	9.9	0.1	56.6	Peak [Scan]	Neutral	66	-9.4	Pass	
9.912	42.8	10.3	0.4	53.5	Quasi Peak	Live	73	-19.5	Pass	
0.157	51.8	9.9	0.1	61.7	Quasi Peak	Neutral	79	-17.3	Pass	
9.912	36.1	10.3	0.4	46.8	Average	Live	60	-13.2	Pass	
0.157	39.4	9.9	0.1	49.3	Average	Neutral	66	-16.7	Pass	

Legend: DIG = Digital Device Emission; TX = Transmitter Emission; FUND = Fundamental Frequency
 NRB = Non-Restricted Band, Limit is 20 dB below Fundamental; RB = Restricted Band

This test report may be reproduced in full only. The document may only be updated by MiCOM Labs personnel. Any changes will be noted in the Document History section of the report.



Specification

Limit

§15.207 (a) Except as shown in paragraphs (b) and (c) of this section, for an intentional radiator that is designed to be connected to the public utility (AC) power line, the radio frequency voltage that is conducted back onto the AC power line on any frequency or frequencies within the band 150 kHz to 30 MHz shall not exceed the limits in the following table, as measured using a 50 $\mu\Omega$ line impedance stabilization network (LISN), see §15.207 (a) matrix below. Compliance with the provisions of this paragraph shall be based on the measurement of the radio frequency voltage between each power line and ground at the power terminal.

RSS-Gen §7.2.2

The radio frequency voltage that is conducted back into the AC power lines in the frequency range of 0.15 MHz to 30 MHz shall not exceed the limits shown in the table below. The tighter limit applies at the frequency range boundaries.

§15.207 (a) and RSS-Gen §7.2.2 Limit Matrix

The lower limit applies at the boundary between frequency ranges

Frequency of Emission (MHz)	Conducted Limit (dB μ V)	
	Quasi-peak	Average
0.15-0.5	66 to 56*	56 to 46*
0.5-5	56	46
5-30	60	50

* Decreases with the logarithm of the frequency

Laboratory Measurement Uncertainty for Conducted Emissions

Measurement uncertainty	± 2.64 dB
-------------------------	---------------

Traceability

Method	Test Equipment Used
Measurements were made per work instruction WI-EMC-01 'Measurement of Conducted Emissions'	0158, 0184, 0287, 0190, 0293, 0307

This test report may be reproduced in full only. The document may only be updated by MiCOM Labs personnel. Any changes will be noted in the Document History section of the report.



Title: SP-4700-A
To: FCC 47 CFR Part 15.407 & IC RSS-210
Serial #: TRIL05-U4b Rev A
Issue Date: 23rd May 2012
Page: 89 of 122

5.1.9. DFS (Dynamic Frequency Selection)

5.1.9.1. Test Procedure and Setup

FCC, Part 15 Subpart C §15.407(h)
FCC 06-96 Memorandum Opinion and Order
Industry Canada RSS-210 A9.4

5.1.9.1.1. Interference Threshold values, Master or Client incorporating In-Service Monitoring

Maximum Transmit Power	Value (see note)
≥ 200 milliwatt	-64 dBm
< 200 milliwatt	-62 dBm
Note 1: This is the level at the input of the receiver assuming a 0 dBi receive antenna	

5.1.9.1.2. DFS Response requirement values

Parameter	Value
<i>Non-occupancy period</i>	Minimum 30 minutes
<i>Channel Availability Check Time</i>	60 seconds
<i>Channel Move Time</i>	10 seconds See Note 1.
<i>Channel Closing Transmission Time</i>	200 milliseconds + an aggregate of 60 milliseconds over remaining 10 second period. See Notes 1 and 2.
<i>U-NII Detection Bandwidth</i>	Minimum 80% of the 99% power bandwidth See Note 3.

Note 1: The instant that the *Channel Move Time* and the *Channel Closing Transmission Time* begins is as follows:

- For the Short pulse radar Test Signals this instant is the end of the *Burst*.
- For the Frequency Hopping radar Test Signal, this instant is the end of the last radar *Burst* generated.
- For the Long Pulse radar Test Signal this instant is the end of the 12 second period defining the radar transmission.

Note 2: The *Channel Closing Transmission Time* is comprised of 200 milliseconds starting at the beginning of the *Channel Move Time* plus any additional intermittent control signals required to facilitate *Channel* changes (an aggregate of 60 milliseconds) during the remainder of the 10 second period. The aggregate duration of control signals will not count quiet periods in between transmissions.

Note 3: During the *U-NII Detection Bandwidth* detection test, radar type 1 is used and for each frequency step the minimum percentage of detection is 90%. Measurements are performed with no data traffic.

This test report may be reproduced in full only. The document may only be updated by MiCOM Labs personnel. Any changes will be noted in the Document History section of the report.



5.1.9.1.3. Radar Test Waveforms

This section provides the parameters for required test waveforms, minimum percentage of successful detections, and the minimum number of trials that must be used for determining DFS conformance. Step intervals of 0.1 microsecond for Pulse Width, 1 microsecond for PRI, 1 MHz for chirp width and 1 for the number of pulses will be utilized for the random determination of specific test waveforms.

Short Pulse Radar Test Waveforms

Radar Type	Pulse Width (μsec)	PRI (μsec)	Number of Pulses	Minimum Percentage of Successful Detection	Minimum Trials
1	1	1428	18	60%	30
2	1-5	150-230	23-29	60%	30
3	6-10	200-500	16-18	60%	30
4	11-20	200-500	12-16	60%	30
Aggregate (Radar Types 1-4)				80%	120

A minimum of 30 unique waveforms are required for each of the short pulse radar types 2 through 4. For short pulse radar type 1, the same waveform is used a minimum of 30 times. If more than 30 waveforms are used for short pulse radar types 2 through 4, then each additional waveform must also be unique and not repeated from the previous waveforms. The aggregate is the average of the percentage of successful detections of short pulse radar types 1-4.

Long Pulse Radar Test Waveform

Radar Type	Pulse Width (μsec)	Chirp Width (MHz)	PRI (μsec)	Number of Pulses per Burst	Number of Bursts	Minimum Percentage of Successful Detection	Minimum Trials
5	50-100	5-20	1000-2000	1-3	8-20	80%	30

The parameters for this waveform are randomly chosen. Thirty unique waveforms are required for the Long Pulse radar test signal. If more than 30 waveforms are used for the Long Pulse radar test signal, then each additional waveform must also be unique and not repeated from the previous waveforms.



Title: SP-4700-A
To: FCC 47 CFR Part 15.407 & IC RSS-210
Serial #: TRIL05-U4b Rev A
Issue Date: 23rd May 2012
Page: 91 of 122

Each waveform is defined as follows:

- 1) The transmission period for the Long Pulse Radar test signal is 12 seconds.
- 2) There are a total of 8 to 20 *Bursts* in the 12 second period, with the number of *Bursts* being randomly chosen. This number is *Burst Count*.
- 3) Each *Burst* consists of 1 to 3 pulses, with the number of pulses being randomly chosen. Each *Burst* within the 12 second sequence may have a different number of pulses.
- 4) The pulse width is between 50 and 100 microseconds, with the pulse width being randomly chosen. Each pulse within a *Burst* will have the same pulse width. Pulses in different *Bursts* may have different pulse widths.
- 5) Each pulse has a linear FM chirp between 5 and 20 MHz, with the chirp width being randomly chosen. Each pulse within a *Burst* will have the same chirp width. Pulses in different *Bursts* may have different chirp widths. The chirp is centered on the pulse. For example, with a radar frequency of 5300 MHz and a 20 MHz chirped signal, the chirp starts at 5290 MHz and ends at 5310 MHz.
- 6) If more than one pulse is present in a *Burst*, the time between the pulses will be between 1000 and 2000 microseconds, with the time being randomly chosen. If three pulses are present in a *Burst*, the time between the first and second pulses is chosen independently of the time between the second and third pulses.
- 7) The 12 second transmission period is divided into even intervals. The number of intervals is equal to *Burst_Count*. Each interval is of length $(12,000,000 / \textit{Burst_Count})$ microseconds. Each interval contains one *Burst*. The start time for the *Burst*, relative to the beginning of the interval, is between 1 and $[(12,000,000 / \textit{Burst_Count}) - (\textit{Total Burst Length}) + (\textit{One Random PRI Interval})]$ microseconds, with the start time being randomly chosen. The step interval for the start time is 1 microsecond. The start time for each *Burst* is chosen independently.

This test report may be reproduced in full only. The document may only be updated by MiCOM Labs personnel. Any changes will be noted in the Document History section of the report.

A representative example of a Long Pulse radar test waveform:

- 1) The total test signal length is 12 seconds.
- 2) 8 *Bursts* are randomly generated for the *Burst_Count*.
- 3) *Burst 1* has 2 randomly generated pulses.
- 4) The pulse width (for both pulses) is randomly selected to be 75 microseconds.
- 5) The PRI is randomly selected to be at 1213 microseconds.
- 6) *Bursts 2* through 8 are generated using steps 3 – 5.
- 7) Each *Burst* is contained in even intervals of 1,500,000 microseconds. The starting location for Pulse 1, *Burst 1* is randomly generated (1 to 1,500,000 minus the total *Burst 1* length + 1 random PRI interval) at the 325,001 microsecond step. *Bursts 2* through 8 randomly fall in successive 1,500,000 microsecond intervals (i.e. *Burst 2* falls in the 1,500,001 – 3,000,000 microsecond range).

Graphical representation of the Long Pulse radar Test Waveform.

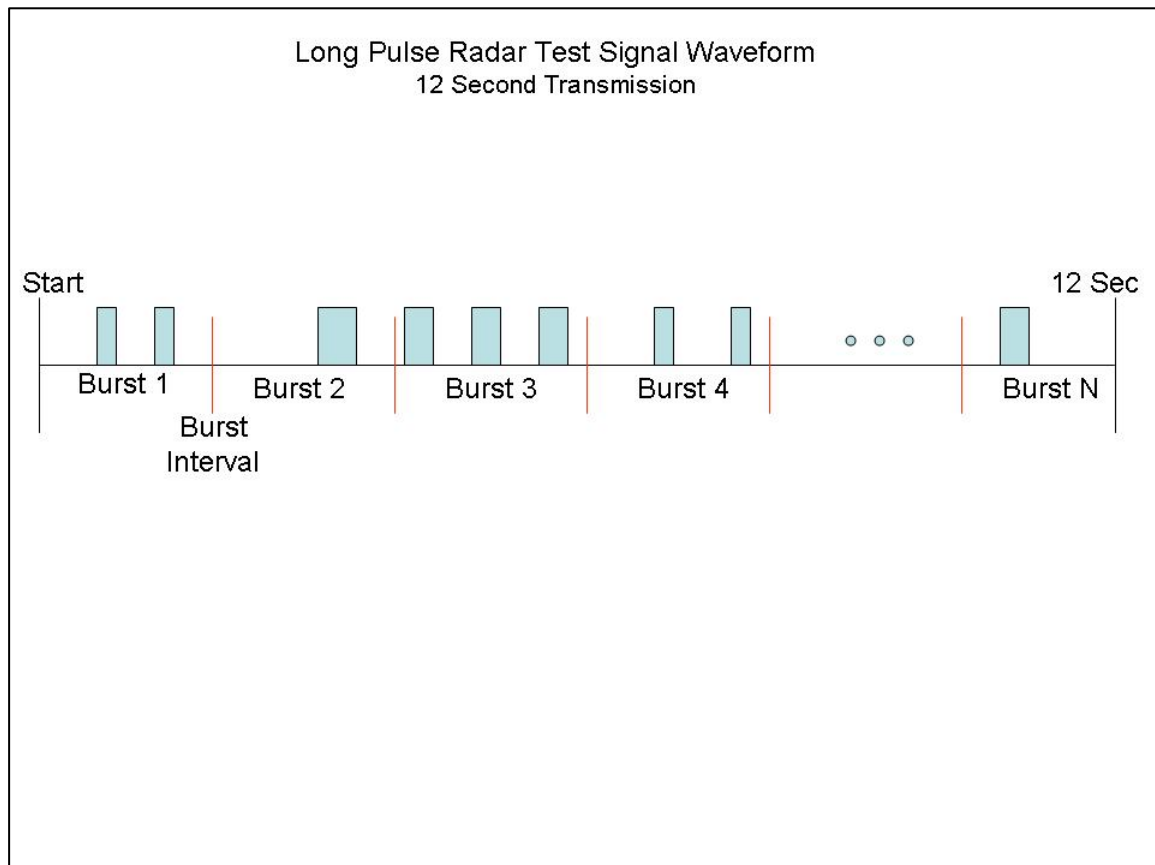

5.1.9.1.4. Frequency Hopping Radar Test Waveform

Frequency Hopping Radar Test Waveform

Radar Type	Pulse Width (µsec)	PRI (µsec)	Pulses per Hop	Hopping Rate (kHz)	Hopping Sequence Length (msec)	Minimum Percentage of Successful Detection	Minimum Trials
6	1	333	9	.333	300	70%	30

For the Frequency Hopping Radar Type, the same *Burst* parameters are used for each waveform. The hopping sequence is different for each waveform and a 100-length segment is selected from the hopping sequence defined by the following algorithm:

5.1.9.1.5. Radar Waveform Calibration

The following equipment setup was used to calibrate the conducted Radar Waveform. A spectrum analyzer was used to establish the test signal level for each radar type. During this process there were no transmissions by either the Master or Client Device. The spectrum analyzer was switched to the zero span (Time Domain) mode at the frequency of the Radar Waveform generator. Peak detection was utilized. The spectrum analyzer resolution bandwidth (RBW) and video bandwidth (VBW) were set to 3 MHz.

The signal generator amplitude was set so that the power level measured at the spectrum analyzer was -61dBm (Ref Section 5.1). The 30dB amplifier gain was entered as an amplitude offset on the spectrum analyzer.

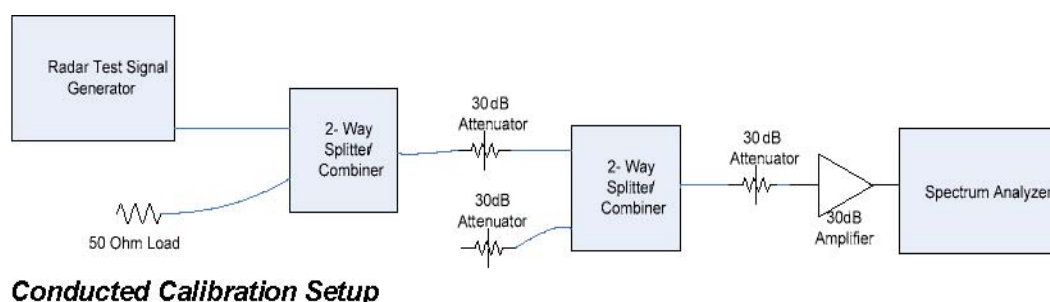



5.1.9.1.6. Weather Radar Band Edge Plots

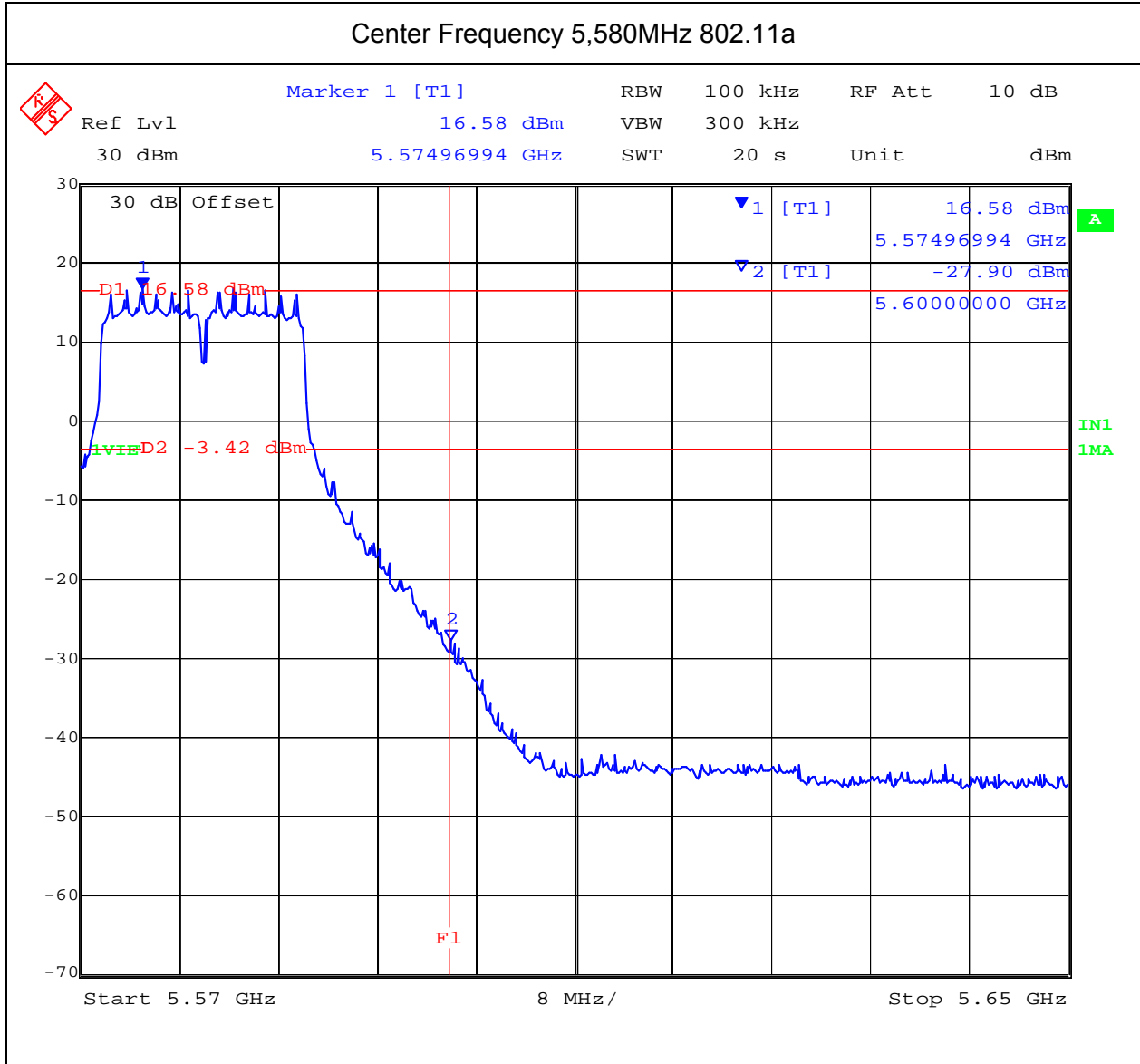

This test report may be reproduced in full only. The document may only be updated by MiCOM Labs personnel. Any changes will be noted in the Document History section of the report.

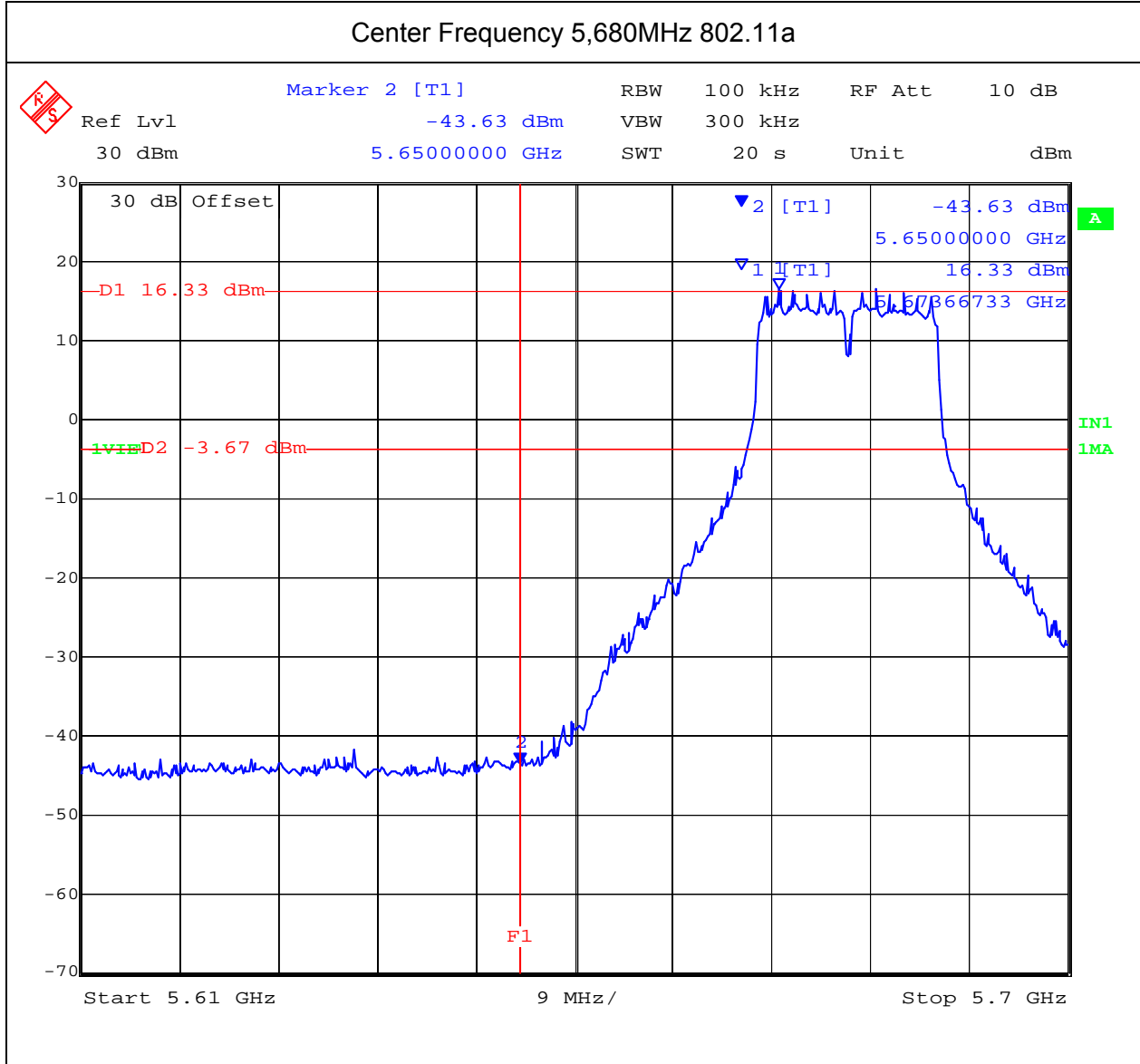

This test report may be reproduced in full only. The document may only be updated by MiCOM Labs personnel. Any changes will be noted in the Document History section of the report.

5.1.9.1.7. Block Diagram(s) of Test Setup

Block Diagram(s) of Test Setup

Setup for Conducted Measurements where the EUT is the Master with injection of Radar Test Waveforms at the Master.

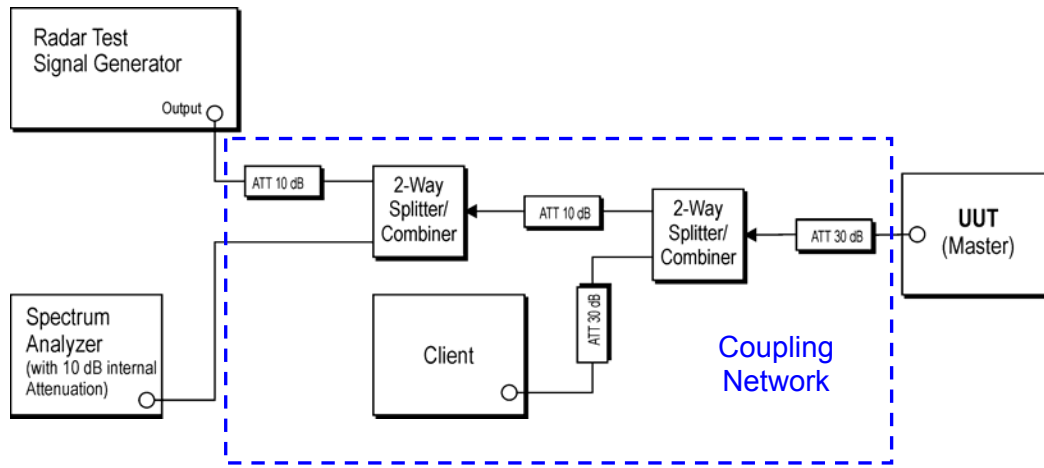

Support Equipment Configuration

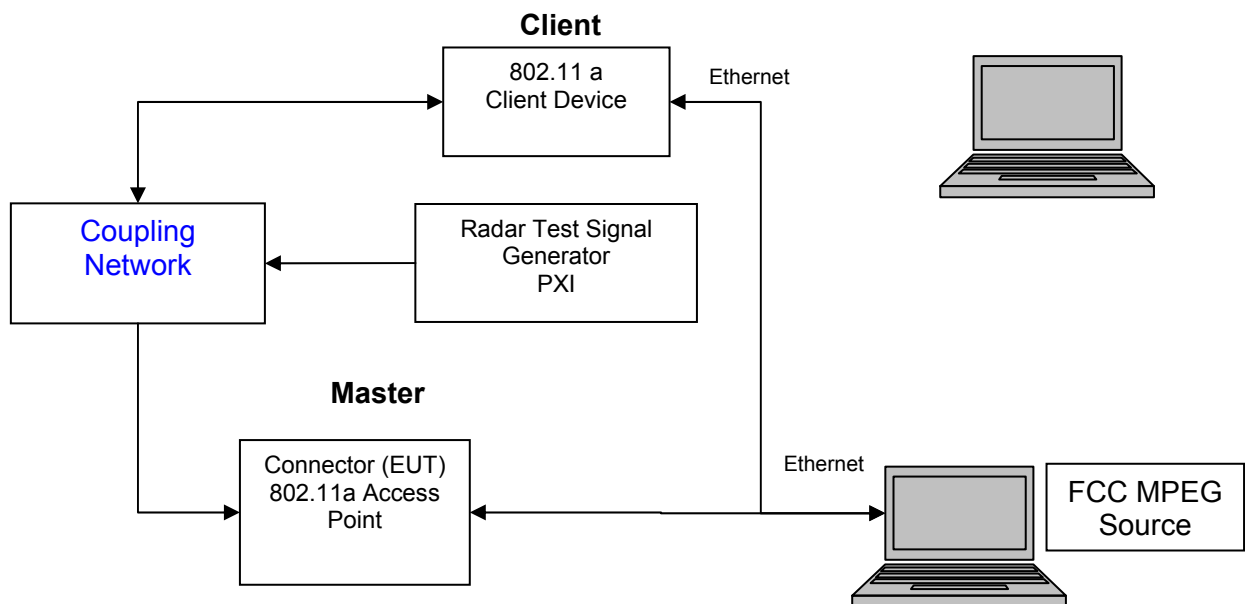

This test report may be reproduced in full only. The document may only be updated by MiCOM Labs personnel. Any changes will be noted in the Document History section of the report.



The EUT is a Master Device with radar detection.

Applicability of DFS Requirements Prior to Use of a Channel
(Ref Table 1 of FCC 06-96)

Requirement	Operational Mode		
	Master	Client Without Radar Detection	Client With Radar Detection
<i>Non-Occupancy Period</i>	Yes	Not required	Yes
<i>DFS Detection Threshold</i>	Yes	Not required	Yes
<i>Channel Availability Check Time</i>	Yes	Not required	Not required
<i>Uniform Spreading</i>	Yes	Not required	Not required
<i>U-NII Detection Bandwidth</i>	Yes	Not required	Yes

Applicability of DFS requirements during normal operation
(Ref Table 2 of FCC 06-96)

Requirement	Operational Mode		
	Master	Client Without Radar Detection	Client With Radar Detection
<i>DFS Detection Threshold</i>	Yes	Not required	Yes
<i>Channel Closing Transmission Time</i>	Yes	Yes	Yes
<i>Channel Move Time</i>	Yes	Yes	Yes
<i>U-NII Detection Bandwidth</i>	Yes	Not required	Yes

This test report may be reproduced in full only. The document may only be updated by MiCOM Labs personnel. Any changes will be noted in the Document History section of the report.



Title: SP-4700-A
To: FCC 47 CFR Part 15.407 & IC RSS-210
Serial #: TRIL05-U4b Rev A
Issue Date: 23rd May 2012
Page: 98 of 122

For the frequency band 5,470 – 5,725 MHz, the Master device provides, on aggregate, uniform loading of the spectrum across all devices by selecting an operating channel among the available channels using a random algorithm. The EUT was tested in 11a mode.

Declared minimum antenna gain 17 dBi. ;

Radar receive signal level = -64 dBm + minimum antenna gain + 1 dB

$$= -64 + 17 + 1$$

Radar receive signal level = -46 dBm

Measurement Results - Dynamic Frequency Selection (DFS)

Ambient conditions.

Temperature: 17 to 23 °C Relative humidity: 31 to 57% Pressure: 999 to 1012 mbar

Radio parameters.

Test methodology: Conducted

Device Type: Master

Transmit Power: Maximum

Operational Details - Dynamic Frequency Selection (DFS)

Operational Modes: 802.11a

Data Rates: 18mpbs 802.11a

**Note* No video pixilation was observed during the video stream at these rates. Video frames per second were noted to be at 30fps.*

Video Streaming Method - Dynamic Frequency Selection (DFS)

Using the VideoLan player a video stream was setup on the master laptop with the destination being the client laptop. The video profile chosen for the video stream is "MPEG-2 + MPGA (TS)". On the client laptop the VideoLan player was setup to listen to an incoming video stream from the master device.

The requisite MPEG video file ("TestFile.mpg" available on the NTIA website at the following link <http://ntiacsd.ntia.doc.gov/dfs/>) is used during this video stream.

This test report may be reproduced in full only. The document may only be updated by MiCOM Labs personnel. Any changes will be noted in the Document History section of the report.



Title: SP-4700-A
To: FCC 47 CFR Part 15.407 & IC RSS-210
Serial #: TRIL05-U4b Rev A
Issue Date: 23rd May 2012
Page: 99 of 122

5.1.9.2. Dynamic Frequency Selection (DFS) Test Results

5.1.9.2.1. UNII Detection Bandwidth:

All UNII channels for this device have identical channel bandwidths and DFS testing was completed on channel 5,500 MHz (802.11a).

The generating equipment is configured as shown in the Conducted Test Setup above. A single Burst of the short pulse radar Type 1 through 6 was produced at 5,500 MHz (802.11a) at a level of -46 dBm. The EUT is set up as a standalone device (no associated Client and no traffic).

A single radar Burst is generated for a minimum of 10 trials, and the response of the EUT is noted. The EUT must detect the Radar Waveform 90% or more of the time.

The radar frequency is increased in 1 MHz steps, repeating the above test sequence, until the detection rate falls below 90%. The highest frequency at which detection is greater than or equal to 90% is denoted as F_H .

The radar frequency is decreased in 1 MHz steps, repeating the above test sequence, until the detection rate falls below 90%. The lowest frequency at which detection is greater than or equal to 90% is denoted as F_L .

The U-NII Detection Bandwidth is calculated as follows:

$$\text{U-NII Detection Bandwidth} = F_H - F_L$$

The U-NII Detection Bandwidth must be at least 80% of the EUT transmitter 99% power Table of results are continued on the next page.

This test report may be reproduced in full only. The document may only be updated by MiCOM Labs personnel. Any changes will be noted in the Document History section of the report.



Title: SP-4700-A
To: FCC 47 CFR Part 15.407 & IC RSS-210
Serial #: TRIL05-U4b Rev A
Issue Date: 23rd May 2012
Page: 100 of 122

EUT Frequency= 5,500 MHz 802.11a (Detection = √, No Detection = 0)											
Radar Frequency (MHz)	1	2	3	4	5	6	7	8	9	10	Detection Rate (%)
-18											%
-17											%
-16											%
-15											%
-14											%
-13											%
-12											%
-11	√	0	0								<90%
-10	√	√	√	√	√	√	√	0	√	√	90%
-9	√	√	√	√	√	√	√	√	√	√	100%
-8	√	√	√	√	√	√	√	√	√	√	100%
-7	√	√	√	√	√	√	√	√	√	√	100%
-6	√	√	√	√	√	√	√	√	√	√	100%
-5	√	√	√	√	√	√	√	√	√	√	100%
-4	√	√	√	√	√	√	√	√	√	√	100%
-3	√	√	√	√	√	√	√	√	√	√	100%
-2	√	√	√	√	√	√	√	√	√	√	100%
-1	√	√	√	√	√	√	√	√	√	√	100%
F ₀	√	√	√	√	√	√	√	√	√	√	100%
+1	√	√	√	√	√	√	√	√	√	√	100%
+2	√	√	√	√	√	√	√	√	√	√	100%
+3	√	√	√	√	√	√	√	√	√	√	100%
+4	√	√	√	√	√	√	√	√	√	√	100%
+5	√	√	√	√	√	√	√	√	√	√	100%
+6	√	√	√	√	√	√	√	√	√	√	100%
+7	√	√	√	√	√	√	√	√	√	√	100%
+8	√	√	√	√	√	√	√	√	√	√	100%
+9	√	√	√	√	√	√	√	√	√	√	100%
+10	√	√	0	√	√	√	√	√	√	√	90%
+11	√	0	√	√	0						<90%
+12											%
+13											%
+14											%
+15											%
+16											%
Detection Bandwidth = F _H -F _L = 5510-5490 = 20 MHz											
EUT 99% Bandwidth = 16.733 MHz (ref. bandwidth channel 5500 MHz)											
16.733 MHz *80% = 13.386 MHz											

For each frequency step the minimum percentage detection is 90%

This test report may be reproduced in full only. The document may only be updated by MiCOM Labs personnel. Any changes will be noted in the Document History section of the report.



Title: SP-4700-A
To: FCC 47 CFR Part 15.407 & IC RSS-210
Serial #: TRIL05-U4b Rev A
Issue Date: 23rd May 2012
Page: 101 of 122

5.1.9.2.2. Initial Channel Availability Check Time

This test verifies that the EUT does not emit pulse, control, or data signals on the test Channel until the power-up sequence has been completed and the U-NII device checks for Radar Waveforms for one minute on the test Channel. This test does not use any Radar Waveforms.

The U-NII device is powered on and be instructed to operate at 5,500MHz 802.11a and. At the same time the EUT is powered on, the spectrum analyzer is set for zero span with a 1 MHz resolution bandwidth at 5,500 MHz with a 260 second sweep time. The analyzer's sweep will be started the same time power is applied to the U-NII device.

The EUT should not transmit any pulse or data transmissions until at least 1 minute after the completion of the power-on cycle.

The first red marker line shown on the following plot denotes the instant when the EUT starts its power-up sequence i.e. T_0 (as defined within the FCC's MO&O 06-96 Normative Reference 2). The power-up reference T_0 is determined by the time it takes for the EUT to start "beaconing" i.e. initial beacon – 60 secs = end of power-up.

The Channel Availability Check Time commences at instant T_0 and will end no sooner than $T_0 + 60$ seconds.



EUT power up and Initial Channel Availability Check Time
5,500MHz 802.11a Power On = 114.72 Seconds

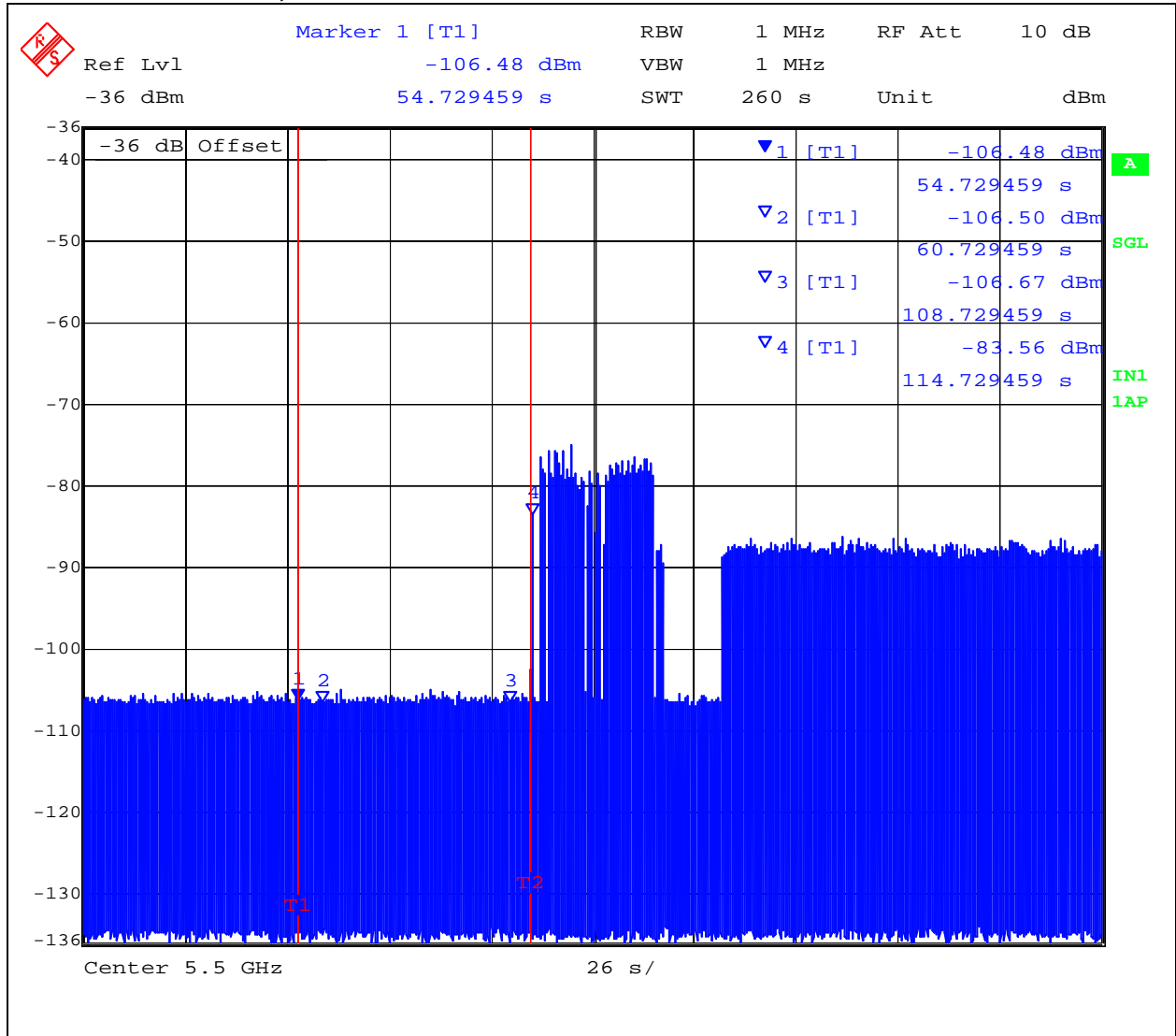

This test report may be reproduced in full only. The document may only be updated by MiCOM Labs personnel. Any changes will be noted in the Document History section of the report.



Title: SP-4700-A
To: FCC 47 CFR Part 15.407 & IC RSS-210
Serial #: TRIL05-U4b Rev A
Issue Date: 23rd May 2012
Page: 103 of 122

5.1.10. Radar Burst at the Beginning of the Channel Availability Check Time:

The steps below define the procedure to verify successful radar detection on the selected Channel during a period equal to the Channel Availability Check Time and avoidance of operation on that Channel when a radar Burst with a level equal to the DFS Detection Threshold +6 dB (-46 dBm Ref Section 6.1.7) occurs at the beginning of the Channel Availability Check Time.

A single Burst of short pulse of radar Type 1 will commence within a 6 second window starting at T_0 (first red marker line on the following plot).

Visual indication on the EUT of successful detection of the radar Burst will be recorded and reported. Observation of emissions at 5,500MHz 802.11a will continue for 2.5 minutes after the radar burst has been generated.

This test report may be reproduced in full only. The document may only be updated by MiCOM Labs personnel. Any changes will be noted in the Document History section of the report.



**Channel Availability Check Time at the start T0 + 6 seconds Check Time
5,500MHz 802.11a**

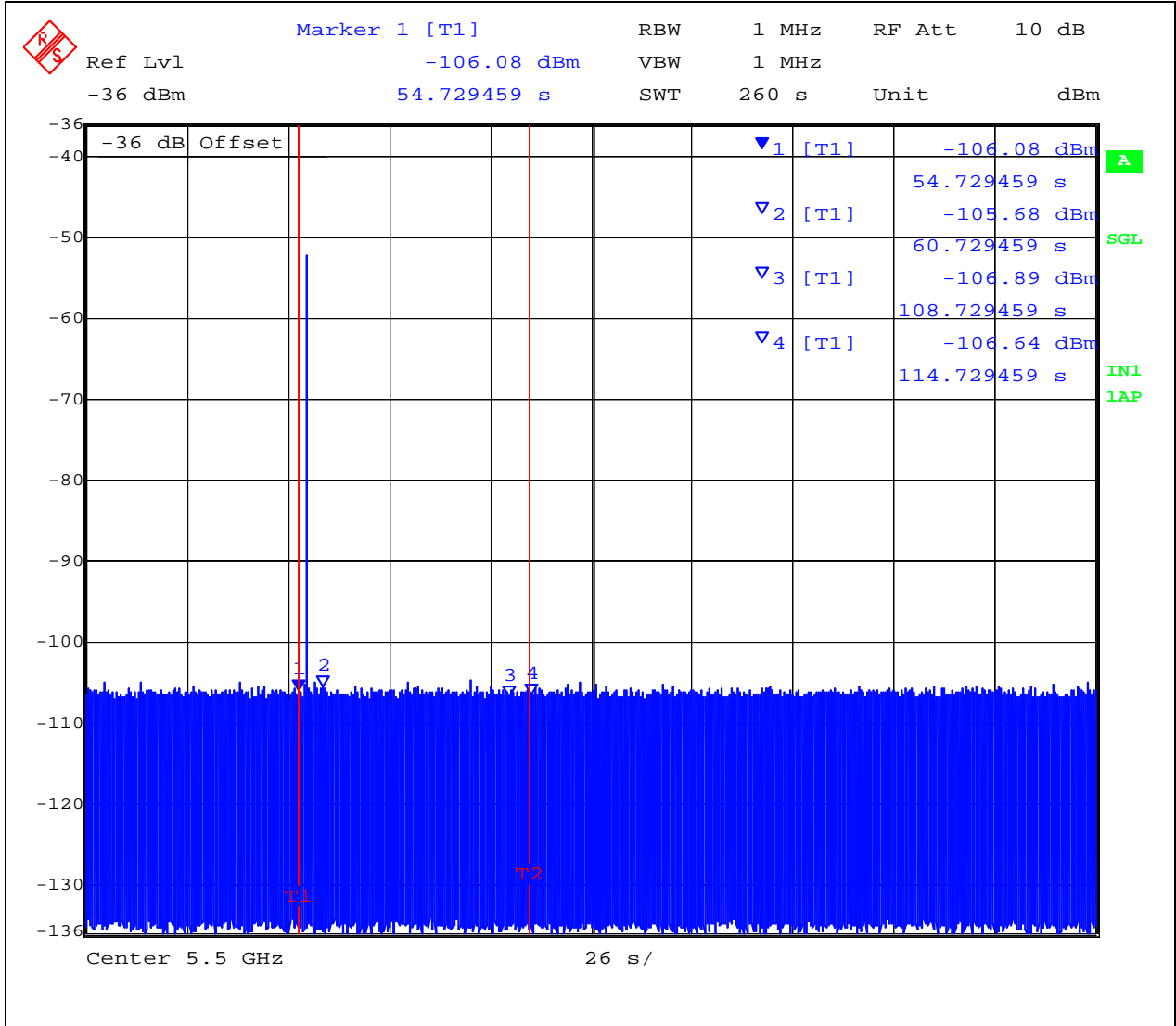

This test report may be reproduced in full only. The document may only be updated by MiCOM Labs personnel. Any changes will be noted in the Document History section of the report.



Title: SP-4700-A
To: FCC 47 CFR Part 15.407 & IC RSS-210
Serial #: TRIL05-U4b Rev A
Issue Date: 23rd May 2012
Page: 105 of 122

5.1.11. Radar Burst at the End of the Channel Availability Check Time:

The steps below define the procedure to verify successful radar detection on the selected Channel during a period equal to the Channel Availability Check Time and avoidance of operation on that Channel when a radar Burst with a level equal to the DFS Detection Threshold occurs at the end of the Channel Availability Check Time.

A single Burst of short pulse of radar type 1 will commence within a 6 second window starting at $T_0 + 54$ seconds. The window will commence at marker 2 and end at the red frequency line T_2 .

Visual indication on the EUT of successful detection of the radar Burst will be recorded and reported. Observation of emissions at 5,500MHz 802.11a will continue for 2.5 minutes after the radar burst has been generated.

This test report may be reproduced in full only. The document may only be updated by MiCOM Labs personnel. Any changes will be noted in the Document History section of the report.



Channel Availability Check Time at T0 + 54 seconds Check Time
5,500MHz 802.11a

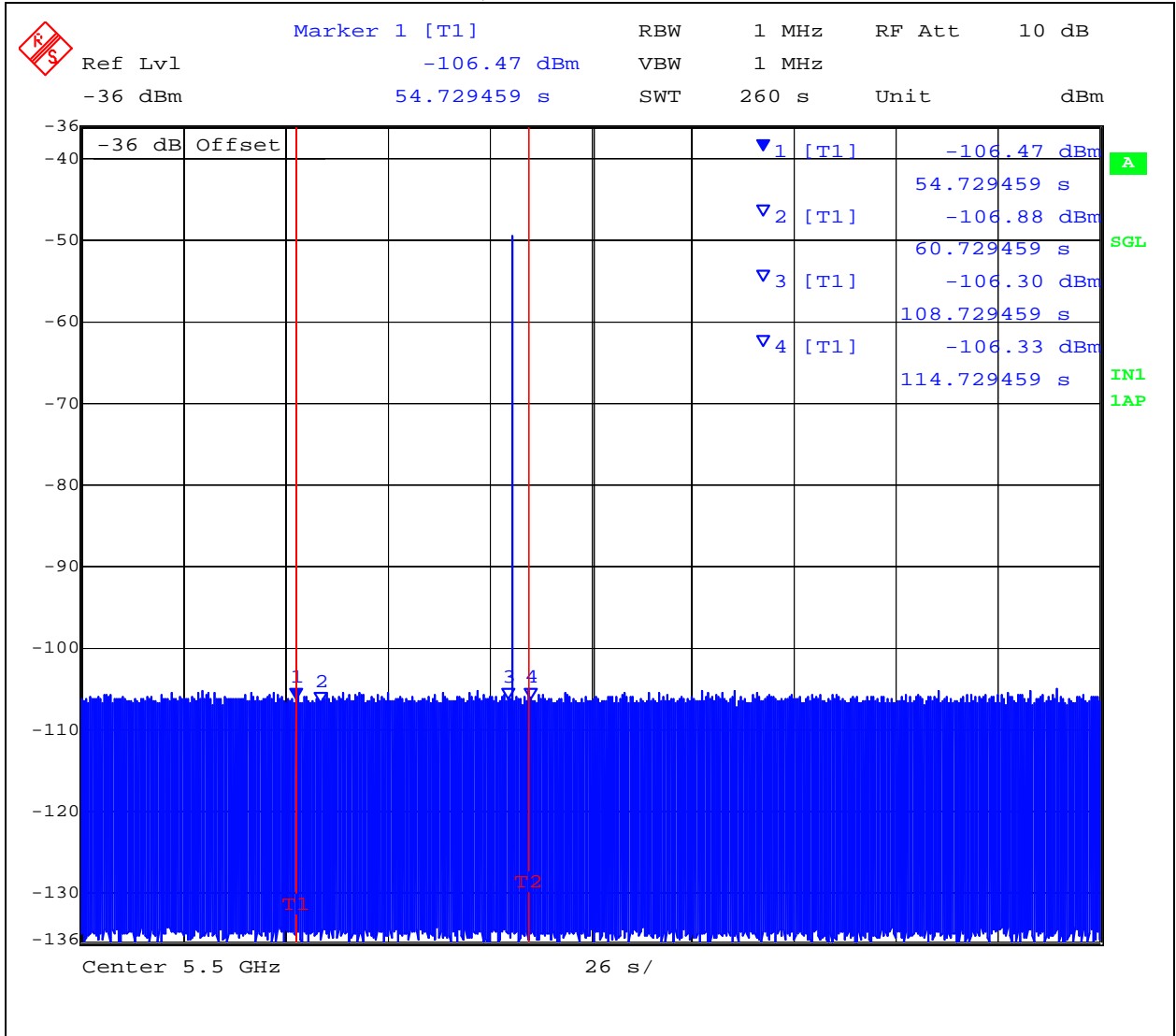

This test report may be reproduced in full only. The document may only be updated by MiCOM Labs personnel. Any changes will be noted in the Document History section of the report.



Title: SP-4700-A
To: FCC 47 CFR Part 15.407 & IC RSS-210
Serial #: TRIL05-U4b Rev A
Issue Date: 23rd May 2012
Page: 107 of 122

5.1.12. In-Service Monitoring for Channel Move Time, Channel Closing Transmission Time and Non-Occupancy Period

FCC §15.407(h)(2)(iii)

The steps below define the procedure to determine the above mentioned parameters when a radar Burst with a level equal to the DFS Detection Threshold is generated on the Operating Channel of the U-NII device.

A U-NII device operating as a Client Device will associate with the EUT (Master). The requisite MPEG video file ("TestFile.mpg" available on the NTIA website at the following link <http://ntiacsd.ntia.doc.gov/dfs/>) is streamed from the master device (AP) to the client.

Channel Closing Transmission Time - Measurement

A Type 1 waveform was introduced to the EUT, from which a 12 second transmission record was digitally captured, collecting nearly 250M samples of data, which included in excess of 600 ms of pre-trigger data. This Type 1 waveform had an integral marker built into its construction, marking the start of the radar waveform play, which directly triggered the PXI digitizer's data capture via the PXI backplane trigger bus.

The test system was set-up to capture all transmission data for access point events above a threshold level of -50 dBm. The test equipment time stamps all captured events with respect to T_0 (zero time indicating the start of the measurements sequence) starting the 612.1 ms pre-trigger period followed by the radar type 1 burst period.

Radar (Type 1) Pre-trigger period 612.1 ms

Type 1 burst period 25.70 ms

(The period of the 18 pulse burst includes [18 pulses * 1.428mS PRI] = 25.704 ms. Then add 1 μ s pulse width for the final pulse.)

Channel Closing Transmission Time starts immediately after the last radar pulse is transmitted i.e. 637.8 ms after the start of the trace capture period.



Title: SP-4700-A
To: FCC 47 CFR Part 15.407 & IC RSS-210
Serial #: TRIL05-U4b Rev A
Issue Date: 23rd May 2012
Page: 108 of 122

Therefore, pulses seen after this 637.8 ms boundary are identified and totaled to provide an aggregate total of transmissions in order to determine whether the EUT is compliant with the Channel Closing Transmission Time requirements as described in MO&O FCC 06-96. In this case, it was found that an aggregate total of 0.00 ms of transmission time accrued. This value is found at the right hand side at the foot of the following plot (10s Total).

Channel Closing Transmission Time 5,500 MHz = 0.00 mSecs (limit 260 mSecs)

Channel Move Time 5,500MHz = 0.00 Secs (limit 10 Secs)

Channel Move Time, Channel Closing Transmission Time for Type 1 Radar Captured by the Test System - 0 to 2 seconds

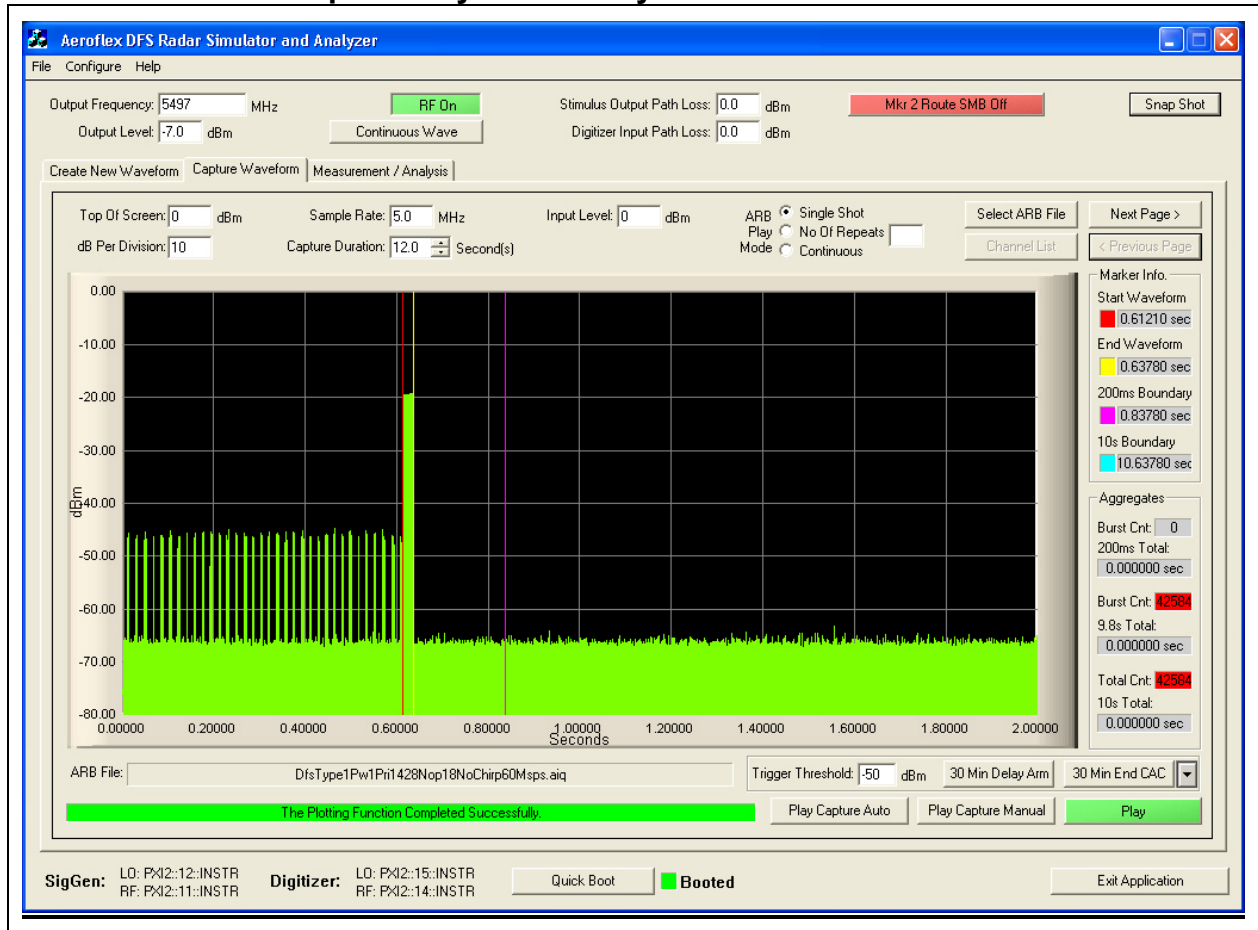

This test report may be reproduced in full only. The document may only be updated by MiCOM Labs personnel. Any changes will be noted in the Document History section of the report.



Title: SP-4700-A
To: FCC 47 CFR Part 15.407 & IC RSS-210
Serial #: TRIL05-U4b Rev A
Issue Date: 23rd May 2012
Page: 109 of 122

Channel Move Time, Channel Closing Transmission Time for Type 1 Radar Captured by the Test System - 2 to 4 seconds

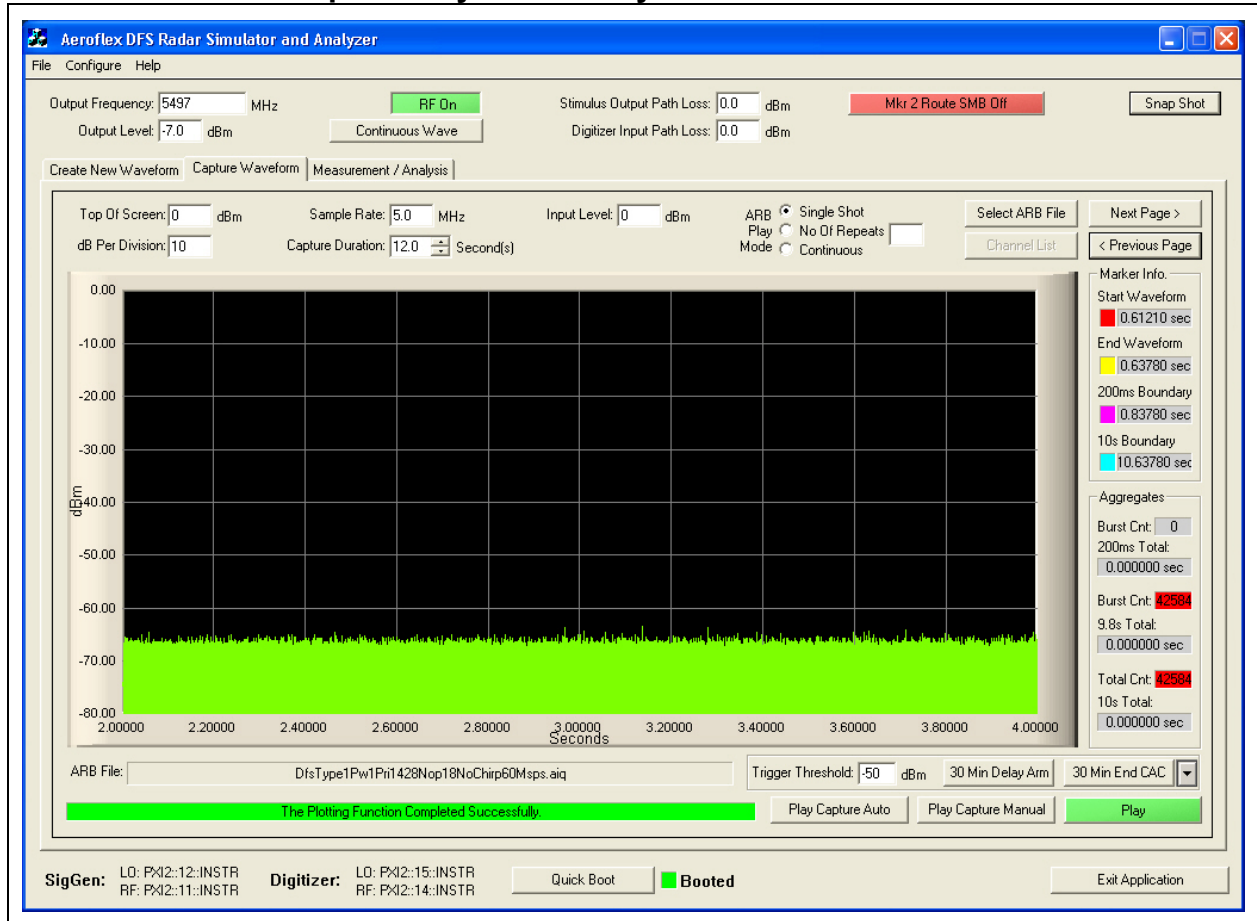

This test report may be reproduced in full only. The document may only be updated by MiCOM Labs personnel. Any changes will be noted in the Document History section of the report.



Title: SP-4700-A
To: FCC 47 CFR Part 15.407 & IC RSS-210
Serial #: TRIL05-U4b Rev A
Issue Date: 23rd May 2012
Page: 110 of 122

Channel Move Time, Channel Closing Transmission Time for Type 1 Radar Captured by the Test System - 4 to 6 seconds

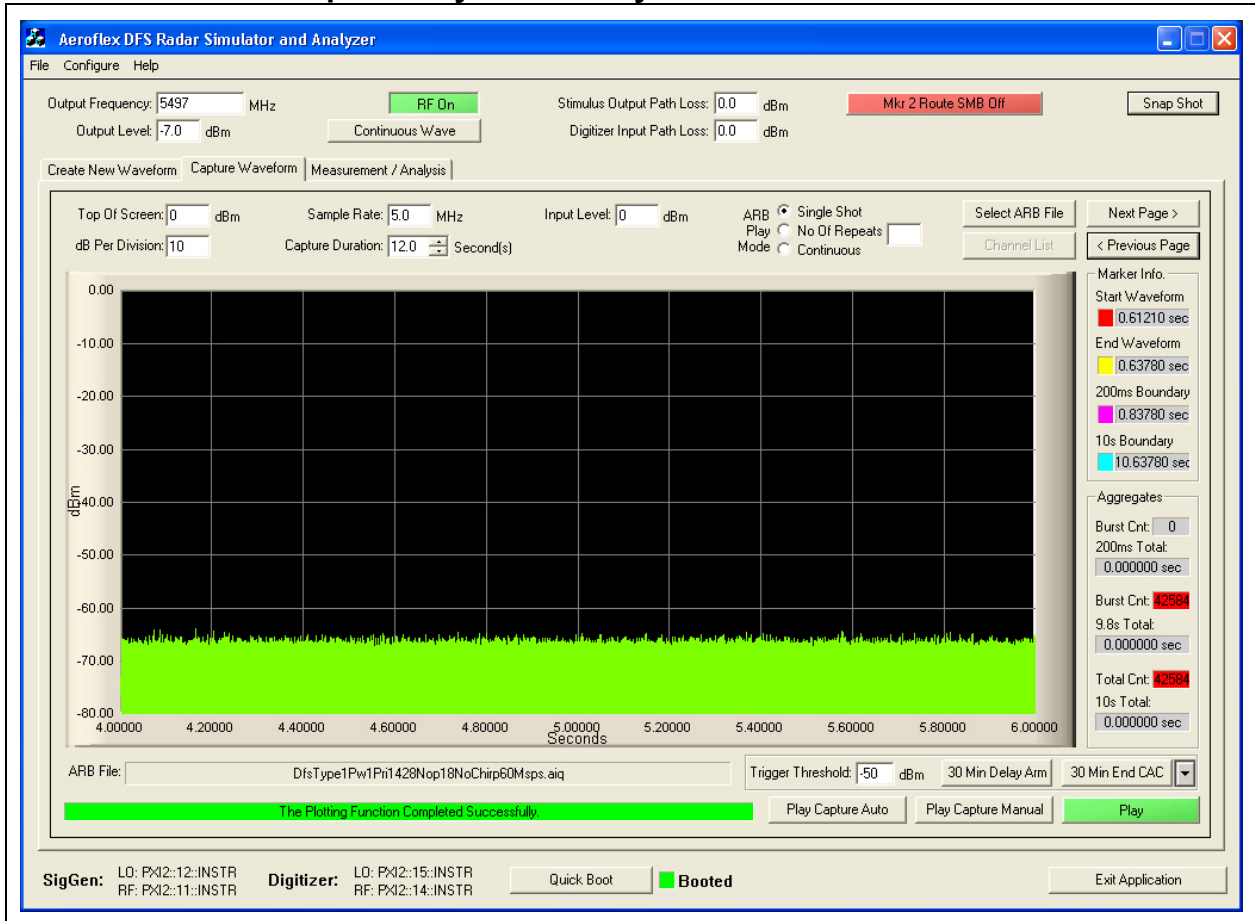

This test report may be reproduced in full only. The document may only be updated by MiCOM Labs personnel. Any changes will be noted in the Document History section of the report.



Title: SP-4700-A
To: FCC 47 CFR Part 15.407 & IC RSS-210
Serial #: TRIL05-U4b Rev A
Issue Date: 23rd May 2012
Page: 111 of 122

Channel Move Time, Channel Closing Transmission Time for Type 1 Radar Captured by the Test System - 6 to 8 seconds

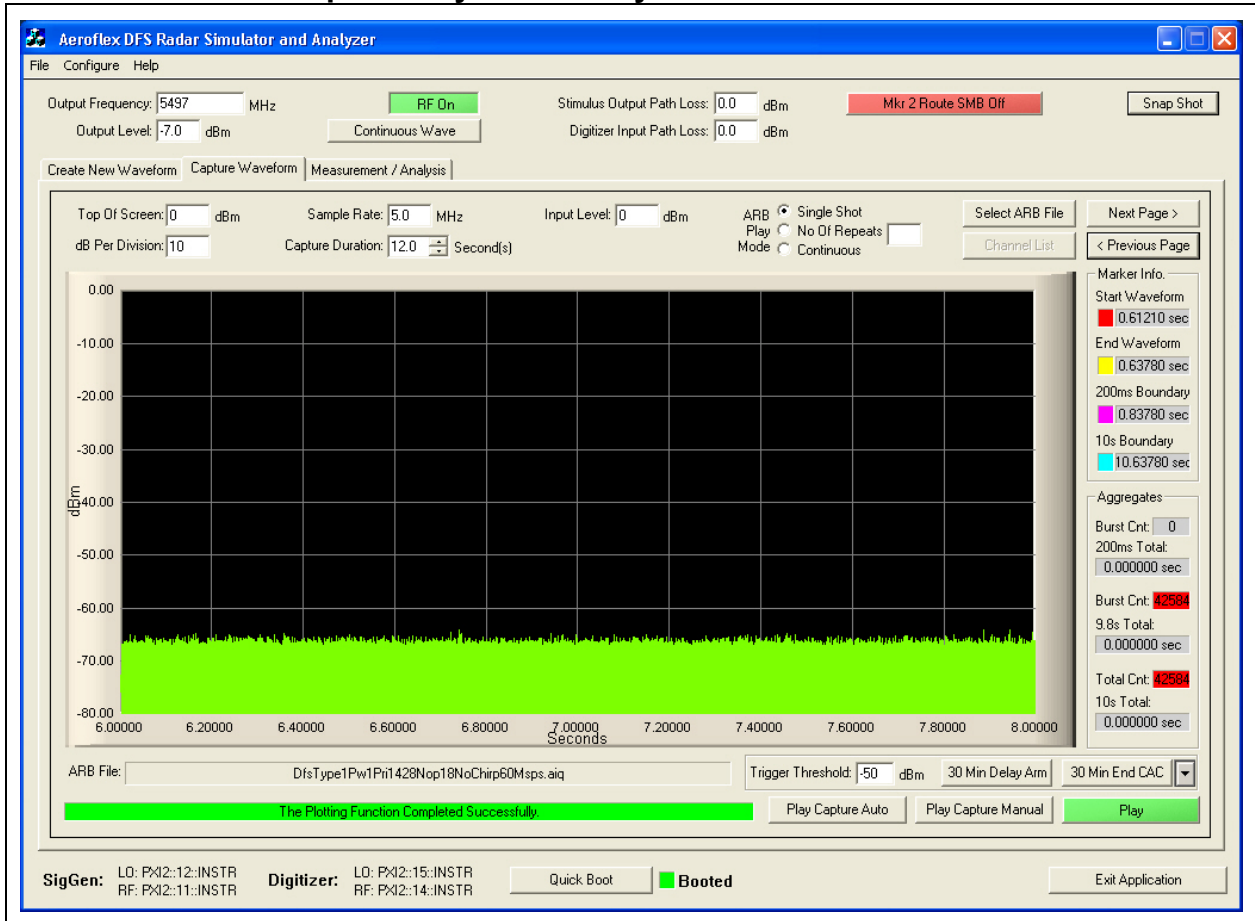

This test report may be reproduced in full only. The document may only be updated by MiCOM Labs personnel. Any changes will be noted in the Document History section of the report.



Title: SP-4700-A
To: FCC 47 CFR Part 15.407 & IC RSS-210
Serial #: TRIL05-U4b Rev A
Issue Date: 23rd May 2012
Page: 112 of 122

Channel Move Time, Channel Closing Transmission Time for Type 1 Radar Captured by the Test System - 8 to 10 seconds

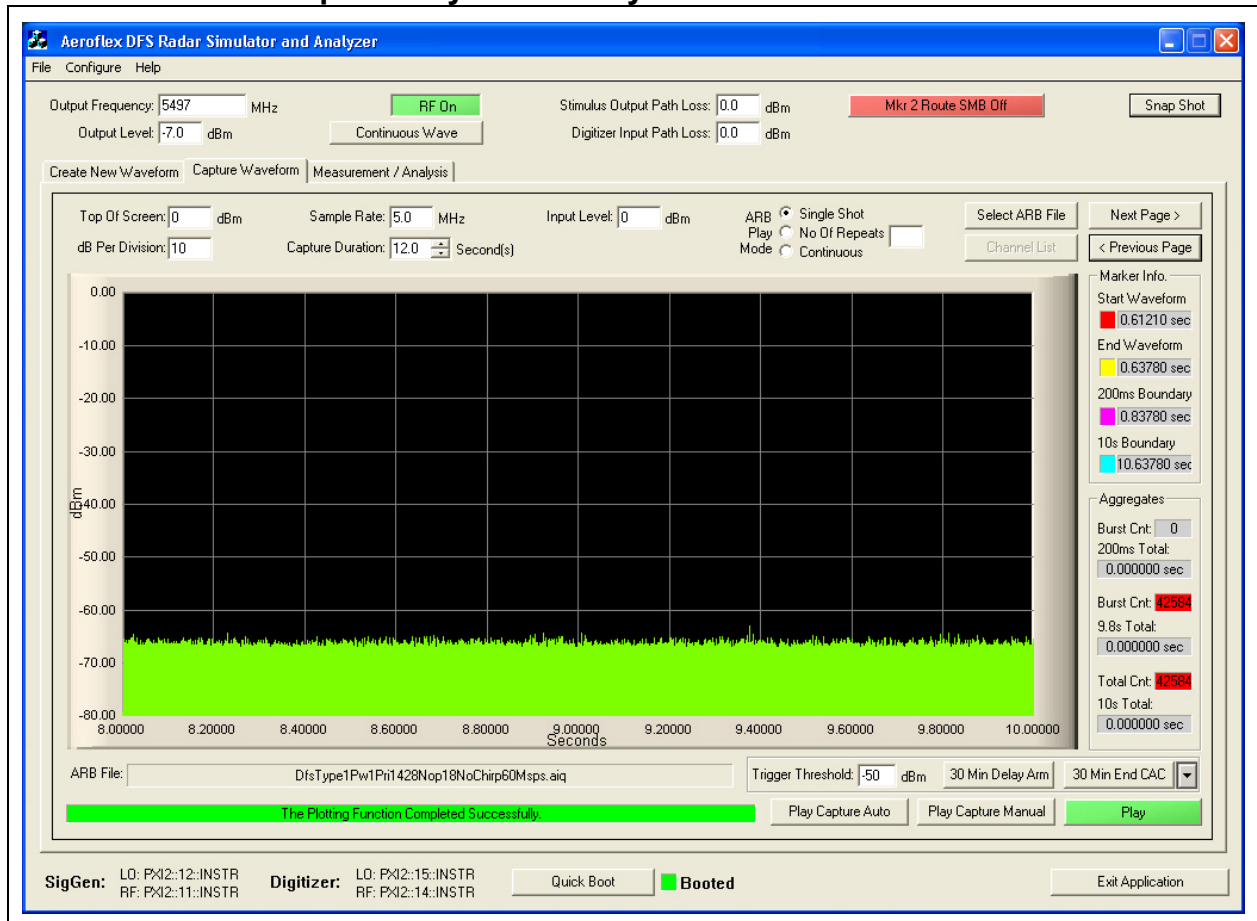

This test report may be reproduced in full only. The document may only be updated by MiCOM Labs personnel. Any changes will be noted in the Document History section of the report.



Title: SP-4700-A
To: FCC 47 CFR Part 15.407 & IC RSS-210
Serial #: TRIL05-U4b Rev A
Issue Date: 23rd May 2012
Page: 113 of 122

Channel Move Time, Channel Closing Transmission Time for Type 1 Radar Captured by the Test System - 10 to 12 seconds

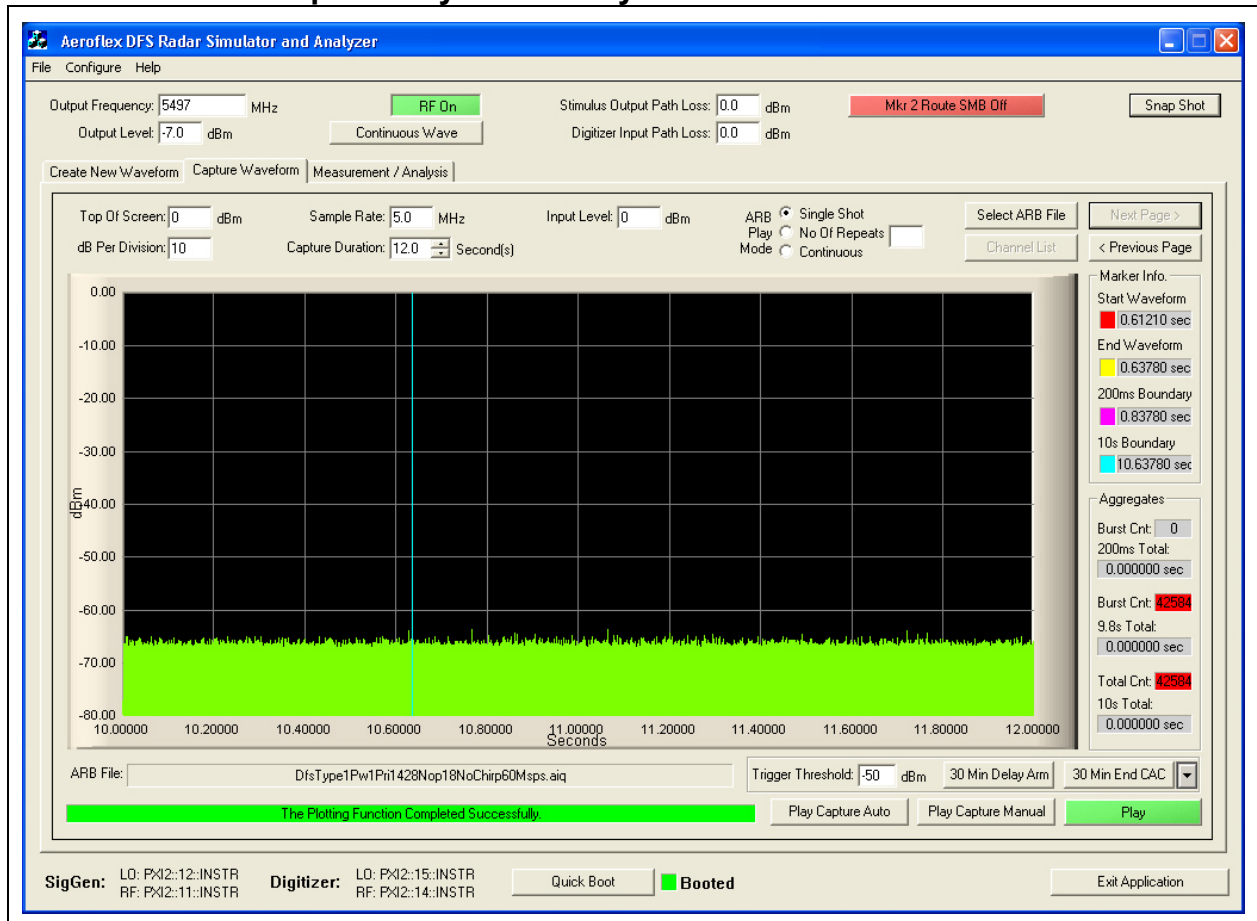

This test report may be reproduced in full only. The document may only be updated by MiCOM Labs personnel. Any changes will be noted in the Document History section of the report.



30 Minute Non-Occupancy Period

The EUT is monitored for more than 30 minutes following the channel close/move time to verify no transmissions resume on this Channel.

30 Minute Non-Occupancy Period Type 1 Radar 5,500MHz 802.11a

	Marker 1 [T1]	RBW	1 MHz	RF Att	10 dB
Ref Lvl	-54.54 dBm	VBW	1 MHz		
-36 dBm	96.192385 s	SWT	2000 s	Unit	dBm

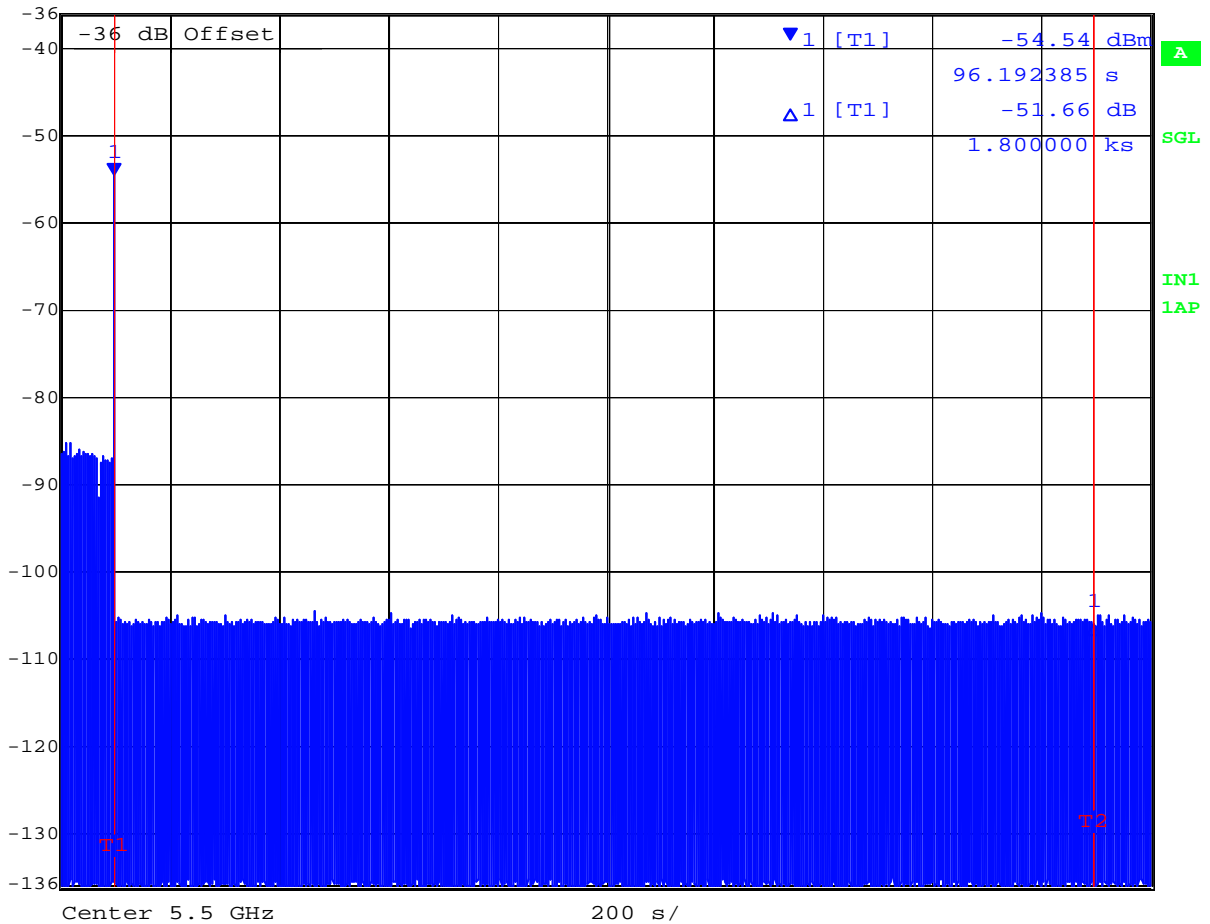

Date: 16.FEB.2012 10:45:39

This test report may be reproduced in full only. The document may only be updated by MiCOM Labs personnel. Any changes will be noted in the Document History section of the report.



Title: SP-4700-A
To: FCC 47 CFR Part 15.407 & IC RSS-210
Serial #: TRIL05-U4b Rev A
Issue Date: 23rd May 2012
Page: 115 of 122

5.1.13. Statistical Performance Check

The steps below define the procedure to determine the minimum percentage of detection when a radar burst with a level equal to the DFS Detection Threshold is generated on the Operating Channel of the U-NII device.

A U-NII device operating as a Client Device will associate with the UUT (Master) at 5,500MHz 802.11a.

The Radar Waveform generator sends the individual waveform for each of the radar types 1-6. Statistical data will be gathered to determine the ability of the device to detect the radar test waveforms. The device can utilize a test mode to demonstrate when detection occurs to prevent the need to reset the device between trial runs. The percentage of successful detection is calculated by:

Total # of detections ÷ Total # of Trials × 100 = Probability of Detection

The Minimum number of trails, minimum percentage of successful detection and the average minimum percentage of successful detection are found in the Radar Test Waveforms section.

This test report may be reproduced in full only. The document may only be updated by MiCOM Labs personnel. Any changes will be noted in the Document History section of the report.



Title: SP-4700-A
To: FCC 47 CFR Part 15.407 & IC RSS-210
Serial #: TRIL05-U4b Rev A
Issue Date: 23rd May 2012
Page: 116 of 122

Verification of Detection 5,500MHz 802.11a

Trial #	Detection = √, No Detection = 0					
	Type 1	Type 2	Type 3	Type 4	Type 5	Type 6
1	√	√	√	√	√	√
2	√	√	√	√	√	√
3	√	√	√	√	√	√
4	√	√	√	√	√	√
5	√	√	√	√	√	√
6	√	√	√	√	√	√
7	√	√	√	√	√	√
8	√	√	√	√	√	√
9	√	√	√	√	√	√
10	√	√	√	√	√	√
11	√	√	√	√	√	√
12	√	0	√	√	√	√
13	√	√	√	√	√	√
14	√	√	√	√	√	√
15	√	√	√	√	√	√
16	√	√	√	√	√	√
17	√	√	√	√	√	√
18	√	√	√	√	√	√
19	√	√	√	√	√	√
20	√	√	√	√	√	√
21	√	√	√	√	√	√
22	√	√	√	√	√	√
23	√	√	√	√	√	√
24	√	√	√	√	√	√
25	√	√	√	√	0	√
26	√	√	0	√	0	√
27	√	√	√	√	√	√
28	√	√	√	√	√	√
29	√	√	√	0	√	√
30	√	√	√	√	√	√
Detection Percentage	100% (>60%)	96.6% (>60%)	96.6% (>60%)	96.6% (>60%)	93.3% (>80%)	100.0% (>70%)

In addition an average minimum percentage of successful detection across all four Short pulse radar test waveforms is required and calculated as follows;

$$(P_{d1} + P_{d2} + P_{d3} + P_{d4}) / 4 = (100\% + 96.6\% + 96.6\% + 96.6\%) / 4 = 97.4\% (> 80\%)$$

This test report may be reproduced in full only. The document may only be updated by MiCOM Labs personnel. Any changes will be noted in the Document History section of the report.



Title: SP-4700-A
To: FCC 47 CFR Part 15.407 & IC RSS-210
Serial #: TRIL05-U4b Rev A
Issue Date: 23rd May 2012
Page: 117 of 122

Measurement Uncertainty Time/Power

Measurement uncertainty		
- Time		4%
- Power		1.33dB

Traceability

Test Equipment Used
0072, 0083, 0098, 0116, 0132, 0158, 0313, 0314, 0193, 0223, 0252, 0253, 0251, 0256, 0328, 0329

This test report may be reproduced in full only. The document may only be updated by MiCOM Labs personnel. Any changes will be noted in the Document History section of the report.

6. PHOTOGRAPHS

6.1. Radiated Test Setup Below 1 GHz - Test Setup

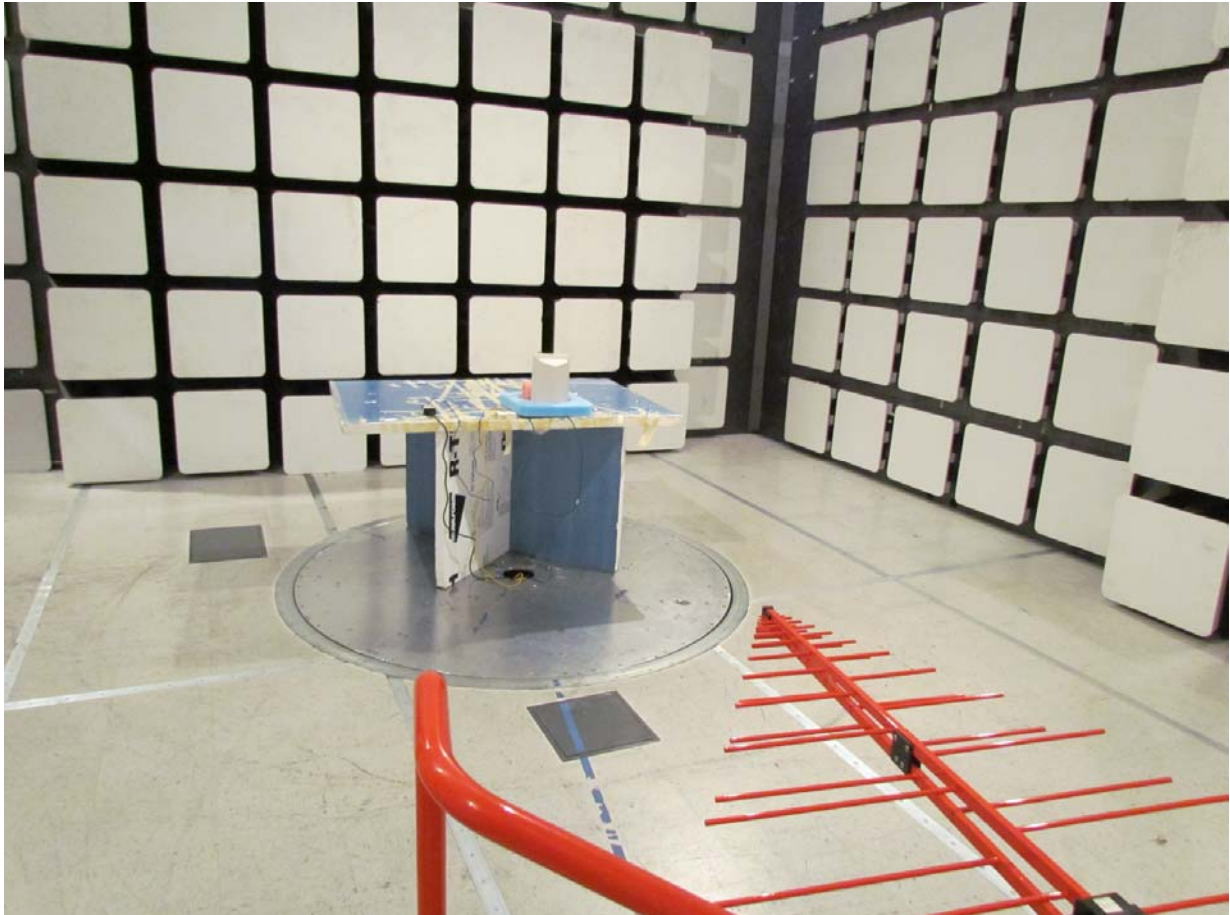

This test report may be reproduced in full only. The document may only be updated by MiCOM Labs personnel. Any changes will be noted in the Document History section of the report.

6.2. Radiated Emissions Above 1 GHz - Test Setup

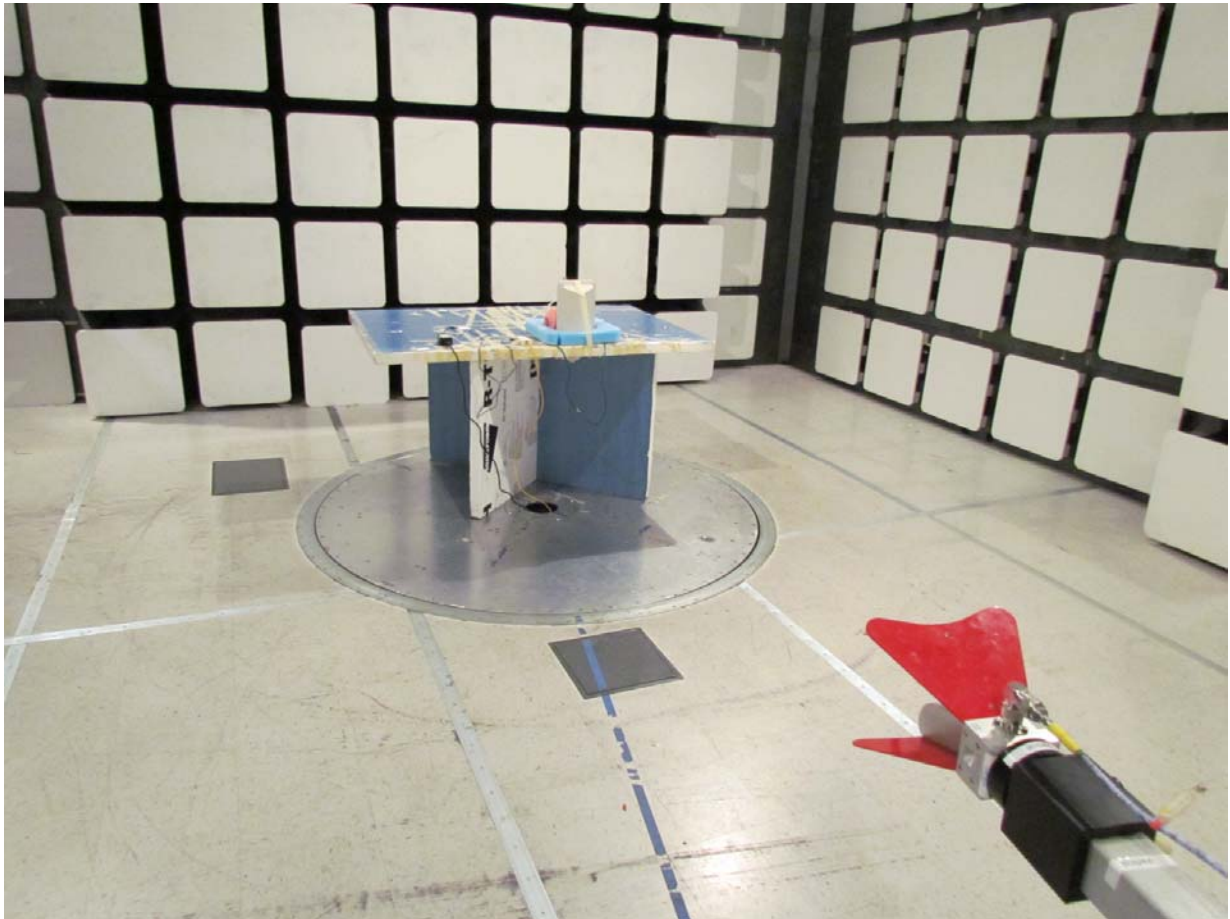

This test report may be reproduced in full only. The document may only be updated by MiCOM Labs personnel. Any changes will be noted in the Document History section of the report.

6.3. ac Wireline Emissions

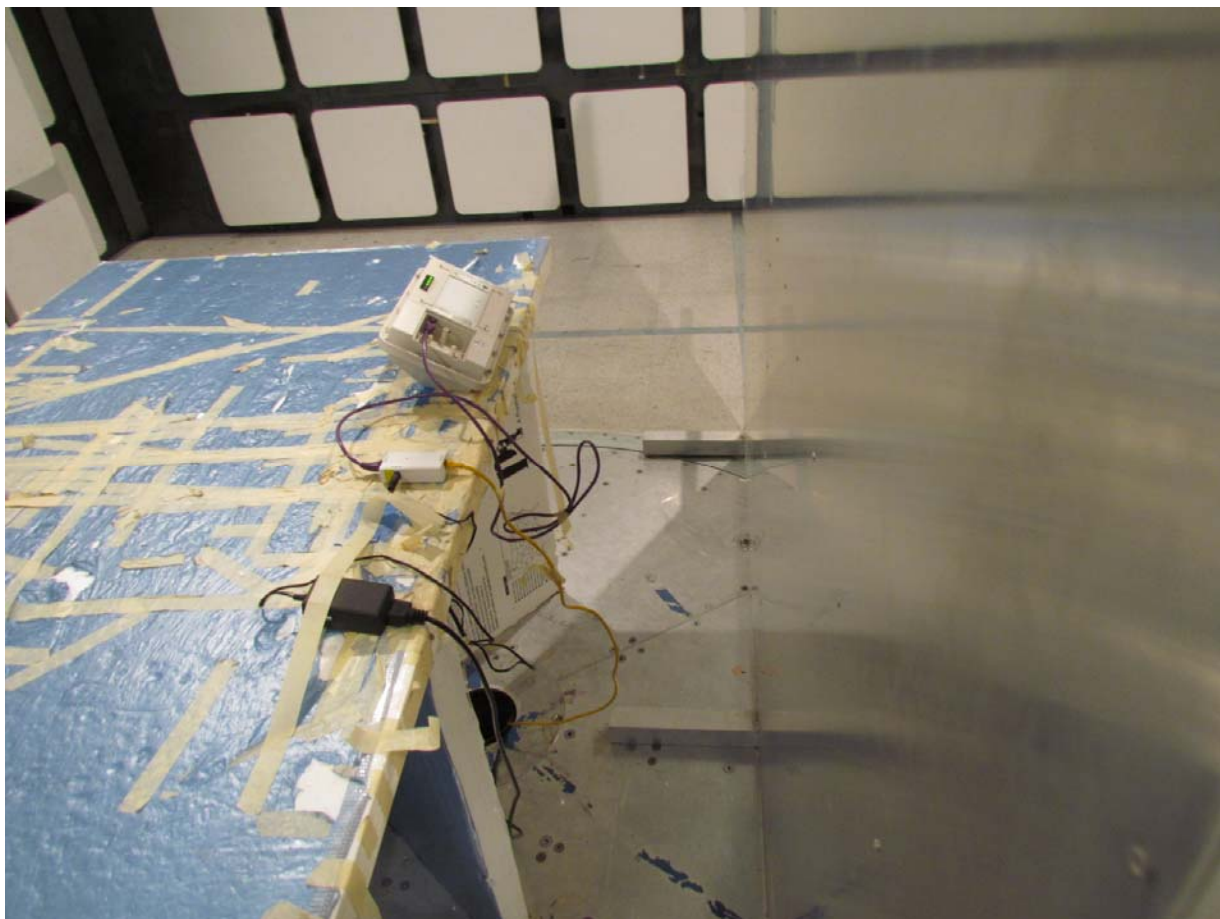



Title: SP-4700-A
To: FCC 47 CFR Part 15.407 & IC RSS-210
Serial #: TRIL05-U4b Rev A
Issue Date: 23rd May 2012
Page: 121 of 122

7. TEST EQUIPMENT DETAILS

Asset #	Instrument	Manufacturer	Part #	Serial #	Calibration Due Date
0070	Power Meter	Hewlett Packard	437B	3125U11552	28 th Nov 12
0117	Power Sensor	Hewlett Packard	8487D	3318A00371	15 th Nov 12
0223	Power Meter	Hewlett Packard	EPM-442A	US37480256	15 th Nov 12
0374	Power Sensor	Hewlett Packard	8485A	3318A19694	29 th Nov 12
0158	Barometer /Thermometer	Control Co.	4196	E2846	8 th Dec 12
0193	EMI Receiver	Rhode & Schwartz	ESI 7	838496/007	2 nd Dec 12
0287	EMI Receiver	Rhode & Schwartz	ESIB40	100201	16 th Nov 12
0338	30 - 3000 MHz Antenna	Sunol	JB3	A052907	8 th Nov 12
0335	1-18 GHz Horn Antenna	EMCO	3117	00066580	7 th Nov 12
0252	SMA Cable	Megaphase	Sucoflex 104	None	N/A
0293	BNC Cable	Megaphase	1689 1GVT4	15F50B001	N/A
0307	BNC Cable	Megaphase	1689 1GVT4	15F50B002	N/A
0310	2m SMA Cable	Micro-Coax	UFA210A-0-0787-3G03G0	209089-001	N/A
0312	3m SMA Cable	Micro-Coax	UFA210A-1-1181-3G0300	209092-001	N/A
0314	30dB N-Type Attenuator	ARRA	N9444-30	1623	N/A

This test report may be reproduced in full only. The document may only be updated by MiCOM Labs personnel. Any changes will be noted in the Document History section of the report.



440 Boulder Court, Suite 200
Pleasanton, CA 94566, USA
Tel: 1.925.462.0304
Fax: 1.925.462.0306
www.micomlabs.com