

FCC TEST REPORT

REPORT NO.: RF940214L12A

MODEL NO.: MD560(B)-01

RECEIVED: Apr. 20, 2005

TESTED: May 03 ~ May 05, 2005

ISSUED: May 06, 2005

APPLICANT: Qcom Technology Inc

ADDRESS: 7F, No.178, Ming Chuan E. Rd., Sec. 3, Taipei,
Taiwan

ISSUED BY: Advance Data Technology Corporation

LAB ADDRESS: No. 47, 14th Ling, Chia Pau Tsuen, Lin Kou
Hsiang 244, Taipei Hsien, Taiwan, R.O.C.

TEST LOCATION: No. 19, Hwa Ya 2nd Rd., Wen Hwa Tsuen,
Kwei Shan Hsiang, Taoyuan Hsien 333,
Taiwan, R.O.C.

This test report consists of 64 pages in total. It may be duplicated completely for legal use with the approval of the applicant. It should not be reproduced except in full, without the written approval of our laboratory. The client should not use it to claim product endorsement by CNLA, A2LA or any government agency. The test results in the report only apply to the tested sample.





TABLE OF CONTENTS

1	CERTIFICATION	4
2	SUMMARY OF TEST RESULTS	5
2.1	MEASUREMENT UNCERTAINTY	5
3	GENERAL INFORMATION	6
3.1	GENERAL DESCRIPTION OF EUT	6
3.2	DESCRIPTION OF TEST MODES	7
3.2.1	CONFIGURATION OF SYSTEM UNDER TEST	8
3.2.2	TEST MODE APPLICABILITY AND TESTED CHANNEL DETAIL:	9
3.3	GENERAL DESCRIPTION OF APPLIED STANDARDS	11
3.4	DESCRIPTION OF SUPPORT UNITS	11
4	TEST PROCEDURES AND RESULTS	12
4.1	CONDUCTED EMISSION MEASUREMENT	12
4.1.1	LIMITS OF CONDUCTED EMISSION MEASUREMENT	12
4.1.2	TEST INSTRUMENTS	12
4.1.3	TEST PROCEDURES	13
4.1.4	DEVIATION FROM TEST STANDARD	13
4.1.5	TEST SETUP	14
4.1.6	EUT OPERATING CONDITIONS	14
4.1.7	TEST RESULTS	15
4.2	NUMBER OF HOPPING FREQUENCY USED	21
4.2.1	LIMIT OF HOPPING FREQUENCY USED	21
4.2.2	TEST INSTRUMENTS	21
4.2.3	TEST PROCEDURES	22
4.2.4	DEVIATION FROM TEST STANDARD	22
4.2.5	TEST SETUP	23
4.2.6	TEST RESULTS	23
4.3	DWELL TIME ON EACH CHANNEL	25
4.3.1	LIMIT OF DWELL TIME USED	25
4.3.2	TEST INSTRUMENTS	25
4.3.3	TEST PROCEDURES	26
4.3.4	DEVIATION FROM TEST STANDARD	26
4.3.5	TEST SETUP	26
4.3.6	TEST RESULTS	27
4.4	CHANNEL BANDWIDTH	31
4.4.1	LIMITS OF CHANNEL BANDWIDTH	31
4.4.2	TEST INSTRUMENTS	31
4.4.3	TEST PROCEDURE	32
4.4.4	DEVIATION FROM TEST STANDARD	32
4.4.5	TEST SETUP	32
4.4.6	EUT OPERATING CONDITION	32
4.4.7	TEST RESULTS	33
4.5	HOPPING CHANNEL SEPARATION	36



4.5.1	LIMIT OF HOPPING CHANNEL SEPARATION	36
4.5.2	TEST INSTRUMENTS.....	36
4.5.3	TEST PROCEDURES	37
4.5.4	DEVIATION FROM TEST STANDARD	37
4.5.5	TEST SETUP.....	37
4.5.6	TEST RESULTS	38
4.6	MAXIMUM PEAK OUTPUT POWER	41
4.6.1	LIMITS OF MAXIMUM PEAK OUTPUT POWER MEASUREMENT.....	41
4.6.2	INSTRUMENTS.....	41
4.6.3	TEST PROCEDURES	42
4.6.4	DEVIATION FROM TEST STANDARD	42
4.6.5	TEST SETUP.....	43
4.6.6	EUT OPERATING CONDITION	43
4.6.7	TEST RESULTS	44
4.7	RADIATED EMISSION MEASUREMENT	47
4.7.1	LIMITS OF RADIATED EMISSION MEASUREMENT.....	47
4.7.2	TEST INSTRUMENTS.....	48
4.7.3	TEST PROCEDURES	49
4.7.4	DEVIATION FROM TEST STANDARD	49
4.7.5	TEST SETUP.....	50
4.7.6	EUT OPERATING CONDITIONS	50
4.7.7	TEST RESULTS	51
4.8	BAND EDGES MEASUREMENT	55
4.8.1	LIMITS OF BAND EDGES MEASUREMENT.....	55
4.8.2	TEST INSTRUMENTS.....	55
4.8.3	TEST PROCEDURE.....	55
4.8.4	DEVIATION FROM TEST STANDARD	55
4.8.5	EUT OPERATING CONDITION	56
4.8.6	TEST RESULTS	56
4.9	ANTENNA REQUIREMENT	59
4.9.1	STANDARD APPLICABLE	59
4.9.2	ANTENNA CONNECTED CONSTRUCTION.....	59
5	PHOTOGRAPHS OF THE TEST CONFIGURATION.....	60
6	INFORMATION ON THE TESTING LABORATORIES	64



1 CERTIFICATION

PRODUCT : Bluetooth with Modem Combo Card
BRAND NAME : Qcom
MODEL NO. : MD560(B)-01
APPLICANT : Qcom Technology Inc
TESTED : May 03 ~ May 05, 2005
TEST SAMPLE : ENGINEERING SAMPLE
STANDARDS : FCC Part 15, Subpart C (Section 15.247)
ANSI C63.4-2003

The above equipment has been tested by **Advance Data Technology Corporation**, and found compliance with the requirement of the above standards. The test record, data evaluation & Equipment Under Test (EUT) configurations represented herein are true and accurate accounts of the measurements of the sample's EMC characteristics under the conditions specified in this report.

PREPARED BY : Windy Chou, **DATE:** May 06, 2005
(Windy Chou)

TECHNICAL ACCEPTANCE : Gary Chang, **DATE:** May 06, 2005
Responsible for RF (Gary Chang)

APPROVED BY : Cody Chang, **DATE:** May 06, 2005
(Cody Chang, Deputy Manager)

2 SUMMARY OF TEST RESULTS

The EUT has been tested according to the following specifications:

APPLIED STANDARD: FCC Part 15, Subpart C			
Standard Section	Test Type and Limit	Result	REMARK
15.207	AC Power Conducted Emission	PASS	Meet the requirement of limit Minimum passing margin is -14.62 dB at 0.205 MHz
15.247(a)(1) (iii)	Number of Hopping Frequency Used Spec.: At least 15 channels	PASS	Meet the requirement of limit
15.247(a)(1) (iii)	Dwell Time on Each Channel Spec. : Max. 0.4 second within 31.6 second	PASS	Meet the requirement of limit
15.247(a)(1)	1. Hopping Channel Separation Spec. : Min. 25 kHz or 20 dB bandwidth, whichever is greater 2. Spectrum Bandwidth of a Frequency Hopping Sequence Spread Spectrum System	PASS	Meet the requirement of limit
15.247(b)	Maximum Peak Output Power Spec.: max. 30dBm	PASS	Meet the requirement of limit
15.247(d)	Transmitter Radiated Emissions Spec.: Table 15.209	PASS	Meet the requirement of limit Minimum passing margin is -6.41dB at 199.12 MHz
15.247(d)	Band Edge Measurement	PASS	Meet the requirement of limit

2.1 MEASUREMENT UNCERTAINTY

Where relevant, the following measurement uncertainty levels have been estimated for tests performed on the EUT as specified in CISPR 16-4:

MEASUREMENT	FREQUENCY	UNCERTAINTY
Conducted emissions	9kHz~30MHz	2.44 dB
Radiated emissions	30MHz ~ 200MHz	3.55 dB
	200MHz ~1000MHz	3.58 dB
	1GHz ~ 18GHz	1.10 dB
	18GHz ~ 40GHz	0.91 dB

3 GENERAL INFORMATION

3.1 GENERAL DESCRIPTION OF EUT

PRODUCT	Bluetooth with Modem Combo Card
MODEL NO.	MD560(B)-01
POWER SUPPLY	3.3Vdc from host equipment
MODULATION TYPE	GFSK
MODULATION TECHNOLOGY	FHSS
FREQUENCY RANGE	2402 MHz ~ 2480 MHz
NUMBER OF CHANNEL	79
OUTPUT POWER	1.578mW
ANTENNA TYPE	Film antenna with -1.17dBi gain (Brand: Hitachi Cable ; P/N: HFT28-LG02-BT)
DATA CABLE	NA
I/O PORTS	NA

NOTE:

1. This report is issued as a supplementary report of ADT report no.: RF940214L12. The model in this report is identical to the original application one.
2. This report is prepared for FCC class II permissive change. The difference compared with the original design is changing antenna and model name.
3. Bluetooth technology is used for the EUT.
4. The above EUT information was declared by manufacturer and for more detailed features description, please refer to the manufacturer's specifications or User's Manual.

3.2 DESCRIPTION OF TEST MODES

Operated in 2400 ~ 2483.5MHz Band:

79 channels are provided to this EUT.

Channel	Freq. (MHz)	Channel	Freq. (MHz)	Channel	Freq. (MHz)	Channel	Freq. (MHz)
0	2402	20	2422	40	2442	60	2462
1	2403	21	2423	41	2443	61	2463
2	2404	22	2424	42	2444	62	2464
3	2405	23	2425	43	2445	63	2465
4	2406	24	2426	44	2446	64	2466
5	2407	25	2427	45	2447	65	2467
6	2408	26	2428	46	2448	66	2468
7	2409	27	2429	47	2449	67	2469
8	2410	28	2430	48	2450	68	2470
9	2411	29	2431	49	2451	69	2471
10	2412	30	2431	50	2452	70	2472
11	2413	31	2433	51	2453	71	2473
12	2414	32	2434	52	2454	72	2474
13	2415	33	2435	53	2455	73	2475
14	2416	34	2436	54	2456	74	2476
15	2417	35	2437	55	2457	75	2477
16	2418	36	2438	56	2458	76	2478
17	2419	37	2439	57	2459	77	2479
18	2420	38	2440	58	2460	78	2480
19	2421	39	2441	59	2461		

3.2.1 CONFIGURATION OF SYSTEM UNDER TEST

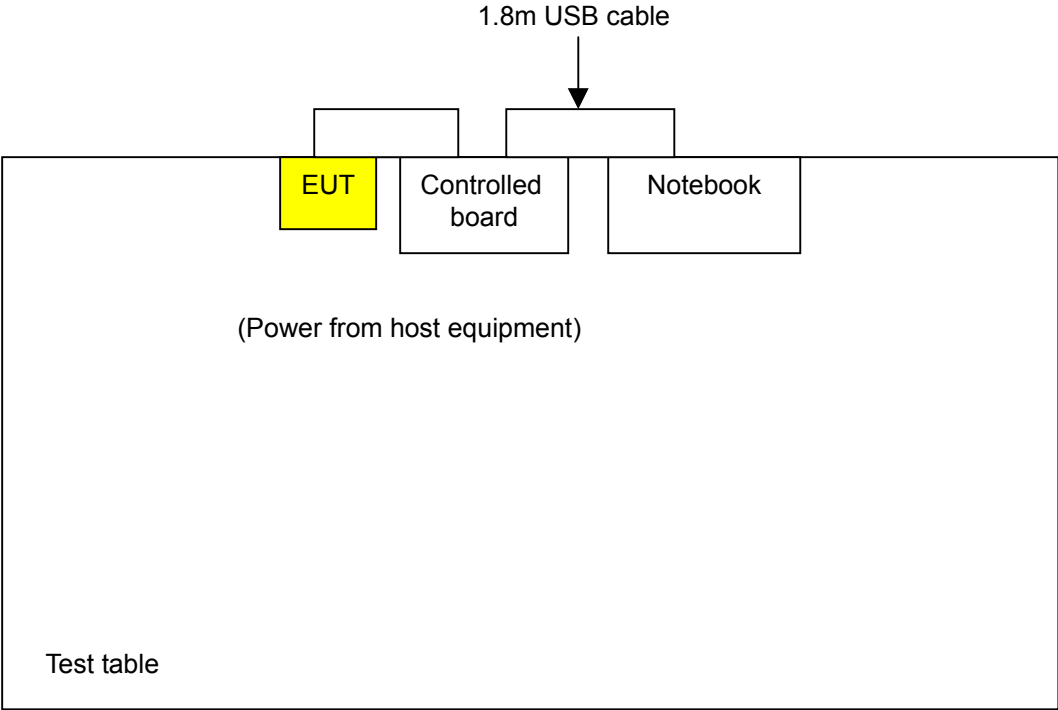



3.2.2 TEST MODE APPLICABILITY AND TESTED CHANNEL DETAIL:

EUT configure mode	Applicable to				Description
	PLC	RE<1G	RE≥1G	APCM	
-	X	X	X	X	NA

Where PLC: Power Line Conducted Emission RE<1G RE: Radiated Emission below 1GHz
 RE≥1G: Radiated Emission above 1GHz APCM: Antenna Port Conducted Measurement

Power Line Conducted Emission Test:

- Pre-Scan has been conducted to determine the worst-case mode from all possible combinations between available modulations, and packet types.
- Following channel(s) was (were) selected for the final test as listed below.

Available Channel	Tested Channel	Modulation Technology	Modulation Type	Packet Type
0 to 78	0, 39, 78	FHSS	GFSK	DH5

Radiated Emission Test (Below 1 GHz):

- Pre-Scan has been conducted to determine the worst-case mode from all possible combinations between available modulations, and packet types.
- Following channel(s) was (were) selected for the final test as listed below.

Available Channel	Tested Channel	Modulation Technology	Modulation Type	Packet Type
0 to 78	78	FHSS	GFSK	DH5

Radiated Emission Test (Above 1 GHz):

- Pre-Scan has been conducted to determine the worst-case mode from all possible combinations between available modulations, and packet types.
- Following channel(s) was (were) selected for the final test as listed below.

Available Channel	Tested Channel	Modulation Technology	Modulation Type	Packet Type
0 to 78	0, 39, 78	FHSS	GFSK	DH5



Bandedge Measurement:

- Pre-Scan has been conducted to determine the worst-case mode from all possible combinations between available modulations, and packet types.
- Following channel(s) was (were) selected for the final test as listed below.

Available Channel	Tested Channel	Modulation Technology	Modulation Type	Packet Type
0 to 78	0, 78	FHSS	GFSK	DH5

Note: The EUT only changed the antenna and model name, no difference on the hardware, so the result in this test item was identical to the original one.

Antenna Port Conducted Measurement:

- Pre-Scan has been conducted to determine the worst-case mode from all possible combinations between available modulations, and packet types.
- Following channel(s) was (were) selected for the final test as listed below.

Available Channel	Tested Channel	Modulation Technology	Modulation Type	Packet Type
0 to 78	0, 39, 78	FHSS	GFSK	DH5

Note: The EUT only changed the antenna and model name, no difference on the hardware, so the result in this test item was identical to the original one.

3.3 GENERAL DESCRIPTION OF APPLIED STANDARDS

The EUT is a Bluetooth with Modem Combo Card. According to the specifications of the manufacturer, it must comply with the requirements of the following standards:

FCC Part 15, Subpart C. (15.247)
ANSI C63.4-2003

All test items have been performed and recorded as per the above standards.

NOTE: The EUT is also considered as a kind of computer peripheral, because the connection to computer is necessary for typical use. It has been verified to comply with the requirements of FCC Part 15, Subpart B, Class B (DoC). The test report has been issued separately.

3.4 DESCRIPTION OF SUPPORT UNITS

NO.	PRODUCT	BRAND	MODEL NO.	SERIAL NO.	FCC ID
1	NOTEBOOK COMPUTER	DELL	PP05L	12130898320	E2K24CLNS

NO.	SIGNAL CABLE DESCRIPTION OF THE ABOVE SUPPORT UNITS
1	NA

NOTE: All power cords of the above support units are non shielded (1.8m).

4 TEST PROCEDURES AND RESULTS

4.1 CONDUCTED EMISSION MEASUREMENT

4.1.1 LIMITS OF CONDUCTED EMISSION MEASUREMENT

FREQUENCY OF EMISSION (MHz)	CONDUCTED LIMIT (dB μ V)	
	Quasi-peak	Average
0.15-0.5	66 to 56	56 to 46
0.5-5	56	46
5-30	60	50

- NOTE:**
1. The lower limit shall apply at the transition frequencies.
 2. The limit decreases in line with the logarithm of the frequency in the range of 0.15 to 0.50 MHz.
 3. All emanations from a class A/B digital device or system, including any network of conductors and apparatus connected thereto, shall not exceed the level of field strengths specified above.

4.1.2 TEST INSTRUMENTS

DESCRIPTION & MANUFACTURER	MODEL NO.	SERIAL NO.	CALIBRATED UNTIL
Test Receiver ROHDE & SCHWARZ	ESCS30	100291	Nov. 16, 2005
RF signal cable Woken	5D-FB	Cable-HYC01-01	Jan. 09, 2006
LISN ROHDE & SCHWARZ	ESH3-Z5	100312	Feb. 15, 2006
LISN ROHDE & SCHWARZ	ESH2-Z5	100104	Feb. 15, 2006
Software ADT	ADT_Cond_V3	NA	NA

- NOTE:**
1. The calibration interval of the above test instruments is 12 months and the calibrations are traceable to NML/ROC and NIST/USA.
 2. The test was performed in HwaYa Shielded Room 1.
 3. The VCCI Site Registration No. is C-2040.

4.1.3 TEST PROCEDURES

- a. The EUT was placed 0.4 meters from the conducting wall of the shielded room with EUT being connected to the power mains through a line impedance stabilization network (LISN). Other support units were connected to the power mains through another LISN. The two LISNs provide 50 ohm/ 50uH of coupling impedance for the measuring instrument.
- b. Both lines of the power mains connected to the EUT were checked for maximum conducted interference.
- c. The frequency range from 150kHz to 30MHz was searched. Emission levels under (Limit - 20dB) was not recorded.

4.1.4 DEVIATION FROM TEST STANDARD

No deviation

4.1.5 TEST SETUP

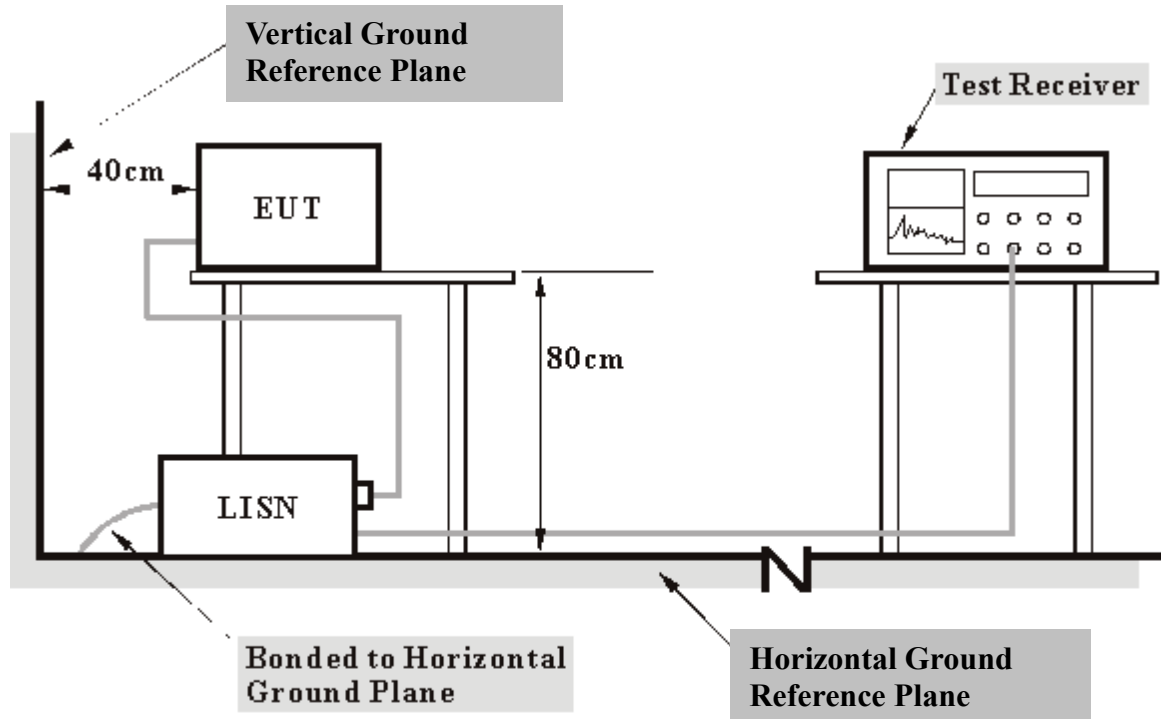

- Note:**
1. Support units were connected to second LISN.
 2. Both of LISNs (AMN) 80 cm from EUT and at the least 80 cm from other units and other metal planes support units.

For the actual test configuration, please refer to the related item – Photographs of the Test Configuration.

4.1.6 EUT OPERATING CONDITIONS

- a. Connected the EUT to a notebook system via the control board and placed on a testing table.
- b. The notebook system ran a test program (provided by manufacturer) to enable EUT under transmission/receiving condition continuously at specific channel frequency.
- c. The notebook system sent "H" messages to its screen.
- d. Steps c was repeated.

4.1.7 TEST RESULTS

Conducted Worst-Case Data

EUT	Bluetooth with Modem Combo Card	MEASUREMENT DETAIL	
MODEL	MD560(B)-01	PHASE	Line 1
CHANNEL	Channel 0	6dB BANDWIDTH	9 kHz
MODULATION TYPE	GFSK	ENVIRONMENTAL CONDITIONS	23deg. C, 65%RH, 991hPa
TESTED BY	Gary Chang	INPUT POWER (SYSTEM)	120Vac, 60 Hz

No	Freq. [MHz]	Corr. Factor (dB)	Reading Value [dB (uV)]		Emission Level [dB (uV)]		Limit [dB (uV)]		Margin (dB)	
			Q.P.	AV.	Q.P.	AV.	Q.P.	AV.	Q.P.	AV.
			1	0.154	0.10	43.74	-	43.84	-	65.79
2	0.209	0.10	47.41	-	47.51	-	63.26	53.26	-15.75	-
3	0.302	0.10	30.53	-	30.63	-	60.18	50.18	-29.55	-
4	1.617	0.20	32.58	-	32.78	-	56.00	46.00	-23.22	-
5	10.406	0.31	33.86	-	34.17	-	60.00	50.00	-25.83	-
6	16.547	0.52	28.33	-	28.85	-	60.00	50.00	-31.15	-

- REMARKS:**
1. Q.P. and AV. are abbreviations of quasi-peak and average individually.
 2. "-": The Quasi-peak reading value also meets average limit and measurement with the average detector is unnecessary.
 3. The emission levels of other frequencies were very low against the limit.
 4. Margin value = Emission level - Limit value
 5. Correction factor = Insertion loss + Cable loss
 6. Emission Level = Correction Factor + Reading Value.

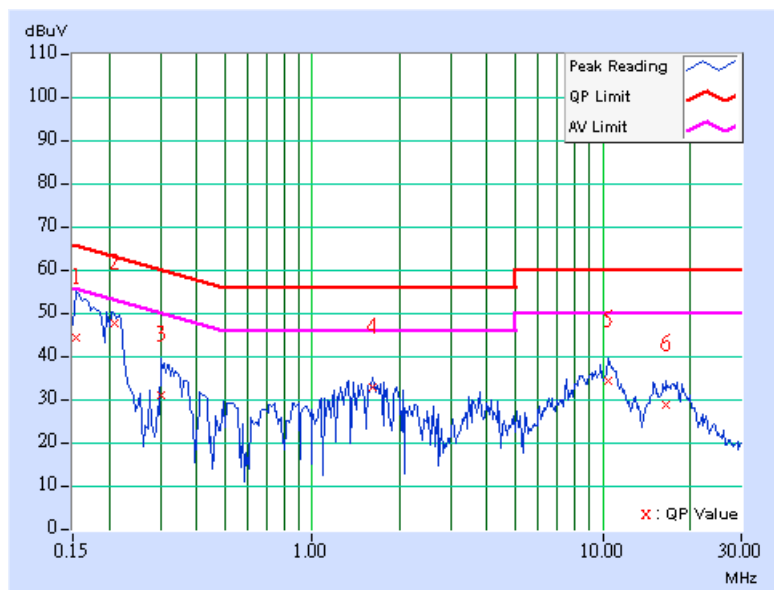



EUT	Bluetooth with Modem Combo Card	MEASUREMENT DETAIL	
MODEL	MD560(B)-01	PHASE	Line 2
CHANNEL	Channel 0	6dB BANDWIDTH	9 kHz
MODULATION TYPE	GFSK	ENVIRONMENTAL CONDITIONS	23deg. C, 65%RH, 991hPa
TESTED BY	Gary Chang	INPUT POWER (SYSTEM)	120Vac, 60 Hz

No	Freq. [MHz]	Corr. Factor (dB)	Reading Value [dB (uV)]		Emission Level [dB (uV)]		Limit [dB (uV)]		Margin (dB)	
			Q.P.	AV.	Q.P.	AV.	Q.P.	AV.	Q.P.	AV.
			1	0.162	0.10	43.18	-	43.28	-	65.38
2	0.205	0.10	47.37	-	47.47	-	63.42	53.42	-15.95	-
3	0.322	0.10	31.12	-	31.22	-	59.66	49.66	-28.44	-
4	1.730	0.20	31.35	-	31.55	-	56.00	46.00	-24.45	-
5	10.363	0.41	34.18	-	34.59	-	60.00	50.00	-25.41	-
6	17.027	0.62	28.12	-	28.74	-	60.00	50.00	-31.26	-

- REMARKS:**
1. Q.P. and AV. are abbreviations of quasi-peak and average individually.
 2. "-": The Quasi-peak reading value also meets average limit and measurement with the average detector is unnecessary.
 3. The emission levels of other frequencies were very low against the limit.
 4. Margin value = Emission level - Limit value
 5. Correction factor = Insertion loss + Cable loss
 6. Emission Level = Correction Factor + Reading Value.

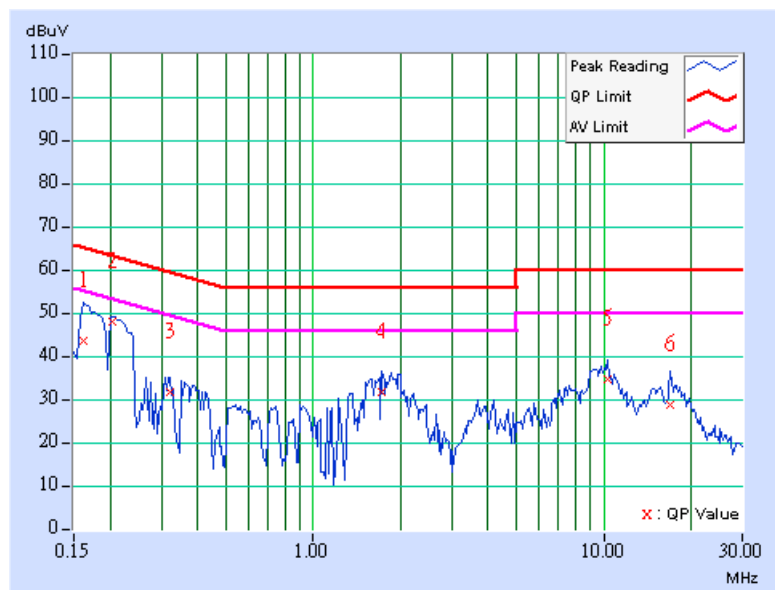



EUT	Bluetooth with Modem Combo Card	MEASUREMENT DETAIL	
MODEL	MD560(B)-01	PHASE	Line 1
CHANNEL	Channel 39	6dB BANDWIDTH	9 kHz
MODULATION TYPE	GFSK	ENVIRONMENTAL CONDITIONS	23deg. C, 65%RH, 991hPa
TESTED BY	Gary Chang	INPUT POWER (SYSTEM)	120Vac, 60 Hz

No	Freq. [MHz]	Corr. Factor (dB)	Reading Value		Emission Level		Limit		Margin	
			[dB (uV)]		[dB (uV)]		[dB (uV)]		(dB)	
			Q.P.	AV.	Q.P.	AV.	Q.P.	AV.	Q.P.	AV.
1	0.162	0.10	45.96	-	46.06	-	65.38	55.38	-19.32	-
2	0.193	0.10	41.34	-	41.44	-	63.91	53.91	-22.47	-
3	0.271	0.10	32.10	-	32.20	-	61.08	51.08	-28.88	-
4	1.914	0.20	31.13	-	31.33	-	56.00	46.00	-24.67	-
5	10.570	0.31	33.73	-	34.04	-	60.00	50.00	-25.96	-
6	14.961	0.40	27.94	-	28.34	-	60.00	50.00	-31.66	-

- REMARKS:**
1. Q.P. and AV. are abbreviations of quasi-peak and average individually.
 2. "-": The Quasi-peak reading value also meets average limit and measurement with the average detector is unnecessary.
 3. The emission levels of other frequencies were very low against the limit.
 4. Margin value = Emission level - Limit value
 5. Correction factor = Insertion loss + Cable loss
 6. Emission Level = Correction Factor + Reading Value.

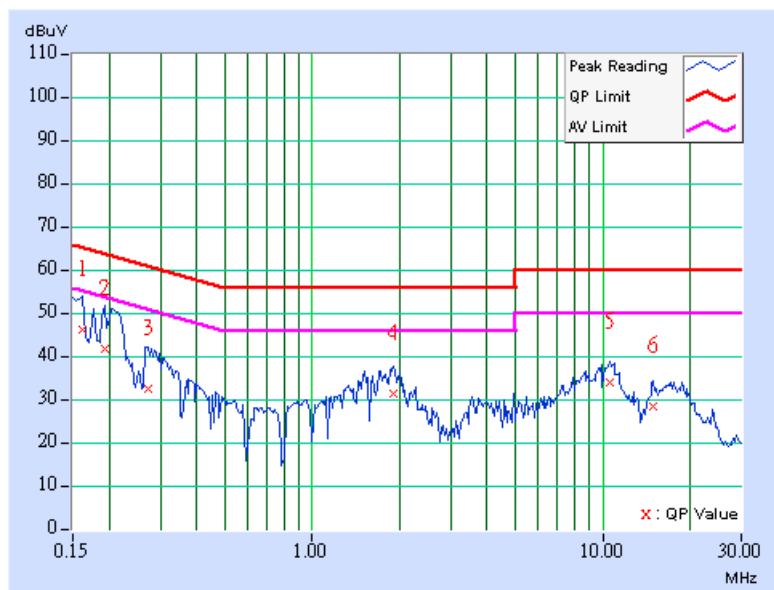



EUT	Bluetooth with Modem Combo Card	MEASUREMENT DETAIL	
MODEL	MD560(B)-01	PHASE	Line 2
CHANNEL	Channel 39	6dB BANDWIDTH	9 kHz
MODULATION TYPE	GFSK	ENVIRONMENTAL CONDITIONS	23deg. C, 65%RH, 991hPa
TESTED BY	Gary Chang	INPUT POWER (SYSTEM)	120Vac, 60 Hz

No	Freq. [MHz]	Corr. Factor (dB)	Reading Value		Emission Level		Limit		Margin	
			[dB (uV)]		[dB (uV)]		[dB (uV)]		(dB)	
			Q.P.	AV.	Q.P.	AV.	Q.P.	AV.	Q.P.	AV.
1	0.150	0.10	48.81	-	48.91	-	66.00	56.00	-17.09	-
2	0.173	0.10	46.03	-	46.13	-	64.79	54.79	-18.66	-
3	0.205	0.10	48.70	-	48.80	-	63.42	53.42	-14.62	-
4	2.133	0.20	30.85	-	31.05	-	56.00	46.00	-24.95	-
5	10.043	0.40	33.63	-	34.03	-	60.00	50.00	-25.97	-
6	16.844	0.61	27.62	-	28.23	-	60.00	50.00	-31.77	-

- REMARKS:**
1. Q.P. and AV. are abbreviations of quasi-peak and average individually.
 2. "-": The Quasi-peak reading value also meets average limit and measurement with the average detector is unnecessary.
 3. The emission levels of other frequencies were very low against the limit.
 4. Margin value = Emission level - Limit value
 5. Correction factor = Insertion loss + Cable loss
 6. Emission Level = Correction Factor + Reading Value.

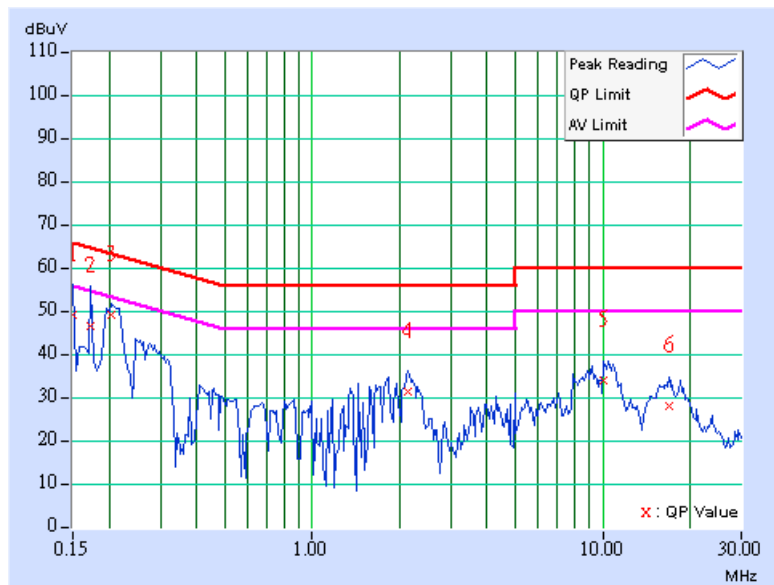



EUT	Bluetooth with Modem Combo Card	MEASUREMENT DETAIL	
MODEL	MD560(B)-01	PHASE	Line 1
CHANNEL	Channel 78	6dB BANDWIDTH	9 kHz
MODULATION TYPE	GFSK	ENVIRONMENTAL CONDITIONS	23deg. C, 65%RH, 991hPa
TESTED BY	Gary Chang	INPUT POWER (SYSTEM)	120Vac, 60 Hz

No	Freq. [MHz]	Corr. Factor (dB)	Reading Value		Emission Level		Limit		Margin	
			[dB (uV)]		[dB (uV)]		[dB (uV)]		(dB)	
			Q.P.	AV.	Q.P.	AV.	Q.P.	AV.	Q.P.	AV.
1	0.193	0.10	44.50	-	44.60	-	63.91	53.91	-19.31	-
2	0.216	0.10	46.24	-	46.34	-	62.96	52.96	-16.62	-
3	1.445	0.20	31.23	-	31.43	-	56.00	46.00	-24.57	-
4	3.801	0.20	26.97	-	27.17	-	56.00	46.00	-28.83	-
5	10.609	0.31	34.09	-	34.40	-	60.00	50.00	-25.60	-
6	15.852	0.47	29.26	-	29.73	-	60.00	50.00	-30.27	-

- REMARKS:**
1. Q.P. and AV. are abbreviations of quasi-peak and average individually.
 2. "-": The Quasi-peak reading value also meets average limit and measurement with the average detector is unnecessary.
 3. The emission levels of other frequencies were very low against the limit.
 4. Margin value = Emission level - Limit value
 5. Correction factor = Insertion loss + Cable loss
 6. Emission Level = Correction Factor + Reading Value.

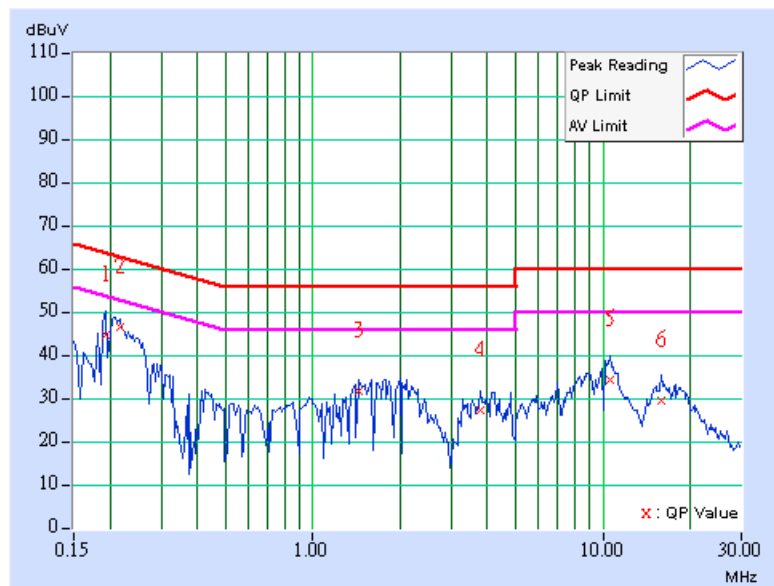



EUT	Bluetooth with Modem Combo Card	MEASUREMENT DETAIL	
MODEL	MD560(B)-01	PHASE	Line 2
CHANNEL	Channel 78	6dB BANDWIDTH	9 kHz
MODULATION TYPE	GFSK	ENVIRONMENTAL CONDITIONS	23deg. C, 65%RH, 991hPa
TESTED BY	Gary Chang	INPUT POWER (SYSTEM)	120Vac, 60 Hz

No	Freq. [MHz]	Corr. Factor (dB)	Reading Value [dB (uV)]		Emission Level [dB (uV)]		Limit [dB (uV)]		Margin (dB)	
			Q.P.	AV.	Q.P.	AV.	Q.P.	AV.	Q.P.	AV.
			1	0.185	0.10	42.80	-	42.90	-	64.25
2	0.224	0.10	39.68	-	39.78	-	62.66	52.66	-22.88	-
3	1.578	0.20	31.48	-	31.68	-	56.00	46.00	-24.32	-
4	8.645	0.35	32.15	-	32.50	-	60.00	50.00	-27.50	-
5	10.430	0.41	34.26	-	34.67	-	60.00	50.00	-25.33	-
6	16.609	0.60	28.26	-	28.86	-	60.00	50.00	-31.14	-

- REMARKS:**
1. Q.P. and AV. are abbreviations of quasi-peak and average individually.
 2. "-": The Quasi-peak reading value also meets average limit and measurement with the average detector is unnecessary.
 3. The emission levels of other frequencies were very low against the limit.
 4. Margin value = Emission level - Limit value
 5. Correction factor = Insertion loss + Cable loss
 6. Emission Level = Correction Factor + Reading Value.

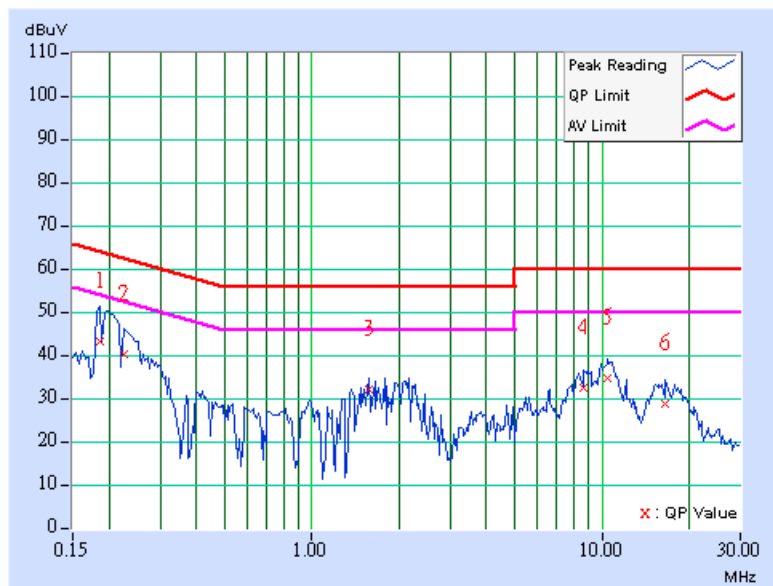

4.2 NUMBER OF HOPPING FREQUENCY USED

4.2.1 LIMIT OF HOPPING FREQUENCY USED

At least 15 channels frequencies, and should be equally spaced.

4.2.2 TEST INSTRUMENTS

Description & Manufacturer	Model No.	Serial No.	Calibrated Until
SPECTRUM ANALYZER	FSEK30	100049	Aug. 12, 2005

NOTE:

The calibration interval of the above test instruments is 12 months. And the calibrations are traceable to NML/ROC and NIST/USA.

4.2.3 TEST PROCEDURES

- a. Check the calibration of the measuring instrument (SA) using either an internal calibrator or a known signal from an external generator.
- b. Turn on the EUT and connect its antenna terminal to measurement via a low loss cable. Then set it to any one measured frequency within its operating range and make sure the instrument is operated in its linear range.
- c. Set the SA on MaxHold Mode, and then keep the EUT in hopping mode. Record all the signals from each channel until each one has been recorded.
- d. Set the SA on View mode and then plot the result on SA screen.
- e. Repeat above procedures until all frequencies measured were complete.

4.2.4 DEVIATION FROM TEST STANDARD

No deviation

4.2.5 TEST SETUP

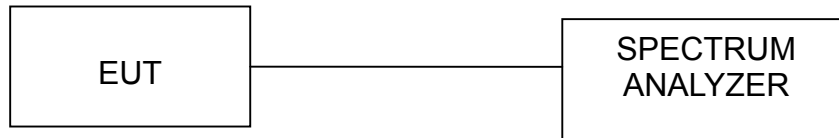

4.2.6 TEST RESULTS

There are 79 hopping frequencies in the hopping mode. Please refer to next page for the test result. On the plots, it shows that the hopping frequencies are equally spaced.

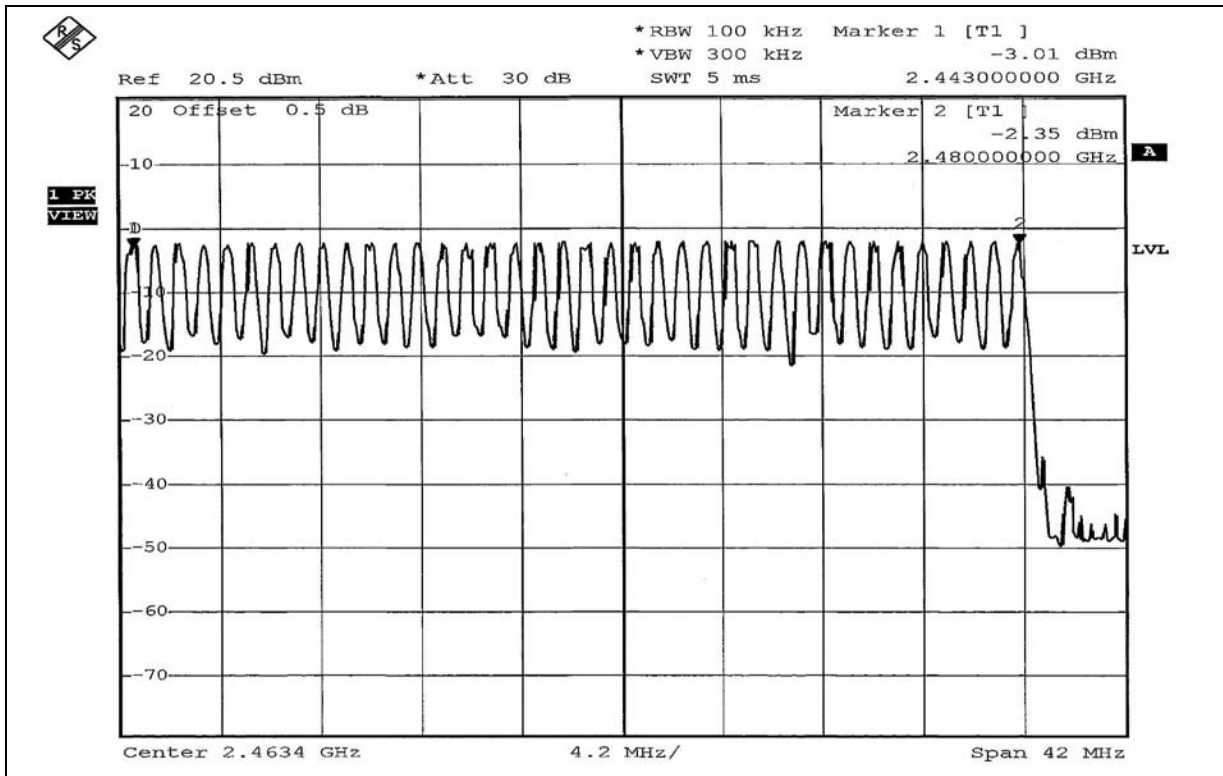
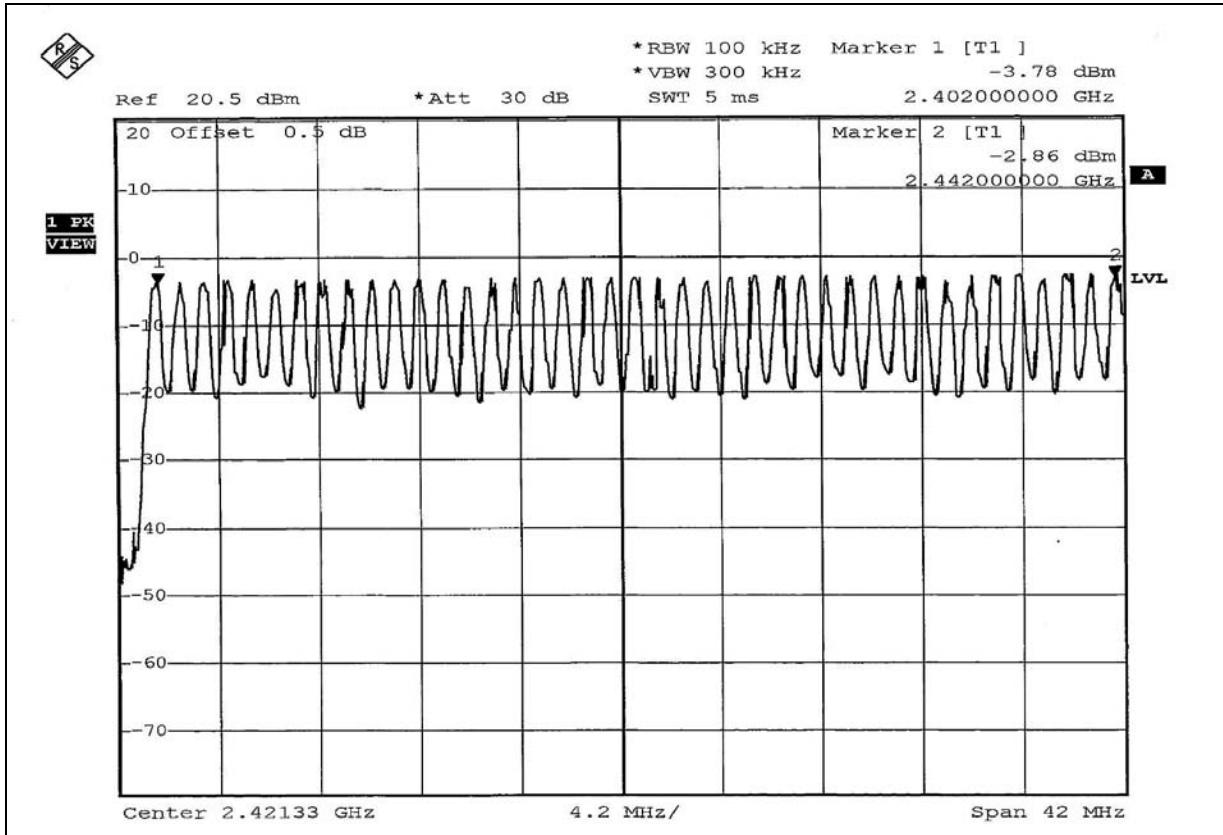

4.3 DWELL TIME ON EACH CHANNEL

4.3.1 LIMIT OF DWELL TIME USED

The average time of occupancy on any channel shall not be greater than 0.4 seconds within a period of 0.4 seconds multiplied by the number of hopping channels employed.

4.3.2 TEST INSTRUMENTS

Description & Manufacturer	Model No.	Serial No.	Calibrated Until
SPECTRUM ANALYZER	FSEK30	100049	Aug. 12, 2005

NOTE:

The calibration interval of the above test instruments is 12 months. And the calibrations are traceable to NML/ROC and NIST/USA.

4.3.3 TEST PROCEDURES

1. Check the calibration of the measuring instrument (SA) using either an internal calibrator or a known signal from an external generator.
2. Turn on the EUT and connect its antenna terminal to measurement via a low loss cable. Then set it to any one measured frequency within its operating range and make sure the instrument is operated in its linear range.
3. Adjust the center frequency of SA on any frequency be measured and set SA to zero span mode. And then, set RBW and VBW of spectrum analyzer to proper value.
4. Measure the time duration of one transmission on the measured frequency. And then plot the result with time difference of this time duration.
5. Repeat above procedures until all frequencies measured were complete.

4.3.4 DEVIATION FROM TEST STANDARD

No deviation

4.3.5 TEST SETUP



4.3.6 TEST RESULTS

Mode	Number of transmission in a 31.6 (79Hopping*0.4)	Length of transmission time (msec)	Result (msec)	Limit (msec)
DH1	50 (times / 5 sec) *6.32=316.00 times	0.452	142.83	400
DH3	25 (times / 5 sec) *6.32=158.00 times	1.740	274.92	400
DH5	17 (times / 5 sec) *6.32=107.44times	3.000	322.32	400

Test plots of the transmitting time slot are shown on next 3 pages.



DH1

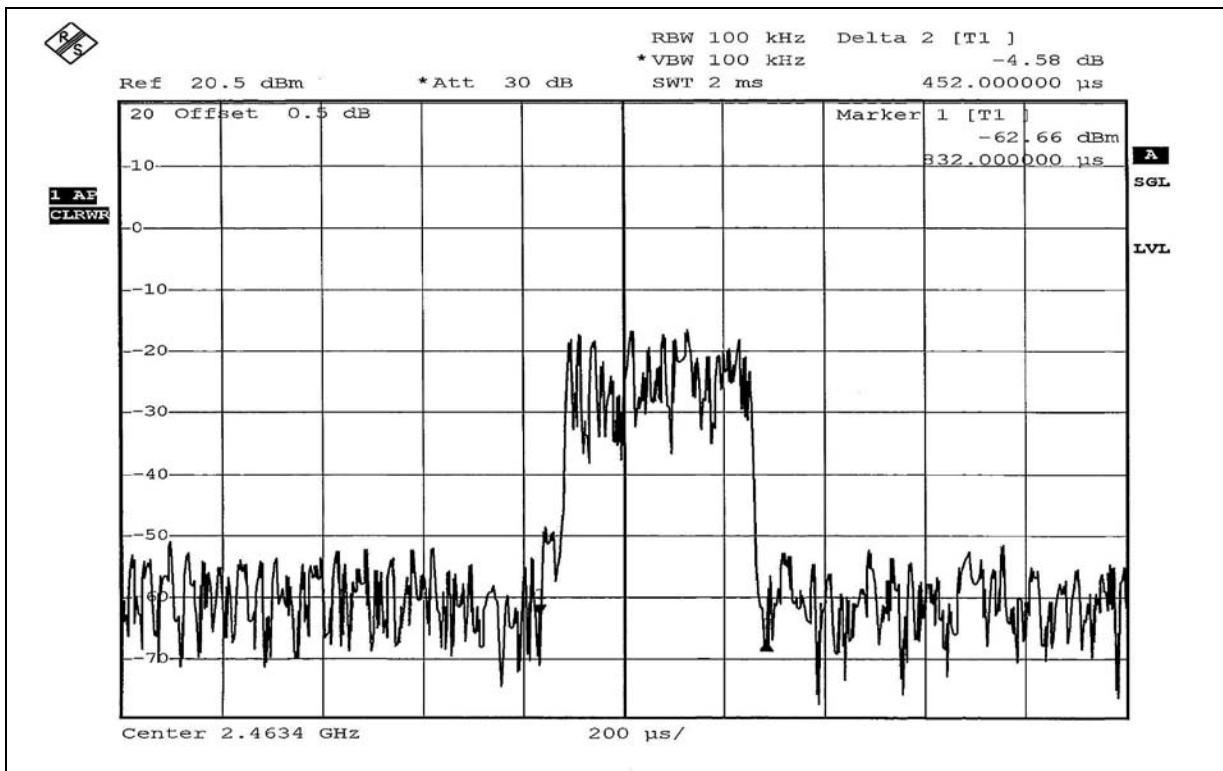
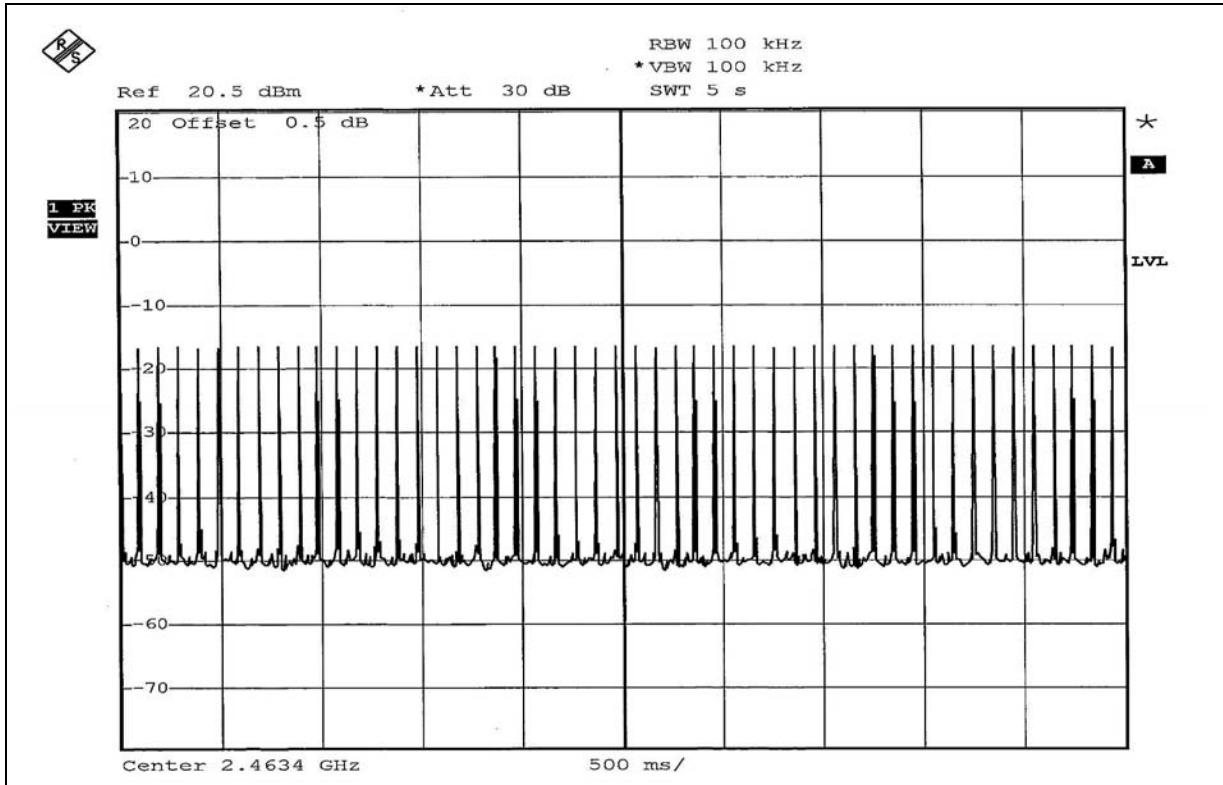



DH3

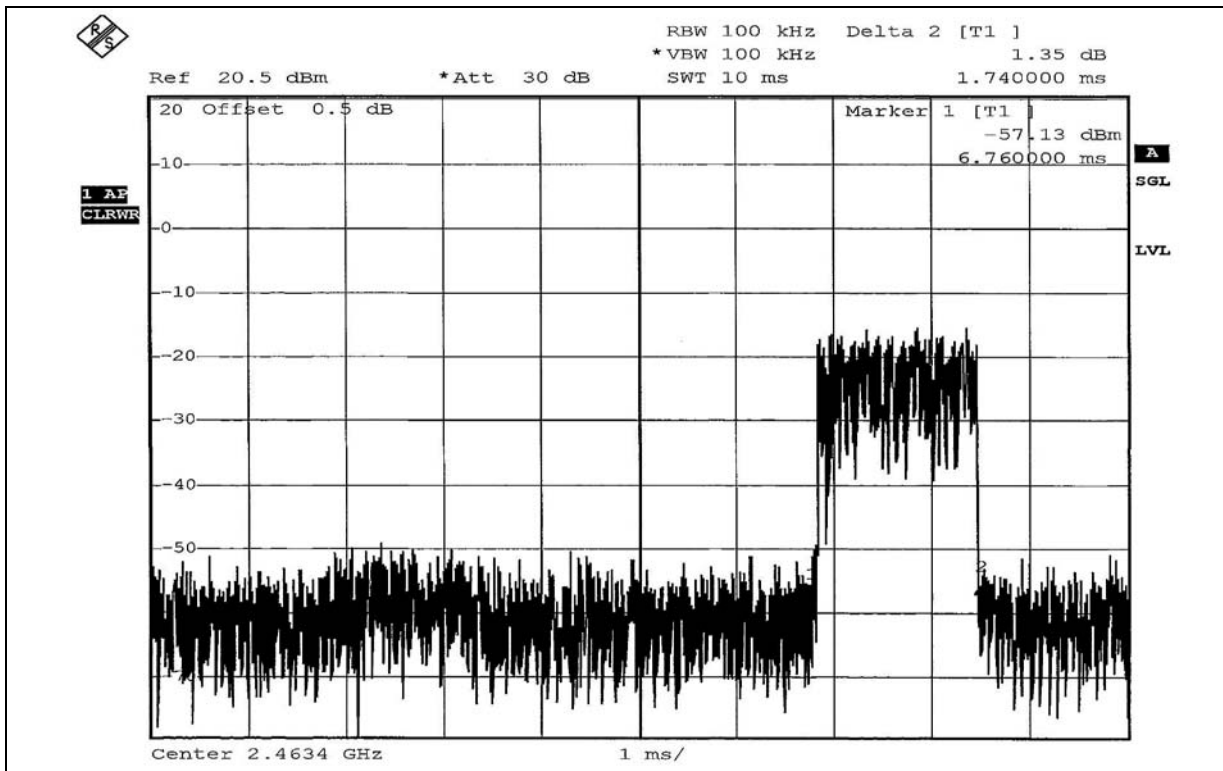
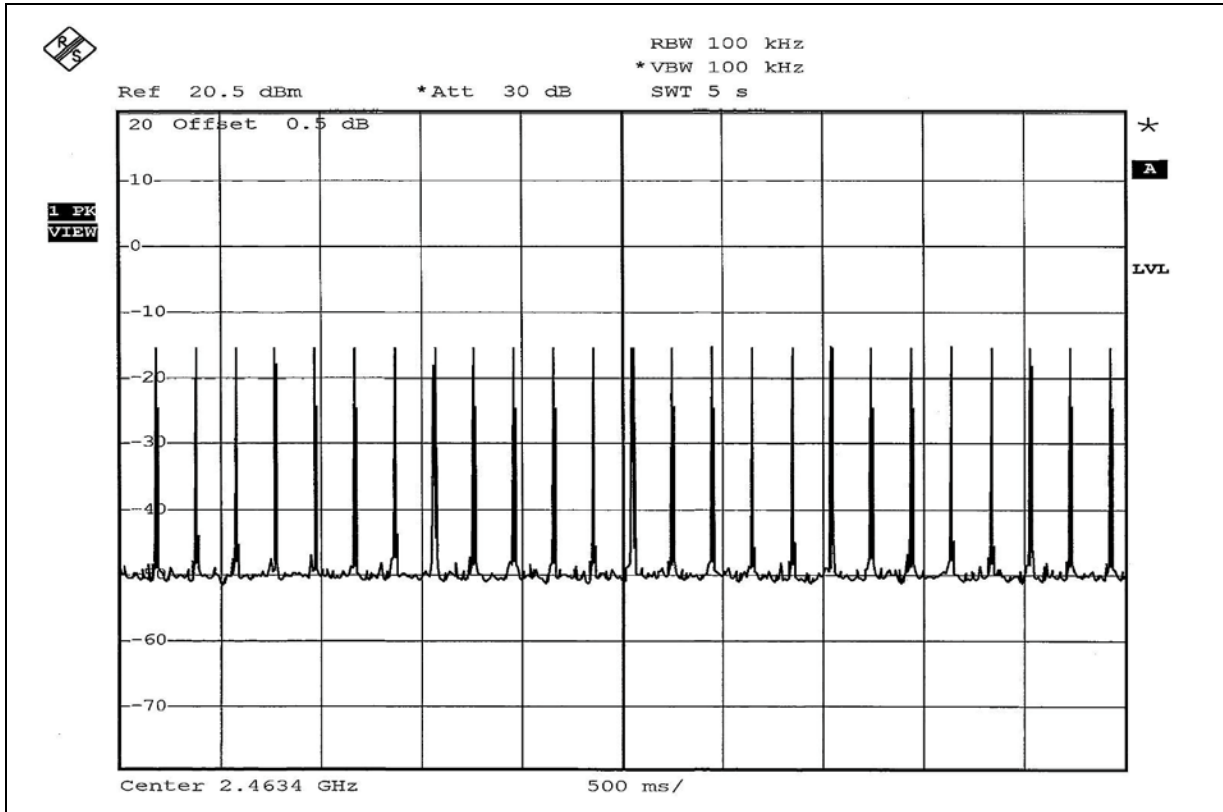



DH5

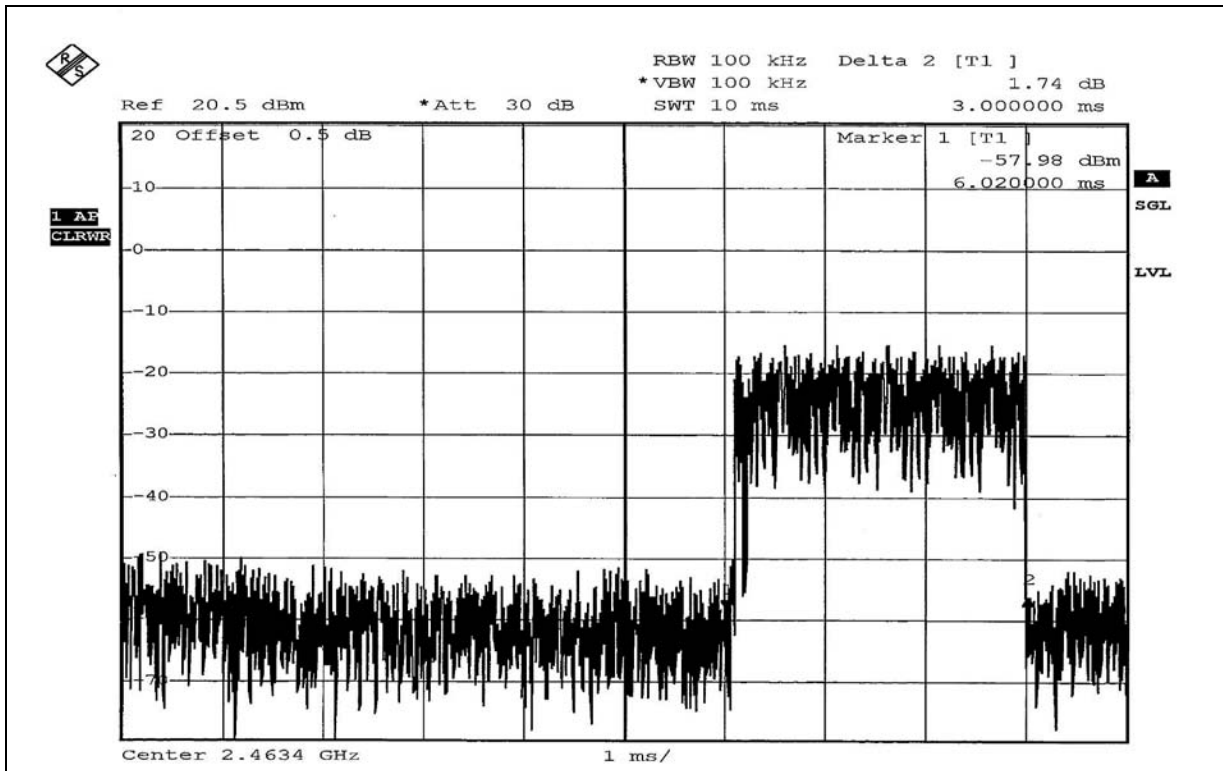
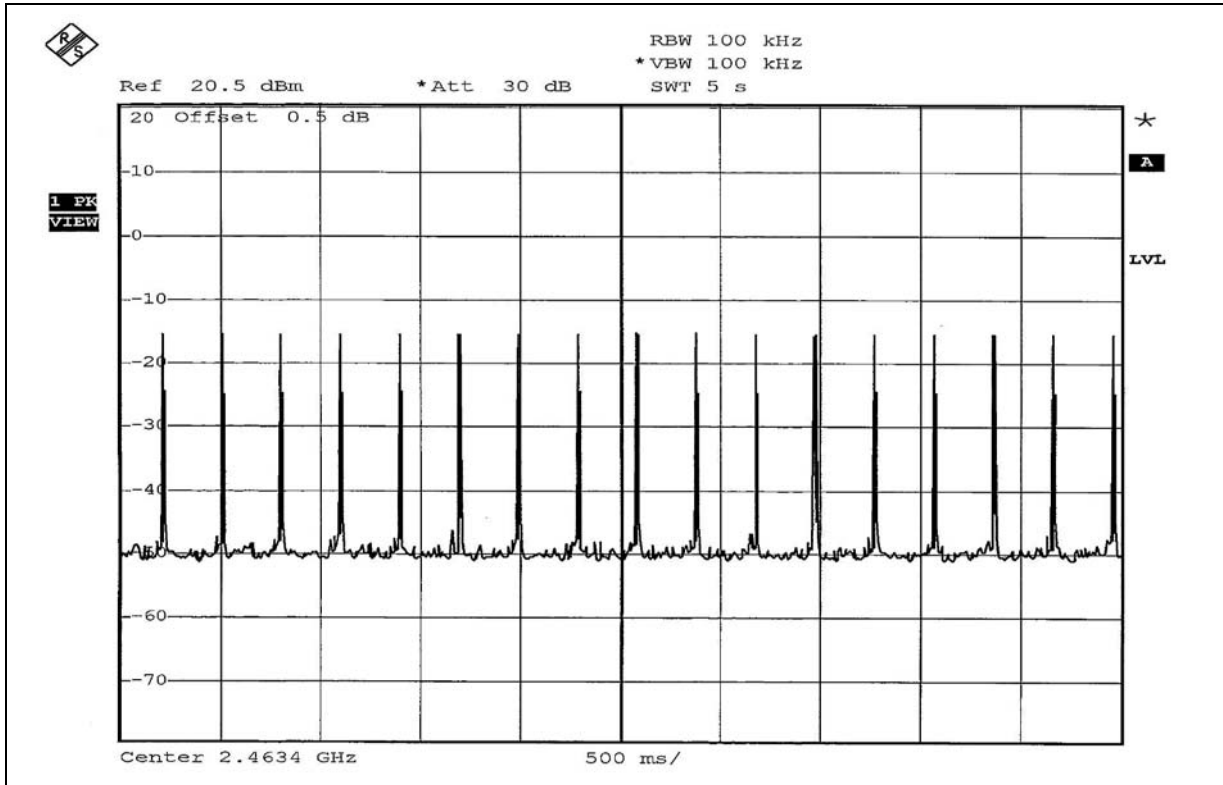

4.4 CHANNEL BANDWIDTH

4.4.1 LIMITS OF CHANNEL BANDWIDTH

For frequency hopping system operating in the 2400-2483.5MHz, If the 20dB bandwidth of hopping channel is greater than 25kHz, the 20dB bandwidth of hopping channel shall be a minimum limit for the hopping channel separation.

4.4.2 TEST INSTRUMENTS

Description & Manufacturer	Model No.	Serial No.	Calibrated Until
SPECTRUM ANALYZER	FSEK30	100049	Aug. 12, 2005

NOTE:

The calibration interval of the above test instruments is 12 months. And the calibrations are traceable to NML/ROC and NIST/USA.

4.4.3 TEST PROCEDURE

1. Check the calibration of the measuring instrument using either an internal calibrator or a known signal from an external generator.
2. Turn on the EUT and connect it to measurement instrument. Then set it to any one convenient frequency within its operating range. Set a reference level on the measuring instrument equal to the highest peak value.
3. Measure the frequency difference of two frequencies that were attenuated 20dB from the reference level. Record the frequency difference as the emission bandwidth.
4. Repeat above procedures until all frequencies measured were complete.

4.4.4 DEVIATION FROM TEST STANDARD

No deviation

4.4.5 TEST SETUP

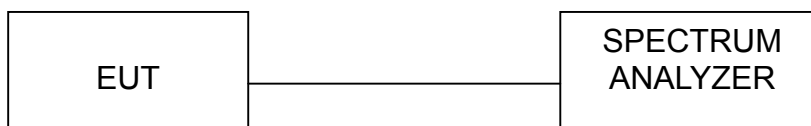

4.4.6 EUT OPERATING CONDITION

The software provided by client enabled the EUT to transmit and receive data at lowest, middle and highest channel frequencies individually.

4.4.7 TEST RESULTS

EUT	Bluetooth with Modem Combo Card	MODEL	MD560(B)
MODULATION TYPE	GFSK	ENVIRONMENTAL CONDITIONS	24 deg. C, 57% RH, 991 hPa
INPUT POWER (SYSTEM)	120Vac, 60 Hz	TESTED BY	Gary Chang

CHANNEL	CHANNEL FREQUENCY (MHz)	20dB BANDWIDTH (kHz)	More Than 25kHz
0	2402	765.00	Yes
39	2441	759.00	Yes
78	2480	765.00	Yes



Channel 0



Channel 39

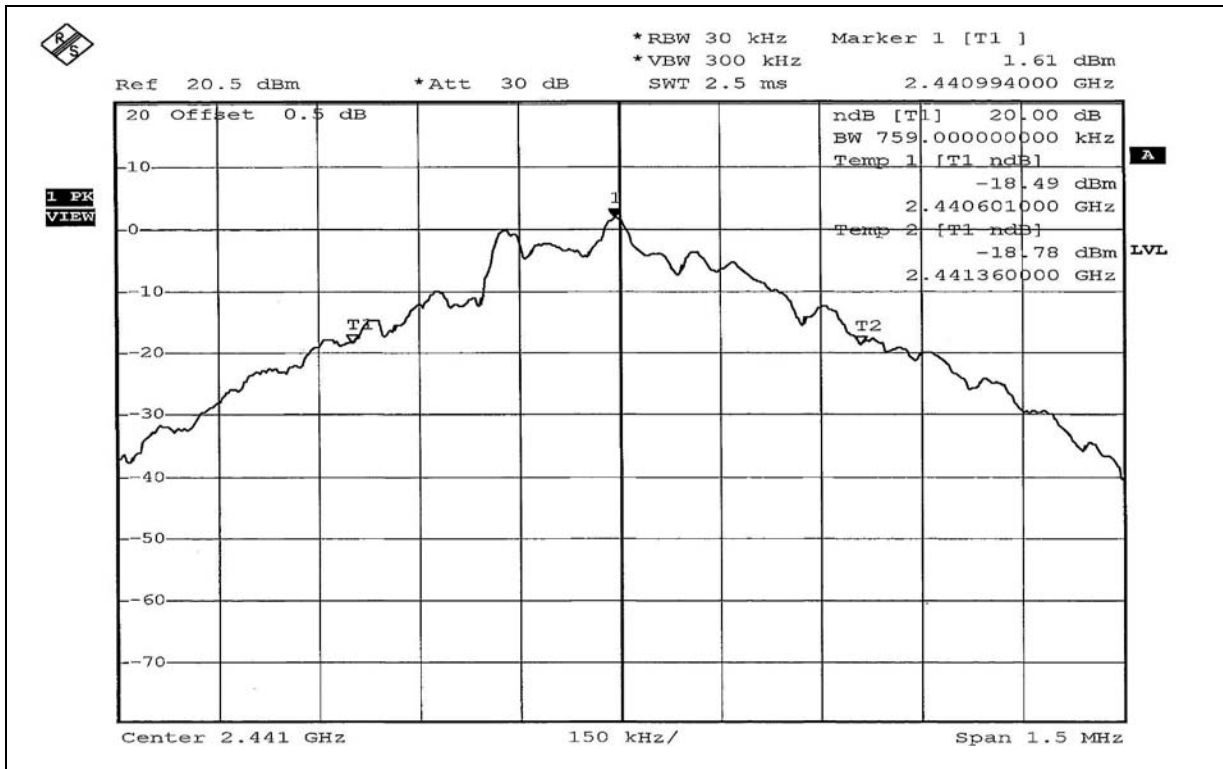



Channel 78

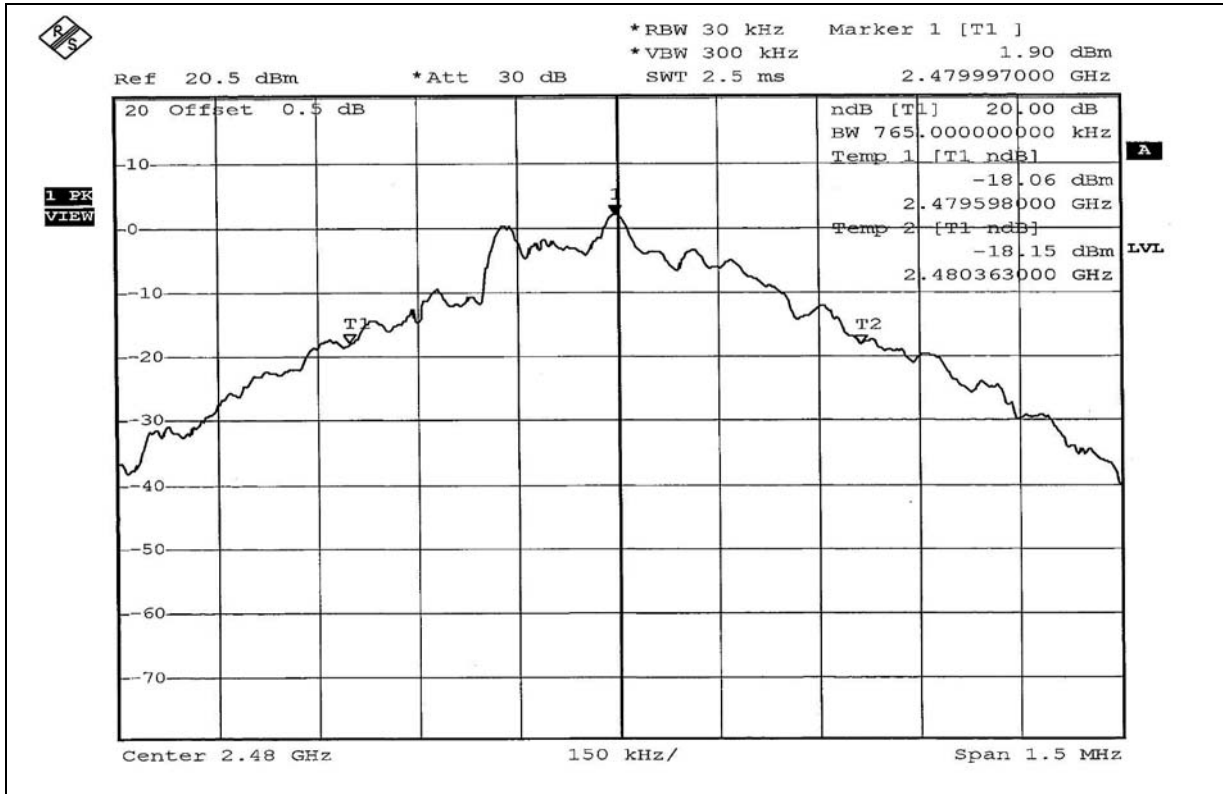

4.5 HOPPING CHANNEL SEPARATION

4.5.1 LIMIT OF HOPPING CHANNEL SEPARATION

At least 25kHz or 20dB bandwidth (whichever is greater).

4.5.2 TEST INSTRUMENTS

Description & Manufacturer	Model No.	Serial No.	Calibrated Until
SPECTRUM ANALYZER	FSEK30	100049	Aug. 12, 2005

NOTE:

The calibration interval of the above test instruments is 12 months. And the calibrations are traceable to NML/ROC and NIST/USA.

4.5.3 TEST PROCEDURES

1. Check the calibration of the measuring instrument using either an internal calibrator or a known signal from an external generator.
2. Turn on the EUT and connect it to measurement instrument. Then set it to any one convenient frequency within its operating range.
3. By using the MaxHold function record the separation of two adjacent channels.
4. Measure the frequency difference of these two adjacent channels by SA MARK function. And then plot the result on SA screen.
5. Repeat above procedures until all frequencies measured were complete.

4.5.4 DEVIATION FROM TEST STANDARD

No deviation

4.5.5 TEST SETUP

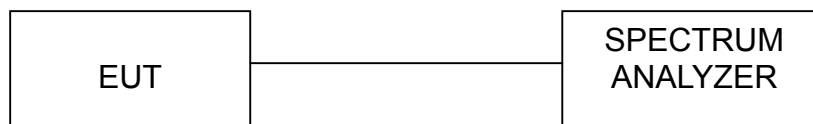

4.5.6 TEST RESULTS

EUT	Bluetooth with Modem Combo Card	MODEL	MD560(B)
MODULATION TYPE	GFSK	ENVIRONMENTAL CONDITIONS	24 deg. C, 57% RH, 991 hPa
INPUT POWER (SYSTEM)	120Vac, 60 Hz	TESTED BY	Gary Chang

Channel	Frequency (MHz)	Adjacent Channel Separation	Minimum Limit (kHz)	Pass / Fail
0	2402	1.005 MHz	765.00	PASS
39	2441	1.010 MHz	759.00	PASS
78	2480	1.005 MHz	765.00	PASS

The minimum limit is 20dB bandwidth. Test results please refer to next 2 pages.



Channel 0

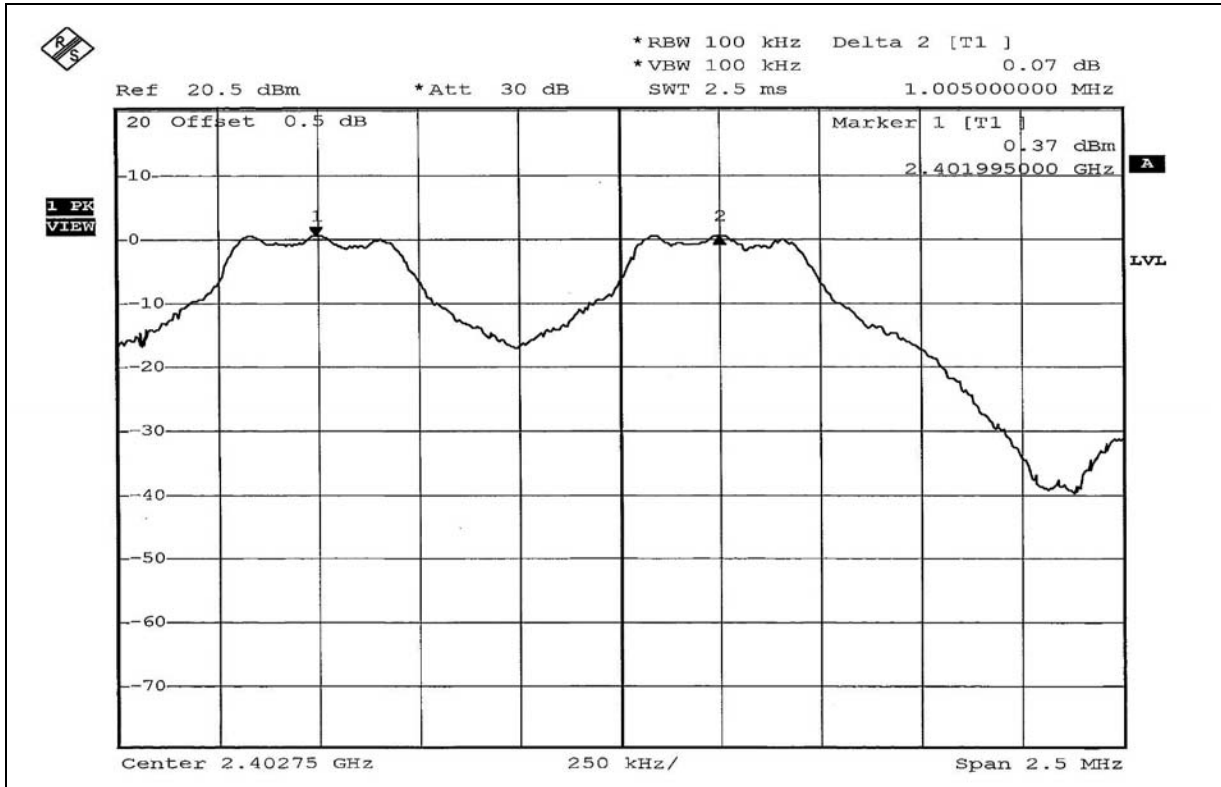

Channel 39

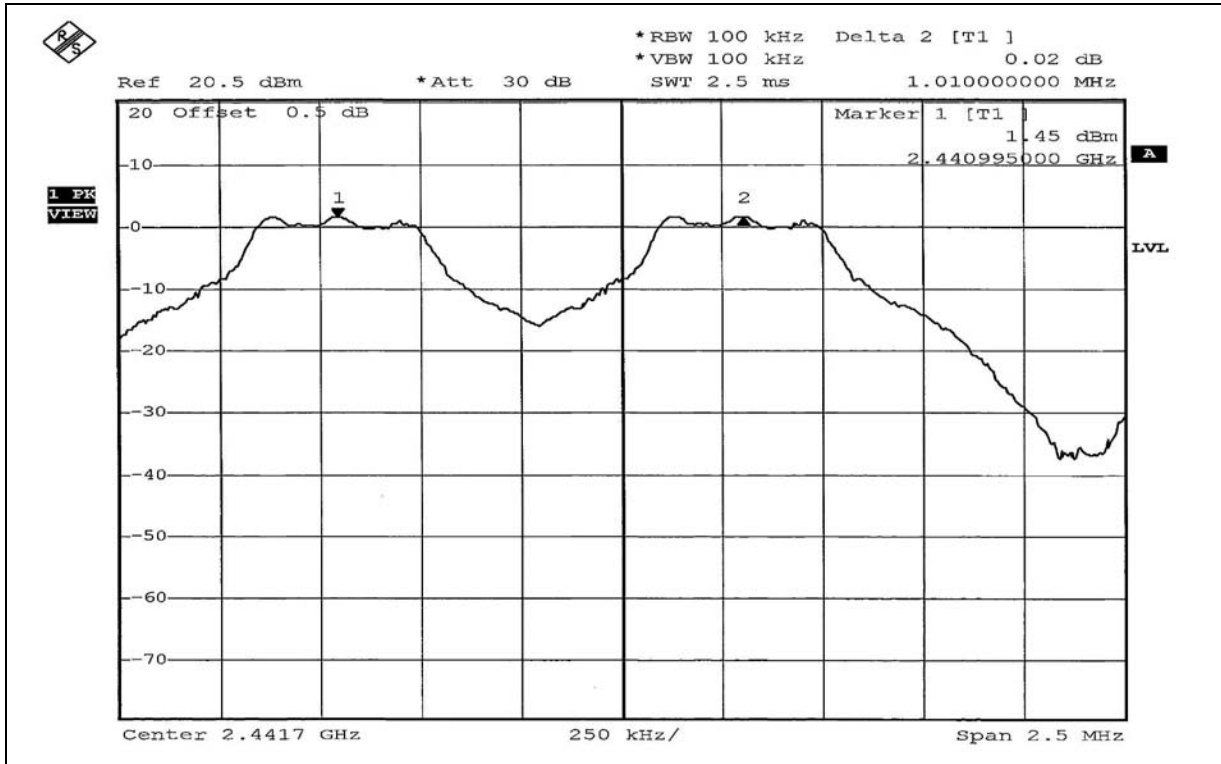



Channel 78

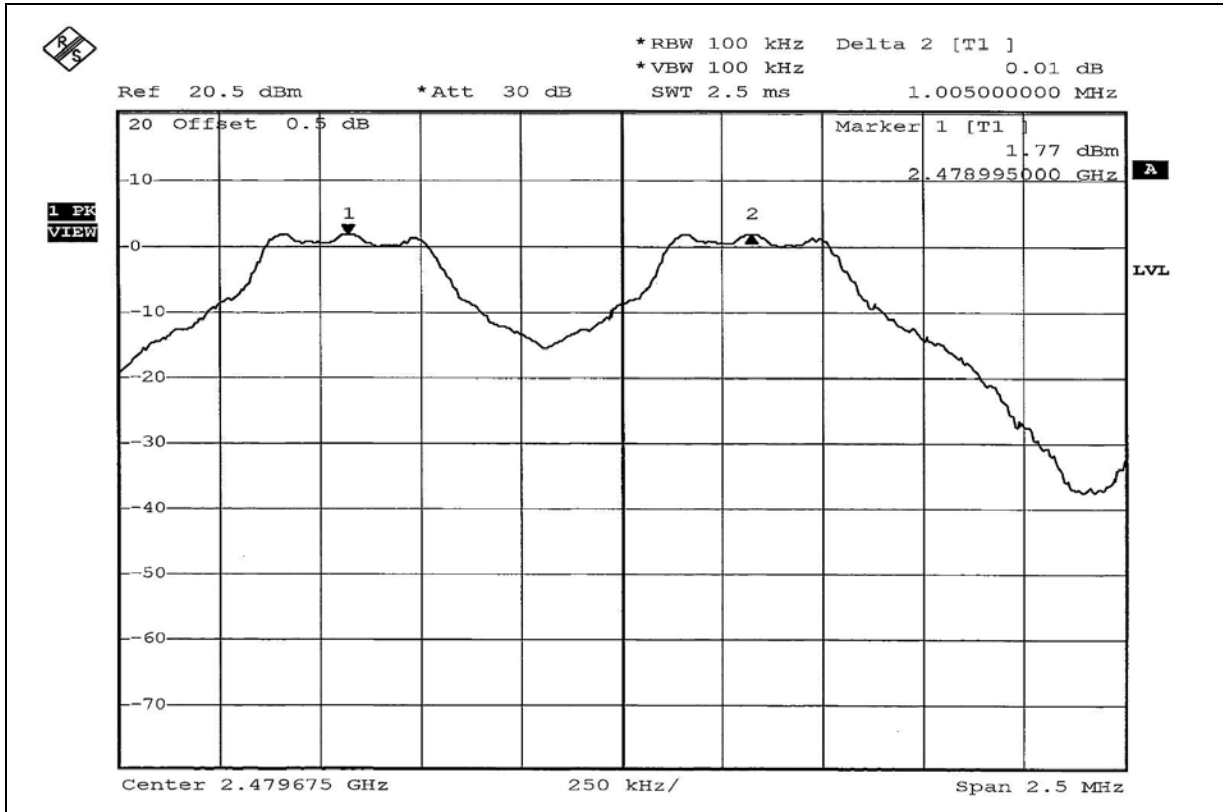

4.6 MAXIMUM PEAK OUTPUT POWER

4.6.1 LIMITS OF MAXIMUM PEAK OUTPUT POWER MEASUREMENT

The Maximum Peak Output Power Measurement is 30dBm.

4.6.2 INSTRUMENTS

Description & Manufacturer	Model No.	Serial No.	Calibrated Until
SPECTRUM ANALYZER	FSEK30	100049	Aug. 12, 2005

NOTE: The calibration interval of the above test instruments is 12 months and the calibrations are traceable to NML/ROC and NIST/USA.

4.6.3 TEST PROCEDURES

1. Check the calibration of the measuring instrument using either an internal calibrator or a known signal from an external generator.
2. Turn on the EUT and connect it to measurement instrument. Then set it to any one convenient frequency within its operating range. Set a reference level on the measuring instrument equal to the highest peak value.
3. The center frequency of the spectrum analyzer is set to the fundamental frequency and using 1 MHz RBW and 3 MHz VBW.
4. Measure the frequency difference of two frequencies that were attenuated 20dB from the reference level. Record the frequency difference as the emission bandwidth.
5. Repeat above procedures until all frequencies measured were complete.

4.6.4 DEVIATION FROM TEST STANDARD

No deviation

4.6.5 TEST SETUP

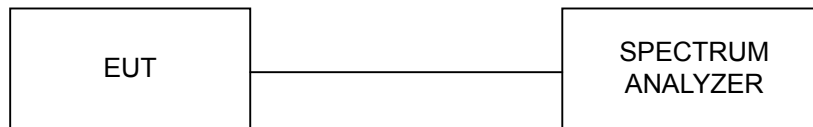

For the actual test configuration, please refer to the related Item – Photographs of the Test Configuration.

4.6.6 EUT OPERATING CONDITION

The software provided by client enabled the EUT to transmit and receive data at lowest, middle and highest channel frequencies individually.

4.6.7 TEST RESULTS

EUT	Bluetooth with Modem Combo Card	MODEL	MD560(B)
MODULATION TYPE	GFSK	ENVIRONMENTAL CONDITIONS	24 deg. C, 57% RH, 991 hPa
INPUT POWER (SYSTEM)	120Vac, 60 Hz	TESTED BY	Gary Chang

CHANNEL	CHANNEL FREQUENCY (MHz)	PEAK POWER OUTPUT (mW)	PEAK POWER OUTPUT (dBm)	PEAK POWER LIMIT (dBm)	PASS/FAIL
0	2402	1.435	1.57	30	PASS
39	2441	1.476	1.69	30	PASS
78	2480	1.578	1.98	30	PASS



Channel 0

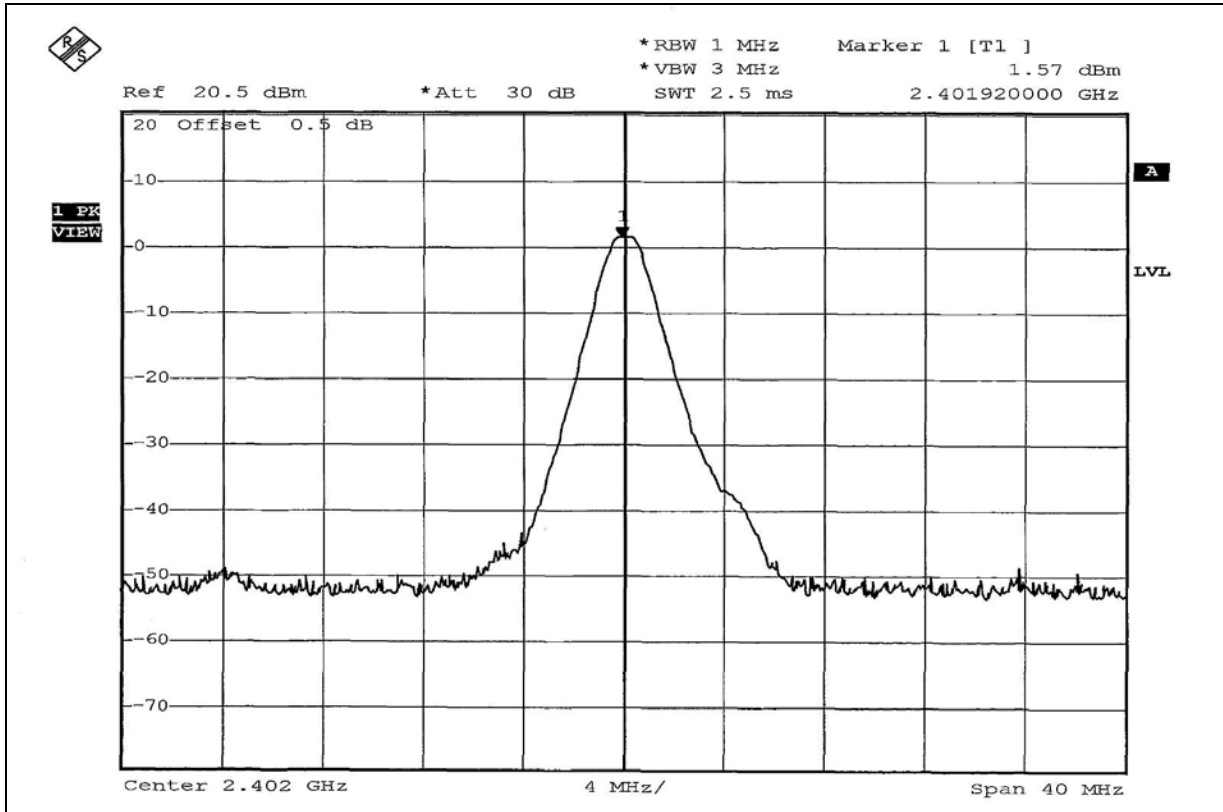

Channel 39

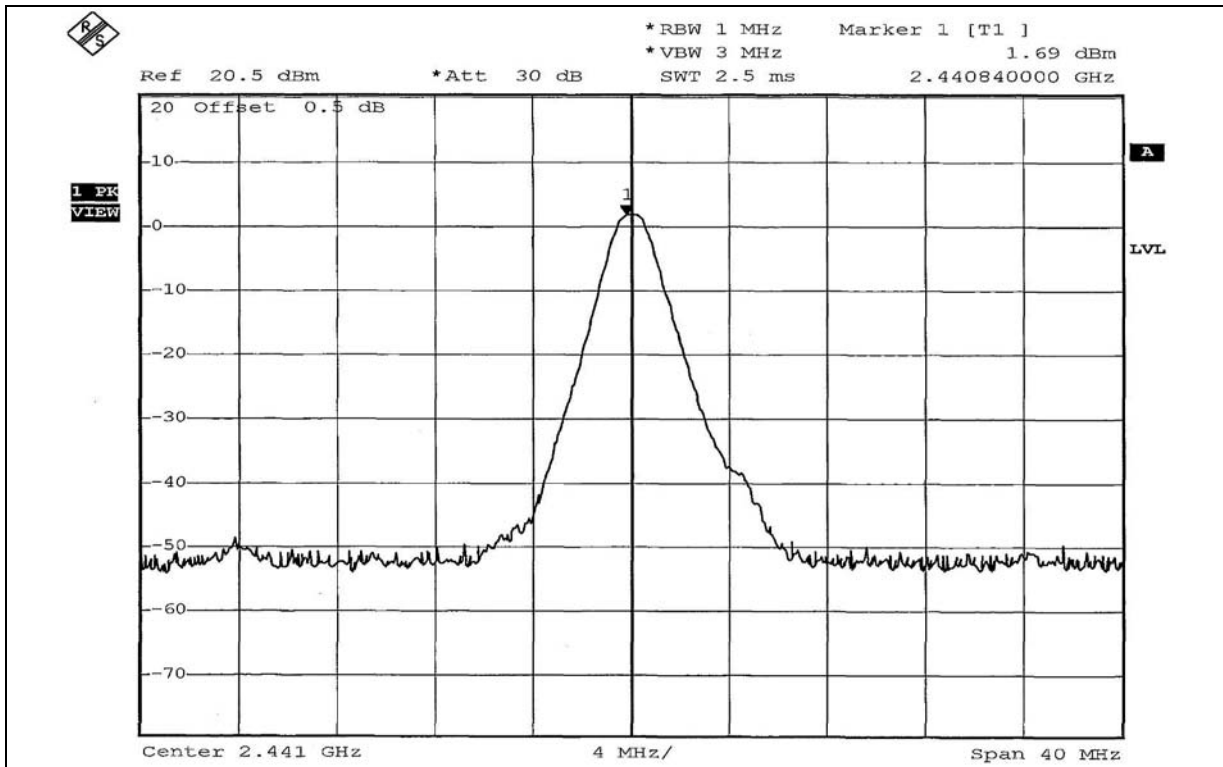



Channel 78

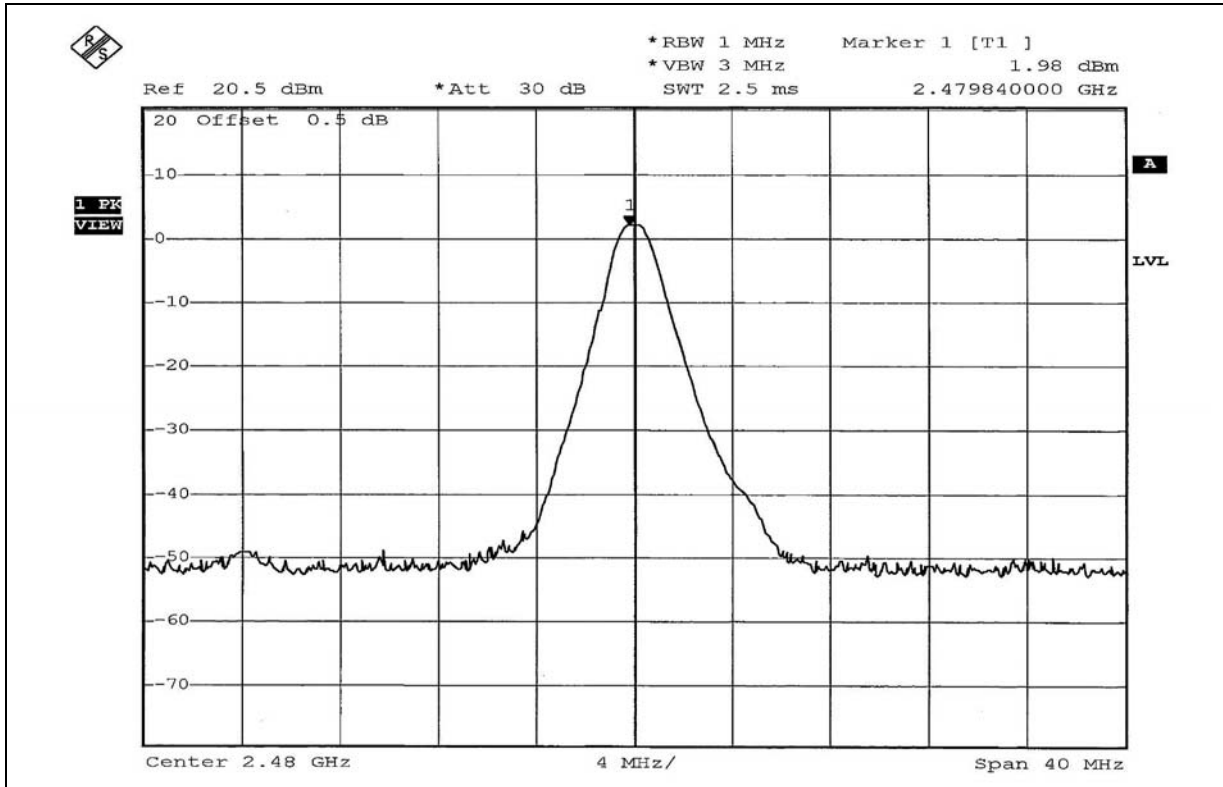

4.7 RADIATED EMISSION MEASUREMENT

4.7.1 LIMITS OF RADIATED EMISSION MEASUREMENT

Emissions radiated outside of the specified bands, shall be according to the general radiated limits in 15.209 as following:

Frequencies (MHz)	Field strength (microvolts/meter)	Measurement distance (meters)
0.009-0.490	2400/F(kHz)	300
0.490-1.705	24000/F(kHz)	30
1.705-30.0	30	30
30-88	100	3
88-216	150	3
216-960	200	3
Above 960	500	3

NOTE: The limit for radiated test was performed according to CISPR 22: 1997, which was specified in FCC PART 15B 15.109(g). Also the limits of ICES-003: 2004 and CISPR 22: 1997 are same.

4.7.2 TEST INSTRUMENTS

DESCRIPTION & MANUFACTURER	MODEL NO.	SERIAL NO.	CALIBRATED UNTIL
Test Receiver ROHDE & SCHWARZ	ESI7	100033	Jun. 08, 2005
Spectrum Analyzer ROHDE & SCHWARZ	FSP40	100040	Jun. 03, 2005
BILOG Antenna SCHWARZBECK	VULB9168	9168-160	Jun. 01, 2005
HORN Antenna SCHWARZBECK	9120D	9120D-408	Jan. 17, 2006
HORN Antenna SCHWARZBECK	BBHA 9170	BBHA9170243	Jan. 23, 2006
Preamplifier Agilent	8447D	2944A10633	Nov. 09, 2005
Preamplifier Agilent	8449B	3008A01964	Nov. 06, 2005
RF signal cable HUBER+SUHNNER	SUCOFLEX 104	218183/4	Jan. 26, 2006
RF signal cable HUBER+SUHNNER	SUCOFLEX 104	218195/4	Jan. 26, 2006
Software ADT.	ADT_Radiated_V5.14	NA	NA
Antenna Tower inn-co GmbH	MA 4000	013303	NA
Antenna Tower Controller inn-co GmbH	CO2000	017303	NA
Turn Table ADT.	TT100.	TT93021703	NA
Turn Table Controller ADT.	SC100.	SC93021703	NA

- NOTE:**
1. The calibration interval of the above test instruments is 12 months and the calibrations are traceable to NML/ROC and NIST/USA.
 2. The test was performed in HwaYa Chamber 2.
 3. The horn antenna and HP preamplifier (model: 8449B) are used only for the measurement of emission frequency above 1GHz if tested.
 4. The VCCI Site Registration No. is R-237.
 5. The IC Site Registration No. is IC4924-3.

4.7.3 TEST PROCEDURES

- a. The EUT was placed on the top of a rotating table 0.8 meters above the ground at a 3 meters semi-anechoic chamber. The table was rotated 360 degrees to determine the position of the highest radiation.
- b. The EUT was set 3 meters away from the interference-receiving antenna, which was mounted on the top of a variable-height antenna tower.
- c. The antenna is a broadband antenna, and its height is varied from one meter to four meters above the ground to determine the maximum value of the field strength. Both horizontal and vertical polarizations of the antenna are set to make the measurement.
- d. For each suspected emission, the EUT was arranged to its worst case and then the antenna was tuned to heights from 1 meter to 4 meters and the rotatable table was turned from 0 degrees to 360 degrees to find the maximum reading.
- e. The test-receiver system was set to Peak Detect Function and Specified Bandwidth with Maximum Hold Mode.
- f. If the emission level of the EUT in peak mode was 10 dB lower than the limit specified, then testing could be stopped and the peak values of the EUT would be reported. Otherwise the emissions that did not have 10 dB margin would be re-tested one by one using peak, quasi-peak or average method as specified and then reported in a data sheet.

NOTE:

1. The resolution bandwidth and video bandwidth of test receiver/spectrum analyzer is 120kHz for Peak detection (PK) and Quasi-peak detection (QP) at frequency below 1GHz.
2. The resolution bandwidth and video bandwidth of test receiver/spectrum analyzer is 1 MHz for Peak detection at frequency above 1GHz.

4.7.4 DEVIATION FROM TEST STANDARD

No deviation.

4.7.5 TEST SETUP

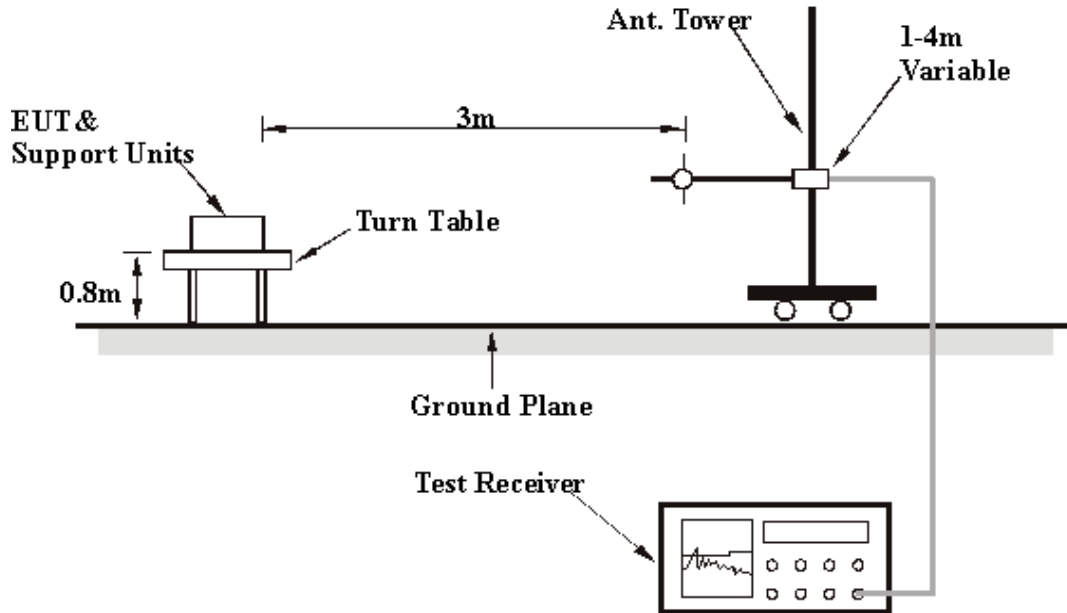

For the actual test configuration, please refer to the related item – Photographs of the Test Configuration.

4.7.6 EUT OPERATING CONDITIONS

Same as 4.1.6

4.7.7 TEST RESULTS

Below 1GHz Worst-Case Data

EUT	Bluetooth with Modem Combo Card	MEASUREMENT DETAIL	
MODEL	MD560(B)-01	FREQUENCY RANGE	Below 1000MHz
CHANNEL	Channel 78	DETECTOR FUNCTION	Quasi-Peak
MODULATION TYPE	GFSK	ENVIRONMENTAL CONDITIONS	25deg. C, 68%RH, 991hPa
TESTED BY	Morgan Chen	INPUT POWER (SYSTEM)	120Vac, 60 Hz

ANTENNA POLARITY & TEST DISTANCE: HORIZONTAL AT 3 M

No.	Freq. (MHz)	Emission Level (dBuV/m)	Limit (dBuV/m)	Margin (dB)	Antenna Height (m)	Table Angle (Degree)	Raw Value (dBuV)	Correction Factor (dB/m)
1	90.26	31.42 QP	43.50	-12.08	1.75 H	127	20.90	10.52
2	131.08	33.92 QP	43.50	-9.58	2.00 H	73	19.79	14.13
3	162.18	36.00 QP	43.50	-7.50	1.50 H	97	20.96	15.03
4	199.12	37.09 QP	43.50	-6.41	1.75 H	289	25.16	11.93
5	475.15	33.89 QP	46.00	-12.11	1.75 H	271	14.93	18.96
6	861.98	33.73 QP	46.00	-12.27	1.00 H	307	8.51	25.22

ANTENNA POLARITY & TEST DISTANCE: VERTICAL AT 3 M

No.	Freq. (MHz)	Emission Level (dBuV/m)	Limit (dBuV/m)	Margin (dB)	Antenna Height (m)	Table Angle (Degree)	Raw Value (dBuV)	Correction Factor (dB/m)
1	43.61	30.15 QP	40.00	-9.85	1.00 V	109	14.58	15.57
2	113.59	33.24 QP	43.50	-10.26	1.00 V	151	20.54	12.70
3	173.85	34.63 QP	43.50	-8.87	1.00 V	313	20.70	13.94
4	475.15	31.59 QP	46.00	-14.41	1.75 V	133	12.62	18.96
5	729.80	35.84 QP	46.00	-10.16	1.25 V	52	12.10	23.74
6	865.87	33.65 QP	46.00	-12.35	1.50 V	196	8.36	25.29

- REMARKS:**
- 1 Emission level(dBuV/m)=Raw Value(dBuV) + Correction Factor(dB/m)
 2. Correction Factor(dB/m) = Antenna Factor (dB/m) + Cable Factor (dB)
 3. The other emission levels were very low against the limit.
 4. Margin value = Emission level – Limit value.



1 ~ 25GHz Worst-Case Data

EUT	Bluetooth with Modem Combo Card	MEASUREMENT DETAIL	
MODEL	MD560(B)-01	FREQUENCY RANGE	1 ~ 25 GHz
CHANNEL	Channel 0	DETECTOR FUNCTION	Peak(PK) Average (AV)
MODULATION TYPE	GFSK	ENVIRONMENTAL CONDITIONS	25deg. C, 68%RH, 991hPa
TESTED BY	Morgan Chen	INPUT POWER (SYSTEM)	120Vac, 60 Hz

ANTENNA POLARITY & TEST DISTANCE: HORIZONTAL AT 3 M

No.	Freq. (MHz)	Emission Level (dBuV/m)	Limit (dBuV/m)	Margin (dB)	Antenna Height (m)	Table Angle (Degree)	Raw Value (dBuV)	Correction Factor (dB/m)
1	1602.00	41.85 PK	74.00	-32.15	1.90 H	11	13.11	28.74
1	1602.00	33.95 AV	54.00	-20.05	1.90 H	11	5.21	28.74
2	2390.00	37.34 PK	74.00	-36.66	1.75 H	20	6.02	31.32
3	*2402.00	97.64 PK			1.22 H	143	66.27	31.37
3	*2402.00	67.64 AV			1.22 H	143	36.27	31.37
4	4804.00	59.32 PK	74.00	-14.68	1.78 H	69	22.57	36.75
4	4804.00	29.32 AV	54.00	-24.68	1.78 H	69	-7.43	36.75

ANTENNA POLARITY & TEST DISTANCE: VERTICAL AT 3 M

No.	Freq. (MHz)	Emission Level (dBuV/m)	Limit (dBuV/m)	Margin (dB)	Antenna Height (m)	Table Angle (Degree)	Raw Value (dBuV)	Correction Factor (dB/m)
1	1602.00	41.74 PK	74.00	-32.26	1.39 V	15	13.00	28.74
1	1602.00	32.81 AV	54.00	-21.19	1.39 V	15	4.07	28.74
2	2390.00	28.75 PK	74.00	-45.25	1.29 V	31	-2.57	31.32
3	*2402.00	87.73 PK			1.24 V	20	57.82	29.91
3	*2402.00	57.73 AV			1.24 V	20	27.82	29.91
4	4804.00	59.33 PK	74.00	-14.67	1.23 V	185	22.58	36.75
4	4804.00	29.33 AV	54.00	-24.67	1.23 V	185	-7.42	36.75

- REMARKS:**
1. Emission level(dBuV/m)=Raw Value(dBuV) + Correction Factor(dB/m)
 - 2 Correction Factor(dB/m) = Antenna Factor (dB/m) + Cable Factor (dB)
 3. The other emission levels were very low against the limit.
 4. Margin value = Emission level – Limit value.
 5. “ * “ : Fundamental frequency
 6. The DH5 packet was the worse case duty cycle for a transmit dwell time on a channel, based upon bluetooth theory the transmitter is on 0.625*5 per 247 ms per channel. Therefore, the duty cycle be equal to: $20\log(3.125/100) = -30$ dB
 7. Average value = peak reading $-20\log(\text{duty cycle})$



EUT	Bluetooth with Modem Combo Card	MEASUREMENT DETAIL	
MODEL	MD560(B)-01	FREQUENCY RANGE	1 ~ 25 GHz
CHANNEL	Channel 39	DETECTOR FUNCTION	Peak(PK) Average (AV)
MODULATION TYPE	GFSK	ENVIRONMENTAL CONDITIONS	25deg. C, 68%RH, 991hPa
TESTED BY	Morgan Chen	INPUT POWER (SYSTEM)	120Vac, 60 Hz

ANTENNA POLARITY & TEST DISTANCE: HORIZONTAL AT 3 M								
No.	Freq. (MHz)	Emission Level (dBuV/m)	Limit (dBuV/m)	Margin (dB)	Antenna Height (m)	Table Angle (Degree)	Raw Value (dBuV)	Correction Factor (dB/m)
1	1627.00	41.12 PK	74.00	-32.88	1.75 H	32	12.31	28.81
1	1627.00	33.27 AV	54.00	-20.73	1.75 H	32	4.46	28.81
2	*2441.00	95.94 PK			1.17 H	157	64.40	31.54
2	*2441.00	65.94 AV			1.17 H	157	34.40	31.54
3	4882.00	60.13 PK	74.00	-13.87	1.51 H	306	23.16	36.98
3	4882.00	30.13 AV	54.00	-23.87	1.51 H	306	-6.84	36.98

ANTENNA POLARITY & TEST DISTANCE: VERTICAL AT 3 M								
No.	Freq. (MHz)	Emission Level (dBuV/m)	Limit (dBuV/m)	Margin (dB)	Antenna Height (m)	Table Angle (Degree)	Raw Value (dBuV)	Correction Factor (dB/m)
1	1627.00	40.98 PK	74.00	-33.02	1.37 V	40	12.17	28.81
1	1627.00	33.02 AV	54.00	-20.98	1.37 V	40	4.21	28.81
2	*2441.00	87.09 PK			1.78 V	219	55.55	31.54
2	*2441.00	57.09 AV			1.78 V	219	25.55	31.54
3	4882.00	59.97 PK	74.00	-14.03	1.40 V	22	22.99	36.98
3	4882.00	29.92 AV	54.00	-24.08	1.40 V	22	-7.06	36.98

- REMARKS:**
1. Emission level(dBuV/m)=Raw Value(dBuV) + Correction Factor(dB/m)
 2. Correction Factor(dB/m) = Antenna Factor (dB/m) + Cable Factor (dB)
 3. The other emission levels were very low against the limit.
 4. Margin value = Emission level – Limit value.
 5. “ * “ : Fundamental frequency
 6. The DH5 packet was the worse case duty cycle for a transmit dwell time on a channel, based upon bluetooth theory the transmitter is on 0.625*5 per 247 ms per channel. Therefore, the duty cycle be equal to: $20\log(3.125/100) = -30$ dB
 7. Average value = peak reading $-20\log(\text{duty cycle})$



EUT	Bluetooth with Modem Combo Card	MEASUREMENT DETAIL	
MODEL	MD560(B)-01	FREQUENCY RANGE	1 ~ 25 GHz
CHANNEL	Channel 78	DETECTOR FUNCTION	Peak(PK) Average (AV)
MODULATION TYPE	GFSK	ENVIRONMENTAL CONDITIONS	25deg. C, 68%RH, 991hPa
TESTED BY	Morgan Chen	INPUT POWER (SYSTEM)	120Vac, 60 Hz

ANTENNA POLARITY & TEST DISTANCE: HORIZONTAL AT 3 M

No.	Freq. (MHz)	Emission Level (dBuV/m)	Limit (dBuV/m)	Margin (dB)	Antenna Height (m)	Table Angle (Degree)	Raw Value (dBuV)	Correction Factor (dB/m)
1	1653.00	47.91 PK	74.00	-26.09	1.25 H	45	19.03	28.88
1	1653.00	42.85 AV	54.00	-11.15	1.25 H	45	13.97	28.88
2	*2480.00	96.83 PK			1.42 H	162	65.13	31.70
2	*2480.00	66.83 AV			1.42 H	162	35.13	31.70
3	2483.50	38.42 PK	74.00	-35.58	1.42 H	162	6.70	31.72
4	4960.00	64.75 PK	74.00	-9.25	1.34 H	35	27.53	37.22
4	4960.00	34.58 AV	54.00	-19.42	1.34 H	35	-2.64	37.22

ANTENNA POLARITY & TEST DISTANCE: VERTICAL AT 3 M

No.	Freq. (MHz)	Emission Level (dBuV/m)	Limit (dBuV/m)	Margin (dB)	Antenna Height (m)	Table Angle (Degree)	Raw Value (dBuV)	Correction Factor (dB/m)
1	1653.00	47.11 PK	74.00	-26.89	1.01 V	112	18.23	28.88
1	1653.00	42.32 AV	54.00	-11.68	1.01 V	112	13.44	28.88
2	*2480.00	86.41 PK			1.55 V	269	54.71	31.70
2	*2480.00	56.41 AV			1.55 V	269	24.71	31.70
3	2483.50	28.14 PK	74.00	-45.86	1.55 V	269	-3.58	31.72
4	4960.00	63.25 PK	74.00	-10.75	1.42 V	311	26.03	37.22
4	4960.00	33.42 AV	54.00	-20.58	1.42 V	311	-3.80	37.22

- REMARKS:**
1. Emission level(dBuV/m)=Raw Value(dBuV) + Correction Factor(dB/m)
 - 2 Correction Factor(dB/m) = Antenna Factor (dB/m) + Cable Factor (dB)
 3. The other emission levels were very low against the limit.
 4. Margin value = Emission level – Limit value.
 5. “ * “ : Fundamental frequency
 6. The DH5 packet was the worse case duty cycle for a transmit dwell time on a channel, based upon bluetooth theory the transmitter is on 0.625*5 per 247 ms per channel. Therefore, the duty cycle be equal to: $20\log(3.125/100) = -30$ dB
 7. Average value = peak reading $-20\log(\text{duty cycle})$

4.8 BAND EDGES MEASUREMENT

4.8.1 LIMITS OF BAND EDGES MEASUREMENT

Below -20dB of the highest emission level of operating band (in 100KHz RBW).

4.8.2 TEST INSTRUMENTS

Description & Manufacturer	Model No.	Serial No.	Calibrated Until
SPECTRUM ANALYZER	FSEK30	100049	Aug. 12, 2005

NOTE:

The calibration interval of the above test instruments is 12 months. And the calibrations are traceable to NML/ROC and NIST/USA.

4.8.3 TEST PROCEDURE

The transmitter output was connected to the spectrum analyzer via a low lose cable. Set both RBW and VBW of spectrum analyzer to 100 kHz with suitable frequency span including 100 MHz bandwidth from band edge. The band edges was measured and recorded.

4.8.4 DEVIATION FROM TEST STANDARD

No deviation

4.8.5 EUT OPERATING CONDITION

The software provided by client enabled the EUT to transmit and receive data at lowest, middle and highest channel frequencies individually.

4.8.6 TEST RESULTS

The spectrum plots are attached on the following 4 images. D2 line indicates the highest level, D1 line indicates the 20dB offset below D2. It shows compliance with the requirement in part 15.247(d).

NOTE 1: The band edge emission plot on page 57 shows 49.22dBc between carrier maximum power and local maximum emission in restrict band (2.3504GHz). The emission of carrier strength list in the test result of channel 0 at the item 4.7.7 is 97.64BuV/m (Peak), so the maximum field strength in restrict band is $97.64 - 49.22 = 48.42$ dBuV/m which is under 74 dBuV/m limit.

The band edge emission plot on page 57 shows 49.22dBc between carrier maximum power and local maximum emission in restrict band (2.3504GHz). The emission of carrier strength list in the test result of channel 0 at the item 4.7.7 is 67.64dBuV/m (Average), so the maximum field strength in restrict band is $67.64 - 49.22 = 18.42$ dBuV/m which is under 54 dBuV/m limit.

NOTE 2: The band edge emission plot on page 58 shows 46.51dBc between carrier maximum power and local maximum emission in restrict band (2.4846GHz). The emission of carrier strength list in the test result of channel 78 at the item 4.7.7 is 96.83dBuV/m (Peak), so the maximum field strength in restrict band is $96.83 - 46.51 = 50.32$ dBuV/m which is under 74 dBuV/m limit.

The band edge emission plot on page 58 shows 46.51dBc between carrier maximum power and local maximum emission in restrict band (2.4846GHz). The emission of carrier strength list in the test result of channel 78 at the item 4.7.7 is 66.83dBuV/m (Average), so the maximum field strength in restrict band is $66.83 - 46.51 = 20.32$ dBuV/m which is under 54 dBuV/m limit.

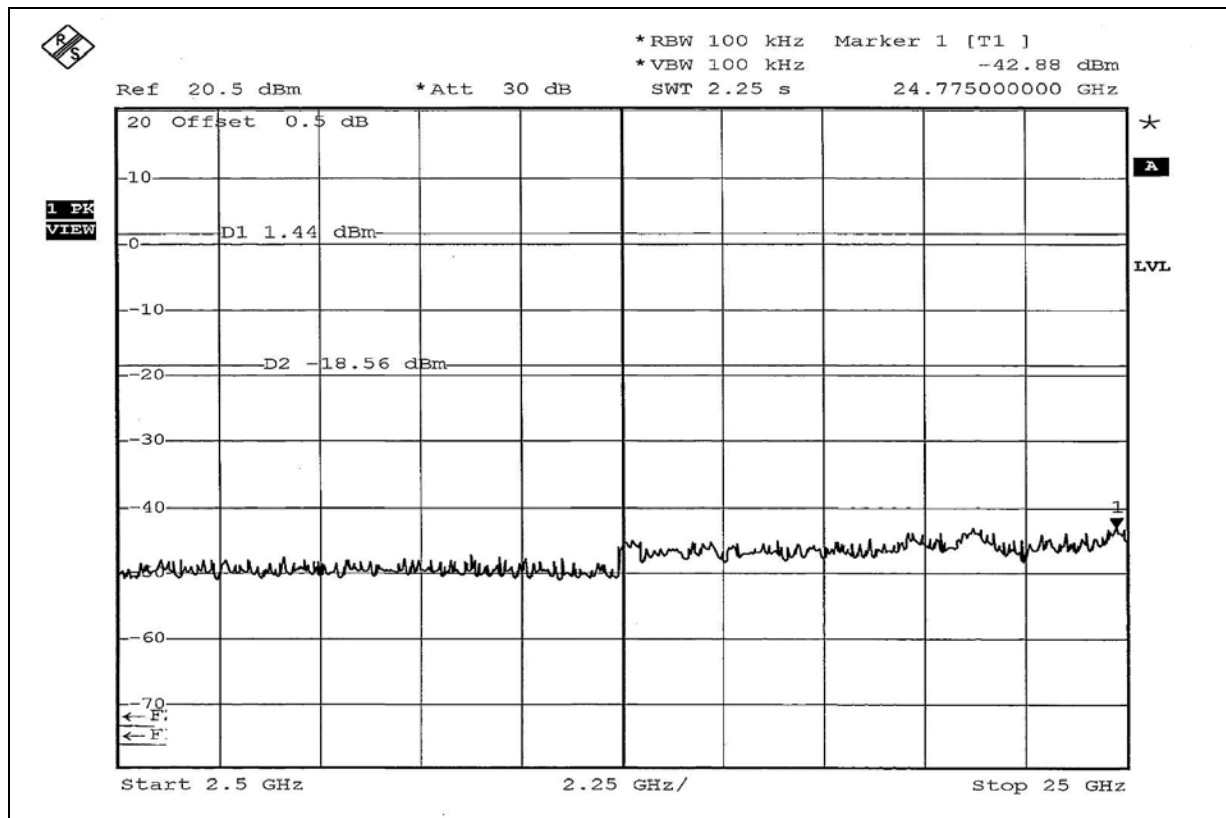
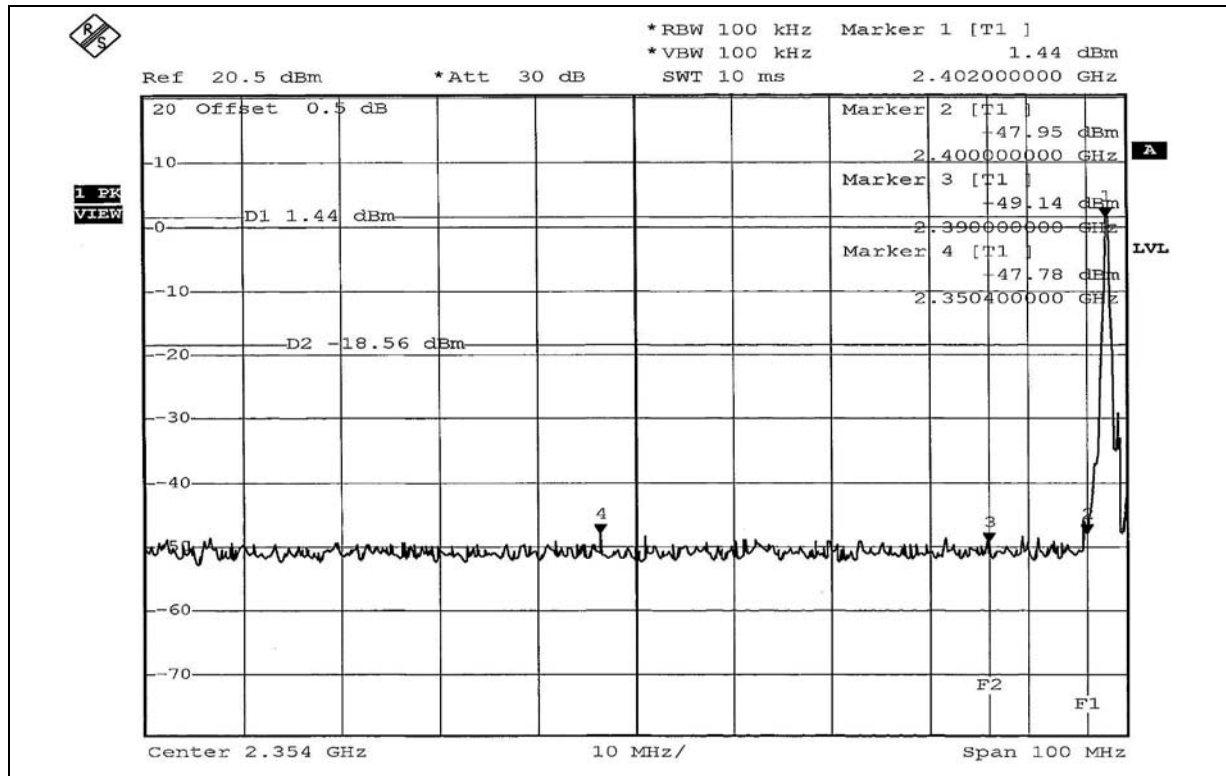

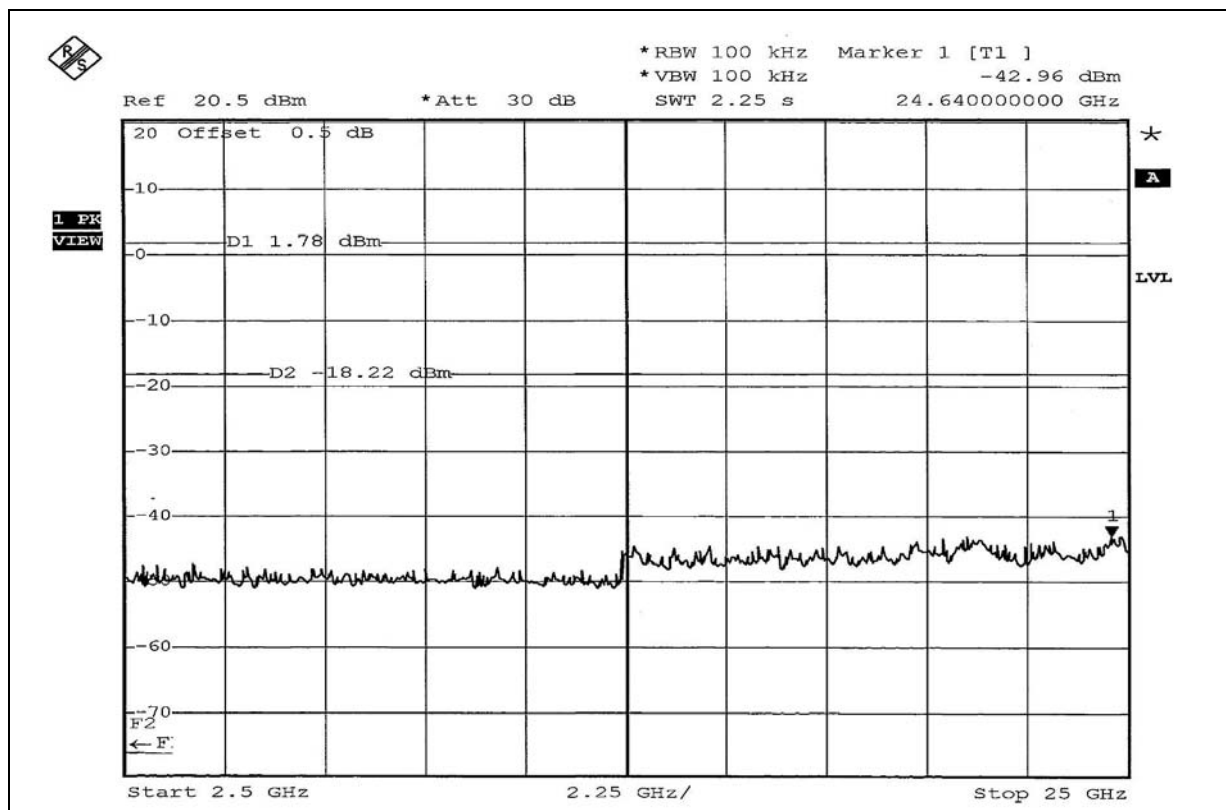
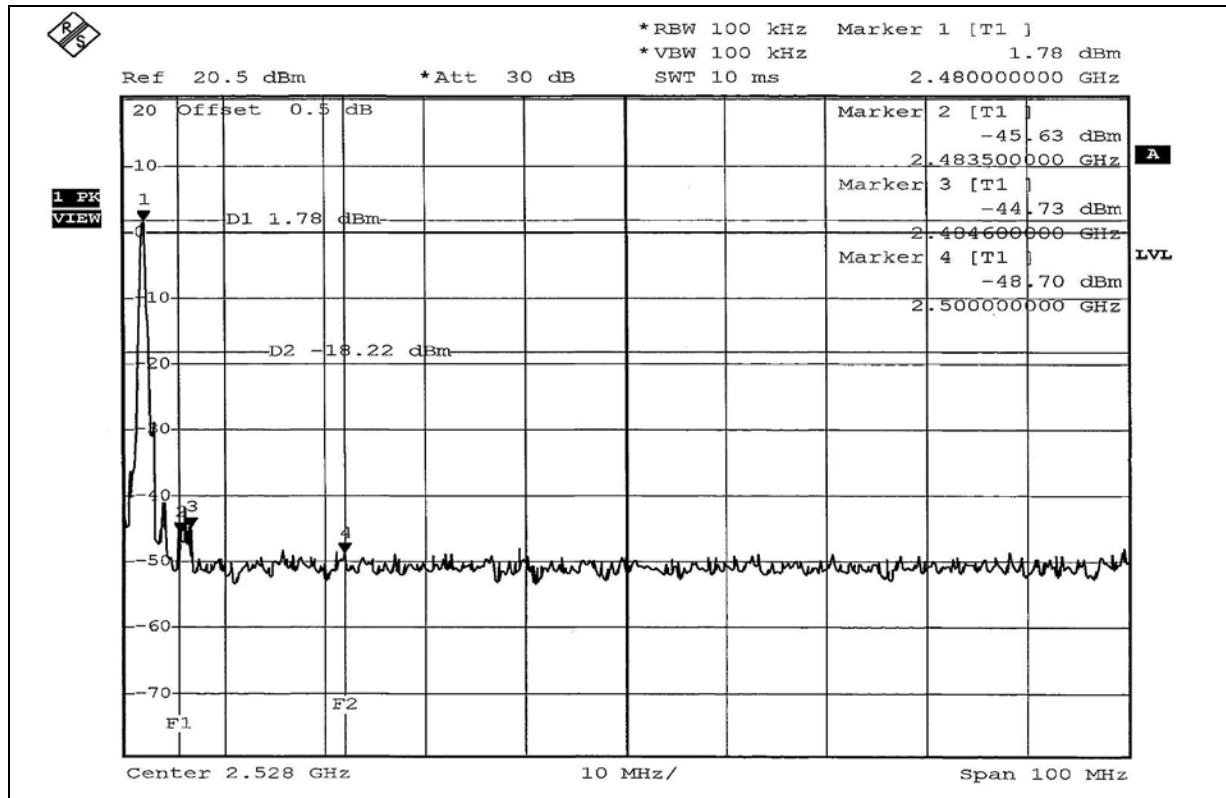



4.9 ANTENNA REQUIREMENT

4.9.1 STANDARD APPLICABLE

For intentional device, according to FCC 47 CFR Section 15.203, an intentional radiator shall be designed to ensure that no antenna other than that furnished by the responsible party shall be used with the device.

And according to FCC 47 CFR Section 15.247 (b), if transmitting antennas of directional gain greater than 6 dBi are used, the power shall be reduced by the amount in dB that the directional gain of the antenna exceeds 6 dBi.

4.9.2 ANTENNA CONNECTED CONSTRUCTION

The antenna used in this product is Film antenna with UFL antenna connector. The maximum gain of this antenna is -1.17dBi.

5 PHOTOGRAPHS OF THE TEST CONFIGURATION CONDUCTED EMISSION TEST





RADIATED EMISSION TEST

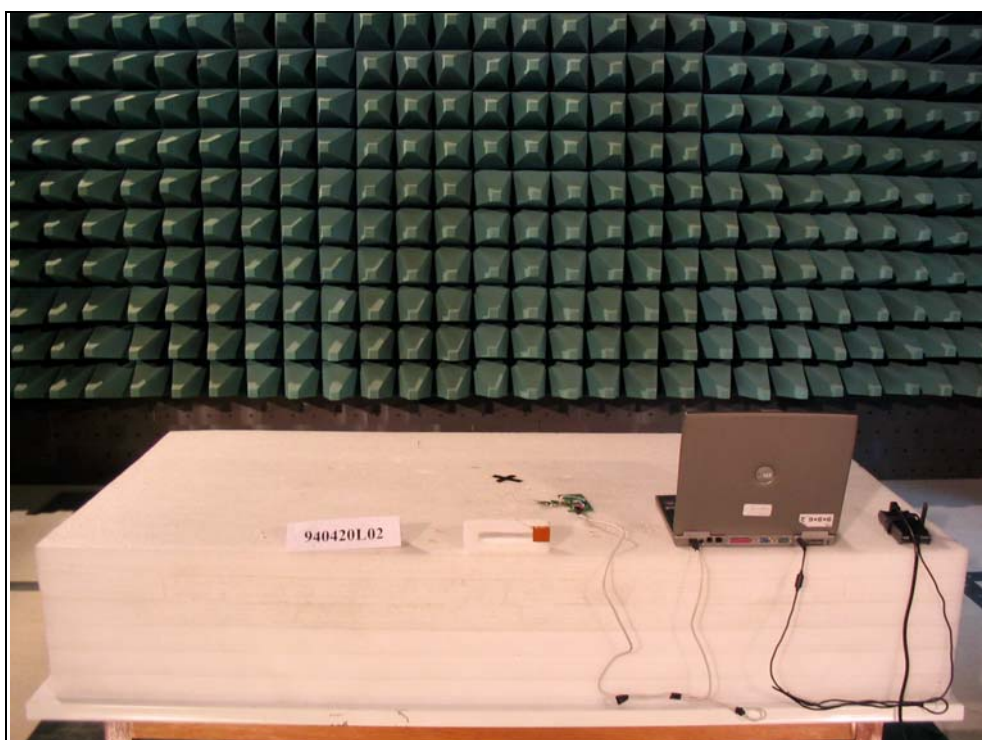
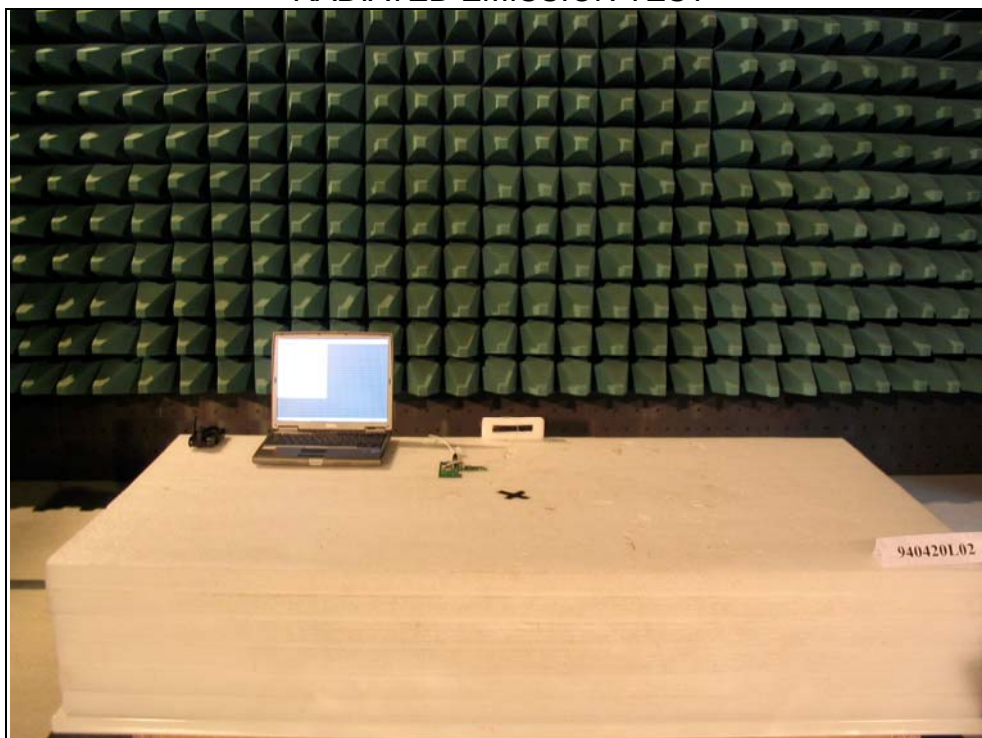



6 INFORMATION ON THE TESTING LABORATORIES

We, ADT Corp., were founded in 1988 to provide our best service in EMC, Radio, Telecom and Safety consultation. Our laboratories are accredited and approved by the following approval agencies according to ISO/IEC 17025.

USA	FCC, NVLAP, UL, A2LA
Germany	TUV Rheinland
Japan	VCCI
Norway	NEMKO
Canada	INDUSTRY CANADA , CSA
R.O.C.	CNLA, BSMI, DGT
Netherlands	Telefication
Singapore	PSB , GOST-ASIA(MOU)
Russia	CERTIS(MOU)

Copies of accreditation certificates of our laboratories obtained from approval agencies can be downloaded from our web site: www.adt.com.tw/index.5/phtml.
If you have any comments, please feel free to contact us at the following:

Linko EMC/RF Lab:

Tel: 886-2-26052180
Fax: 886-2-26052943

Hsin Chu EMC/RF Lab:

Tel: 886-3-5935343
Fax: 886-3-5935342

Hwa Ya EMC/RF/Safety/Telecom Lab:

Tel: 886-3-3183232
Fax: 886-3-3185050

Linko RF Lab.

Tel: 886-3-3270910
Fax: 886-3-3270892

Web Site: www.adt.com.tw

The address and road map of all our labs can be found in our web site also.