



FCC TEST REPORT

REPORT NO.: RF960323L04

MODEL NO.: LR802UKG

RECEIVED: Mar. 23, 2007

TESTED: Mar. 29 ~ May 10, 2007

ISSUED: May 15, 2007

APPLICANT: Qcom Technology Inc.

ADDRESS: 7F, NO.178, MING CHUAN E. RD. SEC 3, TAIPEI
TAIWAN R.O.C.

ISSUED BY: Advance Data Technology Corporation

LAB ADDRESS: No. 47, 14th Ling, Chia Pau Tsuen, Lin Kou
Hsiang 244, Taipei Hsien, Taiwan, R.O.C.

TEST LOCATION: No. 19, Hwa Ya 2nd Rd., Wen Hwa Tsuen, Kwei
Shan Hsiang, Taoyuan Hsien 333, Taiwan,
R.O.C.

This test report consists of 71 pages in total. It may be duplicated completely for legal use with the approval of the applicant. It should not be reproduced except in full, without the written approval of our laboratory. The client should not use it to claim product endorsement by CNLA, A2LA or any government agencies. The test results in the report only apply to the tested sample.





Table of Contents

1.	CERTIFICATION	4
2.	SUMMARY OF TEST RESULTS.....	5
2.1	MEASUREMENT UNCERTAINTY	5
3.	GENERAL INFORMATION	6
3.1	GENERAL DESCRIPTION OF EUT.....	6
3.2	DESCRIPTION OF TEST MODES.....	7
3.2.1	CONFIGURATION OF SYSTEM UNDER TEST.....	7
3.2.2	TEST MODE APPLICABILITY AND TESTED CHANNEL DETAIL	8
3.3	GENERAL DESCRIPTION OF APPLIED STANDARDS.....	10
3.4	DESCRIPTION OF SUPPORT UNITS.....	10
4.	TEST TYPES AND RESULTS	11
4.1	CONDUCTED EMISSION MEASUREMENT.....	11
4.1.1	LIMITS OF CONDUCTED EMISSION MEASUREMENT	11
4.1.2	TEST INSTRUMENTS	11
4.1.3	TEST PROCEDURES	12
4.1.4	DEVIATION FROM TEST STANDARD	12
4.1.5	TEST SETUP	13
4.1.6	EUT OPERATING CONDITIONS.....	13
4.1.7	TEST RESULTS	14
4.2	RADIATED EMISSION MEASUREMENT.....	20
4.2.1	LIMITS OF RADIATED EMISSION MEASUREMENT	20
4.2.2	TEST INSTRUMENTS	21
4.2.3	TEST PROCEDURES	22
4.2.4	DEVIATION FROM TEST STANDARD	22
4.2.5	TEST SETUP	23
4.2.6	EUT OPERATING CONDITIONS.....	23
4.2.7	TEST RESULTS	24
4.3	6DB BANDWIDTH MEASUREMENT.....	38
4.3.1	LIMITS OF 6DB BANDWIDTH MEASUREMENT.....	38
4.3.2	TEST INSTRUMENTS	38
4.3.3	TEST PROCEDURE	39
4.3.4	DEVIATION FROM TEST STANDARD	39
4.3.5	TEST SETUP	39
4.3.6	EUT OPERATING CONDITIONS.....	39
4.3.7	TEST RESULTS	40
4.4	MAXIMUM PEAK OUTPUT POWER	46
4.4.1	LIMITS OF MAXIMUM PEAK OUTPUT POWER MEASUREMENT	46
4.4.2	INSTRUMENTS.....	46
4.4.1	TEST PROCEDURES	47
4.4.2	DEVIATION FROM TEST STANDARD	47
4.4.3	TEST SETUP	47
4.4.4	EUT OPERATING CONDITIONS.....	47
4.4.3	TEST RESULTS	48
4.5	POWER SPECTRAL DENSITY MEASUREMENT	49



4.5.1	LIMITS OF POWER SPECTRAL DENSITY MEASUREMENT.....	49
4.5.2	TEST INSTRUMENTS	49
4.5.3	TEST PROCEDURE	50
4.5.4	DEVIATION FROM TEST STANDARD	50
4.5.5	TEST SETUP	50
4.5.6	EUT OPERATING CONDITION	50
4.5.7	TEST RESULTS	51
4.6	BAND EDGES MEASUREMENT	57
4.6.1	LIMITS OF BAND EDGES MEASUREMENT	57
4.6.2	TEST INSTRUMENTS	57
4.6.3	TEST PROCEDURE	57
4.6.4	DEVIATION FROM TEST STANDARD	57
4.6.5	EUT OPERATING CONDITION	57
4.6.6	TEST RESULTS	58
4.7	ANTENNA REQUIREMENT	68
4.7.1	STANDARD APPLICABLE	68
4.7.2	ANTENNA CONNECTED CONSTRUCTION.....	68
5.	PHOTOGRAPHS OF THE TEST CONFIGURATION	69
6.	INFORMATION ON THE TESTING LABORATORIES.....	70
APPENDIX-A	A-1



1. CERTIFICATION

PRODUCT: 802.11b/g Wireless LAN USB Module
MODEL: LR802UKG
BRAND: Qcom Technology Inc.
APPLICANT: Qcom Technology Inc.
TESTED: Mar. 29 ~ May 10, 2007
TEST SAMPLE: ENGINEERING SAMPLE
STANDARDS: **FCC Part 15, Subpart C (Section 15.247)**
ANSI C63.4-2003

The above equipment (model: LR802UKG) have been tested by **Advance Data Technology Corporation**, and found compliance with the requirement of the above standards. The test record, data evaluation & Equipment Under Test (EUT) configurations represented herein are true and accurate accounts of the measurements of the sample's EMC characteristics under the conditions specified in this report.

PREPARED BY : Wendy Liao , **DATE:** May 15, 2007
(Wendy Liao)

TECHNICAL ACCEPTANCE : Long Chen , **DATE:** May 15, 2007
Responsible for RF (Long Chen)

APPROVED BY : Gary Chang , **DATE:** May 15, 2007
(Gary Chang / Supervisor)

2. SUMMARY OF TEST RESULTS

The EUT has been tested according to the following specifications:

APPLIED STANDARD: FCC Part 15, Subpart C			
Standard Section	Test Type and Limit	Result	Remark
15.207	AC Power Conducted Emission	PASS	Meet the requirement of limit. Minimum passing margin is -16.05dB at 0.216MHz
15.247(a)(2)	Spectrum Bandwidth of a Direct Sequence Spread Spectrum System Limit: min. 500kHz	PASS	Meet the requirement of limit.
15.247(b)	Maximum Peak Output Power Limit: max. 30dBm	PASS	Meet the requirement of limit.
15.247(d)	Radiated Emissions Limit: Table 15.209	PASS	Meet the requirement of limit. Minimum passing margin is -1.27dB at 360.43MHz
15.247(e)	Power Spectral Density Limit: max. 8dBm	PASS	Meet the requirement of limit.
15.247(d)	Band Edge Measurement Limit: 20dB less than the peak value of fundamental frequency	PASS	Meet the requirement of limit.

2.1 MEASUREMENT UNCERTAINTY

Where relevant, the following measurement uncertainty levels have been estimated for tests performed on the EUT as specified in CISPR 16-4-2:

Measurement	Frequency	Uncertainty
Conducted emissions	9kHz~30MHz	2.55 dB
Radiated emissions	30MHz ~ 200MHz	3.47 dB
	200MHz ~ 1000MHz	3.64 dB
	1GHz ~ 18GHz	3.64 dB
	18GHz ~ 40GHz	3.64 dB

This uncertainty represents an expanded uncertainty expressed at approximately the 95% confidence level using a coverage factor of k=2.

3. GENERAL INFORMATION

3.1 GENERAL DESCRIPTION OF EUT

EUT	802.11b/g Wireless LAN USB Module
MODEL NO.	LR802UKG
FCC ID	RUJ-LR802UKG
POWER SUPPLY	5Vdc from host equipment
MODULATION TYPE	CCK, DQPSK, DBPSK for DSSS 64QAM, 16QAM, QPSK, BPSK for OFDM
RADIO TECHNOLOGY	DSSS, OFDM
TRANSFER RATE	802.11b: 11/5.5/2/1Mbps 802.11g: 54/48/36/24/18/12/9/6Mbps
FREQUENCY RANGE	2412MHz ~ 2462MHz
NUMBER OF CHANNEL	11
OUTPUT POWER	64.417mW
ANTENNA TYPE	Refer to NOTE 1
DATA CABLE	NA
I/O PORTS	USB
ASSOCIATED DEVICES	NA

NOTE:

- The following antennas were provided to this EUT.

NO.	ANTENNA TYPE	MANUFACTURER	MODEL NO / PART NO	ANTENNA GAIN	ANTENNA CONNECTOR
1	PIFA	WHA YU INDUSTRIAL CO., LTD	C678-520002-A	-1.48	UFL
2	PIFA	WHA YU INDUSTRIAL CO., LTD	C678-520006-A	2.05	UFL
3	PIFA	TYCO	S37	0.82	UFL
4	PIFA	HIGH-TEK	NEW T700-1	2.30	UFL
5	Dipole	Firich Enterprises Co., Ltd.	OA-24-2.5-01	2.00	RSMA

NOTE: Antenna 1~4 are same type, the one with highest gain will be the worst case, therefore only antenna 4 and 5 are tested for final.

- The EUT, operates in the 2.4GHz frequency range, lets you connect IEEE 802.11g or IEEE 802.11b devices to the network. With its high-speed data transmissions of up to 54Mbps.
- The above EUT information was declared by manufacturer and for more detailed features description, please refer to the manufacturer's specifications or User's Manual.

3.2 DESCRIPTION OF TEST MODES

Eleven channels are provided to this EUT.

CHANNEL	FREQUENCY	CHANNEL	FREQUENCY
1	2412 MHz	7	2442 MHz
2	2417 MHz	8	2447 MHz
3	2422 MHz	9	2452 MHz
4	2427 MHz	10	2457 MHz
5	2432 MHz	11	2462 MHz
6	2437 MHz		

3.2.1 CONFIGURATION OF SYSTEM UNDER TEST

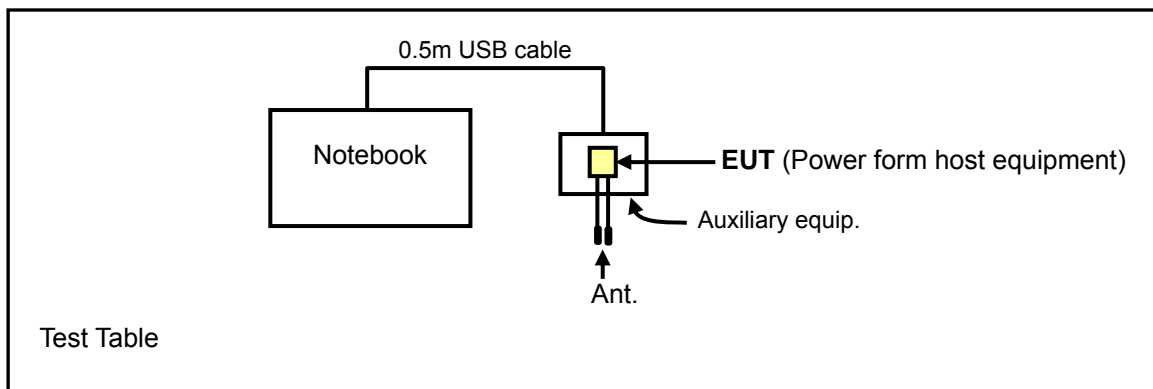

3.2.2 TEST MODE APPLICABILITY AND TESTED CHANNEL DETAIL

EUT configure mode	Applicable to				Description
	PLC	RE<1G	RE≥1G	APCM	
A	√	√	√	√	The EUT with PIFA antenna
B	-	√	√	-	The EUT with Dipole antenna

Where PLC: Power Line Conducted Emission RE<1G RE: Radiated Emission below 1GHz
 RE≥1G: Radiated Emission above 1GHz APCM: Antenna Port Conducted Measurement

NOTE: "-" means no effect.

Power Line Conducted Emission Test:

- Pre-Scan has been conducted to determine the worst-case mode from all possible combinations between available modulations, data rates and antenna ports (if EUT with antenna diversity architecture).
- Following channel(s) was (were) selected for the final test as listed below.

EUT configure mode	Mode	Available Channel	Tested Channel	Modulation Technology	Modulation Type	Data Rate (Mbps)
A	802.11g	1 to 11	1, 6, 11	OFDM	BPSK	6

Radiated Emission Test (Below 1 GHz):

- Pre-Scan has been conducted to determine the worst-case mode from all possible combinations between available modulations, data rates and antenna ports (if EUT with antenna diversity architecture).
- Following channel(s) was (were) selected for the final test as listed below.

EUT configure mode	Mode	Available Channel	Tested Channel	Modulation Technology	Modulation Type	Data Rate (Mbps)
A ~ B	802.11g	1 to 11	11	OFDM	BPSK	6

Radiated Emission Test (Above 1 GHz):

- Pre-Scan has been conducted to determine the worst-case mode from all possible combinations between available modulations, data rates and antenna ports (if EUT with antenna diversity architecture).
- Following channel(s) was (were) selected for the final test as listed below.

EUT configure mode	Mode	Available Channel	Tested Channel	Modulation Technology	Modulation Type	Data Rate (Mbps)
A ~ B	802.11b	1 to 11	1, 6, 11	DSSS	DBPSK	1
A ~ B	802.11g	1 to 11	1, 6, 11	OFDM	BPSK	6



Bandedge Measurement:

- Pre-Scan has been conducted to determine the worst-case mode from all possible combinations between available modulations, data rates and antenna ports (if EUT with antenna diversity architecture).
- Following channel(s) was (were) selected for the final test as listed below.

EUT configure mode	Mode	Available Channel	Tested Channel	Modulation Technology	Modulation Type	Data Rate (Mbps)
A	802.11b	1 to 11	1, 11	DSSS	DBPSK	1
A	802.11g	1 to 11	1, 11	OFDM	BPSK	6

Antenna Port Conducted Measurement:

- Pre-Scan has been conducted to determine the worst-case mode from all possible combinations between available modulations, data rates and antenna ports (if EUT with antenna diversity architecture).
- Following channel(s) was (were) selected for the final test as listed below.

EUT configure mode	Mode	Available Channel	Tested Channel	Modulation Technology	Modulation Type	Data Rate (Mbps)
A	802.11b	1 to 11	1, 6, 11	DSSS	DBPSK	1
A	802.11g	1 to 11	1, 6, 11	OFDM	BPSK	6



3.3 GENERAL DESCRIPTION OF APPLIED STANDARDS

The EUT is a RF product. According to the specifications of the manufacturer, it must comply with the requirements of the following standards:

FCC Part 15, Subpart C. (15.247)

ANSI C63.4- 2003

All test items have been performed and recorded as per the above standards.

NOTE: The EUT is also considered as a kind of computer peripheral, because the connection to computer is necessary for typical use. It has been verified to comply with the requirements of FCC Part 15, Subpart B, Class B (DoC). The test report has been issued separately.

3.4 DESCRIPTION OF SUPPORT UNITS

The EUT has been tested as an independent unit together with other necessary accessories or support units. The following support units or accessories were used to form a representative test configuration during the tests.

NO.	PRODUCT	BRAND	MODEL NO.	SERIAL NO.	FCC ID
1	NOTEBOOK COMPUTER	DELL	PP05L	16484462992	E2K24CLNS
2	AUXILIARY EQUIP.	NA	NA	NA	NA

NO.	SIGNAL CABLE DESCRIPTION OF THE ABOVE SUPPORT UNITS
1	NA
2	0.5m USB shielded cable

NOTE: All power cords of the above support units are non shielded (1.8m).

4. TEST TYPES AND RESULTS

4.1 CONDUCTED EMISSION MEASUREMENT

4.1.1 LIMITS OF CONDUCTED EMISSION MEASUREMENT

FREQUENCY OF EMISSION (MHz)	CONDUCTED LIMIT (dB μ V)	
	Quasi-peak	Average
0.15-0.5	66 to 56	56 to 46
0.5-5	56	46
5-30	60	50

- NOTE:**
1. The lower limit shall apply at the transition frequencies.
 2. The limit decreases in line with the logarithm of the frequency in the range of 0.15 to 0.50 MHz.
 3. All emanations from a class A/B digital device or system, including any network of conductors and apparatus connected thereto, shall not exceed the level of field strengths specified above.

4.1.2 TEST INSTRUMENTS

DESCRIPTION & MANUFACTURER	MODEL NO.	SERIAL NO.	CALIBRATED UNTIL
Test Receiver ROHDE & SCHWARZ	ESCS30	100289	Dec. 07, 2007
RF signal cable Woken	5D-FB	Cable-HYC01-01	Jan. 06, 2008
LISN ROHDE & SCHWARZ	ESH3-Z5	100312	Feb. 13, 2008
LISN ROHDE & SCHWARZ	ESH2-Z5	100104	Sep. 14, 2007
Software ADT	ADT_Cond_V3	NA	NA

- NOTE:**
1. The calibration interval of the above test instruments is 12 months and the calibrations are traceable to NML/ROC and NIST/USA.
 2. The test was performed in HwaYa Shielded Room 1.
 3. The VCCI Site Registration No. is C-2040.

4.1.3 TEST PROCEDURES

- a. The EUT was placed 0.4 meters from the conducting wall of the shielded room with EUT being connected to the power mains through a line impedance stabilization network (LISN). Other support units were connected to the power mains through another LISN. The two LISNs provide 50 ohm/ 50uH of coupling impedance for the measuring instrument.
- b. Both lines of the power mains connected to the EUT were checked for maximum conducted interference.
- c. The frequency range from 150kHz to 30MHz was searched. Emission levels under (Limit - 20dB) was not recorded.

4.1.4 DEVIATION FROM TEST STANDARD

No deviation

4.1.5 TEST SETUP

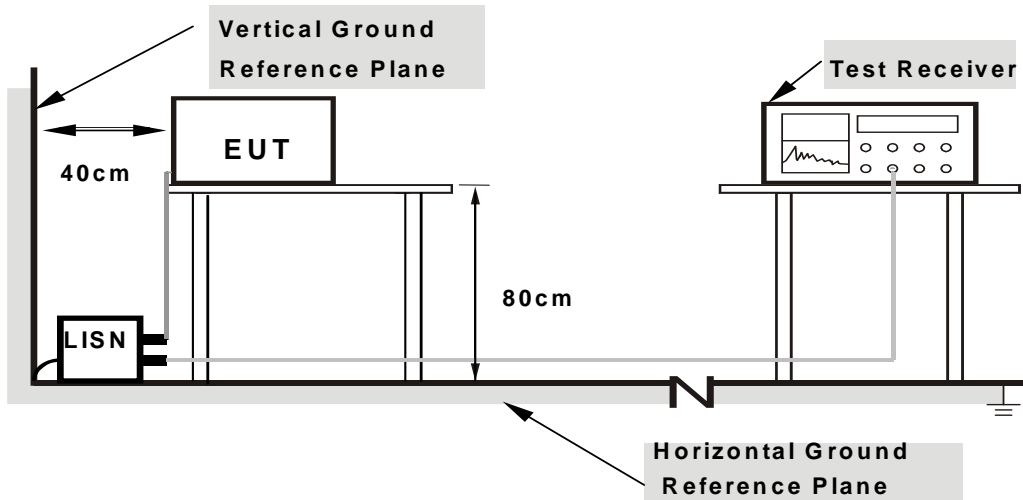

Note: 1.Support units were connected to second LISN.

2.Both of LISNs (AMN) are 80 cm from EUT and at least 80 from other units and other metal planes

For the actual test configuration, please refer to the attached file (Test Setup Photo).

4.1.6 EUT OPERATING CONDITIONS

- a. Connected the EUT to notebook and placed on a testing table.
- b. The notebook ran a test program (provided by manufacturer) to enable EUT under transmission/receiving condition continuously at specific channel frequency.

4.1.7 TEST RESULTS

CONDUCTED WORST-CASE DATA

EUT TEST CONDITION		MEASUREMENT DETAIL	
CHANNEL	Channel 1	PHASE	Line 1
MODULATION TYPE	BPSK	6dB BANDWIDTH	9 kHz
TRANSFER RATE	6Mbps	ENVIRONMENTAL CONDITIONS	20deg. C, 60%RH, 991hPa
TESTED BY	Match Tsui	INPUT POWER (SYSTEM)	120Vac, 60 Hz

No	Freq. [MHz]	Corr. Factor [dB]	Reading Value [dB (uV)]		Emission Level [dB (uV)]		Limit [dB (uV)]		Margin (dB)	
			Q.P.	AV.	Q.P.	AV.	Q.P.	AV.	Q.P.	AV.
			1	0.156	0.21	39.72	-	39.93	-	65.66
2	0.224	0.21	45.94	-	46.15	-	62.66	52.66	-16.51	-
3	0.326	0.21	36.03	-	36.24	-	59.56	49.56	-23.32	-
4	0.673	0.22	34.47	-	34.69	-	56.00	46.00	-21.31	-
5	2.180	0.27	30.51	-	30.78	-	56.00	46.00	-25.22	-
6	10.402	0.56	37.45	-	38.01	-	60.00	50.00	-21.99	-

- REMARKS:**
1. Q.P. and AV. are abbreviations of quasi-peak and average individually.
 2. "-": The Quasi-peak reading value also meets average limit and measurement with the average detector is unnecessary.
 3. The emission levels of other frequencies were very low against the limit.
 4. Margin value = Emission level - Limit value
 5. Correction factor = Insertion loss + Cable loss
 6. Emission Level = Correction Factor + Reading Value.

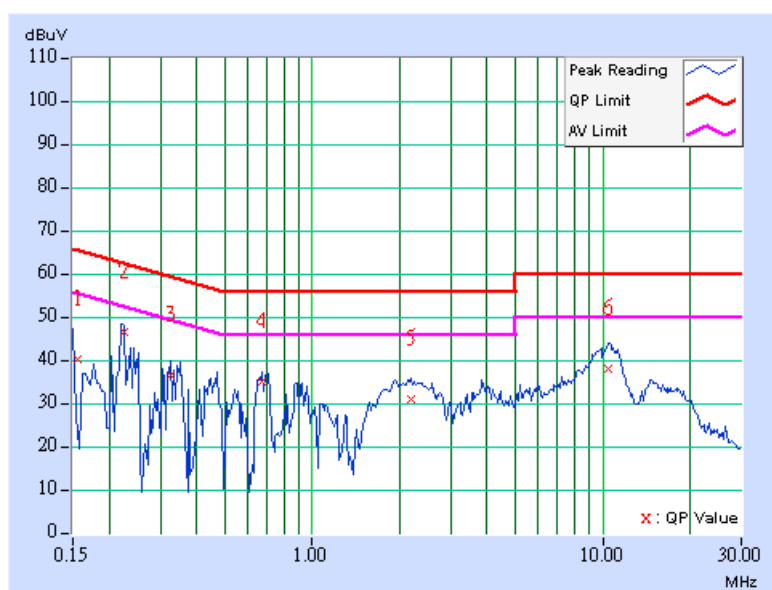

EUT TEST CONDITION		MEASUREMENT DETAIL	
CHANNEL	Channel 1	PHASE	Line 2
MODULATION TYPE	BPSK	6dB BANDWIDTH	9 kHz
TRANSFER RATE	6Mbps	ENVIRONMENTAL CONDITIONS	20deg. C, 60%RH, 991hPa
TESTED BY	Match Tsui	INPUT POWER (SYSTEM)	120Vac, 60 Hz

No	Freq. [MHz]	Corr. Factor (dB)	Reading Value [dB (uV)]		Emission Level [dB (uV)]		Limit [dB (uV)]		Margin (dB)	
			Q.P.	AV.	Q.P.	AV.	Q.P.	AV.	Q.P.	AV.
1	0.154	0.21	39.36	-	39.57	-	65.79	55.79	-26.22	-
2	0.216	0.21	46.70	-	46.91	-	62.96	52.96	-16.05	-
3	0.331	0.21	35.57	-	35.78	-	59.43	49.43	-23.65	-
4	0.705	0.23	33.51	-	33.74	-	56.00	46.00	-22.26	-
5	2.133	0.27	30.83	-	31.10	-	56.00	46.00	-24.90	-
6	10.719	0.53	38.03	-	38.56	-	60.00	50.00	-21.44	-

- REMARKS:**
1. Q.P. and AV. are abbreviations of quasi-peak and average individually.
 2. "-": The Quasi-peak reading value also meets average limit and measurement with the average detector is unnecessary.
 3. The emission levels of other frequencies were very low against the limit.
 4. Margin value = Emission level - Limit value
 5. Correction factor = Insertion loss + Cable loss
 6. Emission Level = Correction Factor + Reading Value.

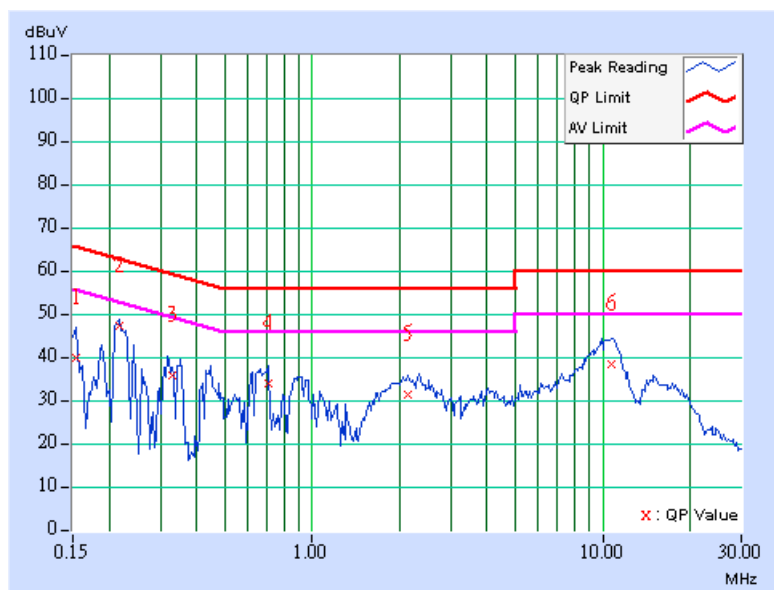

EUT TEST CONDITION		MEASUREMENT DETAIL	
CHANNEL	Channel 6	PHASE	Line 1
MODULATION TYPE	BPSK	6dB BANDWIDTH	9 kHz
TRANSFER RATE	6Mbps	ENVIRONMENTAL CONDITIONS	20deg. C, 60%RH, 991hPa
TESTED BY	Match Tsui	INPUT POWER (SYSTEM)	120Vac, 60 Hz

No	Freq. [MHz]	Corr. Factor (dB)	Reading Value [dB (uV)]		Emission Level [dB (uV)]		Limit [dB (uV)]		Margin (dB)	
			Q.P.	AV.	Q.P.	AV.	Q.P.	AV.	Q.P.	AV.
1	0.177	0.21	38.44	-	38.65	-	64.61	54.61	-25.96	-
2	0.216	0.21	45.77	-	45.98	-	62.96	52.96	-16.98	-
3	0.341	0.21	33.18	-	33.39	-	59.17	49.17	-25.78	-
4	0.662	0.22	34.05	-	34.27	-	56.00	46.00	-21.73	-
5	2.379	0.28	30.70	-	30.98	-	56.00	46.00	-25.02	-
6	10.031	0.54	36.97	-	37.51	-	60.00	50.00	-22.49	-

- REMARKS:**
1. Q.P. and AV. are abbreviations of quasi-peak and average individually.
 2. "-": The Quasi-peak reading value also meets average limit and measurement with the average detector is unnecessary.
 3. The emission levels of other frequencies were very low against the limit.
 4. Margin value = Emission level - Limit value
 5. Correction factor = Insertion loss + Cable loss
 6. Emission Level = Correction Factor + Reading Value.

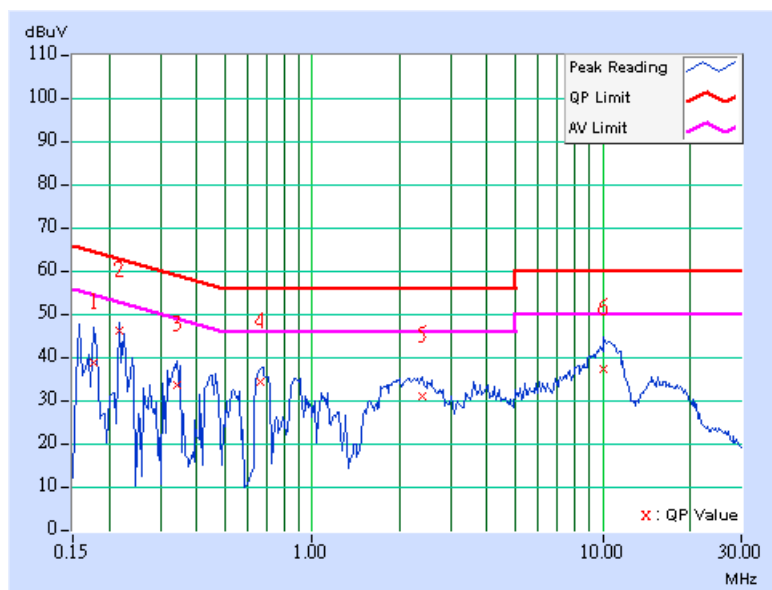

EUT TEST CONDITION		MEASUREMENT DETAIL	
CHANNEL	Channel 6	PHASE	Line 2
MODULATION TYPE	BPSK	6dB BANDWIDTH	9 kHz
TRANSFER RATE	6Mbps	ENVIRONMENTAL CONDITIONS	20deg. C, 60%RH, 991hPa
TESTED BY	Match Tsui	INPUT POWER (SYSTEM)	120Vac, 60 Hz

No	Freq. [MHz]	Corr. Factor (dB)	Reading Value [dB (uV)]		Emission Level [dB (uV)]		Limit [dB (uV)]		Margin (dB)	
			Q.P.	AV.	Q.P.	AV.	Q.P.	AV.	Q.P.	AV.
			1	0.177	0.21	37.96	-	38.17	-	64.61
2	0.228	0.21	44.66	-	44.87	-	62.52	52.52	-17.65	-
3	0.330	0.21	35.61	-	35.82	-	59.46	49.46	-23.64	-
4	0.673	0.22	35.09	-	35.31	-	56.00	46.00	-20.69	-
5	2.191	0.27	30.02	-	30.29	-	56.00	46.00	-25.71	-
6	10.602	0.53	38.43	-	38.96	-	60.00	50.00	-21.04	-

- REMARKS:**
1. Q.P. and AV. are abbreviations of quasi-peak and average individually.
 2. "-": The Quasi-peak reading value also meets average limit and measurement with the average detector is unnecessary.
 3. The emission levels of other frequencies were very low against the limit.
 4. Margin value = Emission level - Limit value
 5. Correction factor = Insertion loss + Cable loss
 6. Emission Level = Correction Factor + Reading Value.

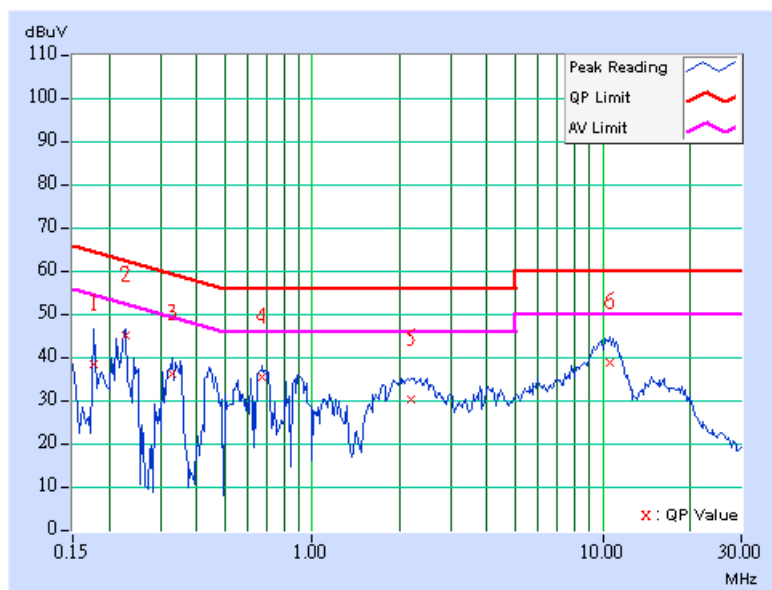

EUT TEST CONDITION		MEASUREMENT DETAIL	
CHANNEL	Channel 11	PHASE	Line 1
MODULATION TYPE	BPSK	6dB BANDWIDTH	9 kHz
TRANSFER RATE	6Mbps	ENVIRONMENTAL CONDITIONS	20deg. C, 60%RH, 991hPa
TESTED BY	Match Tsui	INPUT POWER (SYSTEM)	120Vac, 60 Hz

No	Freq. [MHz]	Corr. Factor (dB)	Reading Value [dB (uV)]		Emission Level [dB (uV)]		Limit [dB (uV)]		Margin (dB)	
			Q.P.	AV.	Q.P.	AV.	Q.P.	AV.	Q.P.	AV.
			1	0.173	0.21	36.96	-	37.17	-	64.79
2	0.219	0.21	45.28	-	45.49	-	62.86	52.86	-17.37	-
3	0.330	0.21	35.53	-	35.74	-	59.46	49.46	-23.72	-
4	0.666	0.22	34.21	-	34.43	-	56.00	46.00	-21.57	-
5	2.113	0.27	30.75	-	31.02	-	56.00	46.00	-24.98	-
6	10.367	0.56	37.63	-	38.19	-	60.00	50.00	-21.81	-

- REMARKS:**
1. Q.P. and AV. are abbreviations of quasi-peak and average individually.
 2. "-": The Quasi-peak reading value also meets average limit and measurement with the average detector is unnecessary.
 3. The emission levels of other frequencies were very low against the limit.
 4. Margin value = Emission level - Limit value
 5. Correction factor = Insertion loss + Cable loss
 6. Emission Level = Correction Factor + Reading Value.

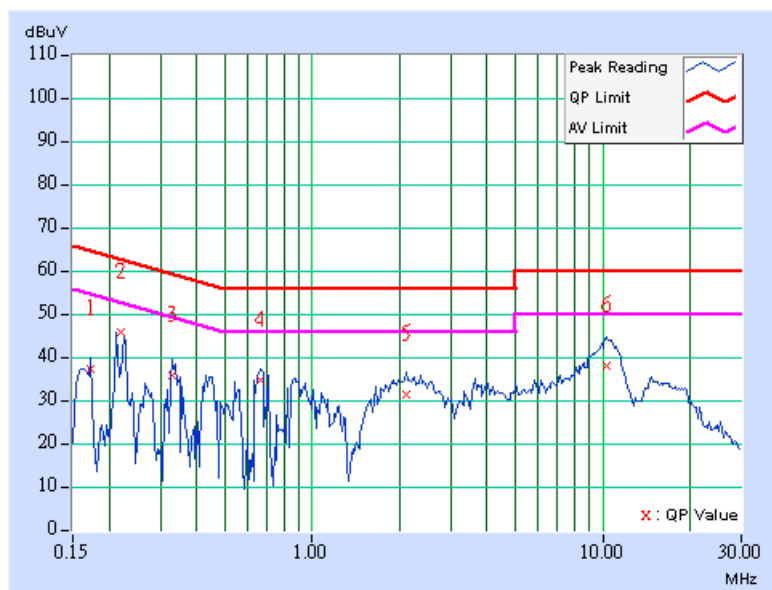

EUT TEST CONDITION		MEASUREMENT DETAIL	
CHANNEL	Channel 11	PHASE	Line 2
MODULATION TYPE	BPSK	6dB BANDWIDTH	9 kHz
TRANSFER RATE	6Mbps	ENVIRONMENTAL CONDITIONS	20deg. C, 60%RH, 991hPa
TESTED BY	Match Tsui	INPUT POWER (SYSTEM)	120Vac, 60 Hz

No	Freq. [MHz]	Corr. Factor (dB)	Reading Value [dB (uV)]		Emission Level [dB (uV)]		Limit [dB (uV)]		Margin (dB)	
			Q.P.	AV.	Q.P.	AV.	Q.P.	AV.	Q.P.	AV.
1	0.162	0.21	39.46	-	39.67	-	65.38	55.38	-25.71	-
2	0.224	0.21	44.86	-	45.07	-	62.66	52.66	-17.59	-
3	0.447	0.21	34.79	-	35.00	-	56.93	46.93	-21.93	-
4	0.654	0.22	34.41	-	34.63	-	56.00	46.00	-21.37	-
5	2.125	0.27	31.33	-	31.60	-	56.00	46.00	-24.40	-
6	10.656	0.53	38.67	-	39.20	-	60.00	50.00	-20.80	-

- REMARKS:**
1. Q.P. and AV. are abbreviations of quasi-peak and average individually.
 2. "-": The Quasi-peak reading value also meets average limit and measurement with the average detector is unnecessary.
 3. The emission levels of other frequencies were very low against the limit.
 4. Margin value = Emission level - Limit value
 5. Correction factor = Insertion loss + Cable loss
 6. Emission Level = Correction Factor + Reading Value.

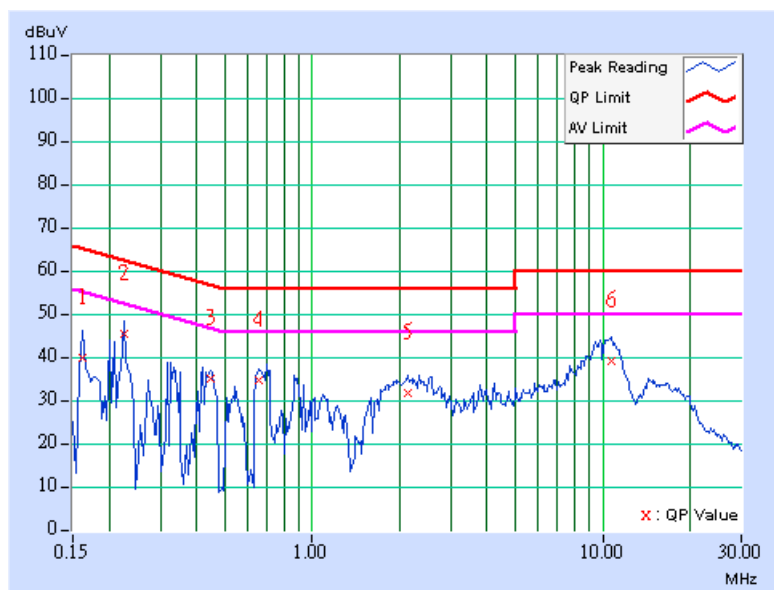

4.2 RADIATED EMISSION MEASUREMENT

4.2.1 LIMITS OF RADIATED EMISSION MEASUREMENT

Emissions radiated outside of the specified bands, shall be according to the general radiated limits in 15.209 as following:

Frequencies (MHz)	Field strength (microvolts/meter)	Measurement distance (meters)
0.009-0.490	2400/F(kHz)	300
0.490-1.705	24000/F(kHz)	30
1.705-30.0	30	30
30-88	100	3
88-216	150	3
216-960	200	3
Above 960	500	3

NOTE:

1. The lower limit shall apply at the transition frequencies.
2. Emission level (dBuV/m) = 20 log Emission level (uV/m).
3. As shown in 15.35(b), for frequencies above 1000MHz, the field strength limits are based on average detector, however, the peak field strength of any emission shall not exceed the maximum permitted average limits, specified above by more than 20dB under any condition of modulation.



4.2.2 TEST INSTRUMENTS

DESCRIPTION & MANUFACTURER	MODEL NO.	SERIAL NO.	CALIBRATED UNTIL
Test Receiver ROHDE & SCHWARZ	ESI7	100033	May 22, 2007
Spectrum Analyzer ROHDE & SCHWARZ	FSP40	100025	Oct. 05, 2007
BILOG Antenna SCHWARZBECK	VULB9168	9168-160	May 31, 2007
HORN Antenna SCHWARZBECK	9120D	9120D-209	Jun. 27, 2007
HORN Antenna SCHWARZBECK	BBHA 9170	BBHA9170243	Dec. 28, 2007
Preamplifier Agilent	8447D	2944A10633	Oct. 26, 2007
Preamplifier Agilent	8449B	3008A01964	Oct. 26, 2007
RF signal cable HUBER+SUHNNER	SUCOFLEX 104	238137/4	Dec. 11, 2007
RF signal cable HUBER+SUHNNER	SUCOFLEX 104	233233/4	Nov. 14, 2007
Software ADT.	ADT_Radiated_V7.6	NA	NA
Antenna Tower inn-co GmbH	MA 4000	013303	NA
Antenna Tower Controller inn-co GmbH	CO2000	017303	NA
Turn Table ADT.	TT100.	TT93021703	NA
Turn Table Controller ADT.	SC100.	SC93021703	NA

NOTE: 1. The calibration interval of the above test instruments is 12 months and the calibrations are traceable to NML/ROC and NIST/USA.

2. The test was performed in HwaYa Chamber 3.
3. The horn antenna and HP preamplifier (model: 8449B) are used only for the measurement of emission frequency above 1GHz if tested.
4. The VCCI Site Registration No. is R-237.
5. The IC Site Registration No. is IC3789B-3.

4.2.3 TEST PROCEDURES

- a. The EUT was placed on the top of a rotating table 0.8 meters above the ground at a 3 meter semi-anechoic chamber. The table was rotated 360 degrees to determine the position of the highest radiation.
- b. The EUT was set 3 meters away from the interference-receiving antenna, which was mounted on the top of a variable-height antenna tower.
- c. The antenna is a broadband antenna, and its height is varied from one meter to four meters above the ground to determine the maximum value of the field strength. Both horizontal and vertical polarizations of the antenna are set to make the measurement.
- d. For each suspected emission, the EUT was arranged to its worst case and then the antenna was tuned to heights from 1 meter to 4 meters and the rotatable table was turned from 0 degrees to 360 degrees to find the maximum reading.
- e. The test-receiver system was set to Peak Detect Function and Specified Bandwidth with Maximum Hold Mode.
- f. If the emission level of the EUT in peak mode was 10 dB lower than the limit specified, then testing could be stopped and the peak values of the EUT would be reported. Otherwise the emissions that did not have 10 dB margin would be re-tested one by one using the quasi-peak method or average method as specified and then reported in Data sheet peak mode and QP mode.

NOTE:

1. The resolution bandwidth and video bandwidth of test receiver/spectrum analyzer is 120kHz for Quasi-peak detection at frequency below 1GHz.
2. The resolution bandwidth of test receiver/spectrum analyzer is 1 MHz and video bandwidth is 3MHz for Peak detection at frequency above 1GHz.
3. The resolution bandwidth of test receiver/spectrum analyzer is 1 MHz and the video bandwidth is 10Hz for Average detection (AV) at frequency above 1GHz.

4.2.4 DEVIATION FROM TEST STANDARD

No deviation

4.2.5 TEST SETUP

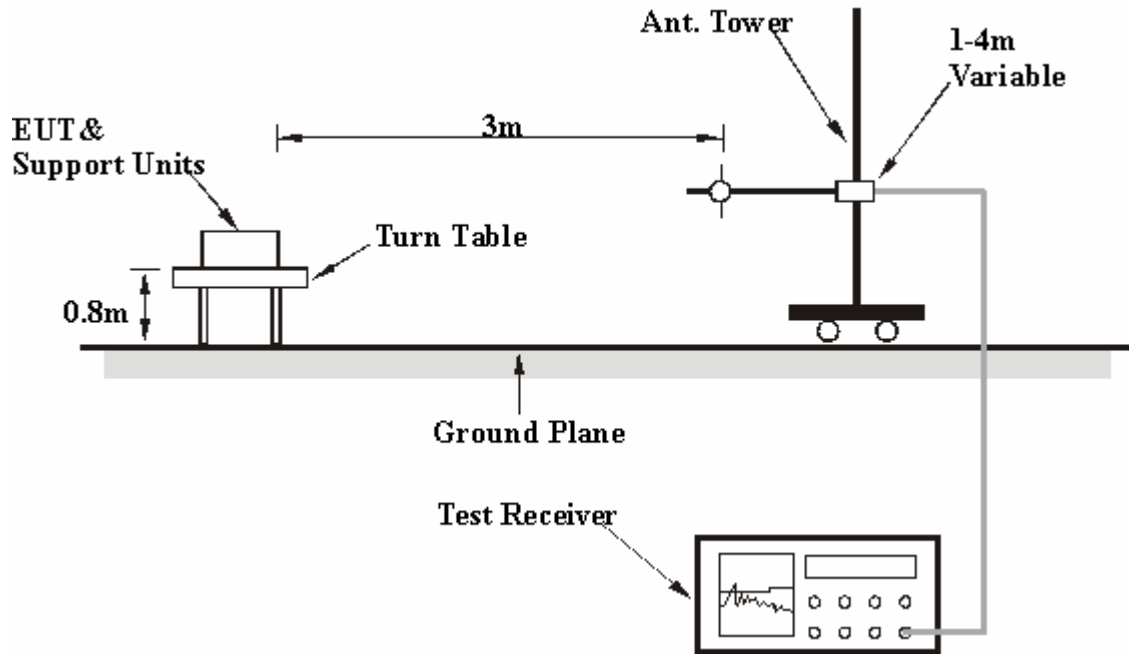

For the actual test configuration, please refer to the attached file (Test Setup Photo).

4.2.6 EUT OPERATING CONDITIONS

Same as 4.1.6

4.2.7 TEST RESULTS

RADIATED WORST-CASE DATA: BELOW 1GHz

EUT TEST CONDITION		MEASUREMENT DETAIL	
CHANNEL	Channel 11	FREQUENCY RANGE	Below 1000MHz
MODULATION TYPE	BPSK	DETECTOR FUNCTION	Quasi-Peak
TRANSFER RATE	6Mbps	ENVIRONMENTAL CONDITIONS	28deg. C, 67%RH, 991hPa
INPUT POWER (SYSTEM)	120Vac, 60 Hz	TEST MODE	A
TESTED BY	Dean Wang		

ANTENNA POLARITY & TEST DISTANCE: HORIZONTAL AT 3 M								
No.	Freq. (MHz)	Emission Level (dBuV/m)	Limit (dBuV/m)	Margin (dB)	Antenna Height (m)	Table Angle (Degree)	Raw Value (dBuV)	Correction Factor (dB/m)
1	243.77	41.87 QP	46.00	-4.13	1.00 H	238	28.66	13.21
2	274.88	42.19 QP	46.00	-3.81	1.00 H	19	27.63	14.55
3	300.16	41.55 QP	46.00	-4.45	1.00 H	226	26.41	15.14
4	360.43	44.73 QP	46.00	-1.27	1.00 H	181	28.01	16.71
5	479.03	44.60 QP	46.00	-1.40	1.50 H	304	24.69	19.91
6	599.58	41.22 QP	46.00	-4.78	1.50 H	316	18.77	22.45
7	720.12	40.32 QP	46.00	-5.68	1.00 H	223	15.54	24.78
8	961.21	45.01 QP	54.00	-8.99	1.50 H	220	16.61	28.40

ANTENNA POLARITY & TEST DISTANCE: VERTICAL AT 3 M								
No.	Freq. (MHz)	Emission Level (dBuV/m)	Limit (dBuV/m)	Margin (dB)	Antenna Height (m)	Table Angle (Degree)	Raw Value (dBuV)	Correction Factor (dB/m)
1	123.23	36.39 QP	43.50	-7.11	1.00 V	43	23.57	12.82
2	360.43	37.48 QP	46.00	-8.52	1.00 V	172	20.76	16.71
3	479.03	39.39 QP	46.00	-6.61	2.00 V	145	19.48	19.91
4	599.58	29.98 QP	46.00	-16.02	1.50 V	10	7.54	22.45
5	720.12	31.56 QP	46.00	-14.44	2.00 V	175	6.78	24.78
6	840.67	34.80 QP	46.00	-11.20	2.00 V	151	8.04	26.76
7	961.21	39.29 QP	54.00	-14.71	1.50 V	121	10.90	28.40

- REMARKS:**
1. Emission level(dBuV/m)=Raw Value(dBuV) + Correction Factor(dB/m)
 2. Correction Factor(dB/m) = Antenna Factor (dB/m) + Cable Factor (dB)
 3. The other emission levels were very low against the limit.
 4. Margin value = Emission level – Limit value.

EUT TEST CONDITION		MEASUREMENT DETAIL	
CHANNEL	Channel 11	FREQUENCY RANGE	Below 1000MHz
MODULATION TYPE	BPSK	DETECTOR FUNCTION	Quasi-Peak
TRANSFER RATE	6Mbps	ENVIRONMENTAL CONDITIONS	28deg. C, 67%RH, 991hPa
INPUT POWER (SYSTEM)	120Vac, 60 Hz	TEST MODE	B
TESTED BY	Dean Wang		

ANTENNA POLARITY & TEST DISTANCE: HORIZONTAL AT 3 M								
No.	Freq. (MHz)	Emission Level (dBuV/m)	Limit (dBuV/m)	Margin (dB)	Antenna Height (m)	Table Angle (Degree)	Raw Value (dBuV)	Correction Factor (dB/m)
1	290.43	41.01 QP	46.00	-4.99	1.00 H	193	26.10	14.92
2	333.21	42.61 QP	46.00	-3.39	1.00 H	220	26.58	16.02
3	368.21	42.63 QP	46.00	-3.37	1.00 H	208	25.73	16.90
4	393.48	40.39 QP	46.00	-5.61	1.00 H	208	22.90	17.49
5	720.12	35.35 QP	46.00	-10.65	1.00 H	25	10.57	24.78
6	840.67	36.32 QP	46.00	-9.68	1.00 H	22	9.56	26.76
7	961.21	44.56 QP	54.00	-9.44	1.50 H	226	16.16	28.40

ANTENNA POLARITY & TEST DISTANCE: VERTICAL AT 3 M								
No.	Freq. (MHz)	Emission Level (dBuV/m)	Limit (dBuV/m)	Margin (dB)	Antenna Height (m)	Table Angle (Degree)	Raw Value (dBuV)	Correction Factor (dB/m)
1	123.23	33.01 QP	43.50	-10.49	2.00 V	7	20.19	12.82
2	286.55	29.93 QP	46.00	-16.07	1.50 V	109	15.10	14.83
3	360.43	30.89 QP	46.00	-15.11	1.00 V	97	14.17	16.71
4	539.30	30.23 QP	46.00	-15.77	1.00 V	10	9.19	21.05
5	733.73	33.82 QP	46.00	-12.18	1.50 V	151	8.64	25.18
6	840.67	34.00 QP	46.00	-12.00	2.00 V	157	7.24	26.76
7	961.21	42.21 QP	54.00	-11.79	1.00 V	10	13.81	28.40

- REMARKS:**
1. Emission level(dBuV/m)=Raw Value(dBuV) + Correction Factor(dB/m)
 2. Correction Factor(dB/m) = Antenna Factor (dB/m) + Cable Factor (dB)
 3. The other emission levels were very low against the limit.
 4. Margin value = Emission level – Limit value.

802.11b DSSS MODULATION

EUT TEST CONDITION		MEASUREMENT DETAIL	
CHANNEL	Channel 1	FREQUENCY RANGE	1 ~ 25GHz
MODULATION TYPE	DBPSK	DETECTOR FUNCTION	Peak(PK) Average (AV)
TRANSFER RATE	1Mbps	ENVIRONMENTAL CONDITIONS	24deg. C, 68%RH, 991hPa
INPUT POWER (SYSTEM)	120Vac, 60 Hz	TEST MODE	A
TESTED BY	Lori Chiu		

ANTENNA POLARITY & TEST DISTANCE: HORIZONTAL AT 3 M								
No.	Freq. (MHz)	Emission Level (dBuV/m)	Limit (dBuV/m)	Margin (dB)	Antenna Height (m)	Table Angle (Degree)	Raw Value (dBuV)	Correction Factor (dB/m)
1	2390.00	55.16 PK	74.00	-18.84	1.60 H	22	23.94	31.22
2	2390.00	44.64 AV	54.00	-9.36	1.60 H	22	13.42	31.22
3	*2412.00	102.46 PK			1.60 H	22	71.25	31.21
4	*2412.00	97.04 AV			1.60 H	22	65.83	31.21
5	3216.00	42.57 PK	74.00	-31.43	1.16 H	140	10.24	32.33
6	3216.00	33.27 AV	54.00	-20.73	1.16 H	140	0.94	32.33
7	4824.00	49.52 PK	74.00	-24.48	1.15 H	223	13.04	36.48
8	4824.00	43.70 AV	54.00	-10.30	1.15 H	223	7.22	36.48

ANTENNA POLARITY & TEST DISTANCE: VERTICAL AT 3 M								
No.	Freq. (MHz)	Emission Level (dBuV/m)	Limit (dBuV/m)	Margin (dB)	Antenna Height (m)	Table Angle (Degree)	Raw Value (dBuV)	Correction Factor (dB/m)
1	2390.00	54.81 PK	74.00	-19.19	1.21 V	61	23.59	31.22
2	2390.00	44.54 AV	54.00	-9.46	1.21 V	61	13.32	31.22
3	*2412.00	97.41 PK			1.21 V	61	66.20	31.21
4	*2412.00	92.31 AV			1.21 V	61	61.10	31.21
5	4924.00	50.08 PK	74.00	-23.92	1.18 V	268	13.40	36.68
6	4924.00	45.05 AV	54.00	-8.95	1.18 V	268	8.37	36.68

- REMARKS:**
1. Emission level(dBuV/m)=Raw Value(dBuV) + Correction Factor(dB/m)
 2. Correction Factor(dB/m) = Antenna Factor (dB/m) + Cable Factor (dB)
 3. The other emission levels were very low against the limit.
 4. Margin value = Emission level – Limit value.
 5. “ * “ : Fundamental frequency



EUT TEST CONDITION		MEASUREMENT DETAIL	
CHANNEL	Channel 6	FREQUENCY RANGE	1 ~ 25GHz
MODULATION TYPE	DBPSK	DETECTOR FUNCTION	Peak(PK) Average (AV)
TRANSFER RATE	1Mbps	ENVIRONMENTAL CONDITIONS	24deg. C, 68%RH, 991hPa
INPUT POWER (SYSTEM)	120Vac, 60 Hz	TEST MODE	A
TESTED BY	Lori Chiu		

ANTENNA POLARITY & TEST DISTANCE: HORIZONTAL AT 3 M								
No.	Freq. (MHz)	Emission Level (dBuV/m)	Limit (dBuV/m)	Margin (dB)	Antenna Height (m)	Table Angle (Degree)	Raw Value (dBuV)	Correction Factor (dB/m)
1	*2437.00	102.31 PK			1.19 H	213	71.09	31.22
2	*2437.00	97.42 AV			1.19 H	213	66.20	31.22
3	3249.00	43.10 PK	74.00	-30.90	1.01 H	23	10.89	32.21
4	3249.00	33.67 AV	54.00	-20.33	1.01 H	23	1.46	32.21
5	4874.00	49.74 PK	74.00	-24.26	1.02 H	136	13.16	36.58
6	4874.00	43.59 AV	54.00	-10.41	1.02 H	136	7.01	36.58

ANTENNA POLARITY & TEST DISTANCE: VERTICAL AT 3 M								
No.	Freq. (MHz)	Emission Level (dBuV/m)	Limit (dBuV/m)	Margin (dB)	Antenna Height (m)	Table Angle (Degree)	Raw Value (dBuV)	Correction Factor (dB/m)
1	*2437.00	97.46 PK			1.44 V	11	66.24	31.22
2	*2437.00	92.70 AV			1.44 V	11	61.48	31.22
3	4874.00	50.26 PK	74.00	-23.74	1.00 V	312	13.68	36.58
4	4874.00	45.68 AV	54.00	-8.32	1.00 V	312	9.10	36.58

- REMARKS:**
1. Emission level(dBuV/m)=Raw Value(dBuV) + Correction Factor(dB/m)
 2. Correction Factor(dB/m) = Antenna Factor (dB/m) + Cable Factor (dB)
 3. The other emission levels were very low against the limit.
 4. Margin value = Emission level – Limit value.
 5. “ * “ : Fundamental frequency

EUT TEST CONDITION		MEASUREMENT DETAIL	
CHANNEL	Channel 11	FREQUENCY RANGE	1 ~ 25GHz
MODULATION TYPE	DBPSK	DETECTOR FUNCTION	Peak(PK) Average (AV)
TRANSFER RATE	1Mbps	ENVIRONMENTAL CONDITIONS	24deg. C, 68%RH, 991hPa
INPUT POWER (SYSTEM)	120Vac, 60 Hz	TEST MODE	A
TESTED BY	Lori Chiu		

ANTENNA POLARITY & TEST DISTANCE: HORIZONTAL AT 3 M								
No.	Freq. (MHz)	Emission Level (dBuV/m)	Limit (dBuV/m)	Margin (dB)	Antenna Height (m)	Table Angle (Degree)	Raw Value (dBuV)	Correction Factor (dB/m)
1	*2462.00	102.10 PK			1.25 H	250	70.87	31.23
2	*2462.00	97.70 AV			1.25 H	250	66.47	31.23
3	2483.50	55.78 PK	74.00	-18.22	1.25 H	250	24.54	31.24
4	2483.50	45.63 AV	54.00	-8.37	1.25 H	250	14.39	31.24
5	3282.00	42.39 PK	74.00	-31.61	1.00 H	147	10.29	32.10
6	3282.00	33.86 AV	54.00	-20.14	1.00 H	147	1.76	32.10
7	4924.00	49.61 PK	74.00	-24.39	1.00 H	218	12.93	36.68
8	4924.00	43.98 AV	54.00	-10.02	1.00 H	218	7.30	36.68

ANTENNA POLARITY & TEST DISTANCE: VERTICAL AT 3 M								
No.	Freq. (MHz)	Emission Level (dBuV/m)	Limit (dBuV/m)	Margin (dB)	Antenna Height (m)	Table Angle (Degree)	Raw Value (dBuV)	Correction Factor (dB/m)
1	*2462.00	97.55 PK			1.53 V	22	66.32	31.23
2	*2462.00	92.99 AV			1.53 V	22	61.76	31.23
3	2483.50	54.90 PK	74.00	-19.10	1.52 V	22	23.66	31.24
4	2483.50	44.83 AV	54.00	-9.17	1.52 V	22	13.59	31.24
5	4924.00	50.21 PK	74.00	-23.79	1.00 V	234	13.53	36.68
6	4924.00	45.37 AV	54.00	-8.63	1.00 V	234	8.69	36.68

- REMARKS:**
1. Emission level(dBuV/m)=Raw Value(dBuV) + Correction Factor(dB/m)
 2. Correction Factor(dB/m) = Antenna Factor (dB/m) + Cable Factor (dB)
 3. The other emission levels were very low against the limit.
 4. Margin value = Emission level – Limit value.
 5. “ * “ : Fundamental frequency

EUT TEST CONDITION		MEASUREMENT DETAIL	
CHANNEL	Channel 1	FREQUENCY RANGE	1 ~ 25GHz
MODULATION TYPE	DBPSK	DETECTOR FUNCTION	Peak(PK) Average (AV)
TRANSFER RATE	1Mbps	ENVIRONMENTAL CONDITIONS	24deg. C, 68%RH, 991hPa
INPUT POWER (SYSTEM)	120Vac, 60 Hz	TEST MODE	B
TESTED BY	Lori Chiu		

ANTENNA POLARITY & TEST DISTANCE: HORIZONTAL AT 3 M								
No.	Freq. (MHz)	Emission Level (dBuV/m)	Limit (dBuV/m)	Margin (dB)	Antenna Height (m)	Table Angle (Degree)	Raw Value (dBuV)	Correction Factor (dB/m)
1	2390.00	55.34 PK	74.00	-18.66	1.33 H	268	24.12	31.22
2	2390.00	44.51 AV	54.00	-9.49	1.33 H	268	13.29	31.22
3	*2412.00	96.90 PK			1.33 H	268	65.69	31.21
4	*2412.00	92.22 AV			1.33 H	268	61.01	31.21
5	4824.00	51.61 PK	74.00	-22.39	1.30 H	70	15.13	36.48
6	4824.00	45.45 AV	54.00	-8.55	1.30 H	70	8.97	36.48

ANTENNA POLARITY & TEST DISTANCE: VERTICAL AT 3 M								
No.	Freq. (MHz)	Emission Level (dBuV/m)	Limit (dBuV/m)	Margin (dB)	Antenna Height (m)	Table Angle (Degree)	Raw Value (dBuV)	Correction Factor (dB/m)
1	2390.00	56.16 PK	74.00	-17.84	1.15 V	330	24.94	31.22
2	2390.00	45.83 AV	54.00	-8.17	1.15 V	330	14.61	31.22
3	*2412.00	103.77 PK			1.14 V	331	72.56	31.21
4	*2412.00	99.51 AV			1.14 V	331	68.30	31.21
5	3216.00	43.28 PK	74.00	-30.72	1.10 V	135	10.95	32.33
6	3216.00	34.54 AV	54.00	-19.46	1.10 V	135	2.21	32.33
7	4824.00	55.74 PK	74.00	-18.26	1.13 V	315	19.26	36.48
8	4824.00	51.73 AV	54.00	-2.27	1.13 V	315	15.25	36.48

- REMARKS:**
1. Emission level(dBuV/m)=Raw Value(dBuV) + Correction Factor(dB/m)
 2. Correction Factor(dB/m) = Antenna Factor (dB/m) + Cable Factor (dB)
 3. The other emission levels were very low against the limit.
 4. Margin value = Emission level – Limit value.
 5. “ * “ : Fundamental frequency



EUT TEST CONDITION		MEASUREMENT DETAIL	
CHANNEL	Channel 6	FREQUENCY RANGE	1 ~ 25GHz
MODULATION TYPE	DBPSK	DETECTOR FUNCTION	Peak(PK) Average (AV)
TRANSFER RATE	1Mbps	ENVIRONMENTAL CONDITIONS	24deg. C, 68%RH, 991hPa
INPUT POWER (SYSTEM)	120Vac, 60 Hz	TEST MODE	B
TESTED BY	Lori Chiu		

ANTENNA POLARITY & TEST DISTANCE: HORIZONTAL AT 3 M								
No.	Freq. (MHz)	Emission Level (dBuV/m)	Limit (dBuV/m)	Margin (dB)	Antenna Height (m)	Table Angle (Degree)	Raw Value (dBuV)	Correction Factor (dB/m)
1	*2437.00	97.00 PK			1.20 H	259	65.78	31.22
2	*2437.00	92.36 AV			1.20 H	259	61.14	31.22
3	4874.00	51.86 PK	74.00	-22.14	1.25 H	159	15.28	36.58
4	4874.00	45.71 AV	54.00	-8.29	1.25 H	159	9.13	36.58

ANTENNA POLARITY & TEST DISTANCE: VERTICAL AT 3 M								
No.	Freq. (MHz)	Emission Level (dBuV/m)	Limit (dBuV/m)	Margin (dB)	Antenna Height (m)	Table Angle (Degree)	Raw Value (dBuV)	Correction Factor (dB/m)
1	*2437.00	103.85 PK			1.17 V	342	72.63	31.22
2	*2437.00	99.57 AV			1.17 V	342	68.35	31.22
3	3249.00	42.79 PK	74.00	-31.21	1.06 V	216	10.58	32.21
4	3249.00	33.85 AV	54.00	-20.15	1.06 V	216	1.64	32.21
5	4874.00	55.89 PK	74.00	-18.11	1.06 V	326	19.31	36.58
6	4874.00	52.03 AV	54.00	-1.97	1.06 V	326	15.45	36.58

- REMARKS:**
1. Emission level(dBuV/m)=Raw Value(dBuV) + Correction Factor(dB/m)
 2. Correction Factor(dB/m) = Antenna Factor (dB/m) + Cable Factor (dB)
 3. The other emission levels were very low against the limit.
 4. Margin value = Emission level – Limit value.
 5. “ * ” : Fundamental frequency

EUT TEST CONDITION		MEASUREMENT DETAIL	
CHANNEL	Channel 11	FREQUENCY RANGE	1 ~ 25GHz
MODULATION TYPE	DBPSK	DETECTOR FUNCTION	Peak(PK) Average (AV)
TRANSFER RATE	1Mbps	ENVIRONMENTAL CONDITIONS	24deg. C, 68%RH, 991hPa
INPUT POWER (SYSTEM)	120Vac, 60 Hz	TEST MODE	B
TESTED BY	Lori Chiu		

ANTENNA POLARITY & TEST DISTANCE: HORIZONTAL AT 3 M								
No.	Freq. (MHz)	Emission Level (dBuV/m)	Limit (dBuV/m)	Margin (dB)	Antenna Height (m)	Table Angle (Degree)	Raw Value (dBuV)	Correction Factor (dB/m)
1	*2462.00	97.09 PK			1.24 H	267	65.86	31.23
2	*2462.00	92.52 AV			1.24 H	267	61.29	31.23
3	2483.50	55.13 PK	74.00	-18.87	1.24 H	266	23.89	31.24
4	2483.50	44.77 AV	54.00	-9.23	1.24 H	266	13.53	31.24
5	4924.00	52.40 PK	74.00	-21.60	1.11 H	241	15.72	36.68
6	4924.00	45.88 AV	54.00	-8.12	1.11 H	241	9.20	36.68

ANTENNA POLARITY & TEST DISTANCE: VERTICAL AT 3 M								
No.	Freq. (MHz)	Emission Level (dBuV/m)	Limit (dBuV/m)	Margin (dB)	Antenna Height (m)	Table Angle (Degree)	Raw Value (dBuV)	Correction Factor (dB/m)
1	*2462.00	103.98 PK			1.11 V	338	72.75	31.23
2	*2462.00	99.61 AV			1.11 V	338	68.38	31.23
3	2483.50	57.09 PK	74.00	-16.91	1.11 V	338	25.85	31.24
4	2483.50	45.56 AV	54.00	-8.44	1.11 V	338	14.32	31.24
5	3282.00	42.56 PK	74.00	-31.44	1.17 V	109	10.46	32.10
6	3282.00	33.77 AV	54.00	-20.23	1.17 V	109	1.67	32.10
7	4924.00	56.08 PK	74.00	-17.92	1.10 V	315	19.40	36.68
8	4924.00	52.34 AV	54.00	-1.66	1.10 V	315	15.66	36.68

- REMARKS:**
1. Emission level(dBuV/m)=Raw Value(dBuV) + Correction Factor(dB/m)
 2. Correction Factor(dB/m) = Antenna Factor (dB/m) + Cable Factor (dB)
 3. The other emission levels were very low against the limit.
 4. Margin value = Emission level – Limit value.
 5. “ * “ : Fundamental frequency

802.11g OFDM MODULATION

EUT TEST CONDITION		MEASUREMENT DETAIL	
CHANNEL	Channel 1	FREQUENCY RANGE	1 ~ 25GHz
MODULATION TYPE	BPSK	DETECTOR FUNCTION	Peak(PK) Average (AV)
TRANSFER RATE	6Mbps	ENVIRONMENTAL CONDITIONS	24deg. C, 68%RH, 991hPa
INPUT POWER (SYSTEM)	120Vac, 60 Hz	TEST MODE	A
TESTED BY	Lori Chiu		

ANTENNA POLARITY & TEST DISTANCE: HORIZONTAL AT 3 M								
No.	Freq. (MHz)	Emission Level (dBuV/m)	Limit (dBuV/m)	Margin (dB)	Antenna Height (m)	Table Angle (Degree)	Raw Value (dBuV)	Correction Factor (dB/m)
1	2390.00	66.43 PK	74.00	-7.57	1.07 H	14	35.21	31.22
2	2390.00	51.45 AV	54.00	-2.55	1.07 H	14	20.23	31.22
3	*2412.00	107.86 PK			1.07 H	15	76.65	31.21
4	*2412.00	97.56 AV			1.07 H	15	66.35	31.21
5	3216.00	43.79 PK	74.00	-30.21	1.00 H	160	11.46	32.33
6	3216.00	34.60 AV	54.00	-19.40	1.00 H	160	2.27	32.33
7	4824.00	49.84 PK	74.00	-24.16	1.00 H	212	13.36	36.48
8	4824.00	36.46 AV	54.00	-17.54	1.00 H	212	-0.02	36.48

ANTENNA POLARITY & TEST DISTANCE: VERTICAL AT 3 M								
No.	Freq. (MHz)	Emission Level (dBuV/m)	Limit (dBuV/m)	Margin (dB)	Antenna Height (m)	Table Angle (Degree)	Raw Value (dBuV)	Correction Factor (dB/m)
1	2390.00	60.85 PK	74.00	-13.15	1.23 V	61	29.63	31.22
2	2390.00	47.23 AV	54.00	-6.77	1.23 V	61	16.01	31.22
3	*2412.00	99.56 PK			1.20 V	64	68.35	31.21
4	*2412.00	89.54 AV			1.20 V	64	58.33	31.21
5	4824.00	51.21 PK	74.00	-22.79	1.00 V	115	14.73	36.48
6	4824.00	37.85 AV	54.00	-16.15	1.00 V	115	1.37	36.48

- REMARKS:**
1. Emission level(dBuV/m)=Raw Value(dBuV) + Correction Factor(dB/m)
 2. Correction Factor(dB/m) = Antenna Factor (dB/m) + Cable Factor (dB)
 3. The other emission levels were very low against the limit.
 4. Margin value = Emission level – Limit value.
 5. “ * “ : Fundamental frequency

EUT TEST CONDITION		MEASUREMENT DETAIL	
CHANNEL	Channel 6	FREQUENCY RANGE	1 ~ 25GHz
MODULATION TYPE	BPSK	DETECTOR FUNCTION	Peak(PK) Average (AV)
TRANSFER RATE	6Mbps	ENVIRONMENTAL CONDITIONS	24deg. C, 68%RH, 991hPa
INPUT POWER (SYSTEM)	120Vac, 60 Hz	TEST MODE	A
TESTED BY	Lori Chiu		

ANTENNA POLARITY & TEST DISTANCE: HORIZONTAL AT 3 M								
No.	Freq. (MHz)	Emission Level (dBuV/m)	Limit (dBuV/m)	Margin (dB)	Antenna Height (m)	Table Angle (Degree)	Raw Value (dBuV)	Correction Factor (dB/m)
1	*2437.00	107.49 PK			1.06 H	243	76.27	31.22
2	*2437.00	97.37 AV			1.06 H	243	66.15	31.22
3	3249.00	43.82 PK	74.00	-30.18	1.08 H	46	11.61	32.21
4	3249.00	34.66 AV	54.00	-19.34	1.08 H	46	2.45	32.21
5	4874.00	50.67 PK	74.00	-23.33	1.21 H	308	14.09	36.58
6	4874.00	36.80 AV	54.00	-17.20	1.21 H	308	0.22	36.58

ANTENNA POLARITY & TEST DISTANCE: VERTICAL AT 3 M								
No.	Freq. (MHz)	Emission Level (dBuV/m)	Limit (dBuV/m)	Margin (dB)	Antenna Height (m)	Table Angle (Degree)	Raw Value (dBuV)	Correction Factor (dB/m)
1	*2437.00	99.38 PK			1.10 V	158	68.16	31.22
2	*2437.00	89.45 AV			1.10 V	158	58.23	31.22
3	4874.00	52.25 PK	74.00	-21.75	1.09 V	220	15.67	36.58
4	4874.00	37.80 AV	54.00	-16.20	1.09 V	220	1.22	36.58

- REMARKS:**
1. Emission level(dBuV/m)=Raw Value(dBuV) + Correction Factor(dB/m)
 2. Correction Factor(dB/m) = Antenna Factor (dB/m) + Cable Factor (dB)
 3. The other emission levels were very low against the limit.
 4. Margin value = Emission level – Limit value.
 5. “ * “ : Fundamental frequency



EUT TEST CONDITION		MEASUREMENT DETAIL	
CHANNEL	Channel 11	FREQUENCY RANGE	1 ~ 25GHz
MODULATION TYPE	BPSK	DETECTOR FUNCTION	Peak(PK) Average (AV)
TRANSFER RATE	6Mbps	ENVIRONMENTAL CONDITIONS	24deg. C, 68%RH, 991hPa
INPUT POWER (SYSTEM)	120Vac, 60 Hz	TEST MODE	A
TESTED BY	Lori Chiu		

ANTENNA POLARITY & TEST DISTANCE: HORIZONTAL AT 3 M								
No.	Freq. (MHz)	Emission Level (dBuV/m)	Limit (dBuV/m)	Margin (dB)	Antenna Height (m)	Table Angle (Degree)	Raw Value (dBuV)	Correction Factor (dB/m)
1	*2462.00	106.22 PK			1.26 H	257	74.99	31.23
2	*2462.00	96.08 AV			1.26 H	257	64.85	31.23
3	2483.50	70.41 PK	74.00	-3.59	1.29 H	220	39.17	31.24
4	2483.50	51.45 AV	54.00	-2.55	1.29 H	220	20.21	31.24
5	3282.00	44.56 PK	74.00	-29.44	1.02 H	134	12.46	32.10
6	3282.00	35.40 AV	54.00	-18.60	1.02 H	134	3.30	32.10
7	4924.00	50.24 PK	74.00	-23.76	1.01 H	267	13.56	36.68
8	4924.00	36.57 AV	54.00	-17.43	1.01 H	267	-0.11	36.68

ANTENNA POLARITY & TEST DISTANCE: VERTICAL AT 3 M								
No.	Freq. (MHz)	Emission Level (dBuV/m)	Limit (dBuV/m)	Margin (dB)	Antenna Height (m)	Table Angle (Degree)	Raw Value (dBuV)	Correction Factor (dB/m)
1	*2462.00	99.89 PK			1.16 V	18	68.66	31.23
2	*2462.00	89.76 AV			1.16 V	18	58.53	31.23
3	2483.50	59.73 PK	74.00	-14.27	1.05 V	20	28.49	31.24
4	2483.50	47.82 AV	54.00	-6.18	1.05 V	20	16.58	31.24
5	4924.00	52.15 PK	74.00	-21.85	1.11 V	208	15.47	36.68
6	4924.00	37.67 AV	54.00	-16.33	1.11 V	208	0.99	36.68

- REMARKS:**
1. Emission level(dBuV/m)=Raw Value(dBuV) + Correction Factor(dB/m)
 2. Correction Factor(dB/m) = Antenna Factor (dB/m) + Cable Factor (dB)
 3. The other emission levels were very low against the limit.
 4. Margin value = Emission level – Limit value.
 5. “ * “ : Fundamental frequency

EUT TEST CONDITION		MEASUREMENT DETAIL	
CHANNEL	Channel 1	FREQUENCY RANGE	1 ~ 25GHz
MODULATION TYPE	BPSK	DETECTOR FUNCTION	Peak(PK) Average (AV)
TRANSFER RATE	6Mbps	ENVIRONMENTAL CONDITIONS	24deg. C, 68%RH, 991hPa
INPUT POWER (SYSTEM)	120Vac, 60 Hz	TEST MODE	B
TESTED BY	Lori Chiu		

ANTENNA POLARITY & TEST DISTANCE: HORIZONTAL AT 3 M								
No.	Freq. (MHz)	Emission Level (dBuV/m)	Limit (dBuV/m)	Margin (dB)	Antenna Height (m)	Table Angle (Degree)	Raw Value (dBuV)	Correction Factor (dB/m)
1	2390.00	56.56 PK	74.00	-17.44	1.36 H	267	25.34	31.22
2	2390.00	45.51 AV	54.00	-8.49	1.36 H	267	14.29	31.22
3	*2412.00	97.68 PK			1.36 H	267	66.47	31.21
4	*2412.00	87.63 AV			1.36 H	267	56.42	31.21
5	4824.00	49.26 PK	74.00	-24.74	1.30 H	73	12.78	36.48
6	4824.00	35.80 AV	54.00	-18.20	1.30 H	73	-0.68	36.48

ANTENNA POLARITY & TEST DISTANCE: VERTICAL AT 3 M								
No.	Freq. (MHz)	Emission Level (dBuV/m)	Limit (dBuV/m)	Margin (dB)	Antenna Height (m)	Table Angle (Degree)	Raw Value (dBuV)	Correction Factor (dB/m)
1	2390.00	66.68 PK	74.00	-7.32	1.14 V	165	35.46	31.22
2	2390.00	51.52 AV	54.00	-2.48	1.14 V	165	20.30	31.22
3	*2412.00	108.24 PK			1.14 V	331	77.03	31.21
4	*2412.00	98.12 AV			1.14 V	331	66.91	31.21
5	3216.00	45.53 PK	74.00	-28.47	1.00 V	224	13.20	32.33
6	3216.00	38.30 AV	54.00	-15.70	1.00 V	224	5.97	32.33
7	4824.00	52.70 PK	74.00	-21.30	1.00 V	316	16.22	36.48
8	4824.00	38.85 AV	54.00	-15.15	1.00 V	316	2.37	36.48

- REMARKS:**
1. Emission level(dBuV/m)=Raw Value(dBuV) + Correction Factor(dB/m)
 2. Correction Factor(dB/m) = Antenna Factor (dB/m) + Cable Factor (dB)
 3. The other emission levels were very low against the limit.
 4. Margin value = Emission level – Limit value.
 5. “ * “ : Fundamental frequency

EUT TEST CONDITION		MEASUREMENT DETAIL	
CHANNEL	Channel 6	FREQUENCY RANGE	1 ~ 25GHz
MODULATION TYPE	BPSK	DETECTOR FUNCTION	Peak(PK) Average (AV)
TRANSFER RATE	6Mbps	ENVIRONMENTAL CONDITIONS	24deg. C, 68%RH, 991hPa
INPUT POWER (SYSTEM)	120Vac, 60 Hz	TEST MODE	B
TESTED BY	Lori Chiu		

ANTENNA POLARITY & TEST DISTANCE: HORIZONTAL AT 3 M								
No.	Freq. (MHz)	Emission Level (dBuV/m)	Limit (dBuV/m)	Margin (dB)	Antenna Height (m)	Table Angle (Degree)	Raw Value (dBuV)	Correction Factor (dB/m)
1	*2437.00	97.23 PK			1.23 H	278	66.01	31.22
2	*2437.00	87.09 AV			1.23 H	278	55.87	31.22
3	4874.00	49.11 PK	74.00	-24.89	1.00 H	108	12.53	36.58
4	4874.00	35.46 AV	54.00	-18.54	1.00 H	108	-1.12	36.58

ANTENNA POLARITY & TEST DISTANCE: VERTICAL AT 3 M								
No.	Freq. (MHz)	Emission Level (dBuV/m)	Limit (dBuV/m)	Margin (dB)	Antenna Height (m)	Table Angle (Degree)	Raw Value (dBuV)	Correction Factor (dB/m)
1	*2437.00	107.97 PK			1.10 V	286	76.75	31.22
2	*2437.00	97.65 AV			1.10 V	286	66.43	31.22
3	3249.00	45.11 PK	74.00	-28.89	1.00 V	165	12.90	32.21
4	3249.00	37.87 AV	54.00	-16.13	1.00 V	165	5.66	32.21
5	4874.00	52.84 PK	74.00	-21.16	1.12 V	360	16.26	36.58
6	4874.00	38.91 AV	54.00	-15.09	1.12 V	360	2.33	36.58

- REMARKS:**
1. Emission level(dBuV/m)=Raw Value(dBuV) + Correction Factor(dB/m)
 2. Correction Factor(dB/m) = Antenna Factor (dB/m) + Cable Factor (dB)
 3. The other emission levels were very low against the limit.
 4. Margin value = Emission level – Limit value.
 5. “ * ” : Fundamental frequency

EUT TEST CONDITION		MEASUREMENT DETAIL	
CHANNEL	Channel 11	FREQUENCY RANGE	1 ~ 25GHz
MODULATION TYPE	BPSK	DETECTOR FUNCTION	Peak(PK) Average (AV)
TRANSFER RATE	6Mbps	ENVIRONMENTAL CONDITIONS	24deg. C, 68%RH, 991hPa
INPUT POWER (SYSTEM)	120Vac, 60 Hz	TEST MODE	B
TESTED BY	Lori Chiu		

ANTENNA POLARITY & TEST DISTANCE: HORIZONTAL AT 3 M								
No.	Freq. (MHz)	Emission Level (dBuV/m)	Limit (dBuV/m)	Margin (dB)	Antenna Height (m)	Table Angle (Degree)	Raw Value (dBuV)	Correction Factor (dB/m)
1	*2462.00	96.89 PK			1.33 H	310	65.66	31.23
2	*2462.00	86.86 AV			1.33 H	310	55.63	31.23
3	2483.50	56.74 PK	74.00	-17.26	1.30 H	311	25.50	31.24
4	2483.50	46.00 AV	54.00	-8.00	1.30 H	311	14.76	31.24
5	4924.00	49.01 PK	74.00	-24.99	1.25 H	224	12.33	36.68
6	4924.00	34.64 AV	54.00	-19.36	1.25 H	224	-2.04	36.68

ANTENNA POLARITY & TEST DISTANCE: VERTICAL AT 3 M								
No.	Freq. (MHz)	Emission Level (dBuV/m)	Limit (dBuV/m)	Margin (dB)	Antenna Height (m)	Table Angle (Degree)	Raw Value (dBuV)	Correction Factor (dB/m)
1	*2462.00	107.72 PK			1.09 V	224	76.49	31.23
2	*2462.00	97.30 AV			1.09 V	224	66.07	31.23
3	2483.50	68.60 PK	74.00	-5.40	1.06 V	105	37.36	31.24
4	2483.50	51.55 AV	54.00	-2.45	1.06 V	105	20.31	31.24
5	3282.00	44.81 PK	74.00	-29.19	1.02 V	231	12.71	32.10
6	3282.00	37.46 AV	54.00	-16.54	1.02 V	231	5.36	32.10
7	4924.00	52.90 PK	74.00	-21.10	1.00 V	258	16.22	36.68
8	4924.00	39.03 AV	54.00	-14.97	1.00 V	258	2.35	36.68

- REMARKS:**
1. Emission level(dBuV/m)=Raw Value(dBuV) + Correction Factor(dB/m)
 2. Correction Factor(dB/m) = Antenna Factor (dB/m) + Cable Factor (dB)
 3. The other emission levels were very low against the limit.
 4. Margin value = Emission level – Limit value.
 5. “ * “ : Fundamental frequency



4.3 6dB BANDWIDTH MEASUREMENT

4.3.1 LIMITS OF 6dB BANDWIDTH MEASUREMENT

The minimum of 6dB Bandwidth Measurement is 0.5 MHz.

4.3.2 TEST INSTRUMENTS

Description & Manufacturer	Model No.	Serial No.	Calibrated Until
SPECTRUM ANALYZER	FSP40	100040	Jun. 07, 2007

NOTE: The calibration interval of the above test instruments is 12 months and the calibrations are traceable to NML/ROC and NIST/USA.

4.3.3 TEST PROCEDURE

The transmitter output was connected to the spectrum analyzer through an attenuator. The bandwidth of the fundamental frequency was measured by spectrum analyzer with 100kHz RBW and 100kHz VBW. The 6dB bandwidth is defined as the total spectrum the power of which is higher than peak power minus 6dB.

4.3.4 DEVIATION FROM TEST STANDARD

No deviation

4.3.5 TEST SETUP

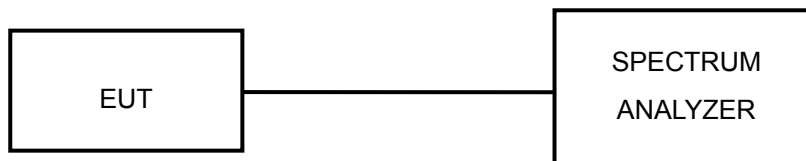

4.3.6 EUT OPERATING CONDITIONS

The software provided by client to enable the EUT under transmission condition continuously at lowest, middle and highest channel frequencies individually.



4.3.7 TEST RESULTS

802.11b DSSS MODULATION

MODULATION TYPE	DBPSK	TRANSFER RATE	1Mbps
INPUT POWER (SYSTEM)	120Vac, 60 Hz	ENVIRONMENTAL CONDITIONS	26deg. C, 66%RH, 991hPa
TESTED BY	Long Chen		

CHANNEL	CHANNEL FREQUENCY (MHz)	6dB BANDWIDTH (MHz)	MINIMUM LIMIT (MHz)	PASS/FAIL
1	2412	12.36	0.5	PASS
6	2437	12.28	0.5	PASS
11	2462	12.28	0.5	PASS

CH 1

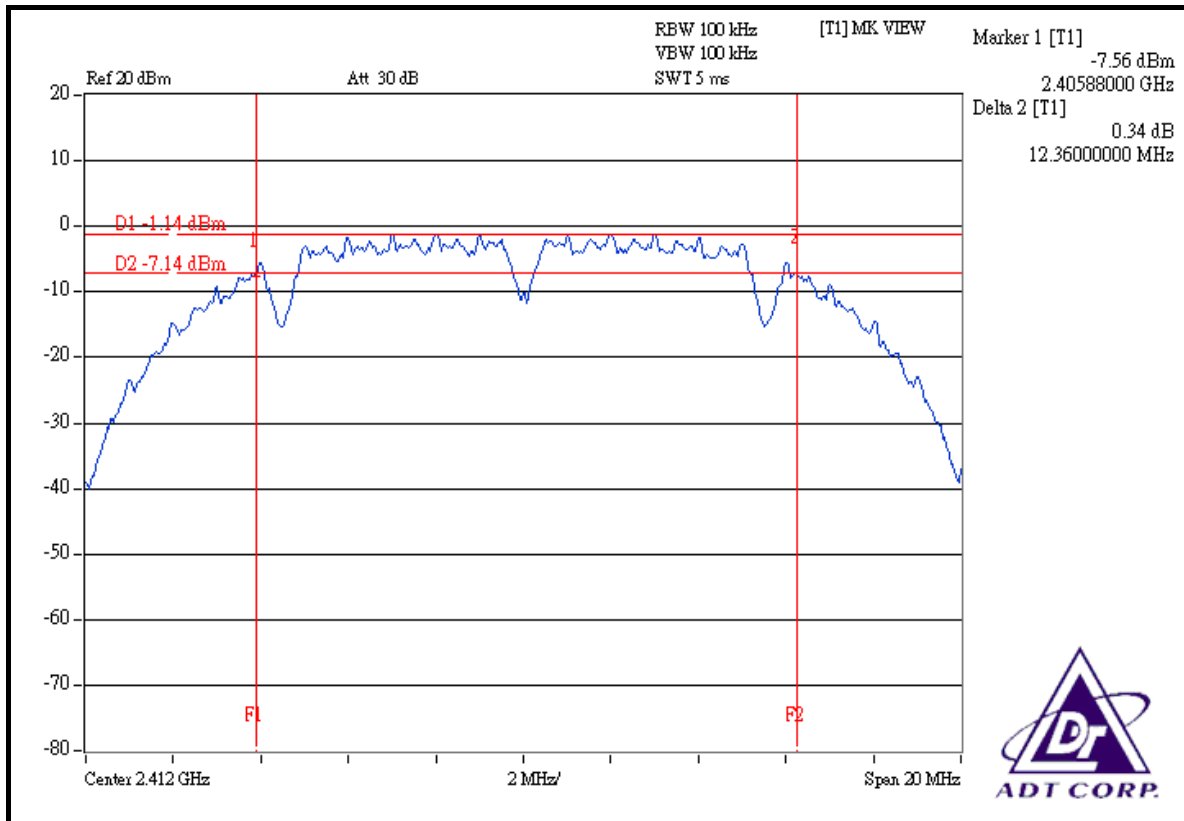

CH 6

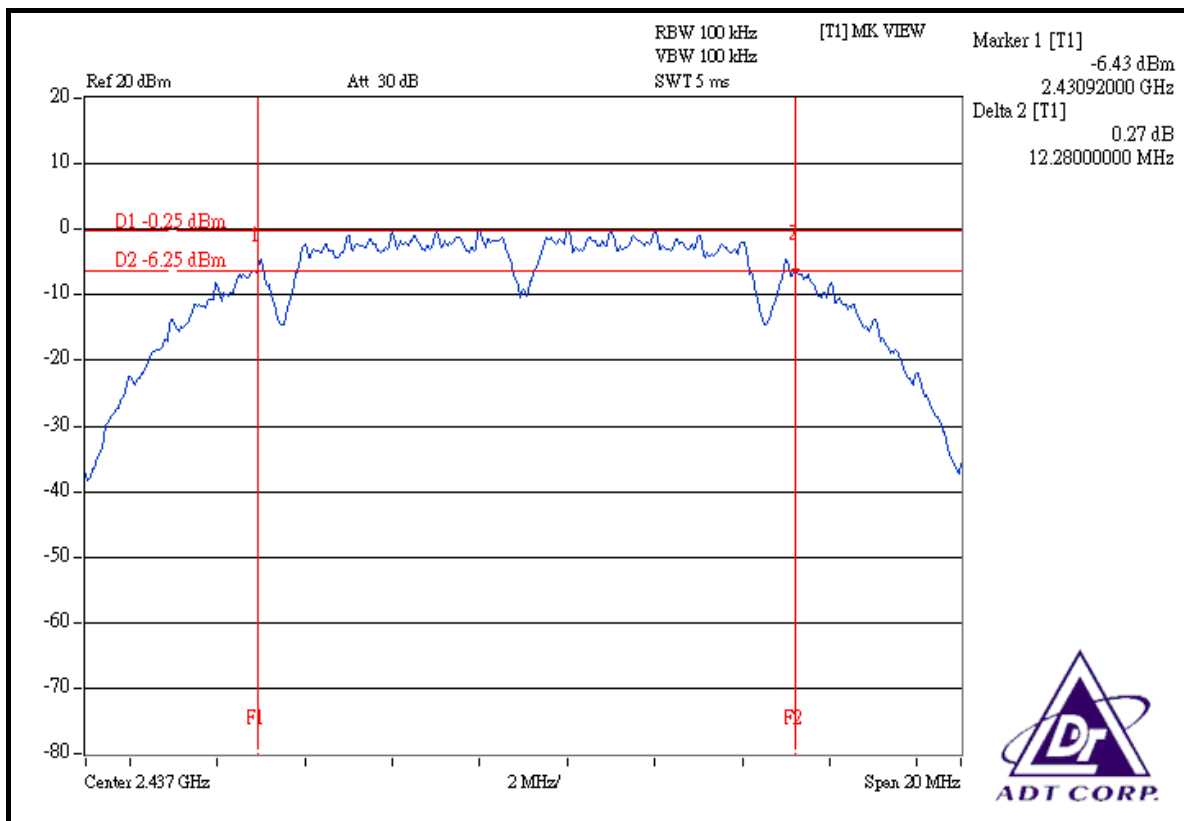



CH 11

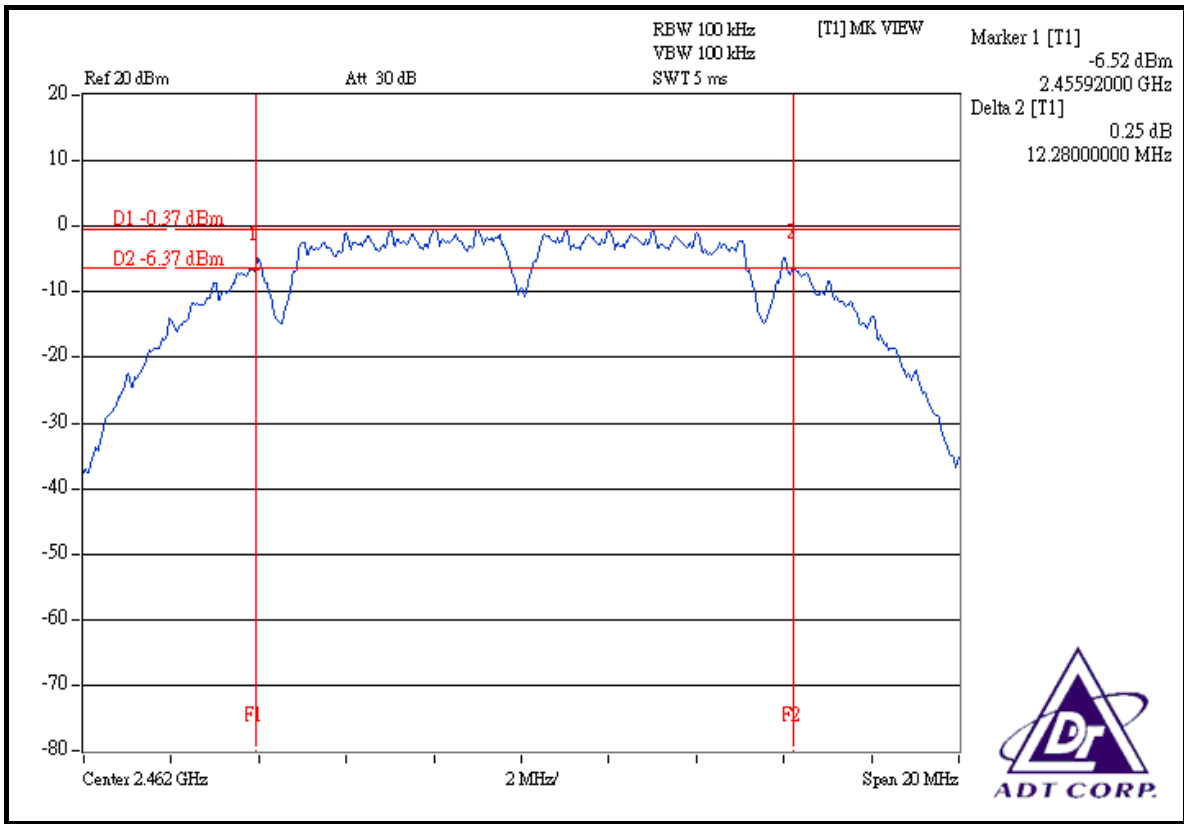



802.11g OFDM MODULATION

MODULATION TYPE	BPSK	TRANSFER RATE	6Mbps
INPUT POWER (SYSTEM)	120Vac, 60 Hz	ENVIRONMENTAL CONDITIONS	26deg. C, 66%RH, 991hPa
TESTED BY	Long Chen		

CHANNEL	CHANNEL FREQUENCY (MHz)	6dB BANDWIDTH (MHz)	MINIMUM LIMIT (MHz)	PASS/FAIL
1	2412	16.52	0.5	PASS
6	2437	16.56	0.5	PASS
11	2462	16.56	0.5	PASS



CH 1

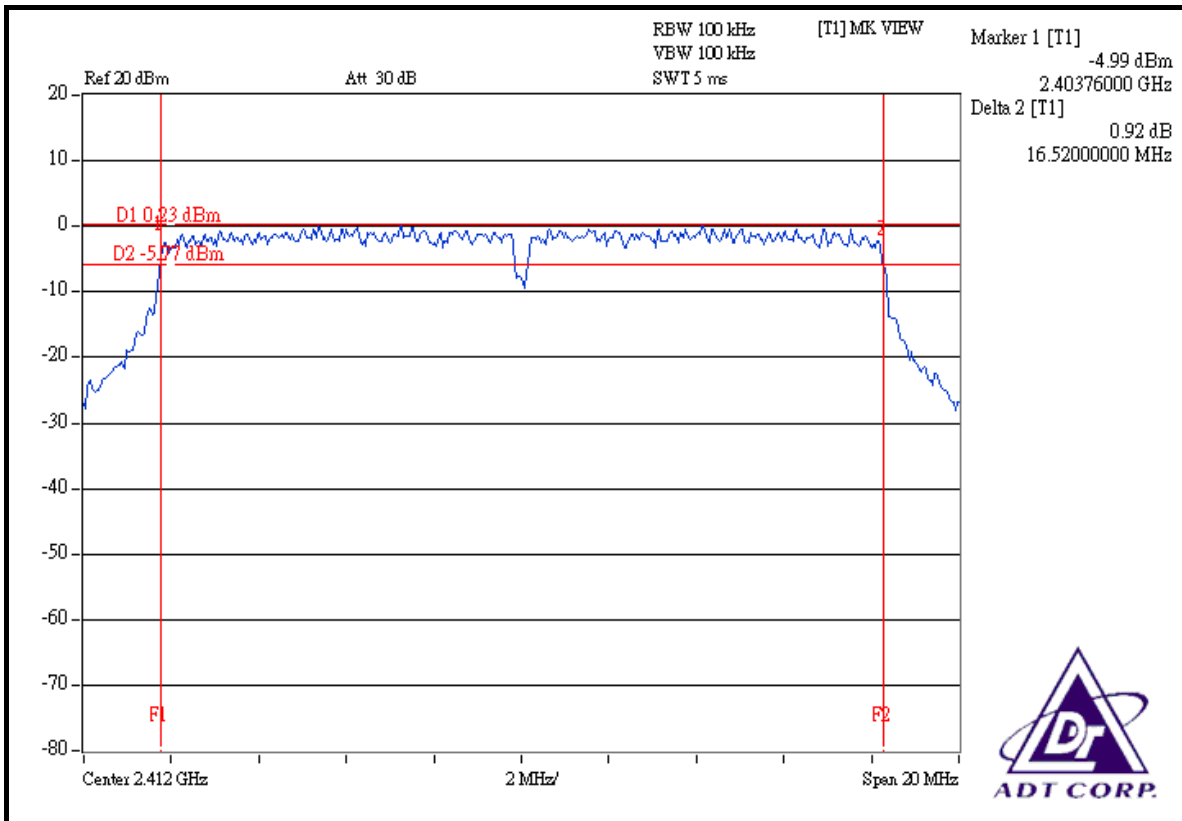

CH 6

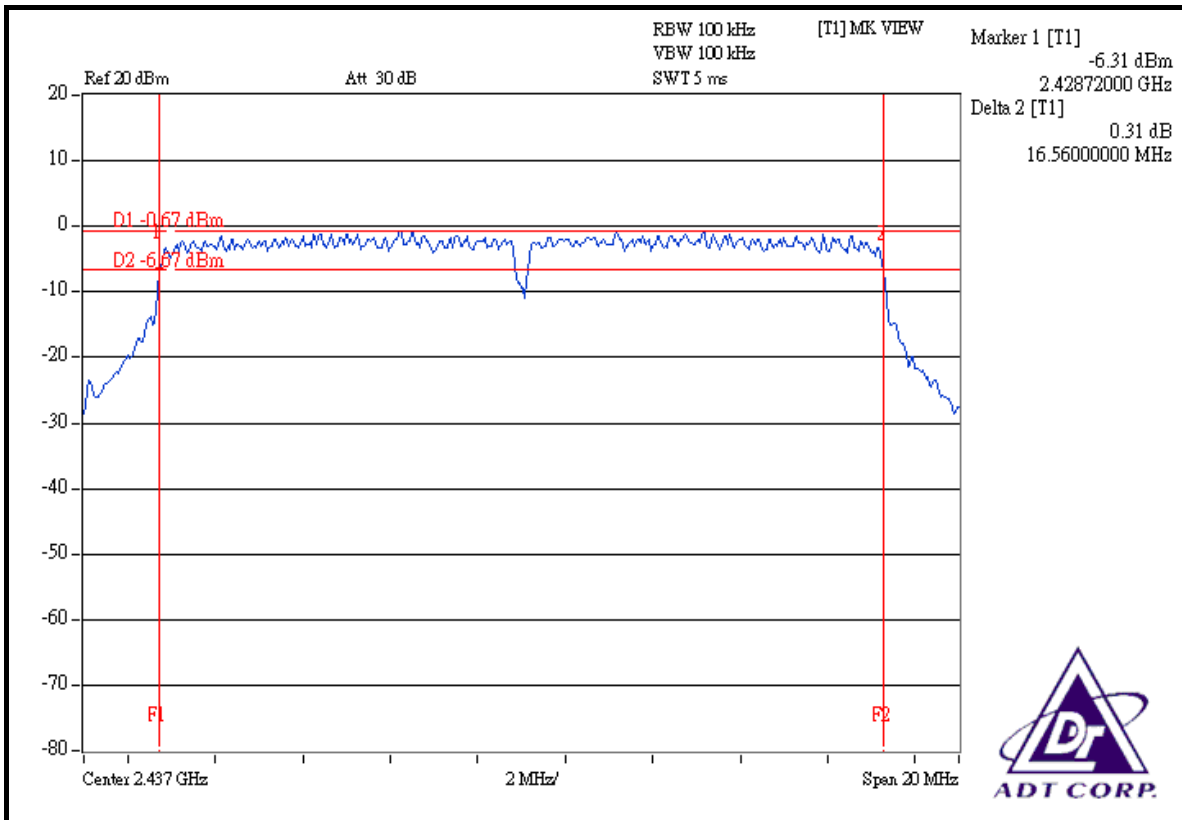



CH 11

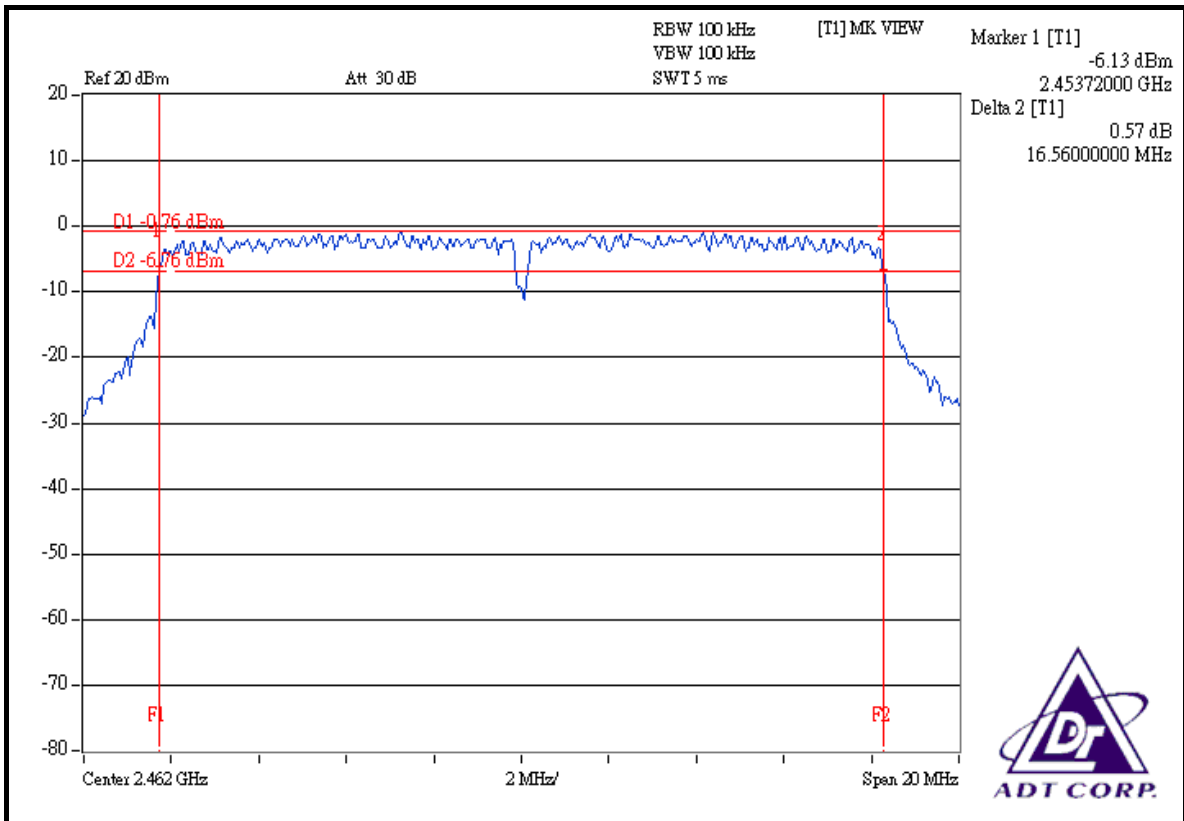



4.4 MAXIMUM PEAK OUTPUT POWER

4.4.1 LIMITS OF MAXIMUM PEAK OUTPUT POWER MEASUREMENT

The Maximum Peak Output Power Measurement is 30dBm.

4.4.2 INSTRUMENTS

Description & Manufacturer	Model No.	Serial No.	Calibrated Until
R&S SPECTRUM ANALYZER	FSP40	100040	Jun. 07, 2007
R&S SIGNAL GENERATOR	SML03	102843	Aug. 31, 2007
TEKTRONIX OSCILLOSCOPE	TDS1012	C037299	Nov. 27, 2007
NARDA DETECTOR	4503A	FSCM99899	NA

NOTE: The calibration interval of the above test instruments is 12 months and the calibrations are traceable to NML/ROC and NIST/USA.

4.4.1 TEST PROCEDURES

A detector was used on the output port of the EUT. An oscilloscope was used to read the response of the detector.

2. Replaced the EUT by the signal generator. The center frequency of the S.G was adjusted to the center frequency of the measured channel.
3. Adjusted the power to have the same reading on oscilloscope. Record the power level.

4.4.2 DEVIATION FROM TEST STANDARD

No deviation

4.4.3 TEST SETUP



4.4.4 EUT OPERATING CONDITIONS

Same as Item 4.3.6



4.4.3 TEST RESULTS

802.11b DSSS MODULATION

MODULATION TYPE	DBPSK	TRANSFER RATE	1Mbps
INPUT POWER (SYSTEM)	120Vac, 60 Hz	ENVIRONMENTAL CONDITIONS	26deg. C, 66%RH, 991hPa
TESTED BY	Long Chen		

CHANNEL	CHANNEL FREQUENCY (MHz)	PEAK POWER OUTPUT (mW)	PEAK POWER OUTPUT (dBm)	PEAK POWER LIMIT (dBm)	PASS/FAIL
1	2412	25.119	14.00	30	PASS
6	2437	25.586	14.08	30	PASS
11	2462	25.410	14.05	30	PASS

802.11g OFDM MODULATION

MODULATION TYPE	BPSK	TRANSFER RATE	6Mbps
INPUT POWER (SYSTEM)	120Vac, 60 Hz	ENVIRONMENTAL CONDITIONS	26deg. C, 66%RH, 991hPa
TESTED BY	Long Chen		

CHANNEL	CHANNEL FREQUENCY (MHz)	PEAK POWER OUTPUT (mW)	PEAK POWER OUTPUT (dBm)	PEAK POWER LIMIT (dBm)	PASS/FAIL
1	2412	64.269	18.08	30	PASS
6	2437	64.417	18.09	30	PASS
11	2462	63.533	18.03	30	PASS



4.5 POWER SPECTRAL DENSITY MEASUREMENT

4.5.1 LIMITS OF POWER SPECTRAL DENSITY MEASUREMENT

The Maximum of Power Spectral Density Measurement is 8dBm.

4.5.2 TEST INSTRUMENTS

Description & Manufacturer	Model No.	Serial No.	Calibrated Until
R&S SPECTRUM ANALYZER	FSP40	100040	Jun. 07, 2007

NOTE:

The calibration interval of the above test instruments is 12 months and the calibrations are traceable to NML/ROC and NIST/USA.

4.5.3 TEST PROCEDURE

The transmitter output was connected to the spectrum analyzer through an attenuator, the bandwidth of the fundamental frequency was measured with the spectrum analyzer using 3kHz RBW and 30kHz VBW, set sweep time = span/3kHz. The power spectral density was measured and recorded. The sweep time is allowed to be longer than span/3kHz for a full response of the mixer in the spectrum analyzer.

4.5.4 DEVIATION FROM TEST STANDARD

No deviation

4.5.5 TEST SETUP

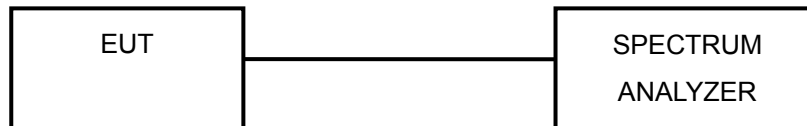

4.5.6 EUT OPERATING CONDITION

Same as Item 4.3.6



4.5.7 TEST RESULTS

802.11b DSSS MODULATION

MODULATION TYPE	DBPSK	TRANSFER RATE	1Mbps
INPUT POWER (SYSTEM)	120Vac, 60 Hz	ENVIRONMENTAL CONDITIONS	26deg. C, 66%RH, 991hPa
TESTED BY	Long Chen		

CHANNEL	CHANNEL FREQUENCY (MHz)	RF POWER LEVEL IN 3kHz BW (dBm)	MAXIMUM LIMIT (dBm)	PASS/FAIL
1	2412	-18.68	8	PASS
6	2437	-18.44	8	PASS
11	2462	-18.42	8	PASS



CH 1

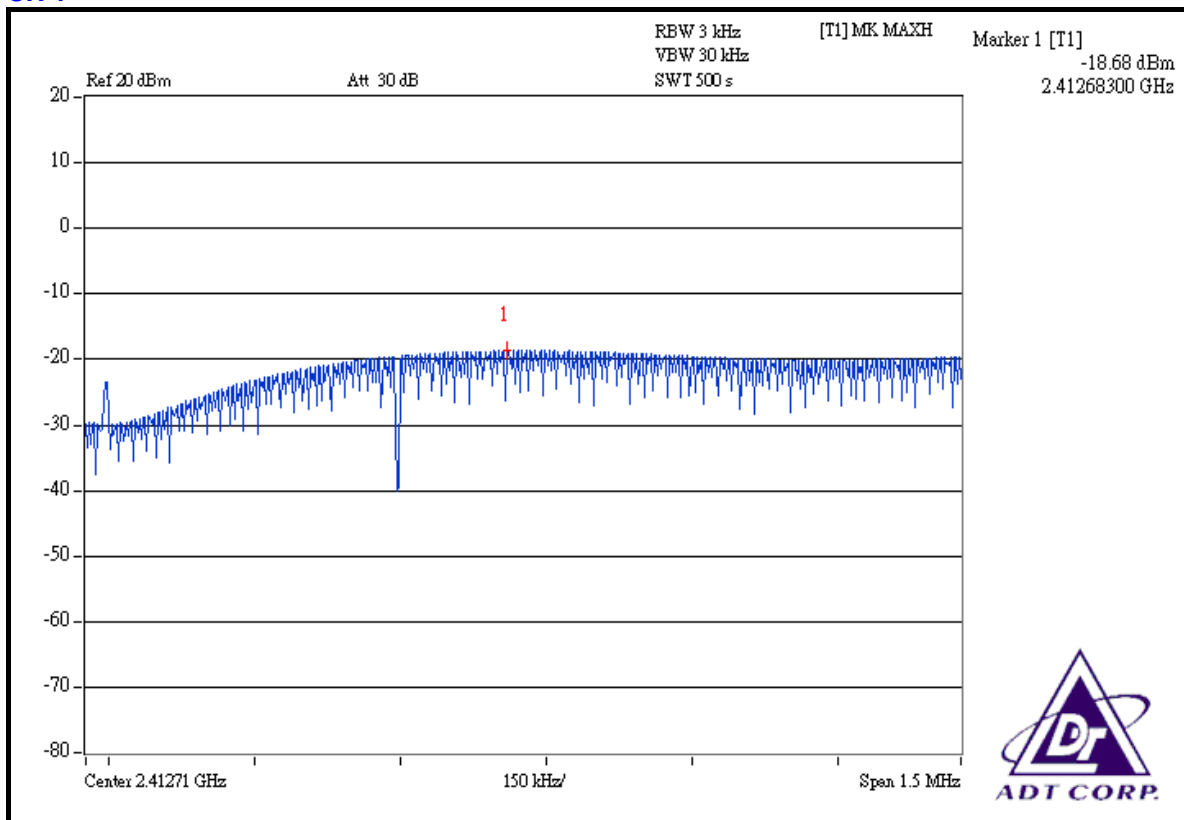

CH 6

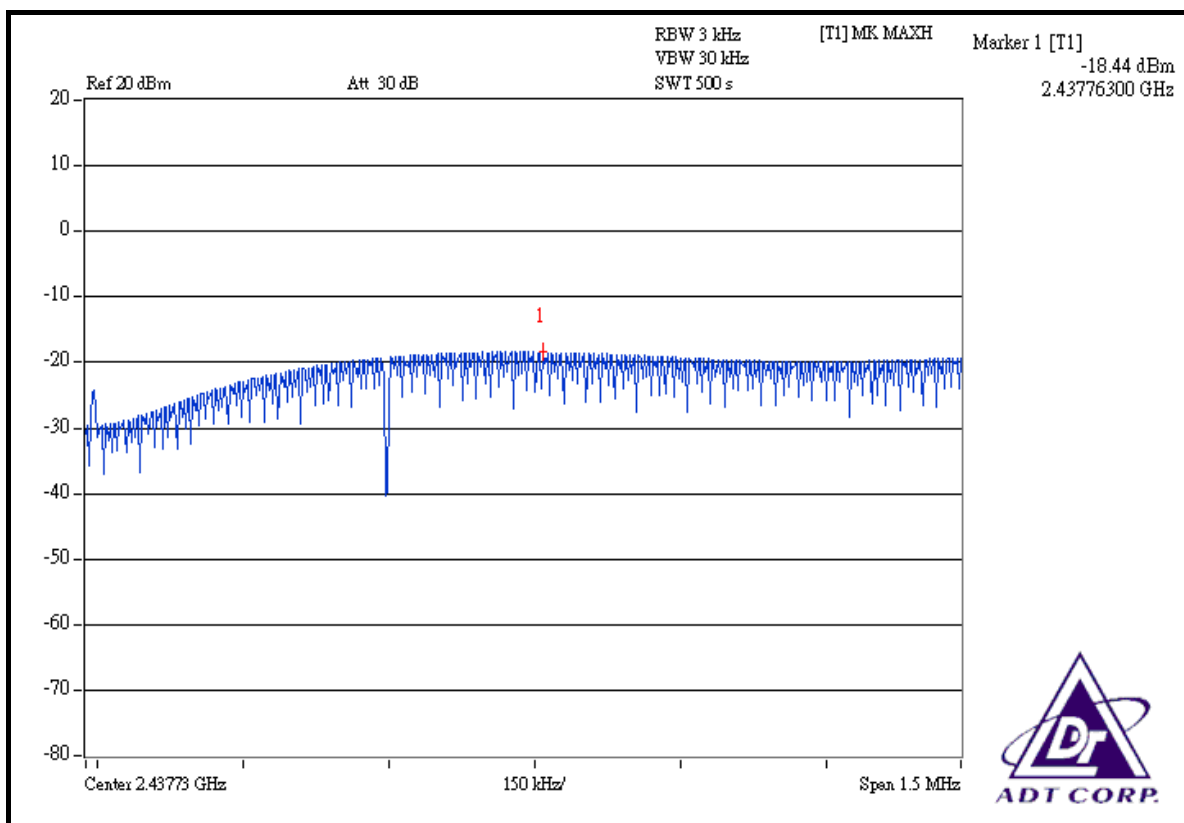

CH 11

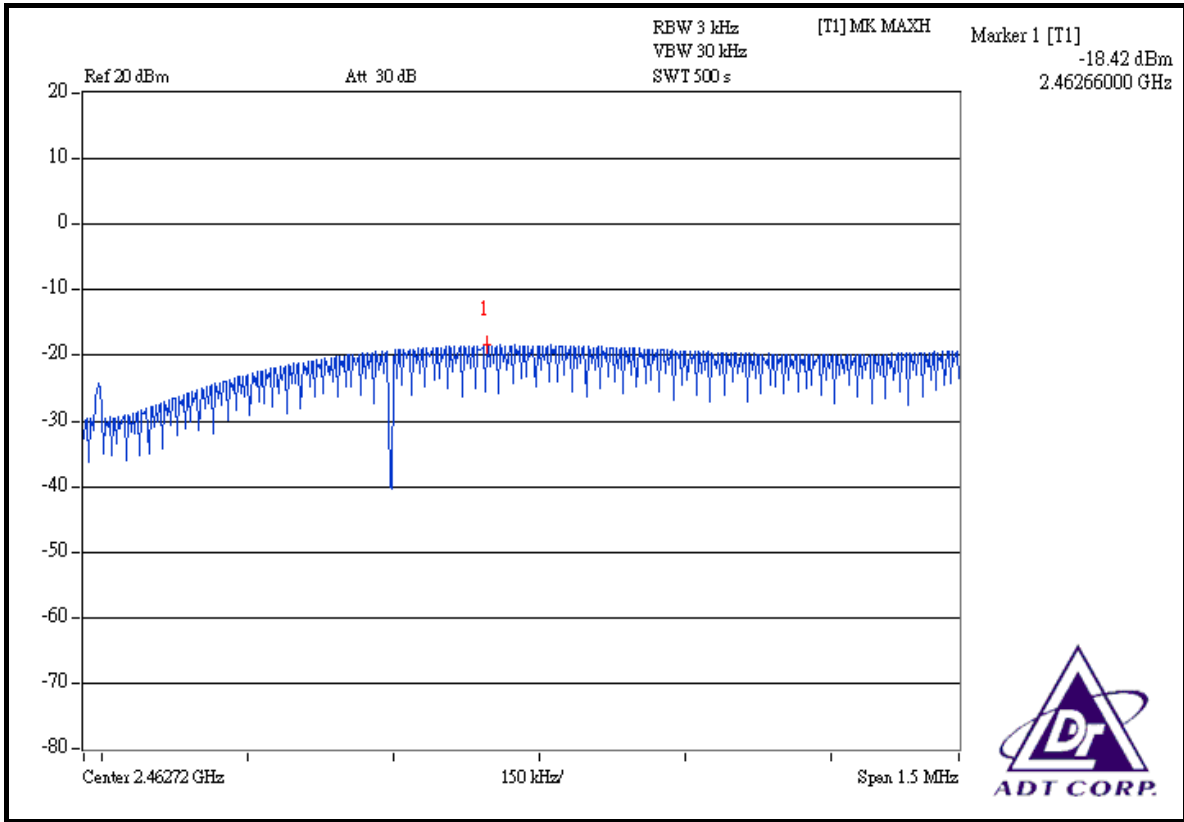



802.11g OFDM MODULATION

MODULATION TYPE	BPSK	TRANSFER RATE	6Mbps
INPUT POWER (SYSTEM)	120Vac, 60 Hz	ENVIRONMENTAL CONDITIONS	26deg. C, 66%RH, 991hPa
TESTED BY	Long Chen		

CHANNEL	CHANNEL FREQUENCY (MHz)	RF POWER LEVEL IN 3kHz BW (dBm)	MAXIMUM LIMIT (dBm)	PASS/FAIL
1	2412	-13.47	8	PASS
6	2437	-13.49	8	PASS
11	2462	-13.61	8	PASS



CH 1

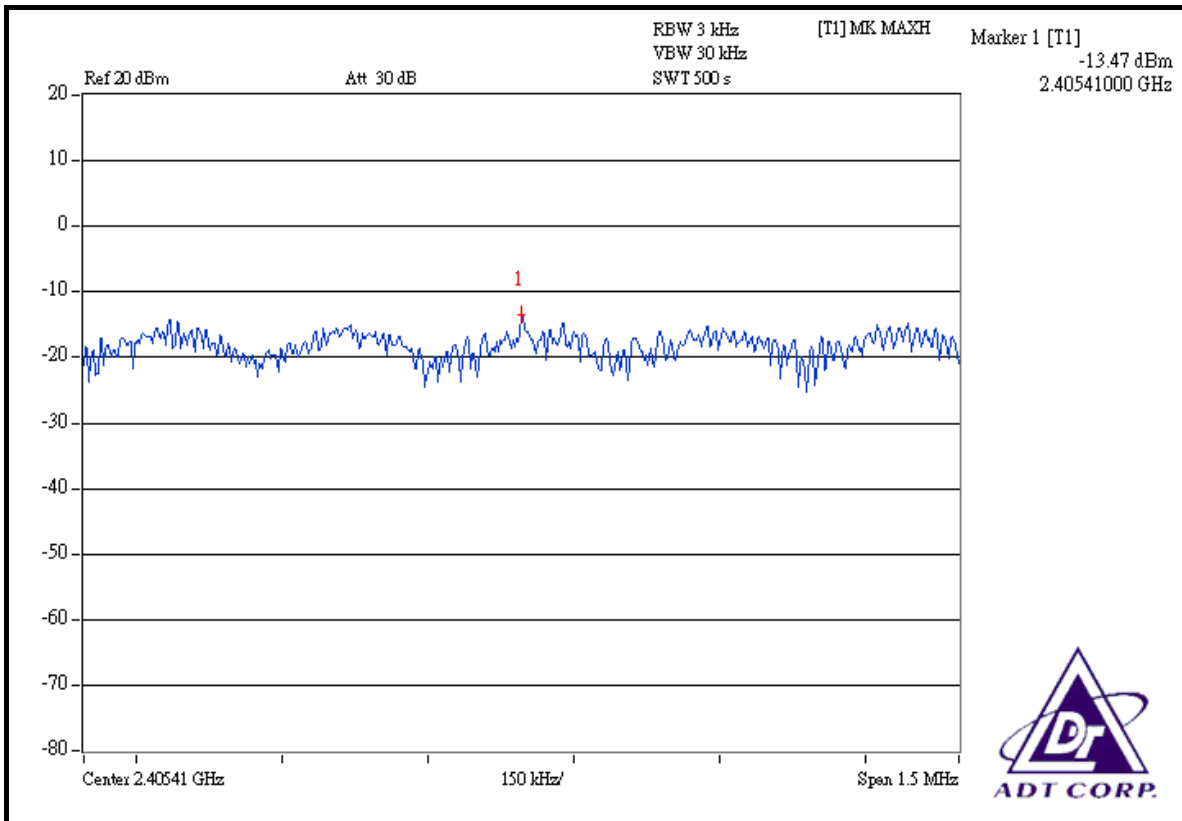

CH 6

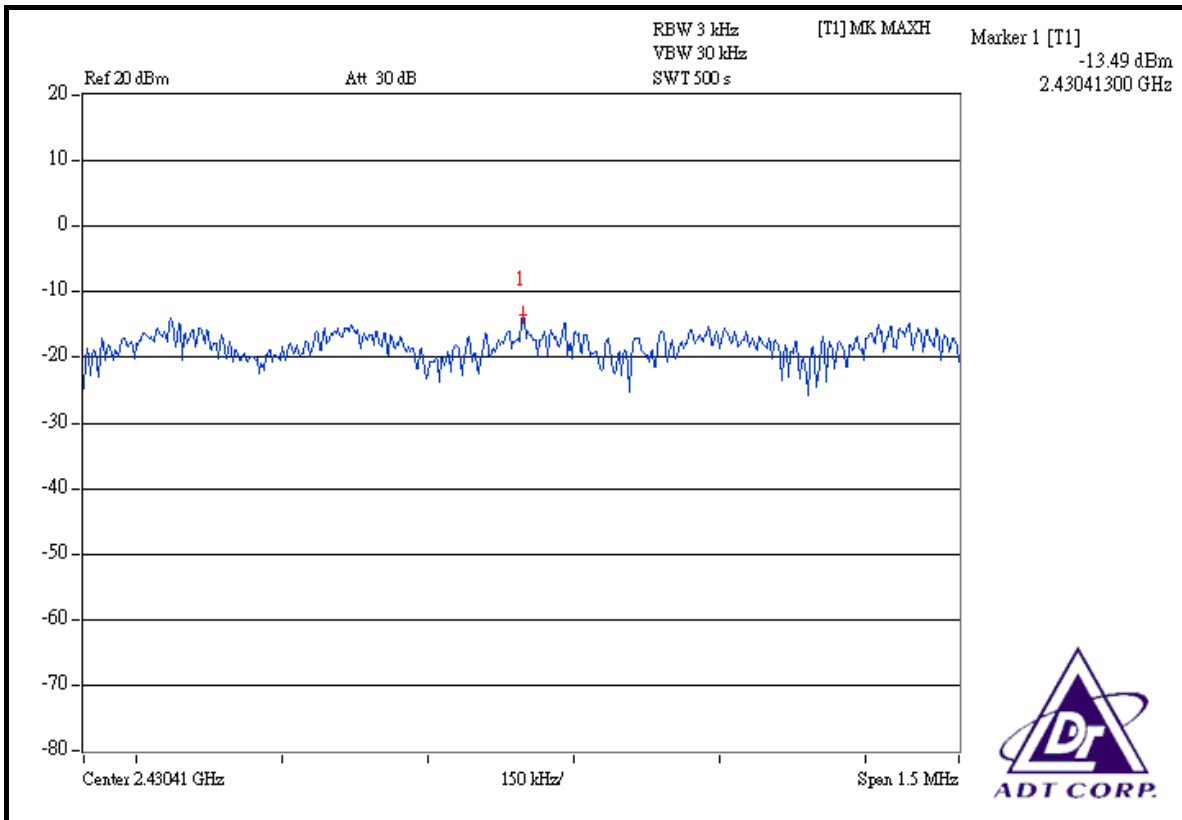



CH 11

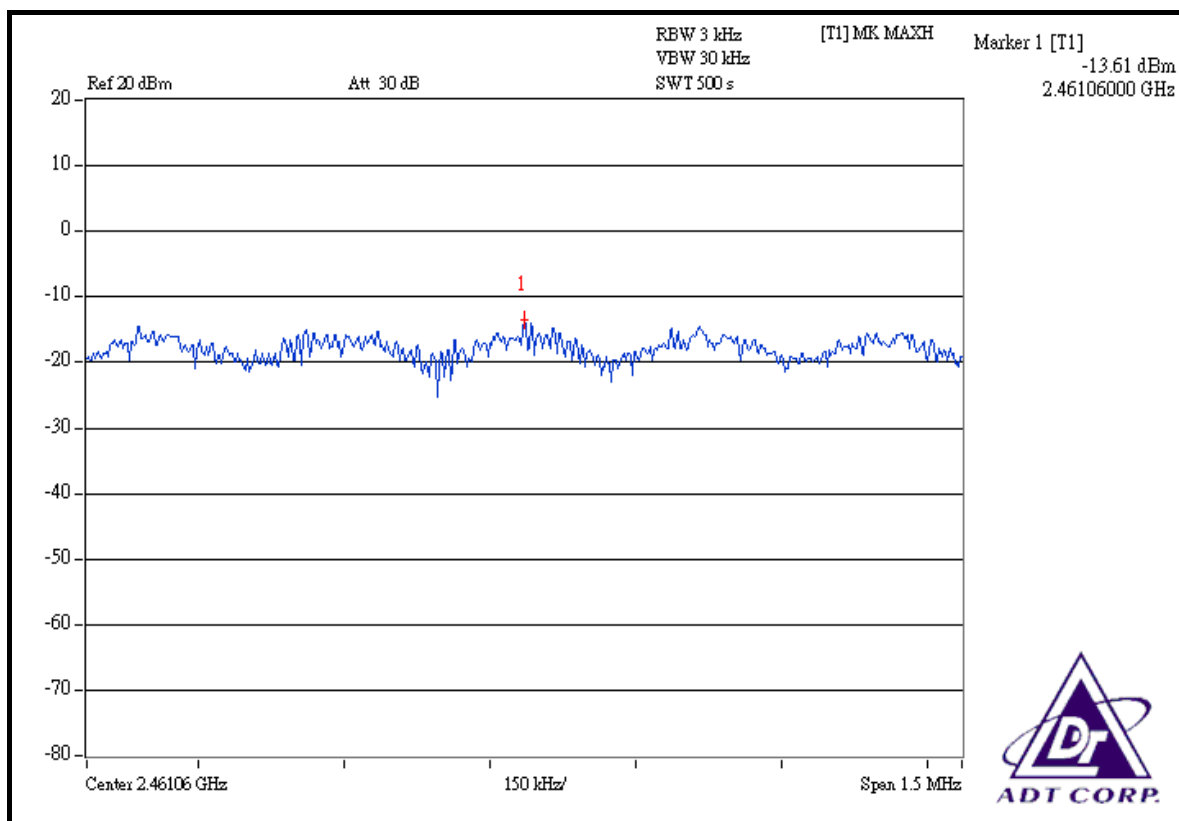



4.6 BAND EDGES MEASUREMENT

4.6.1 LIMITS OF BAND EDGES MEASUREMENT

Below -20dB of the highest emission level of operating band (in 100kHz Resolution Bandwidth).

4.6.2 TEST INSTRUMENTS

Description & Manufacturer	Model No.	Serial No.	Calibrated Until
R&S SPECTRUM ANALYZER	FSP40	100040	Jun. 07, 2007

NOTE: The calibration interval of the above test instruments is 12 months and the calibrations are traceable to NML/ROC and NIST/USA.

4.6.3 TEST PROCEDURE

The transmitter output was connected to the spectrum analyzer via a low loss cable. Set both RBW and VBW of spectrum analyzer to 100 kHz with suitable frequency span including 100 MHz bandwidth from band edge. The band edges was measured and recorded.

The spectrum plots (Peak RBW=VBW=100kHz ; Average RBW=1MHz, VBW=10Hz) are attached on the following pages.

4.6.4 DEVIATION FROM TEST STANDARD

No deviation

4.6.5 EUT OPERATING CONDITION

Same as Item 4.3.6

4.6.6 TEST RESULTS

The spectrum plots are attached on the following 12 images. D1 line indicates the highest level, and D2 line indicates the 20dB offset below D1. It shows compliance with the requirement in part 15.247(d).

802.11b DSSS modulation

Mode A

NOTE 1: The band edge emission plot on the next page shows 45.91dBc between carrier maximum power and local maximum emission in restrict band (2.36840000GHz). The emission of carrier strength list in the test result of channel 1 at the item 4.2.7 is 102.46dBuV/m (Peak), so the maximum field strength in restrict band is $102.46 - 45.91 = 56.55$ dBuV/m which is under 74dBuV/m limit.

The band edge emission plot of on the next page shows 57.28dBc between carrier maximum power and local maximum emission in restrict band (2.39000000GHz). The emission of carrier strength list in the test result of channel 1 at the item 4.2.7 is 97.04dBuV/m (Average), so the maximum field strength in restrict band is $97.04 - 57.28 = 39.76$ dBuV/m which is under 54dBuV/m limit.

NOTE 2: The band edge emission plot on the next second page shows 48.29dBc between carrier maximum power and local maximum emission in restrict band (2.48780000GHz). The emission of carrier strength list in the test result of channel 11 at the item 4.2.7 is 102.10dBuV/m (Peak), so the maximum field strength in restrict band is $102.10 - 48.29 = 53.81$ dBuV/m which is under 74dBuV/m limit.

The band edge emission plot on the next third page shows 58.09dBc between carrier maximum power and local maximum emission in restrict band (2.48380000GHz). The emission of carrier strength list in the test result of channel 11 at the item 4.2.7 is 97.70dBuV/m (Average), so the maximum field strength in restrict band is $97.70 - 58.09 = 39.61$ dBuV/m which is under 54dBuV/m limit.



Mode B

NOTE 1: The band edge emission plot on the next page shows 45.91dBc between carrier maximum power and local maximum emission in restrict band (2.36840000GHz). The emission of carrier strength list in the test result of channel 1 at the item 4.2.7 is 103.77dBuV/m (Peak), so the maximum field strength in restrict band is $103.77 - 45.91 = 57.86$ dBuV/m which is under 74dBuV/m limit.

The band edge emission plot of on the next page shows 57.28dBc between carrier maximum power and local maximum emission in restrict band (2.39000000GHz). The emission of carrier strength list in the test result of channel 1 at the item 4.2.7 is 99.51dBuV/m (Average), so the maximum field strength in restrict band is $99.51 - 57.28 = 42.23$ dBuV/m which is under 54dBuV/m limit.

NOTE 2: The band edge emission plot on the next second page shows 48.29dBc between carrier maximum power and local maximum emission in restrict band (2.48780000GHz). The emission of carrier strength list in the test result of channel 11 at the item 4.2.7 is 103.98dBuV/m (Peak), so the maximum field strength in restrict band is $103.98 - 48.29 = 55.69$ dBuV/m which is under 74dBuV/m limit.

The band edge emission plot on the next third page shows 58.09dBc between carrier maximum power and local maximum emission in restrict band (2.48380000GHz). The emission of carrier strength list in the test result of channel 11 at the item 4.2.7 is 99.61dBuV/m (Average), so the maximum field strength in restrict band is $99.61 - 58.09 = 41.52$ dBuV/m which is under 54dBuV/m limit.

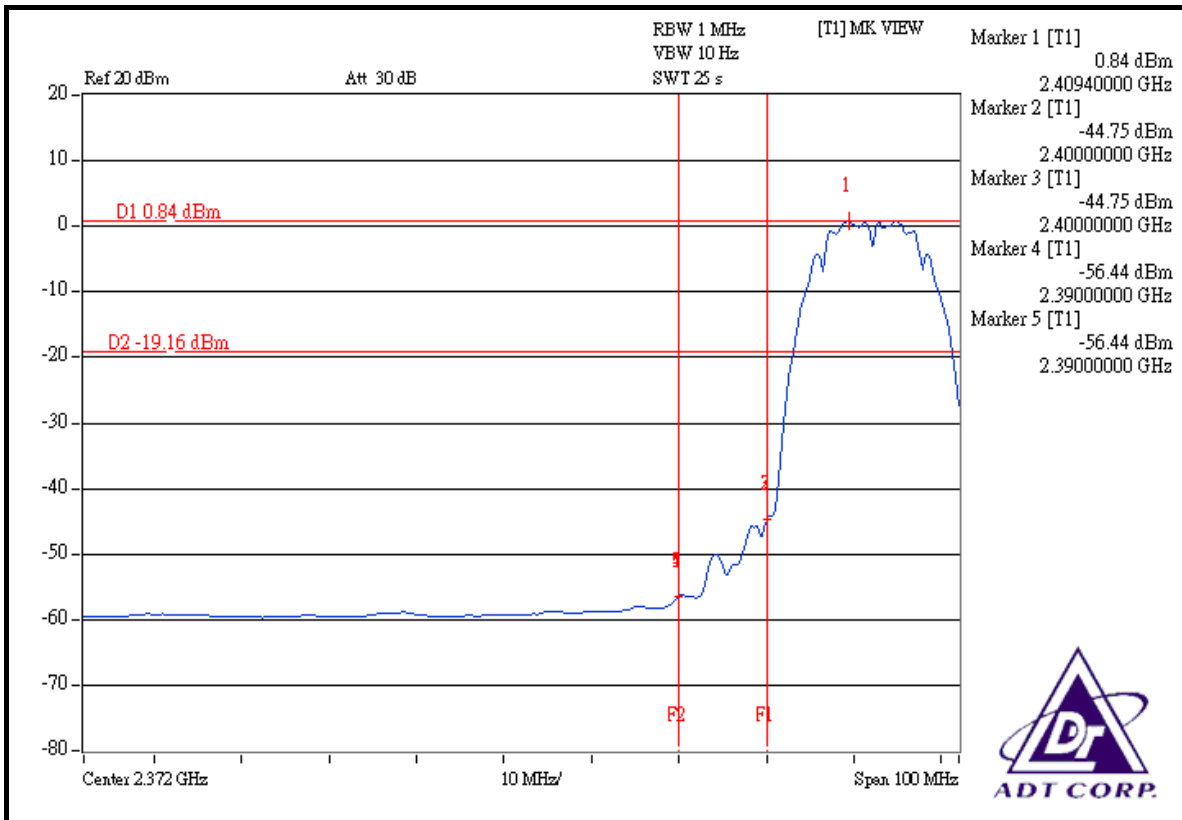
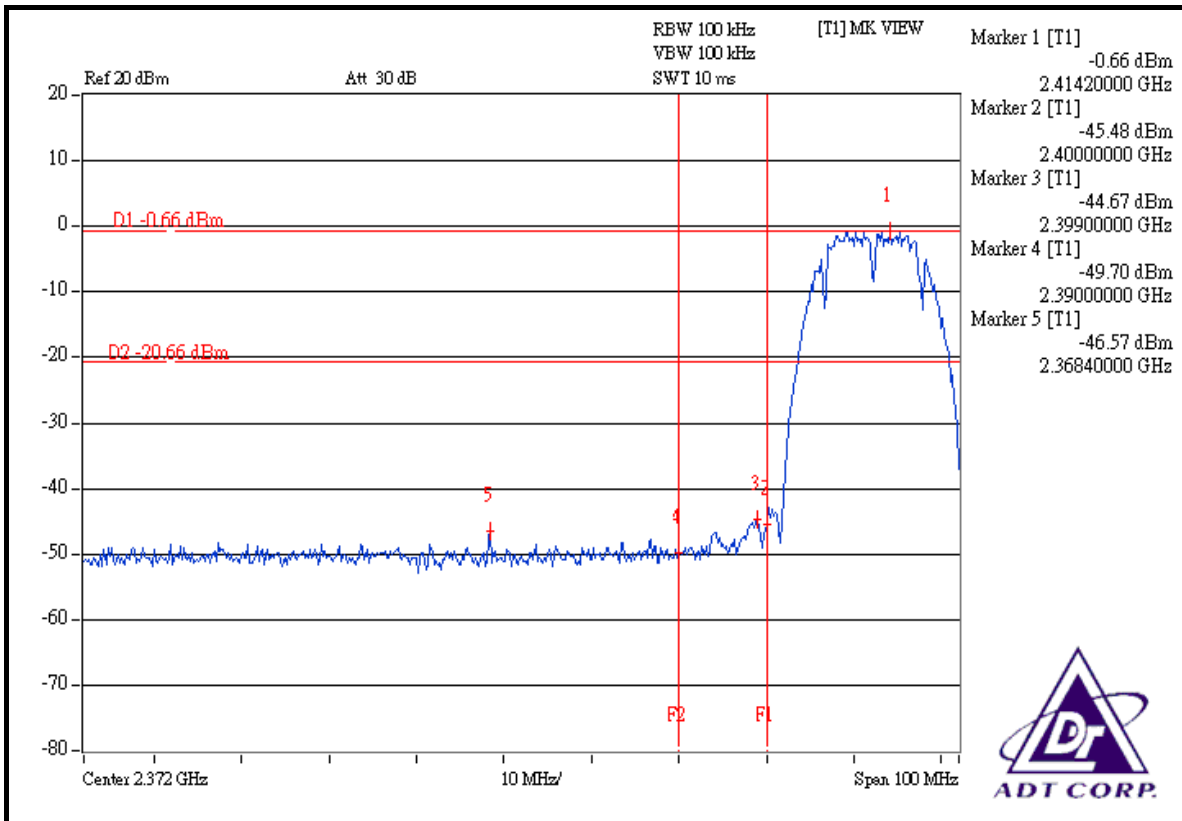

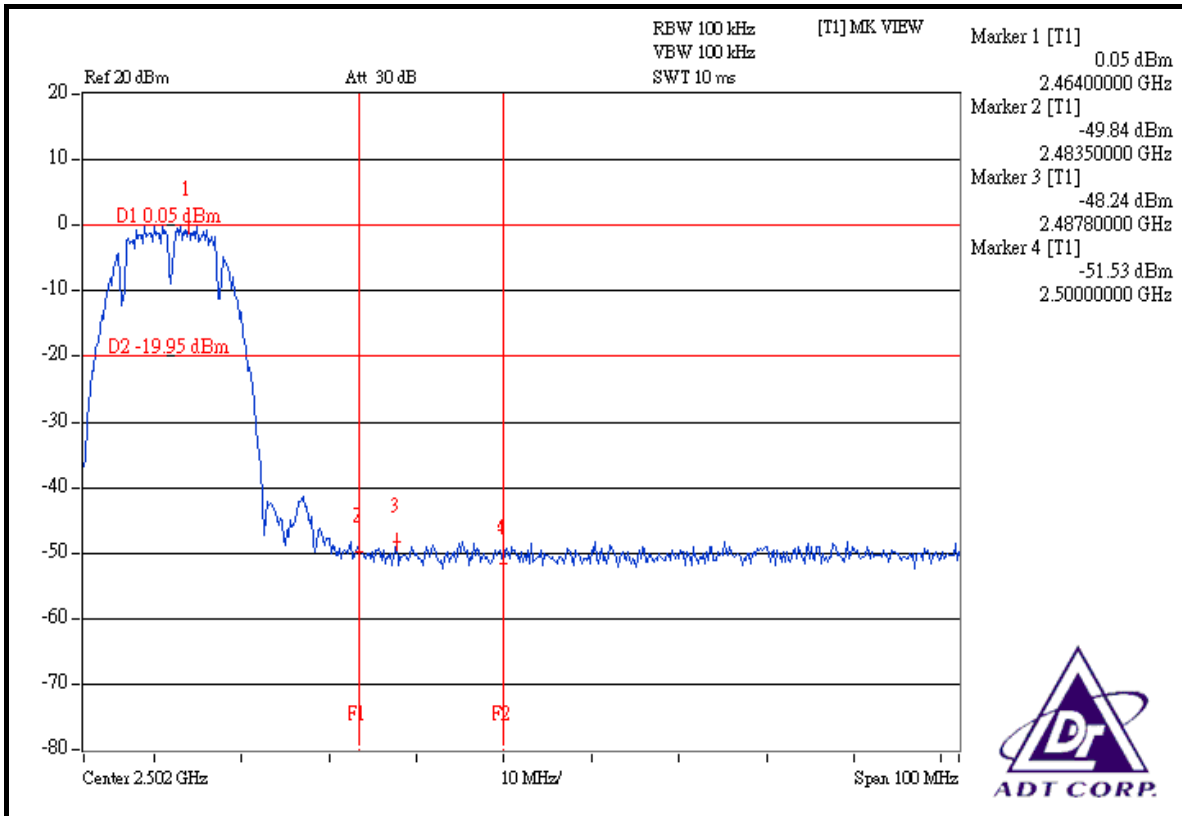
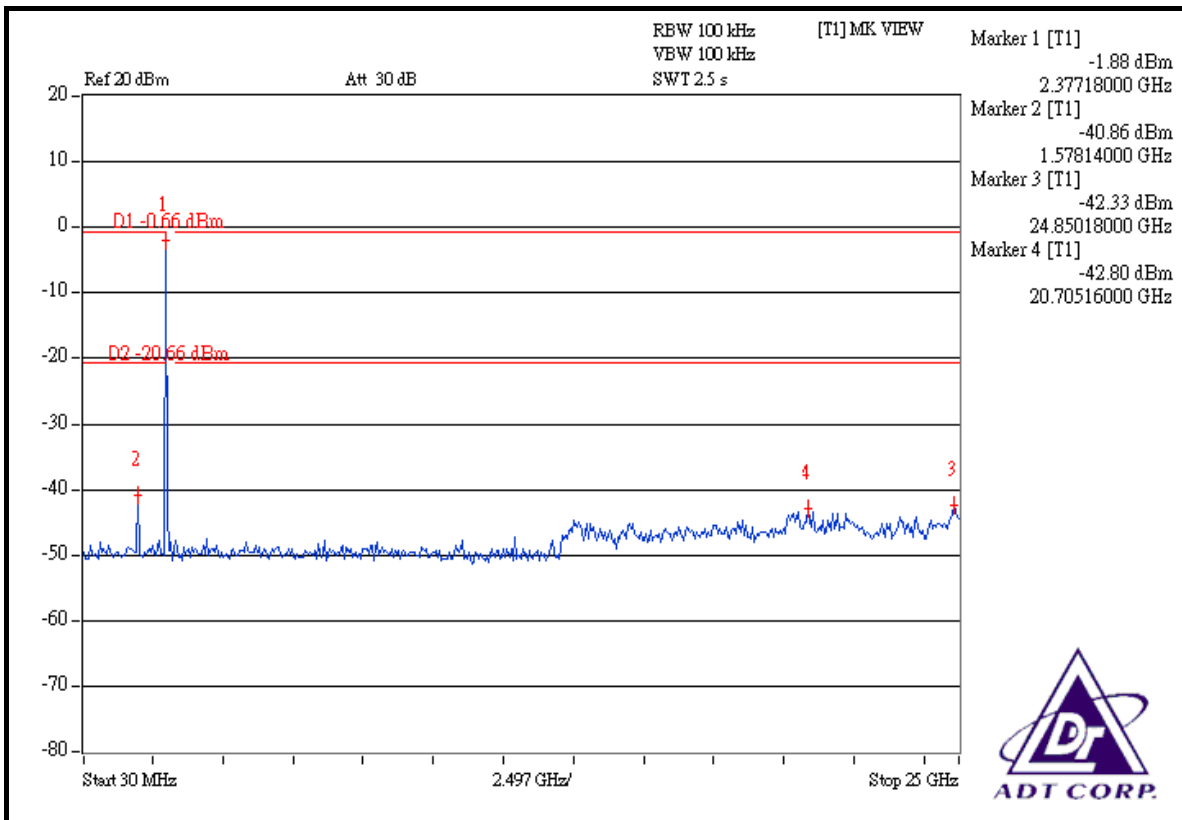

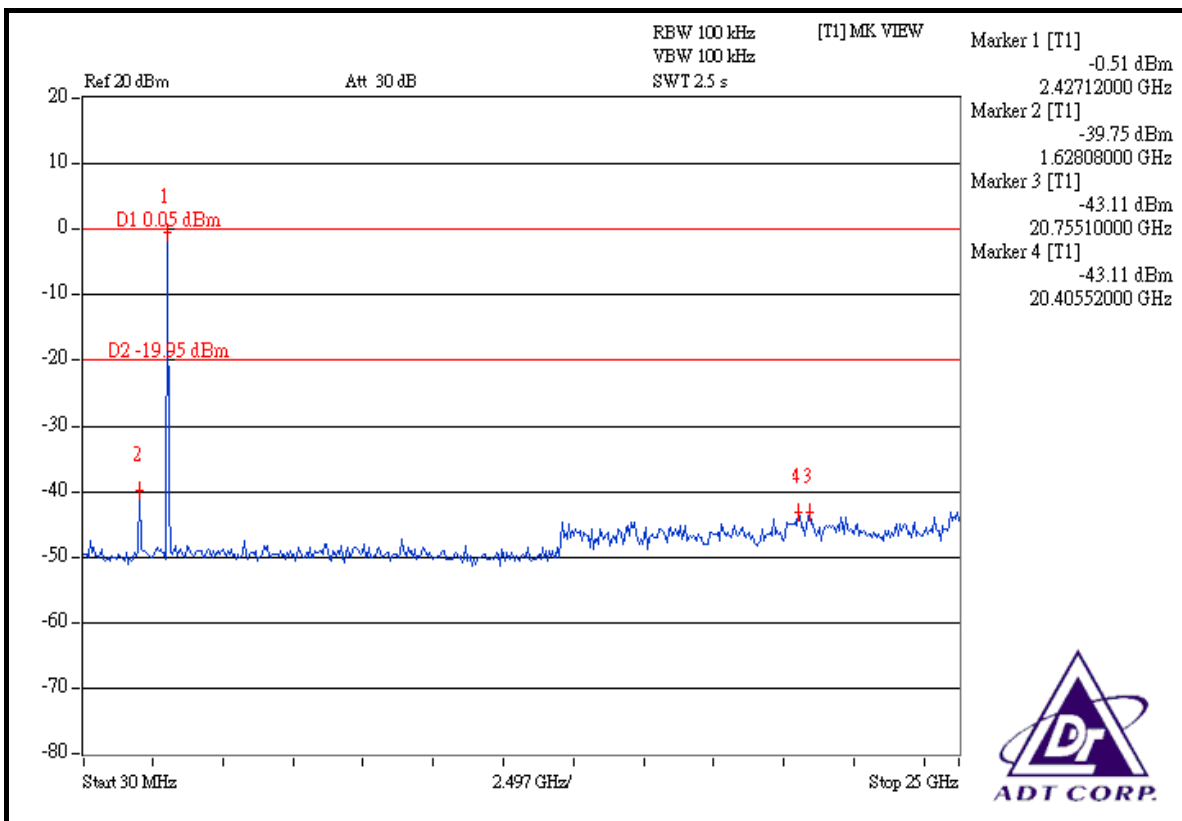
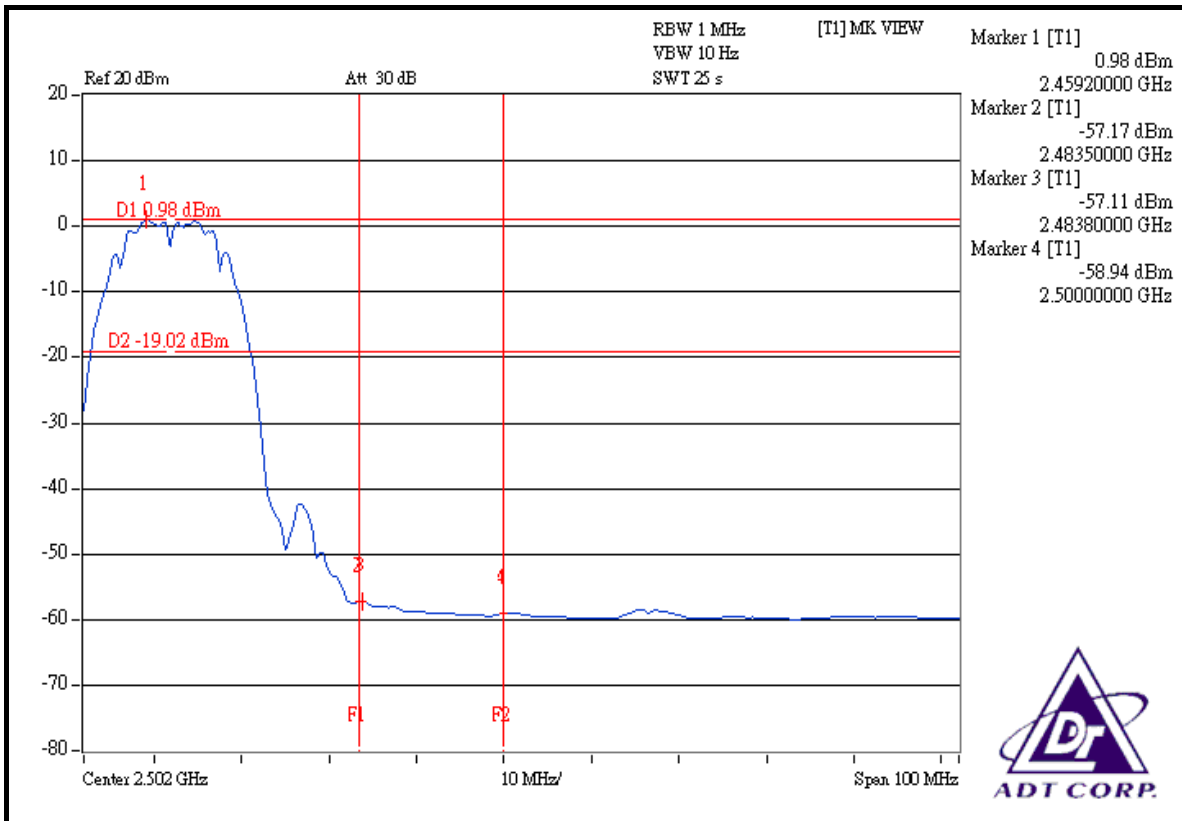

802.11g OFDM modulation

Mode A

NOTE 1: The band edge emission plot on the next page shows 40.76dBc between carrier maximum power and local maximum emission in restrict band (2.38940000GHz). The emission of carrier strength list in the test result of channel 1 at the item 4.2.7 is 107.86dBuV/m (Peak), so the maximum field strength in restrict band is $107.86 - 40.76 = 67.10$ dBuV/m which is under 74dBuV/m limit.

The band edge emission plot of on the next page shows 46.90dBc between carrier maximum power and local maximum emission in restrict band (2.39000000GHz). The emission of carrier strength list in the test result of channel 1 at the item 4.2.7 is 97.56dBuV/m (Average), so the maximum field strength in restrict band is $97.56 - 46.90 = 50.66$ dBuV/m which is under 54dBuV/m limit.

NOTE 2: The band edge emission plot on the next second page shows 43.22dBc between carrier maximum power and local maximum emission in restrict band (2.48360000GHz). The emission of carrier strength list in the test result of channel 11 at the item 4.2.7 is 106.22dBuV/m (Peak), so the maximum field strength in restrict band is $106.22 - 43.22 = 63.00$ dBuV/m which is under 74dBuV/m limit.

The band edge emission plot on the next third page shows 47.15dBc between carrier maximum power and local maximum emission in restrict band (2.48350000GHz). The 96.08dBuV/m (Average), so the maximum field strength in restrict band is $96.08 - 47.15 = 48.93$ dBuV/m which is under 54dBuV/m limit.

Mode B

NOTE 1: The band edge emission plot on the next page shows 40.76dBc between carrier maximum power and local maximum emission in restrict band (2.38940000GHz). The emission of carrier strength list in the test result of channel 1 at the item 4.2.7 is 108.24dBuV/m (Peak), so the maximum field strength in restrict band is $108.24 - 40.76 = 67.48$ dBuV/m which is under 74dBuV/m limit.

The band edge emission plot of on the next page shows 46.90dBc between carrier maximum power and local maximum emission in restrict band (2.39000000GHz). The emission of carrier strength list in the test result of channel 1 at the item 4.2.7 is 98.12dBuV/m (Average), so the maximum field strength in restrict band is $98.12 - 46.90 = 51.22$ dBuV/m which is under 54dBuV/m limit.

NOTE 2: The band edge emission plot on the next second page shows 43.22dBc between carrier maximum power and local maximum emission in restrict band (2.48360000GHz). The emission of carrier strength list in the test result of channel 11 at the item 4.2.7 is 107.72dBuV/m (Peak), so the maximum field strength in restrict band is $107.72 - 43.22 = 64.50$ dBuV/m which is under 74dBuV/m limit.

The band edge emission plot on the next third page shows 47.15dBc between carrier maximum power and local maximum emission in restrict band (2.48350000GHz). The 97.30dBuV/m (Average), so the maximum field strength in restrict band is $97.30 - 47.15 = 50.15$ dBuV/m which is under 54dBuV/m limit.

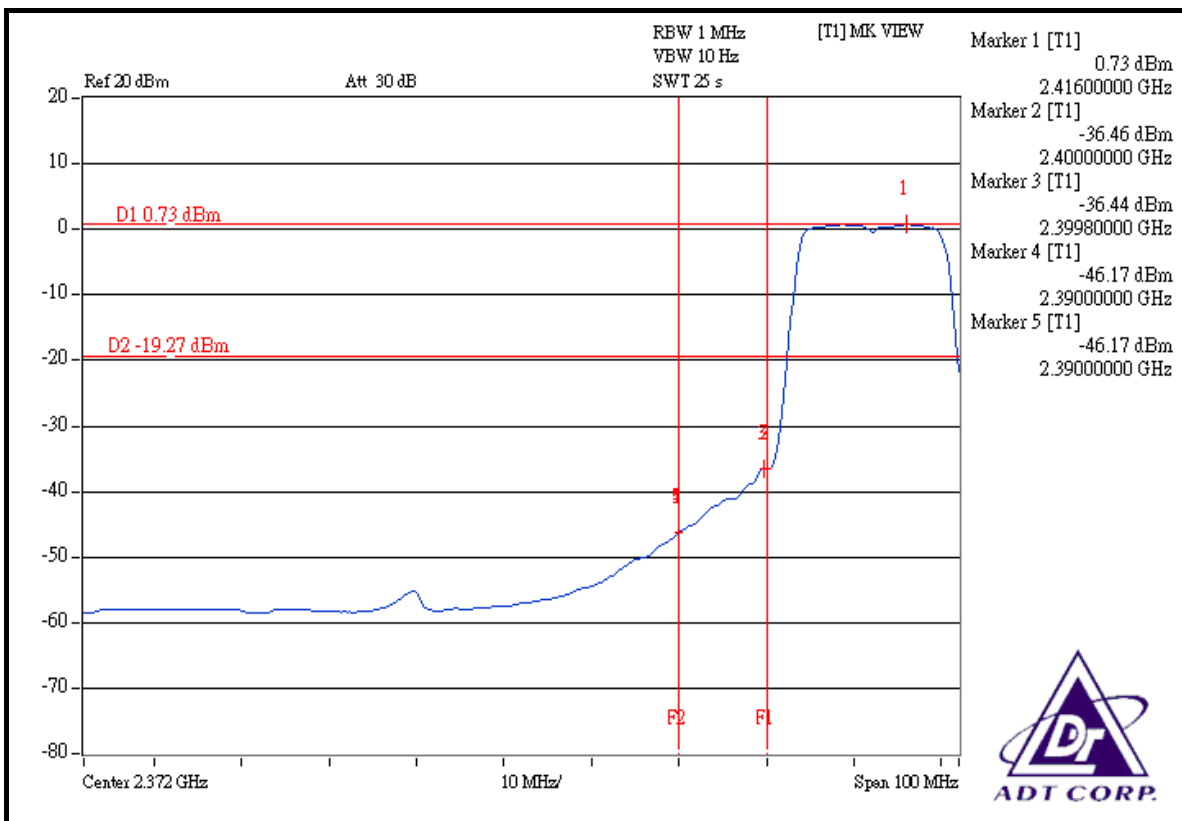
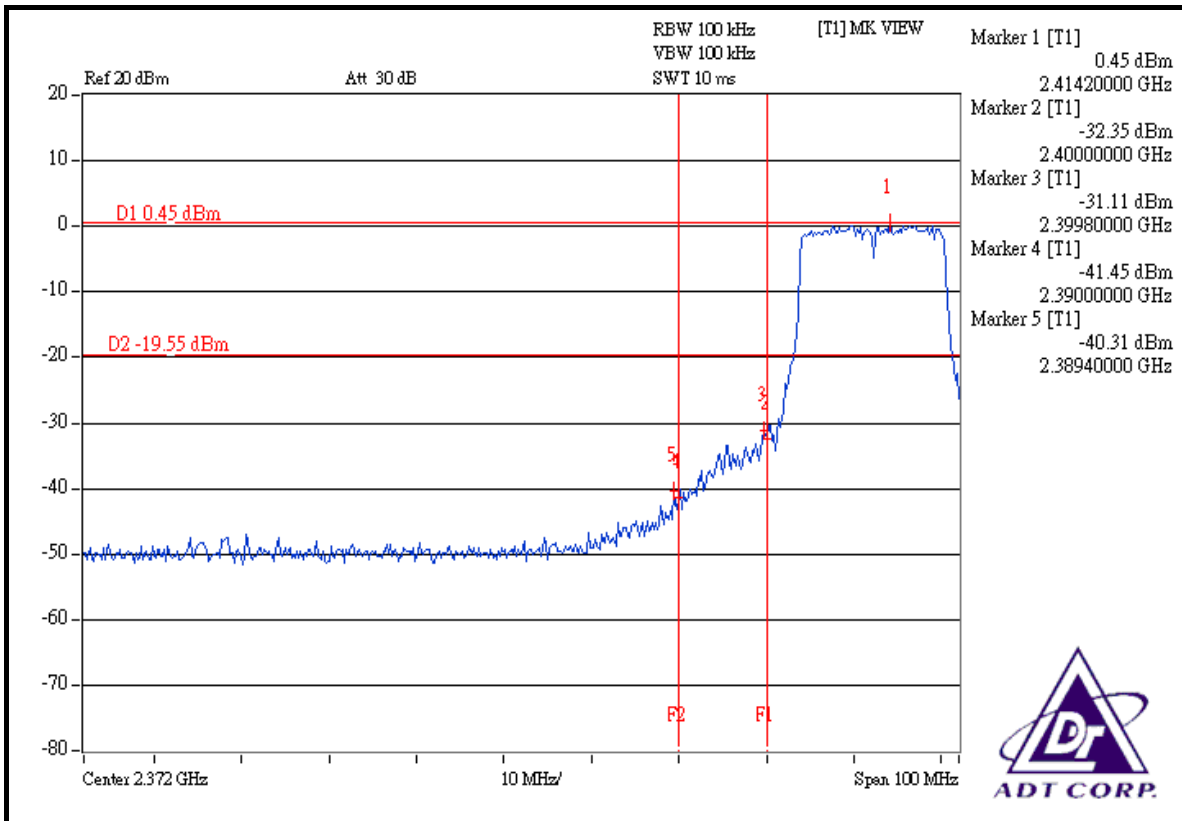

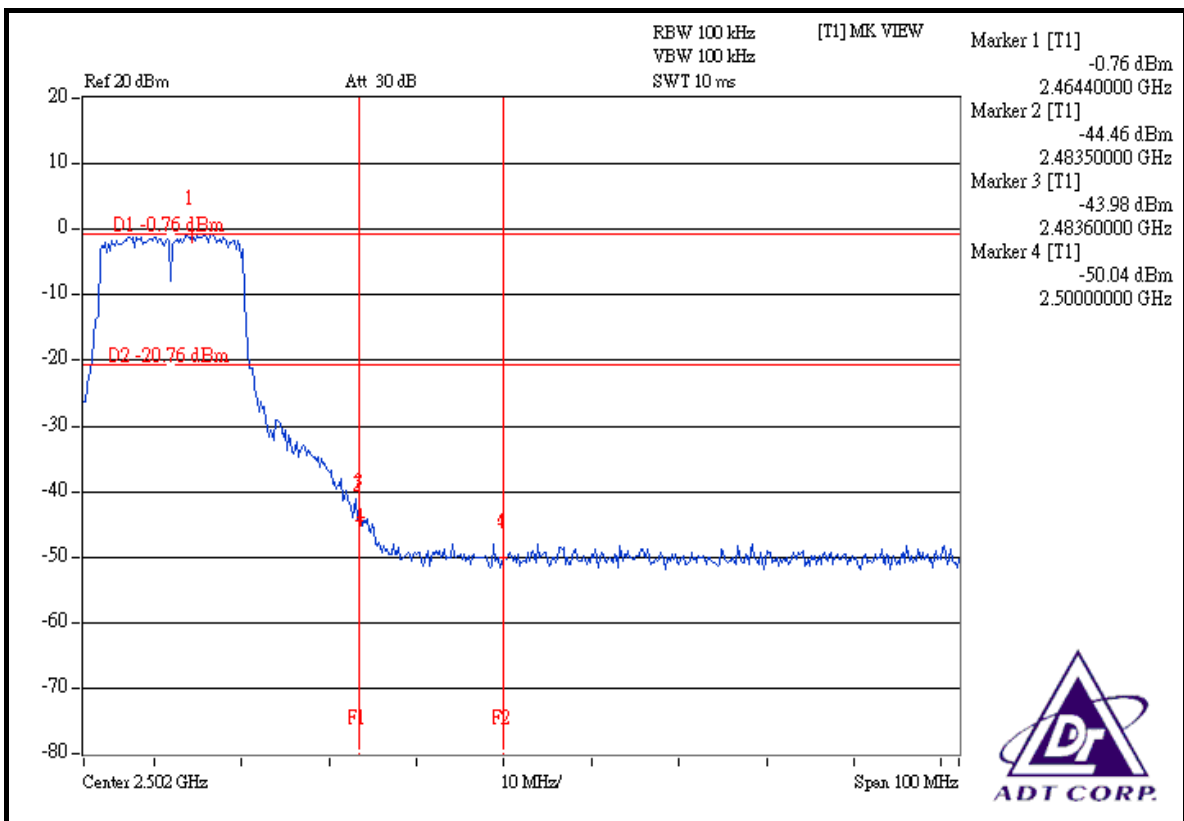
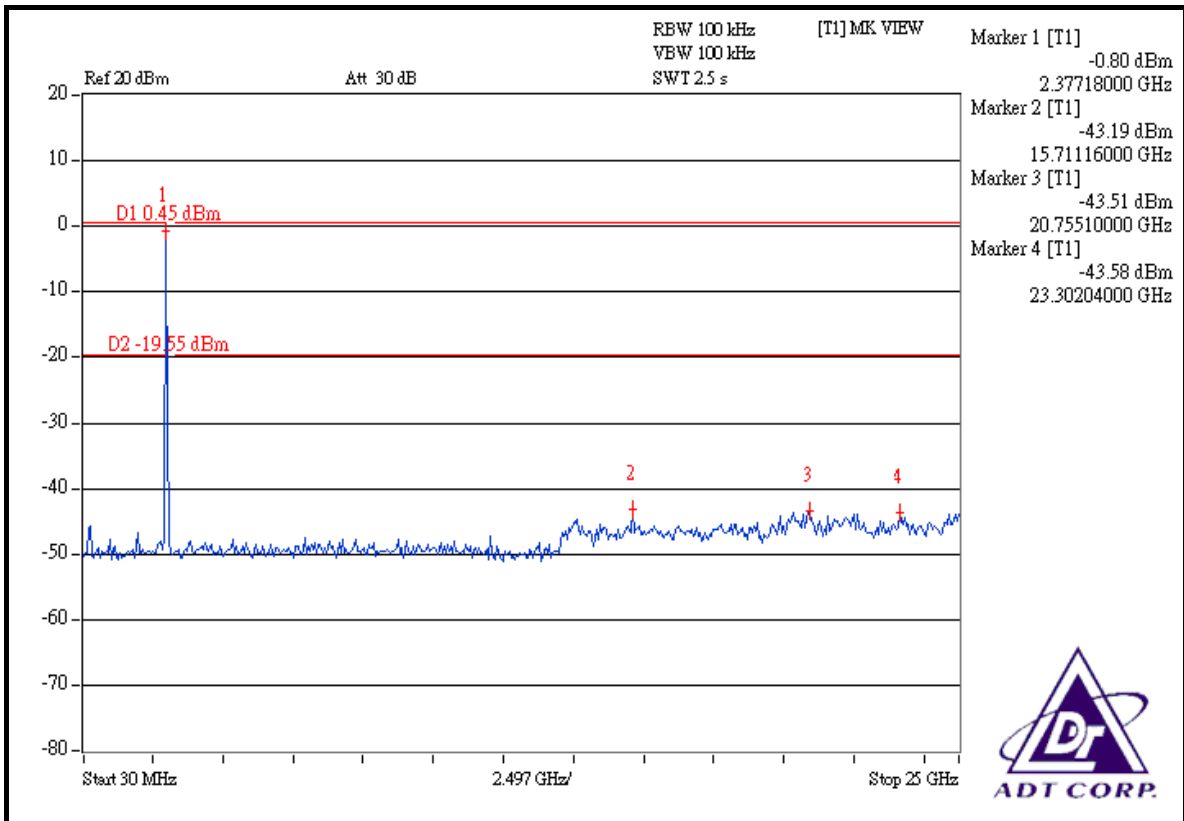

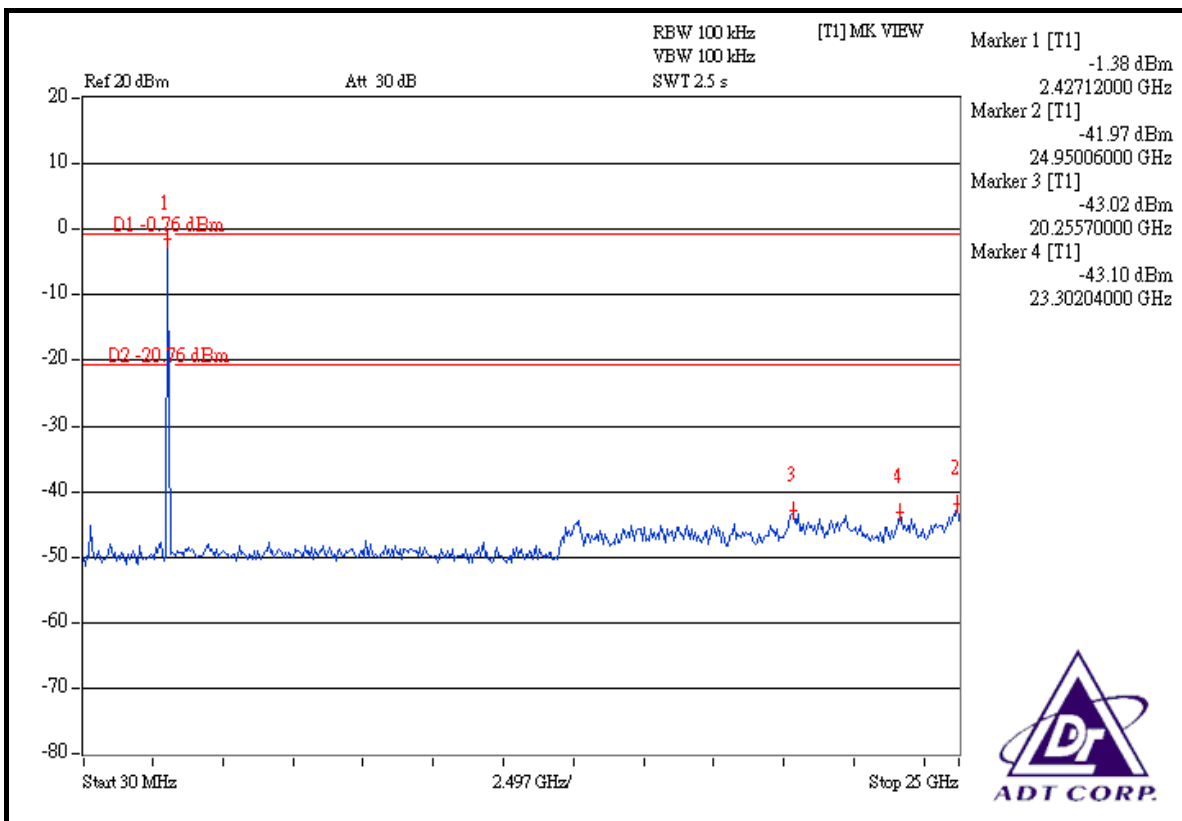
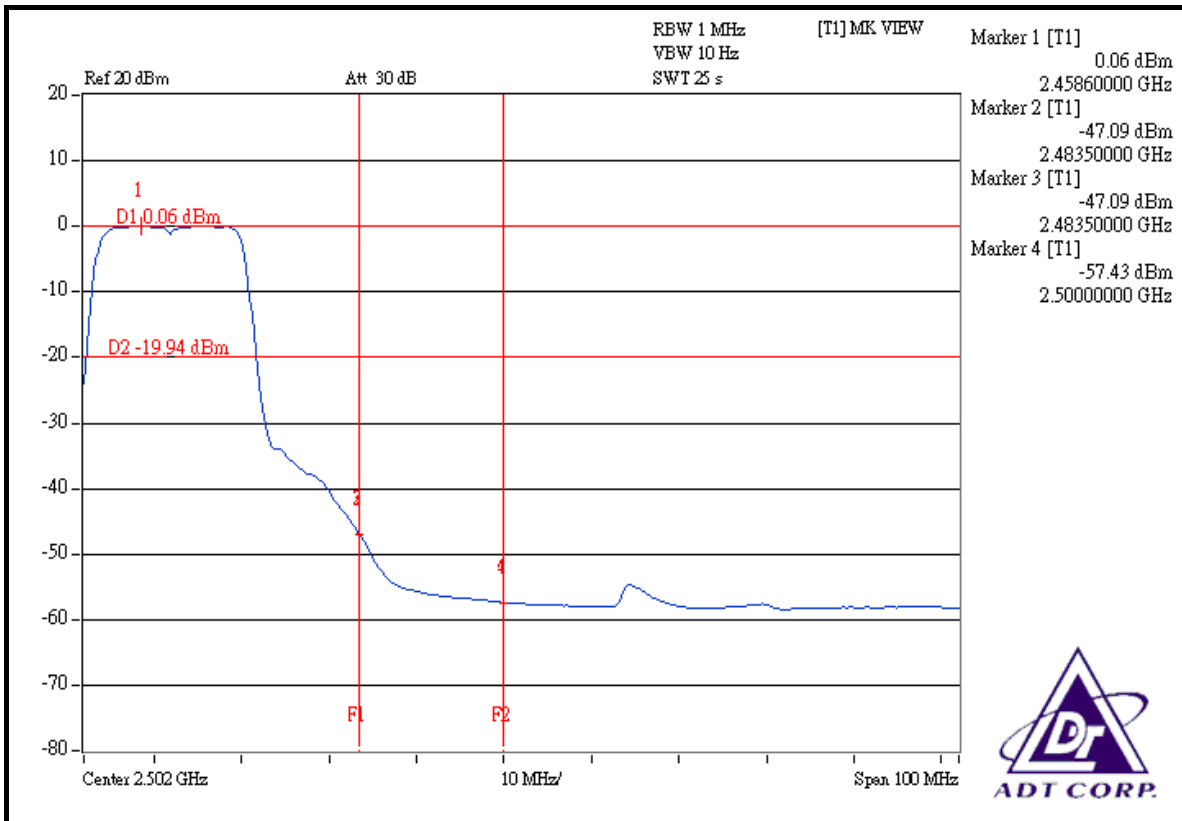

4.7 ANTENNA REQUIREMENT

4.7.1 STANDARD APPLICABLE

For intentional device, according to FCC 47 CFR Section 15.203, an intentional radiator shall be designed to ensure that no antenna other than that furnished by the responsible party shall be used with the device. And according to FCC 47 CFR Section 15.247 (b), if transmitting antennas of directional gain greater than 6dBi are used, the power shall be reduced by the amount in dB that the directional gain of the antenna exceeds 6dBi.

4.7.2 ANTENNA CONNECTED CONSTRUCTION

The antennas used in this product are PIFA antenna with UFL connector and Dipole antenna with R-SMA connector. The maximum Gain of the antenna is 2.3dBi.



5. PHOTOGRAPHS OF THE TEST CONFIGURATION

Please refer to the attached file (Test Setup Photo).



6. INFORMATION ON THE TESTING LABORATORIES

We, ADT Corp., were founded in 1988 to provide our best service in EMC, Radio, Telecom and Safety consultation. Our laboratories are accredited and approved by the following approval agencies according to ISO/IEC 17025.

USA	FCC, UL, A2LA
Germany	TUV Rheinland
Japan	VCCI
Norway	NEMKO
Canada	INDUSTRY CANADA , CSA
R.O.C.	CNLA, BSMI, NCC
Netherlands	Telefication
Singapore	PSB , GOST-ASIA(MOU)
Russia	CERTIS(MOU)

Copies of accreditation certificates of our laboratories obtained from approval agencies can be downloaded from our web site:

www.adt.com.tw/index.5/phtml. If you have any comments, please feel free to contact us at the following:

Linko EMC/RF Lab:

Tel: 886-2-26052180
Fax: 886-2-26051924

Hsin Chu EMC/RF Lab:

Tel: 886-3-5935343
Fax: 886-3-5935342

Hwa Ya EMC/RF/Safety Telecom Lab:

Tel: 886-3-3183232
Fax: 886-3-3185050

Web Site: www.adt.com.tw

The address and road map of all our labs can be found in our web site also.



APPENDIX-A

MODIFICATIONS RECORDERS FOR ENGINEERING CHANGES TO THE EUT BY THE LAB

No any modifications are made to the EUT by the lab during the test.