

EMC TEST REPORT

Report No. : EME-051066

Model No. : AWGS1U

Issued Date : Nov. 22, 2005

Applicant : Asia Pacific Microsystems, Inc.
No. 2, R&D Road 6, Science-Based Industrial Park,
Hsinchu, Taiwan.

Test By : Intertek Testing Services Taiwan Ltd.
No. 11, Lane 275, Ko-Nan 1 Street, Chia-Tung Li,
Shiang-Shan District, Hsinchu City, Taiwan

This test report consists of 47 pages in total. It may be duplicated completely for legal use with the allowance of the applicant. It shall not be reproduced except in full, without the written approval of Intertek Laboratory. The test result(s) in this report only applies to the tested sample(s).

Project Engineer



Kevin Chen

Reviewed By

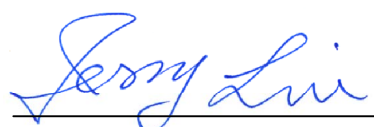

Jerry Liu

Table of Contents

Summary of Tests 4

1. General information 5

 1.1 Identification of the EUT 5

 1.2 Additional information about the EUT 5

 1.3 Antenna description 6

 1.4 Peripherals equipment 6

2. Test specifications 7

 2.1 Test standard 7

 2.2 Operation mode 7

 2.3 Test equipment 8

3. Minimum 6dB Bandwidth test 9

 3.1 Operating environment 9

 3.2 Test setup & procedure 9

 3.3 Measured data of Minimum 6dB Bandwidth test results 9

4. Maximum Output Power test 16

 4.1 Operating environment 16

 4.2 Test setup & procedure 16

 4.3 Measured data of Maximum Output Power test results 16

5. Radiated Emission test 17

 5.1 Operating environment 17

 5.2 Test setup & procedure 17

 5.3 Emission limits 18

 5.4 Radiated spurious emission test data 19

 5.4.1 Measurement results: frequencies equal to or less than 1 GHz 19

 5.4.2 Measurement results: frequency above 1GHz 20

6. Power Spectrum Density test 26

 6.1 Operating environment 26

 6.2 Test setup & procedure 26

 6.3 Measured data of Power Spectrum Density test results 26

7. Emission on the band edge 33

 7.1 Operating environment 33

 7.2 Test setup & procedure 33

 7.3 Test Result 34

7.3.1 Conducted Method 34

7.3.2 Radiated Method 42

8. Power Line Conducted Emission test §FCC 15.207 44

8.1 Operating environment..... 44

8.2 Test setup & procedure..... 44

8.3 Emission limit 45

8.4 Uncertainty of Conducted Emission 45

8.5 Power Line Conducted Emission test data..... 46

Summary of Tests

**802.11g WLAN + Finder Adapter-Model: AWGS1U
FCC ID: RU5AWGS1U**

Test	Reference	Results
Minimum 6dB Bandwidth test	15.247(a)(2)	Complies
Maximum Output Power test	15.247(b)	Complies
Radiated Spurious Emission test	15.205, 15.209	Complies
Power Spectrum Density test	15.247(e)	Complies
Emission on the Band Edge test	15.247(d)	Complies
AC Power Line Conducted Emission test	15.207	Complies

1. General information

1.1 Identification of the EUT

Applicant	: Asia Pacific Microsystems, Inc.
Product	: 802.11g WLAN + Finder Adapter
Model No.	: AWGS1U
FCC ID.	: RU5AWGS1U
Frequency Range	: 2412MHz ~ 2462MHz
Channel Number	: 11 channels
Frequency of Each Channel	: 2412MHz, 2417MHz, 2422MHz, 2427MHz, 2432MHz, 2437MHz, 2442MHz, 2447MHz, 2452MHz, 2457MHz, 2462MHz
Type of Modulation	: DSSS, OFDM
Rated Power	: 5Vdc from Notebook PC
Power Cord	: N/A
Sample Received	: Nov. 17, 2005
Test Date(s)	: Nov. 17, 2005 ~ Nov. 20, 2005

A FCC DoC report has been generated for the client.

1.2 Additional information about the EUT

The EUT is an 802.11g WLAN + Finder Adapter, and was defined as information technology equipment.

For more detail features, please refer to User's manual as file name "User Manual.pdf"

1.3 Antenna description

The EUT uses a permanently connected antenna.

Antenna Gain : 1.3dBi max (Peak)

Antenna Type : Ceramic antenna

Connector Type : N/A

1.4 Peripherals equipment

Peripherals	Manufacturer	Product No.	Serial No.	FCC ID
Notebook PC	IBM	1860	L3WM796	FCC DoC Approved
Printer	HP	C2642A	TH86K1N2ZB	FCC DoC Approved
AP	SMC	SMC2655W	S25028NU05021	FCC DoC Approved

2. Test specifications

2.1 Test standard

The EUT was performed according to the procedures in FCC Part 15 Subpart C Section § 15.205 、 §15.207 、 §15.209 、 §15.247 and ANSI C63.4/2003.

The test of radiated measurements according to FCC Part15 Section 15.33(a) had been conducted and the field strength of this frequency band were all meet limit requirement, thus we evaluate the EUT pass the specified test.

2.2 Operation mode

The EUT was supplied with 5Vdc from Notebook PC and it was running in operating mode.

Plug the EUT in to Notebook PC via USB interface, then turn on the Notebook PC power and run the test program “ZD1211EVL.exe” under windows OS, which provide by manufacturer.

During conducted emission test, the EUT works in normal mode communication with AP. While in other test, it worked in the status of continuously transmitting.

After verifying the maximum output power, the maximum output power was occurred at 1 Mbps data rate in 802.11b and at 18Mbps data rate in 802.11g. The final tests was executed under this condition and recorded in this report individually.

2.3 Test equipment

Equipment	Brand	Frequency range	Model No.	Intertek ID No.	Next Cal. Date
EMI Test Receiver	Rohde & Schwarz	9kHz~2.75GHz	ESCS 30	EC303	04/17/2006
EMI Test Receiver	Rohde & Schwarz	20Hz~26.5GHz	ESMI	EC317	08/07/2006
Spectrum Analyzer	Rohde & Schwarz	9kHz~30GHz	FSP 30	EC353	07/24/2006
Spectrum Analyzer	Rohde & Schwarz	20Hz~40GHz	FSEK 30	EC365	10/17/2006
Horn Antenna	SCHWARZBECK	1GHz~18GHz	BBHA 9120 D	EC371	12/22/2007
Horn Antenna	SCHWARZBECK	14GHz~40GHz	BBHA 9170	EC351	07/08/2007
Bilog Antenna	SCHWARZBECK	25MHz~2GHz	VULB 9168	EC347	12/22/2007
Pre-Amplifier	MITEQ	100MHz~26.5GHz	919981	EC373	12/30/2005
Pre-Amplifier	MITEQ	26GHz~40GHz	828825	EC374	01/28/2006
Wideband Peak Power Meter/ Sensor	Anritsu	100MHz~18GHz	ML2497A/ MA2491A	EC396	10/17/2006
Controller	HDGmbH	N/A	CM 100	EP346	N/A
Antenna Tower	HDGmbH	N/A	MA 240	EP347	N/A
LISN	Rohde & Schwarz	9KHz~30MHz	ESH3-Z5	EC344	01/13/2006

Note: 1. The above equipments are within the valid calibration period.

2. The test antennas (receiving antenna) are calibration per 3 years.

3. Minimum 6dB Bandwidth test

3.1 Operating environment

Temperature: 23 °C
 Relative Humidity: 50 %
 Atmospheric Pressure: 1010 hPa

3.2 Test setup & procedure

The minimum 6dB bandwidth per FCC §15.247(a)(2) was measured using a 50 ohm spectrum analyzer with the resolutions bandwidth set at 100kHz, the video bandwidth set at 300kHz, and the SPAN>>RBW. The test was performed at 3 channels (lowest, middle and highest channel). The minimum 6-dB modulation bandwidth is in the following Table.

3.3 Measured data of Minimum 6dB Bandwidth test results

Test Mode: 802.11b(DSSS Modulation) operating mode

Channel	Frequency (MHz)	Bandwidth (MHz)	Limit
1 (lowest)	2412	9.379	> 500kHz
6 (middle)	2437	9.218	> 500kHz
11 (highest)	2462	9.259	> 500kHz

Test Mode: 802.11g(OFDM Modulation) operating mode

Channel	Frequency (MHz)	Bandwidth (MHz)	Limit
1 (lowest)	2412	16.553	> 500kHz
6 (middle)	2437	16.553	> 500kHz
11 (highest)	2462	16.553	> 500kHz

Please see the plot below.

Test Mode: 802.11b(DSSS Modulation) operating mode

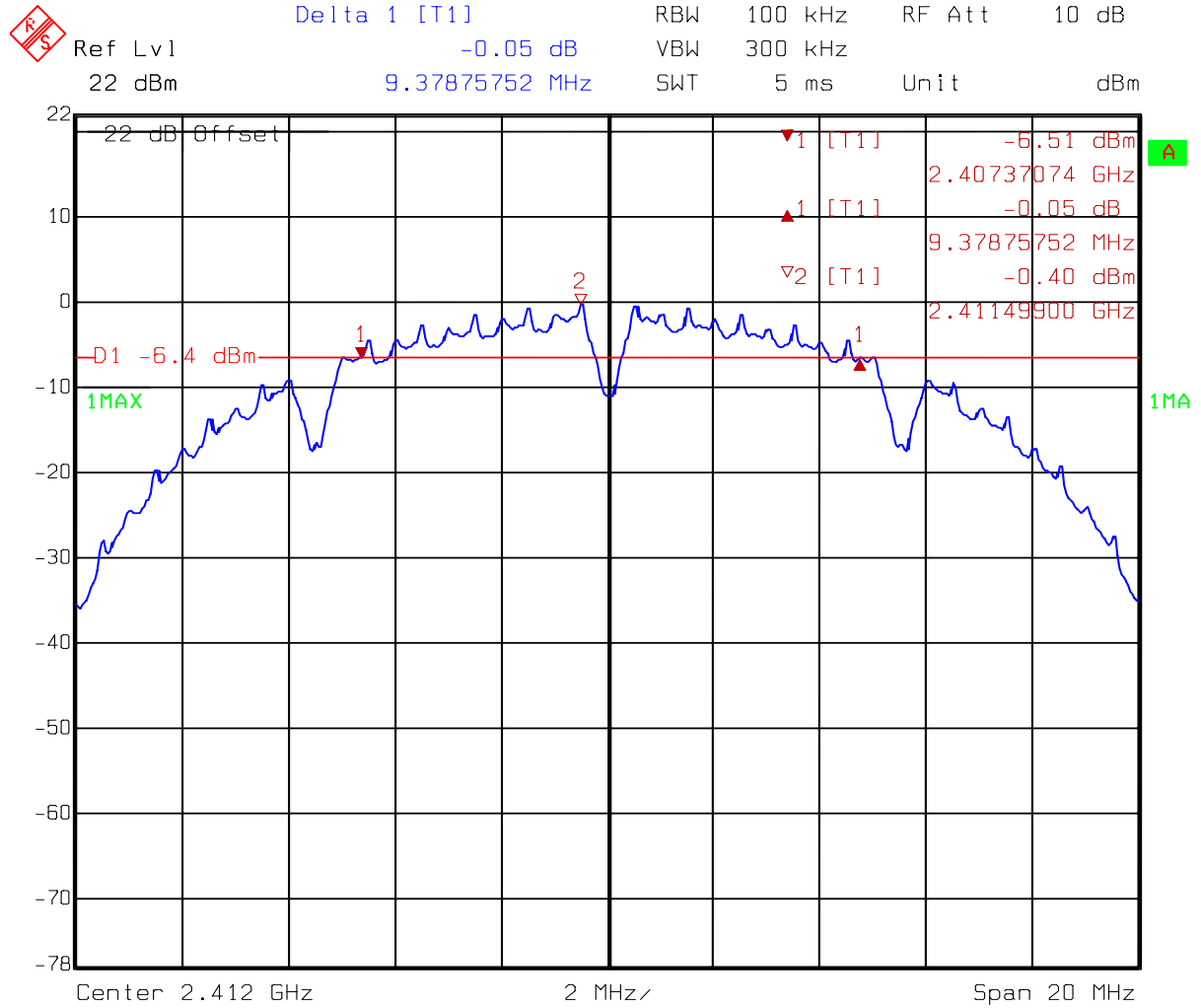

Comment A: 6dB BW at 11b_ch1
 EC365
 Date: 18.NOV.2005 14:27:38

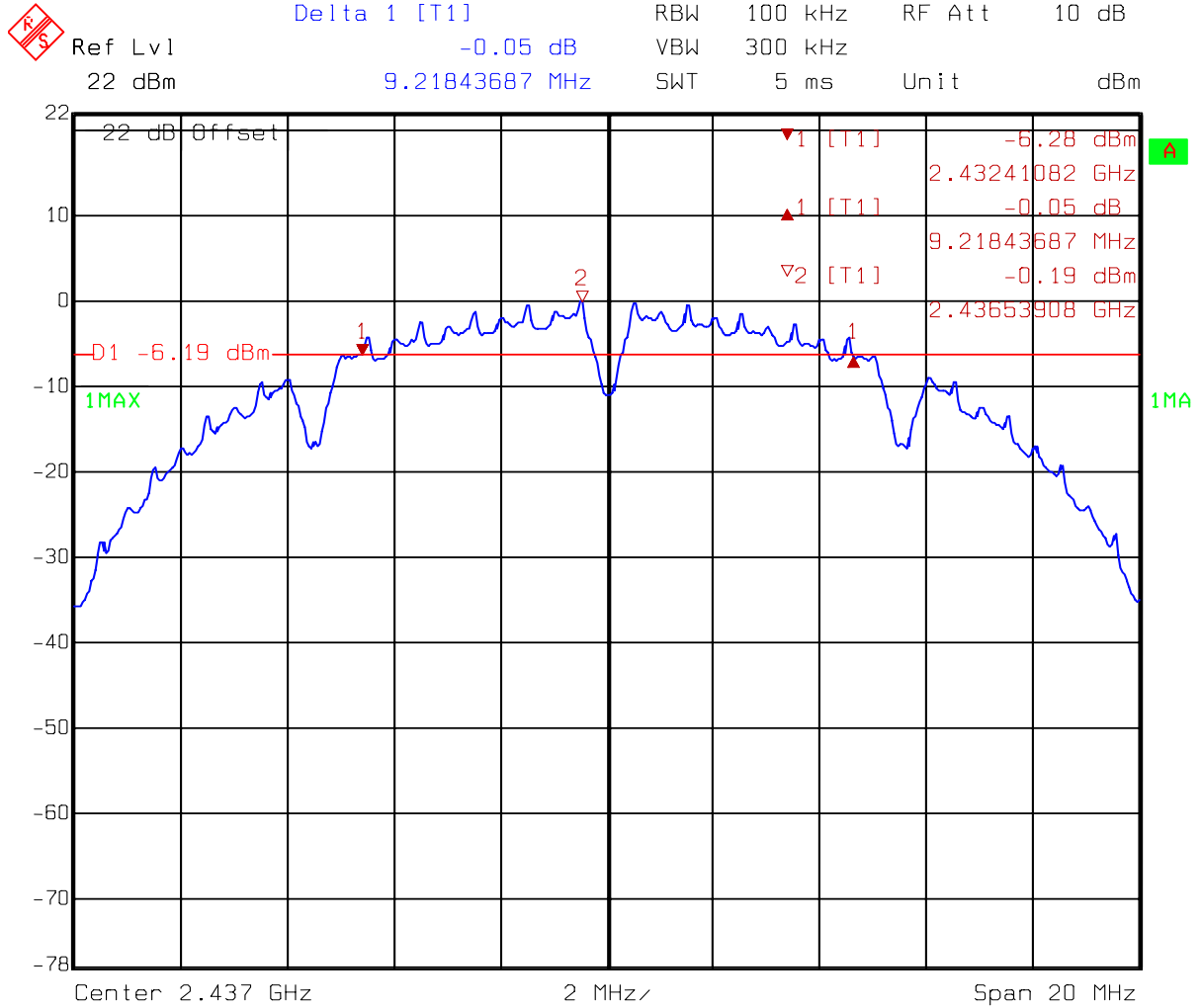

Comment A: 6dB BW at 11b_ch6
EC365

Date: 18.NOV.2005 14:22:57

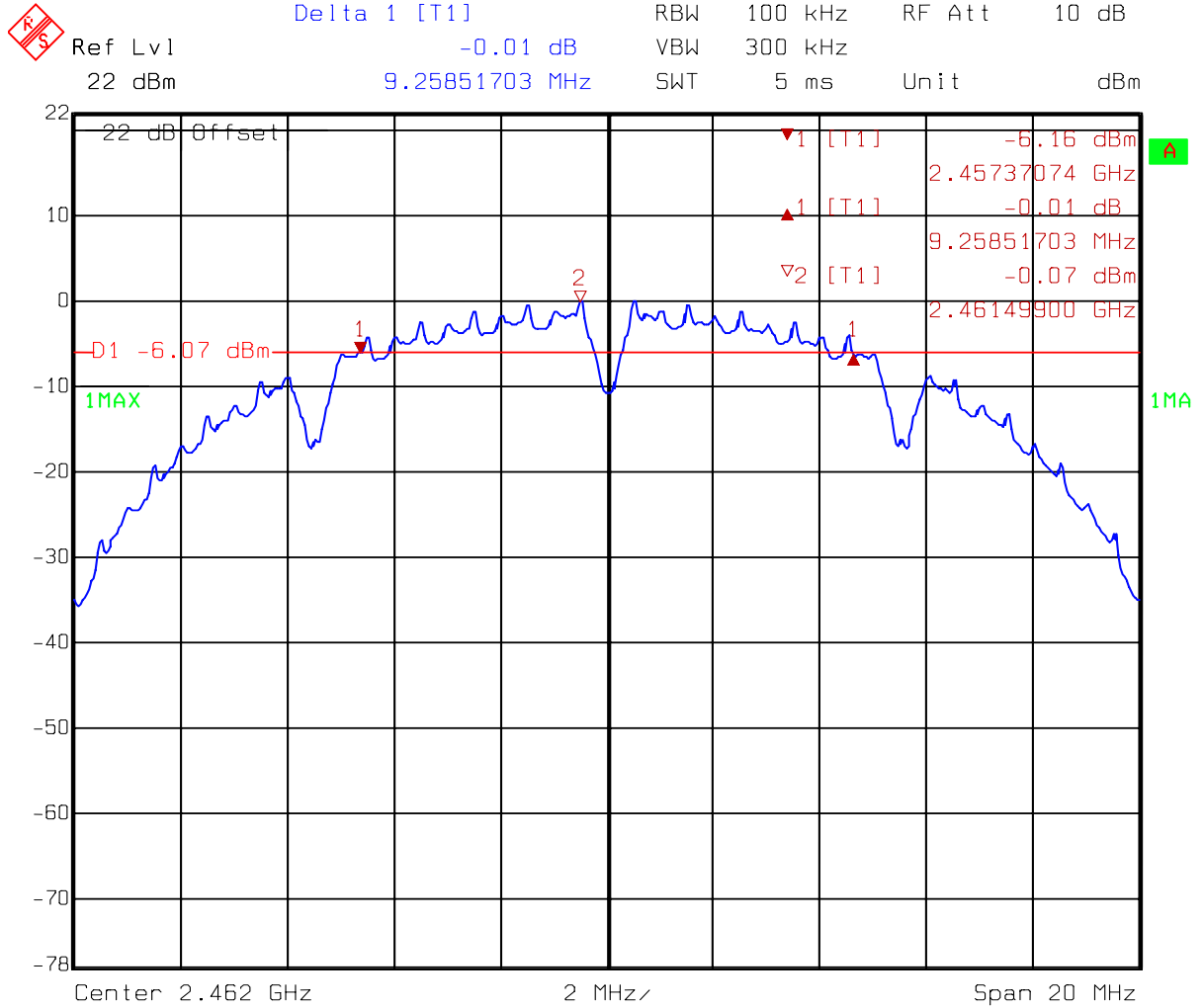

Comment A: 6dB BW at 11b_ch11
 EC365
 Date: 18.NOV.2005 14:20:18

Test Mode: 802.11g(OFDM Modulation) operating mode

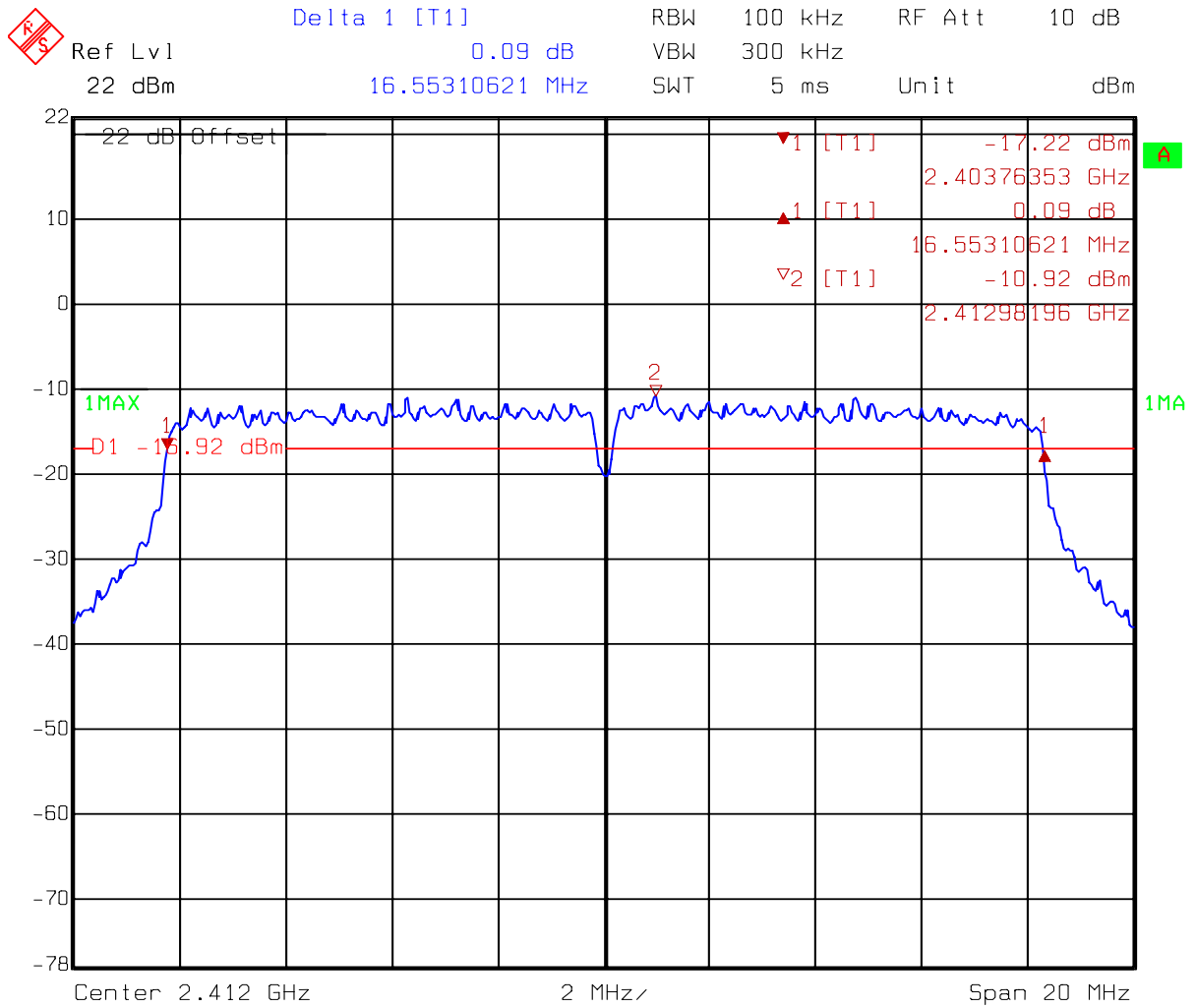

Comment A: 6dB BW at 11g_ch1
EC365

Date: 18.NOV.2005 14:11:32

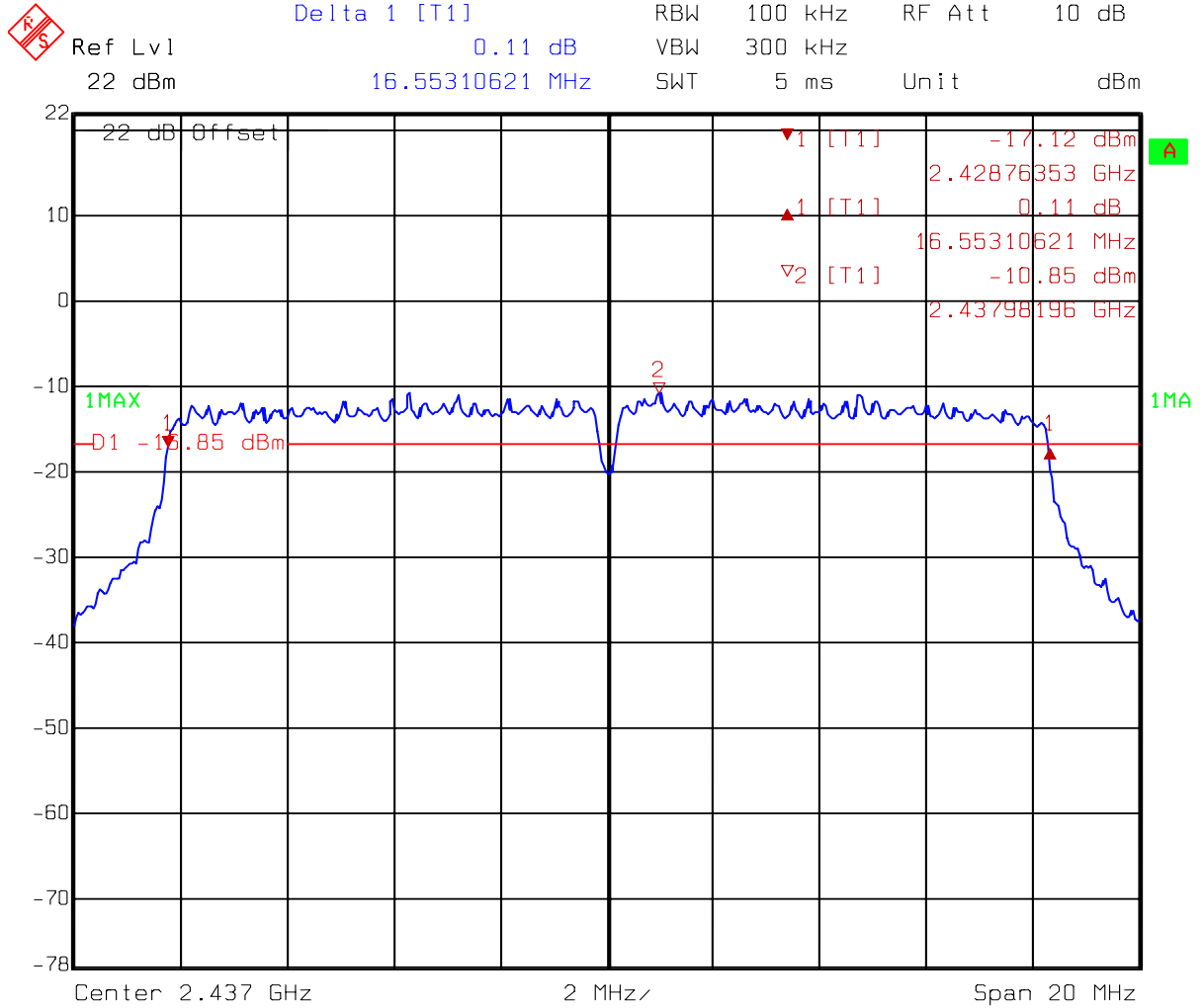

Comment A: 6dB BW at 11g_ch6
EC365

Date: 18.NOV.2005 14:15:20

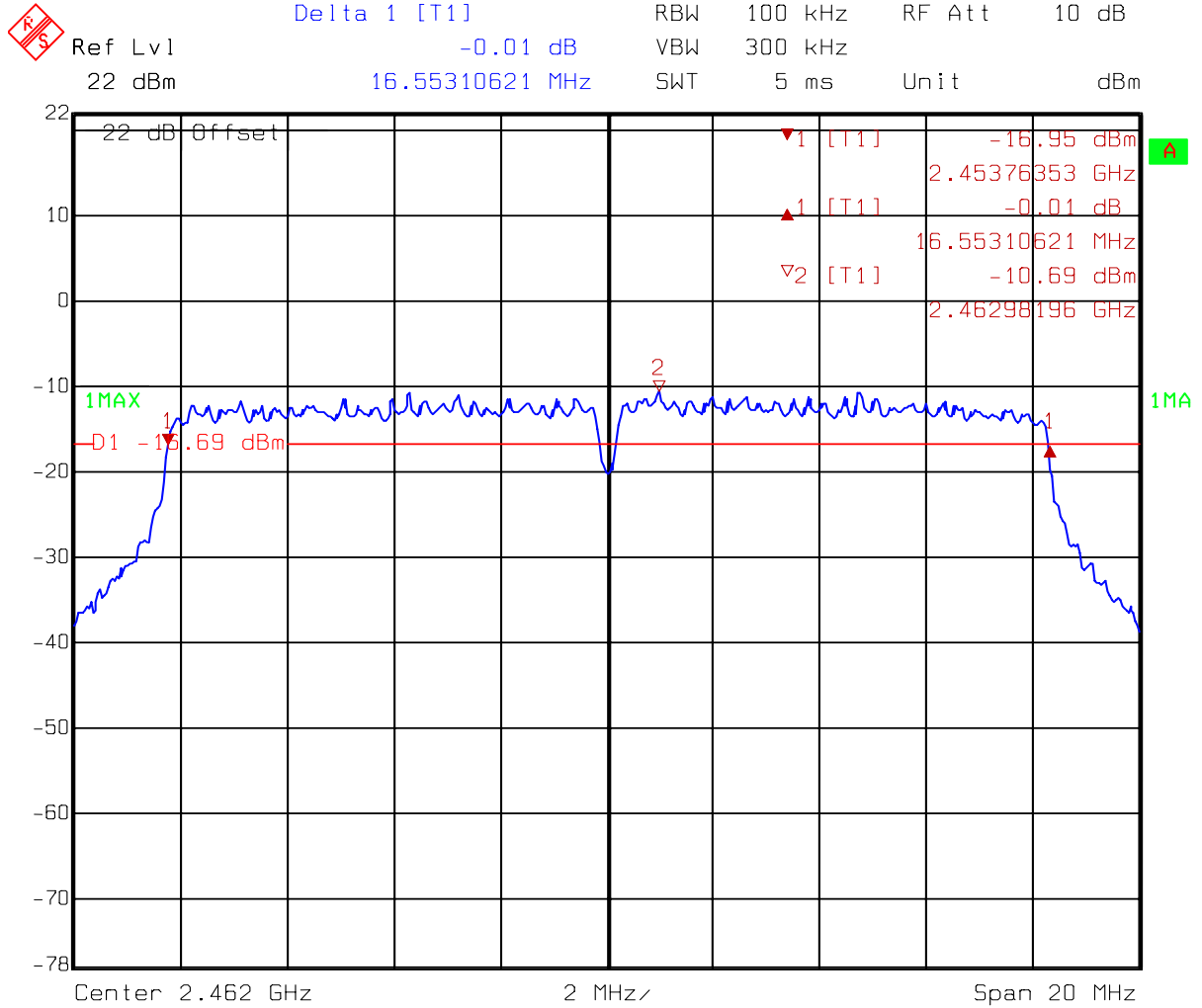

Comment A: 6dB BW at 11g_ch11
EC365
Date: 18.NOV.2005 14:17:26

4. Maximum Output Power test

4.1 Operating environment

Temperature: 24 °C
 Relative Humidity: 56 %
 Atmospheric Pressure: 1011 hPa

4.2 Test setup & procedure

The power output per FCC §15.247(b) was measured on the EUT using a 50 ohm SMA cable connected to peak power meter via power sensor. Power was read directly and cable loss correction (2 dB) was added to the reading to obtain power at the EUT antenna terminals. The test was performed at 3 channels (lowest, middle and highest channel).

4.3 Measured data of Maximum Output Power test results

Test Mode: 802.11b(DSSS Modulation) operating mode

Channel	Freq. (MHz)	C.L. (dB)	Reading (dBm)	Conducted Peak Output Power		Limit (W)
				(dBm)	(mW)	
1 (lowest)	2412	2	10.38	12.38	17.298	1
6 (middle)	2437	2	10.42	12.42	17.458	1
11 (highest)	2462	2	10.45	12.45	17.579	1

Remark:

Conducted Peak Output Power = Reading + C.L.

Test Mode: 802.11g(OFDM Modulation) operating mode

Channel	Freq. (MHz)	C.L. (dB)	Reading (dBm)	Conducted Peak Output Power		Limit (W)
				(dBm)	(mW)	
1 (lowest)	2412	2	9.94	11.94	15.631	1
6 (middle)	2437	2	10.01	12.01	15.885	1
11 (highest)	2462	2	10.05	12.05	16.032	1

Remark:

Conducted Peak Output Power = Reading + C.L.

5. Radiated Emission test

5.1 Operating environment

Temperature: 22 °C
Relative Humidity: 56 %
Atmospheric Pressure: 1012 hPa

5.2 Test setup & procedure

The Diagram below shows the test setup, which is utilized to make these measurements.

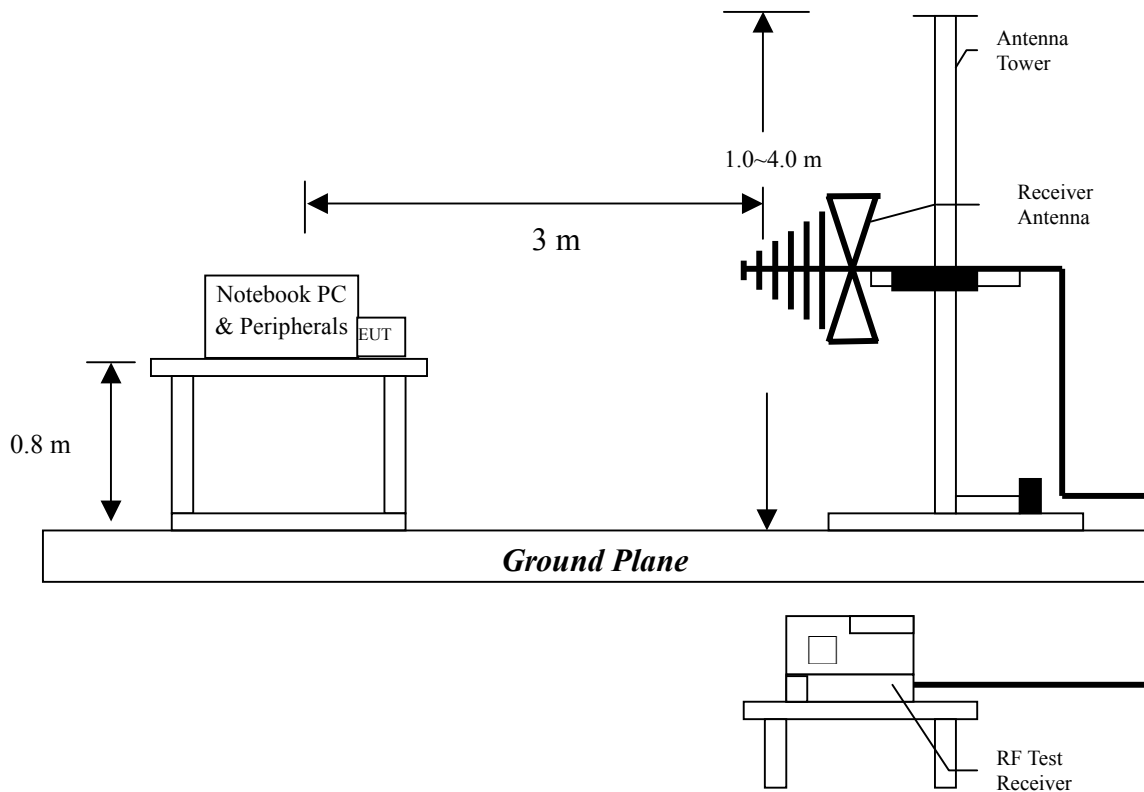

Radiated emissions were investigated cover the frequency range from 30MHz to 1000MHz using a receiver RBW of 120kHz record QP reading, and the frequency over 1GHz using a spectrum analyzer RBW of 1MHz and 10Hz VBW record Average reading. (15.209 paragraph), the Peak reading (1MHz RBW/VBW) recorded also on the report.

The EUT for testing is arranged on a wooden turntable. If some peripherals apply to the EUT, the peripherals will be connected to EUT and the whole system. During the test, all cables were arranged to produce worst-case emissions. The signal is maximized through rotation. The height of antenna and polarization is changing constantly for exploring for maximum signal level. The height of antenna can be up to 4 meters and down to 1 meter.

The measurement for radiated emission will be done at the distance of three meters unless the signal level is too low to measure at that distance. In the case of the reading under noise floor, a pre-amplifier is used and/or the test is conducted at a closer distance. And then all readings are extrapolated back to the equivalent 3meter reading using inverse scaling with distance.

The EUT configuration please refer to the “Spurious set-up photo.pdf”.

5.3 Emission limits

The spurious Emission shall test through the 10th harmonic. In addition, radiated emissions which fall in the restricted bands, as defined in §15.205(a), must also comply with the radiated emission limits specified in §15.209(a).

Frequency (MHz)	Limits (dB μ V/m@3m)
30-88	40
88-216	43.5
216-960	46
Above 960	54

Remark:

1. In the above table, the tighter limit applies at the band edges.
2. Distance refers to the distance in meters between the measuring instrument antenna and the closed point of any part of the device or system

Uncertainty was calculated in accordance with NAMAS NIS 81.

Expanded uncertainty (k=2) of radiated emission measurement is 4.98 dB.

5.4 Radiated spurious emission test data

The radiated spurious emissions at

Frequency (MHz)	Margin
4874.00	-3.11
4924.00	-2.07
4874.00	-4.48
4924.00	-2.8

are less than uncertainty. This is within the stated measurement uncertainty, this may affect compliance determined in other test arrangements.

5.4.1 Measurement results: frequencies equal to or less than 1 GHz

The test was performed on EUT under 802.11b and 802.11g continuously transmitting mode. Channel 1, 6, 11 were verified. The worst case occurred at 802.11b Tx channel 1.

EUT : AWGS1U
Worst Case : 802.11b Tx at channel 1

Antenna Polariz. (V/H)	Freq. (MHz)	Receiver Detector	Corr. Factor (dB/m)	Reading (dBuV)	Corrected Level (dBuV/m)	Limit @ 3 m (dBuV/m)	Margin (dB)	Antenna high (cm)	Turn Table angle (degree)
V	373.380	QP	15.06	17.64	32.70	46.00	-13.30	100	181
V	383.080	QP	16.40	16.59	32.99	46.00	-13.01	105	81
V	423.820	QP	16.47	17.06	33.53	46.00	-12.47	110	122
V	437.400	QP	17.64	15.24	32.88	46.00	-13.12	103	79
V	449.040	QP	17.64	14.59	32.23	46.00	-13.77	142	54
V	718.700	QP	22.29	9.85	32.14	46.00	-13.87	123	69
H	299.600	QP	14.17	18.35	32.52	46.00	-13.49	112	78
H	365.620	QP	15.48	12.14	27.62	46.00	-18.39	145	154
H	449.040	QP	18.12	18.14	36.26	46.00	-9.74	166	199
H	480.080	QP	18.64	18.37	37.01	46.00	-8.99	185	321
H	598.420	QP	20.84	11.55	32.39	46.00	-13.62	156	279
H	718.700	QP	22.44	14.52	36.96	46.00	-9.04	136	48

Remark:

1. Corr. Factor = Antenna Factor + Cable Loss
2. Corrected Level = Reading + Corr. Factor

5.4.2 Measurement results: frequency above 1GHz

EUT : AWGS1U
 Test Condition : 802.11b Tx at channel 1

Frequency (MHz)	Spectrum Analyzer Detector	Antenna Polariz. (H/V)	Preamp. Gain (dB)	Correction Factor (dB/m)	Reading (dBuV)	Corrected Level (dBuV/m)	Limit @ 3 m (dBuV/m)	Margin (dB)	Ant. high (cm)	Turn Table angle (degree)
4824.00	PK	V	36.07	37.77	45.99	47.69	54	-6.31	100	235
7236.00	PK	V	36.18	43.97	-	-	54	-	-	-
4824.00	PK	H	36.07	37.77	43.5	45.2	54	-8.8	102	256
7236.00	PK	H	36.18	43.97	-	-	54	-	-	-

Remark:

1. Correction Factor = Antenna Factor + Cable Loss
2. Corrected Level = Reading + Correction Factor – Preamp. Gain
3. The frequency measured ranges from 1GHz to 25GHz. The data value listed above which is higher than the noise floor, the others please refer to noise floor level.

Noise floor level is:

For PK:

1GHz-3GHz: 20dBuV

3GHz-14GHz: 27dBuV

14GHz-26.5GHz: 39dBuV

For AV:

1GHz-3GHz: 10dBuV

3GHz-14GHz: 16dBuV

14GHz-26.5GHz: 28dBuV

EUT : AWGS1U
 Test Condition : 802.11b Tx at channel 6

Frequency (MHz)	Spectrum Analyzer Detector	Antenna Polariz. (H/V)	Preamp. Gain (dB)	Correction Factor (dB/m)	Reading (dBuV)	Corrected Level (dBuV/m)	Limit @ 3 m (dBuV/m)	Margin (dB)	Ant. high (cm)	Turn Table angle (degree)
4874.00	PK	V	36.07	37.77	49.19	50.89	54	-3.11	100	274
7311.00	PK	V	36.18	43.97	-	-	54	-	-	-
4874.00	PK	H	36.07	37.77	45.78	47.48	54	-6.52	100	285
7311.00	PK	H	36.18	43.97	-	-	54	-	-	-

Remark:

1. Correction Factor = Antenna Factor + Cable Loss
2. Corrected Level = Reading + Correction Factor – Preamp. Gain
3. The frequency measured ranges from 1GHz to 25GHz. The data value listed above which is higher than the noise floor, the others please refer to noise floor level.

Noise floor level is:

For PK:

- 1GHz-3GHz: 20dBuV
- 3GHz-14GHz: 27dBuV
- 14GHz-26.5GHz: 39dBuV

For AV:

- 1GHz-3GHz: 10dBuV
- 3GHz-14GHz: 16dBuV
- 14GHz-26.5GHz: 28dBuV

EUT : AWGS1U
 Test Condition : 802.11b Tx at channel 11

Frequency (MHz)	Spectrum Analyzer Detector	Antenna Polariz. (H/V)	Preamp. Gain (dB)	Correction Factor (dB/m)	Reading (dBuV)	Corrected Level (dBuV/m)	Limit @ 3 m (dBuV/m)	Margin (dB)	Ant. high (cm)	Turn Table angle (degree)
4924.00	PK	V	36.07	37.77	50.23	51.93	54	-2.07	101	268
7386.00	PK	V	36.18	43.97	-	-	54	-	-	-
4924.00	PK	H	36.07	37.77	45.39	47.09	54	-6.91	103	211
7286.00	PK	H	36.18	43.97	-	-	54	-	-	-

Remark:

1. Correction Factor = Antenna Factor + Cable Loss
2. Corrected Level = Reading + Correction Factor – Preamp. Gain
3. The frequency measured ranges from 1GHz to 25GHz. The data value listed above which is higher than the noise floor, the others please refer to noise floor level.

Noise floor level is:

For PK:

- 1GHz-3GHz: 20dBuV
- 3GHz-14GHz: 27dBuV
- 14GHz-26.5GHz: 39dBuV

For AV:

- 1GHz-3GHz: 10dBuV
- 3GHz-14GHz: 16dBuV
- 14GHz-26.5GHz: 28dBuV

EUT : AWGS1U
 Test Condition : 802.11g Tx at channel 1

Frequency (MHz)	Spectrum Analyzer Detector	Antenna Polariz. (H/V)	Preamp. Gain (dB)	Correction Factor (dB/m)	Reading (dBuV)	Corrected Level (dBuV/m)	Limit @ 3 m (dBuV/m)	Margin (dB)	Ant. high (cm)	Turn Table angle (degree)
4824.00	PK	V	36.07	37.77	46.8	48.5	54	-5.5	100	298
7236.00	PK	V	36.18	43.97	-	-	54	-	-	-
4824.00	PK	H	36.07	37.77	40.96	42.66	54	-11.34	102	305
7236.00	PK	H	36.18	43.97	-	-	54	-	-	-

Remark:

1. Correction Factor = Antenna Factor + Cable Loss
2. Corrected Level = Reading + Correction Factor – Preamp. Gain
3. The frequency measured ranges from 1GHz to 25GHz. The data value listed above which is higher than the noise floor, the others please refer to noise floor level.

Noise floor level is:

For PK:

- 1GHz-3GHz: 20dBuV
- 3GHz-14GHz: 27dBuV
- 14GHz-26.5GHz: 39dBuV

For AV:

- 1GHz-3GHz: 10dBuV
- 3GHz-14GHz: 16dBuV
- 14GHz-26.5GHz: 28dBuV

EUT : AWGS1U
Test Condition : 802.11g Tx at channel 6

Frequency (MHz)	Spectrum Analyzer Detector	Antenna Polariz. (H/V)	Preamp. Gain (dB)	Correction Factor (dB/m)	Reading (dBuV)	Corrected Level (dBuV/m)	Limit @ 3 m (dBuV/m)	Margin (dB)	Ant. high (cm)	Turn Table angle (degree)
4874.00	PK	V	36.07	37.77	47.82	49.52	54	-4.48	102	332
7311.00	PK	V	36.18	43.97	-	-	54	-	-	-
4874.00	PK	H	36.07	37.77	44.1	45.8	54	-8.2	100	300
7311.00	PK	H	36.18	43.97	-	-	54	-	-	-

Remark:

1. Correction Factor = Antenna Factor + Cable Loss
2. Corrected Level = Reading + Correction Factor – Preamp. Gain
3. The frequency measured ranges from 1GHz to 25GHz. The data value listed above which is higher than the noise floor, the others please refer to noise floor level.

Noise floor level is:

For PK:

- 1GHz-3GHz: 20dBuV
- 3GHz-14GHz: 27dBuV
- 14GHz-26.5GHz: 39dBuV

For AV:

- 1GHz-3GHz: 10dBuV
- 3GHz-14GHz: 16dBuV
- 14GHz-26.5GHz: 28dBuV

EUT : AWGS1U
 Test Condition : 802.11g Tx at channel 11

Frequency (MHz)	Spectrum Analyzer Detector	Antenna Polariz. (H/V)	Preamp. Gain (dB)	Correction Factor (dB/m)	Reading (dBuV)	Corrected Level (dBuV/m)	Limit @ 3 m (dBuV/m)	Margin (dB)	Ant. high (cm)	Turn Table angle (degree)
4924.00	PK	V	36.07	37.77	49.5	51.2	54	-2.8	101	312
7386.00	PK	V	36.18	43.97	-	-	54	-	-	-
4924.00	PK	H	36.07	37.77	44.87	46.57	54	-7.43	100	346
7286.00	PK	H	36.18	43.97	-	-	54	-	-	-

Remark:

1. Correction Factor = Antenna Factor + Cable Loss
2. Corrected Level = Reading + Correction Factor – Preamp. Gain
3. The frequency measured ranges from 1GHz to 25GHz. The data value listed above which is higher than the noise floor, the others please refer to noise floor level.

Noise floor level is:

For PK:

- 1GHz-3GHz: 20dBuV
- 3GHz-14GHz: 27dBuV
- 14GHz-26.5GHz: 39dBuV

For AV:

- 1GHz-3GHz: 10dBuV
- 3GHz-14GHz: 16dBuV
- 14GHz-26.5GHz: 28dBuV

6. Power Spectrum Density test

6.1 Operating environment

Temperature: 25 °C
 Relative Humidity: 56 %
 Atmospheric Pressure 1015 hPa

6.2 Test setup & procedure

The power spectrum density per FCC §15.247(e) was measured from the antenna port of the EUT using a 50ohm spectrum analyzer with the resolution bandwidth set at 3kHz, the video bandwidth set at 10kHz, a span of 1.5 MHz, and the sweep time set at 500 seconds. Power Density was read directly was added to the reading to obtain power at the EUT antenna terminals. The test was performed at 3 channels (lowest, middle and highest channel). The Power Spectral Density measured result is in the following table.

6.3 Measured data of Power Spectrum Density test results

Test Mode: 802.11b(DSSS Modulation) operating mode

Channel	Frequency (MHz)	Power spectrum density (dBm)	Limit (dBm)
1 (lowest)	2412	-18.70	8
6 (middle)	2437	-14.94	8
11 (highest)	2462	-18.45	8

Test Mode: 802.11g(OFDM Modulation) operating mode

Channel	Frequency (MHz)	Power spectrum density (dBm)	Limit (dBm)
1 (lowest)	2412	-24.65	8
6 (middle)	2437	-24.35	8
11 (highest)	2462	-24.24	8

Please see the plot below.

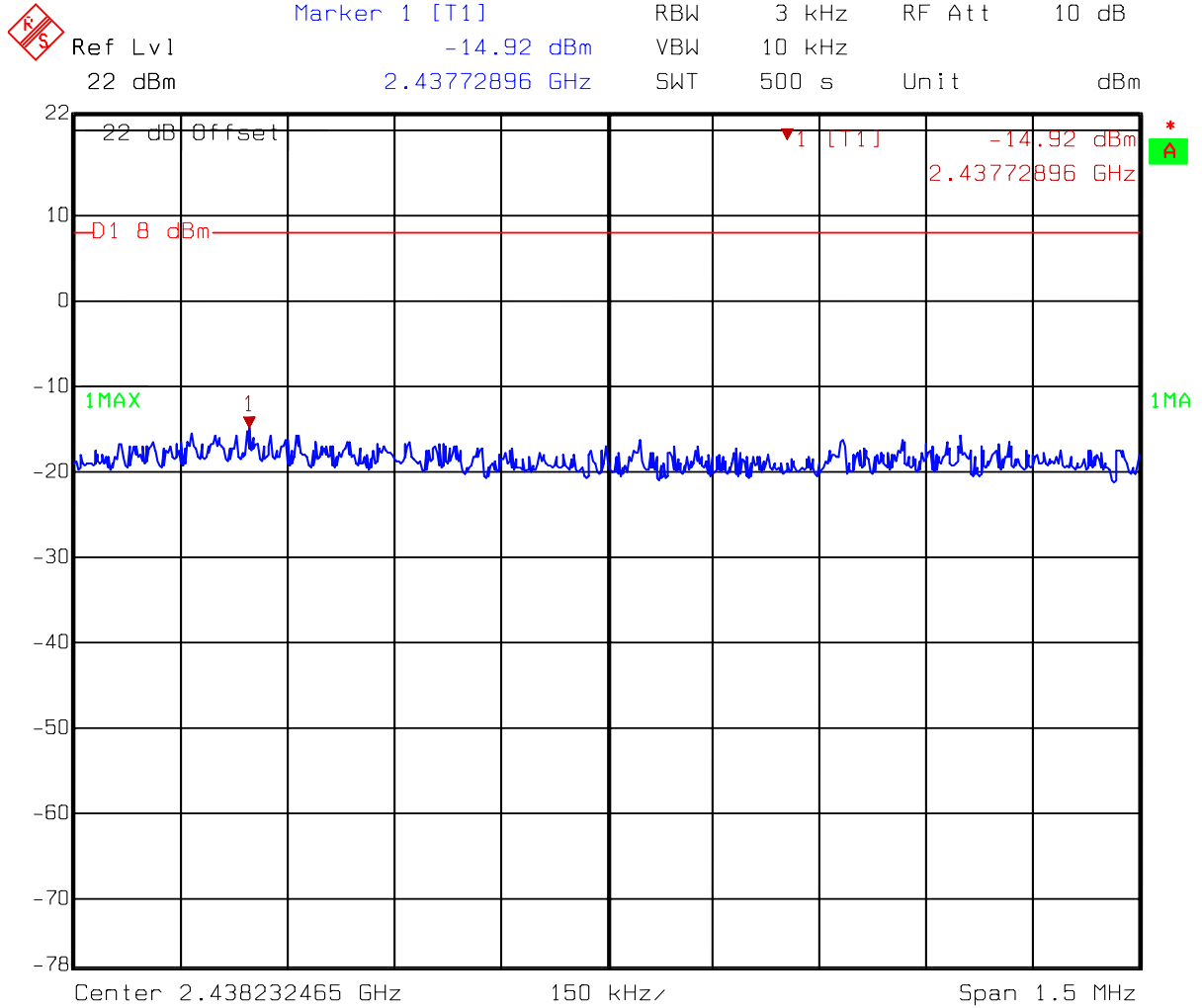

Comment A: Power Density at 11b_ch6
EC365

Date: 18.NOV.2005 14:34:28

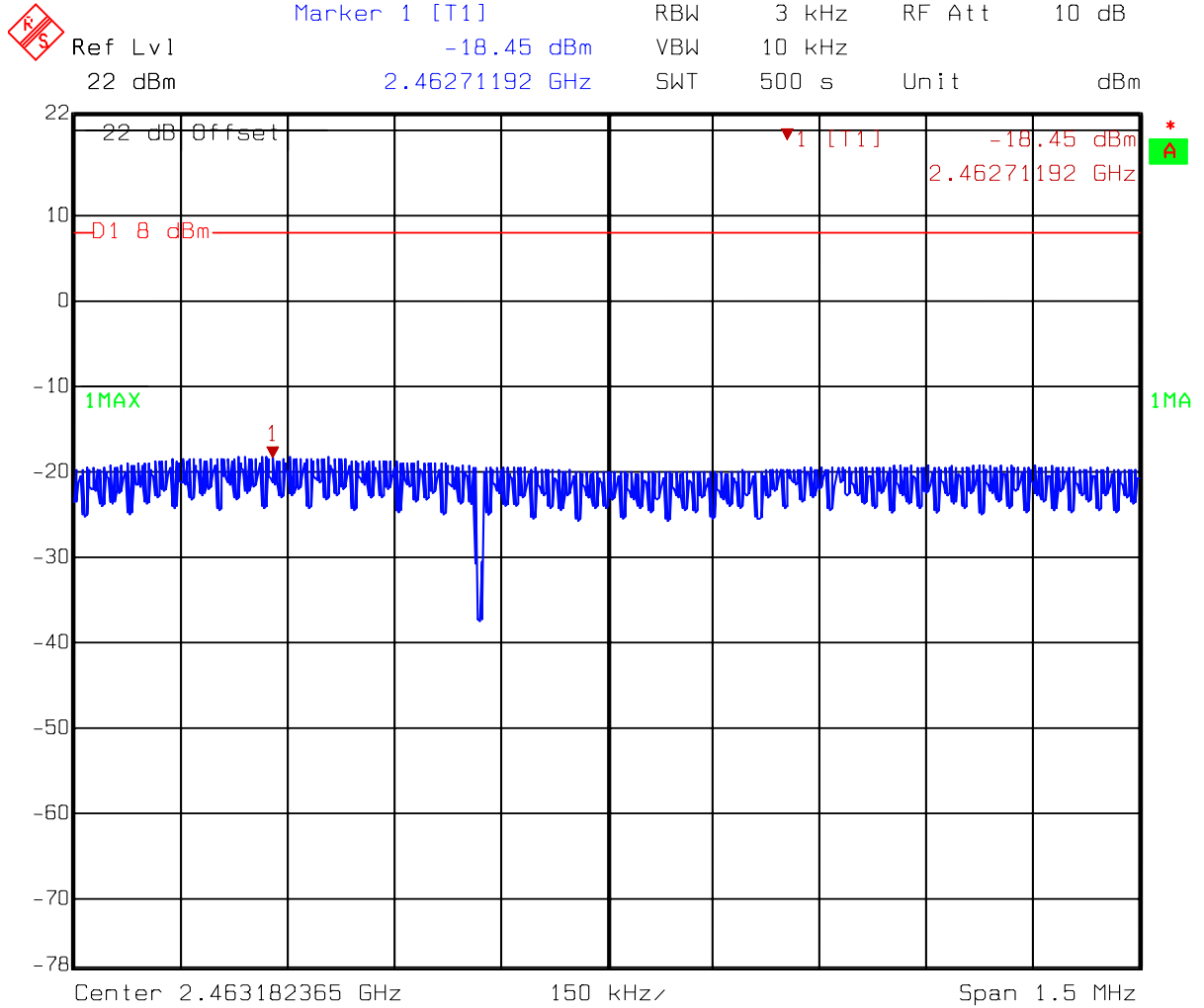

Comment A: Power Density at 11b_ch11
EC365

Date: 18.NOV.2005 14:38:25

Test Mode: 802.11g(OFDM Modulation) operating mode

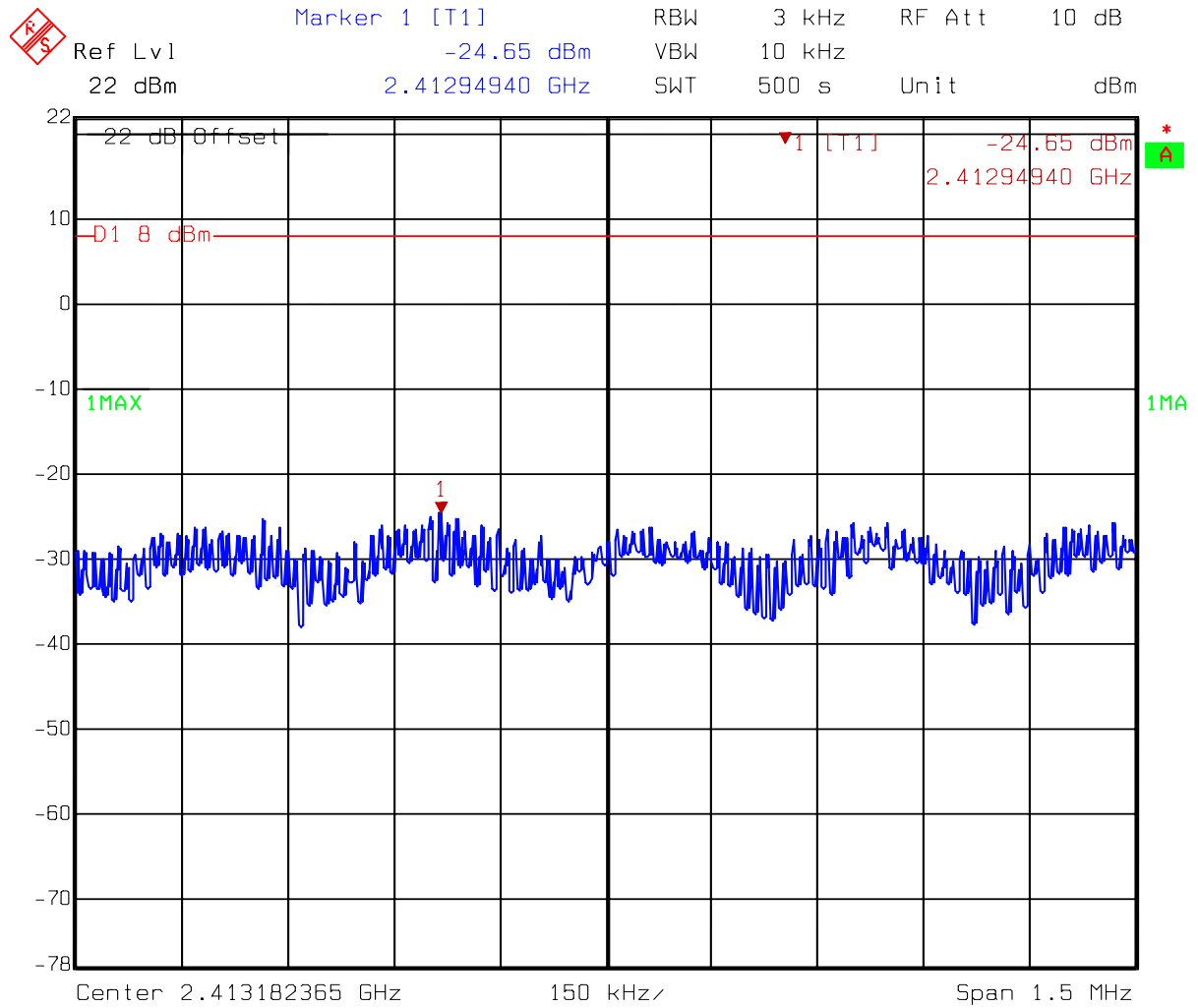

Comment A: Power Density at 11g_ch1
EC365

Date: 18.NOV.2005 14:45:34

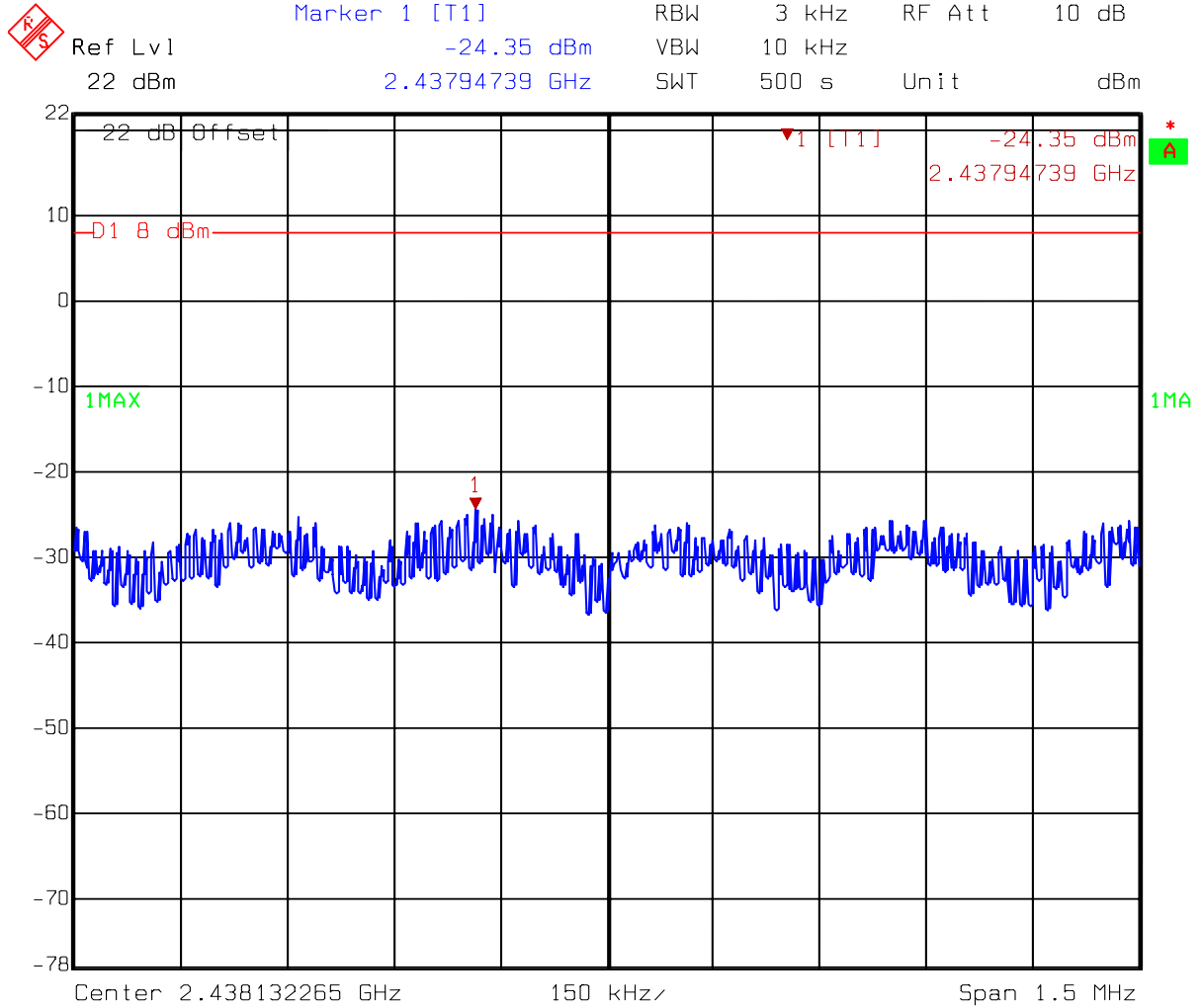

Comment A: Power Density at 11g_ch6
EC365

Date: 18.NOV.2005 14:42:45

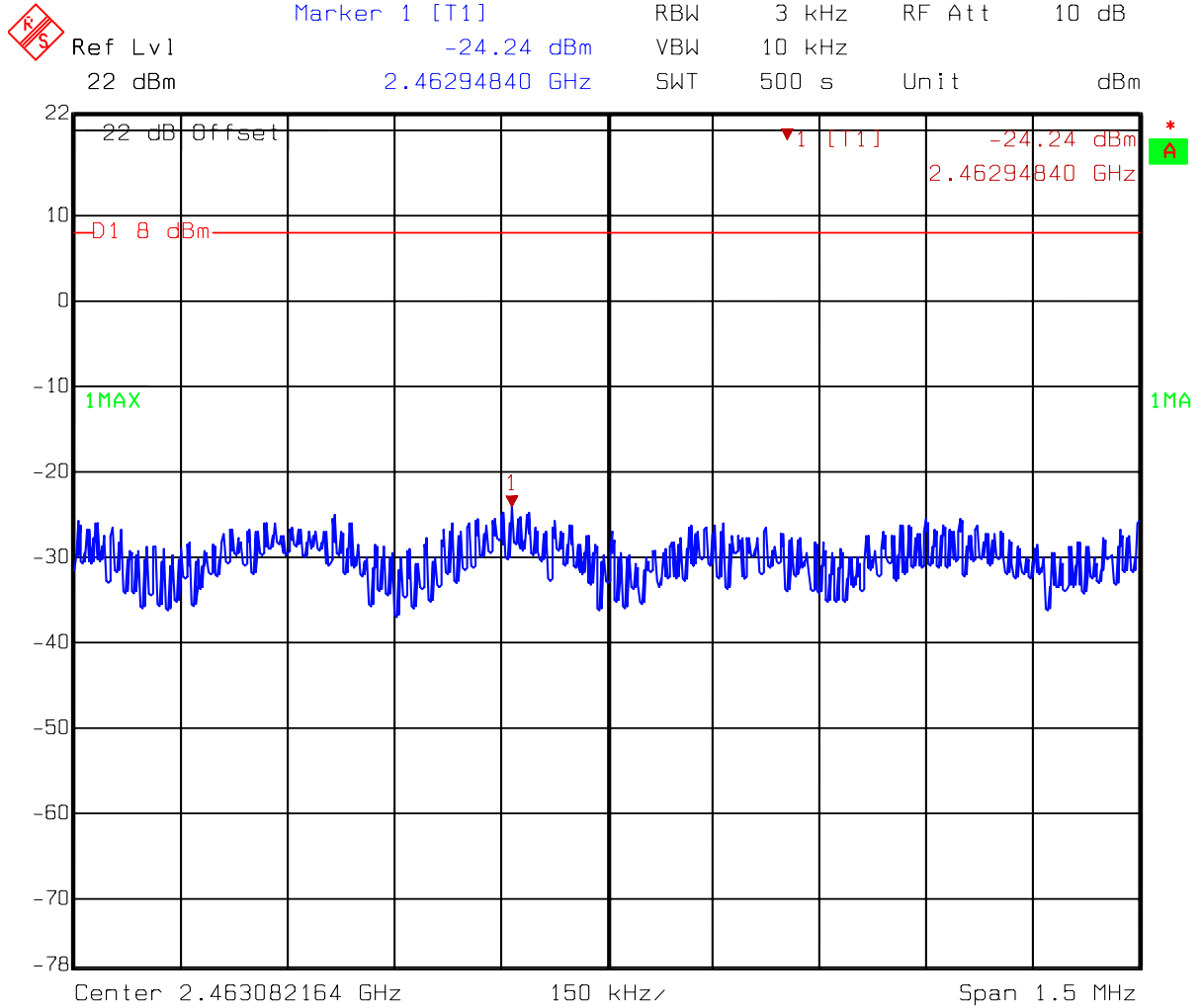

Comment A: Power Density at 11g_ch11
 EC365

Date: 18.NOV.2005 14:40:45

7. Emission on the band edge

In any 100kHz bandwidth outside the frequency band in which the spread spectrum intentional radiator is operating, the radio frequency power that is produced by the intentional radiator shall be at least 20 dB below that in the 100 KHz bandwidth within the band that contains the highest level of the desired power, based on either an RF conducted or a radiated measurement.

7.1 Operating environment

Temperature:	25	°C
Relative Humidity:	50	%
Atmospheric Pressure	1012	hPa

7.2 Test setup & procedure

The output of EUT was connected to spectrum analyzer via a 50ohm cable.

The setting of spectrum analyzer is:

Peak:	RBW = 100kHz ;	VBW = 100kHz
Average:	RBW = 1MHz ;	VBW = 10Hz

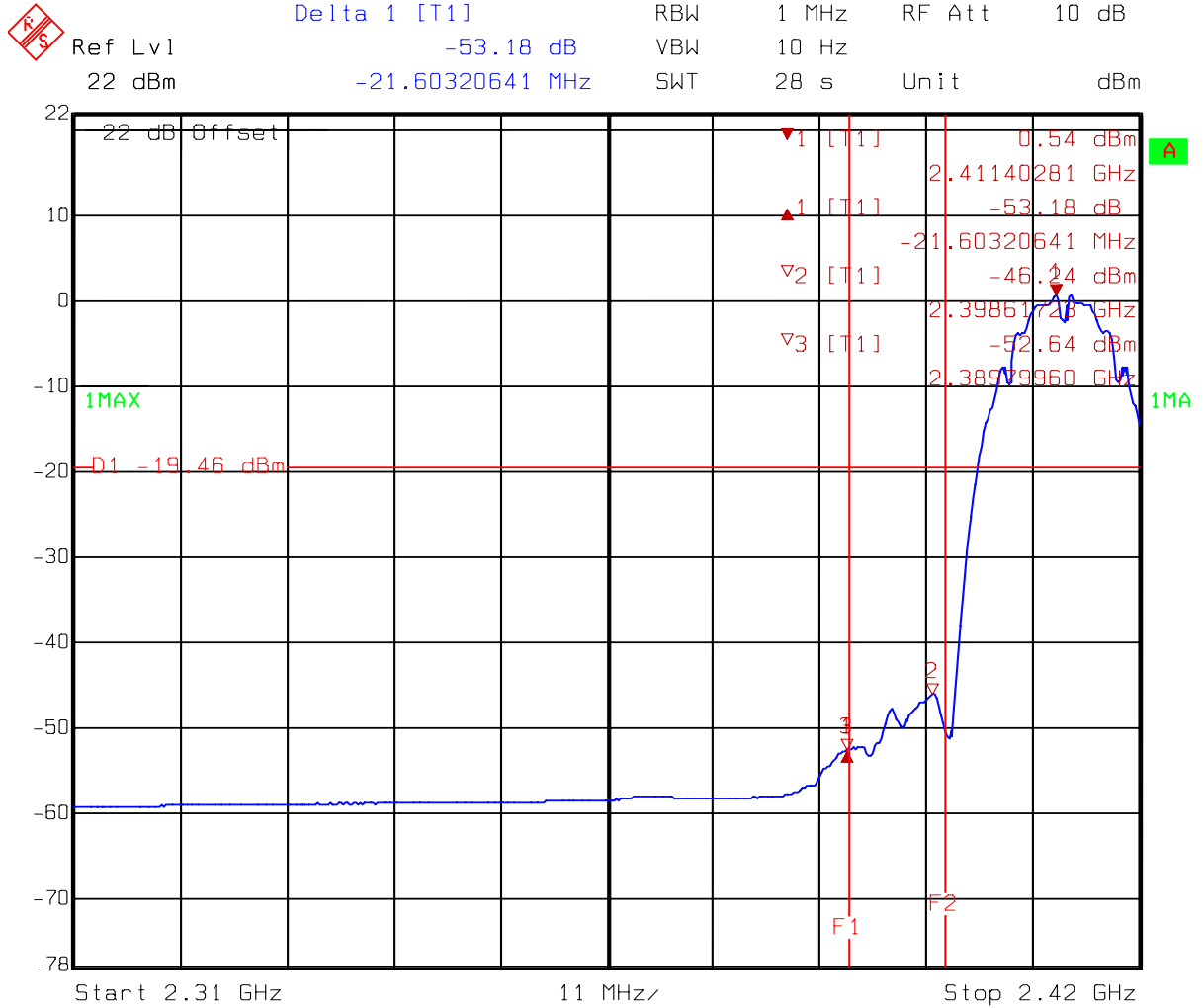

Comment A: Band-Edge at 11b_ch1
 F1=2390MHz, F2=2400MHz EC365
 Date: 18.NOV.2005 15:46:15

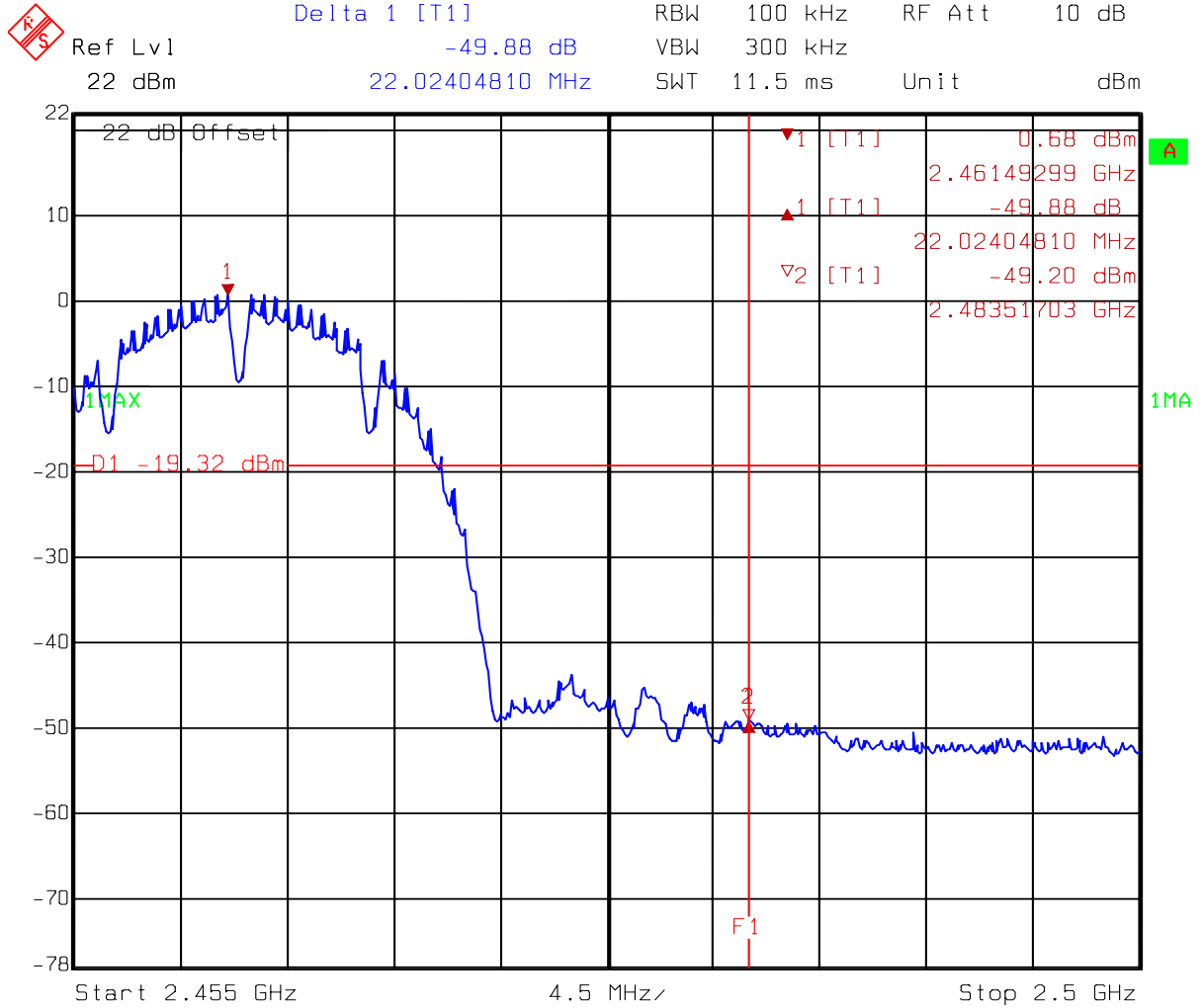

Comment A: Band-Edge at 11b_ch11
F1=2483.5MHz EC365
Date: 18.NOV.2005 15:11:44

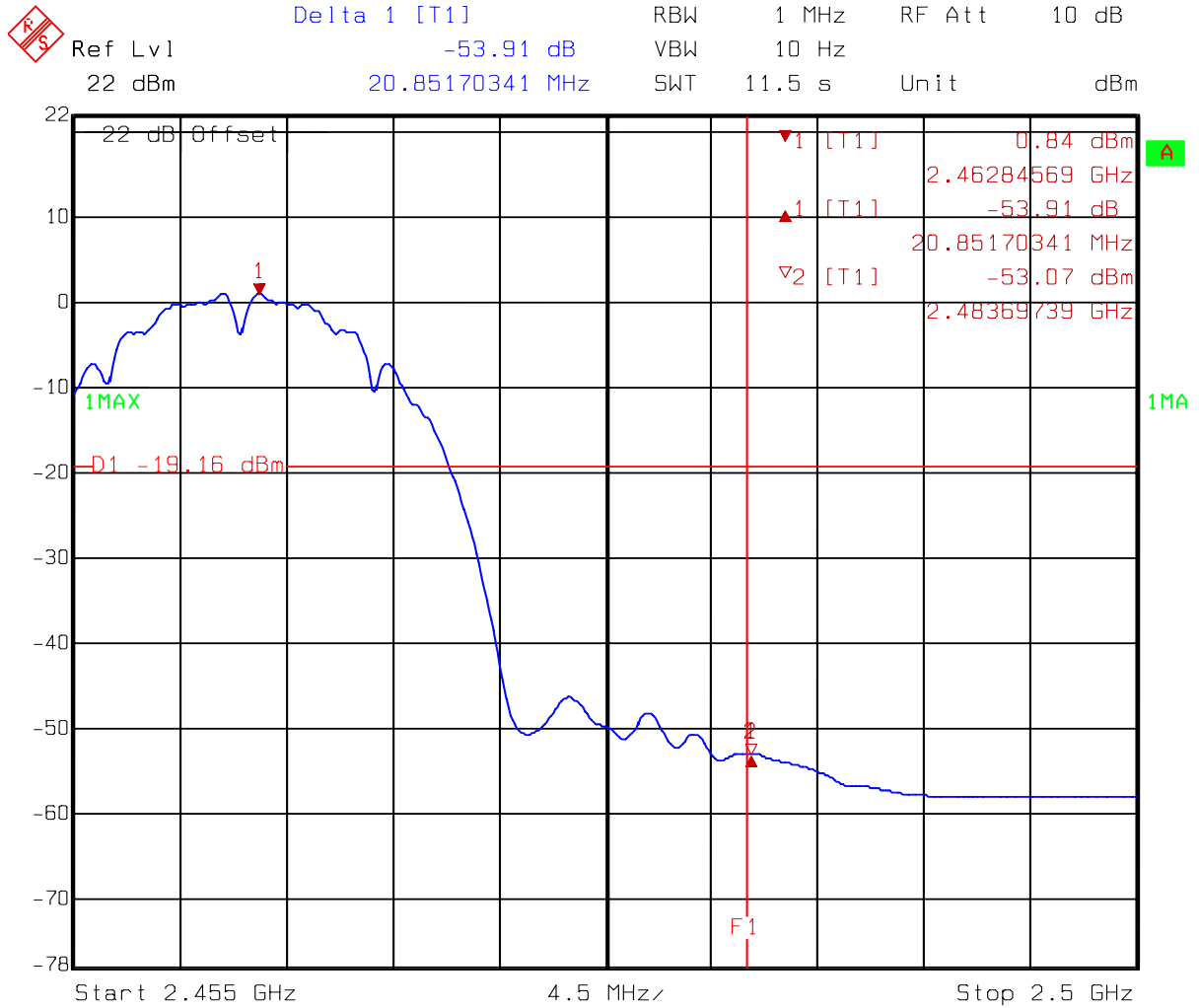

Comment A: Band-Edge at 11b_ch11
 F1=2483.5MHz EC365
 Date: 18.NOV.2005 15:30:19

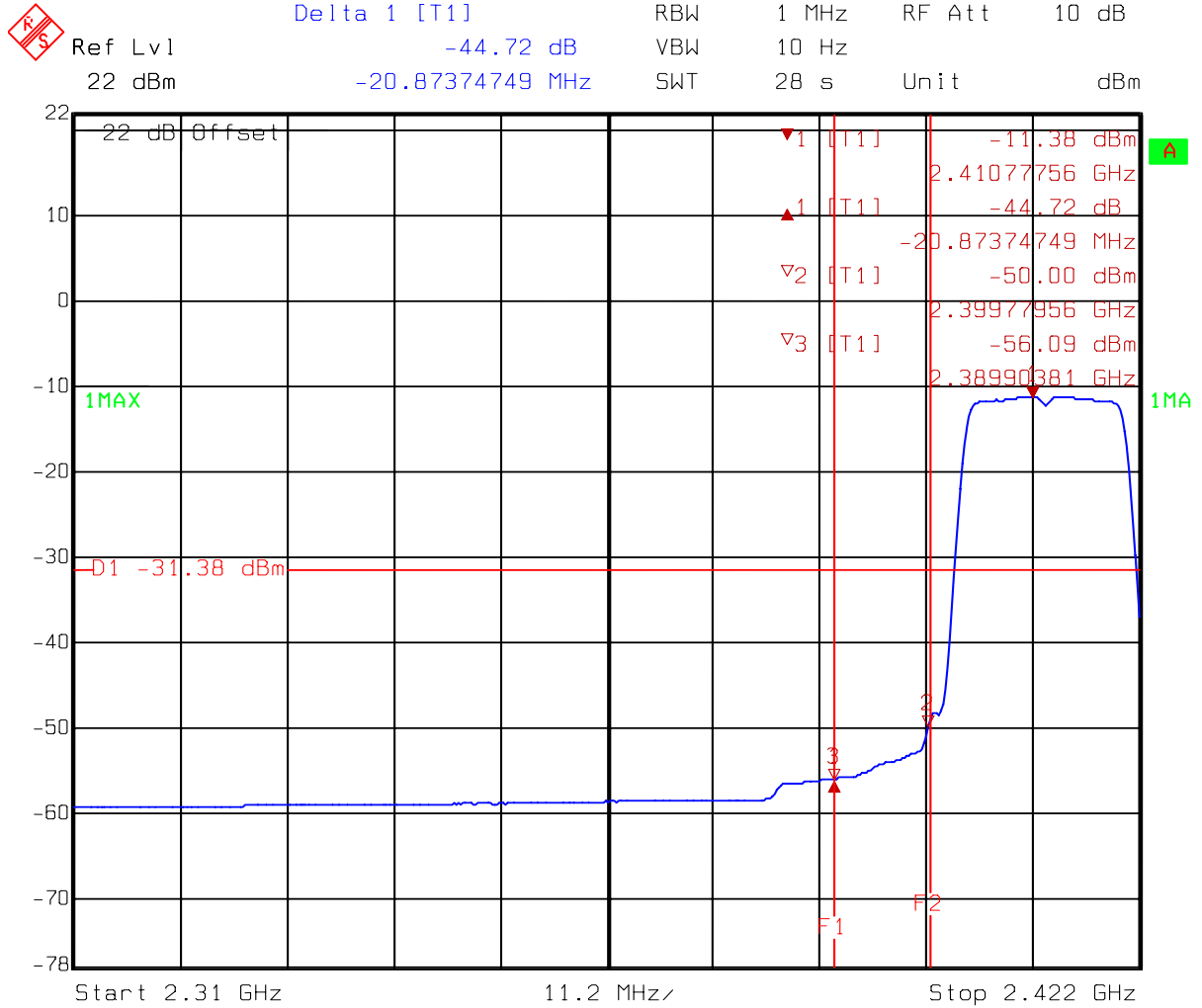

Comment A: Band-Edge at 11g_ch1
 F1=2390MHz, F2=2400MHz EC365
 Date: 18.NOV.2005 14:57:57

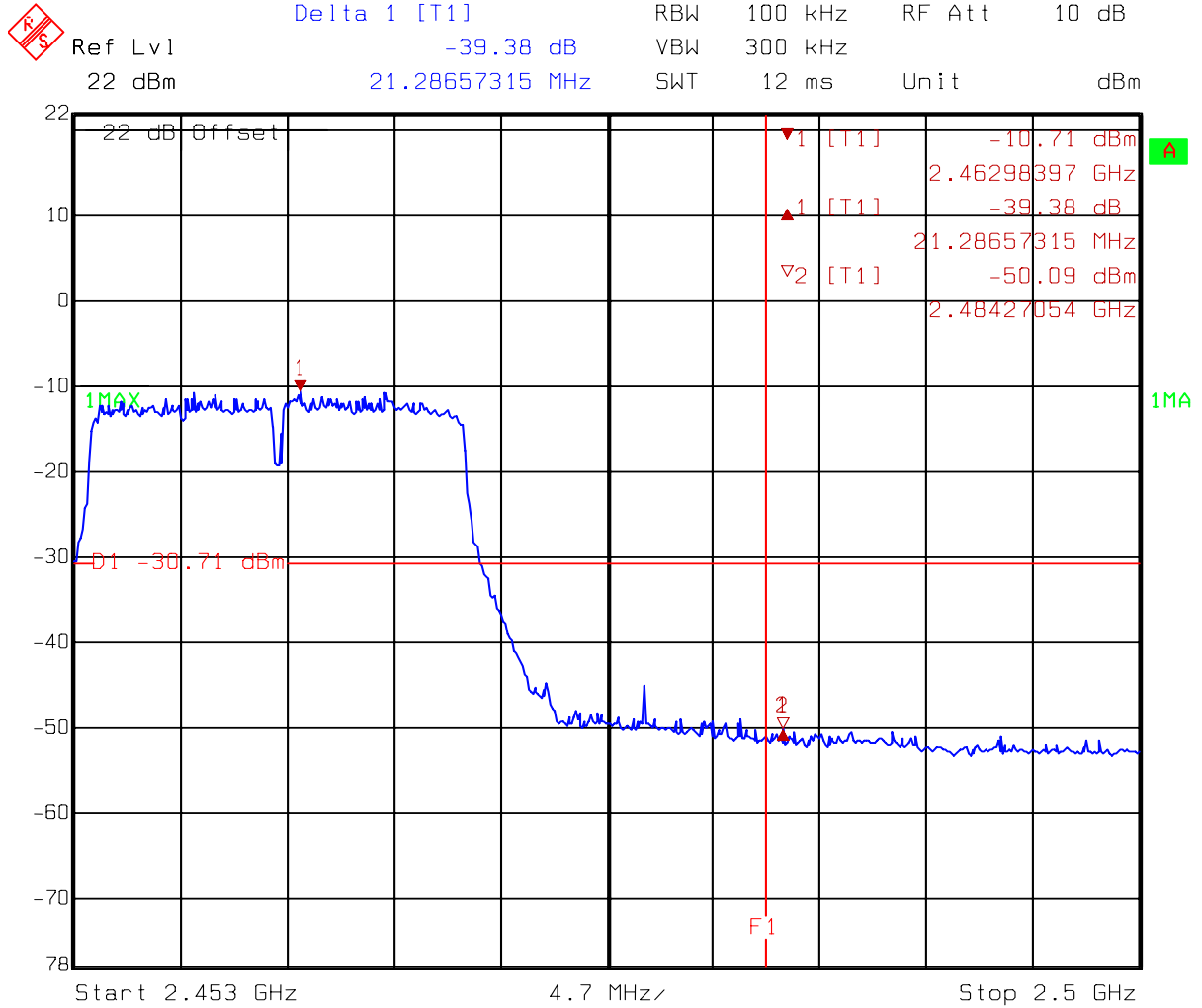

Comment A: Band-Edge at 11g_ch11
 F1=2483.5MHz EC365
 Date: 18.NOV.2005 15:01:48

7.3.2 Radiated Method

Test Mode: 802.11b(DSSS Modulation) operating mode

Channel	Detector	Radiated Method	Conducted Method	The Max. Field Strength in Restrict Band (dBuV/m)	Limit @ 3 m (dBuV/m)	Margin (dB)
		Max. Field Strength of Fundamental @3m (dBuV/m)	Between Carrier Max. Power and Local Max. Emission in Restrict Band (dBc)			
		A	B			
1 (lowest)	PK	110.62	49.33	61.29	74	-12.71
	AV	103.21	53.18	50.03	54	-3.97
11 (highest)	PK	105.98	49.88	56.1	74	-17.9
	AV	97.49	53.91	43.58	54	-10.42

Remark: 1. $C = A - B$

2. $105.14E = C - D$

Test Mode: 802.11g(OFDM Modulation) operating mode

Channel	Detector	Radiated Method	Conducted Method	The Max. Field Strength in Restrict Band (dBuV/m)	Limit @ 3 m (dBuV/m)	Margin (dB)
		Max. Field Strength of Fundamental @3m (dBuV/m)	Between Carrier Max. Power and Local Max. Emission in Restrict Band (dBc)			
		A	B			
1 (lowest)	PK	107.4	38.8	68.6	74	-5.4
	AV	95.54	44.72	50.82	54	-3.18
11 (highest)	PK	105.14	39.38	65.76	74	-8.24
	AV	93.08	44.71	48.37	54	-5.63

Remark: 1. $C = A - B$

2. $105.14E = C - D$

8. Power Line Conducted Emission test §FCC 15.207

8.1 Operating environment

Temperature:	25	°C
Relative Humidity:	59	%
Atmospheric Pressure	1022	hPa

8.2 Test setup & procedure

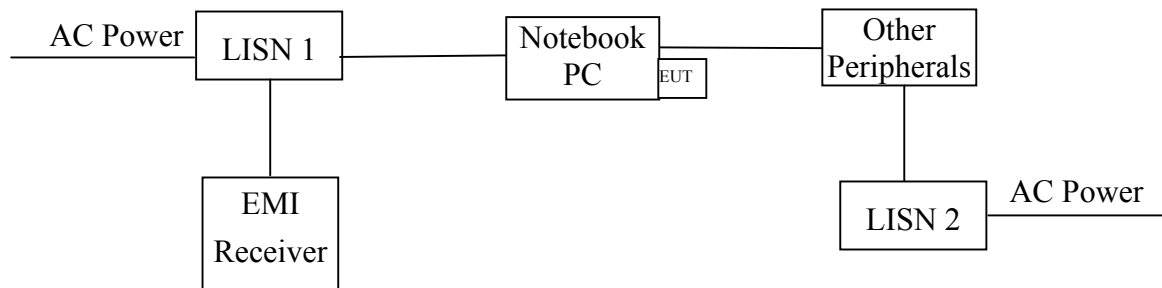

The EUT are connected to the main power through a line impedance stabilization network (LISN). This provides a 50 ohm/50uH coupling impedance for the measuring equipment. The peripheral devices are also connected to the main power through a LISN that provides a 50ohm/50uH coupling impedance with 50ohm termination.

Both sides (Line and Neutral) of AC line are checked for maximum conducted interference. In order to find the maximum emission, the relative positions of equipment and all of the interface cables must be changed according to ANSI C63.4/2003 on conducted measurement. The bandwidth of the field strength meter (R & S Test Receiver ESCS 30) is set at 9kHz.

The EUT configuration please refer to the “Conducted set-up photo.pdf”.

8.3 Emission limit

Freq. (MHz)	Conducted Limit (dBuV)	
	Q.P.	Ave.
0.15~0.50	66 – 56*	56 – 46*
0.50~5.00	56	46
5.00~30.0	60	50

*Decreases with the logarithm of the frequency.

8.4 Uncertainty of Conducted Emission

Expanded uncertainty (k=2) of conducted emission measurement is 2.6 dB.

8.5 Power Line Conducted Emission test data

Phase : Line
 EUT : AWGS1U
 Test Condition : Normal operating mode

Frequency (MHz)	Corr. Factor (dB)	Level Qp (dBuV)	Limit Qp (dBuV)	Level AV (dBuV)	Limit Av (dBuV)	Margin (dB)	
						Qp	Av
0.232	0.10	44.89	62.36	29.04	52.36	-17.47	-23.32
0.305	0.10	39.19	60.11	31.62	50.11	-20.92	-18.49
0.545	0.10	34.26	56.00	17.58	46.00	-21.74	-28.42
0.709	0.10	31.13	56.00	19.28	46.00	-24.87	-26.72
0.912	0.10	28.13	56.00	19.56	46.00	-27.87	-26.44
1.817	0.10	24.28	56.00	15.87	46.00	-31.72	-30.13

Remark:

1. Correction Factor (dB) = LISN Factor (dB) + Cable Loss (dB)
2. Margin (dB) = Level (dBuV) – Limit (dBuV)

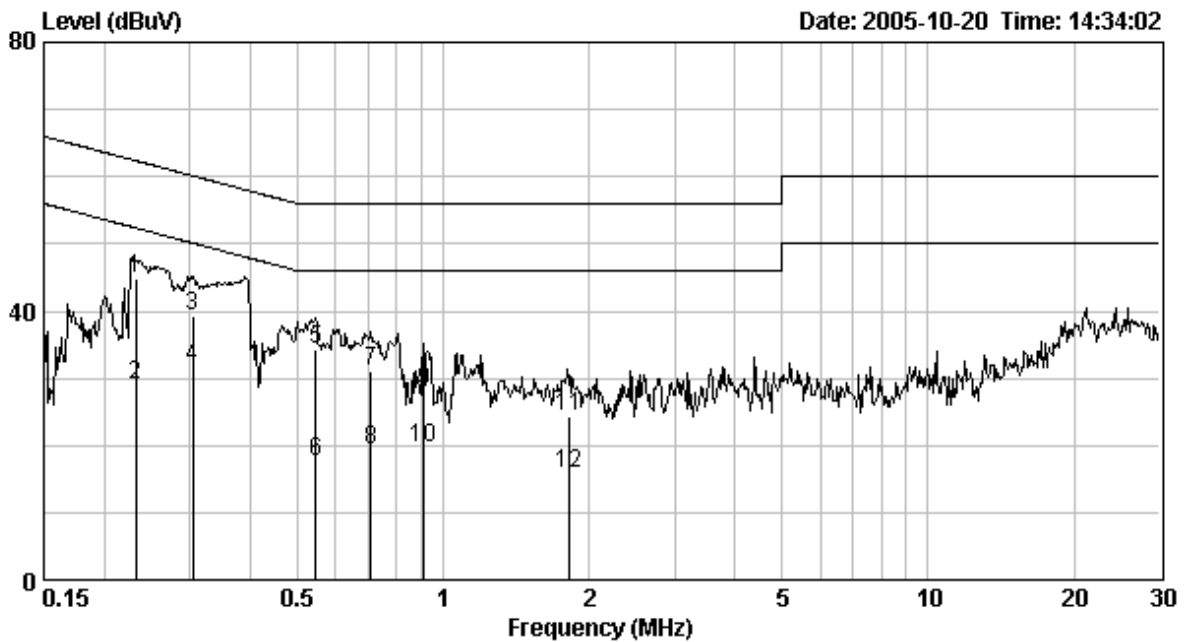

Phase : Neutral
 EUT : AWGS1U
 Test Condition : Normal operating mode

Frequency (MHz)	Corr. Factor (dB)	Level Qp (dBuV)	Limit Qp (dBuV)	Level AV (dBuV)	Limit Av (dBuV)	Margin (dB)	
						Qp	Av
0.201	0.10	35.21	63.55	36.05	53.55	-28.34	-17.50
0.227	0.10	41.69	62.56	23.47	52.56	-20.87	-29.09
0.506	0.10	32.08	56.00	28.35	46.00	-23.92	-17.65
1.107	0.10	28.84	56.00	21.37	46.00	-27.16	-24.63
3.173	0.16	30.04	56.00	22.82	46.00	-25.96	-23.18
20.971	0.62	35.71	60.00	30.29	50.00	-24.29	-19.71

Remark:

1. Correction Factor (dB)= LISN Factor (dB) + Cable Loss (dB)
2. Margin (dB) = Level (dBuV) – Limit (dBuV)

