

## Dual-Band Narrow Beam Width 3x3 MIMO Sector Antenna J9169A



Specifications	J9169A
Frequency (MHz):	2400 - 2500 & 5150 - 5875
Gain dBi ( w/34" cable):	8.0 dBi @ 2450 MHz 10.7 dBi @ 5500 MHz
Maximum VSWR:	2.0 : 1
3 dB Beamwidth – Azimuth:	75° @ 2.45 GHz / 55° @ 5.5 GHz
3 dB Beamwidth – Elevation:	70° @ 2.45 GHz / 60° @ 5.5 GHz
Polarization:	Linear, 2 Vertical, 1 Horizontal
Maximum Input Power:	1 Watt
Cable Length in.(mm):	34" (860) Plenum rated
Mechanical Size in. (mm):	10.2"x 10.2"x 1.3" (259.1 x 259.1 x 33.5)
Weight:	1.8 kg
Antenna Connection:	Reverse SMA (3x)
Radome:	Polycarbonate
Mount Style:	Articulating for Mast / Wall

### HP Warranty Information

See the warranty notice included with this product. A copy of the specific warranty terms applicable to your ProCurve products and replacement parts can be obtained from your HP Sales and Service Office or authorized dealer.

### Support

Hewlett-Packard offers support 24 hours a day, seven days a week through the use of a number of automated electronic services. You can get up-to-date support information from the ProCurve Web site: [www.procurve.com](http://www.procurve.com).

Additionally, your HP-authorized network reseller can provide you with assistance, both with services that they offer and with services offered by HP ProCurve.

### Description

The ProCurve J9169A is a dual-band, narrow beam width directional sector antenna for use in 802.11n MIMO applications. Enclosed in a compact, low-profile radome, the antenna is mounted to a rugged articulating mount. The mount can be affixed to a mast or anchored directly to a vertical surface. Each of the three MIMO antenna elements are connected to the WLAN Access Point via low loss, plenum-rated, coax pigtailed. The radiation patterns are uniform and symmetrical, providing high-level signal density into defined coverage zones. This antenna will greatly enhance the performance of 802.11n systems. The dual-band frequency coverage means that a single type of antenna can be deployed with any MIMO radio in the 2.4-2.5 GHz and 5.1-5.9 GHz bands.

### Safety

**Important Notice: Please read all instructions carefully before attempting to install and use this product.**

The ProCurve J9169A and all associated equipment should be installed in accordance with applicable local and national electric code guidelines to ensure safe operation.

Before connecting your external antenna to a ProCurve Wireless Access Point, please read the instructions in your access point manuals. Be sure that the access point's power levels are set to meet the regulatory requirements in your area. For antenna RF power setting limits by country/region, visit [www.procurve.com/manuals](http://www.procurve.com/manuals).

© Copyright 2008, Hewlett-Packard Company LP

The information contained herein is subject to change without notice.

Printed in USA  
October 2008

Part Number: 5992-5001



## Antenna Location

For best results, mount the J9169A facing towards the center of the coverage area. A line-of-sight path between the antenna and active floor works best. Avoid mounting next to a column or vertical support that could create a shadow zone and reduce coverage to only one portion of the room.

## Installation

In order to ensure optimized field coverage (dependant on final antenna orientation), please note the color coded port identification :

Blue= Vertically Polarized  
Red= Vertically Polarized  
Green= Horizontally Polarized

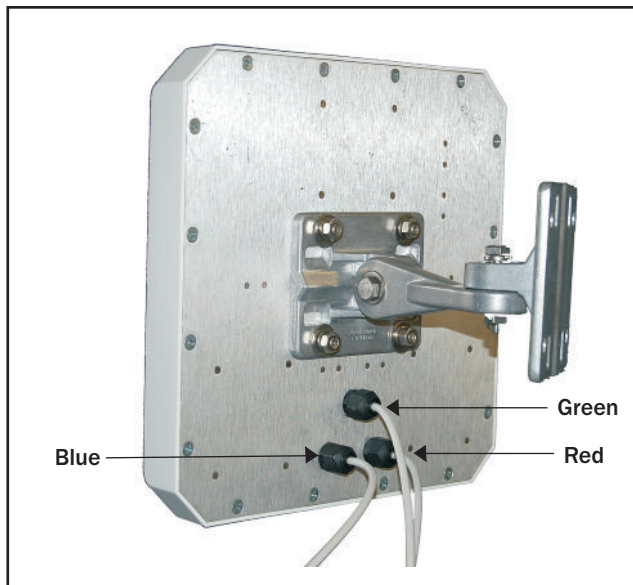

The J9169A is shipped with a heavy duty articulating mount\* that allows mounting to a mast, or optionally, to a vertical surface utilizing wall anchors/molys.

\* See mounting bracket kit (HP 5070-6360) for instructions.

## Lightning Arrester (Optional)

In external applications, it is recommended that you also install three lightning arresters (HP J8996A or equivalent), one for each port of the antenna. Lightning arresters are not included with the antenna and must be purchased separately.

For best results, install the lightning arrester in close proximity to a low-resistance ground at a point where the coaxial cable enters the building (see Photo 1). In most cases, one 8-foot rod driven into moist soil, or multiple rods bonded together, will provide adequate grounding (see National Electrical Code guidelines).

## Lightning Arrester (continued)

To connect the Lightning Arrester to ground, use a very short and direct run of #10 solid copper wire (or equivalent).

For exterior installations, use weatherproof coax connectors with a suitable mastic or rubberized tape to prevent water incursion (see Photo 1).

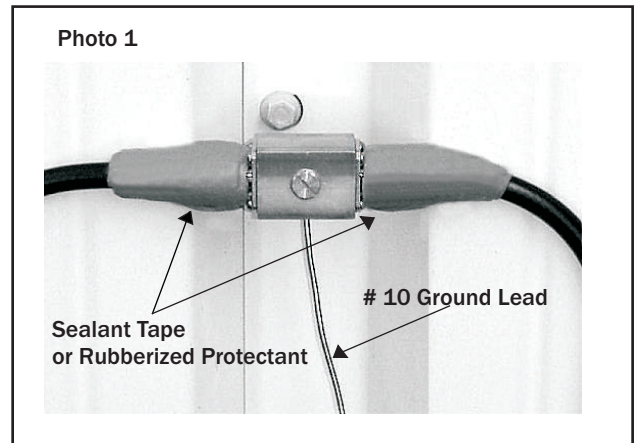

Be sure to install the lightning arrester in an accessible location that permits periodic inspection and replacement (as needed).

Provide drip loops in cables to prevent water from entering the building (see Photo 2).

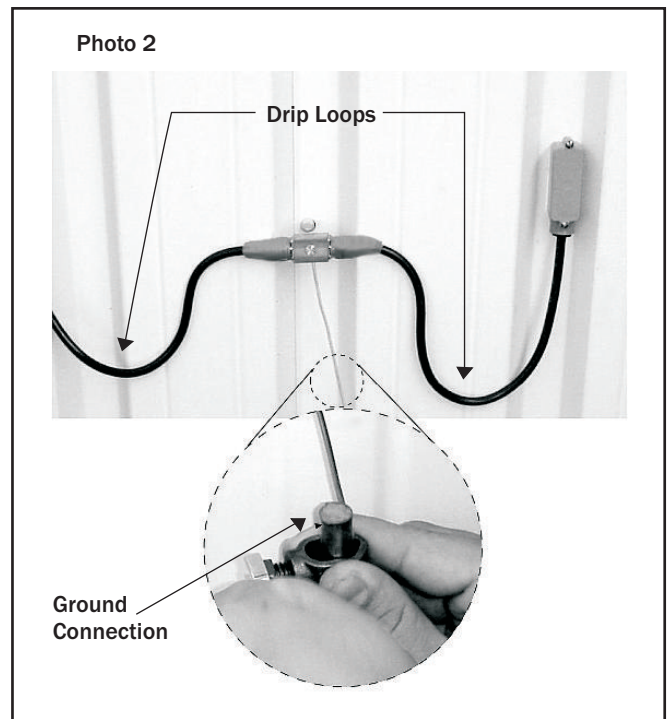

# J9169A Narrow Sector Radiation Plots (2.45 GHz)

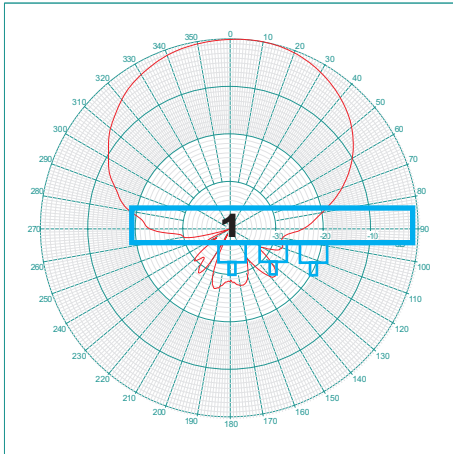

Port 1 E Plane 2.45 GHz

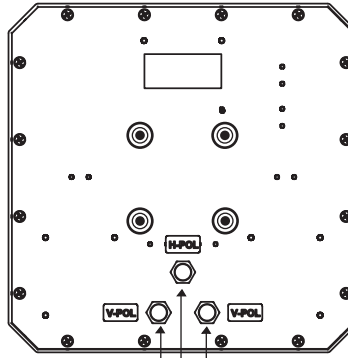

Port 1  
Port 2  
Port 3

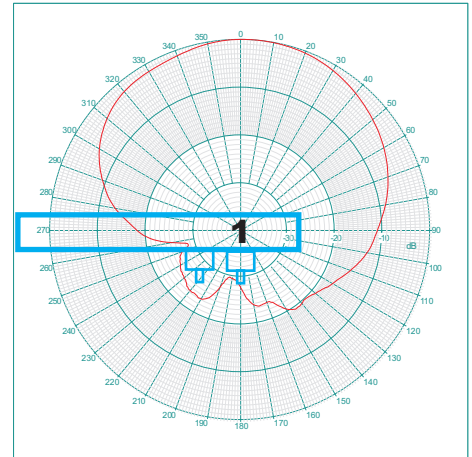

Port 1 H Plane 2.45 GHz

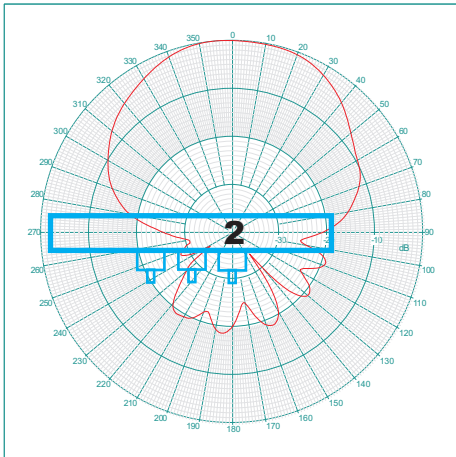

Port 2 E Plane 2.45 GHz

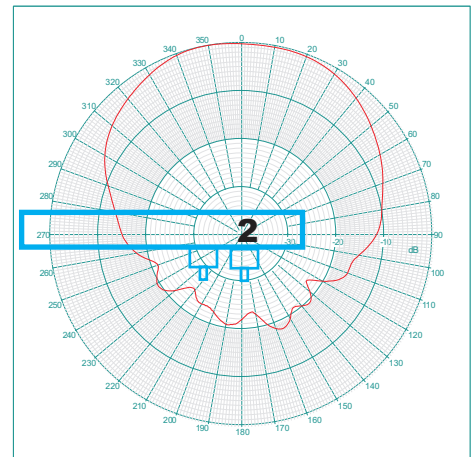

Port 2 H Plane 2.45 GHz

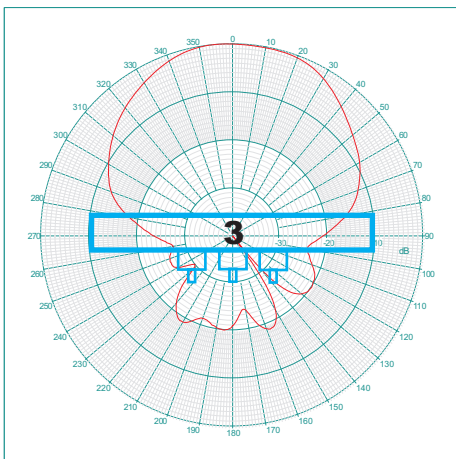

Port 3 E Plane 2.45 GHz

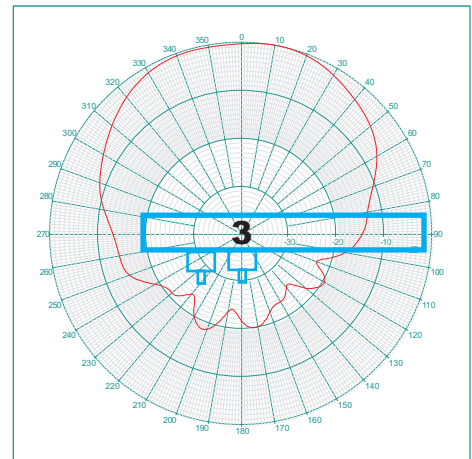

Port 3 H Plane 2.45 GHz



# J9169A Narrow Sector Radiation Plots (5.47 GHz)

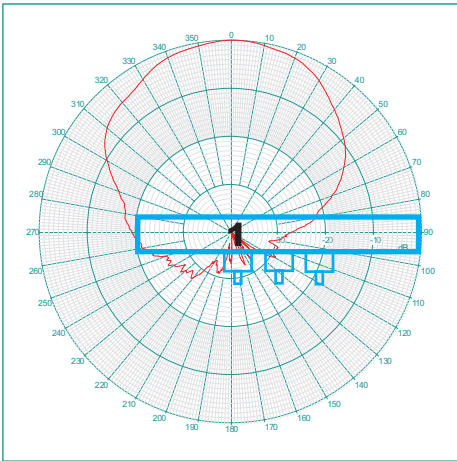

Port 1 E Plane 5.47 GHz

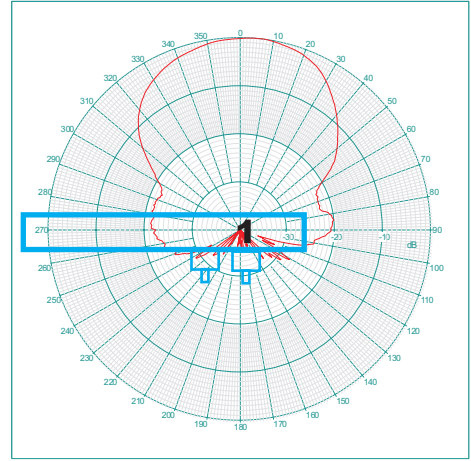

Port 1 H Plane 5.47 GHz

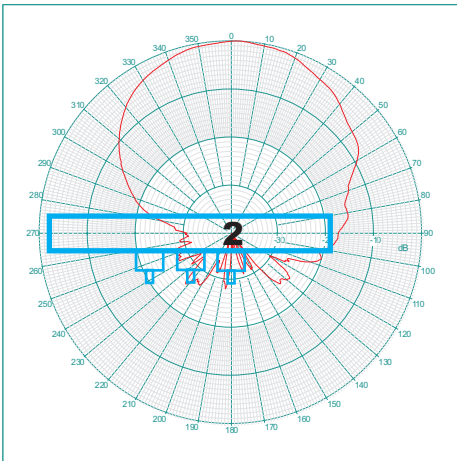

Port 2 E Plane 5.47 GHz

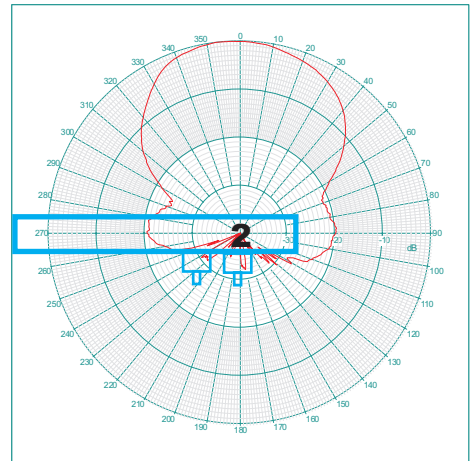

Port 2 H Plane 5.47 GHz

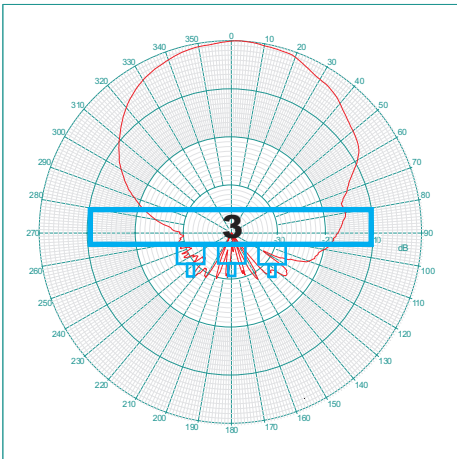

Port 3 E Plane 5.47 GHz

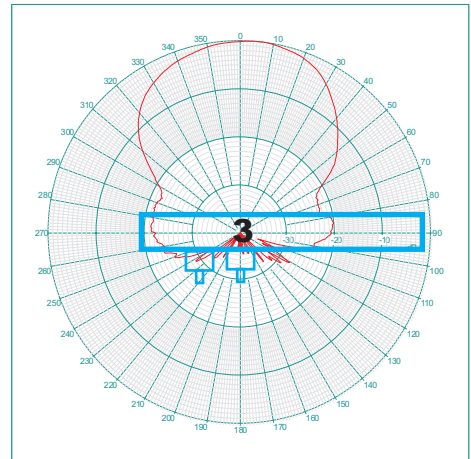

Port 3 H Plane 5.47 GHz