

# HP

## E-MSM466-R Access Point Install Guide

### Abstract

This document describes how to install and initially configure the E-MSM466-R ruggedized Access Point. Professional wireless and electrical equipment experience is required.

DRAFT



HP Part Number: 5998-1426  
Published: July 2011  
Edition: Draft



© Copyright 2011 Hewlett-Packard Development Company, L.P.

The information contained herein is subject to change without notice. The only warranties for HP products and services are set forth in the express warranty statements accompanying such products and services. Nothing herein should be construed as constituting an additional warranty. HP shall not be liable for technical or editorial errors or omissions contained herein.

#### Acknowledgments

Microsoft®, Windows®, Windows® XP, and Windows NT® are U.S. registered trademarks of Microsoft Corporation.

Adobe® and Acrobat® are trademarks of Adobe Systems Incorporated.

#### Warranty

WARRANTY STATEMENT: To obtain a copy of the warranty for this product, see the warranty information website:

[www.hp.com/go/storagewarranty](http://www.hp.com/go/storagewarranty)

#### Revision History

---

Revision #

date

description of revision

---

DRAFT

# Contents

<b>1</b>	<b>Preparing for Installation</b>	<b>5</b>
	Package Contents	5
	Identifying E-MSM466-R components	5
	Protection Equipment Needed	5
	Ports	6
	Radios and antennas	6
	Reset button	6
	Important information to read before installing	6
	Powering the E-MSM466-R	7
	About controlled mode and autonomous mode	7
	Status LED behavior in controlled mode	7
	Status LED behavior in autonomous mode	8
<b>2</b>	<b>Installing</b>	<b>9</b>
	Planning the installation	9
	Preparing the weatherproof Ethernet cable	9
	Installing cabling	10
	Mounting the E-MSM466-R	11
	Pole installation	11
	Wall installation	13
	Connecting the E-MSM466-R	15
	Attaching the grounding wire and antennas	15
	Attaching the Ethernet cable	15
	Powering on the E-MSM466-R	16
<b>3</b>	<b>Initially Configuring (Autonomous mode)</b>	<b>17</b>
	Configuring your computer	17
	Connecting the cables and powering on the E-MSM466-R	17
	Switching the E-MSM466-R to autonomous mode	17
	Logging in	17
	Configuring basic wireless protection	18
	Assigning an IP address to the E-MSM466-R	18
	Testing the wireless network	19
	Before performing additional configuration	19
<b>4</b>	<b>Working with antennas</b>	<b>20</b>
	E-MSM466-R available antennas	20
<b>5</b>	<b>Support and other resources</b>	<b>21</b>
	Online Documentation	21
	Contacting HP	21
	HP Websites	21
	Typographic conventions	21
<b>A</b>	<b>Regulatory information</b>	<b>23</b>
	Notice for U.S.A.	23
	Manufacturer's FCC Declaration of Conformity Statement	23
	FCC Class B statement	23
	Notice to Professional Installers	23
	Notice for Canada	24
	Notice for the European Community	24
	Countries of Operation & Conditions of Use	24
	2.4 GHz Operation	25
	5 GHz Operation	25

Operation Using 5 GHz Channels in the European Community.....	25
Supported External Antennas.....	25
Notice for Brazil, Aviso aos usuários no Brasil.....	25
Notice for Taiwan.....	26
DGT LPD (Low Power Device) Statement.....	26
Korean notices.....	26
Class B equipment.....	26
Turkish recycling notice.....	26
Vietnamese Information Technology and Communications compliance marking.....	26
DOC for the European Community.....	27
Disposal of Waste Equipment by Users in Private Household in the European Union.....	28
English recycling notice.....	28
Bulgarian recycling notice.....	28
Czech recycling notice.....	28
Danish recycling notice.....	28
Dutch recycling notice.....	28
Estonian recycling notice.....	29
Finnish recycling notice.....	29
French recycling notice.....	29
German recycling notice.....	29
Greek recycling notice.....	29
Hungarian recycling notice.....	29
Italian recycling notice.....	30
Latvian recycling notice.....	30
Lithuanian recycling notice.....	30
Polish recycling notice.....	30
Portuguese recycling notice.....	30
Romanian recycling notice.....	31
Slovak recycling notice.....	31
Spanish recycling notice.....	31
Swedish recycling notice.....	31

# 1 Preparing for Installation

This chapter shows you how to get started using the E-MSM466-R Access Point.

## Package Contents

- One E-MSM466-R
- One weatherproof RJ-45 Ethernet connector
- One pole mount/wall mount bracket
- Bracket bolts (x2), lock washers (x2), flat washers (x4)
- Wall anchors (x4) and screws (x4)
- Pole clamps (x2) for a 5 cm (2 inch) diameter pole
- Documentation

## Identifying E-MSM466-R components

E-MSM466-R key components are identified as follows:

**Figure 1 E-MSM466-R key components**

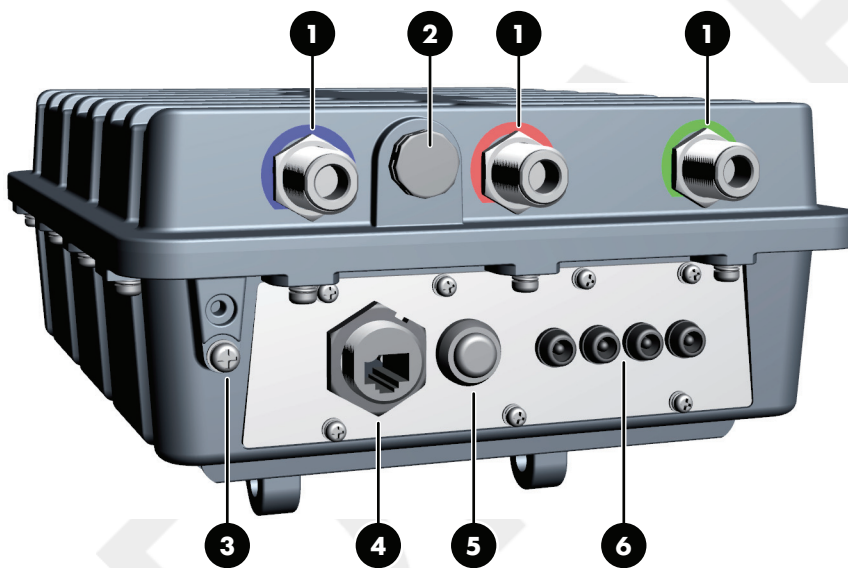

- |                                    |                                                    |
|------------------------------------|----------------------------------------------------|
| 1. Radio 2 antenna connectors (x3) | 4. Ethernet connector                              |
| 2. Vent Nut (do not remove)        | 5. Reset button                                    |
| 3. Grounding lug with screw        | 6. Status LEDs (Power, Ethernet, Radio 1, Radio 2) |

**NOTE:** Three Radio 1 antenna connectors are available on the opposite end of the E-MSM466-R.

## Protection Equipment Needed

In addition to the items supplied with the E-MSM466-R, protection equipment will be required according to your electrical code. Consult the respective *Antenna Guide* (available online, search by antenna part number), including the *Lightning Arrester* section for important safety information and instructions. Note that although the E-MSM466-R includes a built-in Ethernet surge suppressor, you should add an Ethernet surge suppressor where the Ethernet cable enters the building.

## Ports

**Ethernet port:** Auto-sensing 10/100/1000 BaseT Ethernet port with RJ-45 connector. The port supports Power over Ethernet (PoE) 802.3af and 802.3at.

## Radios and antennas

The E-MSM466-R includes no integrated antennas. It provides three antenna connectors for each radio, color-coded red, green, and blue. When connecting the antenna cables, be sure to respect the color-coding. See “E-MSM466-R available antennas” (page 20).

## Reset button

The Reset button is on the bottom of the E-MSM466-R, labeled as 5 in “E-MSM466-R key components” (page 5). To reset (same as power cycling) the E-MSM466-R, press then release the Reset button. To reset the E-MSM466-R to factory defaults, press and hold the Reset button until the status LEDs flash three times, then release.

## Important information to read before installing

---

### **WARNING!** PROFESSIONAL INSTALLATION REQUIRED.

For outdoor or indoor installation. Prior to installing or using the E-MSM466-R, consult with a professional installer trained in RF installation and knowledgeable in local regulations including building and wiring codes, safety, channel, power, outdoor/indoor restrictions, and license requirements for the intended country. It is the responsibility of the end user to ensure that installation and use complies with local safety and radio regulations.

---

**Surge protection and grounding:** When connecting antennas installed outdoors to the E-MSM466-R, make sure that proper lightning surge protection and grounding precautions are taken according to local electrical code. Failure to do so may result in personal injury, fire, equipment damage, or a voided warranty. The HP hardware warranty provides no protection against damage caused by static discharge or a lightning strike. Lightning Arresters (not supplied) are available from HP (J8996A). One arrester is required for each antenna connector (6).

**Cabling:** You must use the appropriate cables, and where applicable, surge protection, for your given region. Cat 5e (or better) cabling is required.

**Country of use:** In some regions, you are prompted to select the country of use during setup. After the country has been set, the E-MSM466-R will automatically limit the available wireless channels, ensuring compliant operation in the selected country. Entering the incorrect country may result in illegal operation and may cause harmful interference to other systems.

**Safety:** Take note of the following during installation:

- If your network covers an area served by more than one power distribution system, make sure all safety grounds are securely interconnected.
- Network cables are subject to hazardous transient voltages (caused by lightning or disturbances in the electrical power grid).
- Handle exposed metal components of the network with caution.
- The E-MSM466-R is powered-on when connected to a PoE power source.

## Powering the E-MSM466-R

The E-MSM466-R can be powered by:

- A 10/100 or 10/100/1000 PoE-enabled switch. Various PoE-enabled switches are available from HP.
- HP 1-Port 802.3at Gig PoE Power Injector (JD054A).
- HP 1-Port 802.3af Gig PoE Power Injector (J9407B).

**CAUTION:** If the E-MSM466-R will be powered by a user-supplied PoE power injector, use only a gigabit-compatible power injector. Although 10/100 PoE-enabled switches are compatible, PoE injectors designed for 10/100 networks only are NOT compatible with the E-MSM466-R.

## About controlled mode and autonomous mode

The E-MSM466-R can operate in one of two modes: controlled (the default) or autonomous. Switching modes resets all configuration settings to factory defaults.

- **Controlled mode:** To become operational, the E-MSM466-R must establish a management tunnel with an E-MSM7xx Controller running at least v5.7.x software. The controller manages the E-MSM466-R and provides all configuration settings. Discovery of the controller is automatic if default settings are used on the E-MSM466-R and the controller, and both devices are on the same subnet. See *Working with controlled APs in the E-MSM7xx Controllers Management and Configuration Guide*.
- **Autonomous mode:** After being switched to autonomous mode, the E-MSM466-R operates as a stand-alone E-MSM466-R. You configure and manage an autonomous E-MSM466-R by using its Web-based management tool, as described in “Initially Configuring (Autonomous mode)” (page 17).

## Status LED behavior in controlled mode

**Table 1 Status LED behavior in controlled mode**

Status LED behavior	Description
Power LED blinks every two seconds.	The E-MSM466-R is starting up.
Power LED blinks once per second.	The E-MSM466-R is looking for an IP address, or building the list of VLANs on which to perform discovery. The management tool is available until discovery occurs.
Power, Ethernet, and Radio LEDs blink in sequence from left to right.	The E-MSM466-R has obtained an IP address and is attempting to discover a controller.
Power LED is on. Ethernet and Radio LEDs blink alternately.	The E-MSM466-R has found a controller and is attempting to establish a secure management tunnel with it.
Power and Ethernet LEDs blink alternately and quickly. Radio LEDs are off.	The E-MSM466-R has received a discovery reply from two or more controllers with the same priority setting. It is unable to connect with either controller until the conflict is resolved.
Power and Radio LEDs blink slowly.	The E-MSM466-R is attempting to establish a local mesh link to a master node.
Power and Ethernet LEDs blink slowly.	The E-MSM466-R is attempting to establish wired connectivity.

After the discovery process is complete, and the E-MSM466-R has established a secure management tunnel to a controller, the Power LED remains on and the Ethernet and Radio LEDs blink to indicate the presence of traffic.

## Status LED behavior in autonomous mode

**Table 2 Status LED behavior in autonomous mode**

LED	Status	Description
Power	Off	The E-MSM466-R has no power.
	Blinking	The E-MSM466-R is starting up. If the Power LED continues to blink after several minutes, it indicates that the software failed to load. Reset or power cycle the E-MSM466-R. If this condition persists, contact HP customer support.
	On	The E-MSM466-R is fully operational.
Ethernet	Off	The port is not connected or there is no activity.
	Blinking	The port is transmitting or receiving data.
Radio	Blinking	The radio is transmitting or receiving data.

DRAFT



## 2 Installing

- ⚠ WARNING!** This is a general procedure. It is the installer's responsibility to perform the installation according to local electrical code and regulations.

### Planning the installation

Identify a suitable install location. The E-MSM466-R is IP67 and NEMA 4X rated, providing protection against water intrusion and salt fog damage. Local electrical and building codes and regional regulations will dictate many aspects of your installation. It is recommended that you perform transmission and reception tests at a proposed location before installing.

You will have to provide an effective earth ground for the E-MSM466-R. It is rarely sufficient to use a metal pole for any equipment grounding. You will also need to decide how to route the Ethernet cable from the building to the E-MSM466-R.

### Preparing the weatherproof Ethernet cable

To provide a weatherproof seal, the Ethernet port on the E-MSM466-R uses a custom weatherproof cable connector (supplied). You must terminate your Ethernet cable with this connector as described in the following procedure. Cable length should not exceed 100 meters (300 feet).

- ⚠ CAUTION:** Ruggedized Ethernet cables must be used for outdoor cable runs.

1. Carefully unpack the nine quick-disconnect items from the plastic bag, identifying all parts as illustrated. If any parts are missing, DO NOT proceed until you get a replacement parts kit.

**Figure 2 Weatherproof connector parts**

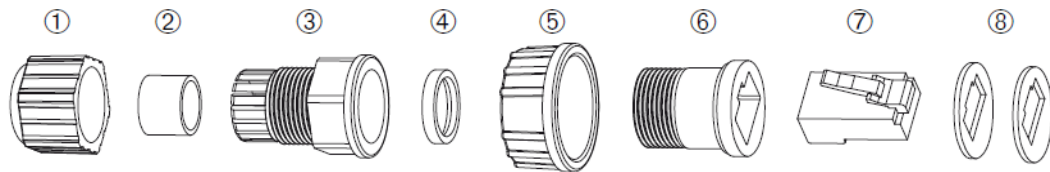

- |                |                  |
|----------------|------------------|
| 1. Sealing nut | 5. Screw nut     |
| 2. Seal        | 6. Body          |
| 3. Clamp ring  | 7. RJ-45 plug    |
| 4. Gasket      | 8. RJ-45 Gaskets |
2. If your Ethernet cable already has an RJ-45 connector on the end that will connect to the E-MSM466-R, remove the RJ-45 connector by cutting the cable at least 1.2 cm (.5 inch) before the RJ-45 connector. Be sure to make a clean cut with a pair of sharp angle cutters. *The complete cut (through both the cable sheath and all wires) must occur in a single cutting motion.*
  3. Hold the clamp ring (3) horizontally, with its fingers to the left. Insert the seal (2) into the fingers on the left end so that it is flush with the end of the fingers. Insert the gasket (4) into the right end, pushing it against the ridge at the end of the threads. The gasket (4) is beveled on one side. The beveled side should face inwards away from the screw nut (5).
  4. Thread the sealing nut (1) onto the left end of the clamp ring (3). Tighten it only enough for it to stay attached.
  5. Hold the screw nut (5) vertically, with the open threads facing up, and drop the body (6) into it, with the RJ-45 connector opening facing up.

6. Hold the clamp ring (3) vertically below the screw nut/body items and screw the body (6) into the threads on the clamp ring (3). Tighten it only enough to stay attached. Note that the screw nut (5) remains loose on the body (6).
7. Remove the white backing paper from one of the RJ-45 gaskets (8) and press the glued side onto the body (6) **being very careful** to align the gasket (8) with the RJ-45 connector shape on the body (6).
8. Remove the backing paper from the second RJ-45 gasket (8) and press it over the first one, being sure to maintain alignment.
9. Tighten the threads between body (6) and clamp Ring (3) **by hand. DO NOT tighten between clamp ring (3) and sealing nut (1). Do not over tighten. Do not tighten with tools.**  
The quick-disconnect assembly should now look like this when held horizontally, with the sealing nut (1) at the left end, and the screw nut (5) over the body (6) on the right.

**Figure 3 Quick-disconnect assembly**

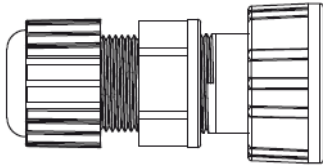

10. Carefully thread the cleanly-cut end of the Ethernet cable through the sealing nut (1) end of the quick-disconnect assembly, and push through approximately 30 cm (1 foot) of cable.

---

**NOTE:** The next two steps should be performed by someone with experience building Ethernet cables.

---

11. Prepare the cable and attach it to the RJ-45 Plug (7) according to the directions included with your crimping tool.
12. Before continuing, test the cable with a portable Ethernet cable tester to ensure that the RJ-45 plug (7) is correctly connected.
13. Carefully pull the cable slack back through the quick-disconnect assembly until the RJ-45 plug (7) is almost touching the body (6). Adjust the cable position so that the RJ-45 Plug (7) fits precisely into the RJ-45 cutout in the body (6), and press down the plastic tab so the plug fits correctly.
14. Tighten the threads between sealing nut (1) and clamp ring (3) by hand, until the cable is firmly anchored. **Do not over tighten. Do not tighten with tools.**

## Installing cabling

According to your needs and local electrical codes and regulations, run Ethernet, body ground wire, and any separate grounding wires as needed for antenna lightning arresters as described in the respective *Antenna Guide* to where the E-MSM466-R will be installed. For the Ethernet cable, allow for an extra 0.6 meters (two feet) for connector attachment and drip loops. Install an Ethernet surge suppressor (not supplied) according to its instructions at the location where the Ethernet cable enters the building. This may not be necessary if the outdoor cable run is very short, for example, when the E-MSM466-R is mounted on an outdoor wall. The E-MSM466-R already includes a built-in Ethernet suppressor for the other end of the Ethernet cable.

# Mounting the E-MSM466-R

## Pole installation

1. Locate the E-MSM466-R mount bracket. Note that the four screw holes (1) in Figure 4 are not used for pole mounts, only wall mounts.

**Figure 4 Mounting bracket**

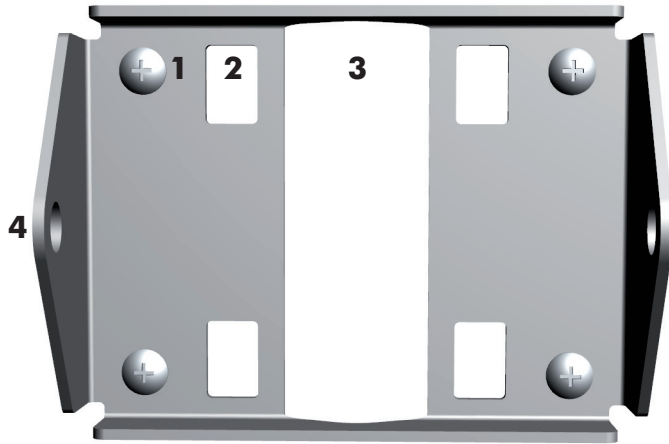

1. Screw holes (x4) (screws shown)

2. Pole clamp slot (x4)

3. Pole cut out

4. Bracket bolt hole (x2)

2. Refer to Figure 5. Locate the two bracket bolts (5), the two lock washers, and the four flat washers. Onto each bracket bolt (5), thread a lock washer followed by a flat washer. Push both washers against the bracket bolt (5) head.
3. Place the E-MSM466-R bracket post up on a table.
4. Position the bracket (4) over the bracket posts (6) so that the holes in the bracket (4) and the bracket posts (6) align.
5. On one side of the E-MSM466-R, slide in a second flat washer between the bracket (4) and the bracket post (6), and while holding the edge of this flat washer, thread the bracket bolt (5) (with the lock washer and flat washer already threaded) through the hole in the bracket (4), through the second flat washer, and then screw the bracket bolt (5) sufficiently into the bracket post (6) so that the threads fully grip.

- Repeat the same for the second bracket bolt (5). The E-MSM466-R with attached bracket should now look similar to Figure 5.

**Figure 5 Mounting Bracket Attached**

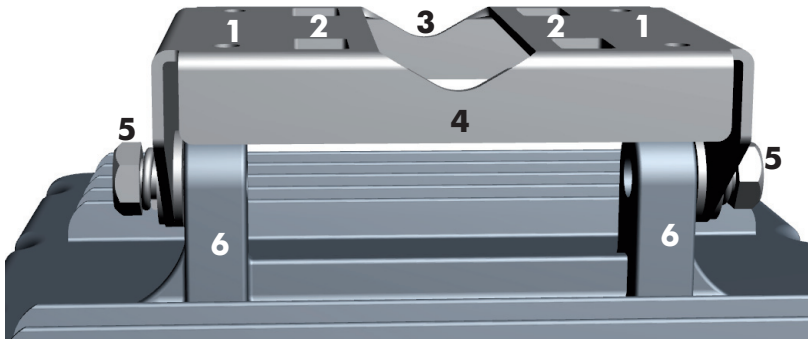

- |                         |                      |
|-------------------------|----------------------|
| 1. Screw holes (x4)     | 4. Bracket           |
| 2. Pole clamp slot (x4) | 5. Bracket bolt (x2) |
| 3. Pole cut out         | 6. Bracket post (x2) |

- Hold the E-MSM466-R with the Ethernet connector pointing toward the ground near the desired position on the pole and press the pole cut out (3) against the pole.
- Refer to Figure 6. For the first pole clamp, wrap the pole clamp around the pole, feed it through one pole clamp slot and then back out the other pole clamp slot, and then around the pole, and into the pole clamp anchor. Hold the E-MSM466-R firmly against the pole at the desired position and then fully tighten the pole clamp screw to anchor the E-MSM466-R against the pole. Attach the second pole clamp in the same manner as the first, also firmly tightening it.

**Figure 6 E-MSM466-R mounted on pole**

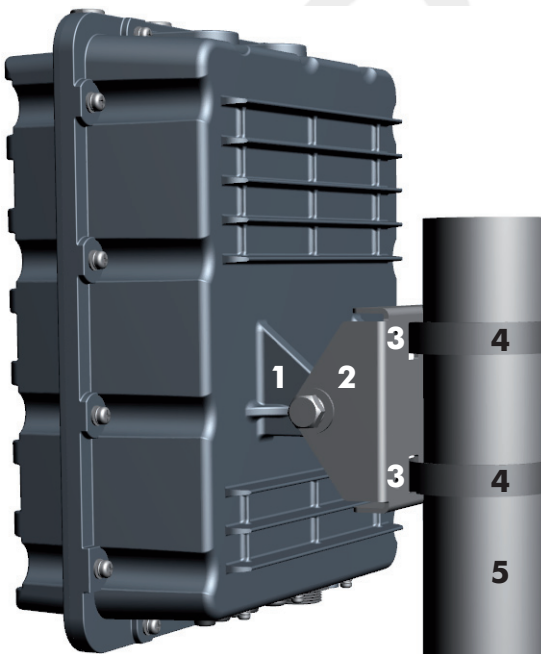

- |                         |                    |
|-------------------------|--------------------|
| 1. Bracket post         | 4. Pole clamp (x2) |
| 2. Bracket              | 5. Pole            |
| 3. Pole clamp slot (x2) |                    |

9. Rotate the E-MSM466-R body up or down to the desired position and then tighten the bracket bolts to 50 kgf-cm (43.4 lbf-in).

## Wall installation

1. Hold the mount bracket as a drilling template against the wall at the desired position with the two bracket bolt holes (4) facing the left and right sides. Mark four holes for the screws (wall anchors).

**Figure 7 Mounting bracket**

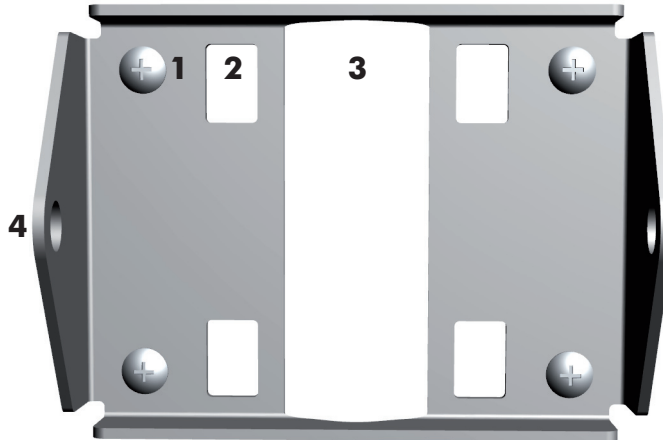

- |                                    |                           |
|------------------------------------|---------------------------|
| 1. Screw holes (x4) (screws shown) | 4. Bracket bolt hole (x2) |
| 2. Pole clamp slot (x4)            |                           |
| 3. Pole cut out                    |                           |

2. Drill four holes for the wall anchors, typically 4.7 mm (3/16 inch) in diameter.
3. Insert the anchors and tap them flush with the wall surface.
4. Screw the E-MSM466-R bracket to the wall.
5. Refer to Figure 8. Locate the two bracket bolts (5), the two lock washers, and the four flat washers. Onto each bracket bolt (5), thread a lock washer followed by a flat washer. Push both washers against the bracket bolt (5) head.
6. Hold the E-MSM466-R up to the mount bracket (4), angling the E-MSM466-R so that it is parallel with the mount bracket (4) and the bolt holes align.
7. Have an assistant hold the E-MSM466-R in place with the bolt holes aligned. On one side of the E-MSM466-R, slide in a second flat washer between the bracket (4) and the bracket post (6), and while holding the edge of this flat washer, thread the bracket bolt (5) (with the lock washer and flat washer already threaded) through the hole in the bracket (4), through the

second flat washer, and then screw the bracket bolt (5) sufficiently into the bracket post (6) so that the threads fully grip.

**Figure 8 Mounting Bracket Attached**

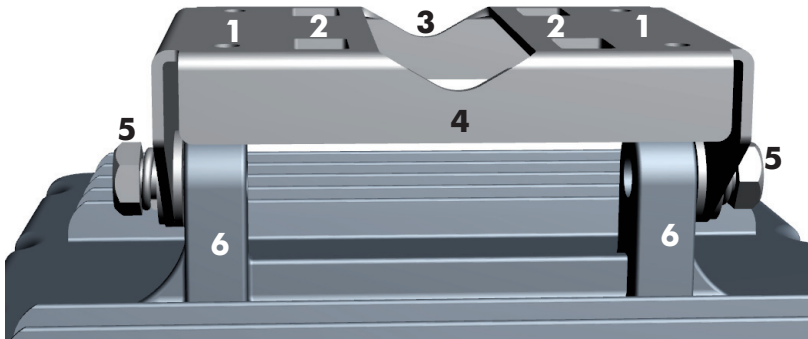

- |                         |                      |
|-------------------------|----------------------|
| 1. Screw holes (x4)     | 4. Bracket           |
| 2. Pole clamp slot (x4) | 5. Bracket bolt (x2) |
| 3. Pole cut out         | 6. Bracket post (x2) |

8. Repeat the same for the second bracket bolt (5).
9. Verify that the bracket (4) is now connected to the E-MSM466-R and the wall as illustrated in Figures 8 and 9.
10. Rotate the E-MSM466-R up or down to the desired position and then firmly tighten both bracket bolts (5) to 50 kgf-cm (43.4 lbf-in).

**Figure 9 E-MSM466-R mounted on wall**

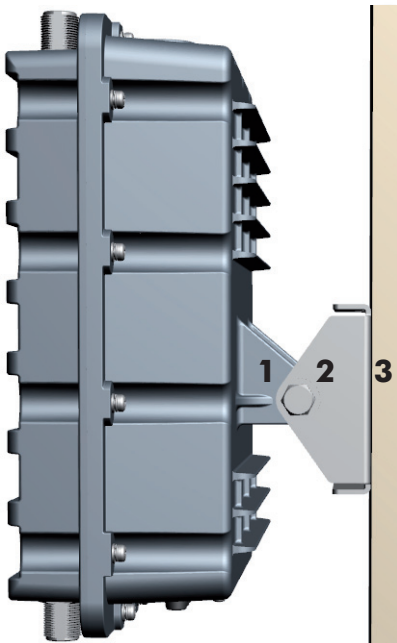

1. Bracket post
2. Bracket
3. Wall

# Connecting the E-MSM466-R

## Attaching the grounding wire and antennas

1. Remove the grounding screw (1) from lug on the E-MSM466-R body
2. Attach a grounding cable (2), #10 AWG or thicker, with the grounding screw (1).

**Figure 10** Grounding cable

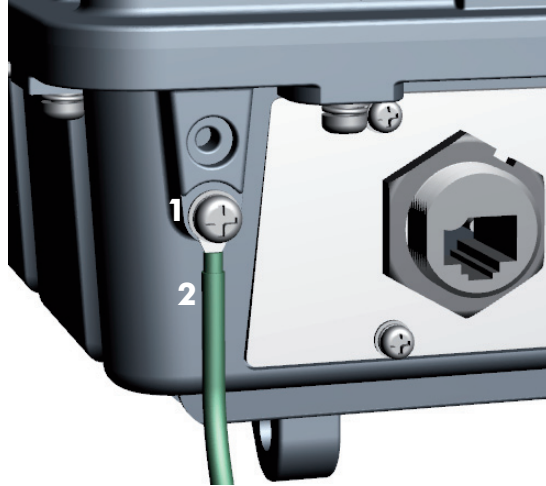

1. Grounding screw
2. Grounding cable
3. Tighten the grounding screw and ensure the cable is firmly anchored.
4. Install antennas including antenna connector lightning arresters as described in the respective *Antenna Guide* available online (search by antenna part number). An *HP Lightning Arrester (J8996A) Guide* is also available online.

## Attaching the Ethernet cable

1. Connect the Ethernet cable to the Ethernet connector (See [“E-MSM466-R key components” \(page 5\)](#)).
2. Create a drip loop in the Ethernet cable below the E-MSM466-R. A drip loop provides additional protection against water running down the Ethernet cable and into the connector. Form the loop as shown here. Make sure that the distance between the loop start and end points is at least 15 cm (6 inches), and that the cable hangs down at least 25 cm (10 inches).

**Figure 11** Drip loop

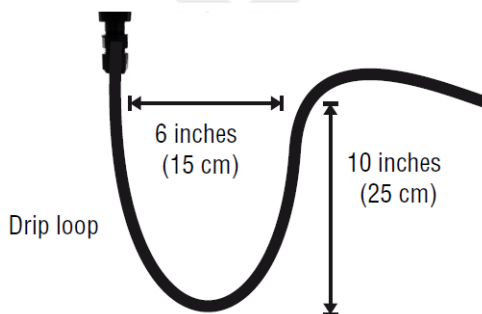

3. See [“Weatherproof connector parts” \(page 9\)](#). Mate the RJ-45 Plug with the socket on the E-MSM466-R, hold it firmly in place, and tighten the Screw Nut by hand. **Do not over tighten. Do not tighten with tools.**

## Powering on the E-MSM466-R

The E-MSM466-R can be powered by:

- A PoE-enabled switch. PoE-enabled switches are available from HP.
- HP 1-Port 802.3at Gig PoE Power Injector (JD054A).
- HP 1-Port 802.3af Gig PoE Power Injector (J9407B).

DRAFT



---

## 3 Initially Configuring (Autonomous mode)

This procedure describes how to switch a factory-default E-MSM466-R to autonomous mode and then perform its initial configuration that enables you to establish a wireless connection through the E-MSM466-R to the Internet.

---

**NOTE:** The controller must be running at least v5.7.x software.

**NOTE:** For controlled-mode configuration, see *Working with controlled APs* in the *E-MSM7xx Controllers Management and Configuration Guide*.

---

### Configuring your computer

1. Disconnect your computer LAN port and configure it to use a static IP address in the range **192.168.1.2** to **192.168.1.254**, and a subnet mask of **255.255.255.0** as described in your operating system documentation. Set the default gateway to **192.168.1.1**, and DNS server to **192.168.1.1**.
2. Disable any wireless connection on your computer.

### Connecting the cables and powering on the E-MSM466-R

1. Connect the cables:
  - If using a PoE switch, use Ethernet cables to connect your computer and the E-MSM466-R to an unused factory-default PoE switch.
  - If using a PoE injector, use Ethernet cables to connect your computer to the *data in* port of the PoE injector and the E-MSM466-R to the *data* and *power out* port of the PoE injector.
2. Power on the E-MSM466-R by powering on the PoE switch or injector. Initially, the E-MSM466-R Power LED will blink once every two seconds. Wait approximately a minute until it begins blinking once per second before proceeding to the next step.

### Switching the E-MSM466-R to autonomous mode

---

**NOTE:** A factory-default E-MSM466-R is assumed.

---

1. In a Web browser, enter the address: **https://192.168.1.1**.
2. A security certificate warning is displayed the first time you connect to the management tool. This is normal. Select whatever option is needed in your Web browser to continue to the management tool.
3. On the Login page, specify **admin** for both **Username** and **Password** and then select **Login**. The E-MSM466-R management tool home page opens.
4. Select **Switch to Autonomous Mode** and confirm the change. The E-MSM466-R restarts in autonomous mode.

---

**NOTE:** To avoid a delay after switching modes, clear the ARP (address resolution protocol) cache on your computer. In Windows for example, from the **Windows Start** menu, select **Run** and enter "arp -d" (without the quotes). Select **OK**.

---

### Logging in

1. Wait until the Power LED stops blinking and remains on.
2. On the Login page, specify **admin** for both **Username** and **Password** and then select **Login**.
3. Click through the other prompts for License and Registration.

4. In some regions, a **Country** prompt appears. Select the country in which the E-MSM466-R will operate.

△ **CAUTION:** The correct country must be selected. See “Country of use” (page 6).

5. At the password prompt it is recommended that you change the default password and select **Save**. Passwords must be at least six characters long and include four different characters. The management tool is organized with menus and sub-menus. Instructions for making menu selections, such as “select **Wireless > Local mesh**” instruct you to select the **Wireless** menu and then the **Local mesh** sub-menu, as follows:

**Figure 12 Selecting Wireless > Local mesh**

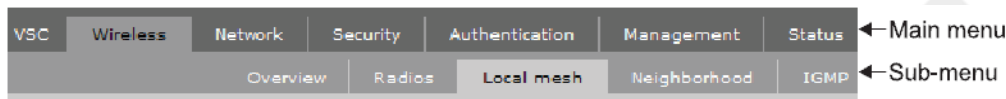

## Configuring basic wireless protection

It is recommended that you at least configure basic wireless protection. See *Wireless protection* in the *E-MSM3xx / E-MSM4xx Access Points Management and Configuration Guide*. To configure basic WPA protection:

1. Select **VSC > HP** and then enable **Wireless protection** and set it to **WPA**.
2. Under **Mode**, select **WPA or WPA2**, then under Key source, select **Preshared key** and specify a key of at least 20 characters. Select **Save**.

## Assigning an IP address to the E-MSM466-R

By default the E-MSM466-R operates as a DHCP client. This means that if the network has a DHCP server, the E-MSM466-R will automatically receive a new IP address in place of its default address of 192.168.1.1 upon connecting to the network. Use one of the following methods to assign an IP address to the E-MSM466-R:

- **Pre-configure the DHCP server** to assign a specific IP address to the E-MSM466-R. To do this you need to specify the E-MSM466-R Ethernet MAC address and a reserved IP address on the DHCP server. The E-MSM466-R Ethernet MAC address is printed on the E-MSM466-R label identified as **LAN MAC**, and listed on the management tool Home page as **Ethernet base MAC address**.
- **Let the DHCP server automatically assign an IP address.** By default, the DHCP server will assign an IP address after the E-MSM466-R connects to the network. After the DHCP server has assigned the E-MSM466-R an IP address, you can then find the IP address of the E-MSM466-R by looking for its Ethernet base MAC address in the DHCP server log. For example after Step 4 below, you could go to the DHCP server log to retrieve the IP address assigned to the E-MSM466-R.
- **Assign a static IP address to the E-MSM466-R.** The address must be on the same subnet as the network to which the E-MSM466-R will connect.
  1. Select **Network > DNS**, and set the DNS server address. Select **Save**.
  2. Select **Network > Ports > Bridge port**.
  3. Select **Static** and then **Configure**. For **IP address** set an address that is on the same subnet as the network to which the E-MSM466-R will connect after installation. Respect any DHCP server-mandated static address ranges. Also set **Mask** and **Default gateway**.
  4. Select **Save**. Connection to the management tool is lost. You can later reconnect to the management tool by specifying the new IP address.

## Testing the wireless network

For the purposes of this example, the network must have a DHCP server and an Internet connection. Broadband routers typically include a DHCP server.

1. Disconnect your computer from the PoE switch or injector.
2. Power off the E-MSM466-R by disconnecting the Ethernet cable from the E-MSM466-R.
3. Use an Ethernet cable to connect the switch or the *data in* port of the injector to the network.
4. Reconnect and power on the E-MSM466-R. Use an Ethernet cable to reconnect the E-MSM466-R to the PoE switch or the *data* and *power out* port of the injector.
5. Enable the wireless network interface of your computer, and ensure that it is set to obtain an IP address and a DNS address automatically as described in your operating system documentation.
6. By default, the E-MSM466-R creates a wireless network named HP in the 5GHz band for 802.11n and 802.11a users. Connect your computer to this wireless network, specifying the pre-shared key you set earlier in Step 2 of [“Configuring basic wireless protection” \(page 18\)](#).
7. Confirm that you can browse the Internet using the wireless network.

## Before performing additional configuration

Configure your computer LAN port and connect it to the same network as the E-MSM466-R. Re-launch the E-MSM466-R management tool at **https://<IP address>** where **<IP address>** is the E-MSM466-R IP address from [“Assigning an IP address to the E-MSM466-R” \(page 18\)](#) above.

## 4 Working with antennas

For antenna installation information, refer to the respective *Antenna Guide*. Important safety information is included in each *Antenna Guide*.

### E-MSM466-R available antennas

Only the following antennas are approved for use with the E-MSM466-R. Compatible indoor antennas are shown only for those who choose to install an E-MSM466-R in an indoor location.

**NOTE:** For indoor installations, indoor antennas can be used with the E-MSM466-R, however, RP-SMA to standard N connector adapters (not supplied) are required to connect indoor antennas to the E-MSM466-R.

**Table 3 E-MSM466-R Available Antennas**

Part	Type	Band	Gain	Use	Elements
J9719A	Omni-directional	2.4GHz	6dBi	Outdoor	3
J9720A	Omni-directional	5GHz	8dBi	Outdoor	3
J9169A	Narrow Beam Sector	2.4/5GHz	8/10.7dBi	Outdoor	3
J9170A	Directional	2.4/5GHz	10.9/13.5dBi	Outdoor	3
J9171A	Omni-directional	2.4/5GHz	3/4dBi	Indoor	3
J9659A	Omni-directional	2.4/5GHz	2.5/6dBi	Indoor	6

**CAUTION:** Depending on the country of use, the antenna selected, and your radio settings, it may be mandatory to reduce the radio transmission power level to maintain regulatory compliance. For specific power limits for your country, consult the *HP E-MSM466-R External Antenna RF Power-level Setting Guide* available from [www.hp.com/support/manuals](http://www.hp.com/support/manuals) (search for your antenna).

**WARNING!** When using the E-MSM466-R outdoors, you must ensure that a lightning arrester is used on each antenna connector (6). Lightning Arresters (not supplied) are available from HP (J8996A).

# 5 Support and other resources

## Online Documentation

You can download documentation from the HP Support Website at: [www.hp.com/support/manuals](http://www.hp.com/support/manuals). Search by product number or name.

## Contacting HP

For worldwide technical support information, see the HP support Website: [www.hp.com/networking/support](http://www.hp.com/networking/support)

Before contacting HP, collect the following information:

- Product model names and numbers
- Technical support registration number (if applicable)
- Product serial numbers
- Error messages
- Operating system type and revision level
- Detailed questions

## HP Websites





For additional information, see the following HP Websites:

- [www.hp.com](http://www.hp.com)
- [www.hp.com/networking](http://www.hp.com/networking)

## Typographic conventions

**Table 4 Document conventions**

Convention	Element
Blue text: <a href="#">Table 4 (page 21)</a>	Cross-reference links and e-mail addresses
Blue, underlined text: <a href="http://www.hp.com">www.hp.com</a>	Website addresses
<b>Bold</b> text	<ul style="list-style-type: none"><li>• Keys that are pressed</li><li>• Text typed into a GUI element, such as a box</li><li>• GUI elements that are clicked or selected, such as menu and list items, buttons, tabs, and check boxes</li></ul>
<i>Italic</i> text	Text emphasis
Monospace text	<ul style="list-style-type: none"><li>• File and directory names</li><li>• System output</li><li>• Code</li><li>• Commands, their arguments, and argument values</li></ul>
<i>Monospace, italic</i> text	<ul style="list-style-type: none"><li>• Code variables</li><li>• Command variables</li></ul>
<b>Monospace, bold</b> text	Emphasized monospace text

- 
-  **WARNING!** Indicates that failure to follow directions could result in bodily harm or death.
- 
-  **CAUTION:** Indicates that failure to follow directions could result in damage to equipment or data.
- 
-  **IMPORTANT:** Provides clarifying information or specific instructions.
- 
- NOTE:** Provides additional information.
- 
-  **TIP:** Provides helpful hints and shortcuts.
- 

DRAFT

---

# A Regulatory information

## Notice for U.S.A.

### Manufacturer's FCC Declaration of Conformity Statement

<b>Manufacturer:</b>	Hewlett-Packard Company 3000 Hanover Street Palo Alto, CA 94304-1185 USA
----------------------	--------------------------------------------------------------------------------

For questions regarding this declaration, contact the Product Regulations Manager at the above address.

### FCC Class B statement

This FCC Class B device complies with Part 15 of the FCC rules. Operation is subject to the following two conditions: 1) this device may not cause harmful interference, and 2) this device must accept any interference received, including interference that may cause undesired operation.

This device has been tested and found to comply with the limits for a Class B digital device, pursuant to part 15 of the FCC Rules. These limits are designed to provide reasonable protection against harmful interference in a residential installation. This equipment generates, uses, and can radiate radio frequency energy and, if not installed and used in accordance with the instructions, may cause harmful interference to radio communications. However, there is no guarantee that interference will not occur in a particular installation. If this equipment does cause harmful interference to radio or television reception, which can be determined by turning the equipment off and on, the user is encouraged to try to correct the interference by one or more of the following measures:

- Reorient or relocate the receiving antenna.
- Increase the separation between the equipment and the receiver.
- Connect the equipment into an outlet on a circuit different from that to which the receiver is connected.
- Consult the dealer or an experienced radio/television technician for help.

The FCC requires the user to be notified that any changes or modifications made to the device that are not expressly approved by the Hewlett-Packard Company may void the user's authority to operate the equipment.

- 
- △ CAUTION:** In the United States, operation on channels 36-48 in the 5150-5250 MHz band , and 100-140 in the 5470-5725 MHz band is restricted to indoor-use only. Outdoor operation on these channels is a strict violation of the FCC rules and can cause harmful interference to commercial radar communications. For outdoor operation, channels 36-48 and 100-140 must not be used. If using automatic channel assignment, add channels 36-48 and 100-140 to the Automatic channel exclusion list.
- 

### Notice to Professional Installers

As a Professional Installer responsible for the proper installation and configuration of this Access Point, you need to understand and prepare for operating near any TDWR (Terminal Doppler Weather Radar) locations. The FCC has requested that you become familiar with and comply with the following:

- Read and understand the FCC Memorandum dated July 27th, 2010, Subject: Elimination of interference to Terminal Doppler Weather Radar (TDWR) located here:

[www.spectrumbridge.com/Libraries/Misc\\_docs/FCC Memorandum on UNII Device Operation.sflb.ashx](http://www.spectrumbridge.com/Libraries/Misc_docs/FCC_Memorandum_on_UNII_Device_Operation.sflb.ashx)

- If the E-MSM466-R system is within the specified range 35km (21.75 mi) of any TDWR, set the primary transmit frequency (and alternate frequencies, if used) to a frequency (or frequencies) at least 30 MHz (center-to-center) from the TDWR operation frequency shown on [www.spectrumbridge.com/udia/search.aspx](http://www.spectrumbridge.com/udia/search.aspx), or in the table shown in the above FCC Memorandum.
- If you are using automatic channel assignment, add the channels you need to avoid in the automatic channel exclusion list.
- Register each E-MSM466-R system operating within 35km (21.75mi) of any TDWR in the voluntary WISPA-sponsored database at: [www.spectrumbridge.com/udia/home.aspx](http://www.spectrumbridge.com/udia/home.aspx)

## Notice for Canada

The following notices apply to Canada:

- This device complies with the limits for a Class B digital device and conforms to Industry Canada standard ICES-003. Products that contain a radio transmitter comply with Industry Canada standard RSS210 and are labeled with an IC approval number.
- Cet appareil numérique de la classe B est conforme à la norme ICES-003 de Industry Canada. La radio sans fil de ce dispositif est conforme à la certification RSS 210 de Industry Canada et est étiquetée avec un numéro d'approbation IC.
- This device complies with the Class B limits of Industry Canada. Operation is subject to the following two conditions: 1) this device may not cause harmful interference, and 2) this device must accept interference received, including interference that may cause undesired operation.

To reduce potential radio interference with other users, the antenna type and its gain should be so chosen that the equivalent isotropically radiated power (EIRP) is not more than that required for successful communication.

## Notice for the European Community



This device complies with the EMC Directive 2004/108/EC, Low Voltage Directive 2006/95/EC and R&TTE Directive 1999/5/EC. Compliance with these directives implies conformity to harmonized European standards (European Norms) that are listed on the EU Declaration of Conformity that has been issued by HP for this device.

See also "Recycling notices" (page 27)

## Countries of Operation & Conditions of Use

This device may be used in the following EU and EFTA countries: Austria, Belgium, Bulgaria, Cyprus, Czech Republic, Denmark, Estonia, Finland, France, Germany, Greece, Hungary, Iceland, Ireland, Italy, Latvia, Liechtenstein, Lithuania, Luxembourg, Malta, Netherlands, Norway, Poland, Portugal, Romania, Slovakia, Slovenia, Spain, Sweden, Switzerland and the United Kingdom. Requirements for outdoor vs. indoor operation, licensing and allowed channels of operation apply in some countries as described below.



---

**NOTE:** The user must use the configuration utility provided with this device to ensure the channels of operation are in conformance with the spectrum usage rules for EU and EFTA countries as described below.

---

## 2.4 GHz Operation

- This device may be operated outdoors or indoors in all EU and EFTA countries using the 2.4 GHz band (Channels 1 - 13), except where noted below.
- In **France**, this device may use the entire 2400 - 2483.5 MHz band (Channels 1 through 13) for indoor applications. For outdoor use, only the 2400 - 2454 MHz frequency band (Channels 1 through 9) may be used. For the latest requirements, see <http://www.art-telecom.fr>.

L'utilisation de cet équipement (2.4 GHz wireless LAN) est soumise à certaines restrictions: cet équipement peut être utilisé à l'intérieur d'un bâtiment en utilisant toutes les fréquences de 2400 à 2483.5 MHz (Chaîne 1-13). Pour une utilisation en environnement extérieur, vous devez utiliser les fréquences comprises entre 2400 à 2454-MHz (Chaîne 1-9). Pour les dernières restrictions, voir <http://www.art-telecom.fr>.

## 5 GHz Operation

- This device requires the user or installer to properly enter the **current country of operation** in the 5 GHz Radio Configuration Window.
- This device will automatically limit the allowable channels determined by the current country of operation. Incorrectly entering the country of operation may result in illegal operation and may cause harmful interference to other systems. The user is obligated to ensure the device is operating according to the channel limitations, outdoor/indoor restrictions and license requirements for each European Community country as described in this guide.
- This device employs **a radar detection feature** required for European Community and EFTA country operation in the 5 GHz band. This feature is automatically enabled when the country of operation is correctly configured for any European Community or EFTA country. The presence of nearby radar operation may result in temporary interruption of operation of this device. The radar detection feature will automatically restart operation on a channel free of radar.
- This device is restricted to **indoor** use when operated in EU and EFTA countries using the 5.15-5.35 GHz band (Channels 36, 40, 44, 48, 52, 56, 60 and 64). See the table below for the allowed 5 GHz channels in each band.

## Operation Using 5 GHz Channels in the European Community

The user/installer must use the provided configuration utility to check the current channel of operation and make necessary configuration changes to ensure operation occurs in conformance with European National spectrum usage laws as described below and elsewhere in this guide.

Frequency Band (MHz)	Allowed Channels	Usage	Maximum EIRP (mW)
5150 - 5250	36, 40, 44, 48	Indoor use only	200
5250 - 5350	52, 56, 60, 64	Indoor use only	200
5470 - 5725	100, 104, 108, 112, 116, 132, 136, 140.	Indoor or outdoor use	1000

## Supported External Antennas

For antenna information see "E-MSM466-R available antennas" (page 20).

## Notice for Brazil, Aviso aos usuários no Brasil

Este equipamento opera em caráter secundário, isto é, não tem direito à proteção contra interferência prejudicial, mesmo de estações do mesmo tipo, e não pode causar interferência a sistemas operando em caráter primário.

## Notice for Taiwan

### DGT LPD (Low Power Device) Statement

#### 低功率電波輻射性電機管理辦法

第十四條 經型式認證合格之低功率射頻電機，非經許可，公司、商號或使用者均不得擅自變更頻率、加大功率或變更原設計之特性及功能。

第十七條 低功率射頻電機之使用不得影響飛航安全及干擾合法通信；經發現有干擾現象時，應立即停用，並改善至無干擾時方得繼續使用。  
前項合法通信，指依電信規定作業之無線電信。低功率射頻電機須忍受合法通信或工業、科學及醫療用電波輻射性電機設備之干擾。

## Korean notices

### Class B equipment

#### B급 기기 (가정용 정보통신기기)

이 기기는 가정용으로 전자파적합등록을 한 기기로서 주거지역에서는 물론 모든 지역에서 사용할 수 있습니다.

## Turkish recycling notice



Türkiye Cumhuriyeti: EEE Yönetmeliğine Uygundur

## Vietnamese Information Technology and Communications compliance marking

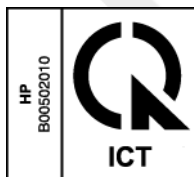

# DOC for the European Community

The following DOC (Declaration of Conformity) applies to the European Community.



## DECLARATION OF CONFORMITY according to ISO/IEC 17050-1 and EN 17050-1

**DoC #: MRLBB-1002-03**

**Supplier's Name:** Hewlett-Packard Company  
**Manufacturer's Address:** 8000 Foothills Blvd., Roseville, CA 95747 U.S.A.

**declares, that the product**

**Product Name:** HP E-MSM466 Dual Radio 802.11n AP  
**Product Number(s):** J9622A, J9619A  
**Regulatory Model No:** MRLBB-1002  
**Product Options:** J9169A, J9170A, J9171A, J9659A

**conforms to the following Product Specifications:**

**Safety:** IEC 60950-1:2005 / EN 60950-1:2006 +A11:2009  
**EMC:** EN 55022:2006 +A1:2007, Class B  
EN 60601-1-2:2007  
**Telecom:** EN 300 328 V1.7.1 (2006-10)  
EN 301 893 V1.5.1 (2008-12)  
EN 301 489-17 V2.1.1 (2009-05)  
EN 62311:2008  
**Energy Use:** Regulation (EC) No. 1275/2008

### Supplementary Information:

The product herewith complies with the requirements of the Low Voltage Directive 2006/95/EC, the EMC Directive 2004/108/EEC and the R&TTE Directive 1999/5/EC and carries the CE marking accordingly.

For regulatory identification purposes, this product has been assigned a Regulatory Model Number (RMN). The RMN for your product is MRLBB-1002. The RMN should not be confused with the marketing name or Product Numbers.

This product includes integral wireless radio modules, model MRLBB-1003.

Roseville, November 29, 2010

  
Michael E. Avery, Regulatory Engineering Mgr

### Local contact for regulatory information:

EMEA: Hewlett-Packard GmbH, HQ-TRE, Herrenberger Straße 140, D-71034 Böblingen, Germany  
[www.hp.com/go/certificates](http://www.hp.com/go/certificates)

U.S.: Hewlett-Packard, 3000 Hanover St., Palo Alto, CA 94304, U.S.A. 650-857-1501

# Disposal of Waste Equipment by Users in Private Household in the European Union

## English recycling notice

### Disposal of waste equipment by users in private household in the European Union



This symbol means do not dispose of your product with your other household waste. Instead, you should protect human health and the environment by handing over your waste equipment to a designated collection point for the recycling of waste electrical and electronic equipment. For more information, please contact your household waste disposal service

## Bulgarian recycling notice

### Изхвърляне на отпадъчно оборудване от потребители в частни домакинства в Европейския съюз



Този символ върху продукта или опаковката му показва, че продуктът не трябва да се изхвърля заедно с другите битови отпадъци. Вместо това, трябва да предпазите човешкото здраве и околната среда, като предадете отпадъчното оборудване в предназначен за събирането му пункт за рециклиране на неизползваемо електрическо и електронно борудване. За допълнителна информация се свържете с фирмата по чистота, чиито услуги използвате.

## Czech recycling notice

### Likvidace zařízení v domácnostech v Evropské unii



Tento symbol znamená, že nesmíte tento produkt likvidovat spolu s jiným domovním odpadem. Místo toho byste měli chránit lidské zdraví a životní prostředí tím, že jej předáte na k tomu určené sběrné pracoviště, kde se zabývají recyklací elektrického a elektronického vybavení. Pro více informací kontaktujte společnost zabývající se sběrem a svozem domovního odpadu.

## Danish recycling notice

### Bortskaffelse af brugt udstyr hos brugere i private hjem i EU



Dette symbol betyder, at produktet ikke må bortskaffes sammen med andet husholdningsaffald. Du skal i stedet den menneskelige sundhed og miljøet ved at afl evere dit brugte udstyr på et dertil beregnet indsamlingssted for af brugt, elektrisk og elektronisk udstyr. Kontakt nærmeste renovationsafdeling for yderligere oplysninger.

## Dutch recycling notice

### Inzameling van afgedankte apparatuur van particuliere huishoudens in de Europese Unie



Dit symbool betekent dat het product niet mag worden gedeponeerd bij het overige huishoudelijke afval. Bescherm de gezondheid en het milieu door afgedankte apparatuur in te leveren bij een hiervoor bestemd inzamelpunt voor recycling van afgedankte elektrische en elektronische apparatuur. Neem voor meer informatie contact op met uw gemeentereinigingsdienst.

## Estonian recycling notice

### Äravisatavate seadmete likvideerimine Euroopa Liidu eramajapidamistes



See märk näitab, et seadet ei tohi visata olmeprügi hulka. Inimeste tervise ja keskkonna säästmise nimel tuleb äravisatav toode tuua elektriliste ja elektrooniliste seadmete käitlemisega egelevasse kogumispunkti. Küsimuste korral pöörduge kohaliku prügikäitlusettevõtte poole.

## Finnish recycling notice

### Kotitalousjätteiden hävittäminen Euroopan unionin alueella



Tämä symboli merkitsee, että laitetta ei saa hävittää muiden kotitalousjätteiden mukana. Sen sijaan sinun on suojattava ihmisten terveyttä ja ympäristöä toimittamalla käytöstä poistettu laite sähkö- tai elektroniikkajätteen kierrätyspisteeseen. Lisätietoja saat jätehuoltoyhtiöltä.

## French recycling notice

### Mise au rebut d'équipement par les utilisateurs privés dans l'Union Européenne



Ce symbole indique que vous ne devez pas jeter votre produit avec les ordures ménagères. Il est de votre responsabilité de protéger la santé et l'environnement et de vous débarrasser de votre équipement en le remettant à une déchetterie effectuant le recyclage des équipements électriques et électroniques. Pour de plus amples informations, prenez contact avec votre service d'élimination des ordures ménagères.

## German recycling notice

### Entsorgung von Altgeräten von Benutzern in privaten Haushalten in der EU



Dieses Symbol besagt, dass dieses Produkt nicht mit dem Haushaltsmüll entsorgt werden darf. Zum Schutze der Gesundheit und der Umwelt sollten Sie stattdessen Ihre Altgeräte zur Entsorgung einer dafür vorgesehenen Recyclingstelle für elektrische und elektronische Geräte übergeben. Weitere Informationen erhalten Sie von Ihrem Entsorgungsunternehmen für Hausmüll.

## Greek recycling notice

### Απορριψη άχρηστου εξοπλισμού από ιδιώτες χρήστες στην Ευρωπαϊκή Ένωση



Αυτό το σύμβολο σημαίνει ότι δεν πρέπει να απορριψετε το προϊόν με τα λοιπά οικιακά απορρίμματα. Αντίθετα, πρέπει να προστατέψετε την ανθρώπινη υγεία και το περιβάλλον παραδίδοντας τον άχρηστο εξοπλισμό σας σε εξουσιοδοτημένο σημείο συλλογής για την ανακύκλωση άχρηστου ηλεκτρικού και ηλεκτρονικού εξοπλισμού. Για περισσότερες πληροφορίες, επικοινωνήστε με την υπηρεσία απόρριψης απορριμμάτων της περιοχής σας.

## Hungarian recycling notice

### A hulladék anyagok megsemmisítése az Európai Unió háztartásaiban



Ez a szimbólum azt jelzi, hogy a készüléket nem szabad a háztartási hulladékkal együtt kidobni. Ehelyett a leselejtezett berendezéseknek az elektromos vagy elektronikus hulladék átvételére kijelölt helyen történő beszállításával megóvja az emberi egészséget és a környezetet. További információt a helyi köztisztasági vállalatától kaphat.

## Italian recycling notice

### Smaltimento di apparecchiature usate da parte di utenti privati nell'Unione Europea



Questo simbolo avvisa di non smaltire il prodotto con i normali rifiuti domestici. Rispettare la salute umana e l'ambiente conferendo l'apparecchiatura dismessa a un centro di raccolta designato per il riciclo di apparecchiature elettroniche ed elettriche. Per ulteriori informazioni, rivolgersi al servizio per lo smaltimento dei rifiuti domestici.

## Latvian recycling notice

### Europos Sąjungos namų ūkio vartotojų įrangos atliekų šalinimas



Šis simbolis nurodo, kad gaminio negalima išmesti kartu su kitomis buitinėmis atliekomis. Kad apsaugotumėte žmonių sveikatą ir aplinką, pasenusią nenaudojamą įrangą turite nuvežti į elektrinių ir elektroninių atliekų surinkimo punktą. Daugiau informacijos teiraukitės buitinių atliekų surinkimo tarnybos.

## Lithuanian recycling notice

### Nolietotu iekartu iznīcināšanas noteikumi lietotājiem Eiropas Savienības privātajās mājāsaimniecībās



Šis simbols norāda, ka ierīci nedrīkst utilizēt kopā ar citiem mājāsaimniecības atkritumiem. Jums jā rūpējas par cilvēku veselības un vides aizsardzību, nododot lietoto aprīkojumu otrreizējai pārstrādei īpašā lietotu elektrisko un elektronisko ierīču savākšanas punktā. Lai iegūtu plašāku informāciju, lūdzu, sazinieties ar savu mājāsaimniecības atkritumu likvidēšanas dienestu.

## Polish recycling notice

### Utylizacja zużytego sprzętu przez użytkowników w prywatnych gospodarstwach domowych w krajach Unii Europejskiej



Ten symbol oznacza, że nie wolno wyrzucać produktu wraz z innymi domowymi odpadkami. Obowiązkiem użytkownika jest ochrona zdrowia ludzkiego i środowiska przez przekazanie zużytego sprzętu do wyznaczonego punktu zajmującego się recyklingiem odpadów powstających ze sprzętu elektrycznego i elektronicznego. Więcej informacji można uzyskać od lokalnej firmy zajmującej wywozem nieczystości.

## Portuguese recycling notice

### Descarte de equipamentos usados por utilizadores domésticos na União Europeia



Este símbolo indica que não deve descartar o seu produto juntamente com os outros lixos domésticos. Ao invés disso, deve proteger a saúde humana e o meio ambiente levando o seu equipamento para descarte em um ponto de recolha destinado à reciclagem de resíduos de equipamentos eléctricos e electrónicos. Para obter mais informações, contacte o seu serviço de tratamento de resíduos domésticos.

## Romanian recycling notice

### Casarea echipamentului uzat de către utilizatorii casnici din Uniunea Europeană



Acest simbol înseamnă să nu se arunce produsul cu alte deșeuri menajere. În schimb, trebuie să protejați sănătatea umană și mediul predând echipamentul uzat la un punct de colectare desemnat pentru reciclarea echipamentelor electrice și electronice uzate. Pentru informații suplimentare, vă rugăm să contactați serviciul de eliminare a deșeurilor menajere local.



## Slovak recycling notice

### Likvidácia vyradených zariadení používateľmi v domácnostiach v Európskej únii



Tento symbol znamená, že tento produkt sa nemá likvidovať s ostatným domovým odpadom. Namiesto toho by ste mali chrániť ľudské zdravie a životné prostredie odovzdaním odpadového zariadenia na zbernom mieste, ktoré je určené na recykláciu odpadových elektrických a elektronických zariadení. Ďalšie informácie získate od spoločnosti zaoberajúcej sa likvidáciou domového odpadu.



## Spanish recycling notice

### Eliminación de los equipos que ya no se utilizan en entornos domésticos de la Unión Europea



Este símbolo indica que este producto no debe eliminarse con los residuos domésticos. En lugar de ello, debe evitar causar daños a la salud de las personas y al medio ambiente llevando los equipos que no utilice a un punto de recogida designado para el reciclaje de equipos eléctricos y electrónicos que ya no se utilizan. Para obtener más información, póngase en contacto con el servicio de recogida de residuos domésticos.



## Swedish recycling notice

### Hantering av elektroniskt avfall för hemanvändare inom EU



Den här symbolen innebär att du inte ska kasta din produkt i hushållsavfallet. Värna i stället om natur och miljö genom att lämna in uttjänt utrustning på anvisad samlingsplats. Allt elektriskt och elektroniskt avfall går sedan vidare till återvinning. Kontakta ditt återvinningsföretag för mer information.

