



Test Report

Prepared for: Cellphone Mate Inc

Model: M2M-V

Description: Single Band Direct Connect

FCC ID: RSNM2M-V

To

FCC Part 20

Date of Issue: April 20, 2014

On the behalf of the applicant:

Cellphone-Mate Inc.
48346 Milmont Drive
Fremont, CA 94538

To the attention of:

Hongtao Zhan, CEO
Ph: (510) 770-0469
Email: hzhhan@cellphone-mate.com

Prepared By
Compliance Testing, LLC
1724 S. Nevada Way
Mesa, AZ 85204
(480) 926-3100 phone / (480) 926-3598 fax
www.compliancetesting.com
Project No: p1440008

Mike Graffeo
Project Test Engineer

This report may not be reproduced, except in full, without written permission from Compliance Testing.
All results contained herein relate only to the sample tested.



Test Report Revision History

Revision	Date	Revised By	Reason for Revision
1.0	4/20/14	Mike Graffeo	Original Document
2.0	4/24/14	Amanda Reed & Mike Graffeo	Updated model description Re-measured gain & updated table
3.0	5/27/14	Mike Graffeo	1) Updated emission designators 2) Removed part 22 and part 24 references
4.0	6/20/14	Mike Graffeo	Updated test result summary table to show compliance to part 20 rules for noise limit, variable noise limit, and gain limit.



Table of Contents

<u>Description</u>	<u>Page</u>
Standard Test Conditions and Engineering Practices	5
Test Result Summary	6
Authorized Frequency Band	7
Maximum Power and Gain	9
Intermodulation	11
Out-of-Band Emissions	13
Conducted Spurious Emissions	22
Noise Limits	31
Variable Gain	34
Occupied Bandwidth	36
Oscillation Detection	43
Radiated Spurious	48
Test Equipment Utilized	50



ILAC / A2LA

Compliance Testing, LLC, has been accredited in accordance with the recognized International Standard ISO/IEC 17025:2005. This accreditation demonstrates technical competence for a defined scope and the operation of a laboratory quality management system (refer joint ISO-ILAC-IAF Communiqué dated January 2009).

The tests results contained within this test report all fall within our scope of accreditation, unless noted below.

Please refer to <http://www.compliancetesting.com/labscope.html> for current scope of accreditation.

Testing Certificate Number: **2152.01**

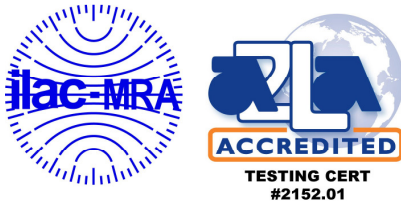

FCC Site Reg. #349717

IC Site Reg. #2044A-2

Non-accredited tests contained in this report:

N/A



Test and Measurement Data

Subpart
2.1033(c)(14):

All tests and measurement data shown were performed in accordance with FCC Rules and Regulations, Part 2, Subpart J and the following individual Parts: 20.21 in conjunction with latest version of KDB 935210.

Standard Test Conditions and Engineering Practices

Except as noted herein, the following conditions and procedures were observed during the testing:

In accordance with ANSI/C63.4-2009, and unless otherwise indicated in the specific measurement results, the ambient temperature of the actual EUT was maintained within the range of 10° to 40 °C (50° to 104 °F), unless the particular equipment requirements specify testing over a different temperature range. Also, unless otherwise indicated, the humidity levels were in the range of 10% to 90% relative humidity.

Environmental Conditions		
Temp (°C)	Humidity (%)	Pressure (mbar)
24.9 – 31.0	33.5 – 63.0	985.5 - 943.0

Measurement results, unless otherwise noted, are worst-case measurements.

EUT Description

Model: M2M-V

Description: Single Band Direct Connect

Firmware: N/A

Software: N/A

Additional Information:

The EUT is an in building, bi-directional amplifier (direct connect) for the boosting of cellular phone signals and data communication devices.

The following frequency bands and emission types are utilized and is considered a fixed consumer signal booster.

Frequency Band (MHz)	
Uplink	776 - 787
Downlink	746 - 757
Modulation Type	GSM, CDMA, EDGE, HSPA, EVDO, LTE

Emission Designators					
CDMA	HSPA	LTE	EVDO	EDGE	GSM
F9W	F9W	G7D	F9W	G7W	GXW

The modulation types and emission designators listed in the tables represent the modulations that the cell phone providers use for each frequency band. GSM, CDMA, and WCDMA represent all the modulation types (phase and amplitude or a combination thereof) utilized within the industry. EDGE, HSPA, LTE etc. are all protocols or multiplexing techniques using the base modulations.

EUT Operation during Tests

The EUT was in a normal operating condition.



Test Result Summary

Specification	Test Name	Pass, Fail, N/A	Comments
20.21(e)(3)	Authorized Frequency Band	Pass	
20.21(e)(8)(i)(B) 20.21(e)(8)(i)(C) 20.21(e)(8)(i)(D)	Maximum Power and Gain	Pass	
20.21(e)(8)(i)(F)	Intermodulation	Pass	
20.21(e)(8)(i)(E)	Out-of-Band Emissions	Pass	
2.1051 27.53(c) 27.53(e) 27.53(f) 27.53(g)	Conducted Spurious Emissions	Pass	
20.21(e)(8)(i)(A) 20.21(e)(8)(I)	Noise Limits	N/A	Per the test data on page 32, the noise is below -70dBm/MHz ("Transmit Power OFF Mode"), therefore is by default compliant to the Variable Uplink Noise Power Tests, Variable Downlink Noise Power Tests, and Noise timing tests. These tests are not applicable.
20.21(e)(8)(i)(I)	Uplink Inactivity	N/A	per rule 20.21e... if noise is less than -70dBm/MHz ("Transmit Power OFF Mode") then EUT will not shut off, therefore this test will not be performed
20.21(e)(8)(i)(C)(1) 20.21(e)(8)(i)(C)(H) 20.21(e)(8)(i)(C)(2)(i)(Fixed) 20.21(e)(8)(i)(C)(2)(ii)(Fixed)	Variable Gain	Pass	
2.1049	Occupied Bandwidth	Pass	
20.21(e)(8)(ii)(A)	Oscillation Detection	Pass	
2.1053	Radiated Spurious	Pass	
20.21(e)(8)(i)(B)	Spectrum Block Filtering	N/A	This only applies to devices utilizing spectrum block filtering



Authorized Frequency Band

Name of Test:

Authorized Frequency Band

Engineer: Mike Graffeo

Test Equipment Utilized:

i00331 and i00405

Test Date: 4/17/14

Test Procedure

The EUT was connected to a spectrum analyzer through an attenuator with the losses being input into the spectrum analyzer as a combination of reference level offset and correction factor as needed to ensure accurate readings. A signal generator was utilized to produce a CW input signal tuned to the center channel of the operational band. The RF input level was increased to a point just prior to the AGC being in control of the power. The Signal generator was set to sweep across 2X the operational band of the EUT while the spectrum analyzer was set to MAX HOLD. Two markers were placed at the edges of the operational band and a third marker was placed at the highest point within the band no closer than 2.5 MHz from the band edge.

Test Setup

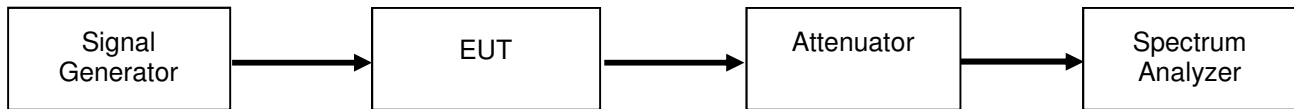



Uplink Test Plot 776 - 787 MHz Band

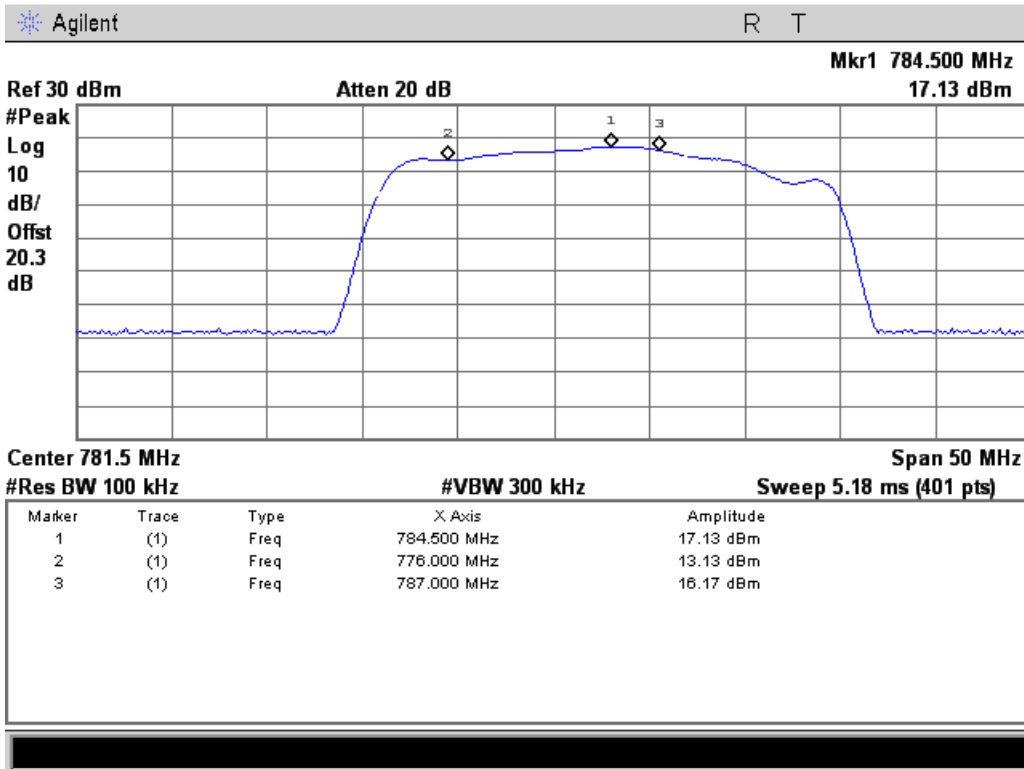

Downlink Test Plot 746 - 757 MHz Band

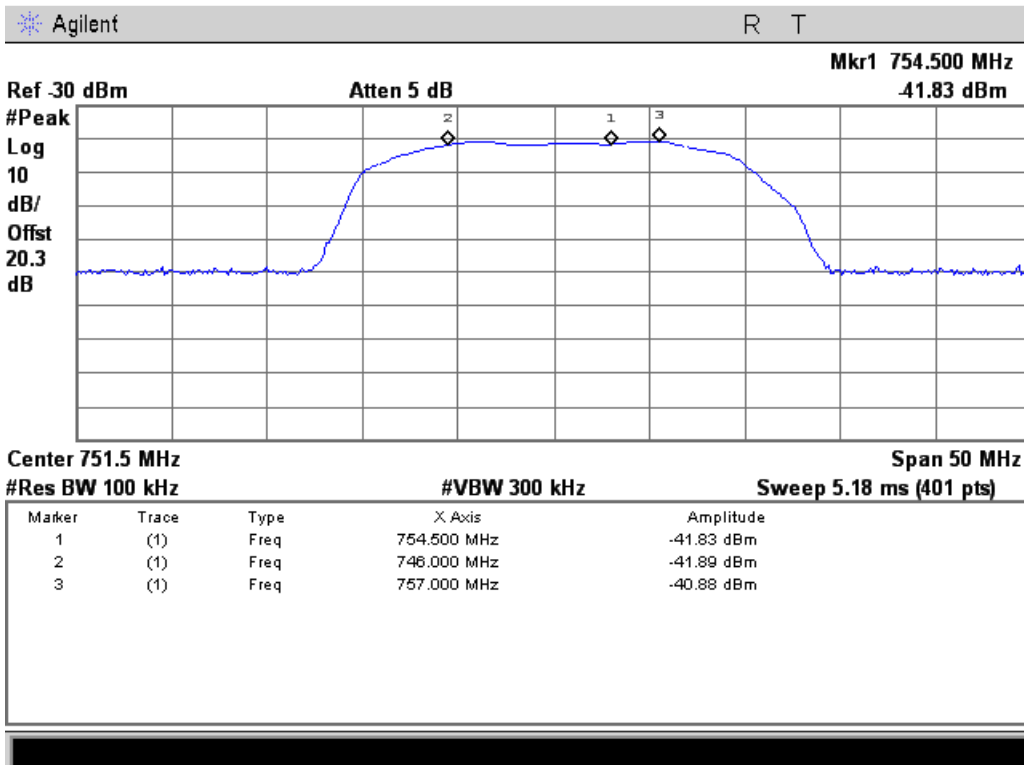



Maximum Power and Gain

Name of Test: Maximum Power and Gain

Test Equipment Utilized: i00331 and i00405

Engineer: Mike Graffeo

Test Date: 4/17/14

Test Procedure

The EUT was connected to a spectrum analyzer through an attenuator with the losses being input into the spectrum analyzer as a combination of reference level offset and correction factor as needed to ensure accurate readings. The spectrum analyzer and signal generator were tuned to the frequency with the highest power level in the band, as determined by the Authorized Frequency Band test. The RF input level was increased to a point just prior to the AGC being in control of the power for both pulsed single time slot GSM modulation and 4.1 MHz AWGN modulation. The maximum power was measured and verified to meet the minimum and maximum levels allowed, with the maximum gain being computed from these values. The uplink and downlink gain under each condition were verified to be within 9 dB of each other.

The following formula was used for calculating the gain limits.

$$\text{Gain Limit (dB)} = 6.5 \text{ dB} + 20\text{Log}(F_{\text{MHz}})$$

F_{MHz} is the uplink mid-band frequency with the downlink gain limit being equivalent to the paired Uplink band gain limit.

Test Setup

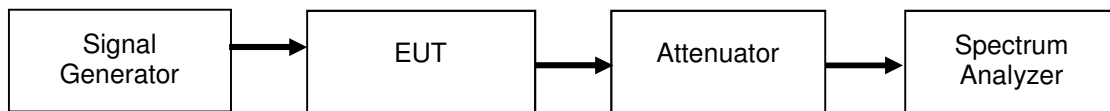



Uplink Power Test Results

Frequency Band (MHz)	Input Level (dBm)	Output Power (dBm)	Lower Limit (dBm)	Upper Limit (dBm)	Result
776 - 787 MHz Pulsed GSM	4.3	18.6	17	30	Pass
776 - 787 MHz AWGN	3.5	18.5	17	30	Pass

Downlink Power Test Results

Frequency Band (MHz)	Input Level (dBm)	Output Power (dBm)	Upper Limit (dBm)	Result
746 - 757 MHz Pulsed GSM	-51.1	-36.8	17	Pass
746 - 757 MHz AWGN	-51.5	-36.5	17	Pass

Uplink and Downlink Gain Test Results

Modulation	Uplink Frequency (MHz)	Downlink Frequency (MHz)	Uplink Gain (dB)	Uplink Limit (dB)	Downlink Gain (dB)	Downlink Limit (dB)	Delta (dB)	Limit (dB)	Margin (dB)
Pulsed CW	784.5	754.5	14.3	15	14.4	15	0.09	9	-8.91
AWGN	784.5	754.5	15.0	15	15.0	15	0.02	9	-8.98



Intermodulation

Name of Test: Intermodulation
Test Equipment Utilized: i00331, i00405, i00412

Engineer: Mike Graffeo
Test Date: 4/17/2014

Test Procedure

The EUT was connected to a spectrum analyzer through an attenuator. Two signal generators were utilized to produce two CW signals 600 kHz apart and centered in the operational band. Attenuator and cable insertion loss correction factors were input to either the signal generator or the spectrum analyzer as required to ensure that accurate measurements were recorded. The input power was set at the maximum allowable power and the RMS intermodulation products were measured to ensure they were less than -19 dBm in a 3 kHz RBW. The uplink and downlink intermodulation products were plotted, with the levels being listed in the summary tables.

Test Setup

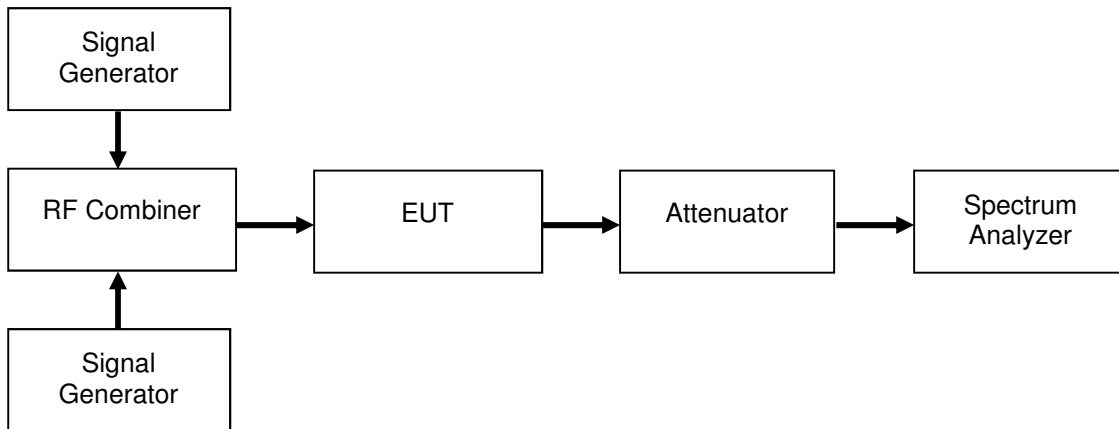

Uplink Test Results

Frequency Band (MHz)	Intermodulation Level (dBm)	Limit (dBm)	Result
776 - 787 MHz	-28.32	-19	Pass

Downlink Test Results

Frequency Band (MHz)	Intermodulation Level (dBm)	Limit (dBm)	Result
746 - 757 MHz	-88.56	-19	Pass



Uplink Test Plots

776 - 787 MHz Band

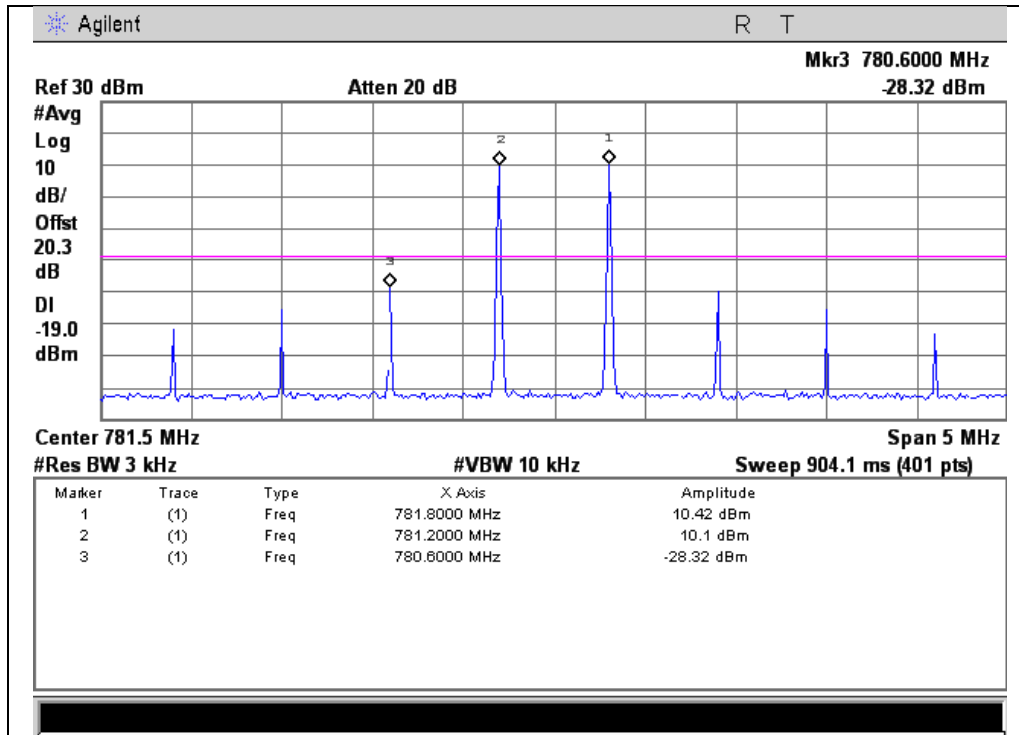

Downlink Test Plots

746 - 757 MHz Band

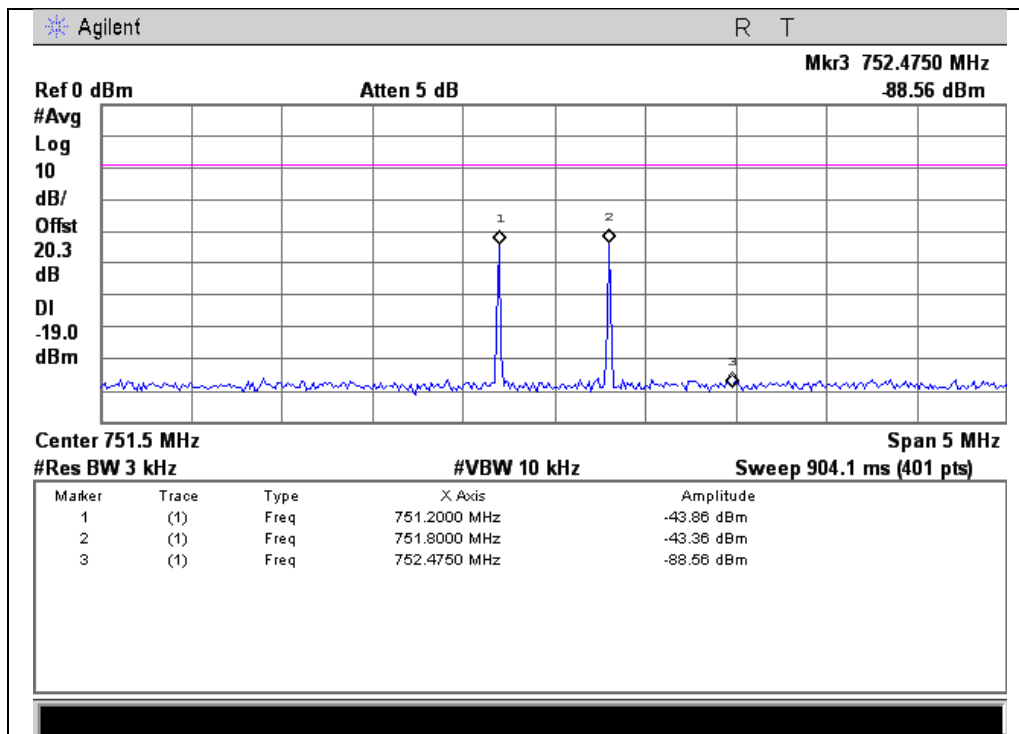



Out-of-Band Emissions

Name of Test:

Out-of-Band Emissions

Engineer: Mike Graffeo

Test Equipment Utilized:

i00331 and i00405

Test Date: 4/18/14

Test Procedure

The EUT was connected to a spectrum analyzer through an attenuator with the losses being input into the spectrum analyzer as a combination of reference level offset and correction factor in order to ensure accurate readings. A signal generator was utilized to produce the following signals: GSM, CDMA, and WCDMA. The signal generator was tuned to the lowest allowable upper and lower channel within the EUT operational band for each respective modulation type. The RF input level was increased to a point just prior to the AGC being in control of the power. For each modulation type the Out of Band Emissions were measured to ensure they met the limits.

The following formula was used for calculating the limits:

$$\text{Limit} = P1 - 6 - (43 + 10\text{Log}(P2)) = -19\text{dBm}$$

P1 = power in dBm

P2 = power in Watts

Test Setup

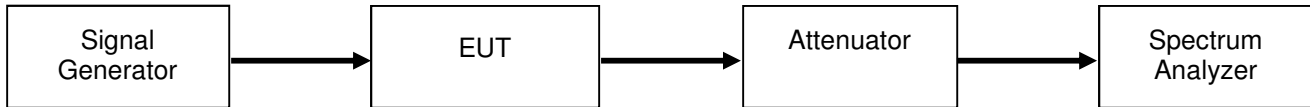



GSM Uplink Test Results

Frequency Band (MHz)	Band Edge	Measured Level (dBm)	Limit (dBm)	Result
776 - 787	Lower	-27.59	-19	Pass
776 - 787	Upper	-25.83	-19	Pass

CDMA Uplink Test Results

Frequency Band (MHz)	Band Edge	Measured Level (dBm)	Limit (dBm)	Result
776 - 787	Lower	-77.47	-19	Pass
776 - 787	Upper	-41.72	-19	Pass

WCDMA Uplink Test Results

Frequency Band (MHz)	Band Edge	Measured Level (dBm)	Limit (dBm)	Result
776 - 787	Lower	-46.13	-19	Pass
776 - 787	Upper	-42.99	-19	Pass



GSM Downlink Test Results

Frequency Band (MHz)	Band Edge	Measured Level (dBm)	Limit (dBm)	Result
746 - 757	Lower	-78.40	-19	Pass
746 - 757	Upper	-76.34	-19	Pass

CDMA Downlink Test Results

Frequency Band (MHz)	Band Edge	Measured Level (dBm)	Limit (dBm)	Result
746 - 757	Lower	-77.18	-19	Pass
746 - 757	Upper	-77.50	-19	Pass

WCDMA Downlink Test Results

Frequency Band (MHz)	Band Edge	Measured Level (dBm)	Limit (dBm)	Result
746 - 757	Lower	-78.14	-19	Pass
746 - 757	Upper	-77.47	-19	Pass



GSM Uplink Test Plots

776 - 787 MHz Band

Lower Band Edge

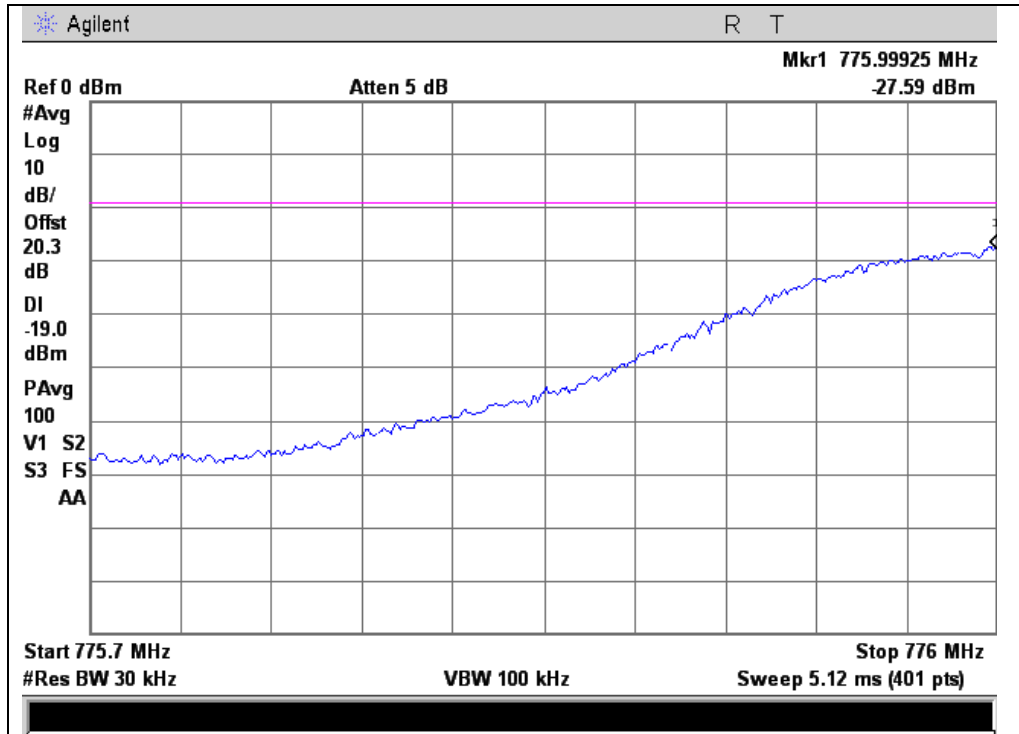

Upper Band Edge

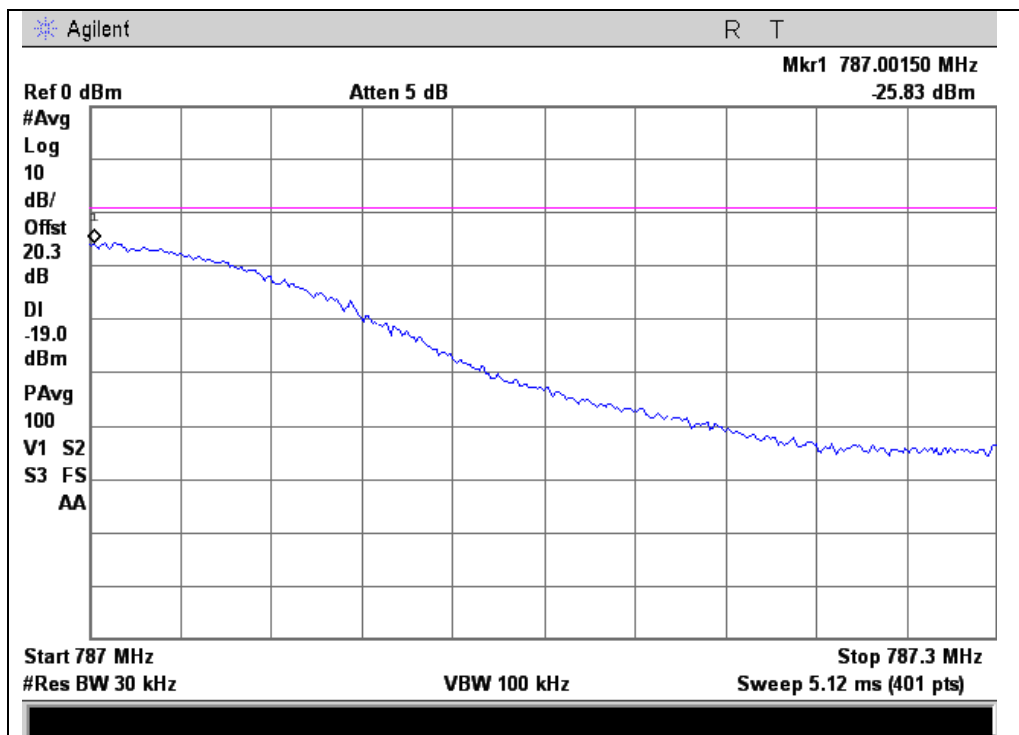



CDMA Uplink Test Plots

776 - 787 MHz Band

Lower Band Edge

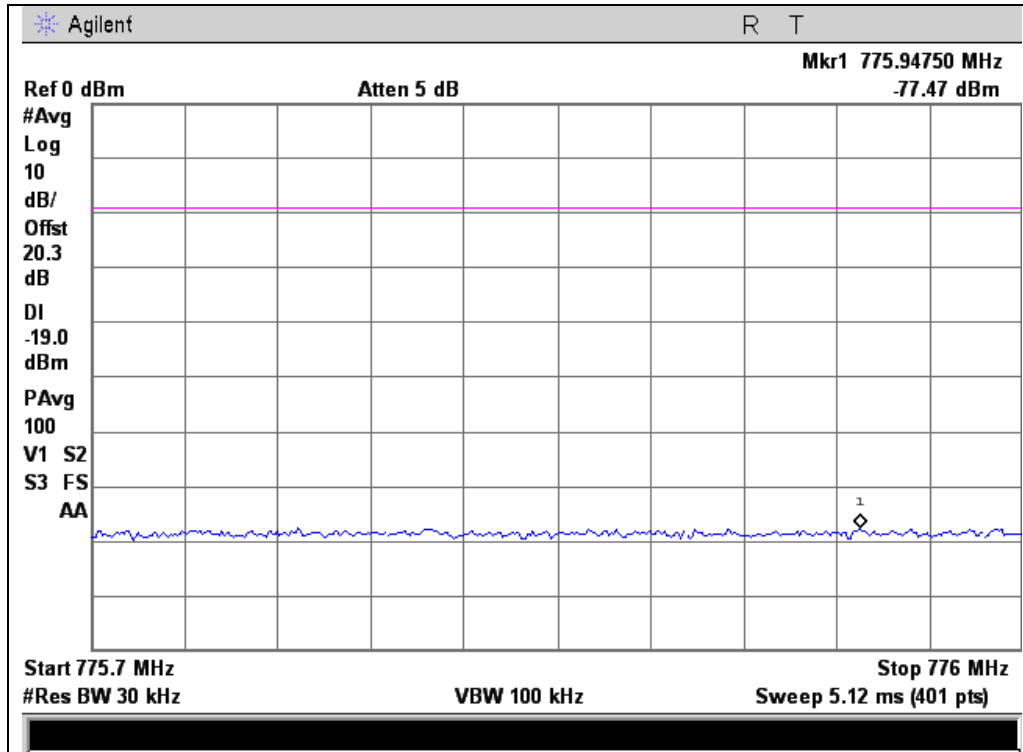

Upper Band Edge

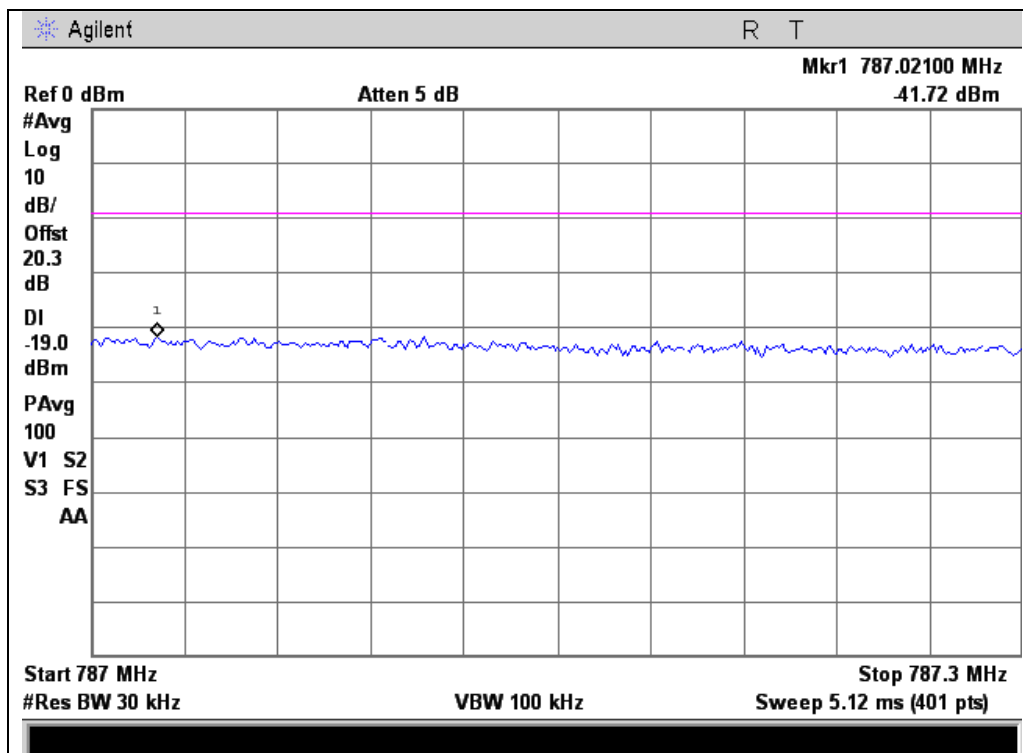



WCDMA Uplink Test Plots 776 - 787 MHz Band

Lower Band Edge

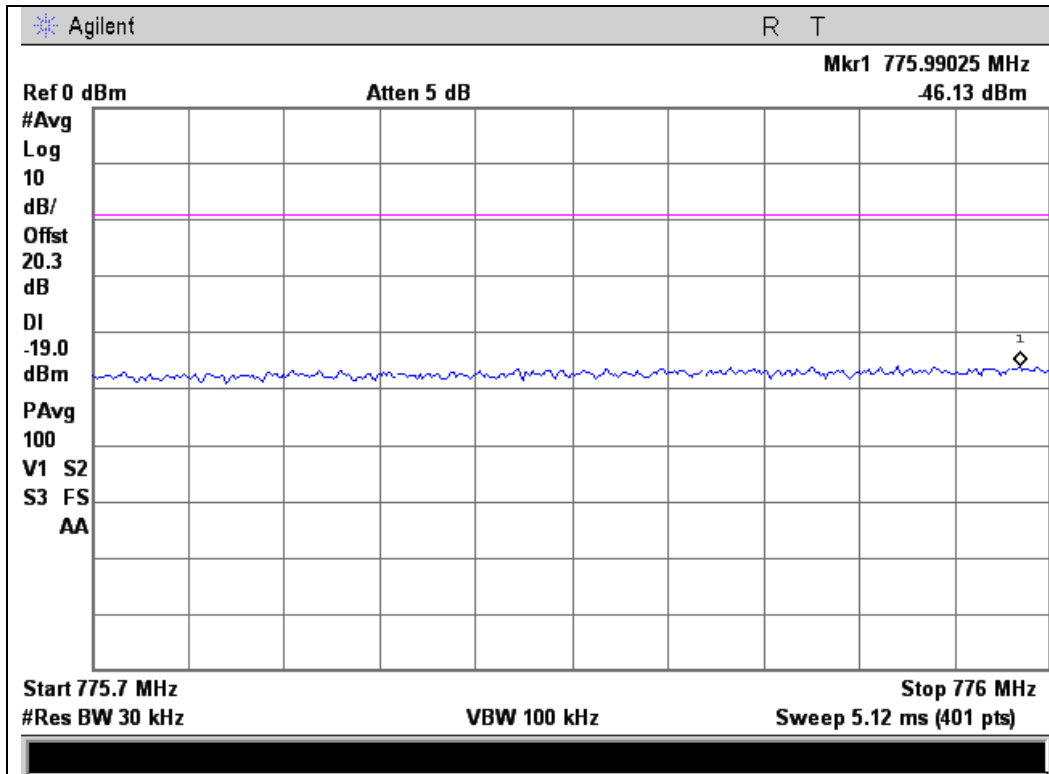

Upper Band Edge

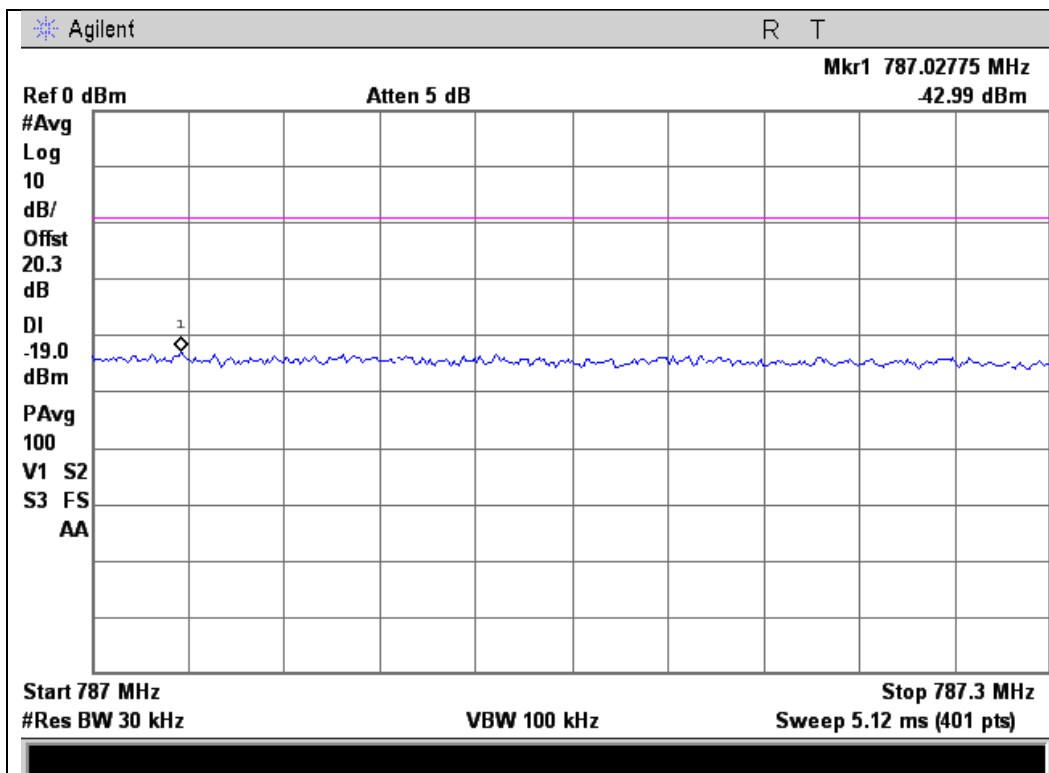



GSM Downlink Test Plots 746 - 757 MHz Band

Lower Band Edge

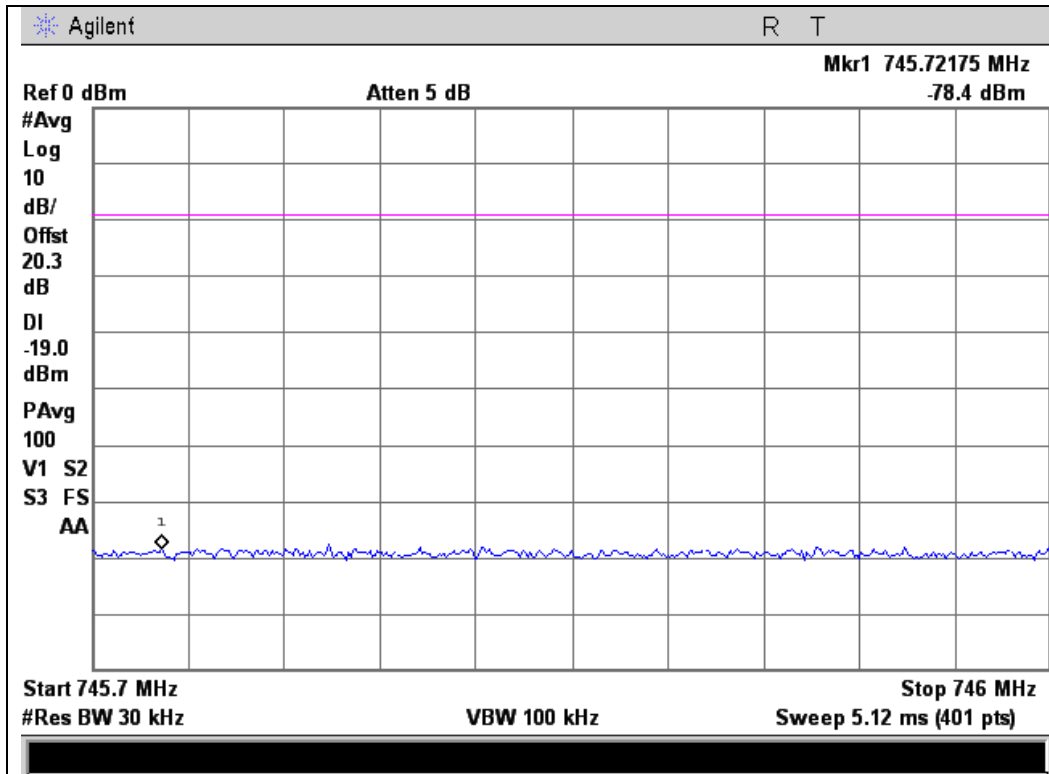

Upper Band Edge

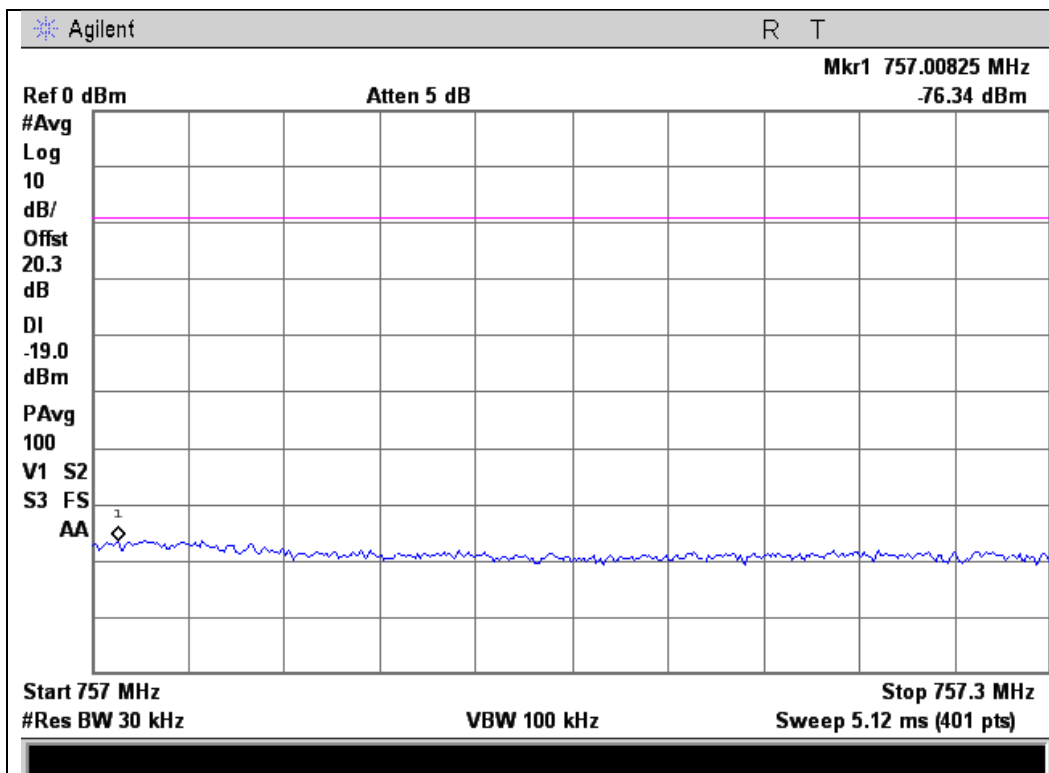



CDMA Downlink Test Plots

746 - 757 MHz Band

Lower Band Edge

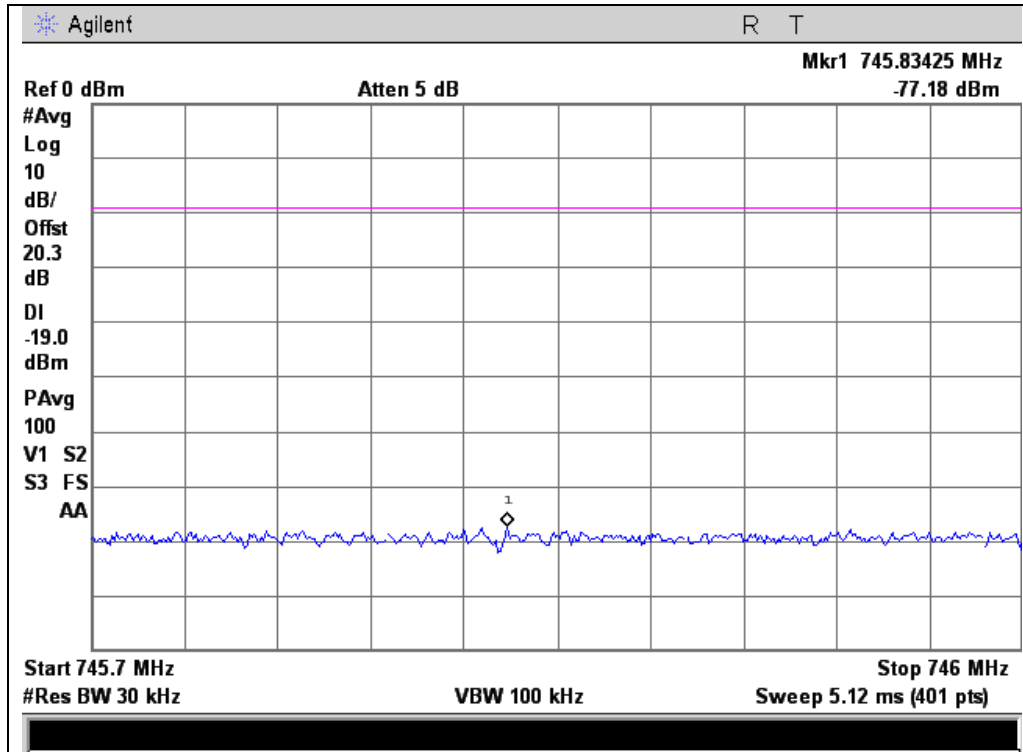

Upper Band Edge

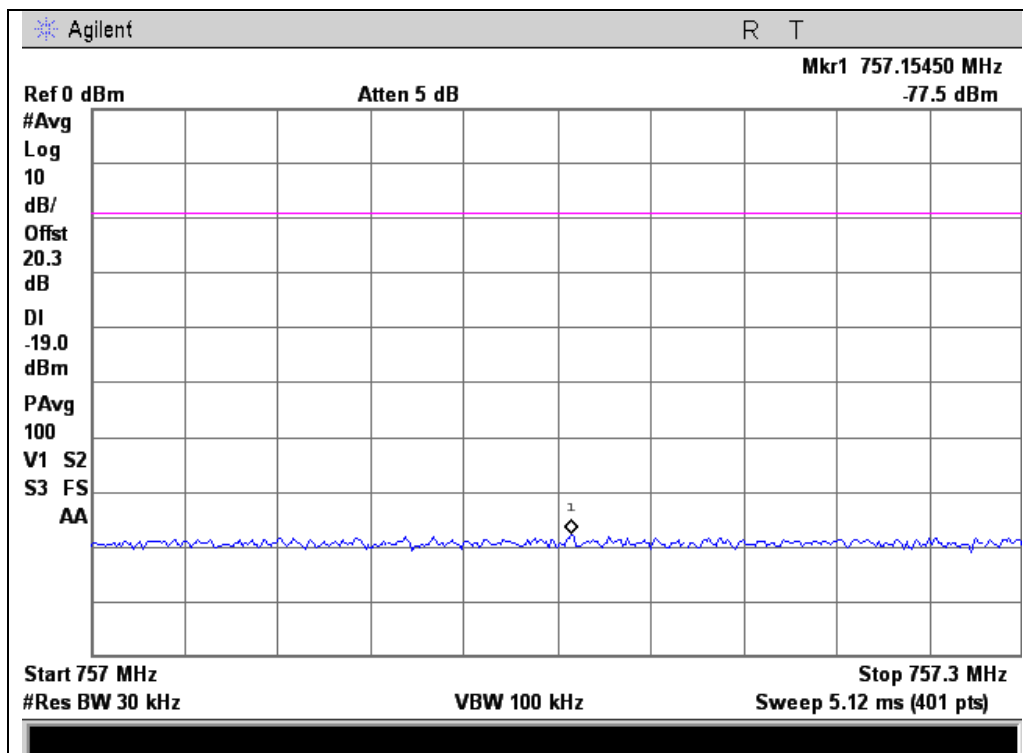



WCDMA Downlink Test Plots

746 - 757 MHz Band

Lower Band Edge

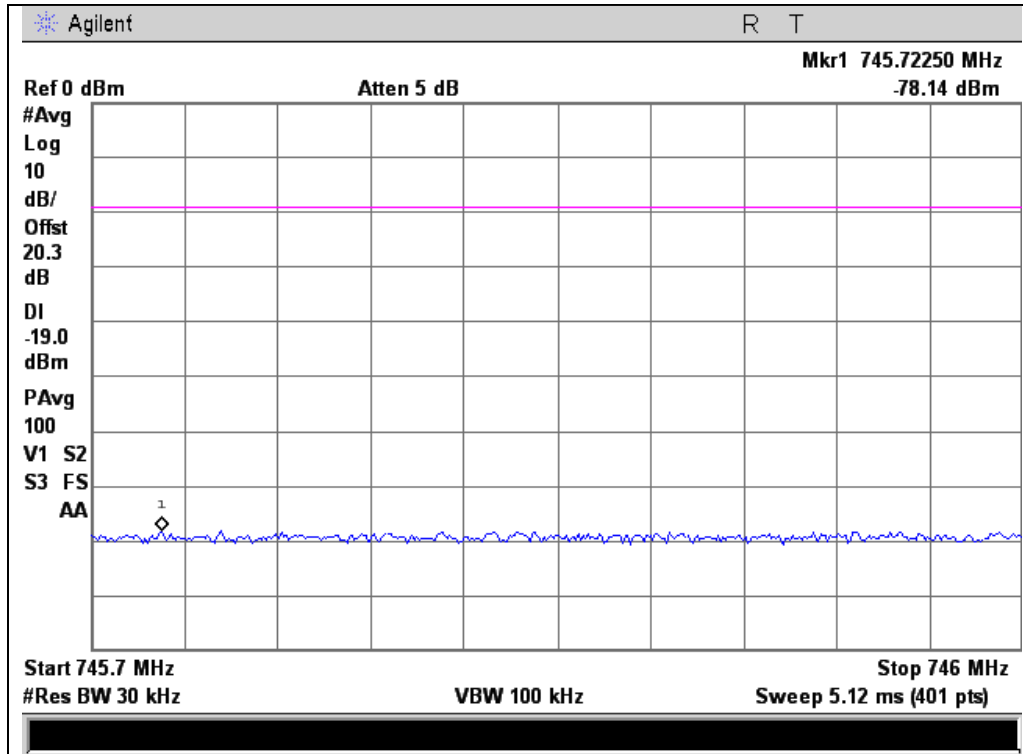

Upper Band Edge

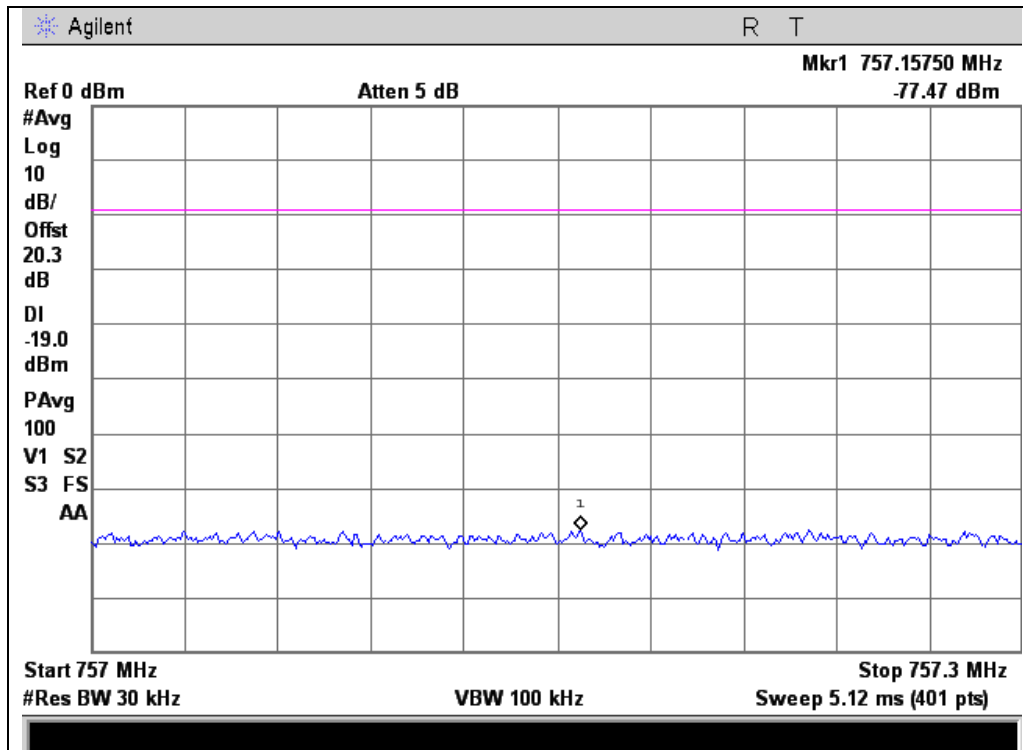



Conducted Spurious Emissions

Name of Test: Conducted Spurious Emissions

Test Equipment Utilized: i00331 and i00405

Engineer: Mike Graffeo

Test Date: 4/18/2014

Test Procedure

The EUT was connected to a spectrum analyzer through an attenuator, with the losses being input into the spectrum analyzer as a combination of reference level offset and correction factor as needed to ensure accurate readings. A signal generator was utilized to produce a 4.1 MHz AWGN signal operating at the maximum allowable power. The conducted spurious emissions from 9 kHz to 10 times the highest tunable frequency for each operational band were measured (excluding the band defined by the Out of band emissions test). The emissions were plotted and the highest level was recorded in the summary table.

The following formulas are used for calculating the limits.

$$\text{Conducted Spurious Emissions Limit} = P1 - (43 + 10\text{Log}(P2)) = -13 \text{ dBm}$$

P1 = power in dBm

P2 = power in Watts

Test Setup

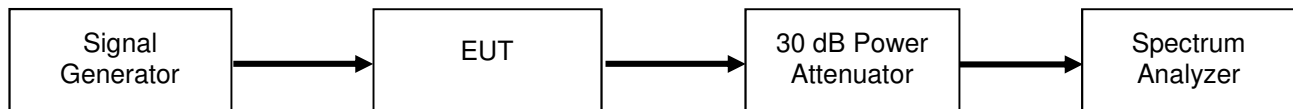

Uplink Test Results

Frequency Band (MHz)	Measured Frequency (MHz)	Measured Level (dBm)	Limit (dBm)	Result
776 - 787	2342.7	-46.2	-13	Pass

Downlink Test Results

Frequency Band (MHz)	Measured Frequency (MHz)	Measured Level (dBm)	Limit (dBm)	Result
746 - 757	2999.5	-57.21	-13	Pass



For the 746 – 758 downlink and 776 – 788 Uplink bands of operation, the following additional spurious emissions requirements apply.

FCC 27.53(c)

For operations in the 746-758 MHz band and the 776-788 MHz band, the power of any emission outside the licensee's frequency band(s) of operation shall be attenuated below the transmitter power (P) within the licensed band(s) of operation, measured in watts, in accordance with the following:

(3)On all frequencies between 763-775 MHz and 793-805 MHz, by a factor not less than $76 + 10 \log (P)$ dB in a 6.25 kHz band segment, for base and fixed stations

The test is performed using a 10 kHz RBW. Since the limit is referenced to a 6.25 kHz BW, the following correction factor is applied to the measured data.

BW correction Factor = $10\text{Log } B1/B2$

BW correction Factor = $10\text{Log } 6.25 / 10 = - 2.04 \text{ dB}$

Final Value (dBm) = conducted measurement +BW correction factor

776 – 787 MHz Uplink Band

Spurious Frequency Range (MHz)	Measured Frequency (MHz)	Measured Value (dB)	Bandwidth Correction Factor (dB)	Final Value (dBm)	Limit (dBm)	Margin (dB)
763 – 775	774.53	-58.33	-2.04	-60.37	-46	-14.37
793 – 805	793.11	-71.84	-2.04	-73.88	-46	-27.88

746 - 757 MHz Downlink Band

Spurious Frequency Range (MHz)	Measured Frequency (MHz)	Measured Value (dB)	Bandwidth Correction Factor (dB)	Final Value (dBm)	Limit (dBm)	Margin (dB)
763 – 775	764.7	-81.19	-2.04	-83.23	-46	-37.23
793 – 805	795.29	-81.61	-2.04	-83.65	-46	-37.65



FCC 27.53(f)

For operations in the 746-763 MHz, 775-793 MHz, and 805-806 MHz bands, emissions in the band 1559-1610 MHz shall be limited to -70 dBW/MHz equivalent isotropically radiated power (EIRP) for wideband signals, and -80 dBW EIRP for discrete emissions of less than 700 Hz bandwidth. For the purpose of equipment authorization, a transmitter shall be tested with an antenna that is representative of the type that will be used with the equipment in normal operation.

Since the limit is referenced to EIRP, the final data is computed using the Conducted Spurious Emission data and adding the BW correction factor and the final gain/loss data from the antenna kitting information supplied by the manufacturer.

For the Narrowband measurement, the test is performed using a 10 kHz RBW. Since the limit is referenced to a 700 Hz BW, the following correction factor is applied to the measured data.

$BW \text{ correction Factor} = 10\text{Log } B1/B2$

$BW \text{ correction Factor} = 10\text{Log } 700 / 10000 = - 11.55 \text{ dB}$

$\text{Final Value (dBm)} = \text{conducted measurement} + BW \text{ correction factor} + \text{final gain/loss from Antenna Kitting document}$

The Limit for discreet (narrowband) emissions is -80dBW (-50 dBm) in 700 MHz BW.

The Limit for (wideband Emissions) is -70 dBW (-40 dBm) in a 1 MHz BW

776 – 787 MHz Uplink Band

Spurious Frequency Range (MHz)	Measured Frequency (MHz)	Measured Value (dBm)	Bandwidth Correction Factor (dB)	Gain/Loss from Antenna Kitting Information (dB)	Final Value (dBm)	Limit (dBm)	Margin (dB)
1559 – 1610 (Wideband)	1562.79	-52.13	0.00	0.00	-52.13	-40	-12.13
1559 – 1610 (Narrowband)	1562.79	-73.07	-11.55	0.00	-84.62	-50	-34.62

746 - 757 MHz Downlink Band

Spurious Frequency Range (MHz)	Measured Frequency (MHz)	Measured Value (dBm)	Bandwidth Correction Factor (dB)	Gain/Loss from Antenna Kitting information (dB)	Final Value (dBm)	Limit (dBm)	Margin (dB)
1559 – 1610 (Wideband)	1605.81	-62.4	0.00	0.00	-62.40	-40	-22.40
1559 – 1610 (Narrowband)	1595.22	-82.31	-11.55	0.00	-93.86	-50	-43.86



Uplink Test Plots

776 - 787 MHz Band
30 kHz – 775.9 MHz

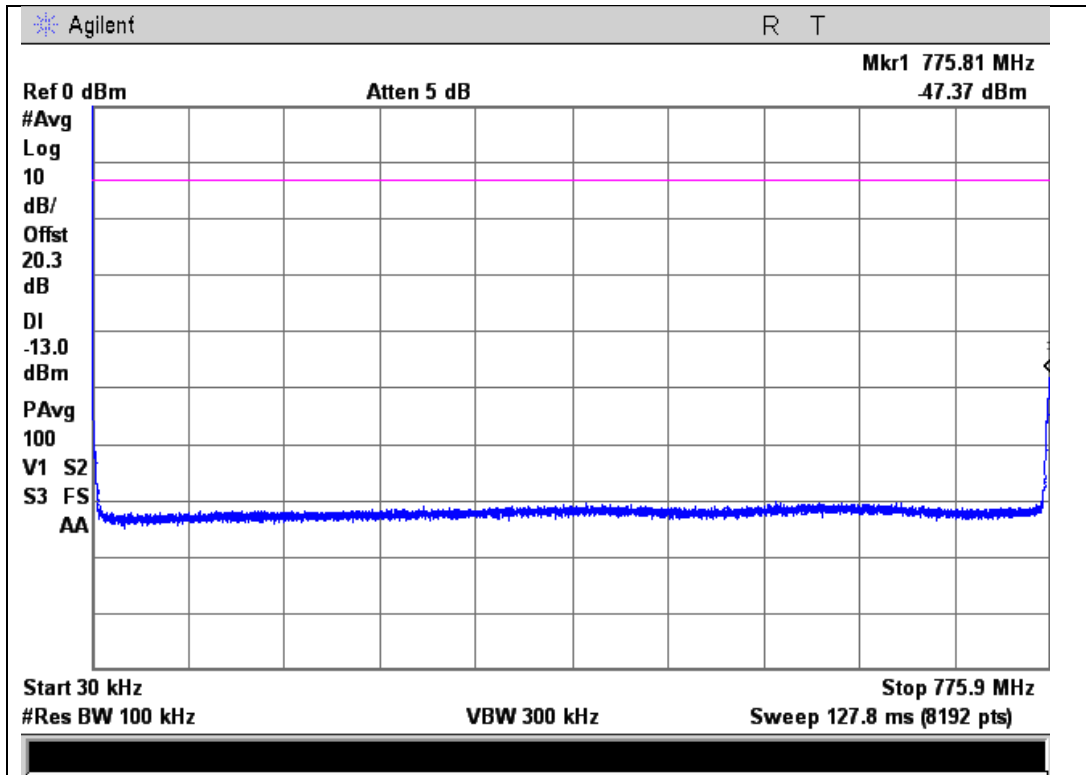

787.1 MHz – 7.87 GHz

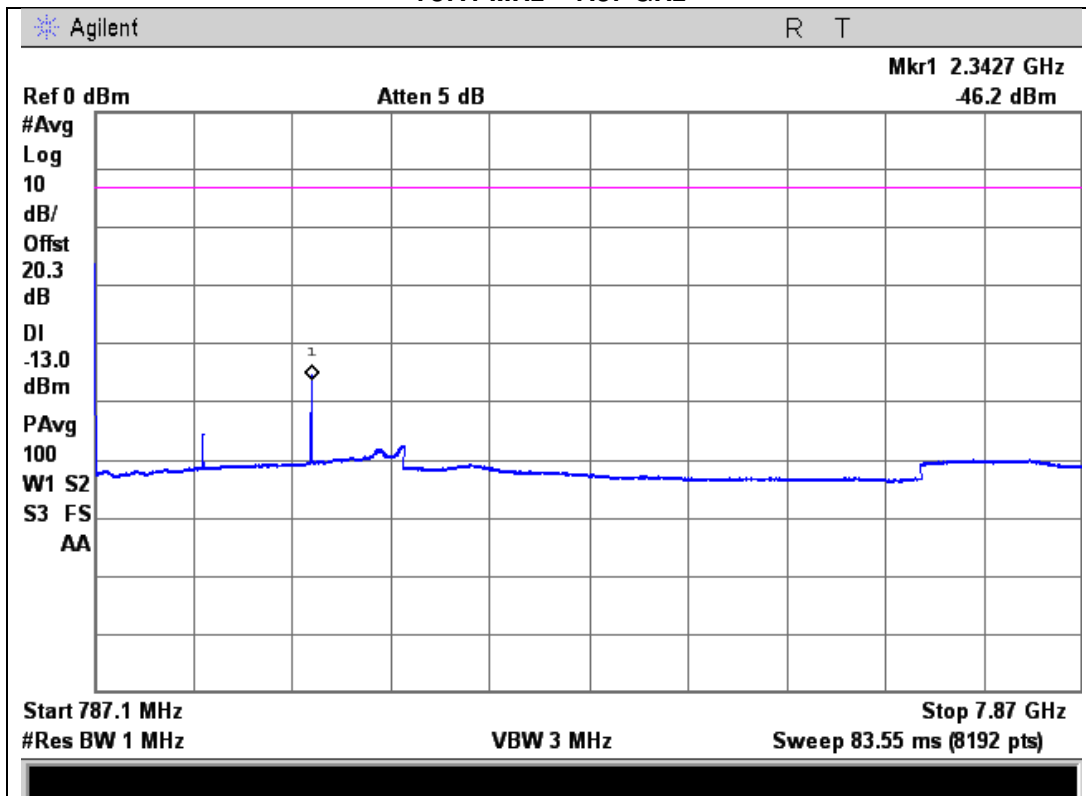



Downlink Test Plots 746 - 757 MHz Band

30 kHz – 745.9 MHz

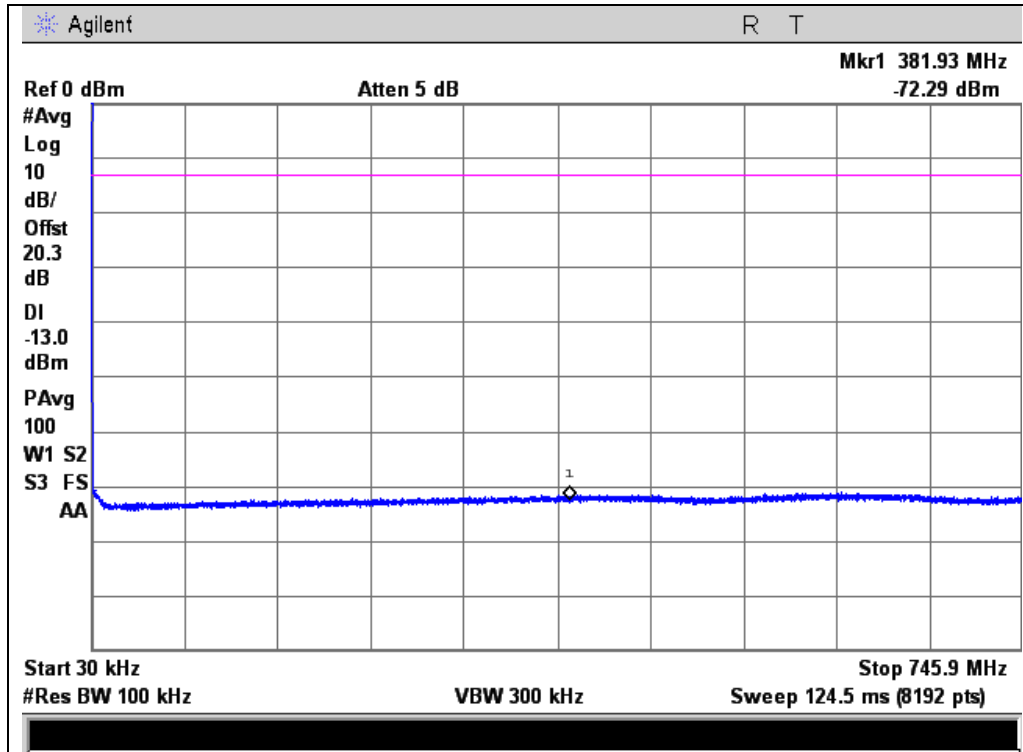

757.1 – 7.57 GHz

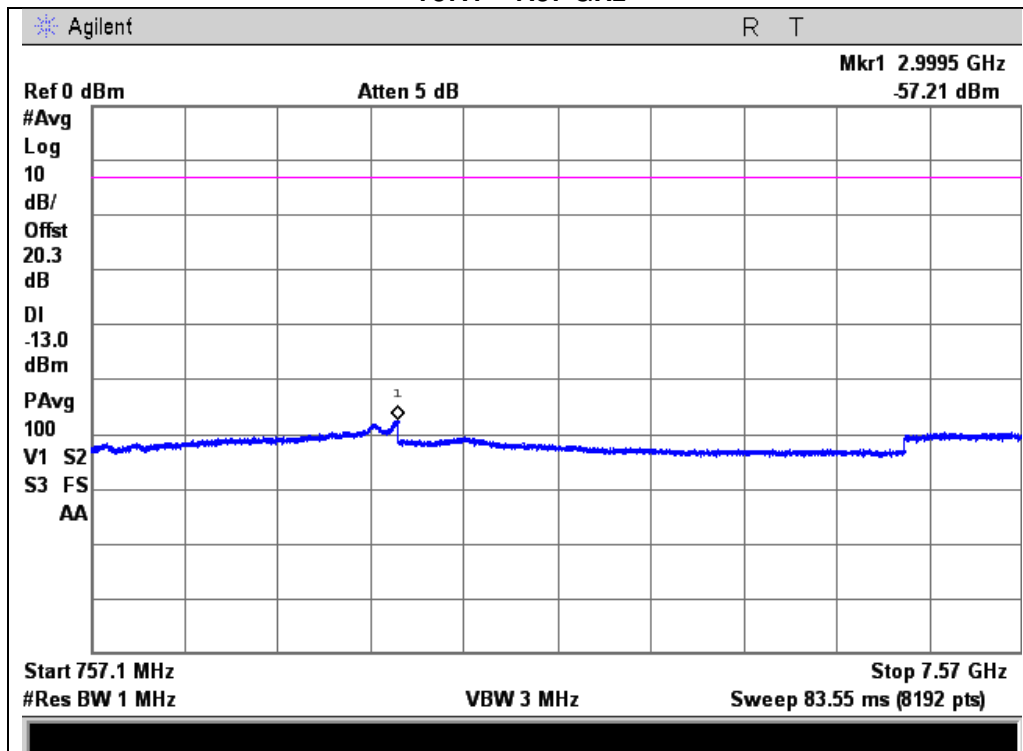



776 – 787 MHz Uplink Test Plots for the

763 - 775 MHz Frequency Range

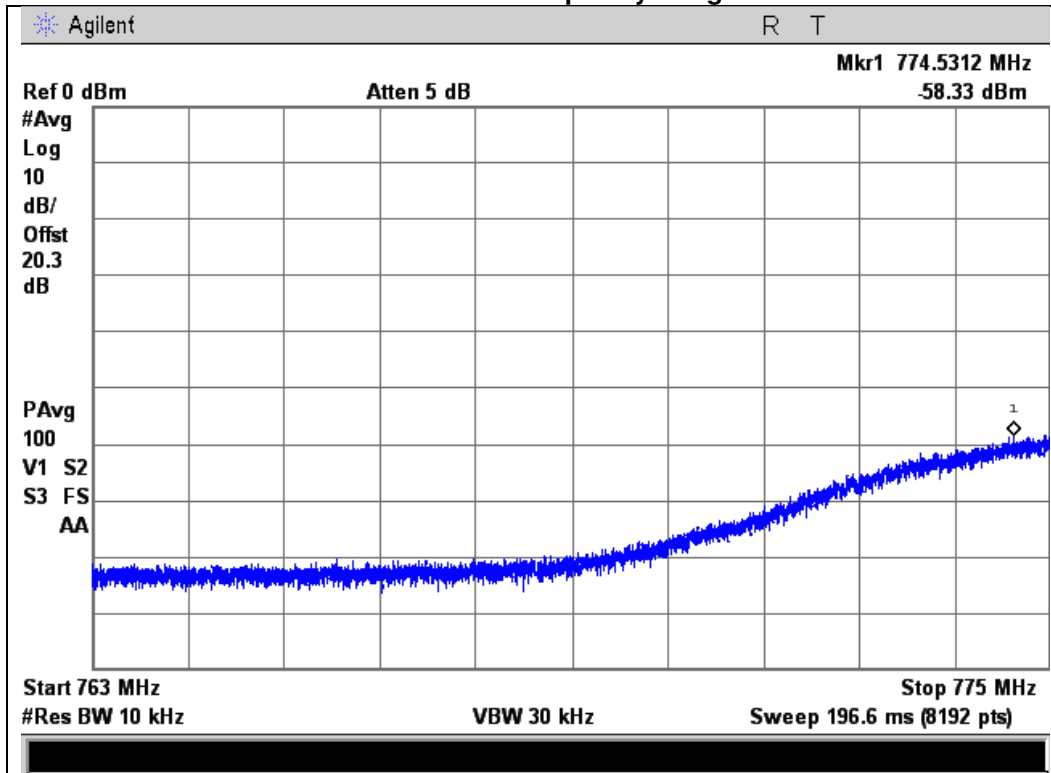

793 - 805 MHz Frequency Range

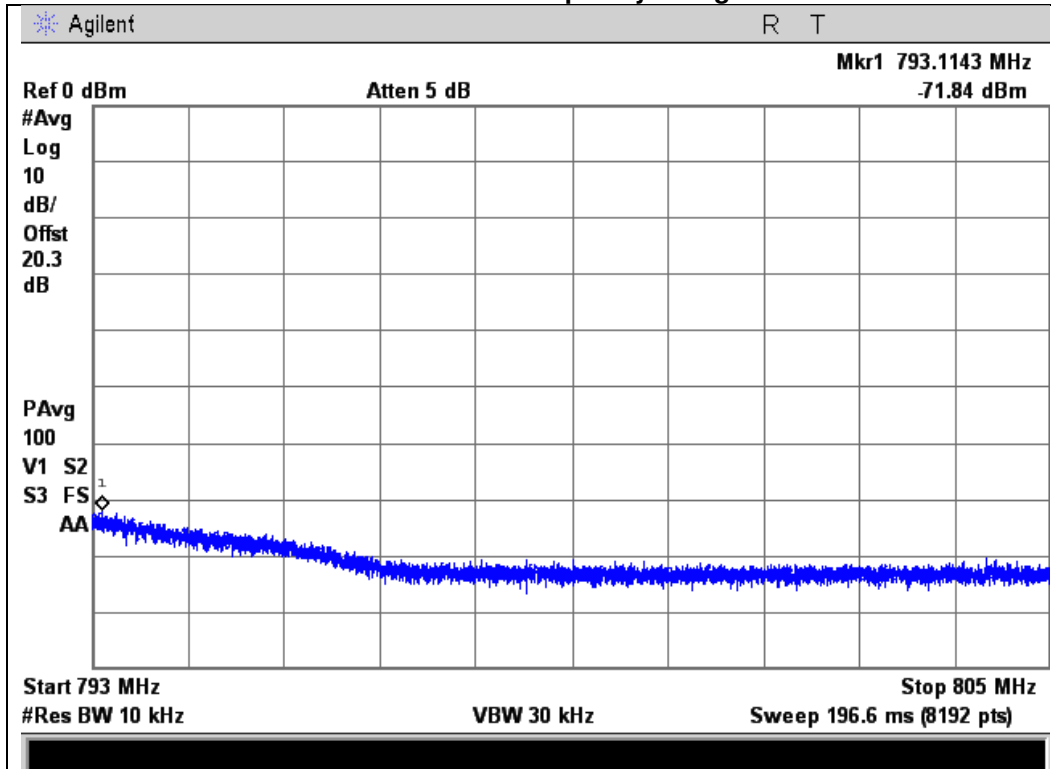



776 – 787 MHz Uplink Test Plots for the

1559 - 1610 MHz Frequency Range (Wideband)

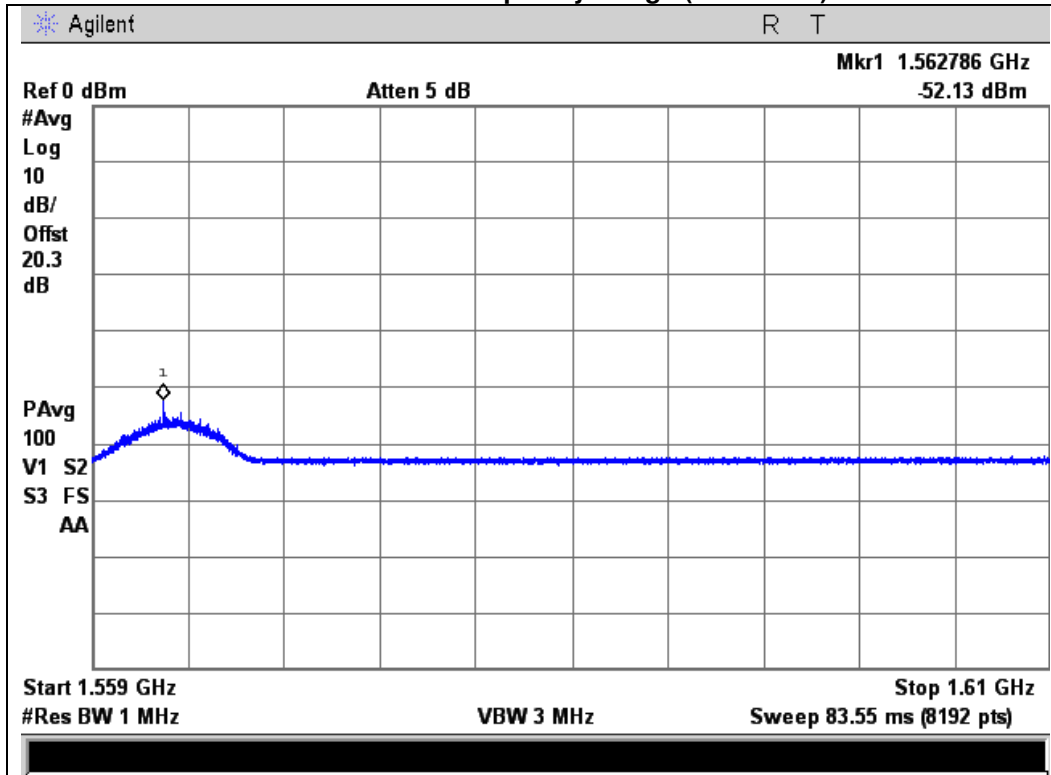

1559 - 1610 MHz Frequency Range (Narrowband)

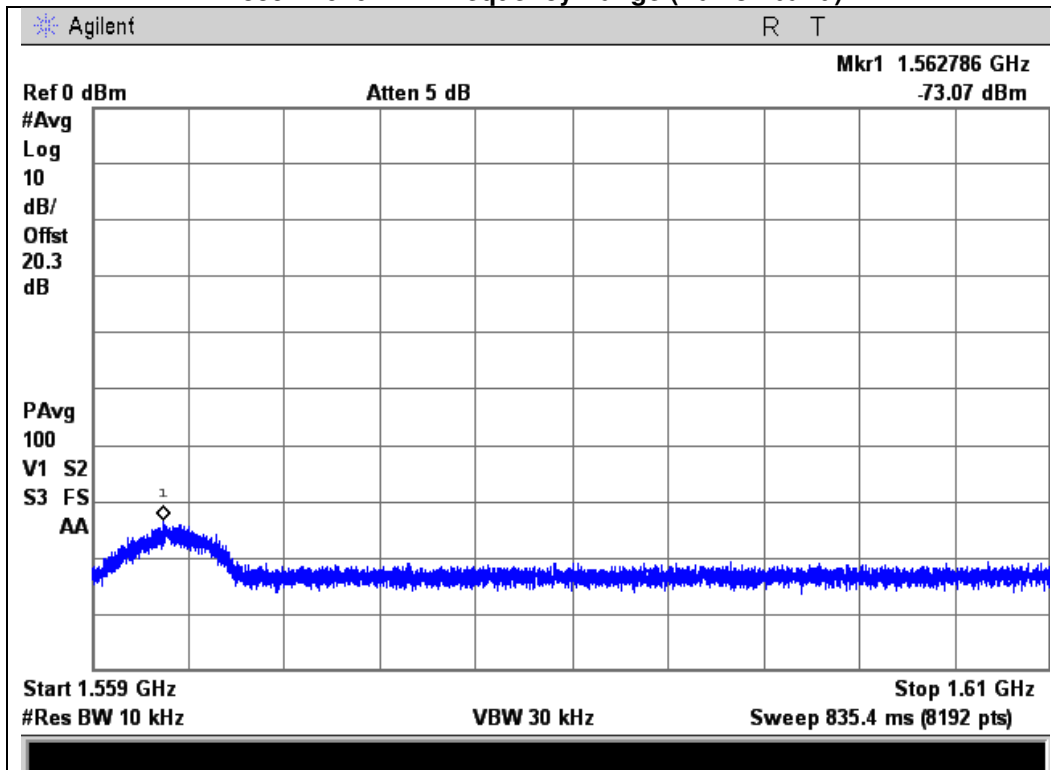



746 – 757 MHz Downlink Test Plots for the

763 - 775 MHz Frequency Range

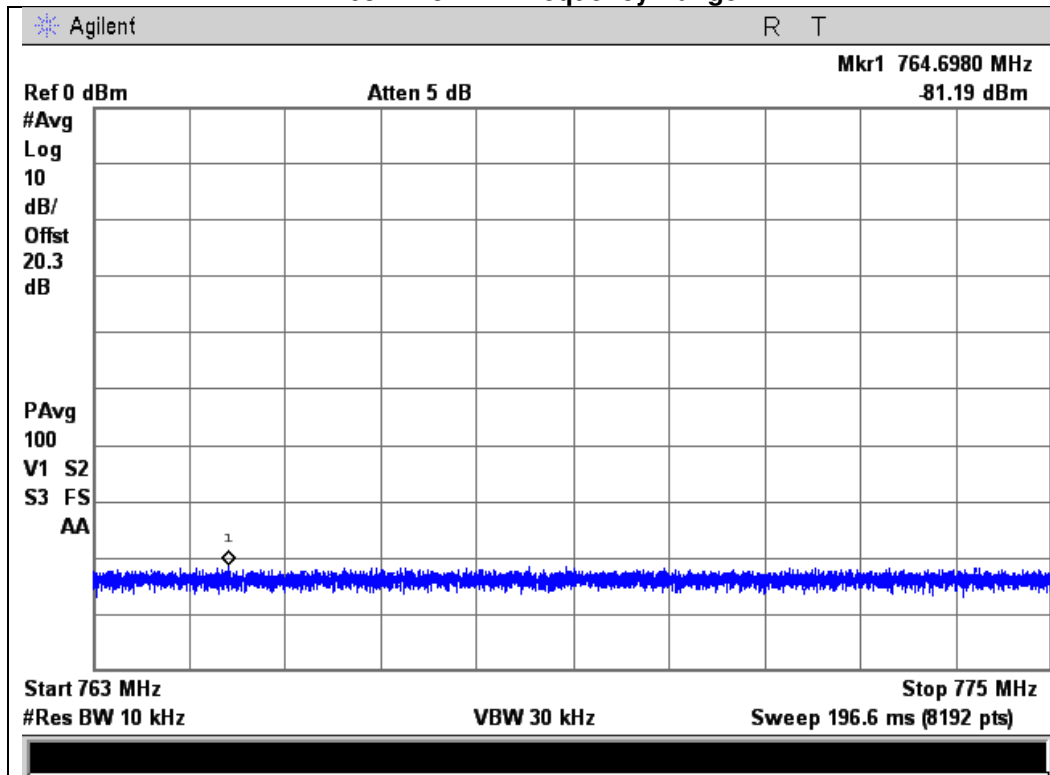

793 - 805 MHz Frequency Range

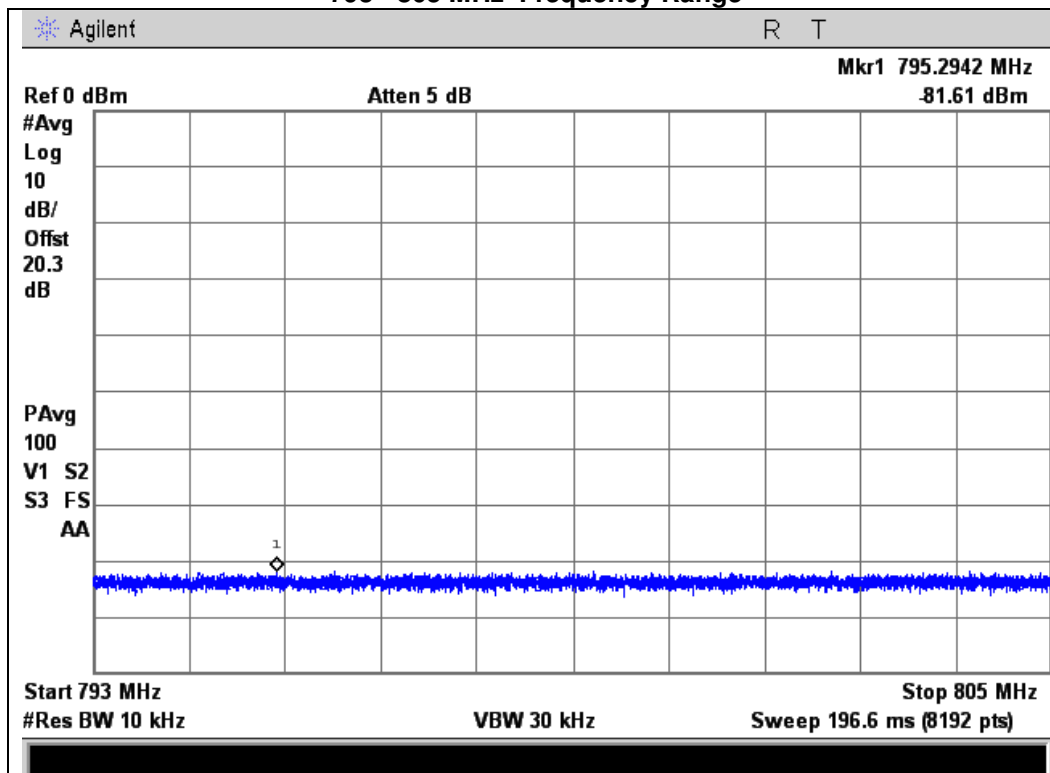



746 – 757 MHz Downlink Test Plots for the

1559 - 1610 MHz Frequency Range (Wideband)

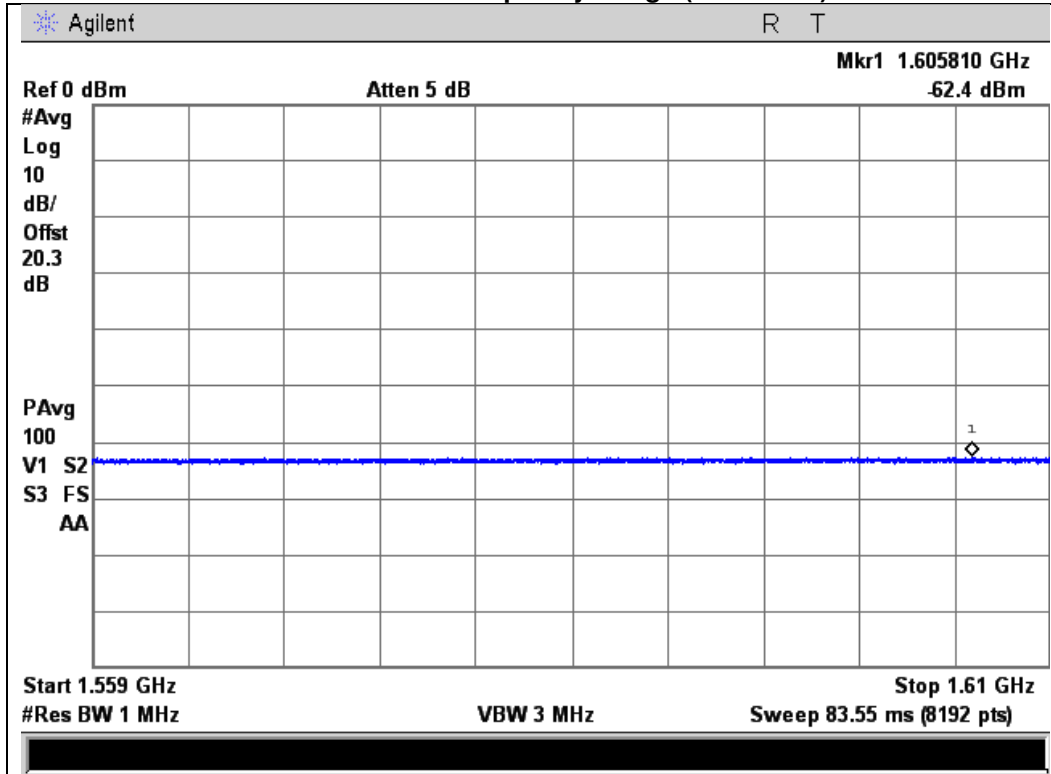

1559 - 1610 MHz Frequency Range (Narrowband)

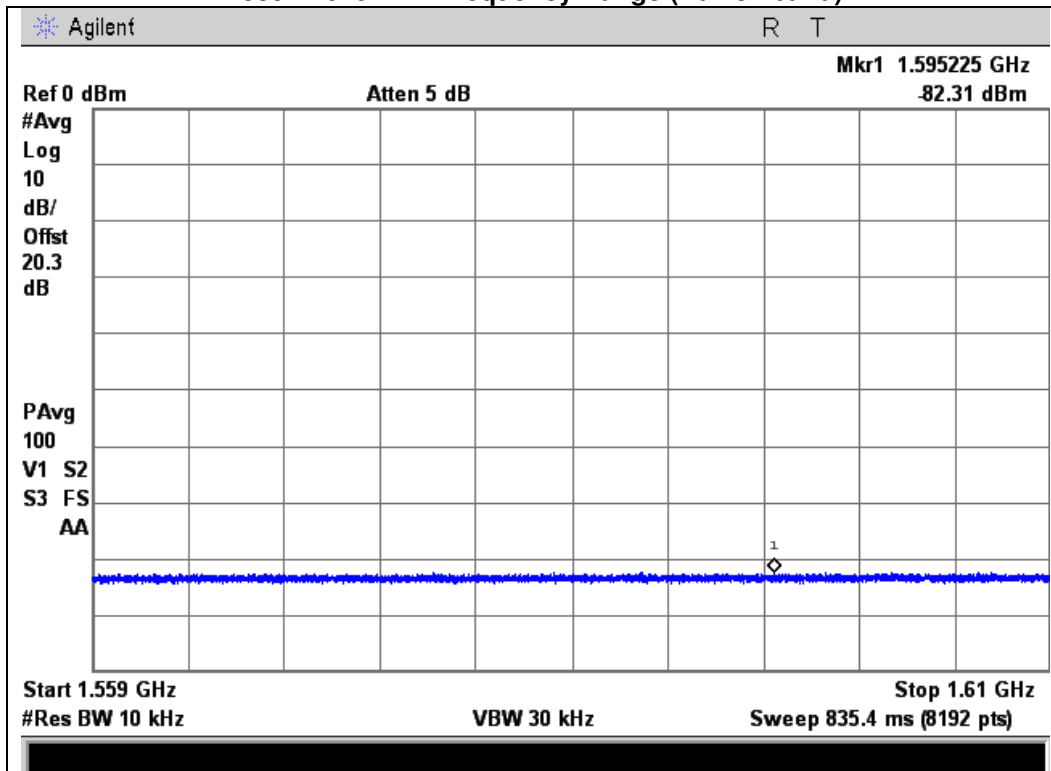



Noise Limits

Name of Test: Noise Limits
Test Equipment Utilized: i00331, i00405, i00412

Engineer: Mike Graffeo
Test Date: 4/17/2014

Test Procedure

The EUT was connected to a spectrum analyzer through an attenuator with the losses being input into the spectrum analyzer as a combination of reference level offset and correction factor as necessary to ensure that accurate readings were obtained. A series of three tests were performed: the maximum uplink and downlink noise, the variable noise for the uplink and downlink in the presence of a downlink signal, and the variable uplink noise timing. The detailed procedures from KDB 935210 D03 Wideband Consumer Signal Booster Measurement Guidance DR04-41516c were followed.

The following formulas are used for calculating the limits. Note – Downlink noise power limit is calculated with the CF of the associated uplink band.

Noise Power = $-102.5 + \text{LOG}_{10}(\text{Band Center Frequency}) * 20$

Test Setup

Uplink and Downlink Maximum Noise Power





Maximum Uplink Noise Test Results

Frequency Band (MHz)	Measured Noise (dBm)	Limit (dBm)	Margin (dB)	Result
776 - 787	-76.46	-44.6	-31.8	Pass

Maximum Downlink Noise Test Results

Frequency Band (MHz)	Measured Noise (dBm)	Limit (dBm)	Margin (dB)	Result
746 - 757	-86.34	-44.6	-41.7	Pass



Maximum Uplink Noise Test Plots

776 - 787 MHz Band

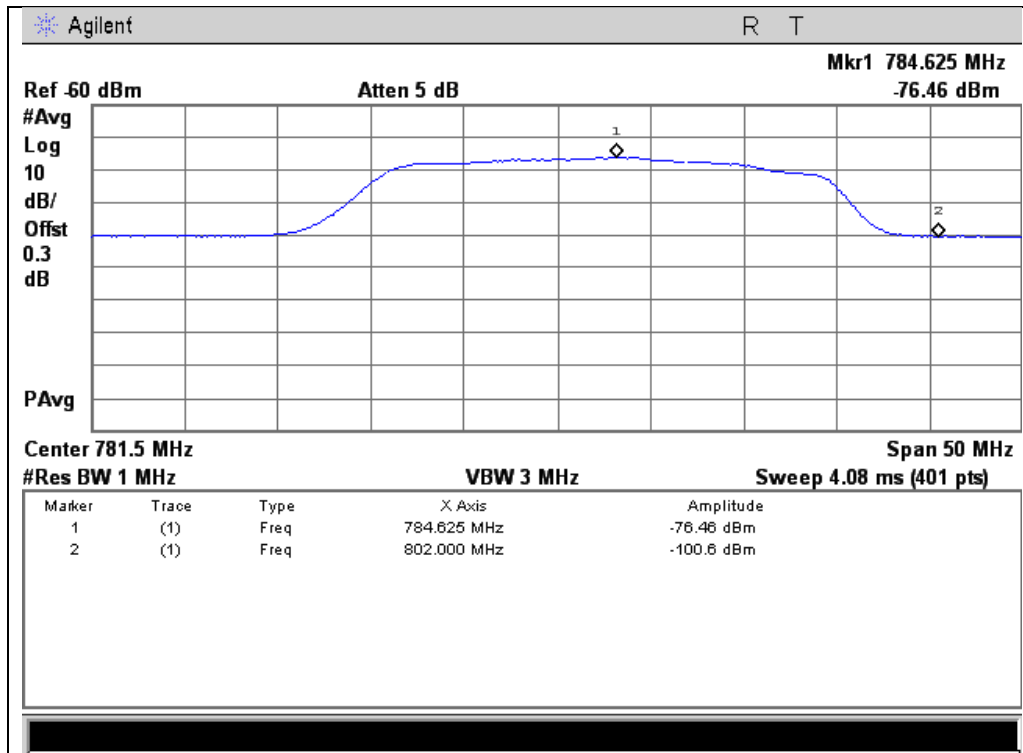

Maximum Downlink Noise Test Plots

746 - 757 MHz Band

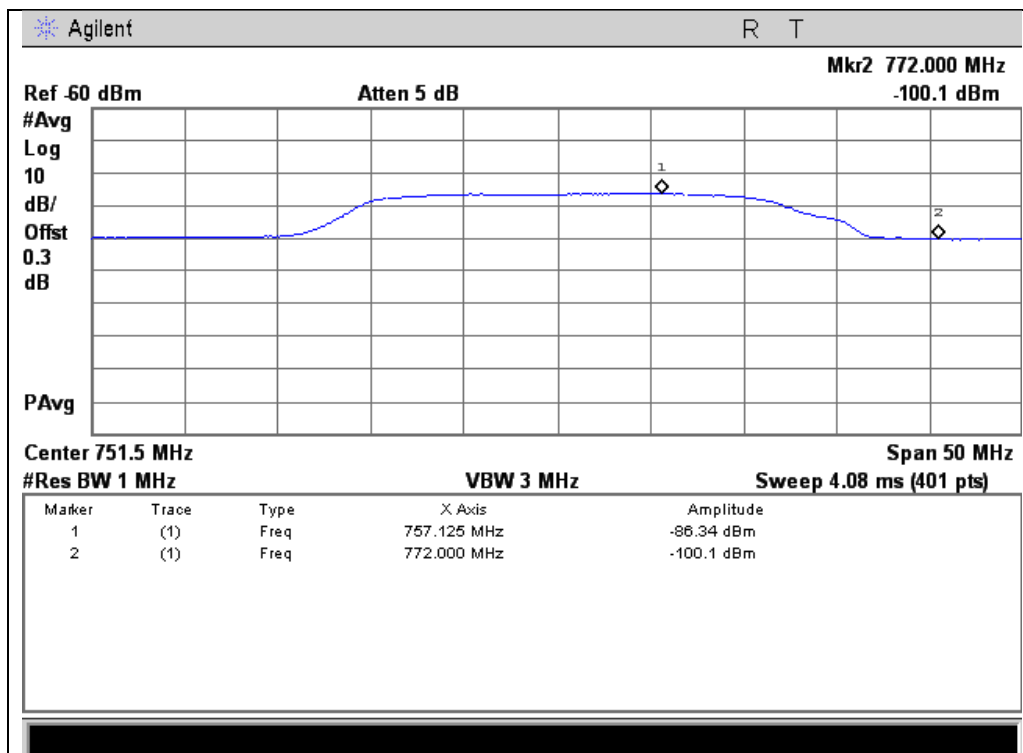



Variable Gain

Name of Test: Variable Gain
Test Equipment Utilized: i00331, i00405, i00412

Engineer: Mike Graffeo
Test Date: 4/18/2014

Test Procedure

The EUT was connected to a spectrum analyzer through an attenuator with the losses being input into the spectrum analyzer as a combination of reference level offset and correction factor in order to ensure accurate readings were obtained. The uplink gain in the presence of a downlink signal was measured for each operational uplink band using the detailed procedures from KDB 935210 D03 Wideband Consumer Signal Booster Measurement Guidance DR04-41516.

The following formula is used for calculating the limits:

$$\text{Variable Gain} = -34 \text{ dB} - \text{RSSI} + \text{MSCL}$$

Test Setup

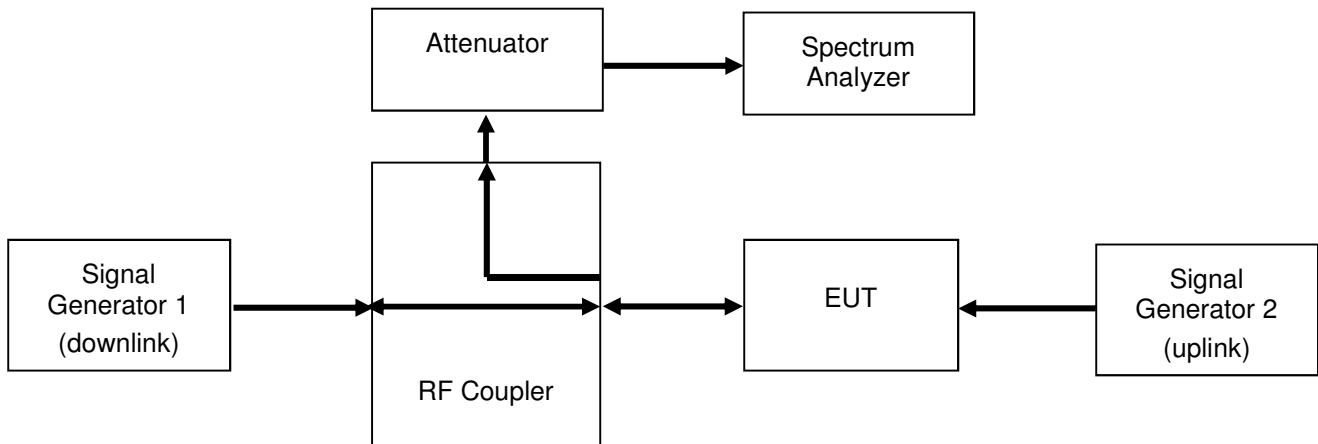



Uplink Test Results

776 - 787 MHz

RSSI (dBm)	MSCL (dB)	Gain Limit (dBm)	P(in) (dBm)	P(out) (dBm)	Gain (dB)	Margin (dB)
-50	0.0	16.0	-1.9	12.5	14.4	-1.6
-45	0.0	11.0	-1.9	7.3	9.2	-1.8
-44	0.0	10.0	-1.9	6.3	8.2	-1.8
-43	0.0	9.0	-1.9	5.3	7.2	-1.8
-42	0.0	8.0	-1.9	4.3	6.2	-1.8
-37	0.0	3.0	-1.9	-9.0	0.8	-2.2



Occupied Bandwidth

Name of Test: Occupied Bandwidth

Test Equipment Utilized: i00331 and i00405

Engineer: Mike Graffeo

Test Date: 4/18/2014

Test Procedure

The EUT was connected to a spectrum analyzer through an attenuator with the losses being input into the spectrum analyzer as a combination of reference level offset and correction factor as required to ensure that accurate readings were obtained. A signal generator was utilized to produce the following signals: GSM, CDMA, and WCDMA. The signal generator was tuned to the center channel of each of the EUT operational uplink and downlink bands with the RF level set at a point just prior to the AGC being in control of the power. For each modulation type, the input and output signal was measured and plotted to ensure that the signals were similar.

Test Setup

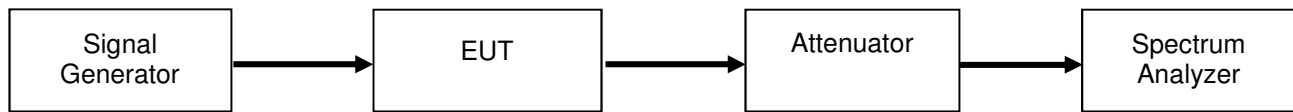



GSM Uplink Test Plots

776 - 787 MHz Band

Input

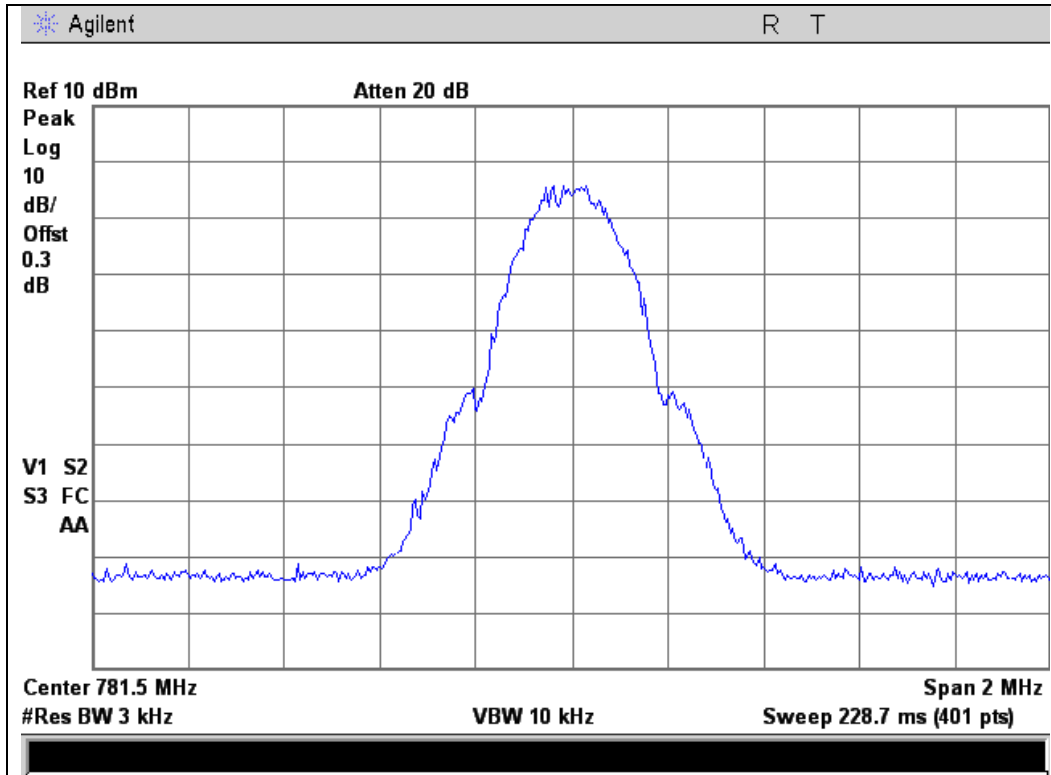

Output

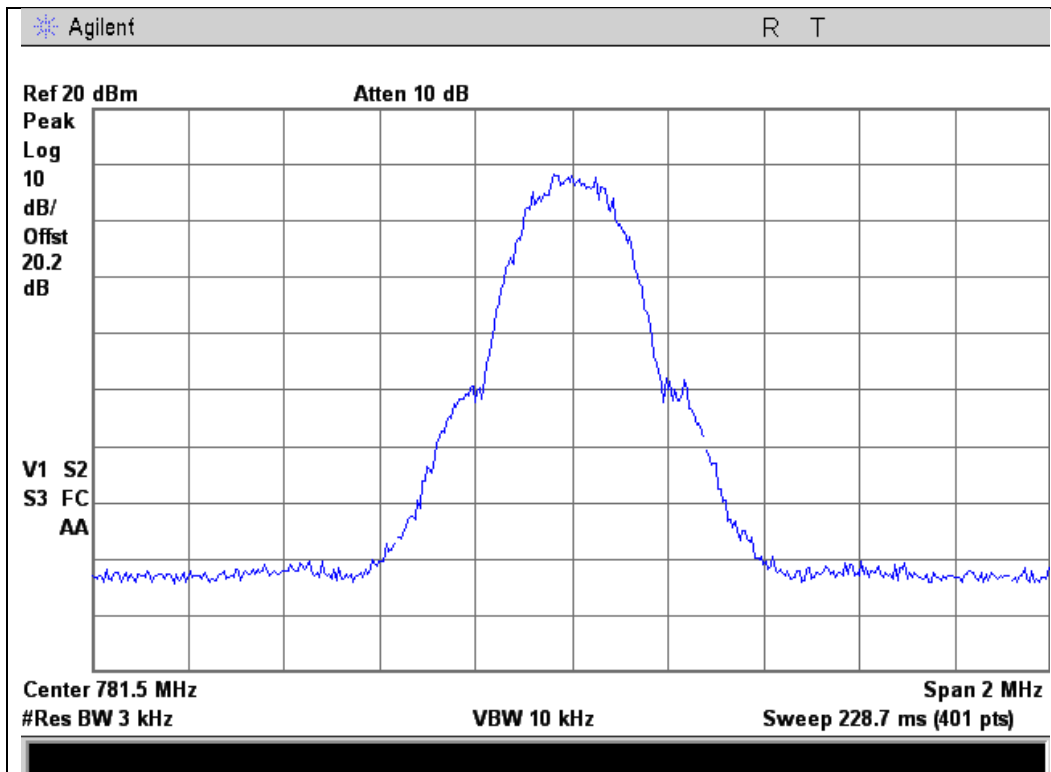



CDMA Uplink Test Plots

776-787MHz MHz Band

Input

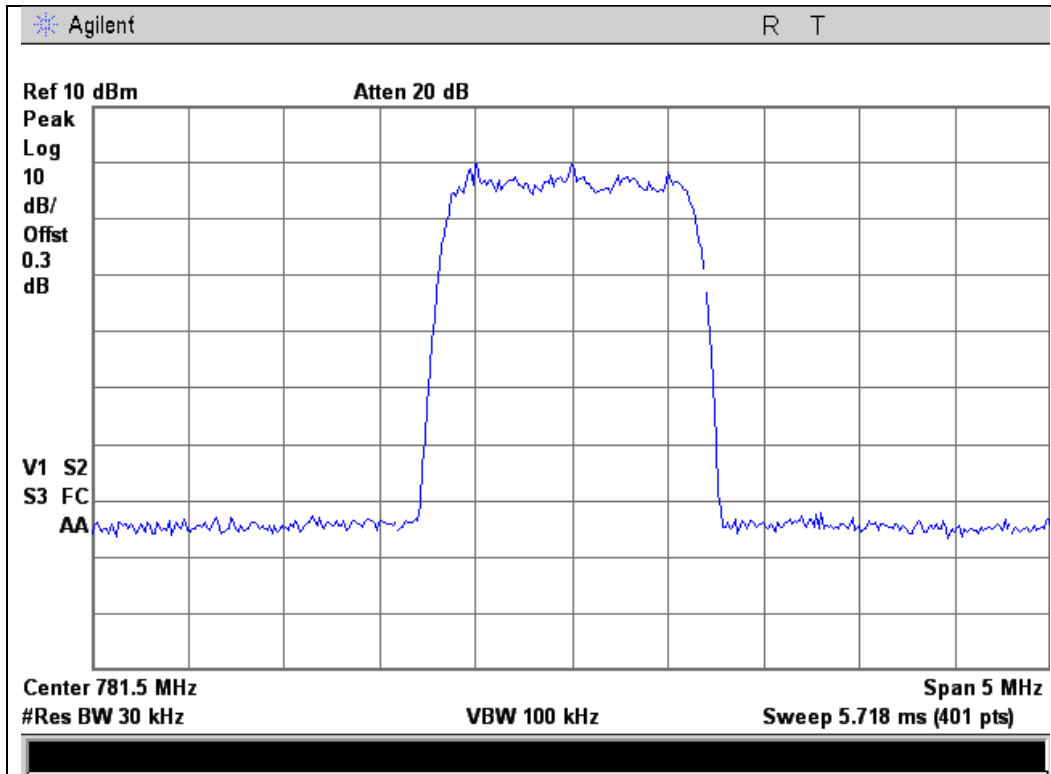

Output

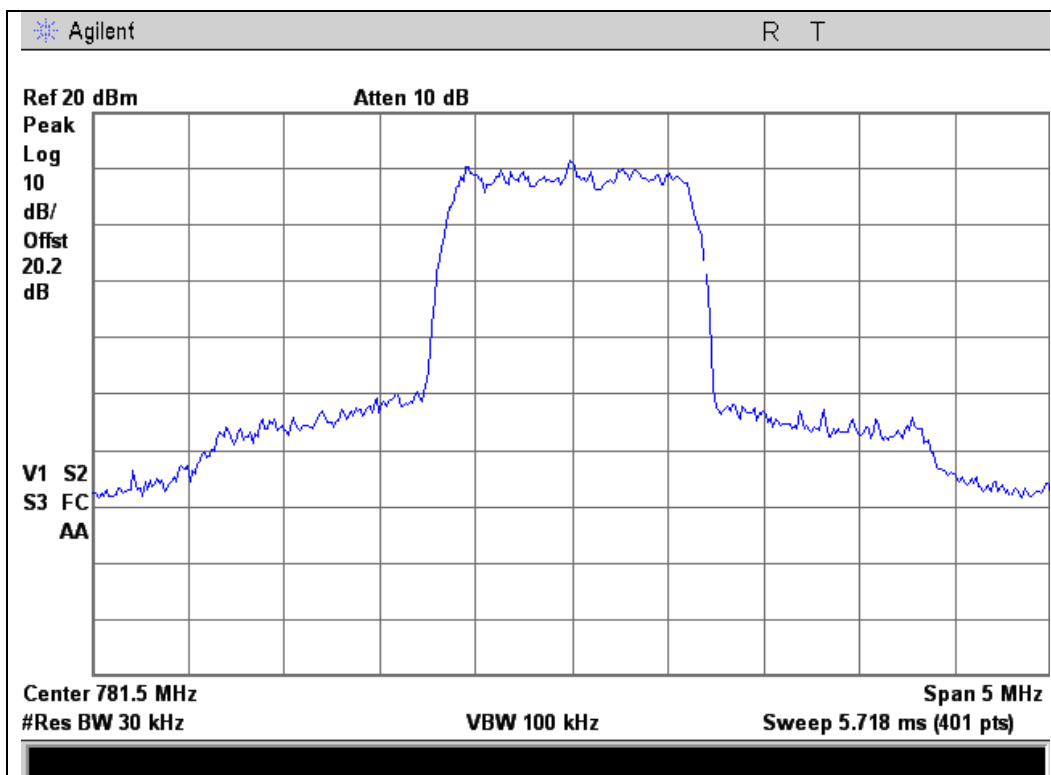



WCDMA Uplink Test Plots

776-787 MHz Band

Input

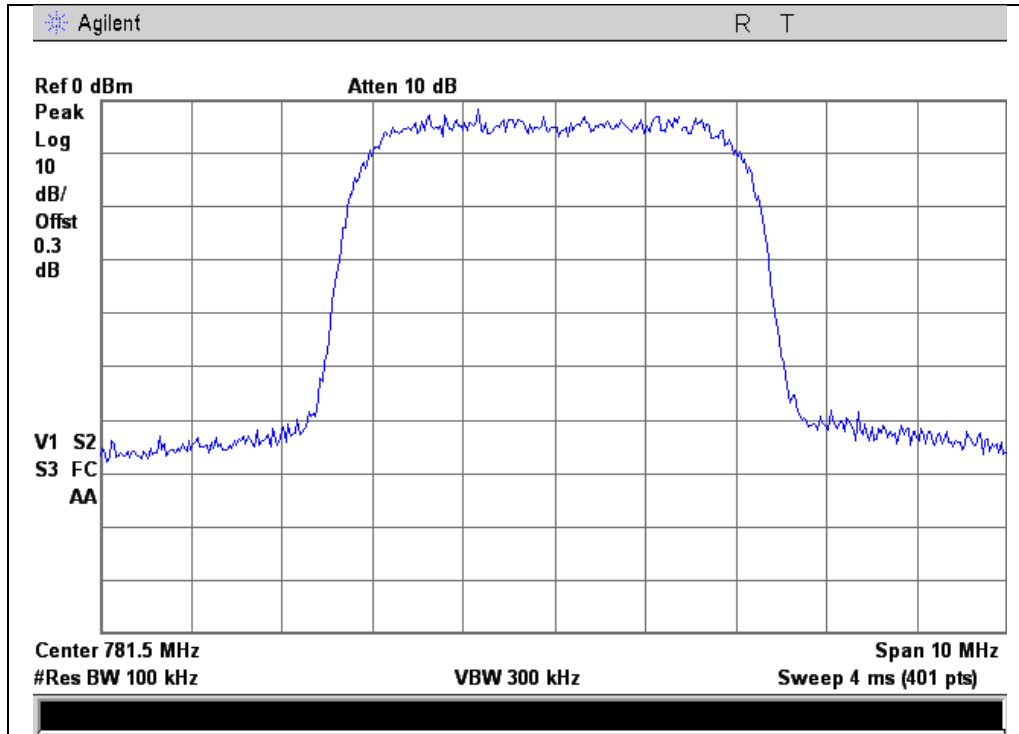

Output

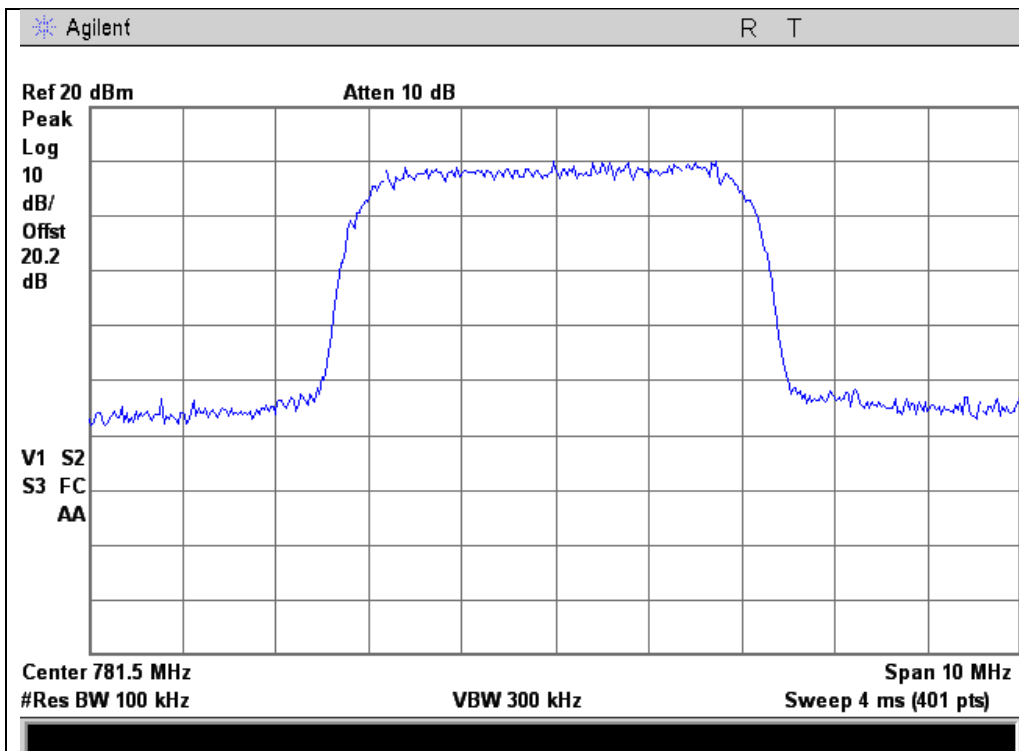



GSM Downlink Test Plots

746-757 MHz Band

Input

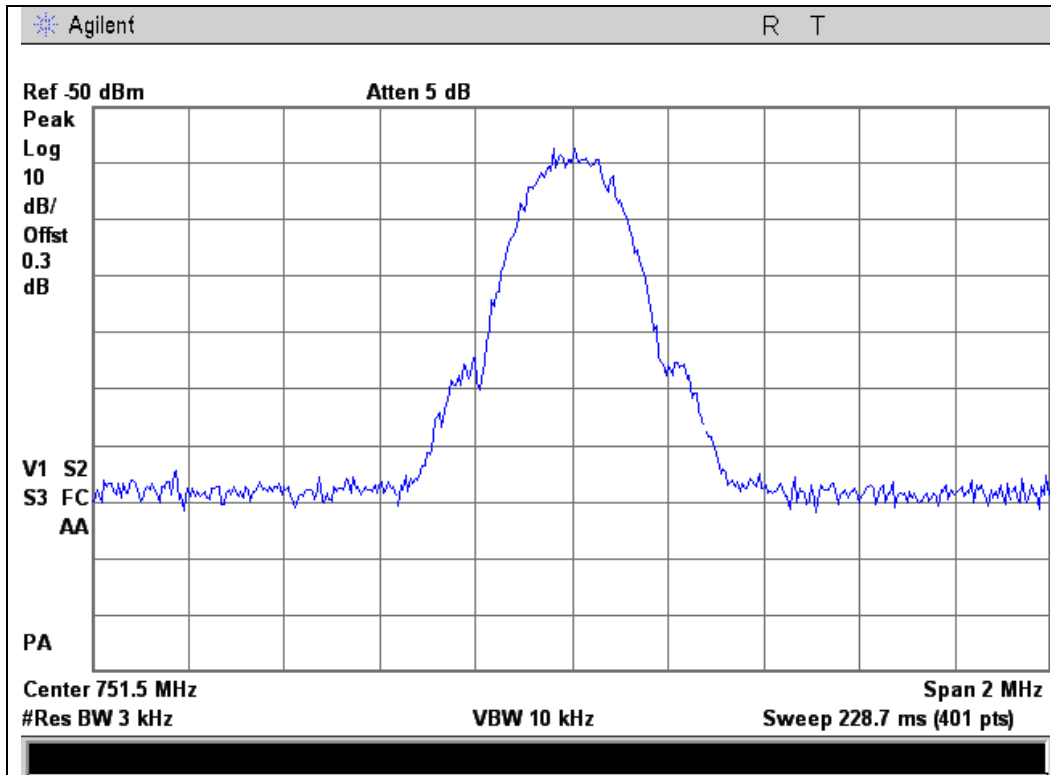

Output

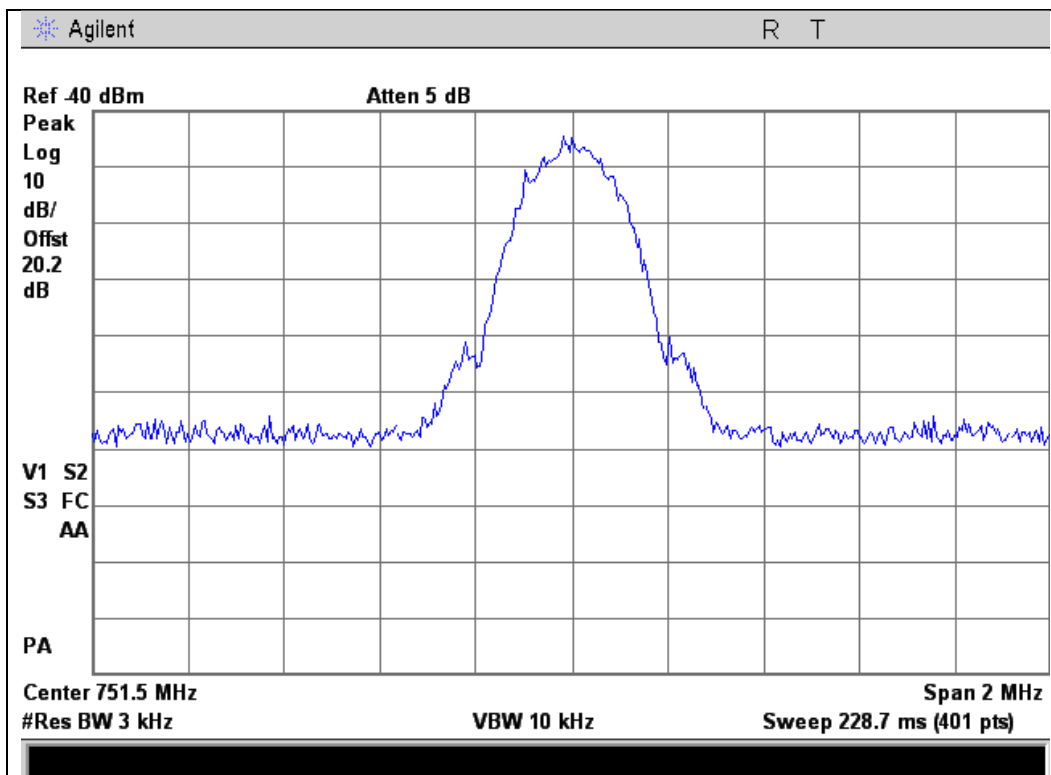



CDMA Downlink Test Plots

746-757 MHz Band

Input

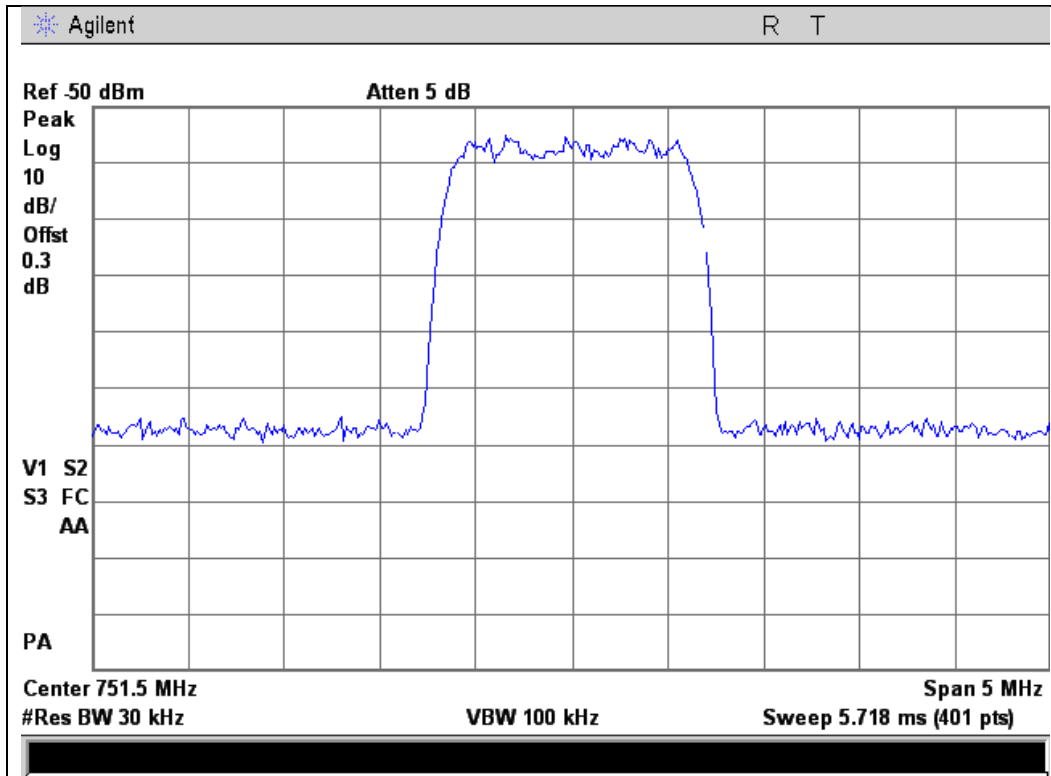

Output

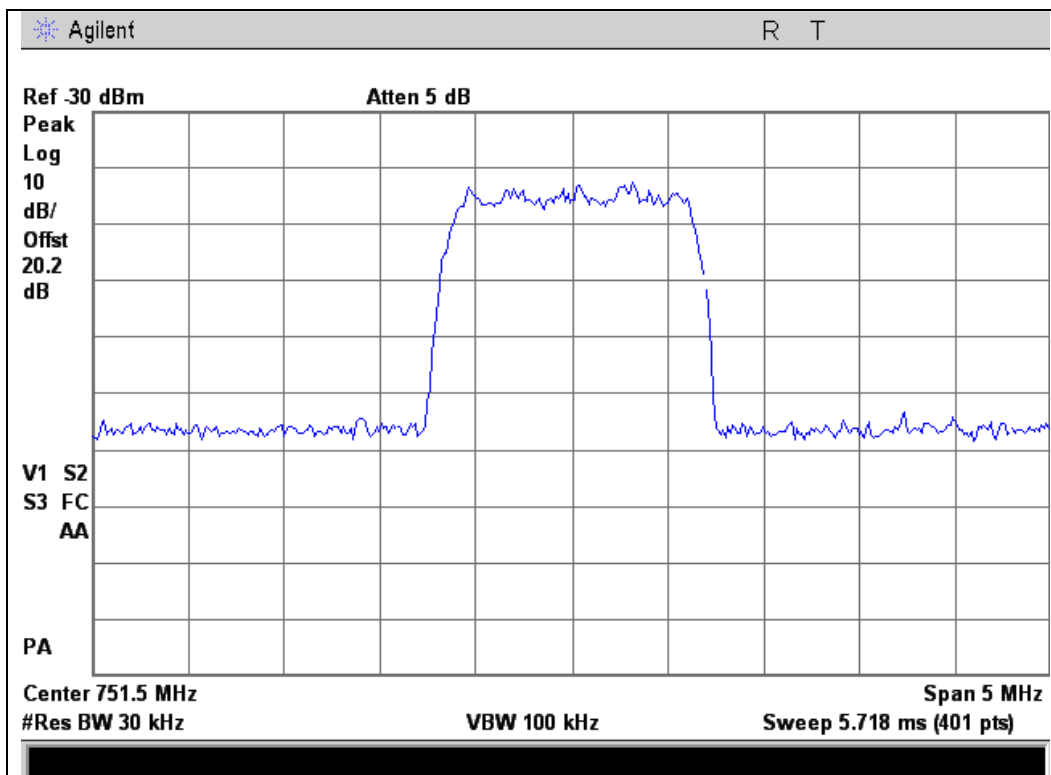



WCDMA Downlink Test Plots

746-757 MHz Band

Input

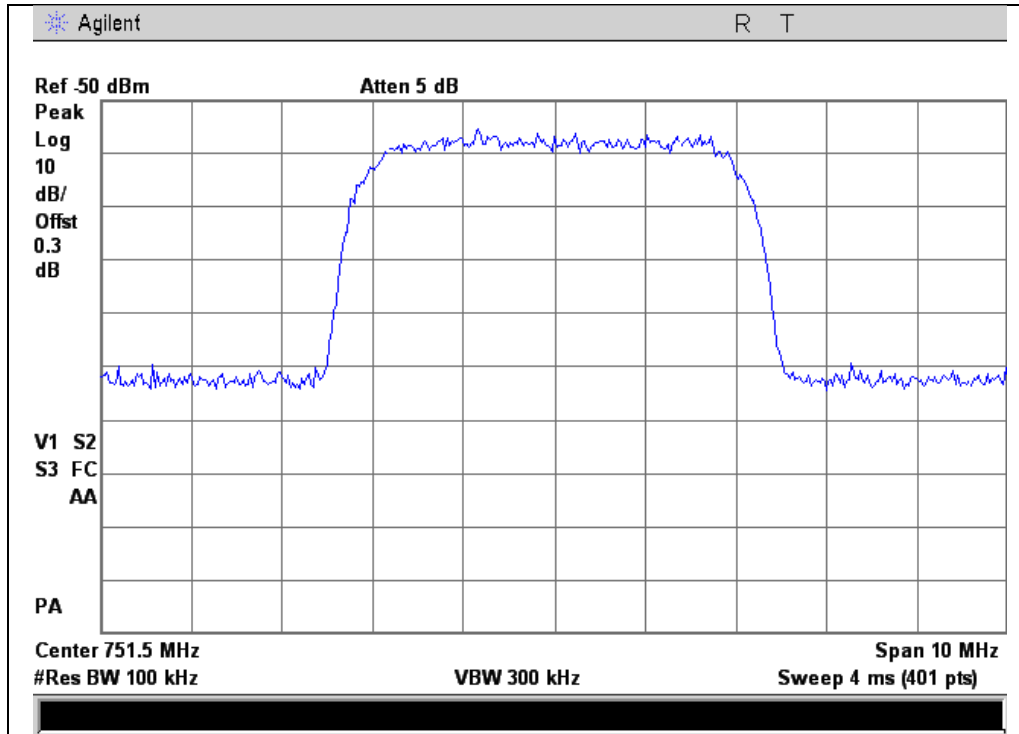

Output

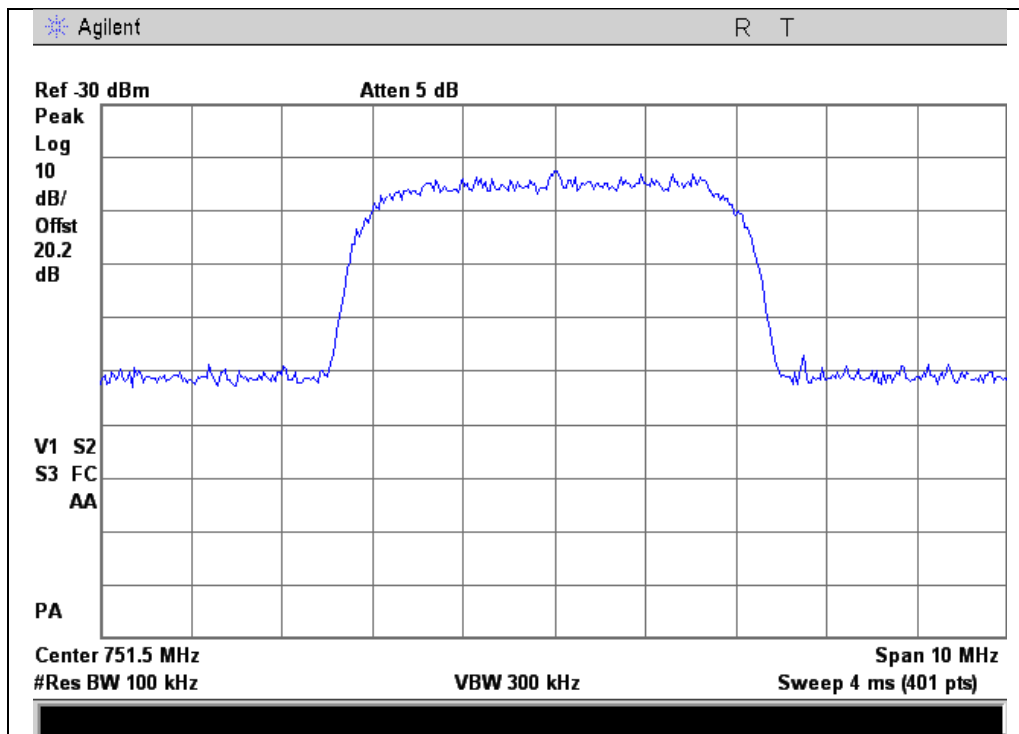



Oscillation Detection

Name of Test: Oscillation Detection
Test Equipment Utilized: i00331, i00405, i00412

Engineer: Mike Graffeo
Test Date: 3/31/2014

Test Procedure

The EUT was connected to a spectrum analyzer set for 0 Hz operation. The EUT uplink and downlink were fed back upon each other through a selectable band pass filter and variable attenuator. The EUT uplink and downlink were tested to ensure that the presence of oscillation was detected and that the EUT output turned off within 300 mS for the Uplink and 1 second for the Downlink and remained off for 1 minute. A EUT with test software was utilized to ensure that the EUT only had a maximum of 5 attempts at restart from oscillation before permanently shutting off.

Test Setup

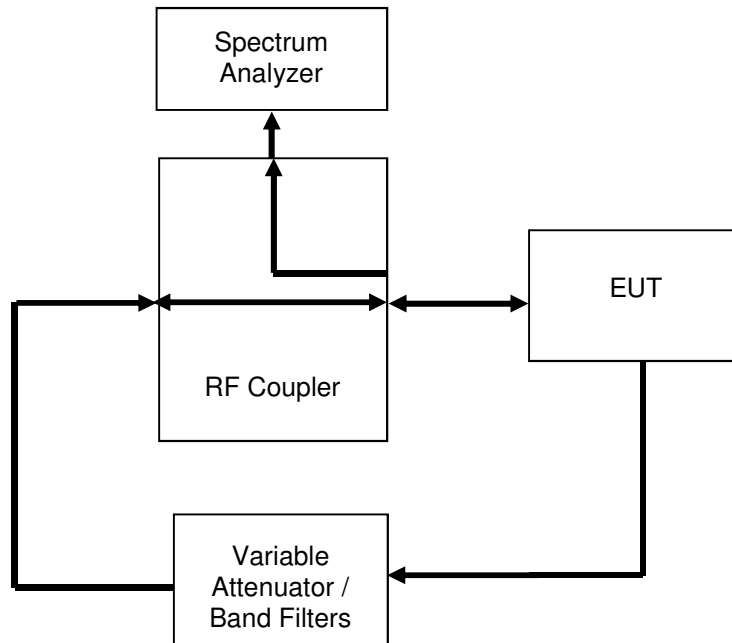



Uplink Detection Time Test Results

Frequency Band (MHz)	Measured Time (mS)	Limit (mS)	Result
776 - 787	61.2	300	Pass

Downlink Detection Time Test Results

Frequency Band (MHz)	Measured Time (mS)	Limit (mS)	Result
746 - 757	80.85	1000	Pass

Uplink Restart Time Test Results

Frequency Band (MHz)	Measured Time (S)	Limit (S)	Result
776 - 787	69	≥60	Pass

Downlink Restart Time Test Results

Frequency Band (MHz)	Measured Time (S)	Limit (S)	Result
746 - 757	69	≥60	Pass

Uplink Restart Count Test Results

Frequency Band (MHz)	Restarts	Limit	Result
776 - 787	3	≤5	Pass

Downlink Restart Count Test Results

Frequency Band (MHz)	Restarts	Limit	Result
746 - 757	3	≤5	Pass



Uplink Detection Time Test Results

776 - 787 MHz Band

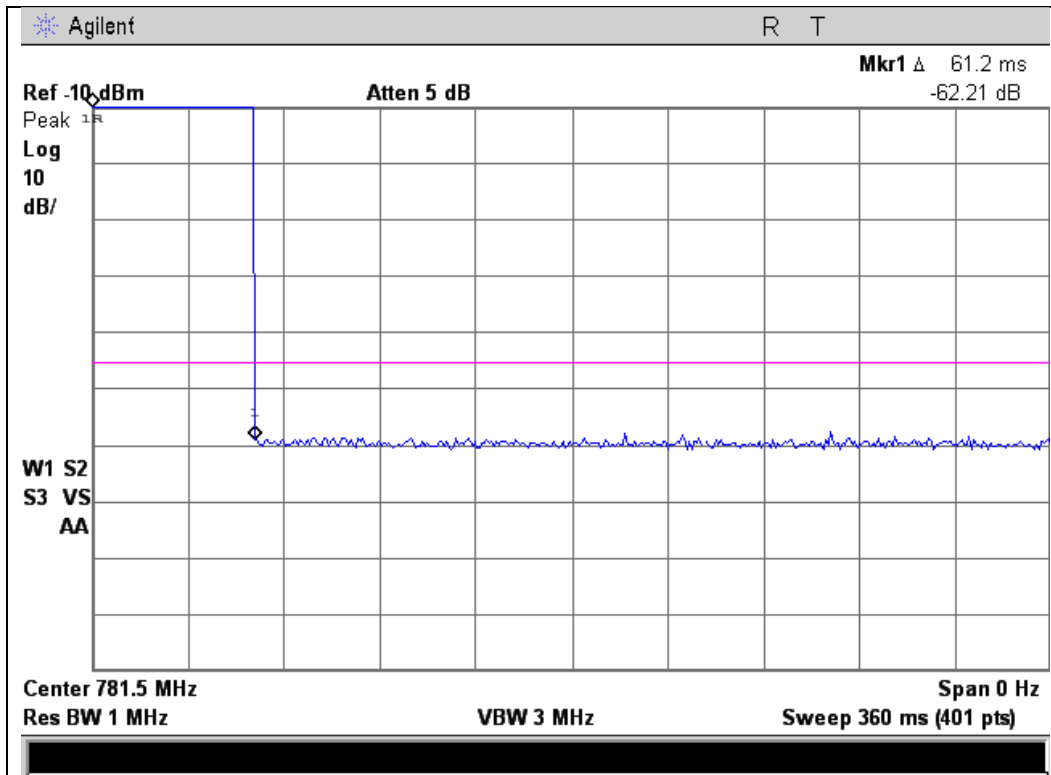

Downlink Detection Time Test Results

746 - 757 MHz Band

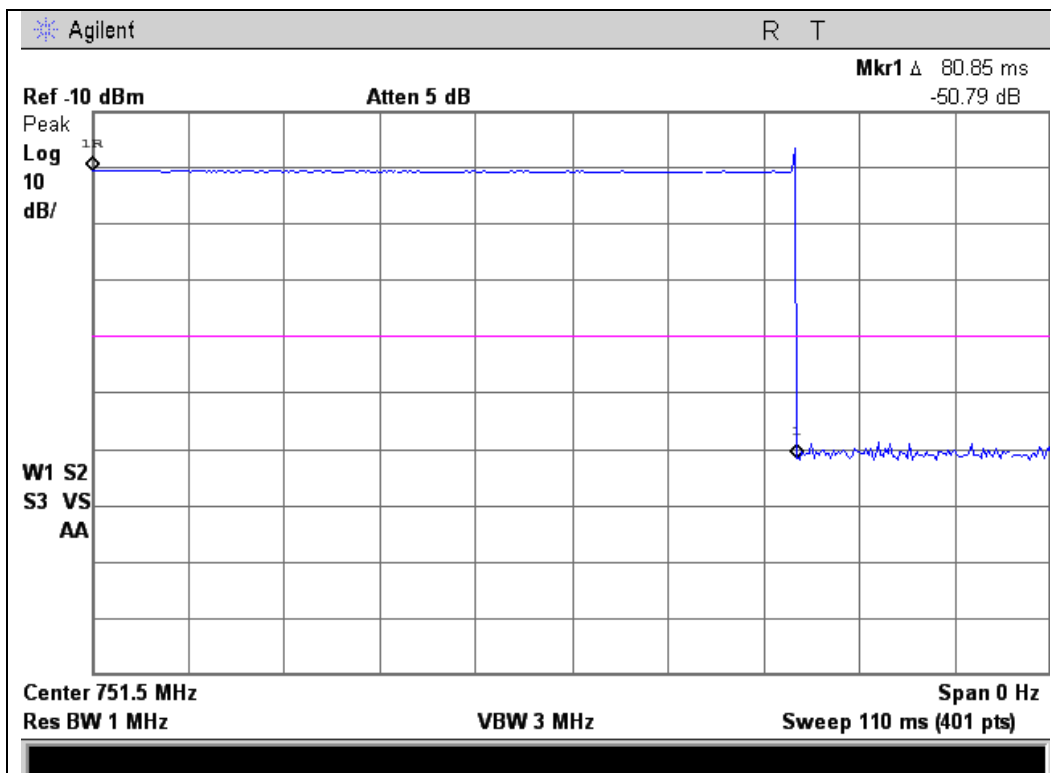



Uplink Restart Time Test Results

776 - 787 MHz Band

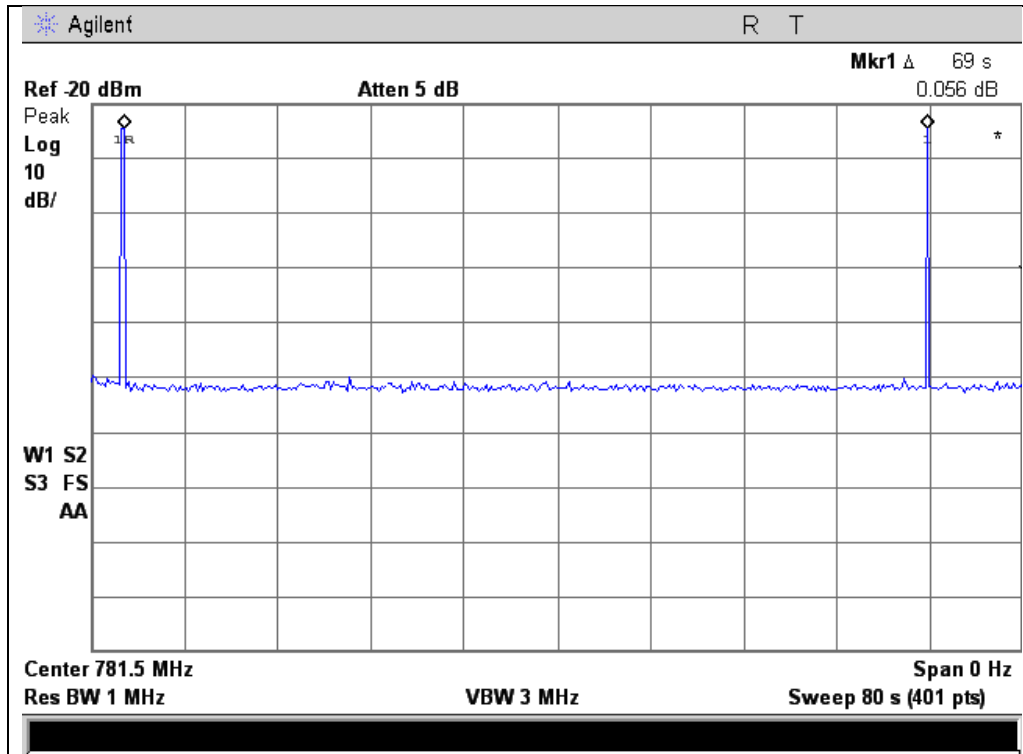

Uplink Restart Time Test Results

746 - 757 MHz Band

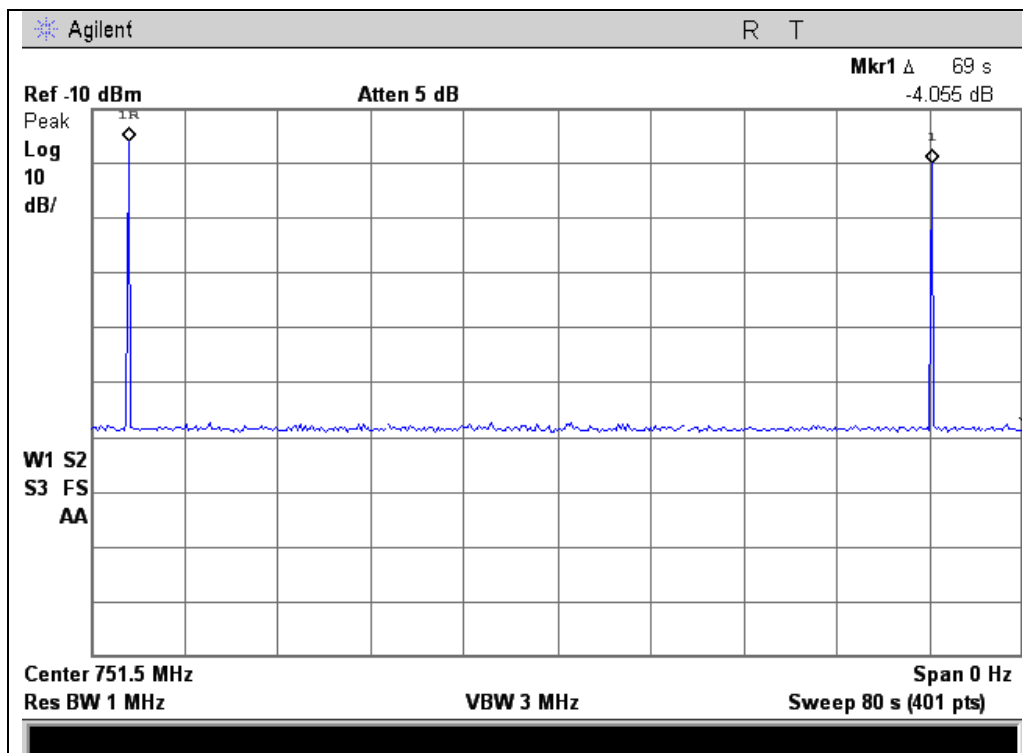



Uplink Restart Count Test Results 776 - 787 MHz Band

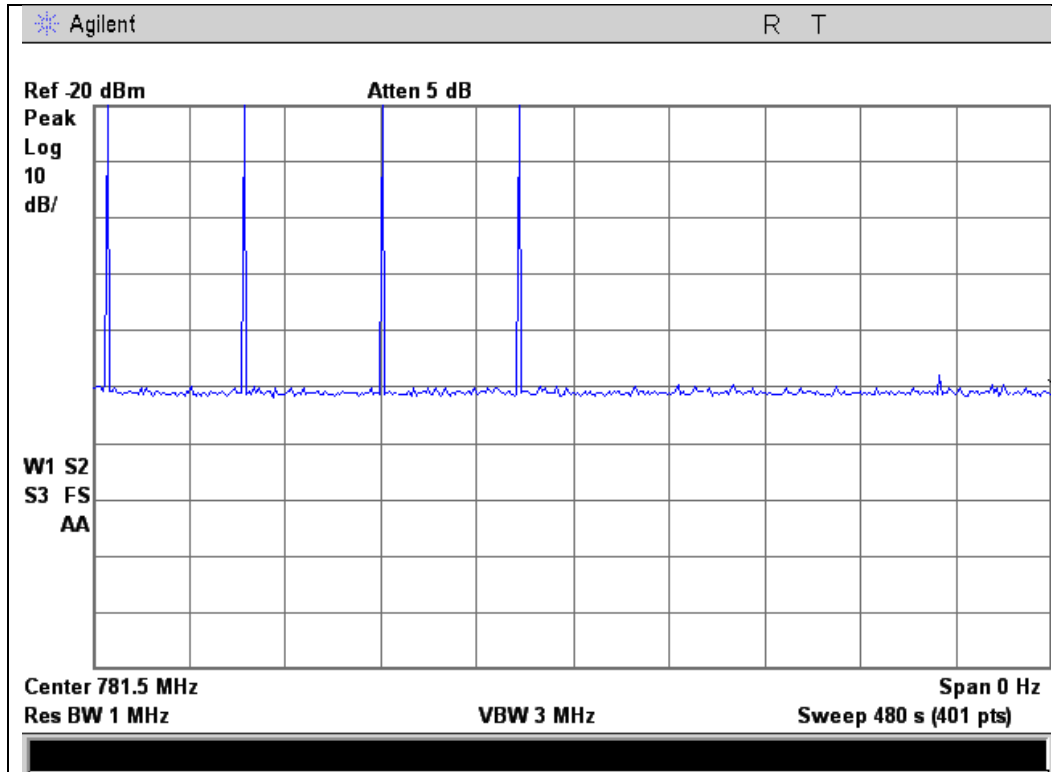

Downlink Restart Count Test Results 746 - 757 MHz Band

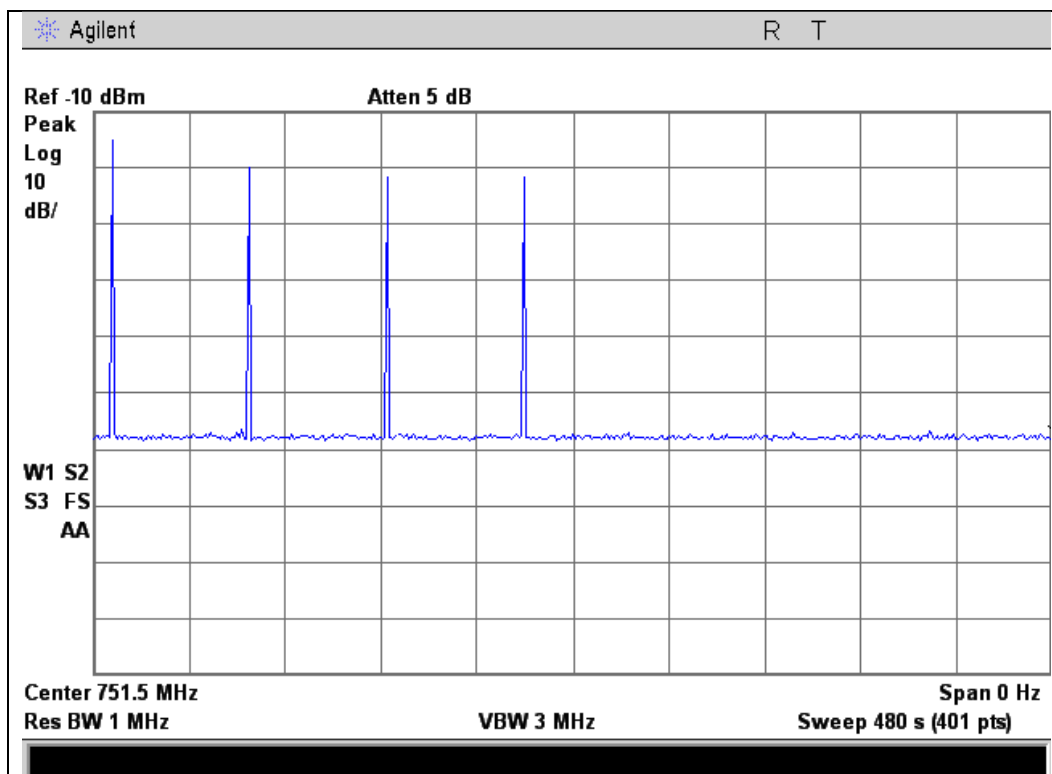



Radiated Spurious

Name of Test: Radiated Spurious

Engineer: Mike Graffeo

Test Equipment Utilized: i00405, i00334, i00271, i00331

Test Date: 4/18/2014

Test Procedure

The EUT was tested in a semi-anechoic chamber with the turntable set 3m from the receiving antenna. A spectrum analyzer was used to verify that the EUT met the requirements for Radiated Emissions. The EUT was tested by rotating it 360 degrees with the antenna in both the vertical and horizontal orientation while raised from 1 to 4 meters to ensure that the signal levels were maximized. All cable and antenna correction factors were input into the spectrum analyzer ensuring an accurate measurement in ERP/EIRP with the resultant power in dBm. A signal generator was used to provide a CW signal centered in each operational uplink and downlink band. The EUT output was terminated into a 50 Ohm non-radiating load.

The following formula was used for calculating the limits:

$$\text{Radiated Spurious Emissions Limit} = P1 - (43 + 10\text{Log}(P2)) = -13\text{dBm}$$

P1 = power in dBm

P2 = power in Watts

Test Setup

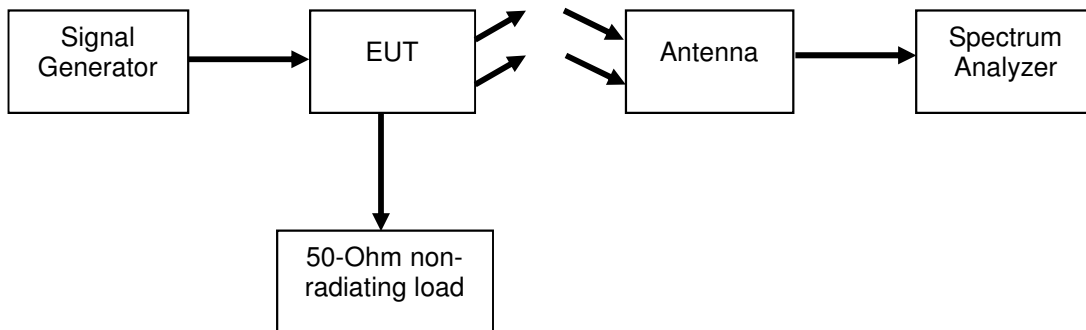



Uplink Test Results

776-787 MHz Band 781.5 MHz Tuned Frequency

Measured Frequency (MHz)	Measured Level (dBm)	Limit (dBm)	Result
1563	-79.79	-13	Pass
2345	-77.20	-13	Pass
3126	-78.73	-13	Pass

Downlink Test Results

746-757 MHz Band 751.5 MHz Tuned Frequency

Measured Frequency (MHz)	Measured Level (dBm)	Limit (dBm)	Result
1503	-81.42	-13	Pass
2255	-78.63	-13	Pass
3006	-77.22	-13	Pass

No other emissions were detected. All emissions were lower than -13 dBm.
All emissions were system noise floor.



Test Equipment Utilized

Description	Manufacturer	Model #	CT Asset #	Last Cal Date	Cal Due Date
Horn Antenna	EMCO	3115	i00271	4/19/12	4/19/14
Humidity / Temp Meter	Newport	IBTHX-W-5	i00282	3/24/14	3/24/15
Voltmeter	Fluke	75III	i00320	3/24/14	3/24/15
Spectrum Analyzer	Agilent	E4407B	i00331	4/23/13	4/23/14
Non-radiating load	Termaline	8201	i00334	Verified on: 1/16/14	
Power Supply (for EUT)	HP	6654A	i00350	Verified on: 1/16/14	
Signal Generator	Rohde & Schwarz	SMU200A	i00405	12/11/13	12/11/14
RF Directional Coupler	Meca	CS06-1.500V	i00412	Verified on: 1/16/14	

In addition to the above listed equipment standard RF connectors and cables were utilized in the testing of the described equipment. Prior to testing these components were tested to verify proper operation.

END OF TEST REPORT



Test Setup Photos
FCC ID: RSNM2M-V

RF Conducted



RF Radiated
(EUT at 3 meters)

