

CM2020 Industrial

Dual-Band Cellular Booster for Commercial
Offices, Institutions and Housing Complexes.

User Guide

WARNING

This is NOT a CONSUMER device. It is designated for installation by FCC LICENSEES and QUALIFIED INSTALLERS. You MUST have an FCC LICENSE or express consent of an FCC Licensee to operate this device. Unauthorized use may result in significant forfeiture penalties, including penalties in excess of \$100,000 for each continuing violation.

CHAPTER 1: Introduction 1	
1.1 - Package Contents	3
1.2 - Features & Benefits	3
1.3 - Additional Items Needed	3
1.4 - How It Works	4
CHAPTER 2: Safety	4
2.1 - Safety Warnings	4-5
CHAPTER 3: Planning	6
3.1 - Overview	6
3.2 - Exterior Antenna	7
3.3 - Interior Antennas	8
3.4 - Antenna Separation	9-11
3.5 - Calculating Signal Strength	11-12
3.6 - Booster Location	13
3.7 - Accessories	13
3.8 - Need Help?	14
CHAPTER 4: Installation	14
4.1 - Selecting the Locations	14
4.2 - Soft Installation	14-15
4.3 - Exterior Antenna	16
4.4 - Internal Antennas	17
4.5 - Mounting the Booster	18
CHAPTER 5: Configuration & Testing	18
5.1 - DIP Switches and Lights	19
5.2 - Initial Configuration	19-20
5.3 - Powering on the Booster	21
5.4 - Testing	21
5.5 - Adjusting the Booster	21
5.6 - Automatic Shutdown	22
CHAPTER 6: Warranty	22
6.1 - Warranty Periods	22-24
6.2 - Warranty Information	24
6.3 - Contact Information	24

Introducing SureCall's CM2020, Industrial booster Please read this entire manual before proceeding. with the installation. This manual applies to the CM2020 Industrial model.

1.1 - Package Contents

Your booster box contains the following items:

- CM2020 Booster.
- Mounting kit (not shown).
- DC power supply (not shown).
- Wall anchors (not shown).

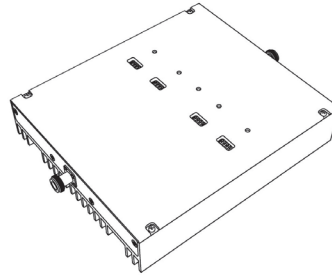

1.2 - Features & Benefits

The CM2020 Industrial booster offers the following features and benefits:

- Powerful in-building booster with 31dB of adjustable gain level.
- Extends cellular signals in areas with poor coverage due to geographical and/or building design.
- Suitable for large areas up to approximately 80,000 square feet depending on outside signal strength and carrier frequency.
- Power control maintains maximum output power at 3 watts EIRP.
- Automatic oscillation detection and protection system powers down the booster to prevent harmful radio interference (if equipped).

1.3 - Additional Items Needed

The CM2020 booster requires the following components for a complete installation:

- External antenna (such as the SC-100L or SC-288W omni or SC-230D Yagi by SureCall).
- Lightning protector (CMLP).
- Cable splitter if installing multiple antennas (up to six in a typical installation).

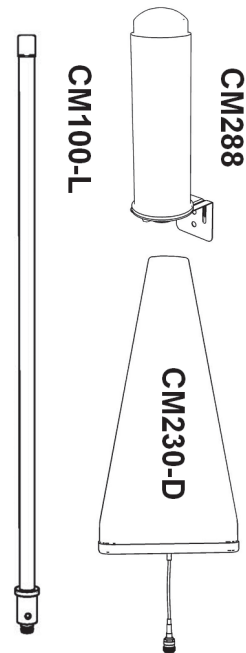

- Sufficient SC-400 ultra low loss interior/exterior cable (for boosters above 55dB).
- Sufficient SC-240 ultra low loss interior/exterior cable (for boosters 55dB and below).
- Up to 6 internal antennas (such as the SC-222W, SC-223, or SC-224 omnidirectional domes and/or SC-248W flat panel by SureCall).
- Grounded surge suppressor for DC power

1.4 - How It Works

The CM2020 booster amplifies cellular signals from the nearest tower to phones in a building and from those phones back to the tower to compensate for weak reception caused by distance, topography, building structure, and/or other reasons. The booster receives the signal from an outside antenna, amplifies that signal, and then rebroadcasts it via the interior antenna(s) where it is picked up by cellular phones, modems, and data cards. The interior antennas also pick up signals from cellular devices and pass them to the booster. The booster amplifies these signals and passes them to the exterior antenna for rebroadcast back to the tower.

CHAPTER 2: Safety

This chapter contains important safety information designed to prevent personal injury, equipment malfunction, and/or radio interference. You are responsible for ensuring a safe installation.

2.1 - Safety Warnings

- You are responsible for knowing and following all applicable codes and regulations and for obtaining all required permits and inspections.
- Follow all safety precautions contained in this Installation Manual.
- The installation process may require working in high locations such as roofs and/or ladders. Follow applicable safety regulations and best practices to avoid falling. Take care not to drop objects off any high area. Cordon off ground areas directly below roof or ladder work when possible.
- Always use appropriate personal protective equipment such as goggles, gloves, hard hat, etc. as needed and as required.

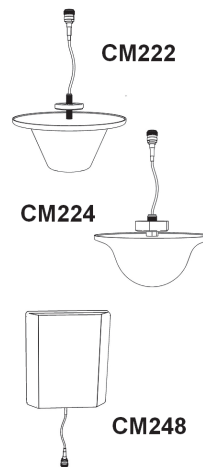

WARNING: FAILURE TO EXERCISE CAUTION WHEN WORKING IN HIGH AREAS COULD CAUSE A FALL AND PERSONAL INJURY.

Some components may be heavy and/or bulky. Always use proper lifting and carrying techniques when handling components, especially when working on a ladder, roof, or other area with a fall hazard.

- The exterior antenna must not be co-located or operating in conjunction with any other antenna.
- Always use a properly installed SureCall lightning protector between the exterior antenna and the booster.



CAUTION: FAILURE TO PROPERLY INSTALL A LIGHTNING PROTECTOR CAN RESULT IN DAMAGE TO THE BOOSTER, ANTENNAS, AND WIRING.

- Always power off the booster before working on the roof of the building or anywhere in close proximity to the external antenna.
- Allow at least 24 inches (60cm) of separation between interior antennas and humans or animals.
- Allow at least 24 inches (60cm) of separation between exterior antennas and all persons.
- Comply with all antenna separation requirements to prevent signal oscillation.



CAUTION: SIGNAL OSCILLATION CAN CAUSE RADIO INTERFERENCE WITH CELLULAR TOWERS AND RESULT IN CIVIL AND/OR CRIMINAL PENALTIES.

CHAPTER 3: Planning

3.1 - Overview

The general booster installation process follows these steps:

1. Decide where to mount the exterior antenna. This will generally be on the wall or roof of the building in the location with the strongest signal. You will need to decide whether to use an omnidirectional antenna mounted vertically or a directional Yagi antenna pointed directly at the cellular tower (line of sight). You must also consider attaching a grounded lightning protector between the exterior antenna and the booster.
2. Decide where to mount the interior antenna(s), being sure to take separation requirements into account. In general, long narrow spaces will benefit most from directional flat-panel antennas while more square spaces will benefit more from omnidirectional dome antennas.
3. Decide where to mount the booster. This should be in a secure indoor location near a grounded power source.
4. Decide where to route the cables between the exterior antenna and the booster and between the booster and interior antennas.
5. Install the antennas as described in their respective Installation Manuals.
6. Route the cables to the booster location.
7. Install the booster as described in this manual.
8. Power on the booster and perform the configuration and testing as described in this manual.

3.2 - Exterior Antenna

You may use either an omnidirectional antenna such as the SC-100-L (flat area with no obstructions) or a directional Yagi antenna such as the SC-230W (to point directly at the tower). The omnidirectional antenna receives and transmits signals over a horizontal 360-degree circle while the Yagi antenna receives and transmits signals over a focused area and must be aimed directly (line of sight) toward the cellular tower that provides the best signal to the building.

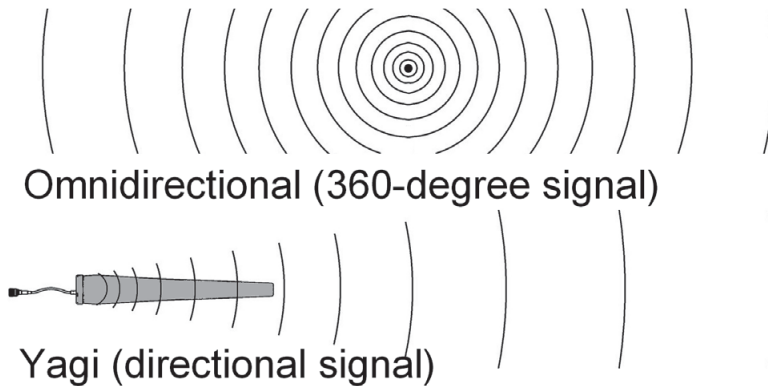

The exterior antenna and mast (if any) must be mounted in a location that meets all of the following criteria:

- Best signal strength.
- Not colocated with other antennas or used in conjunction with other antennas.
- Away from all power lines.
- 6' from lightning rod antennas.
- 24" from all persons.

These distances are general guidelines only; refer to the applicable building and electrical codes in your area to determine local requirements.

3.3 - Interior Antennas

You may use any combination of omnidirectional (dome) and/or directional (flat panel) interior antennas needed to obtain optimal signal strength throughout the building or installation area. Dome antennas such as the SC-222W, SC-223 and SC-224 provide 360-degree hemispherical coverage suitable for mostly square areas while flat panel antennas such as the SC-248W provide a focused zone of coverage suitable for long narrow areas. The following example uses two dome antennas and one panel antenna to provide full coverage (exterior Yagi antenna also shown):

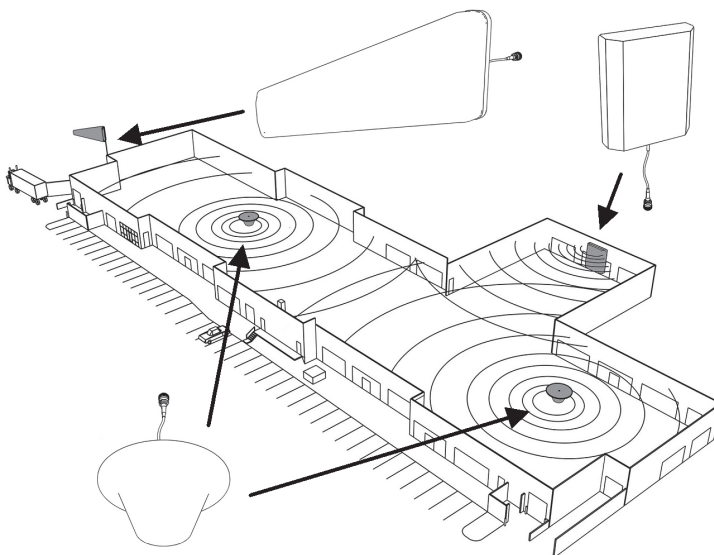

Keep in mind that floor structures in multistory buildings can cause significant signal loss, which means that you may need to install interior antennas on more than one floor. Here is an example of a multistory installation:

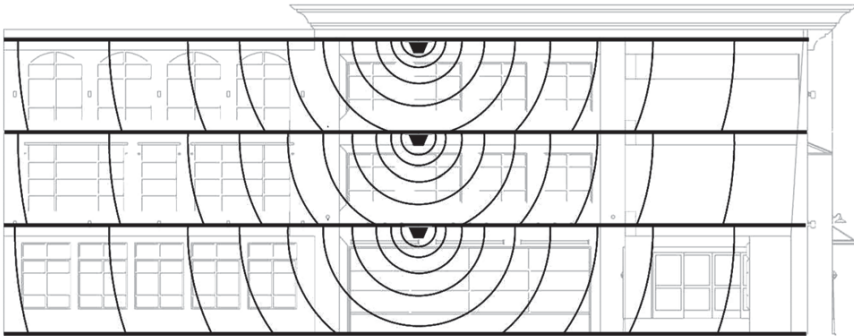

Note: You may or may not need antennas on every floor of a multistory building depending on factors such as building material, booster gain, etc.

3.4 - Antenna Separation

Proper antenna separation is essential in order to prevent signal oscillation (feedback) that can interfere with the cellular tower. Separation is measured in a straight line from the exterior antenna to the closest interior antenna. The closest allowable distance depends on a number of factors such as booster gain level, building material, etc. Recommended separation distances are:

Amplifier gain	Min. separation (ad)
40dB	5-6'
45dB	15-20'
50dB	50'
55dB	60'
65dB	75-80'
70dB	100'
75dB	100'-120'
80dB	120'-180'

Note: Vertical separation is more important than horizontal separation. If you are unable to obtain the required separation horizontally, try raising the exterior antenna. You may also try reducing the booster gain as described in Chapter 5 of this manual.

The easiest way to calculate the straight-line separation between antennas is to break it down into three simple measurements and then use some basic geometry to find the distance, as follows:

1. Measure the distances ab , bc , and cd as shown in the diagram on the next page.

- Distance from the nearest interior antenna (Point a) to the wall underneath the exterior antenna (Point b). This is distance ab .

- Distance from Point b to directly underneath the exterior antenna. This is Point (c). This is distance bc .

- Distance from Point c to the exterior antenna (Point d). This is distance cd .

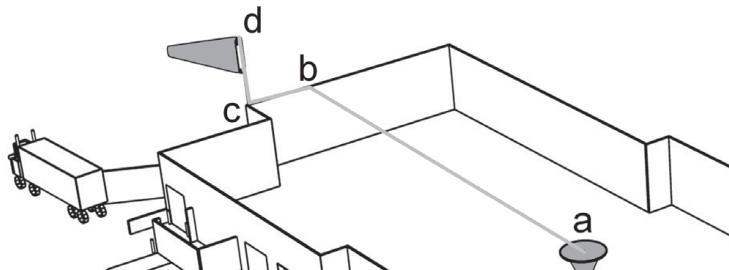

2. Multiply ab times ab to obtain ab^2 .

3. Multiply bc times bc to obtain bc^2 .

4. Multiply cd times cd to obtain cd^2 .

5. Add ab^2+bc^2 to obtain ac^2 .

6. Add ac^2+cd^2 to obtain ad^2 .

7. The straight-line distance ad is the square root ($\sqrt{\quad}$) key. of the result obtained in Step 6. Example:

- Distance $ab=40$ feet; $ab^2 = 40 \times 40 = 1600$.

- Distance $bc=10$ feet; $bc^2 = 10 \times 10 = 100$.

- Distance $cd=20$ feet; $cd^2 = 20 \times 20 = 400$.

- $ac^2 = 1600 + 100 = 1700$

- $ad^2 = 1700 + 400 = 2100$

- $ad = 45.83'$

Here, the straight-line distance ad is just under 46 feet, which is compatible with 50dB booster gain as indicated in the previous table.

Separate interior antennas based on the calculations shown in Section 3.5. You may mix and match dome and directional antennas as needed to obtain proper coverage throughout the building or area where you need to boost the signal. If you are using a Yagi exterior antenna, you should normally aim it away from all interior antennas regardless of separation to prevent oscillation.



CAUTION: SIGNAL OSCILLATION CAN CAUSE RADIO INTERFERENCE WITH CELLULAR TOWERS AND RESULT IN CIVIL AND/OR CRIMINAL PENALTIES.

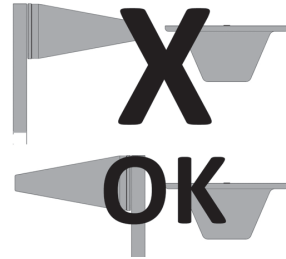

3.5 - Calculating Signal Strength

You can calculate the number of antennas you will need using the following parameters (in dB):

- **Outside signal level (OSL):** This is the signal strength at the exterior antenna location and will always be a negative number that will usually fall between -50 and -100dBm. Calls will drop at levels of about -100dB and lower.
- **Outside antenna gain (OAG):** This the signal boost provided by the exterior antenna and is always a positive number with SureCall antennas.

OAG	Cellular	PCS
SC-100S omni	+5	+5
SC-100L omni	+9	+9
SC-288 omni	+3	+3
SC-230D Yagi	+10	+11

- **Inside antenna gain (IAG):** This is the signal boost provided by an interior antenna and is always a positive number with SureCall antennas.

SC-222W omni dome	+3	+3
SC-223 omni dome	+3	+3
SC-248 Directional panel	+7	+10

- **Cable loss (CL):** This is the signal loss caused by the cable and is always a negative number.

IAG Cellular PCS

20' SC- 400/SC-240	-1/-2	-2/-4
30' SC-400/SC-240	-2/-4	-3/-6
50' SC-400/SC-240	-3/-6	-4/-8
100' SC-400/SC-240	-4/-8	-7/-14

- **Splitter loss (SL):** This is the signal loss caused by a splitter (used if you are installing multiple antennas).

SL	Cellular	PCS
2-way	-3	-3
3-way	-5	-5
4-way	-6	-6

- **Booster gain (AG):** Number of decibels of amplification provided by the booster (rated gain less any attenuation, as described in Chapter 5 of this manual). This is always a positive number.

The signal strength S at an interior antenna equals $OSL+OAG+IAG+CL+SL+AG$. To calculate the approximate coverage distance of each antenna:

1. Calculate the signal strength S for the first interior antenna using the preceding formula.
2. Find the signal strength S for the antenna along the bottom of the graph on the following page.
3. Move straight up the signal strength line to the PCS and cellular curves.
4. Read the approximate coverage radius on the left.

3.6 - Booster Location

Select an indoor location for the booster that meets the following criteria:

- Wall or ceiling mounts are acceptable.
- Near a properly grounded 110VAC outlet.
- Not in a tightly enclosed or overly hot space.
- All power and warning lights easily visible.
- Least amount of cable to connect all antennas.

3.7 - Accessories

The final step in the planning process is to make sure you have all of the necessary accessories to complete the installation. You will need all of the items listed in Chapter 1 of this manual plus some or all of the following:

- Cable clips: Use these to secure the cables to interior and exterior walls/ceilings.
- Appropriately rated sealant/caulking: Use this to waterproof the opening where the cable from the exterior antenna enters the building, if needed.
- Hand and/or power tools: As needed to complete the installation.
- Personal Equipment (PPE): Use all PPE required by local codes and/or best practices to help ensure personal safety during installation.

Note: You may need to obtain a permit from your local building department to install the booster and antennas. Check your local building and/or electrical codes.



CAUTION: YOU ARE RESPONSIBLE FOR ENSURING THAT THE INSTALLATION MEETS ALL APPLICABLE CODES.

3.8 - Need Help?

If you need help planning your installation, please contact a qualified installer, the reseller from whom you purchased the booster, or SureCall.

Chapter 4.

This chapter describes how to install the booster and antennas for best results.

4.1 - Selecting the Locations

Select the locations for the exterior antenna, interior antenna(s), booster, cables, and accessories as described in the previous chapter.



CAUTION: FAILURE TO PROPERLY PLAN THE BOOSTER INSTALLATION CAN CAUSE SIGNAL OSCILLATION AND/OR OTHER EQUIPMENT MALFUNCTION.

4.2 - Soft Installation

Perform a “soft” installation of all components to test signal coverage and oscillation before making the installation permanent. Avoid making holes or other permanent fixtures during this initial phase. Please refer to Chapter 5 of this manual for configuration and testing instructions. Proceed with the final installation once configuration and testing are complete.

4.3 - Exterior Antenna

Mount the exterior antenna in the location you selected during the planning process. Be sure to follow all of the instructions included with the antenna to ensure a safe installation. Remember:

- An omnidirectional antenna (SC-100-L, SC-100-S, etc.) must be mounted vertically.
- A Yagi antenna (such as the SC-230W) must be mounted horizontally and be aimed at the desired cellular tower (line of sight).



CAUTION: MOUNT THE EXTERIOR ANTENNA ON A FIXED STRUCTURE.



WARNING: FAILURE TO EXERCISE CAUTION WHEN WORKING IN HIGH AREAS COULD CAUSE A FALL AND PERSONAL INJURY.



WARNING: DO NOT TOUCH ANY LIVE ELECTRICAL WIRES OR ALLOW THE ANTENNA OR CABLING TO TOUCH ANY LIVE ELECTRICAL WIRES.



CAUTION: AVOID AIMING A YAGI ANTENNA TOWARD ANY INTERIOR ANTENNA.

1. Mount the antenna.
2. Connect a length of SC-400 cable to the
3. Run the cable along the planned route.
4. Install a properly grounded CMLP lightning protector.
5. Seal any holes you make in the outside of the building with appropriate caulking or sealant.

4.4 - Internal Antennas

Mount the interior antenna(s) in the location(s) you selected during the planning process.

Be sure to follow the instructions included with the antenna(s) for a safe installation. Remember:

- Dome antennas (SC-222W, SC-223, etc.) should be mounted in the ceiling as close to the center of the desired coverage area as possible with the domed side pointing down.
- Flat panel antennas (SC-248W) should be wall-mounted as close as possible to center of the wall at one end of long narrow space.



CAUTION: VERIFY THAT ALL INTERIOR ANTENNAS MEET THE SEPARATION REQUIREMENTS DESCRIBED IN THE PREVIOUS CHAPTER AND THAT NO ANTENNA IS AIMED TOWARD THE EXTERIOR ANTENNA.

1. Mount the antenna.
2. Connect a length of SC-400 or SC-240 cable to the antenna and tighten until hand-tight.
3. If you are installing multiple antennas, run the cable to the splitter location and connect the cable to one of the outputs on the splitter.
4. Connect another length of SC-400 or SC-240 cable to the input side of the splitter (if used) and run this cable to the booster location.



CAUTION: DO NOT CONNECT AN INTERIOR ANTENNA TO THE SPLITTER INPUT.

4.5 - Mounting the Booster

Mount the booster as follows:

1. Verify that the selected location meets all of the criteria described in the previous chapter.
2. Attach the included mounting kit to the booster using the screws provided. Tighten the screws by hand with a screwdriver until tight plus 1/4 to 1/2 turn. Do not over-tighten.
3. Mount the booster to the wall using appropriate screws and/or wall anchors. The top side of the booster with the lights and DIP switches should be facing away from the wall and be plainly visible when standing near the booster.
4. Connect the exterior antenna cable to the Outside Antenna port on the booster.
5. Connect the interior antenna cable to the Inside Antenna port on the booster.
6. Verify that all cable connections are tight and that the exterior and interior antennas are connected to the proper jacks.



CAUTION: DO NOT POWER ON THE BOOSTER UNTIL INSTRUCTED TO DO SO.



CAUTION: NEVER POWER ON THE BOOSTER WHEN ANY ANTENNAS ARE DISCONNECTED AS THIS COULD DAMAGE THE BOOSTER.

CHAPTER 5: Configuration & Testing

This chapter describes how to power on, configure, and test the booster.

5.1 - DIP Switches and Lights

The CM2020 Industrial booster has the following indicators and controls:

- PCS Uplink Warning light/DIP switches (1):

These DIP switches control the PCS communications with the cellular tower.

- PCS Downlink Warning light/DIP switches (2):

These DIP switches control the PCS amplification within the building.

- Power light (3): This light should be illuminated or blinking green at all times while the booster is powered on.

- Cellular Downlink Warning light/DIP switches (4): These DIP switches control the cellular amplification within the building.

- Cellular Uplink Warning light/DIP switches (5): These switches control the cellular communications with the tower.

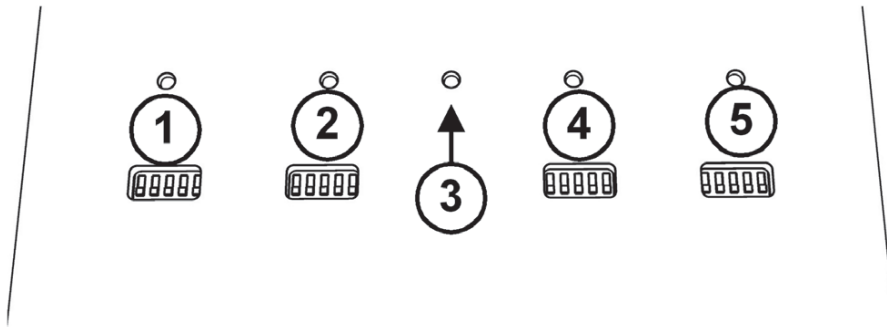

When the booster is powered on:

- The green Power light (3) should illuminate.
- The red Warning lights (1, 2, 4, 5) should remain OFF. If one or more Warning lights illuminate, power off the booster immediately.

Each bank of DIP switches contains five switches.

- Moving a switch down (away from the indicator lights) turns that switch OFF and increases booster gain for the selected channel.
- Moving a switch up (toward the indicator lights) turns that switch ON and decreases booster gain for the selected channel.



From left to right, the DIP switches in each bank provide 1, 2, 4, 8, and 16 dB of attenuation (reduced amplification). These switches are cumulative, meaning that the total amount of attenuation for a channel is equal to the combined dB of all ON DIP switches in the corresponding bank. For example:

- Turning all switches OFF = 0dB attenuation (booster is at full gain).
- Turning ON Switch #1 in a bank = 1dB attenuation (booster maximum gain is reduced by 1dB).
- Turning ON Switches #1, 3, and 5 in a bank = 1+4+16dB attenuation = 21dB attenuation. For example, in a 68dB booster, this means that the selected channel would be reduced to 47dB (68dB-21dB).
- Turning ON all switches in a bank = 1+2+4+8+16dB attenuation = 31dB attenuation. For example, in a 68dB booster, that means that the selected channel would be reduced to 37dB (68dB-31dB).

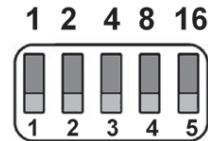

5.2 - Initial Configuration

By default, your booster ships with all DIP switches turned ON to provide maximum gain in all channels. This should always be your starting point whenever installing or reinstalling the booster.

5.3 - Powering on the Booster

To power on the booster:

1. Make sure that exterior and interior antenna cables are snugly connected to the proper ports on the booster.

Configuration & Testing

2. Plug a surge suppressor into a grounded 110VAC wall outlet.
3. Plug the AC end of the power adapter that came with the booster into the surge suppressor.
4. Plug the DC end of the power adapter into the Power port on the booster.



CAUTION: ONLY USE THE POWER SUPPLY INCLUDED WITH THE BOOSTER. USE OF ANOTHER POWER SUPPLY COULD DAMAGE THE BOOSTER AND/OR POWER SUPPLY.

5. Verify that the green Power light is illuminated.
6. If any red Warning light(s) illuminate, immediately power off the booster by either unplugging the DC power supply from the surge suppressor or by turning off the switch on the surge suppressor. Increase the attenuation (reduce gain) to the affected channel(s) and try again. If you are at maximum attenuation and still receiving a warning, then you must verify that all antennas have been placed according to these instructions and relocate antennas as needed to eliminate the oscillation. See Section 5.6 for more information.



CAUTION: DO NOT PROCEED BEYOND THIS POINT UNTIL THE BOOSTER IS POWERED ON AND NO RED WARNING LIGHTS ARE ILLUMINATED.

7. Once the booster is powered on and no red Warning lights are illuminated, you may proceed to adjust the booster.

5.4 – Testing

Once the booster is powered on and no Warning lights are illuminated, walk around the entire area to test the voice and/or data signal. Refine the antenna locations and/or gain levels as needed, and then complete the permanent installation once the system is working as desired.

5.5 - Adjusting the Booster

Keep the following points in mind when adjusting the booster:

- Full power is not always your best option. Your goal is to obtain a usable cellular signal in as many areas of the building as possible. A successful installation means that you can make calls without dropping and/or have a reliable data connection.
- Do not expect to see 5 bars of reception everywhere in the building as this is practically impossible. Also, signal strength in dB can vary significantly without necessarily affecting the number of bars displayed because different phone and data card manufacturers handle bars slightly differently.
- A good rule of thumb is that increasing gain by 6dB doubles the coverage distance of the interior antennas. Start at the lowest gain setting and increase gain gradually as needed.
- If one or more red Warning lights comes on, oscillation is either happening or is about to happen and protection circuits are activating (if equipped). If oscillation is or becomes severe, the booster will power down and will then wake every 30 seconds for the next 15 minutes to see if the problem has been resolved. If the problem has not been resolved after 15 minutes, the booster will shut off and will need to be unplugged and plugged back in again to reset.
- You may see oscillation in the 800MHz band and/or the 1900MHz band (see Section 5.6).
- If you can't get the system to work properly, you may need to install an additional interior antenna and/or a different type of interior antenna and/or relocate interior antennas.

Note: In general, the uplink and downlink DIP switches should be set identically but this is not always the case.

5.6 - Automatic Shutdown

If equipped, the CM2020 booster includes an automatic shutdown feature that works in the following sequence:

1. The cellular side (lights 4 and 5 in the diagram on Page 19) is usually the first side to experience oscillation. When oscillation is detected in the uplink and/or downlink, the appropriate Warning light(s) will begin flashing red and the Power light (light 3 in the diagram on Page 21) will turn red.

2. If oscillation occurs on the PCS side, lights 1 and/or 2 will blink as appropriate and the Power light (3) will turn red if it is not already red because of cellular oscillation.
3. If the problem is not resolved, the affected side will shut down after 30 seconds. In general the cellular side will oscillate more easily than the PCS side.
4. The booster will wake back up. When this occurs, the power light will be green. If oscillation resumes, the lights will flash as previously described. These 30-second cycles will continue for 15 minutes or until the problem is resolved.
5. If the problem is not resolved within 15 minutes, the booster will shut down (all lights off except the Power light, which is red) and must be reset by unplugging it from the power supply and plugging it back in.

To resolve oscillation, increase the antenna separation (Section 3.4) and/or the attenuation (Section 5.1).

CHAPTER 6: Warranty

This chapter contains the warranty information for your SureCall product and also contains information on how to contact the company.

6.1 - Warranty Periods

Your warranty includes the following periods:

- **Three-Year Product Warranty:** SureCall products are covered under a three-year product warranty from the date of purchase. This protects the customer from any defects or problems the product may have that are solely the fault of SureCall. Incorrect installation or misuse will void this warranty. Upon the return of a defective product, SureCall will issue the customer a working replacement. All returned packages should contain all products distributed.
- **Five-Year Extended Product Warranty:** A five year warranty is available for purchase on any products sold by SureCall. A five-year warranty must be obtained at the time of purchase. This warranty adds an additional two years to the three year warranty we provide. All regulations still apply.

Insert Warranty information from previous User's Guide. 6.3 - Contact Information

You may consult a SureCall customer service agent directly by contacting us as follows:

- Our online support center is at www.surecall.com/HelpDeskService.aspx If needed, you can create an online support ticket. This is the fastest and best way to get support for your product.
- Call us at (888)365-6283.

Three-Year Product Warranty

SureCall warrants its products for three years from the date of purchase against defects in workmanship and/or materials. Specifications are subject to change. The three-year warranty only applies to products meeting the latest FCC Certification Guidelines stated on 2/20/2013 and going into effect April 30, 2014. A two-year warranty applies to any products manufactured before May 1, 2014.

Products returned by customers must be in their original, un-modified condition, shipped in the original or protective packaging with proof-of-purchase documentation enclosed, and a Return Merchandise Authorization (RMA) number printed clearly on the outside of the shipping container.

Buyers may obtain an RMA number for warranty returns by calling the SureCall Return Department toll-free at 1-888-365-6283. Any returns received by SureCall without an RMA number clearly printed on the outside of the shipping container will be returned to sender. In order to receive full credit for signal boosters, all accessories originally included in the signal booster box must be returned with the signal booster. (The Buyer does not need to include accessories sold in addition to the signal booster, such as antennas or cables.)

This warranty does not apply to any product determined by SureCall to have been subjected to misuse, abuse, neglect, or mishandling that alters or damages the product's physical or electronic properties.

SureCall warrants to the Buyer that each of its products, when shipped, will be free from defects in material and workmanship, and will perform in full accordance with applicable specifications. The limit of liability under this warranty is, at SureCall's option, to repair or replace any product or part thereof which was purchased up to **THREE YEARS after May 1, 2014 or TWO YEARS for products purchased before May 1, 2014**, as determined by examination by SureCall, prove defective in material and/or workmanship. Warranty returns must first be authorized in writing by SureCall. Disassembly of any SureCall product by anyone other than an authorized representative of SureCall voids this warranty in its entirety. SureCall reserves the right to make changes in any of its products without incurring any obligation to make the same changes on previously delivered products.

As a condition to the warranties provided for herein, the Buyer will prepay the shipping charges for all products returned to SureCall for repair, and SureCall will pay the return shipping with the exception of products returned from outside the United States, in which case the Buyer will pay the shipping charges.

The Buyer will pay the cost of inspecting and testing any goods returned under the warranty or otherwise, which are found to meet the applicable specifications or which are not defective or not covered by this warranty.

Products sold by SureCall shall not be considered defective or non-conforming to the Buyer's order if they satisfactorily fulfill the performance requirements that were published in the product specification literature, or in accordance with samples provided by SureCall. This warranty shall not apply to any products or parts thereof which have been subject to accident, negligence, alteration, abuse, or misuse. SureCall makes no warranty whatsoever in respect to accessories or parts not supplied by it.

Limitations of Warranty, Damages and Liability:

EXCEPT AS EXPRESSLY SET FORTH HEREIN, THERE ARE NO WARRANTIES, CONDITIONS, GUARANTEES, OR REPRESENTATIONS AS TO MERCHANTABILITY, FITNESS FOR A PARTICULAR PURPOSE, OR OTHER WARRANTIES, CONDITIONS, GUARANTEES, OR REPRESENTATIONS, WHETHER EXPRESSED OR IMPLIED, IN LAW OR IN FACT, ORAL OR IN WRITING. SURECALL AGGREGATE LIABILITY IN DAMAGES OR OTHERWISE SHALL NOT EXCEED THE PAYMENT, IF ANY, RECEIVED BY CELLPHONE-MATE, INC. FOR THE UNIT OF PRODUCT OR SERVICE FURNISHED OR TO BE FURNISHED, AS THE CASE MAY BE, WHICH IS THE SUBJECT OF CLAIM OR DISPUTE. IN NO EVENT SHALL SURECALL BE LIABLE FOR INCIDENTAL, CONSEQUENTIAL, OR SPECIAL DAMAGES, HOWSOEVER CAUSED.

All matters regarding this warranty shall be interpreted in accordance with the laws of the State of California, and any controversy that cannot be settled directly shall be settled by arbitration in California in accordance with the rules then prevailing of the American Arbitration Association, and judgment upon the award rendered may be entered in any court having jurisdiction thereof. If one or more provisions provided herein are held to be invalid or unenforceable under applicable law, then such provision shall be ineffective and excluded to the extent of such invalidity or unenforceability without affecting in any way the remaining provisions hereof.

WARNING: E911 location information may not be provided or may be inaccurate for calls served BY USING THIS DEVICE.

48346 Milmont Drive
Fremont, California 94538
USA
888.365.6283
Fax: 510.996.7250
www.surecall.com

SureCall has made a good faith effort to ensure the accuracy of the information in this document and disclaims the implied warranties of merchantability and fitness for a particular purpose and makes no express warranties, except as may be stated in its written agreement with and for its customers. SureCall shall not be held liable to anyone for any indirect, special or consequential damages due to omissions or errors. The information and specifications in this document are subject to change without notice. © 2014. All Rights Reserved. All trademarks and registered trademarks are the property of their respective owners.