



SPORTON International Inc.

No. 52, Huaya 1st Rd., Guishan Dist., Taoyuan City, Taiwan (R.O.C.)
Ph: 886-3-327-3456 / FAX: 886-3-327-0973 / www.sporton.com.tw

FCC RADIO TEST REPORT

Applicant's company	Allied Telesis K.K
Applicant Address	2nd. TOC Bldg. 7-21-11 Nishi-Gotanda, Shinagawa-ku, Tokyo Japan, 141-0031
FCC ID	RSL-MWS2533AP
Manufacturer's company	Senao Networks, Inc.
Manufacturer Address	3F, No. 529, Chung Cheng Rd., Hsintien, Taipei, Taiwan

Product Name	IEEE 802.a/b/g/n/ac Managed Wireless Access Point
Brand Name	
Model No.	AT-MWS2533AP
Test Rule Part(s)	47 CFR FCC Part 15 Subpart E § 15.407
Test Freq. Range	5250 ~ 5350MHz / 5470 ~ 5725MHz
Received Date	Oct. 15, 2015
Final Test Date	Oct. 12, 2017
Submission Type	Class II Change

Statement

Test result included is for the IEEE 802.11n and IEEE 802.11a/ac of the product.

The test result in this report refers exclusively to the presented test model / sample.

Without written approval of SPORTON International Inc., the test report shall not be reproduced except in full.

The measurements and test results shown in this test report were made in accordance with the procedures and found in compliance with the limit given in **ANSI C63.10-2013**,

47 CFR FCC Part 15 Subpart E, KDB789033 D02 v01, KDB662911 D01 v02r01, KDB644545 D03 v01.

The test equipment used to perform the test is calibrated and traceable to NML/ROC.



Table of Contents

1. CERTIFICATION OF COMPLIANCE	1
2. SUMMARY OF THE TEST RESULT	2
3. GENERAL INFORMATION	3
3.1. Product Details	3
3.2. Table for Filed Antenna	6
3.3. Table for Carrier Frequencies	7
3.4. Table for Test Modes	8
3.5. Table for Testing Locations.....	10
3.6. Table for Class II Change	11
3.7. Table for Supporting Units	12
3.8. Table for Parameters of Test Software Setting	13
3.9. EUT Operation during Test	14
3.10. Duty Cycle.....	14
3.11. Test Configurations.....	15
4. TEST RESULT.....	18
4.1. AC Power Line Conducted Emissions Measurement	18
4.2. 26dB Bandwidth and 99% Occupied Bandwidth Measurement	22
4.3. 6dB Spectrum Bandwidth Measurement	37
4.4. Maximum Conducted Output Power Measurement.....	41
4.5. Power Spectral Density Measurement.....	62
4.6. Radiated Emissions Measurement.....	75
4.7. Band Edge Emissions Measurement.....	107
4.8. Frequency Stability Measurement.....	119
4.9. Antenna Requirements	127
5. LIST OF MEASURING EQUIPMENTS.....	128
6. MEASUREMENT UNCERTAINTY	130
APPENDIX A. TEST PHOTOS	
APPENDIX B. RADIATED EMISSION CO-LOCATION REPORT	
PHOTOGRAPHS OF EUT V01	



History of This Test Report

REPORT NO.	VERSION	DESCRIPTION	ISSUED DATE
FR720735-02AA	Rev. 01	Initial issue of report	Oct. 24, 2017

1. CERTIFICATION OF COMPLIANCE

Product Name : IEEE 802.a/b/g/n/ac Managed Wireless Access Point

Brand Name : 

Model No. : AT-MWS2533AP

Applicant : Allied Telesis K.K

Test Rule Part(s) : 47 CFR FCC Part 15 Subpart E § 15.407

Sporton International as requested by the applicant to evaluate the EMC performance of the product sample received on Oct. 15, 2015 would like to declare that the tested sample has been evaluated and found to be in compliance with the tested rule parts. The data recorded as well as the test configuration specified is true and accurate for showing the sample's EMC nature.



Phoenix Chen/Assistant Manager

SPORTON INTERNATIONAL INC.

2. SUMMARY OF THE TEST RESULT

Applied Standard: 47 CFR FCC Part 15 Subpart E				
Part	Rule Section	Description of Test	Result	Under Limit
4.1	15.207	AC Power Line Conducted Emissions	Complies	5.3 dB
4.2	15.407(a)	26dB Spectrum Bandwidth and 99% Occupied Bandwidth	Complies	-
4.3	15.407(e)	6dB Spectrum Bandwidth	Complies	-
4.4	15.407(a)	Maximum Conducted Output Power	Complies	0.05 dB
4.5	15.407(a)	Power Spectral Density	Complies	0.01 dB
4.6	15.407(b)	Radiated Emissions	Complies	4.07 dB
4.7	15.407(b)	Band Edge Emissions	Complies	1.02 dB
4.8	15.407(g)	Frequency Stability	Complies	-
4.9	15.203	Antenna Requirements	Complies	-

3. GENERAL INFORMATION

3.1. Product Details

Items	Description
Product Type	WLAN (4TX, 4RX)
Radio Type	Intentional Transceiver
Power Type	From power adapter or PoE
Modulation	IEEE 802.11a: OFDM IEEE 802.11n/ac: see the below table
Data Modulation	IEEE 802.11a/n: OFDM (BPSK / QPSK / 16QAM / 64QAM) IEEE 802.11ac: OFDM (BPSK / QPSK / 16QAM / 64QAM / 256QAM)
Data Rate (Mbps)	IEEE 802.11a: OFDM (6/9/12/18/24/36/48/54) IEEE 802.11n/ac: see the below table
Frequency Range	5250 ~ 5350MHz / 5470 ~ 5725MHz
Channel Number	16 for 20MHz bandwidth ; 8 for 40MHz bandwidth 4 for 80MHz bandwidth
Channel Band Width (99%)	Mode 1: PIFA Antenna / Chain1:5.84 dBi, Chain2:5.50 dBi, Chain3:5.84 dBi, Chain4:5.65 dBi Band 2: IEEE 802.11a: 16.32 MHz IEEE 802.11ac MCS0/Nss1 (VHT20): 17.45 MHz IEEE 802.11ac MCS0/Nss1 (VHT40): 36.32 MHz IEEE 802.11ac MCS0/Nss1 (VHT80): 75.83 MHz Band 3: IEEE 802.11a: 16.41 MHz IEEE 802.11ac MCS0/Nss1 (VHT20): 17.45 MHz IEEE 802.11ac MCS0/Nss1 (VHT40): 36.32 MHz IEEE 802.11ac MCS0/Nss1 (VHT80): 76.12 MHz

Maximum Conducted Output Power	Mode 1: PIFA Antenna / Chain1:5.84 dBi, Chain2:5.50 dBi, Chain3:5.84 dBi, Chain4:5.65 dBi Band 2: IEEE 802.11a: 18.45 dBm IEEE 802.11ac MCS0/Nss1 (VHT20): 18.28 dBm IEEE 802.11ac MCS0/Nss1 (VHT40): 21.14 dBm IEEE 802.11ac MCS0/Nss1 (VHT80): 16.46 dBm Band 3: IEEE 802.11a: 18.67 dBm IEEE 802.11ac MCS0/Nss1 (VHT20): 18.36 dBm IEEE 802.11ac MCS0/Nss1 (VHT40): 21.35 dBm IEEE 802.11ac MCS0/Nss1 (VHT80): 23.95 dBm
Carrier Frequencies	Please refer to section 3.4
Antenna	Please refer to section 3.3

Items	Description	
Communication Mode	<input checked="" type="checkbox"/> IP Based (Load Based)	<input type="checkbox"/> Frame Based
TPC Function	<input checked="" type="checkbox"/> With TPC	<input type="checkbox"/> Without TPC
Weather Band (5600~5650MHz)	<input checked="" type="checkbox"/> With 5600~5650MHz	<input type="checkbox"/> Without 5600~5650MHz
Operating Mode	<input type="checkbox"/> Outdoor access point	
	<input checked="" type="checkbox"/> Indoor access point	
	<input type="checkbox"/> Fixed point-to-point access points	
	<input type="checkbox"/> Mobile and portable client devices	

Antenna and Band width

Antenna	Four (TX)		
	20 MHz	40 MHz	80 MHz
Band width Mode	20 MHz	40 MHz	80 MHz
IEEE 802.11a	V	X	X
IEEE 802.11n	V	V	X
IEEE 802.11ac	V	V	V

IEEE 11n/ac Spec.

Protocol	Number of Transmit Chains (NTX)	Data Rate / MCS
802.11n (HT20)	4	MCS 0-31
802.11n (HT40)	4	MCS 0-31
802.11ac (VHT20)	4	MCS 0-8/Nss1-4
802.11ac (VHT40)	4	MCS 0-9/Nss1-4
802.11ac (VHT80)	4	MCS 0-9/Nss1-4

Note 1: IEEE Std. 802.11n modulation consists of HT20 and HT40 (HT: High Throughput).

Then EUT supports HT20 and HT40.

Note 2: IEEE Std. 802.11ac modulation consists of VHT20, VHT40, VHT80 and VHT160 (VHT: Very High Throughput). Then EUT supports VHT20, VHT40 and VHT80 in 5GHz.

Note 3: Modulation modes consist of below configuration:

HT20/HT40: IEEE 802.11n, VHT20/VHT40/VHT80: IEEE 802.11ac

3.2. Table for Filed Antenna

Set.	Brand Holder	Model Number (Part No.)	Extreme Part No. (Short Description)	Antenna Type	Connector	Polarized Antenna	Gain (dBi)	
							2.4GHz	5GHz
1	Senao Networks, Inc.	AP3935i	-	PIFA Antenna	IPEX	X	Note 1	

Note1:

Set.	Antenna Gain (dBi)							
	2.4GHz				5GHz			
	Chain 1	Chain 2	Chain 3	Chain 4	Chain 1	Chain 2	Chain 3	Chain 4
1	3.81	3.75	3.98	3.47	5.84	5.50	5.84	5.65

Note2:

The EUT has ten sets of antennas.

<For 2.4GHz Function>

For IEEE 802.11b/g/n/ac mode (4TX, 4RX):

Chain 1, Chain 2, Chain 3 and Chain 4 could transmit/receive simultaneously.

<For 5GHz Function>

For IEEE 802.11a/n/ac mode (4TX, 4RX):

Chain 1, Chain 2, Chain 3 and Chain 4 could transmit/receive simultaneously.

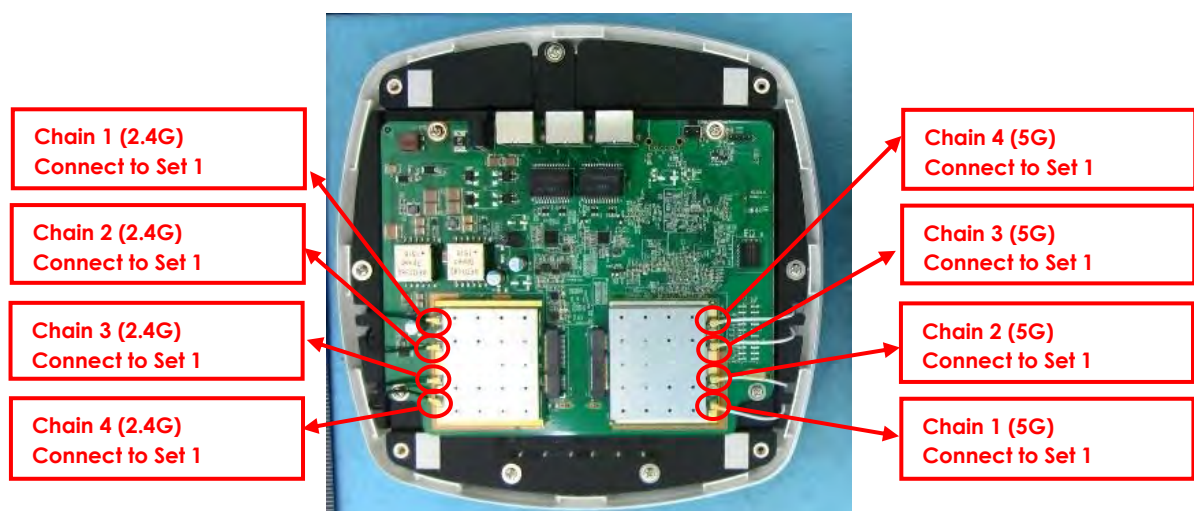

3.3. Table for Carrier Frequencies

There are three bandwidth systems.

For 20MHz bandwidth systems, use Channel 52, 56, 60, 64, 100, 104, 108, 112, 116, 120, 124, 128, 132, 136, 140, 144.

For 40MHz bandwidth systems, use Channel 54, 62, 102, 110, 118, 126, 134, 142.

For 80MHz bandwidth systems, use Channel 58, 106, 122, 138.

Frequency Band	Channel No.	Frequency	Channel No.	Frequency
5250~5350 MHz Band 2	52	5260 MHz	60	5300 MHz
	54	5270 MHz	62	5310 MHz
	56	5280 MHz	64	5320 MHz
	58	5290 MHz	-	-
5470~5725 MHz Band 3	100	5500 MHz	124	5620 MHz
	102	5510 MHz	126	5630 MHz
	104	5520 MHz	128	5640 MHz
	106	5530 MHz	132	5660 MHz
	108	5540 MHz	134	5670 MHz
	110	5550 MHz	136	5680 MHz
	112	5560 MHz	138	5690 MHz
	116	5580 MHz	140	5700 MHz
	118	5590 MHz	142	5710 MHz
	120	5600 MHz	144	5720 MHz
	122	5610 MHz	-	-

3.4. Table for Test Modes

Preliminary tests were performed in different data rate to find the worst radiated emission. The data rate shown in the table below is the worst-case rate with respect to the specific test item. Investigation has been done on all the possible configurations for searching the worst cases. The following table is a list of the test modes shown in this test report.

Test Items	Mode		Data Rate	Channel	Chain
AC Power Conducted Emission	Normal Link		-	-	-
Max. Conducted Output Power	11a/BPSK	Band 2-3	6Mbps	52/60/64/100/ 116/140/144	1+2+3+4
	11ac VHT20	Band 2-3	MCS0/Nss 1	52/60/64/100/ 116/140/144	1+2+3+4
	11ac VHT40	Band 2-3	MCS0/Nss 1	54/62/102/110/ 134/142	1+2+3+4
	11ac VHT80	Band 2-3	MCS0/Nss 1	58/106/122/13 8	1+2+3+4
Power Spectral Density	11a/BPSK	Band 2-3	6Mbps	52/60/64/100/ 116/140/144	1+2+3+4
	11ac VHT20	Band 2-3	MCS0/Nss 1	52/60/64/100/ 116/140/144	1+2+3+4
	11ac VHT40	Band 2-3	MCS0/Nss 1	54/62/102/110/ 134/142	1+2+3+4
	11ac VHT80	Band 2-3	MCS0/Nss 1	58/106/122/13 8	1+2+3+4
26dB Spectrum Bandwidth 99% Occupied Bandwidth Measurement	11a/BPSK	Band 2-3	6Mbps	52/60/64/100/ 116/140/144	1+2+3+4
	11ac VHT20	Band 2-3	MCS0/Nss 1	52/60/64/100/ 116/140/144	1+2+3+4
	11ac VHT40	Band 2-3	MCS0/Nss 1	54/62/102/110/ 134/142	1+2+3+4
	11ac VHT80	Band 2-3	MCS0/Nss 1	58/106/122/13 8	1+2+3+4
6dB Spectrum Bandwidth Measurement	11a/BPSK	Band 3	6Mbps	144	1+2+3+4
	11ac VHT20	Band 3	MCS0/Nss 1	144	1+2+3+4
	11ac VHT40	Band 3	MCS0/Nss 1	142	1+2+3+4

	11ac VHT80	Band 3	MCS0/Nss 1	138	1+2+3+4
Radiated Emission Below 1GHz	11ac VHT80	Band 2-3	MCS0/Nss 1	122/155	1+2+3+4
Radiated Emission Above 1GHz	11a/BPSK	Band 2-3	6Mbps	52/60/64/100/ 116/140/144	1+2+3+4
	11ac VHT20	Band 2-3	MCS0/Nss 1	52/60/64/100/ 116/140/144	1+2+3+4
	11ac VHT40	Band 2-3	MCS0/Nss 1	54/62/102/110/ 134/142	1+2+3+4
	11ac VHT80	Band 2-3	MCS0/Nss 1	58/106/122/13 8	1+2+3+4
Band Edge Emission	11a/BPSK	Band 2-3	6Mbps	52/60/64/100/ 116/140/144	1+2+3+4
	11ac VHT20	Band 2-3	MCS0/Nss 1	52/60/64/100/ 116/140/144	1+2+3+4
	11ac VHT40	Band 2-3	MCS0/Nss 1	54/62/102/110/ 134/142	1+2+3+4
	11ac VHT80	Band 2-3	MCS0/Nss 1	58/106/122/13 8	1+2+3+4
Frequency Stability	20 MHz	Band 2-3	-	60/116	3, 4
	40 MHz	Band 2-3	-	62/110	3, 4
	80 MHz	Band 2-3	-	58/106	3, 4

Note1: VHT20/VHT40 covers HT20/HT40, due to same modulation. The power setting for 802.11n HT20 and HT40 are the same or lower than 802.11ac VHT20 and VHT40.

Note2:

The adapter and PoE are for measurement only, would not be marketed.

The adapter and PoE information as below:

Power	Brand	Model
Adapter	APD	WA-24Q12R
PoE	Microsemi	PD-9001GR

Note3: All the specification of test configurations and test modes were based on customer's request.

Note4: The console port can not be used by end user. It is generally used for updating FW by professional installer.

The following test modes were performed for all tests:

For Conducted Emission test:

Mode 1. Normal Link+ Adapter

For Radiated Emission Below 1GHz test:

Mode 1. Place EUT in Z axis + Adapter

Mode 2. Place EUT in Z axis + PoE

Mode 1 is the worst case, so it was selected to record in this test report.

For Radiated Emission Above 1GHz test:

The Mode 1 was performed at Y axis and Z axis position. Y axis has been evaluated to be the worst case, thus measurement will follow this same test mode.

Mode 1. Place EUT in Y axis

For Co-location MPE and Radiated Emission Co-location Test:

The EUT could be applied with 2.4GHz WLAN function and 5GHz WLAN function; therefore Co-location Maximum Permissible Exposure (Please refer to FA720735-01AB) and Radiated Emission Co-location (please refer to Appendix B) tests are added for simultaneously transmit between 2.4GHz WLAN function and 5GHz WLAN function.

3.5. Table for Testing Locations

Test Site Location					
Address:	No.8, Lane 724, Bo-ai St., Jhubei City, Hsinchu County 302, Taiwan, R.O.C.				
TEL:	886-3-656-9065				
FAX:	886-3-656-9085				
Test Site No.	Site Category	Location	FCC Reg. No.	IC File No.	VCCI Reg. No
03CH01-CB	SAC	Hsin Chu	262045	IC 4086D	-
TH01-CB	OVEN Room	Hsin Chu	-	-	-

Open Area Test Site (OATS); Semi Anechoic Chamber (SAC).

Testing Location		
<input checked="" type="checkbox"/>	HWA YA	ADD : No. 52, Huaya 1st Rd., Guishan Dist., Taoyuan City, Taiwan (R.O.C.)
		TEL : 886-3-327-3456 FAX : 886-3-327-0973
Test site Designation No. TW1190 with FCC.		

Test Condition	Test Site No.	Test Engineer	Test Environment	Test Date
Radiated	03CH02-HY	Lynus Tsai	22.5°C / 55%	12/Oct/2017
AC Conduction	CO04-HY	Teddy Chang	22°C / 55%	15/Aug/2017

3.6. Table for Class II Change

This product is an extension of original one reported under Sporton project number: FR720735-01AB

Below is the table for the change of the product with respect to the original one.

Modifications	Performance Checking
<ol style="list-style-type: none"> 1. Add Band 2 and Band 3 (5250~5350 MHz, 5470~5725 MHz) 2. Product name was changed 	<ol style="list-style-type: none"> 1. AC Power Line Conduction Emissions 2. 26dB Bandwidth and 99% Occupied Bandwidth Measurement 3. 6dB Spectrum Bandwidth Measurement 4. Maximum Conducted Output Power Measurement 5. Power Spectral Density Measurement 6. Radiated Emissions 7. Band Edge Emissions Measurement 8. Frequency Stability Measurement

3.7. Table for Supporting Units

For Test Site No: 03CH01-CB

Support Unit	Brand	Model	FCC ID
Notebook	DELL	E4300	DoC
Adapter	Powertron Electronics Corp.	PA1024-120IB200	N/A

For Test Site No: TH01-CB

Support Unit	Brand	Model	FCC ID
Notebook	DELL	E4300	DoC
Adapter	Powertron Electronics Corp.	PA1024-120IB200	N/A

For Test Site No: CO04-HY

Support Unit	Brand	Model	FCC ID
Adapter (Client Provided)	APD	WA-24Q12R	N/A
Dummy Load	-	-	N/A
Notebook	DELL	E5430	DoC
Notebook(5G)	DELL	P55G	DoC

3.8. Table for Parameters of Test Software Setting

During testing, Channel and Power Controlling Software provided by the customer was used to control the operating channel as well as the output power level. The RF output power selection is for the setting of RF output power expected by the customer and is going to be fixed on the firmware of the final end product.

Mode: PIFA Antenna / Chain1:5.84 dBi, Chain2:5.50 dBi, Chain3:5.84 dBi, Chain4:5.65 dBi

Test Software Version	QCA VER3.0.144.0						
Mode	Test Frequency (MHz)						
	NCB: 20MHz						
	5260 MHz	5300 MHz	5320 MHz	5500 MHz	5580 MHz	5700 MHz	5720 MHz
802.11a	12	12	13	13	12	12	13
802.11ac MCS0/Nss1 VHT20	12.5	12.5	12.5	12.5	12.5	12.5	13
Mode	NCB: 40MHz						
802.11ac MCS0/Nss1 VHT40	5270 MHz	5310 MHz	5510 MHz	5550 MHz	5670 MHz	5710 MHz	
	14.5	11.5	14.5	14.5	14.5	15	
Mode	NCB: 80MHz						
802.11ac MCS0/Nss1 VHT80	5290 MHz		5530 MHz		5610 MHz		5690 MHz
	12		11		17		18.5

3.9. EUT Operation during Test

The EUT was programmed to be in continuously transmitting mode.

3.10. Duty Cycle

Mode	On Time (ms)	On+Off Time (ms)	Duty Cycle (%)	Duty Factor (dB)	1/T Minimum VBW (kHz)
802.11a	4.974	5.064	98.22	0.08	0.01
802.11ac MCS0/Nss1 VHT20	2.320	2.420	95.87	0.18	0.43
802.11ac MCS0/Nss1 VHT40	1.110	1.200	92.50	0.34	0.90
802.11ac MCS0/Nss1 VHT80	2.058	2.128	96.71	0.15	0.49

3.11. Test Configurations

3.11.1. AC Power Line Conduction Emissions Test Configuration

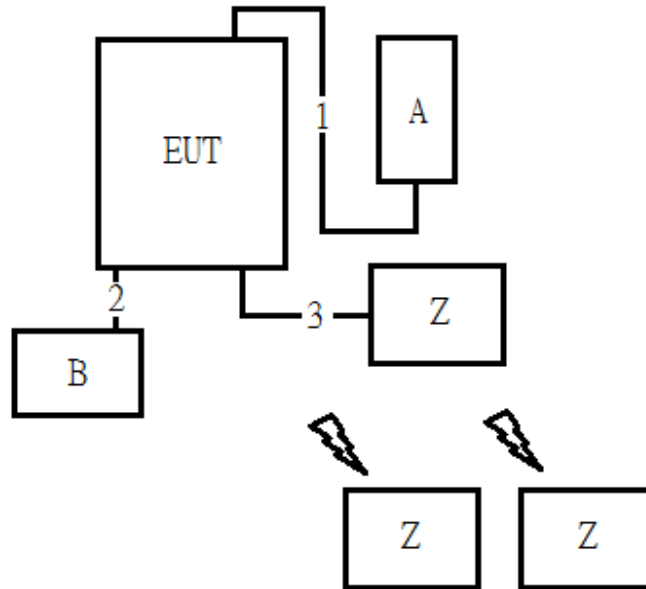

Item	Connection	Shielded	Length(m)
1	DC Power Cable	No	1.5
2	RJ45 Cable	No	1
3	RJ45 Cable	No	10

No.	Equipment	Brand	Model	FCC ID
A	Adapter	APD	WA-24Q12R	N/A
B	Dummy Load	-	-	N/A
Z	NoteBook	DELL	E5430	DoC
Z	NoteBook(2.4G)	DELL	P55G	DoC
Z	NoteBook(5G)	DELL	P55G	DoC

3.11.2. Radiation Emissions Test Configuration

Test Configuration: 30MHz ~1GHz

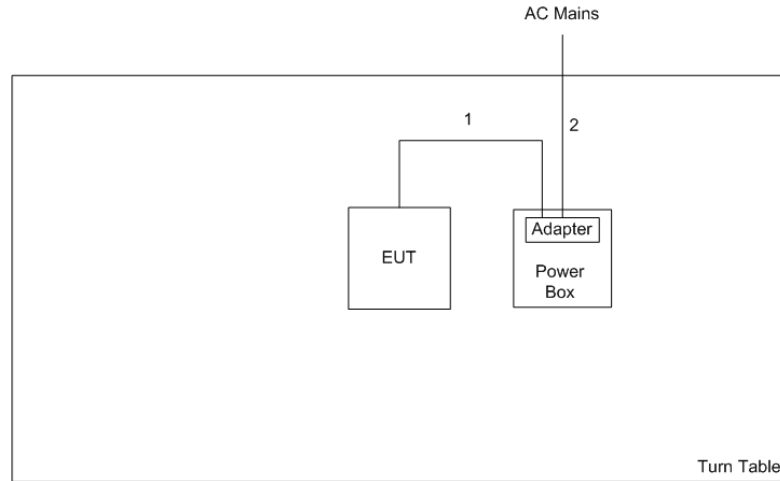

Item	Connection	Shielded	Length(m)
1	DC Power line	No	1.5m
2	AC Power line	No	1.8m

Test Configuration: above 1GHz

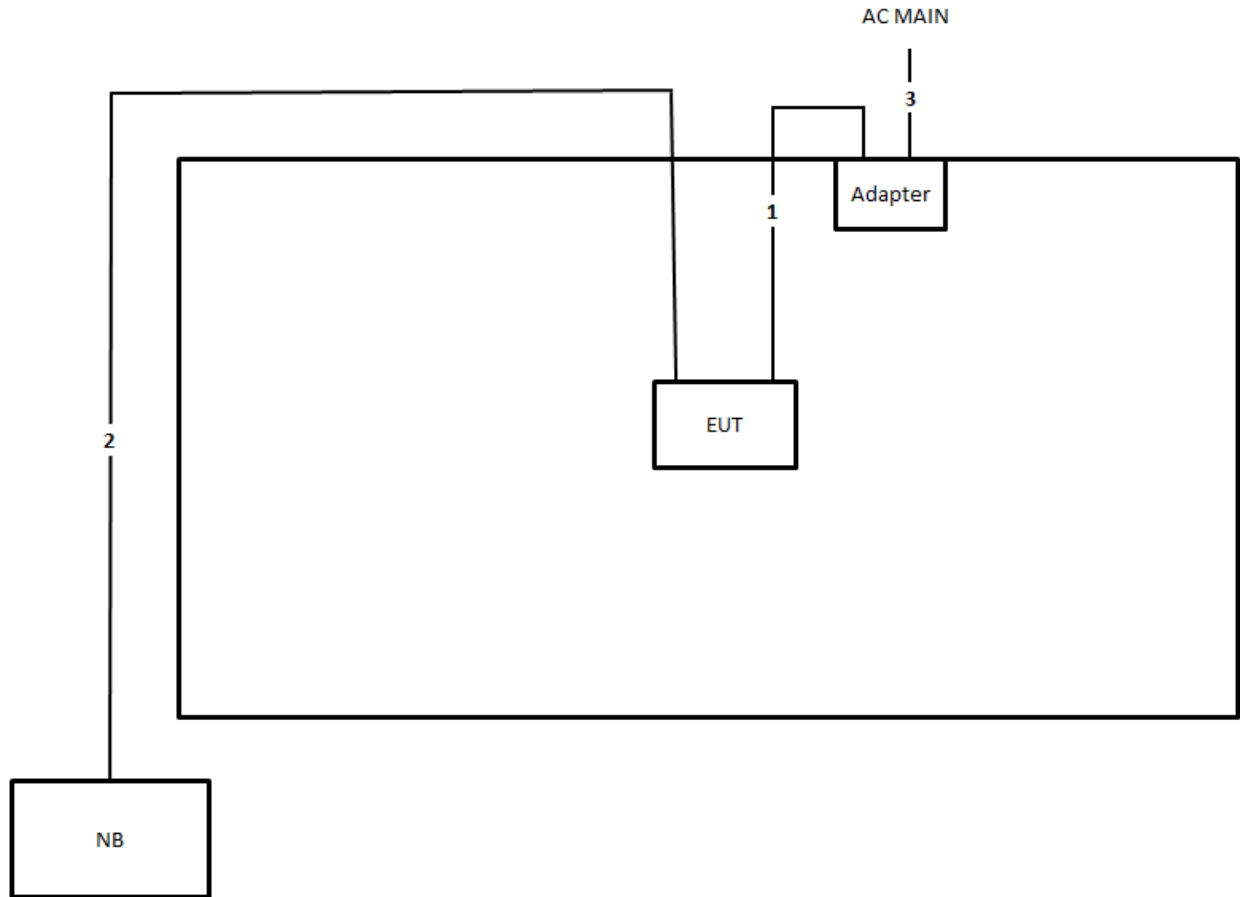

Item	Connection	Shielded	Length(m)
1	DC Power cable	No	1.2
2	RJ-45 cable	No	10
3	AC Power cable	No	1.8

4. TEST RESULT

4.1. AC Power Line Conducted Emissions Measurement

4.1.1. Limit

For this product that is designed to connect to the AC power line, the radio frequency voltage that is conducted back onto the AC power line on any frequency or frequencies within the band 150 kHz to 30 MHz shall not exceed below limits table.

Frequency (MHz)	QP Limit (dBuV)	AV Limit (dBuV)
0.15~0.5	66~56	56~46
0.5~5	56	46
5~30	60	50

4.1.2. Measuring Instruments and Setting

Please refer to section 5 of equipments list in this report. The following table is the setting of the receiver.

Receiver Parameters	Setting
Attenuation	10 dB
Start Frequency	0.15 MHz
Stop Frequency	30 MHz
IF Bandwidth	9 kHz

4.1.3. Test Procedures

1. Configure the EUT according to ANSI C63.10. The EUT or host of EUT has to be placed 0.4 meter far from the conducting wall of the shielding room and at least 80 centimeters from any other grounded conducting surface.
2. Connect EUT or host of EUT to the power mains through a line impedance stabilization network (LISN).
3. All the support units are connected to the other LISNs. The LISN should provide 50uH/50ohms coupling impedance.
4. The frequency range from 150 kHz to 30 MHz was searched.
5. Set the test-receiver system to Peak Detect Function and Specified Bandwidth with Maximum Hold Mode.
6. The measurement has to be done between each power line and ground at the power terminal.

4.1.4. Test Setup Layout

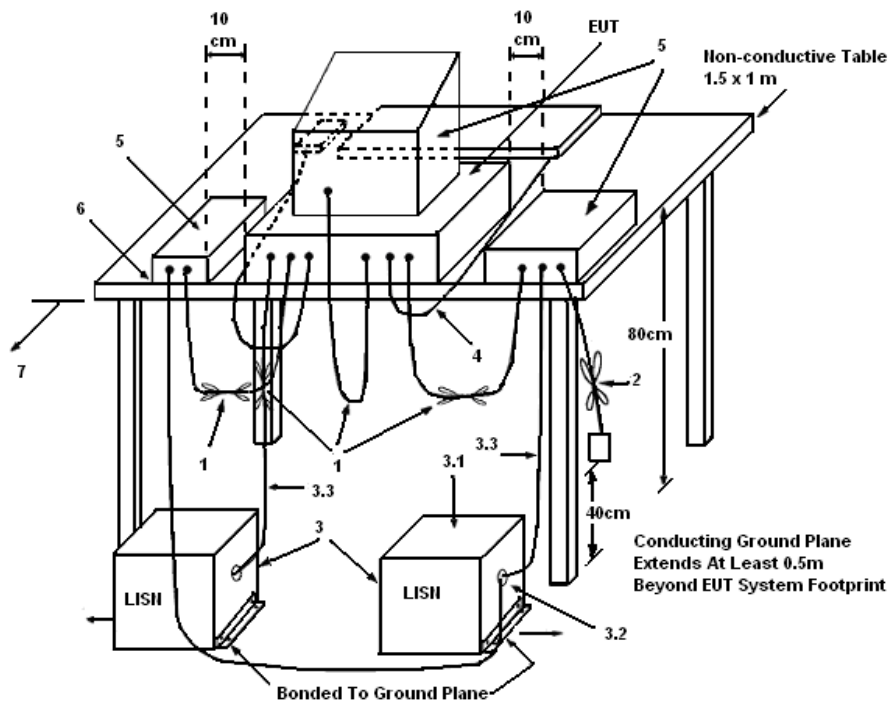

LEGEND:

- (1) Interconnecting cables that hang closer than 40 cm to the ground plane shall be folded back and forth in the center forming a bundle 30 to 40 cm long.
- (2) I/O cables that are not connected to a peripheral shall be bundled in the center. The end of the cable may be terminated, if required, using the correct terminating impedance. The overall length shall not exceed 1 m.
- (3) EUT connected to one LISN. Unused LISN measuring port connectors shall be terminated in 50Ω . LISN can be placed on top of, or immediately beneath, reference ground plane.
 - (3.1) All other equipment powered from additional LISN(s).
 - (3.2) Multiple outlet strip can be used for multiple power cords of non-EUT equipment.
 - (3.3) LISN at least 80 cm from nearest part of EUT chassis.
- (4) Cables of hand-operated devices, such as keyboards, mice, etc., shall be placed as for normal use.
- (5) Non-EUT components of EUT system being tested.
- (6) Rear of EUT, including peripherals, shall all be aligned and flush with rear of tabletop.
- (7) Rear of tabletop shall be 40 cm removed from a vertical conducting plane that is bonded to the ground plane.

4.1.5. Test Deviation

There is no deviation with the original standard.

4.1.6. EUT Operation during Test

The EUT was placed on the test table and programmed in normal function.

4.1.7. Results of AC Power Line Conducted Emissions Measurement

Temperature	22°C	Humidity	55%
Test Engineer	Teddy Chang	Phase	Line
Configuration	Normal Link	Test Mode	Mode 1

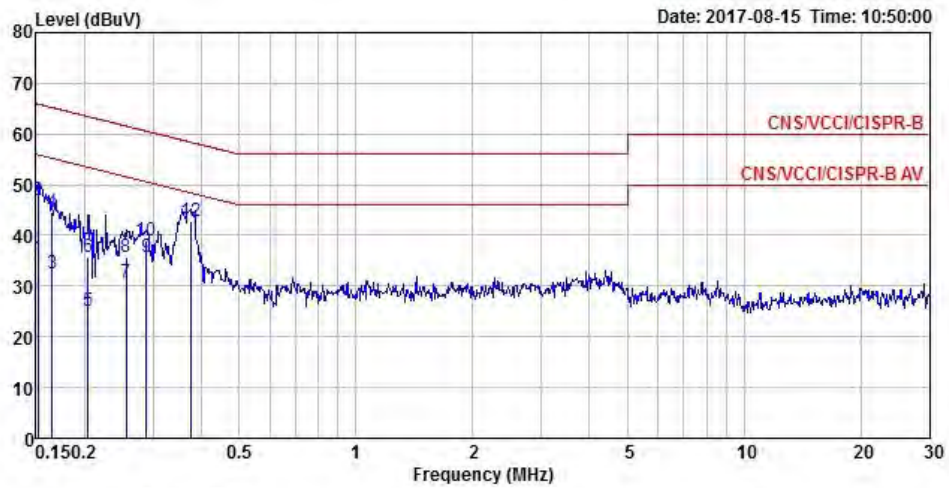

	Freq	Level	Over	Limit	Read	LISN	Cable	Remark
	MHz	dBuV	Limit	Line	Level	Factor	Loss	
			dB	dBuV	dBuV	dB	dB	
1	0.15	35.31	-20.60	55.91	25.43	9.66	0.22	Average
2	0.15	46.88	-19.03	65.91	37.00	9.66	0.22	QP
3	0.17	32.33	-22.88	55.21	22.42	9.66	0.25	Average
4	0.17	44.48	-20.73	65.21	34.57	9.66	0.25	QP
5	0.20	25.00	-28.45	53.45	15.06	9.65	0.29	Average
6	0.20	35.68	-27.77	63.45	25.74	9.65	0.29	QP
7	0.26	30.65	-20.91	51.56	20.76	9.66	0.23	Average
8	0.26	35.75	-25.81	61.56	25.86	9.66	0.23	QP
9	0.29	35.66	-14.93	50.59	25.79	9.67	0.20	Average
10	0.29	38.83	-21.76	60.59	28.96	9.67	0.20	QP
11	MAX	0.38	41.35	-7.04	48.39	31.55	9.68	Average
12		0.38	42.86	-15.53	58.39	33.06	9.68	QP

Temperature	22°C	Humidity	55%
Test Engineer	Teddy Chang	Phase	Neutral
Configuration	Normal Link	Test Mode	Mode 1

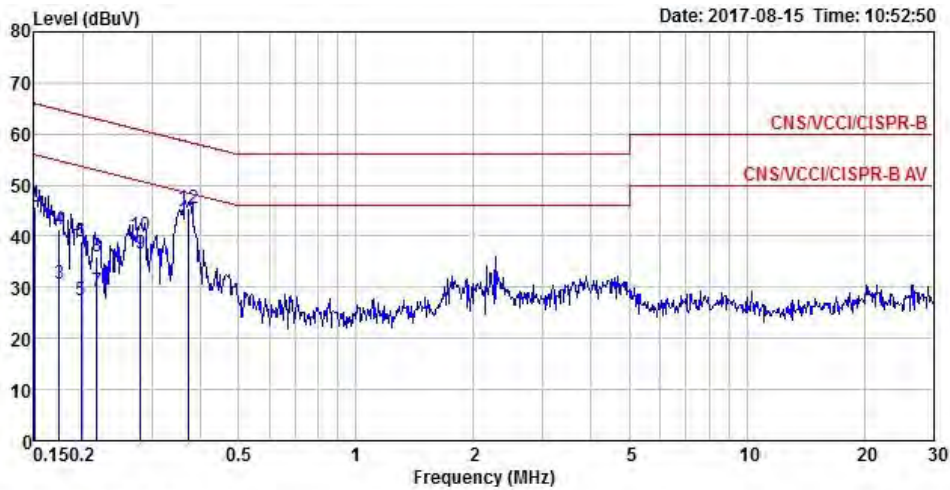

	Freq	Level	Over	Limit	Read	LISN	Cable	Remark
	MHz	dBuV	Limit	Line	Level	Factor	Loss	
			dB	dBuV	dBuV	dB	dB	
1	0.15	34.62	-21.38	56.00	24.80	9.60	0.22	Average
2	0.15	45.82	-20.18	66.00	36.00	9.60	0.22	QP
3	0.17	30.67	-24.10	54.77	20.77	9.64	0.26	Average
4	0.17	41.35	-23.42	64.77	31.45	9.64	0.26	QP
5	0.20	27.43	-26.28	53.71	17.46	9.67	0.30	Average
6	0.20	39.01	-24.70	63.71	29.04	9.67	0.30	QP
7	0.22	29.30	-23.62	52.92	19.37	9.66	0.27	Average
8	0.22	36.02	-26.90	62.92	26.09	9.66	0.27	QP
9	0.28	36.73	-14.08	50.81	26.88	9.65	0.20	Average
10	0.28	40.02	-20.79	60.81	30.17	9.65	0.20	QP
11	MAX	0.37	43.17	-5.30	48.47	33.42	9.63	Average
12		0.37	45.52	-12.95	58.47	35.77	9.63	QP

Note:

Level = Read Level + LISN Factor + Cable Loss.

4.2. 26dB Bandwidth and 99% Occupied Bandwidth Measurement

4.2.1. Limit

No restriction limits.

4.2.2. Measuring Instruments and Setting

Please refer to section 5 of equipments list in this report. The following table is the setting of the spectrum analyzer.

26dB Bandwidth	
Spectrum Parameters	Setting
Attenuation	Auto
Span Frequency	> 26dB Bandwidth
RBW	Approximately 1% of the emission bandwidth
VBW	VBW > RBW
Detector	Peak
Trace	Max Hold
Sweep Time	Auto
99% Occupied Bandwidth	
Spectrum Parameters	Setting
Span	1.5 times to 5.0 times the OBW
RBW	1 % to 5 % of the OBW
VBW	$\geq 3 \times \text{RBW}$
Detector	Peak
Trace	Max Hold

4.2.3. Test Procedures

For Radiated 26dB Bandwidth and 99% Occupied Bandwidth Measurement:

1. The transmitter was radiated to the spectrum analyzer in peak hold mode.
2. Measure the maximum width of the emission that is 26 dB down from the peak of the emission. Compare this with the RBW setting of the analyzer. Readjust RBW and repeat measurement as needed until the RBW/EBW ratio is approximately 1%.

4.2.4. Test Setup Layout

For Radiated 26dB Bandwidth and 99% Occupied Bandwidth Measurement:

This test setup layout is the same as that shown in section 4.6.4.

4.2.5. Test Deviation

There is no deviation with the original standard.

4.2.6. EUT Operation during Test

The EUT was programmed to be in continuously transmitting mode.

4.2.7. Test Result of 26dB Bandwidth and 99% Occupied Bandwidth

Temperature	25°C	Humidity	50%
Test Engineer	Eddie Weng & Lucas Huang		
Test Mode	Mode 1: PIFA Antenna / Chain1:5.84 dBi, Chain2:5.50 dBi, Chain3:5.84 dBi, Chain4:5.65 dBi		

Mode	Frequency	26dB Bandwidth (MHz)	99% Occupied Bandwidth (MHz)
802.11a	5260 MHz	18.43	16.32
	5300 MHz	18.61	16.32
	5320 MHz	18.35	16.15
	5500 MHz	18.52	16.41
	5580 MHz	18.35	16.15
	5700 MHz	18.35	16.32
802.11ac MCS0/Nss1 VHT20	5260 MHz	19.13	17.37
	5300 MHz	19.13	17.37
	5320 MHz	19.13	17.45
	5500 MHz	19.22	17.37
	5580 MHz	19.48	17.45
	5700 MHz	19.39	17.45
802.11ac MCS0/Nss1 VHT40	5270 MHz	39.71	36.32
	5310 MHz	39.57	36.18
	5510 MHz	40.14	36.32
	5550 MHz	40.00	36.32
	5670 MHz	40.00	36.32
802.11ac MCS0/Nss1 VHT80	5290 MHz	83.48	75.83
	5530 MHz	84.06	75.54
	5610 MHz	84.06	76.12

Straddle Channel

Mode	Frequency	26dB BW (MHz)	99% OBW (MHz)	26dB BW F1 (MHz)	99% OBW T1 (MHz)	UNII 2C 26dB BW (MHz)	UNII 3 26dB BW (MHz)	UNII 2C 99% BW (MHz)	UNII 3 99% BW (MHz)
802.11a	5720 MHz	18.35	16.24	5710.70	5711.84	14.30	4.04	13.16	3.08
802.11ac MCS0/Nss1 VHT20	5720 MHz	18.96	17.19	5710.35	5711.23	14.65	4.30	13.77	3.42
802.11ac MCS0/Nss1 VHT40	5710 MHz	40.29	36.47	5689.86	5691.91	35.15	5.14	33.09	3.38
802.11ac MCS0/Nss1 VHT80	5690 MHz	84.93	76.41	5647.39	5651.80	77.61	7.32	73.20	3.21

Mode 1: PIFA Antenna / Chain1:5.84 dBi, Chain2:5.50 dBi, Chain3:5.84 dBi, Chain4:5.65 dBi

26dB Bandwidth and 99% Occupied Bandwidth Plot on Configuration IEEE 802.11a / Chain 1 + Chain 2 + Chain 3 + Chain 4 / 5260 MHz

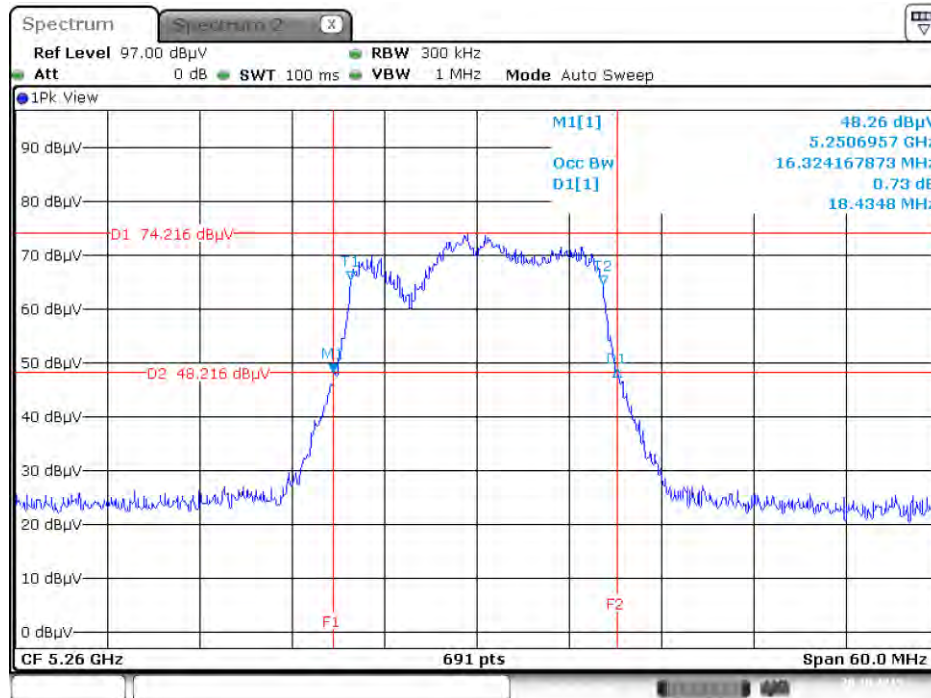

Date: 20.OCT.2015 23:06:27

26dB Bandwidth and 99% Occupied Bandwidth Plot on Configuration IEEE 802.11a / Chain 1 + Chain 2 + Chain 3 + Chain 4 / 5300 MHz

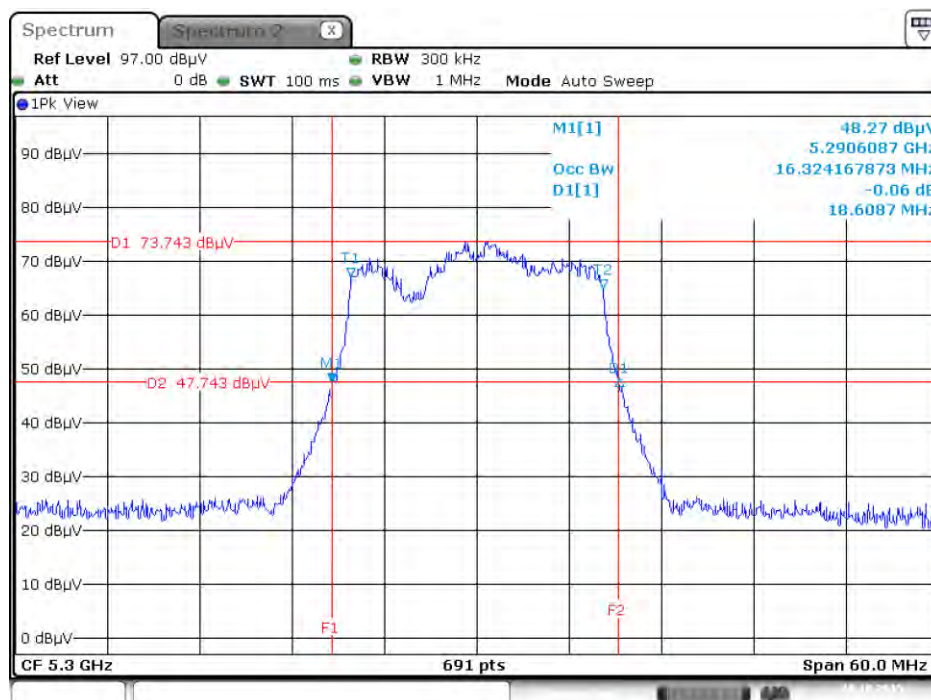

Date: 20.OCT.2015 23:06:57

26dB Bandwidth and 99% Occupied Bandwidth Plot on Configuration IEEE 802.11a / Chain 1 + Chain 2 + Chain 3 + Chain 4 / 5320 MHz

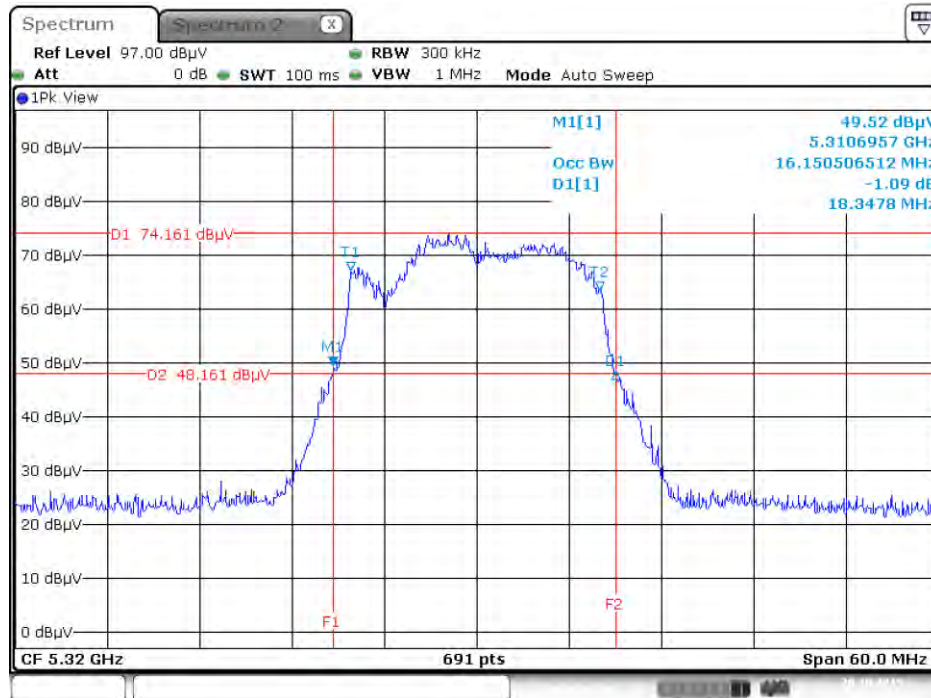

Date: 20.OCT.2015 23:07:35

26dB Bandwidth and 99% Occupied Bandwidth Plot on Configuration IEEE 802.11a / Chain 1 + Chain 2 + Chain 3 + Chain 4 / 5500 MHz

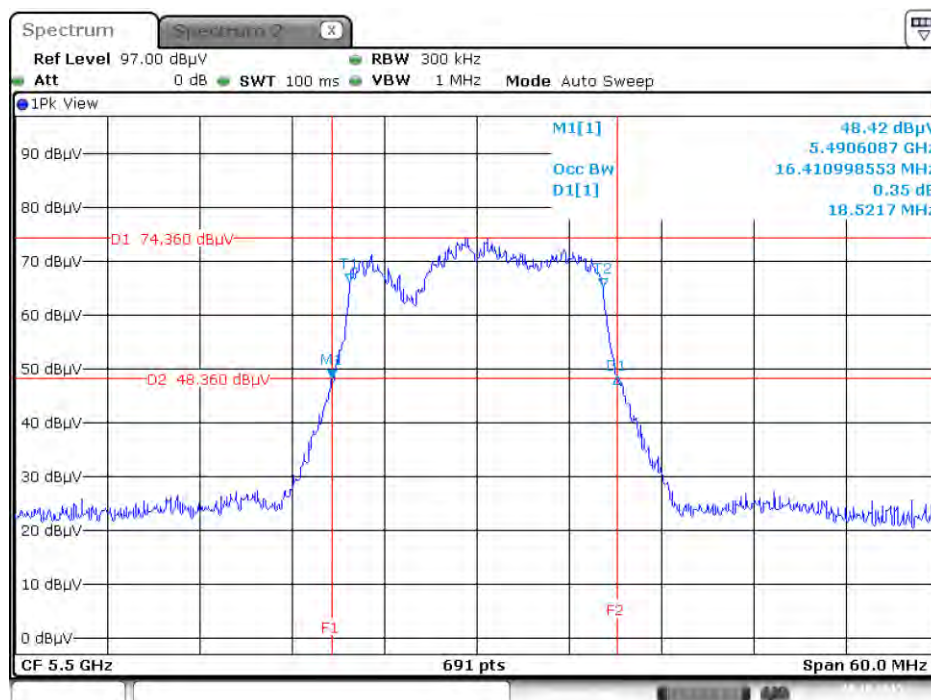

Date: 20.OCT.2015 23:08:02

26dB Bandwidth and 99% Occupied Bandwidth Plot on Configuration IEEE 802.11a / Chain 1 + Chain 2 + Chain 3 + Chain 4 / 5580 MHz

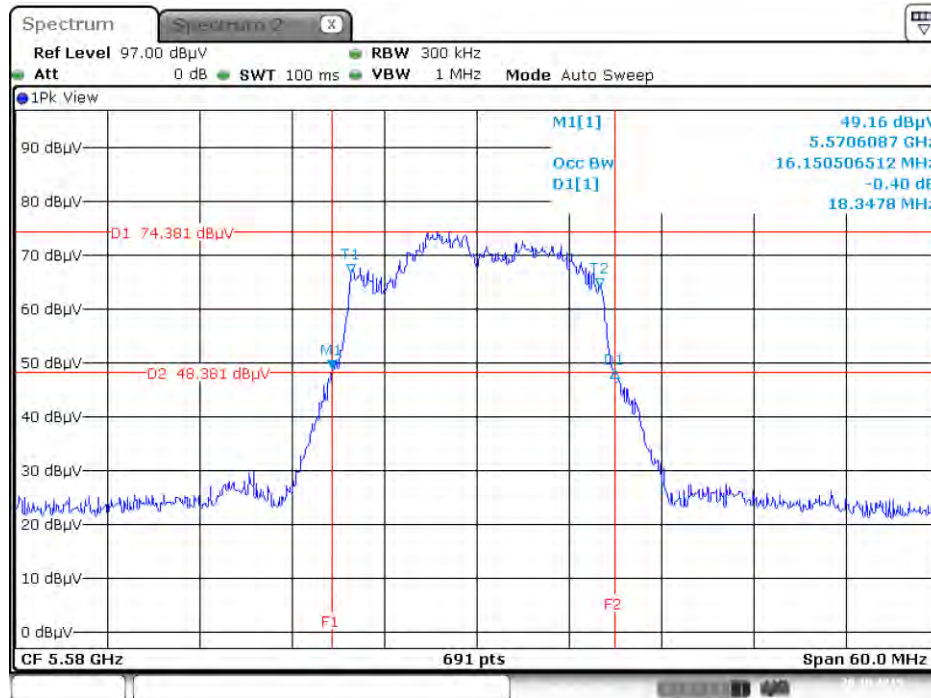

Date: 20.OCT.2015 23:08:39

26dB Bandwidth and 99% Occupied Bandwidth Plot on Configuration IEEE 802.11a / Chain 1 + Chain 2 + Chain 3 + Chain 4 / 5700 MHz

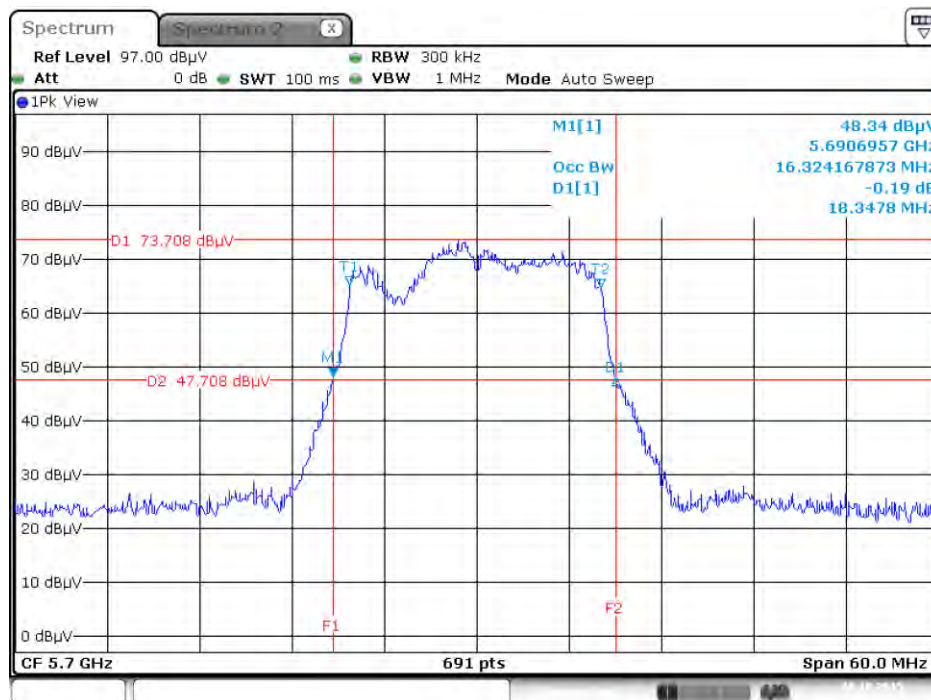

Date: 20.OCT.2015 23:09:14

26dB Bandwidth and 99% Occupied Bandwidth Plot on Configuration IEEE 802.11ac MCS0/Nss1 VHT20 / Chain 1 + Chain 2 + Chain 3 + Chain 4 / 5260 MHz

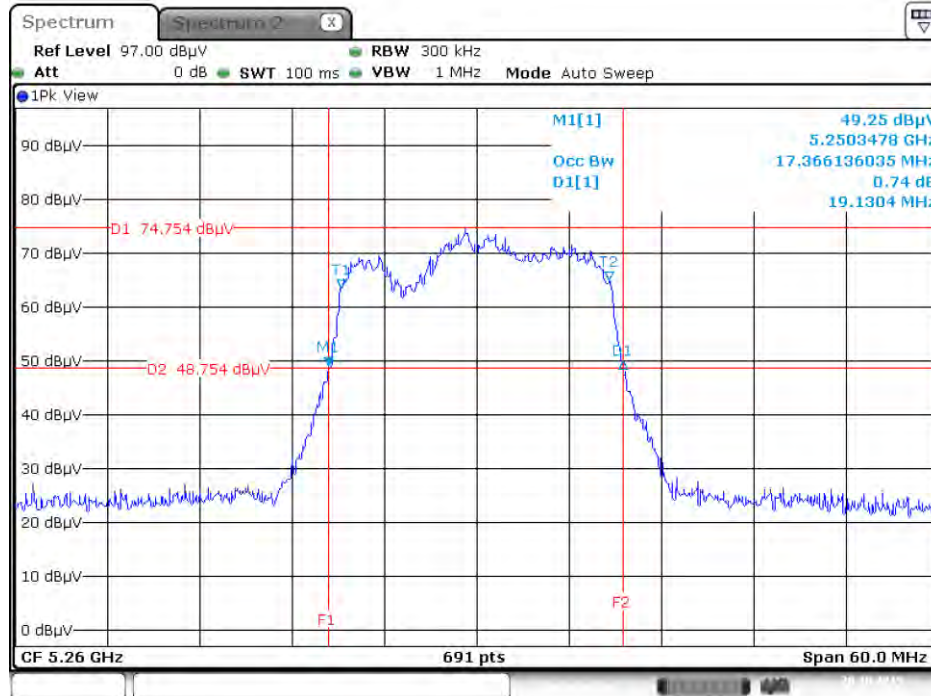

Date: 20.OCT.2015 23:30:57

26dB Bandwidth and 99% Occupied Bandwidth Plot on Configuration IEEE 802.11ac MCS0/Nss1 VHT20 / Chain 1 + Chain 2 + Chain 3 + Chain 4 / 5300 MHz

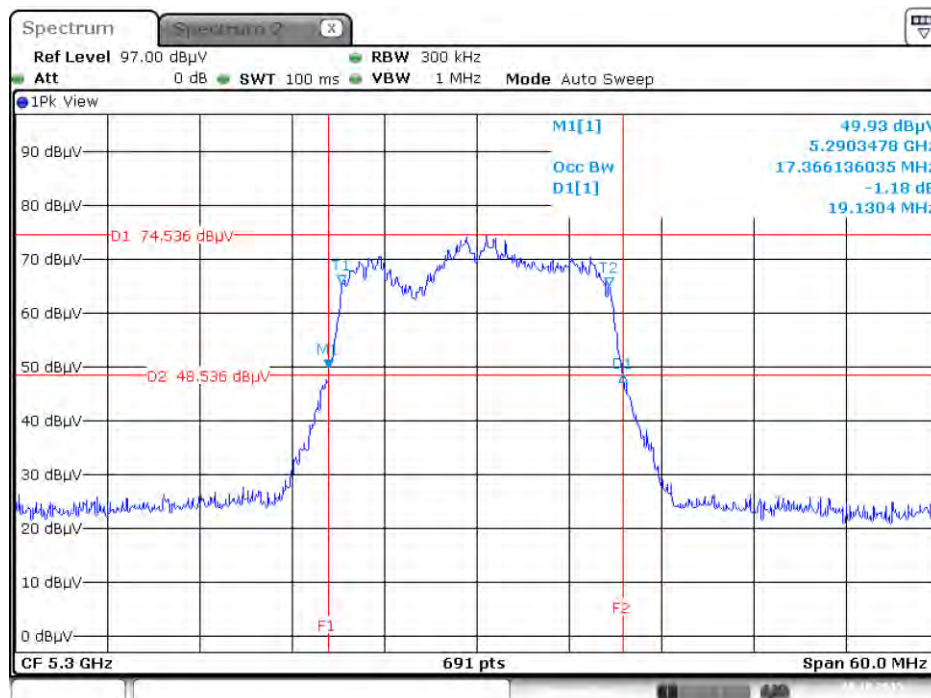

Date: 20.OCT.2015 23:31:26

26dB Bandwidth and 99% Occupied Bandwidth Plot on Configuration IEEE 802.11ac MCS0/Nss1 VHT20 / Chain 1 + Chain 2 + Chain 3 + Chain 4 / 5320 MHz

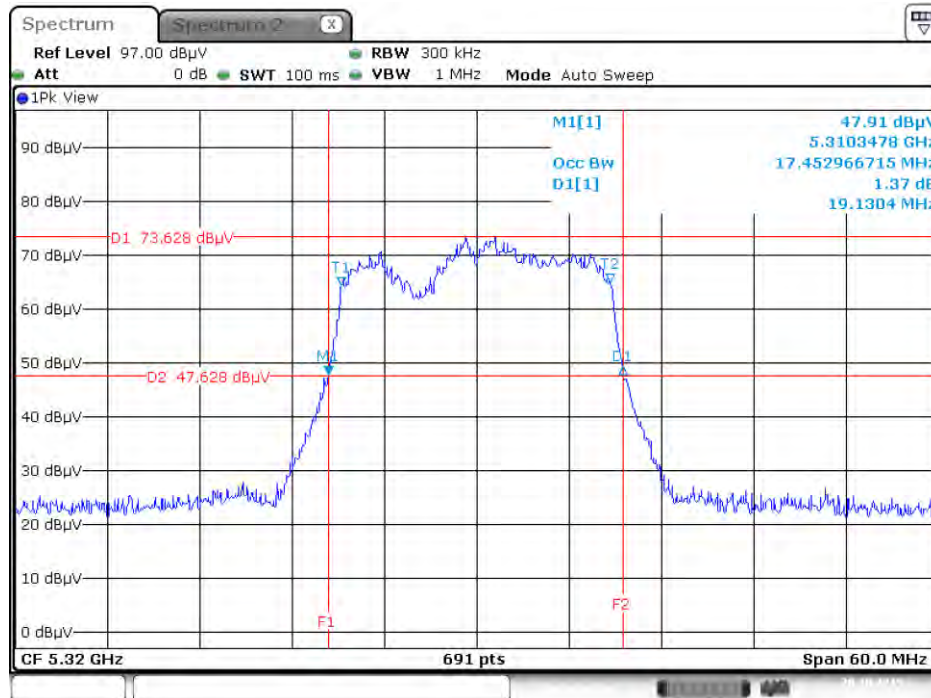

Date: 20.OCT.2015 23:31:59

26dB Bandwidth and 99% Occupied Bandwidth Plot on Configuration IEEE 802.11ac MCS0/Nss1 VHT20 / Chain 1 + Chain 2 + Chain 3 + Chain 4 / 5500 MHz

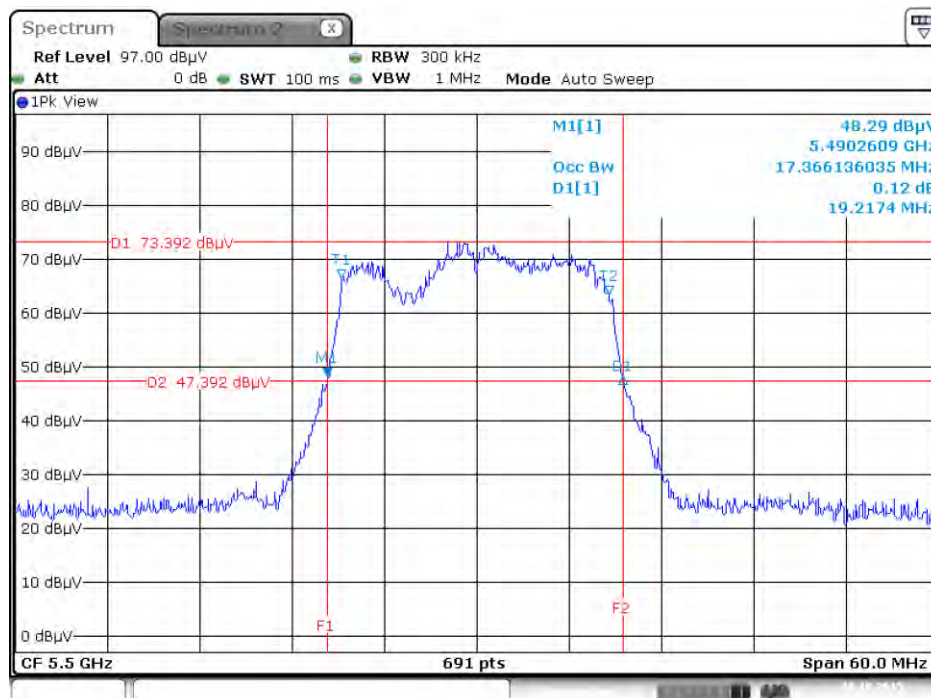

Date: 20.OCT.2015 23:32:32

26dB Bandwidth and 99% Occupied Bandwidth Plot on Configuration IEEE 802.11ac MCS0/Nss1 VHT20 / Chain 1 + Chain 2 + Chain 3 + Chain 4 / 5580 MHz

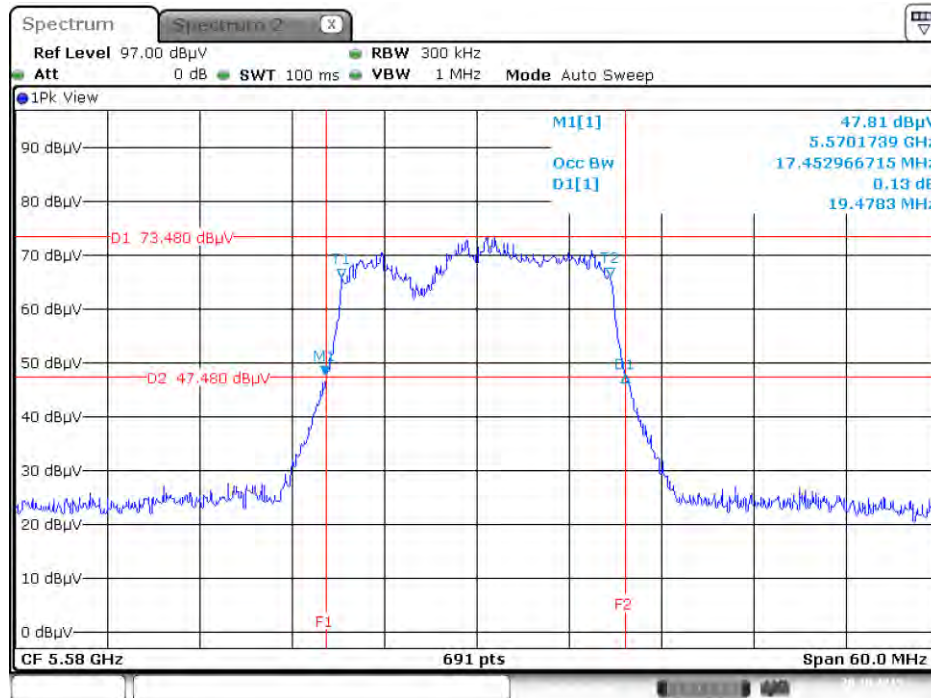

Date: 20.OCT.2015 23:33:03

26dB Bandwidth and 99% Occupied Bandwidth Plot on Configuration IEEE 802.11ac MCS0/Nss1 VHT20 / Chain 1 + Chain 2 + Chain 3 + Chain 4 / 5700 MHz

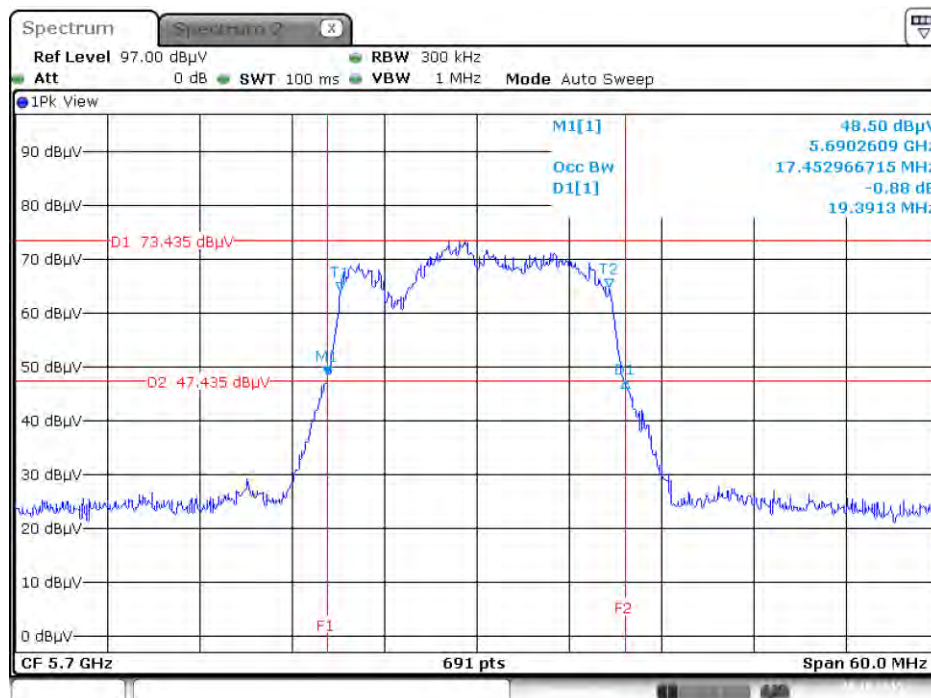

Date: 20.OCT.2015 23:33:37

26dB Bandwidth and 99% Occupied Bandwidth Plot on Configuration IEEE 802.11ac MCS0/Nss1 VHT40 / Chain 1 + Chain 2 + Chain 3 + Chain 4 / 5270 MHz

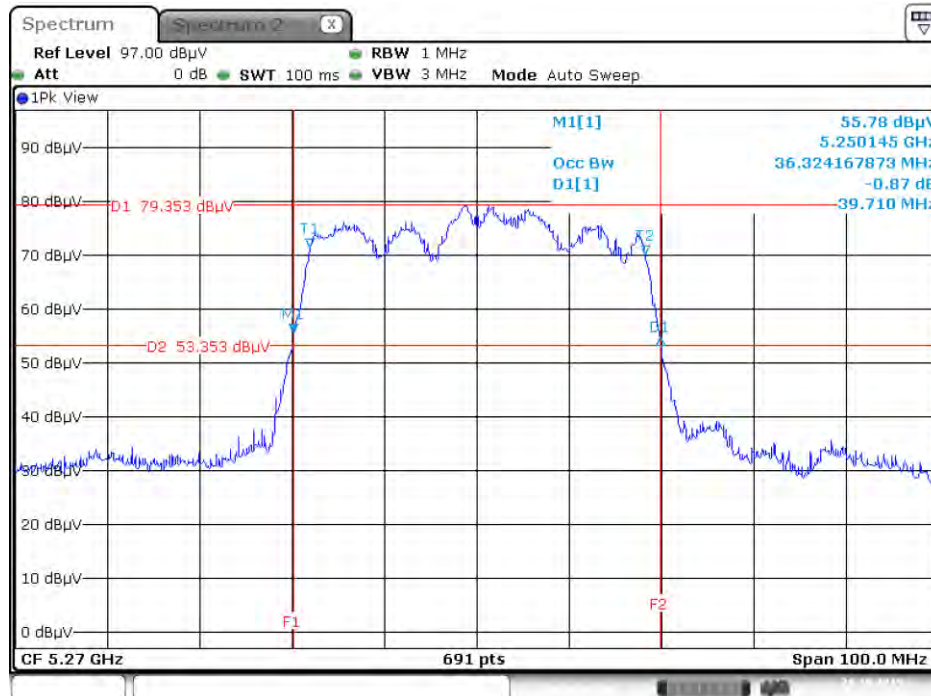

Date: 21.OCT.2015 00:18:45

26dB Bandwidth and 99% Occupied Bandwidth Plot on Configuration IEEE 802.11ac MCS0/Nss1 VHT40 / Chain 1 + Chain 2 + Chain 3 + Chain 4 / 5310 MHz

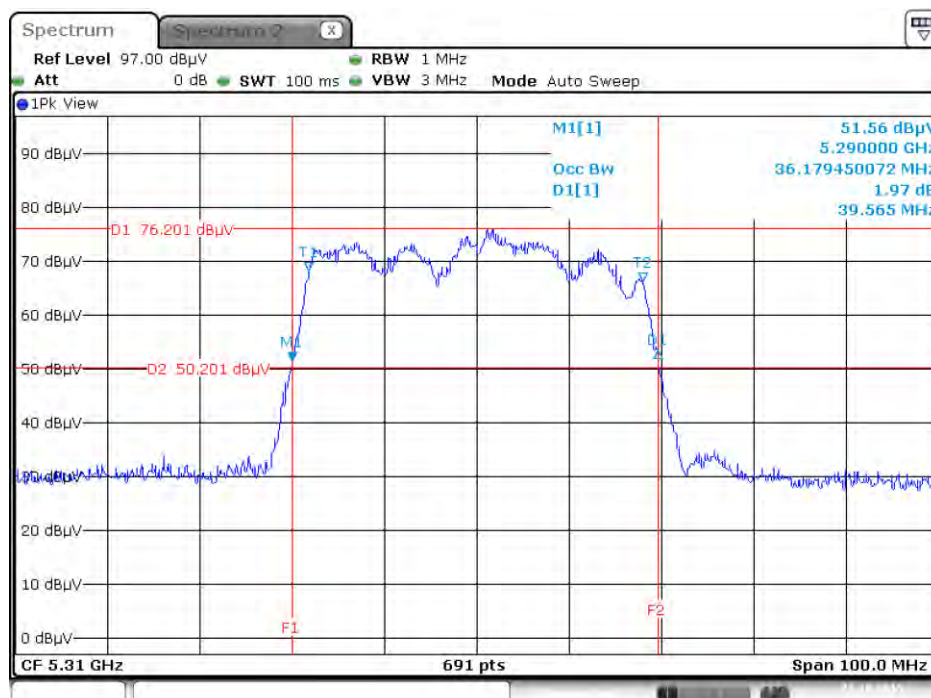

Date: 21.OCT.2015 00:19:24

26dB Bandwidth and 99% Occupied Bandwidth Plot on Configuration IEEE 802.11ac MCS0/Nss1 VHT40 / Chain 1 + Chain 2 + Chain 3 + Chain 4 / 5510 MHz

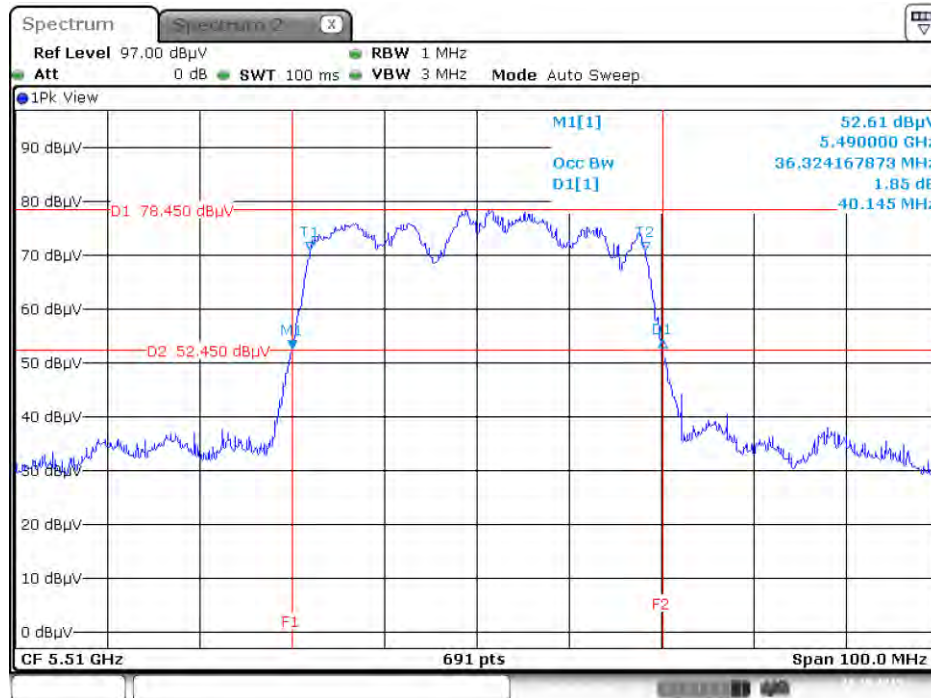

Date: 21.OCT.2015 00:20:03

26dB Bandwidth and 99% Occupied Bandwidth Plot on Configuration IEEE 802.11ac MCS0/Nss1 VHT40 / Chain 1 + Chain 2 + Chain 3 + Chain 4 / 5550 MHz

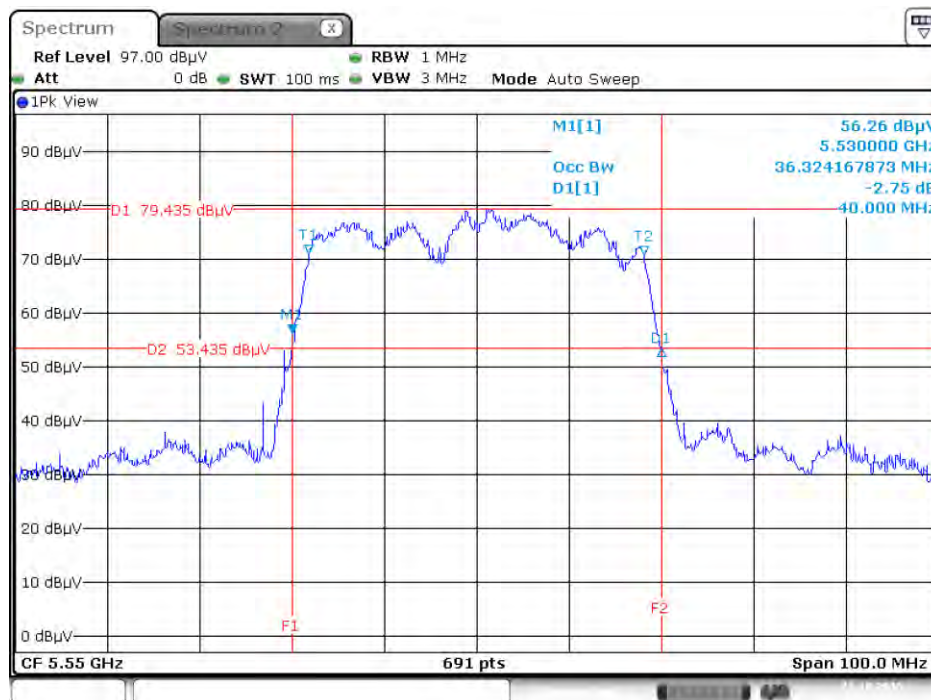

Date: 21.OCT.2015 00:20:35

26dB Bandwidth and 99% Occupied Bandwidth Plot on Configuration IEEE 802.11ac MCS0/Nss1 VHT40 / Chain 1 + Chain 2 + Chain 3 + Chain 4 / 5670 MHz

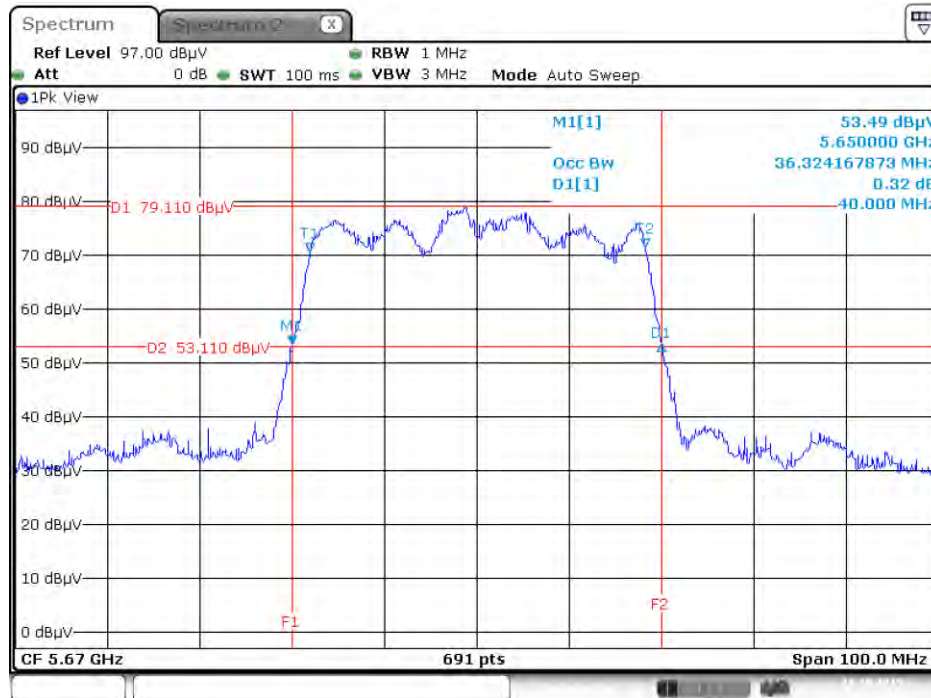

Date: 21.OCT.2015 00:21:11

26dB Bandwidth and 99% Occupied Bandwidth Plot on Configuration IEEE 802.11ac MCS0/Nss1 VHT80 / Chain 1 + Chain 2 + Chain 3 + Chain 4 / 5290 MHz

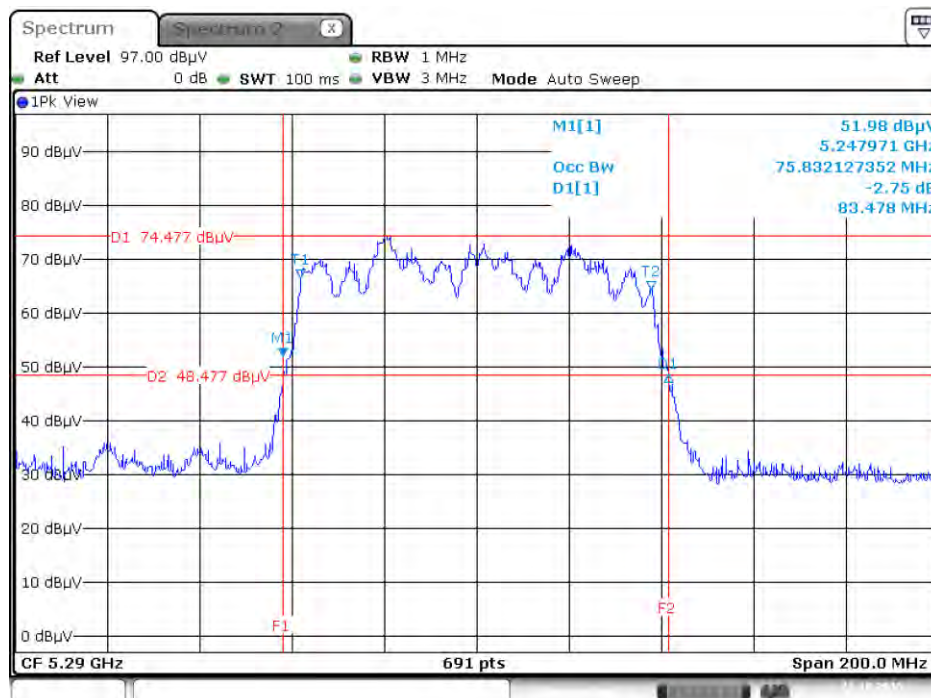

Date: 21.OCT.2015 00:23:55

26dB Bandwidth and 99% Occupied Bandwidth Plot on Configuration IEEE 802.11ac MCS0/Nss1 VHT80 / Chain 1 + Chain 2 + Chain 3 + Chain 4 / 5530 MHz

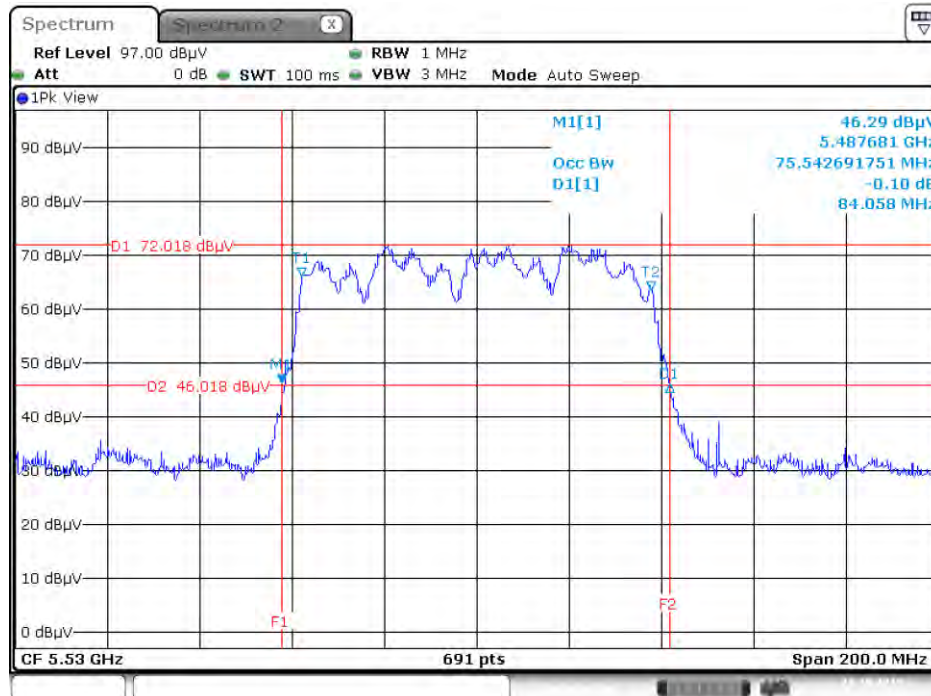

Date: 21.OCT.2015 00:24:33

26dB Bandwidth and 99% Occupied Bandwidth Plot on Configuration IEEE 802.11ac MCS0/Nss1 VHT80 / Chain 1 + Chain 2 + Chain 3 + Chain 4 / 5610 MHz

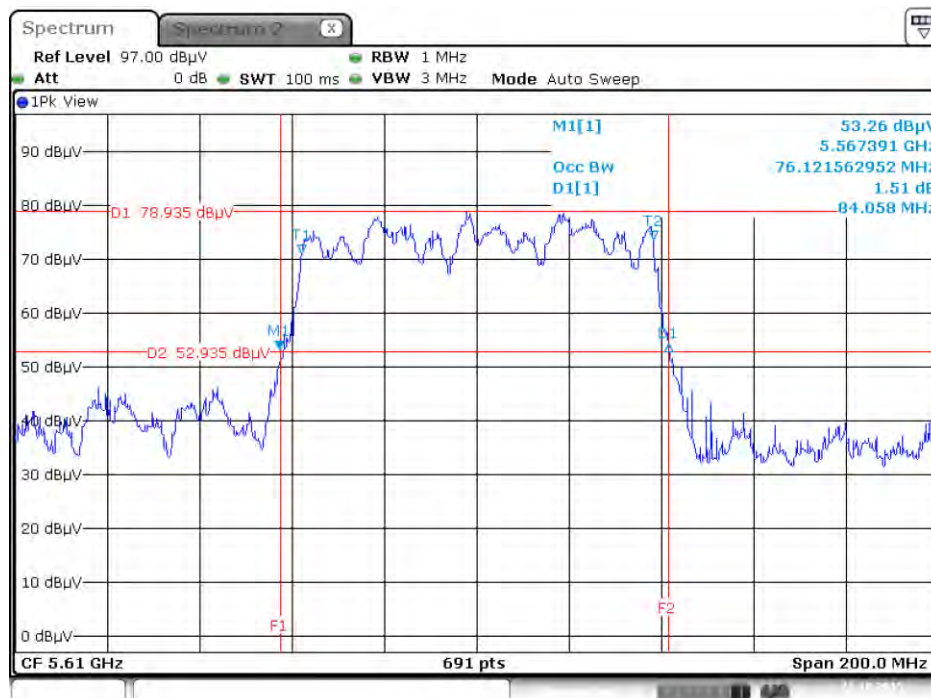

Date: 21.OCT.2015 00:25:14

Straddle Channel

26dB Bandwidth and 99% Occupied Bandwidth Plot on Configuration IEEE 802.11a / Chain 1 + Chain 2 + Chain 3 + Chain 4 / 5720 MHz

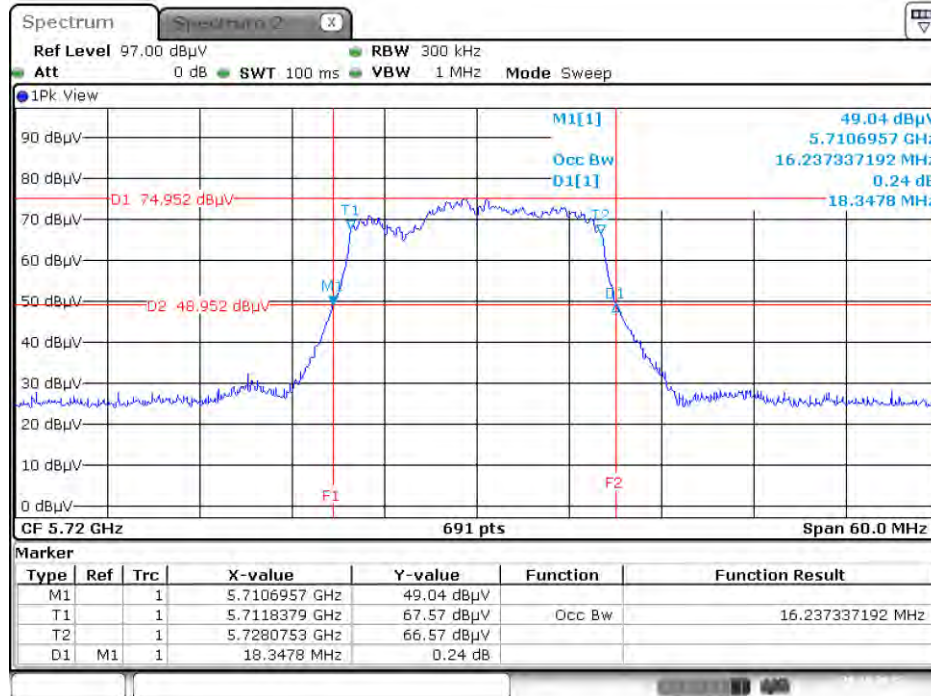

Date: 20.OCT.2015 22:30:11

26dB Bandwidth and 99% Occupied Bandwidth Plot on Configuration IEEE 802.11ac MCS0/Nss1 VHT20 / Chain 1 + Chain 2 + Chain 3 + Chain 4 / 5720 MHz

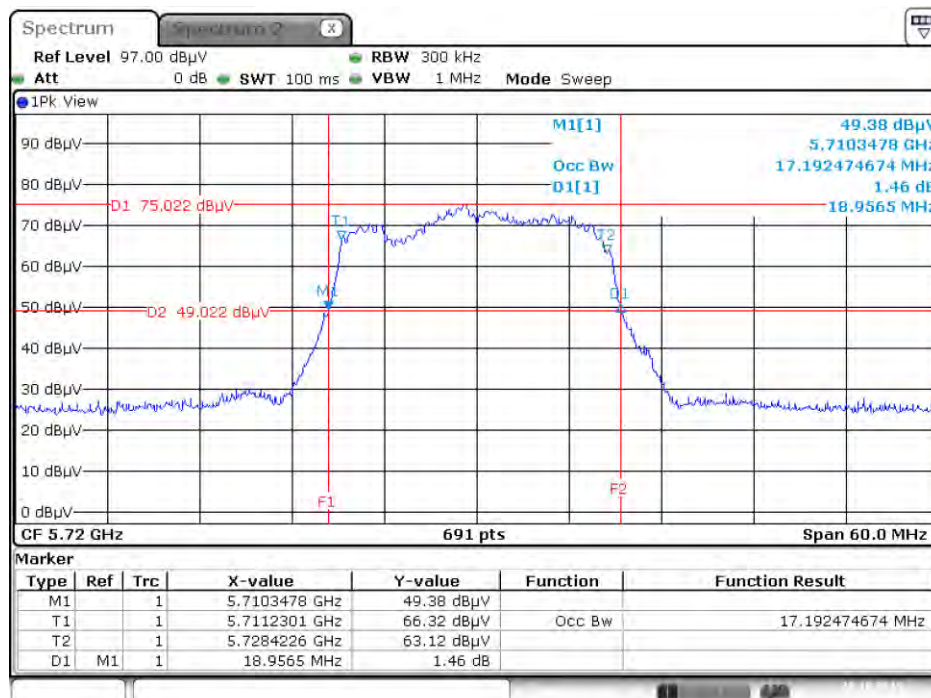

Date: 20.OCT.2015 22:29:42

26dB Bandwidth and 99% Occupied Bandwidth Plot on Configuration IEEE 802.11ac MCS0/Nss1 VHT40 / Chain 1 + Chain 2 + Chain 3 + Chain 4 / 5710 MHz

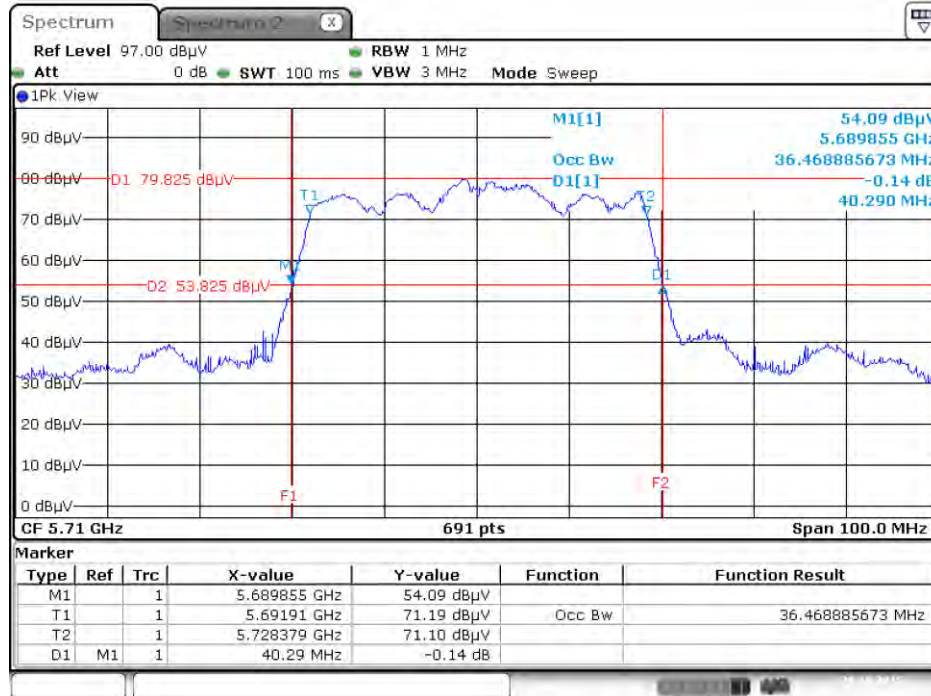

Date: 20.OCT.2015 22:30:41

26dB Bandwidth and 99% Occupied Bandwidth Plot on Configuration IEEE 802.11ac MCS0/Nss1 VHT80 / Chain 1 + Chain 2 + Chain 3 + Chain 4 / 5690 MHz

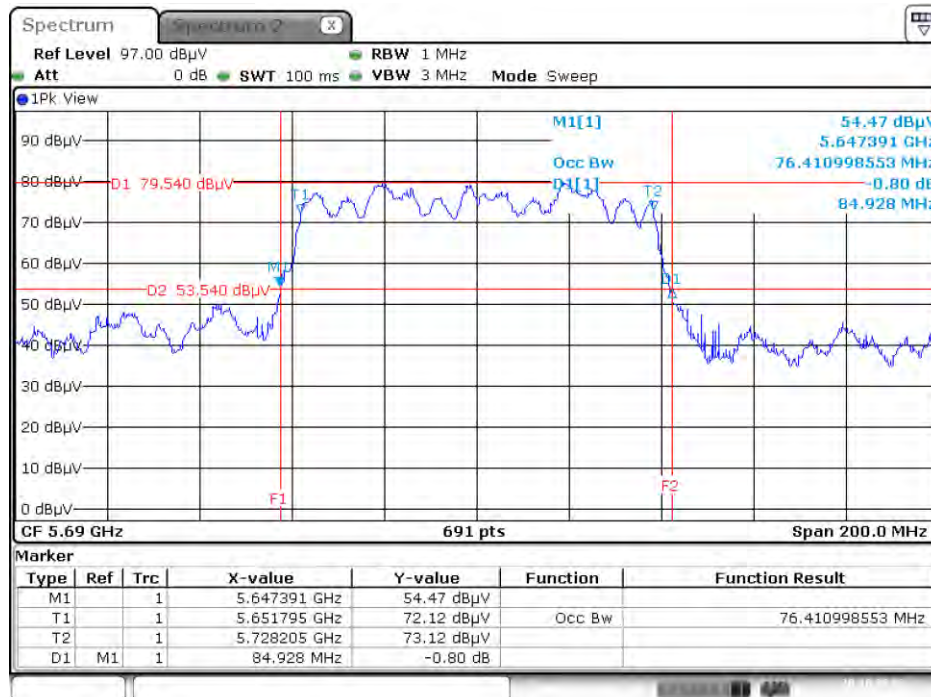

Date: 20.OCT.2015 22:31:21

4.3. 6dB Spectrum Bandwidth Measurement

4.3.1. Limit

For digital modulation systems, the minimum 6dB bandwidth shall be at least 500 kHz.

4.3.2. Measuring Instruments and Setting

Please refer to section 5 of equipments list in this report. The following table is the setting of spectrum analyzer.

6dB Spectrum Bandwidth	
Spectrum Parameters	Setting
Attenuation	Auto
Span Frequency	> 6dB Bandwidth
RBW	100kHz
VBW	$\geq 3 \times \text{RBW}$
Detector	Peak
Trace	Max Hold
Sweep Time	Auto

4.3.3. Test Procedures

For Radiated 6dB Bandwidth Measurement:

1. The transmitter was radiated to the spectrum analyzer in peak hold mode.
2. Test was performed in accordance with KDB789033 D02 v01 for Compliance Testing of Unlicensed National Information Infrastructure (U-NII) Devices - section (C) Emission Bandwidth.
3. Multiple antenna system was performed in accordance with KDB662911 D01 v02r01 Emissions Testing of Transmitters with Multiple Outputs in the Same Band.
4. Measured the spectrum width with power higher than 6dB below carrier.

4.3.4. Test Setup Layout

For Radiated 6dB Bandwidth Measurement:

This test setup layout is the same as that shown in section 4.6.4.

4.3.5. Test Deviation

There is no deviation with the original standard.

4.3.6. EUT Operation during Test

The EUT was programmed to be in continuously transmitting mode.

4.3.7. Test Result of 6dB Spectrum Bandwidth

Temperature	25°C	Humidity	50%
Test Engineer	Eddie Weng & Lucas Huang		
Test Mode	Mode 1: PIFA Antenna / Chain1:5.84 dBi, Chain2:5.50 dBi, Chain3:5.84 dBi, Chain4:5.65 dBi		

Straddle Channel

Mode	Frequency	6dB BW (MHz)	6dB BW F2 (MHz)	UNII 3 BW (MHz)	Min. Limit (kHz)	Test Result
802.11a	5720 MHz	15.65	5711.83	2.48	500	Complies
802.11ac MCS0/Nss1 VHT20	5720 MHz	9.51	5717.10	1.61	500	Complies
802.11ac MCS0/Nss1 VHT40	5710 MHz	35.59	5692.49	3.09	500	Complies
802.11ac MCS0/Nss1 VHT80	5690 MHz	73.33	5654.35	2.68	500	Complies

Straddle Channel

Mode 1: PIFA Antenna / Chain1:5.84 dBi, Chain2:5.50 dBi, Chain3:5.84 dBi, Chain4:5.65 dBi

6 dB Bandwidth Plot on Configuration IEEE 802.11a / Chain 1 + Chain 2 + Chain 3 + Chain 4 / 5720 MHz

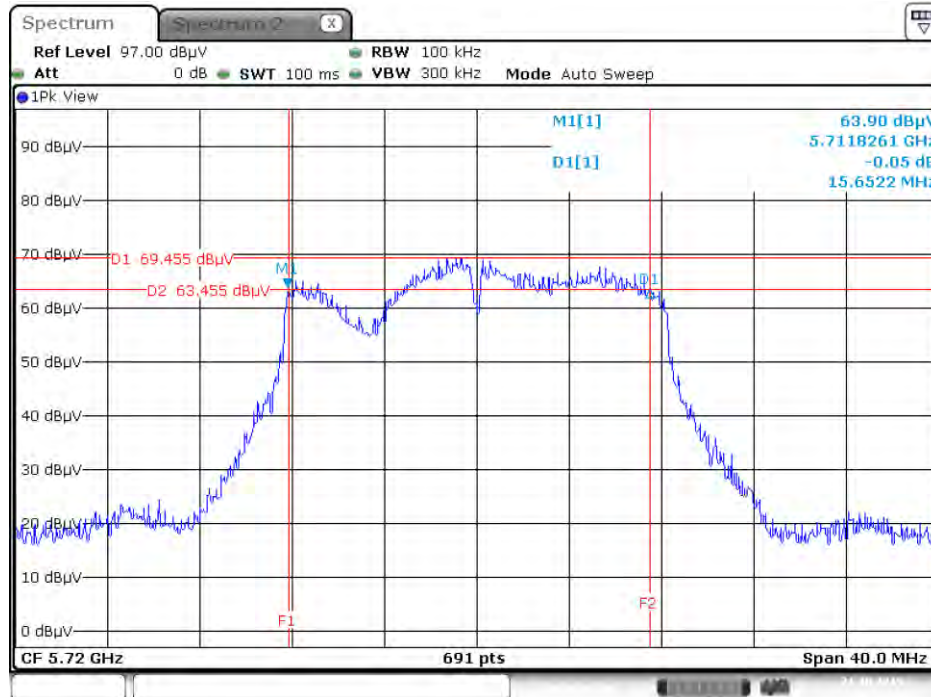

Date: 21.OCT.2015 00:33:23

6 dB Bandwidth Plot on Configuration IEEE 802.11ac MCS0/Nss1 VHT20 / Chain 1 + Chain 2 + Chain 3 + Chain 4 / 5720 MHz

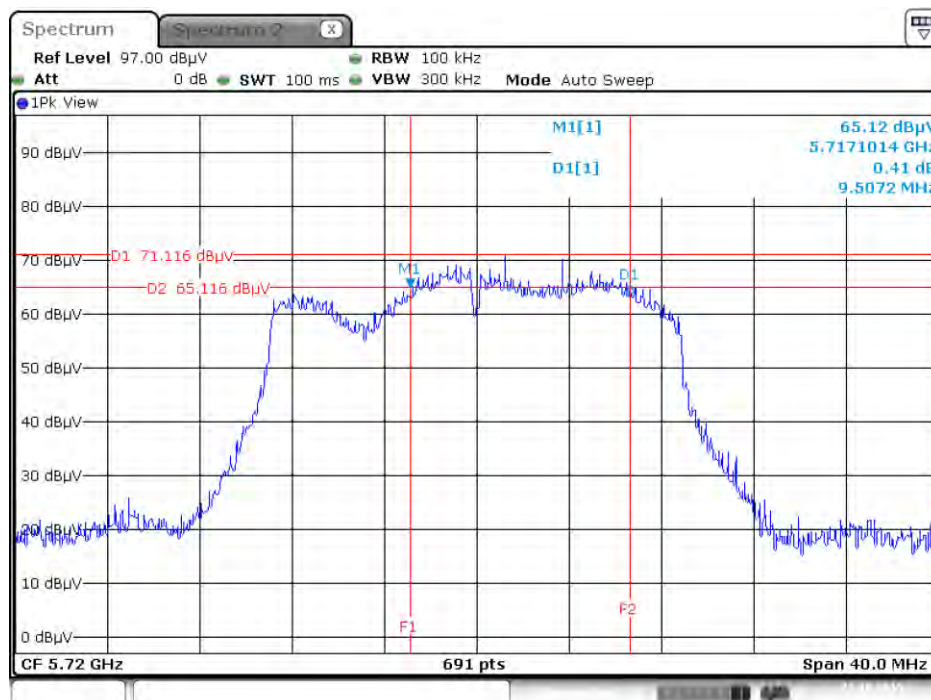

Date: 21.OCT.2015 00:33:57

6 dB Bandwidth Plot on Configuration IEEE 802.11ac MCS0/Nss1 VHT40 / Chain 1 + Chain 2 + Chain 3 + Chain 4 / 5710 MHz

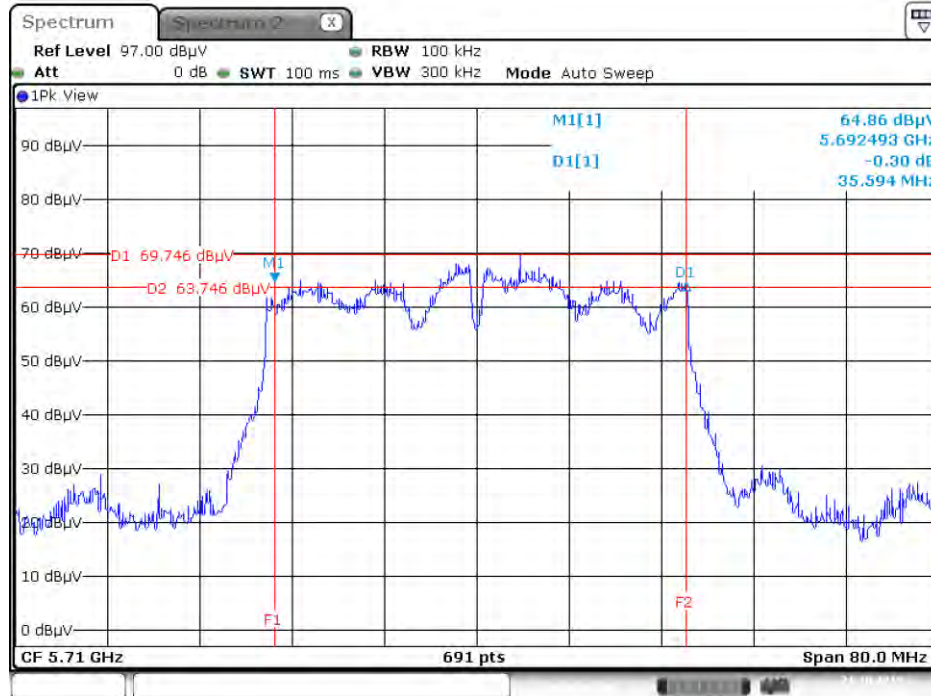

Date: 21.OCT.2015 00:34:43

6 dB Bandwidth Plot on Configuration IEEE 802.11ac MCS0/Nss1 VHT80 / Chain 1 + Chain 2 + Chain 3 + Chain 4 / 5690 MHz

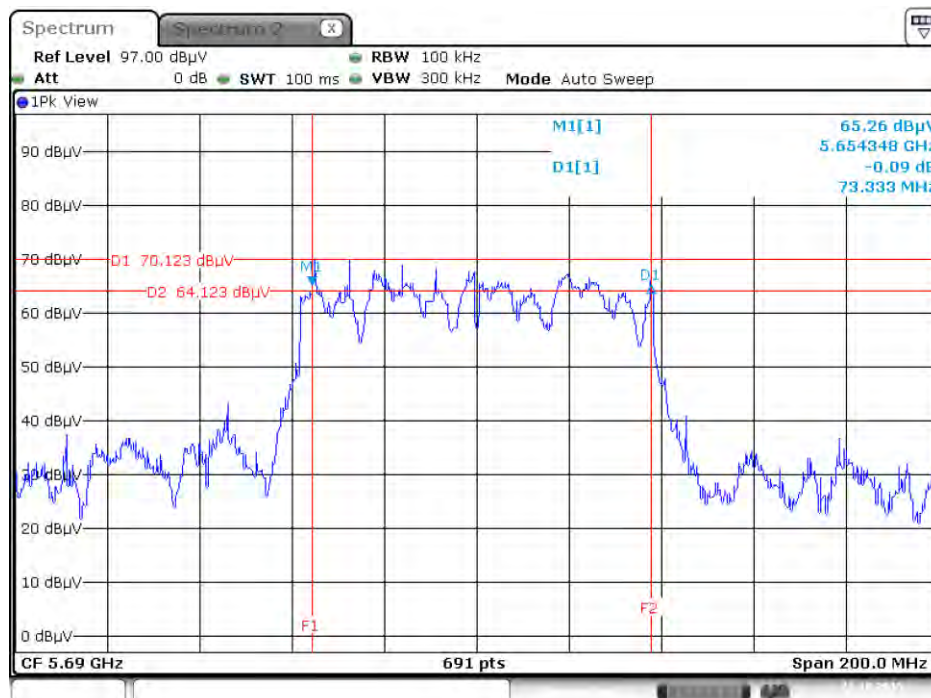

Date: 21.OCT.2015 00:36:10

4.4. Maximum Conducted Output Power Measurement

4.4.1. Limit

Frequency Band		Limit
<input checked="" type="checkbox"/>	5.25-5.35 GHz	The maximum conducted output power over the frequency bands of operation shall not exceed the lesser of 250 mW (24dBm) or 11 dBm $10 \log B$, where B is the 26 dB emission bandwidth in megahertz. If transmitting antennas of directional gain greater than 6 dBi are used, both the maximum conducted output power and the maximum power spectral density shall be reduced by the amount in dB that the directional gain of the antenna exceeds 6 dBi.
<input checked="" type="checkbox"/>	5.470-5.725 GHz	

4.4.2. Measuring Instruments and Setting

For other channel:

Please refer to section 5 of equipments list in this report. The following table is the setting of the power meter.

Power Meter Parameter	Setting
Detector	AVERAGE

For straddle channel:

Please refer to section 5 of equipments list in this report. The following table is the setting of the spectrum analyzer.

Spectrum Parameter	Setting
Attenuation	Auto
Span Frequency	Encompass the entire emissions bandwidth (EBW) of the signal
RBW	1000 kHz
VBW	3000 kHz
Detector	RMS
Trace	Average Sweep count 100
Sweep Time	Auto

4.4.3. Test Procedures

For other channel:

1. The transmitter output (antenna port) was connected to the power meter.
2. Test was performed in accordance with KDB789033 D02 v01 for Compliance Testing of Unlicensed National Information Infrastructure (U-NII) Devices - section (E) Maximum conducted output power =>3. Measurement using a Power Meter (PM) =>b) Method PM-G (Measurement using a gated RF average power meter).
3. Multiple antenna systems was performed in accordance with KDB662911 D01 v02r01 Emissions Testing of Transmitters with Multiple Outputs in the Same Band.
4. When measuring maximum conducted output power with multiple antenna systems, add every result of the values by mathematic formula.

For straddle channel:

1. The transmitter output (antenna port) was connected to the spectrum analyzer.
2. Test was performed in accordance with FCC Public Notice DA 02-2138, August 30, 2002.

4.4.4. Test Setup Layout

For other channel:

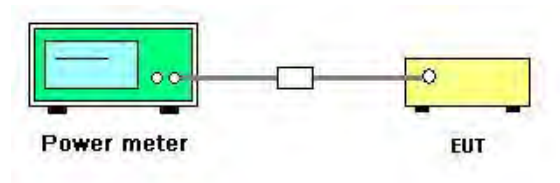

For straddle channel:

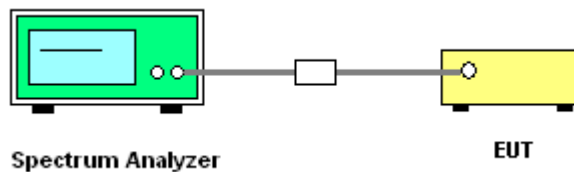

4.4.5. Test Deviation

There is no deviation with the original standard.

4.4.6. EUT Operation during Test

The EUT was programmed to be in continuously transmitting mode.

4.4.7. Test Result of Maximum Conducted Output Power

Temperature	25°C	Humidity	50%
Test Engineer	Eddie Weng & Lucas Huang	Test Date	Oct. 20, 2015
Test Mode	Mode 1: PIFA Antenna / Chain1:5.84 dBi, Chain2:5.50 dBi, Chain3:5.84 dBi, Chain4:5.65 dBi		

Mode	Frequency	Conducted Power (dBm)					Max. Limit (dBm)	Result
		Chain 1	Chain 2	Chain 3	Chain 4	Total		
802.11a	5260 MHz	12.22	12.07	12.02	12.12	18.13	23.66	Complies
	5300 MHz	12.36	11.92	11.98	12.11	18.12	23.70	Complies
	5320 MHz	12.52	12.41	12.59	12.18	18.45	23.64	Complies
	5500 MHz	12.42	12.63	12.71	12.84	18.67	23.68	Complies
	5580 MHz	12.23	12.18	12.25	12.45	18.30	23.64	Complies
	5700 MHz	11.92	12.04	12.09	12.09	18.06	23.64	Complies
802.11ac MCS0/Nss1 VHT20	5260 MHz	12.39	12.11	12.19	12.23	18.25	23.82	Complies
	5300 MHz	12.43	12.15	12.16	12.28	18.28	23.82	Complies
	5320 MHz	12.34	12.12	12.26	12.21	18.25	23.82	Complies
	5500 MHz	12.39	12.21	12.32	12.29	18.32	23.84	Complies
	5580 MHz	12.42	12.22	12.39	12.32	18.36	23.90	Complies
	5700 MHz	12.12	12.21	12.22	12.33	18.24	23.84	Complies
802.11ac MCS0/Nss1 VHT40	5270 MHz	15.56	15.12	14.81	14.95	21.14	24.00	Complies
	5310 MHz	10.59	10.39	10.69	10.63	16.60	24.00	Complies
	5510 MHz	13.95	13.94	13.85	13.90	19.93	24.00	Complies
	5550 MHz	15.68	15.25	15.16	15.11	21.33	24.00	Complies
	5670 MHz	15.47	15.26	15.12	15.46	21.35	24.00	Complies
802.11ac MCS0/Nss1 VHT80	5290 MHz	10.52	10.30	10.44	10.49	16.46	24.00	Complies
	5530 MHz	9.62	9.66	9.81	9.61	15.70	24.00	Complies
	5610 MHz	17.62	17.18	17.05	17.14	23.27	24.00	Complies

Note 1:

For 802.11a

 5260 MHz power limit= $11+10\log(B)$; $11+10\log(18.43)=23.66\text{dBm}<24\text{dBm}$, so limit=23.66dBm.

 5300 MHz power limit= $11+10\log(B)$; $11+10\log(18.61)=23.70\text{dBm}<24\text{dBm}$, so limit=23.70dBm.

 5320 MHz power limit= $11+10\log(B)$; $11+10\log(18.35)=23.64\text{dBm}<24\text{dBm}$, so limit=23.64dBm.

 5500 MHz power limit= $11+10\log(B)$; $11+10\log(18.52)=23.68\text{dBm}<24\text{dBm}$, so limit=23.68dBm.

 5580 MHz power limit= $11+10\log(B)$; $11+10\log(18.35)=23.64\text{dBm}<24\text{dBm}$, so limit=23.64dBm.

 5700 MHz power limit= $11+10\log(B)$; $11+10\log(18.35)=23.64\text{dBm}<24\text{dBm}$, so limit=23.64dBm.

For 802.11ac VHT20

5260 MHz power limit= $11+10\log(B)$; $11+10\log(19.13)=23.82\text{dBm}<24\text{dBm}$, so limit=23.82dBm.

5300 MHz power limit= $11+10\log(B)$; $11+10\log(19.13)=23.82\text{dBm}<24\text{dBm}$, so limit=23.82dBm.

5320 MHz power limit= $11+10\log(B)$; $11+10\log(19.13)=23.82\text{dBm}<24\text{dBm}$, so limit=23.82dBm.

5500 MHz power limit= $11+10\log(B)$; $11+10\log(19.22)=23.84\text{dBm}<24\text{dBm}$, so limit=23.84dBm.

5580 MHz power limit= $11+10\log(B)$; $11+10\log(19.48)=23.90\text{dBm}<24\text{dBm}$, so limit=23.90dBm.

5700 MHz power limit= $11+10\log(B)$; $11+10\log(19.39)=23.84\text{dBm}<24\text{dBm}$, so limit=23.84dBm.

Note 2: Antenna gain=5.84dBi <6dBi, so the limit doesn't reduce.

Straddle Channel

Mode	Frequency	Conducted Power (dBm)					Max. Limit (dBm)	Result
		Chain 1	Chain 2	Chain 3	Chain 4	Total		
802.11a	5720 MHz (UNII 2C)	11.82	11.87	12.45	11.47	17.94	22.55	Complies
	5720 MHz (UNII 3)	5.18	5.38	6.20	5.19	11.53	30.00	Complies
802.11ac MCS0/Nss1 VHT20	5720 MHz (UNII 2C)	11.52	11.55	12.17	11.26	17.66	22.66	Complies
	5720 MHz (UNII 3)	5.40	5.52	6.34	5.55	11.74	30.00	Complies
802.11ac MCS0/Nss1 VHT40	5710 MHz (UNII 2C)	15.18	15.22	15.74	14.91	21.29	24.00	Complies
	5710 MHz (UNII 3)	3.18	3.48	4.46	3.39	9.68	30.00	Complies
802.11ac MCS0/Nss1 VHT80	5690 MHz (UNII 2C)	17.87	17.69	18.59	17.49	23.95	24.00	Complies
	5690 MHz (UNII 3)	3.51	3.68	4.55	3.41	9.83	30.00	Complies

(UNII 2C)

Note 1:

For 802.11a

5720 MHz power limit= $11+10\log(B)$; $11+10\log(14.30)=22.55\text{dBm}<24\text{dBm}$, so limit=22.55dBm.

For 802.11ac VHT20

5720 MHz power limit= $11+10\log(B)$; $11+10\log(14.65)=22.66\text{dBm}<24\text{dBm}$, so limit=22.66dBm.

Note 2: Antenna gain=5.84dBi <6dBi, so the limit doesn't reduce.

(UNII 3)

Note 1: Antenna gain=5.84dBi <6dBi, so the limit doesn't reduce.

Note: All the test values were listed in the report.

For plots, only the channel with worse result was shown.

Straddle Channel

Mode 1: PIFA Antenna / Chain1:5.84 dBi, Chain2:5.50 dBi, Chain3:5.84 dBi, Chain4:5.65 dBi

Conducted Output Power Plot on Configuration IEEE 802.11a / Chain 1 / 5720 MHz (UNII 2C)

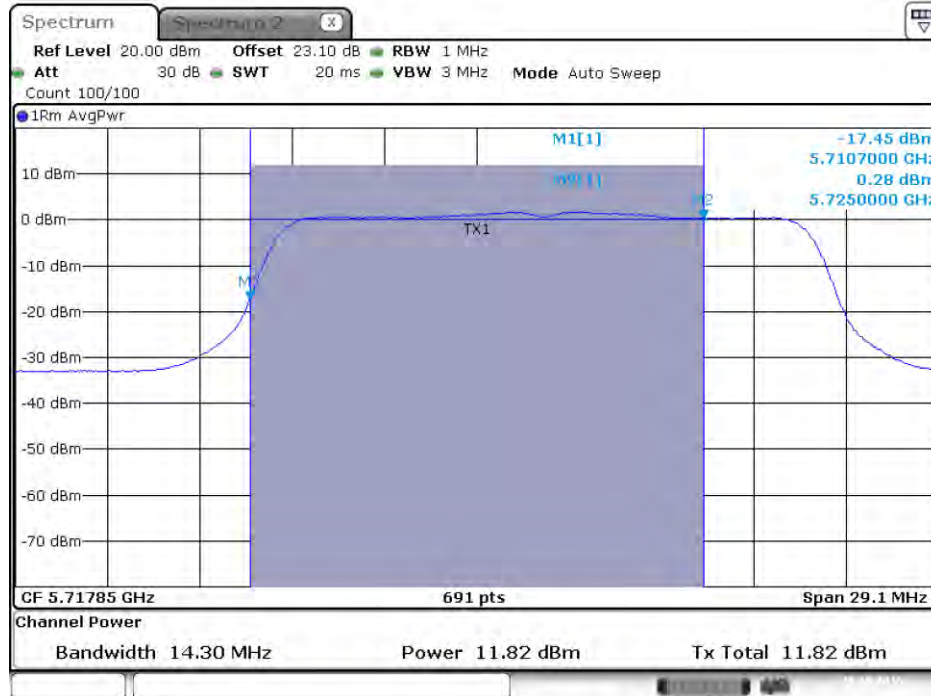

Date: 20.OCT.2015 22:39:19

Conducted Output Power Plot on Configuration IEEE 802.11a / Chain 2 / 5720 MHz (UNII 2C)

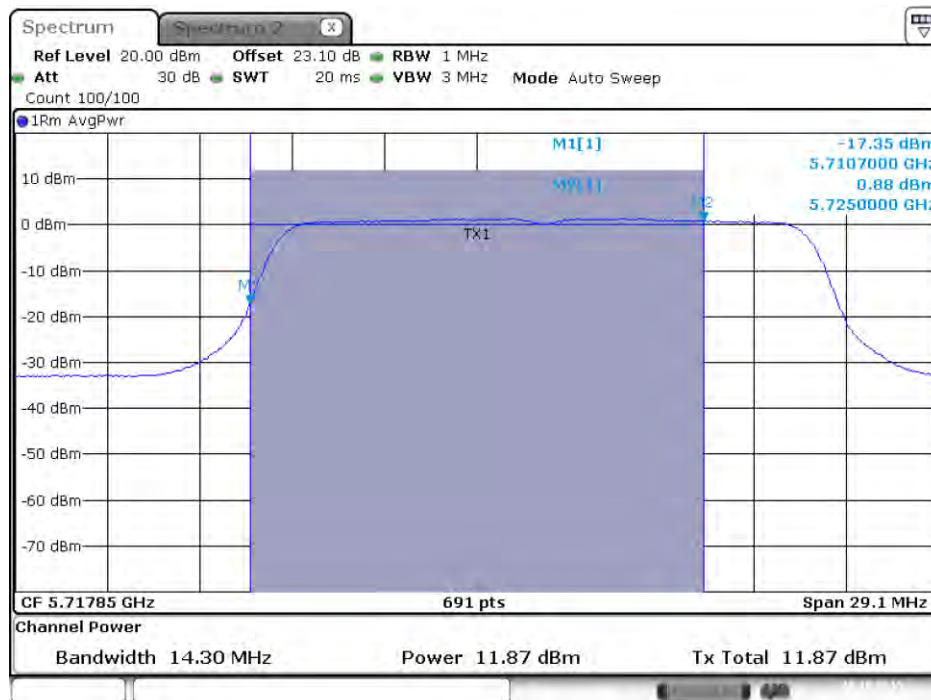

Date: 20.OCT.2015 22:39:26

Conducted Output Power Plot on Configuration IEEE 802. 11a / Chain 3 / 5720 MHz (UNII 2C)

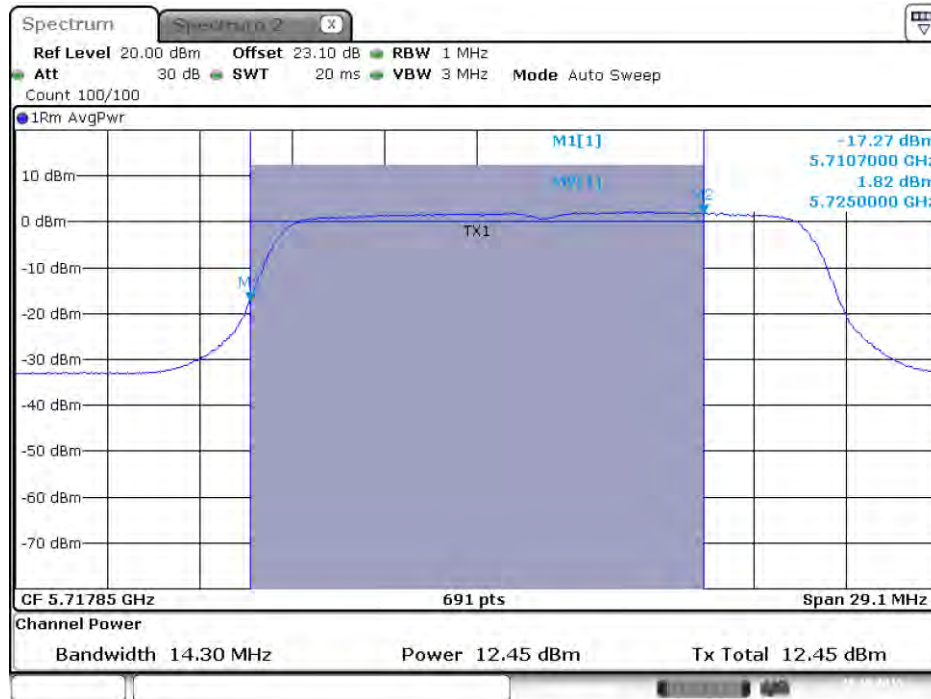

Date: 20.OCT.2015 22:39:33

Conducted Output Power Plot on Configuration IEEE 802.11a / Chain 4 / 5720 MHz (UNII 2C)

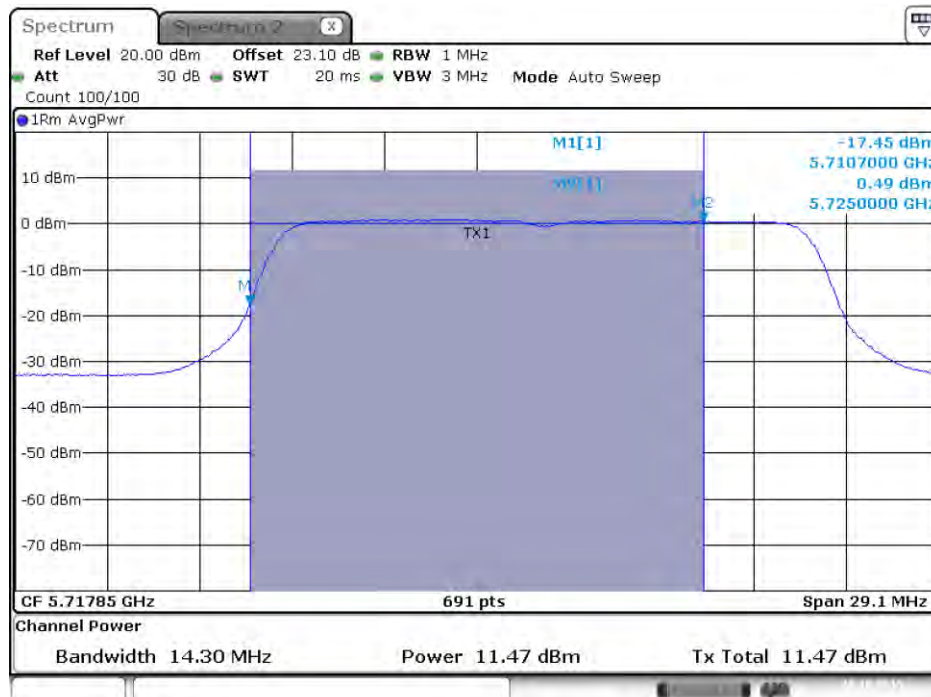

Date: 20.OCT.2015 22:39:40

Conducted Output Power Plot on Configuration IEEE 802. 11a / Chain 1 / 5720 MHz (UNII 3)



Date: 20.OCT.2015 22:39:23

Conducted Output Power Plot on Configuration IEEE 802. 11a / Chain 2 / 5720 MHz (UNII 3)



Date: 20.OCT.2015 22:39:30

Conducted Output Power Plot on Configuration IEEE 802. 11a / Chain 3 / 5720 MHz (UNII 3)

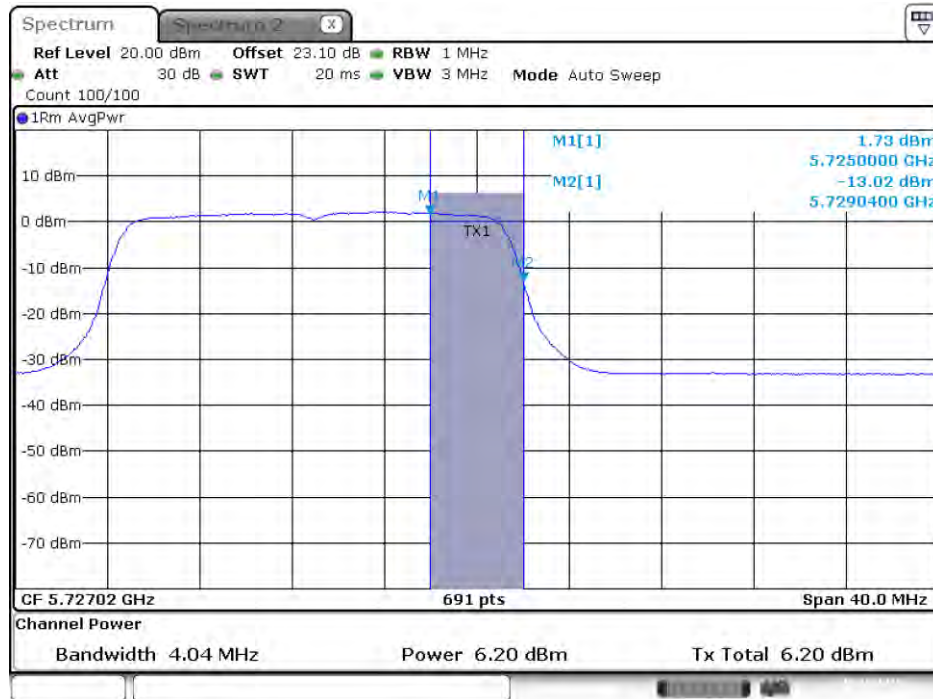

Date: 20.OCT.2015 22:39:37

Conducted Output Power Plot on Configuration IEEE 802. 11a / Chain 4 / 5720 MHz (UNII 3)

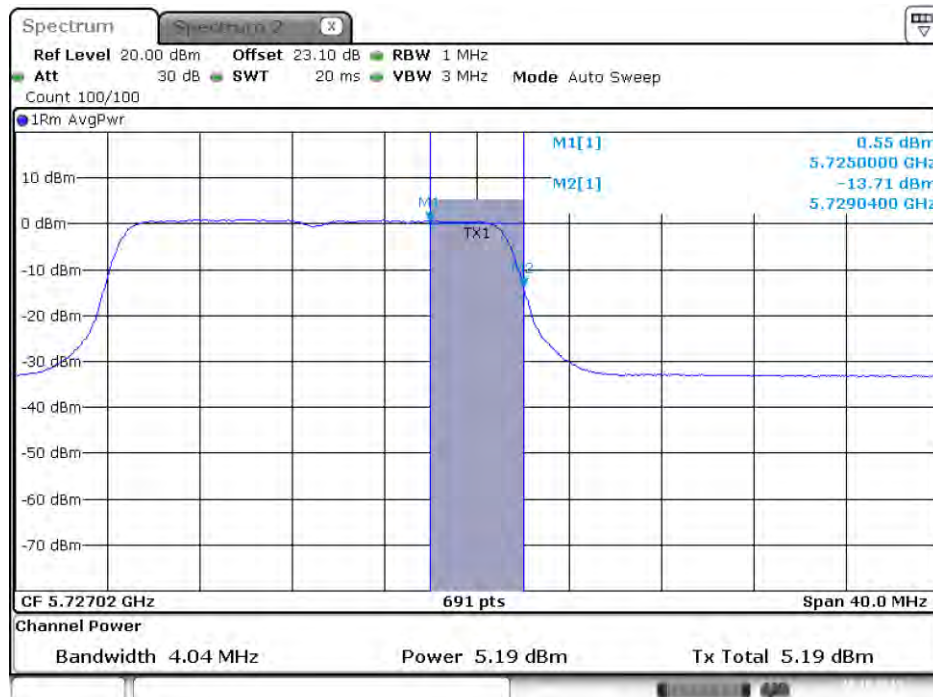

Date: 20.OCT.2015 22:39:44

Conducted Output Power Plot on Configuration IEEE 802.11ac MCS0/Nss1 VHT20 / Chain 1 / 5720 MHz (UNII 2C)

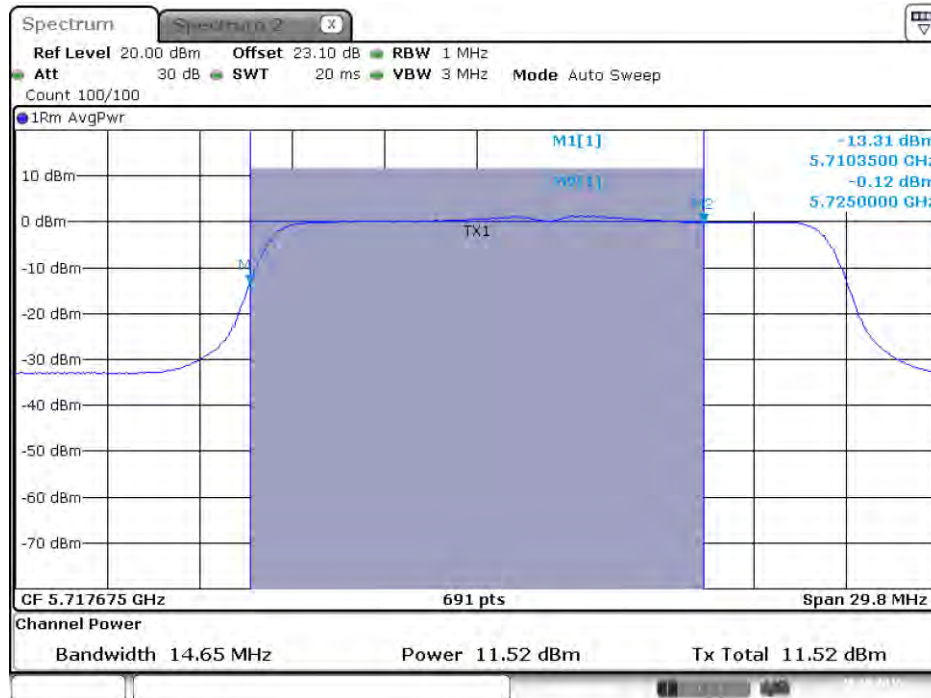

Date: 20 OCT 2015 23:00:44

Conducted Output Power Plot on Configuration IEEE 802.11ac MCS0/Nss1 VHT20 / Chain 2 / 5720 MHz (UNII 2C)

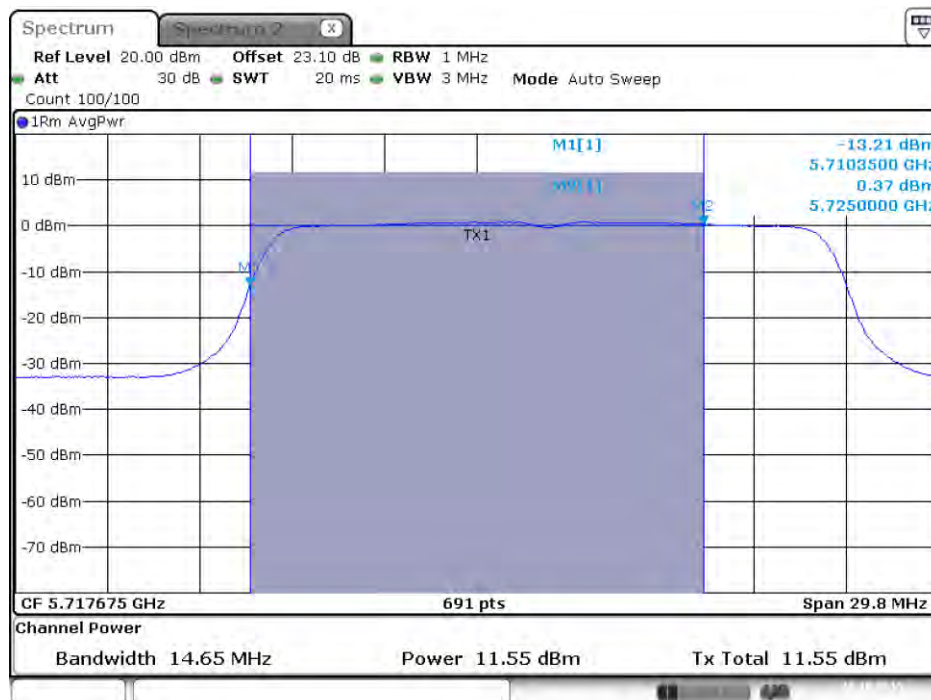

Date: 20.OCT.2015 23:00:51

Conducted Output Power Plot on Configuration IEEE 802.11ac MCS0/Nss1 VHT20 / Chain 3 / 5720 MHz (UNII 2C)

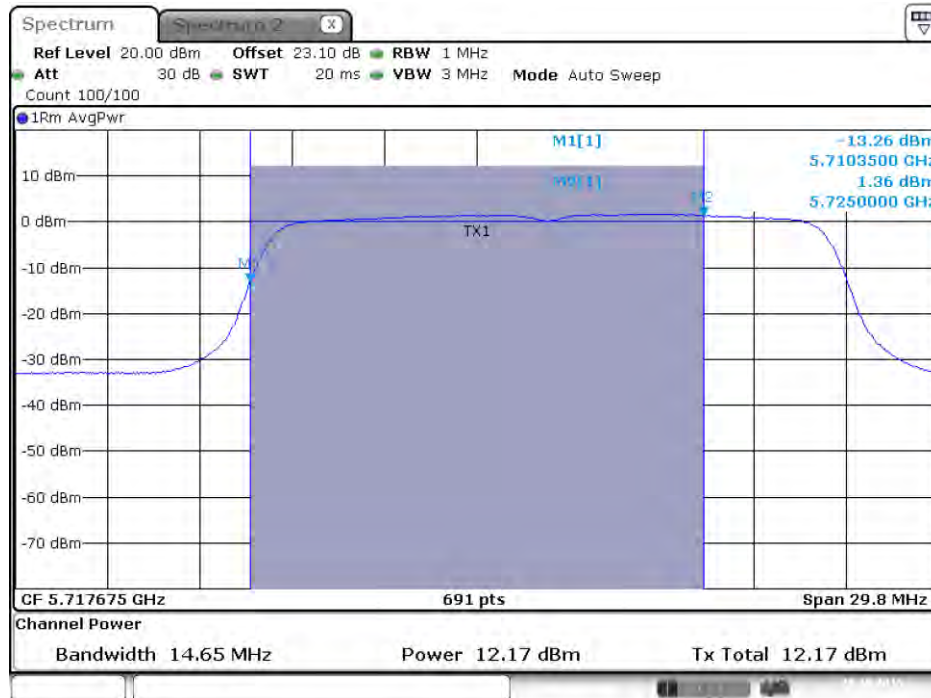

Date: 20 OCT 2015 23:00:58

Conducted Output Power Plot on Configuration IEEE 802.11ac MCS0/Nss1 VHT20 / Chain 4 / 5720 MHz (UNII 2C)

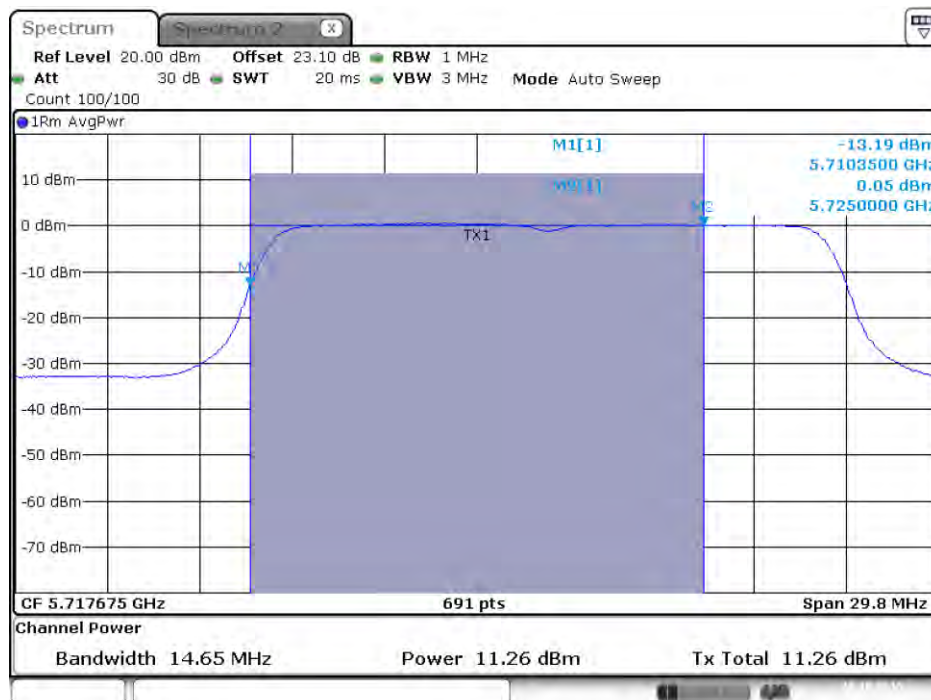

Date: 20.OCT.2015 23:01:06

Conducted Output Power Plot on Configuration IEEE 802.11ac MCS0/Nss1 VHT20 / Chain 1 / 5720 MHz (UNII 3)



Date: 20.OCT.2015 23:00:48

Conducted Output Power Plot on Configuration IEEE 802.11ac MCS0/Nss1 VHT20 / Chain 2 / 5720 MHz (UNII 3)

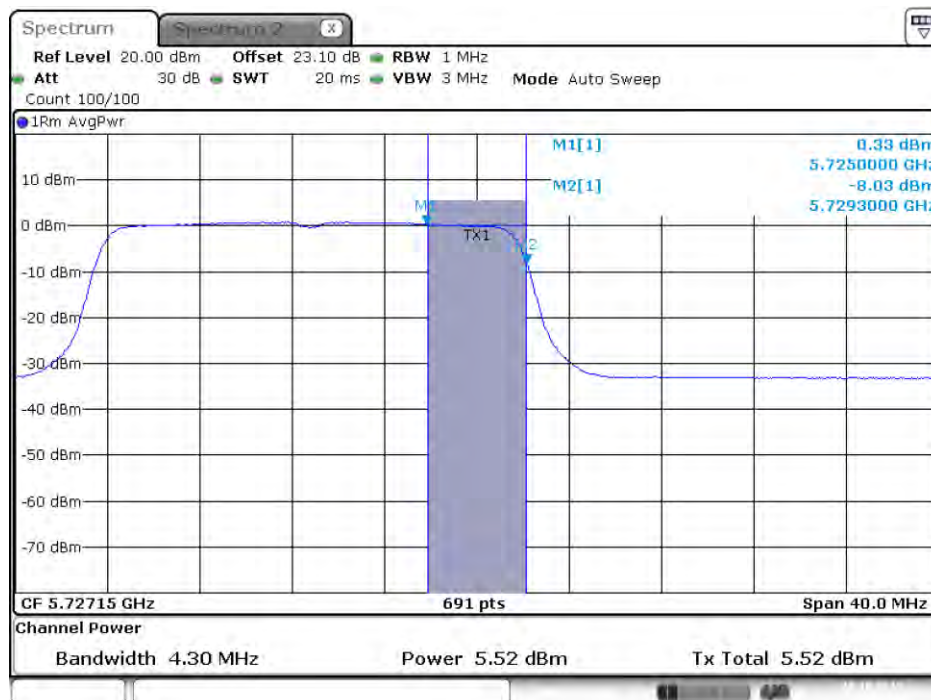

Date: 20.OCT.2015 23:00:55

Conducted Output Power Plot on Configuration IEEE 802.11ac MCS0/Nss1 VHT20 / Chain 3 / 5720 MHz (UNII 3)



Date: 20.OCT.2015 23:01:02

Conducted Output Power Plot on Configuration IEEE 802.11ac MCS0/Nss1 VHT20 / Chain 4 / 5720 MHz (UNII 3)

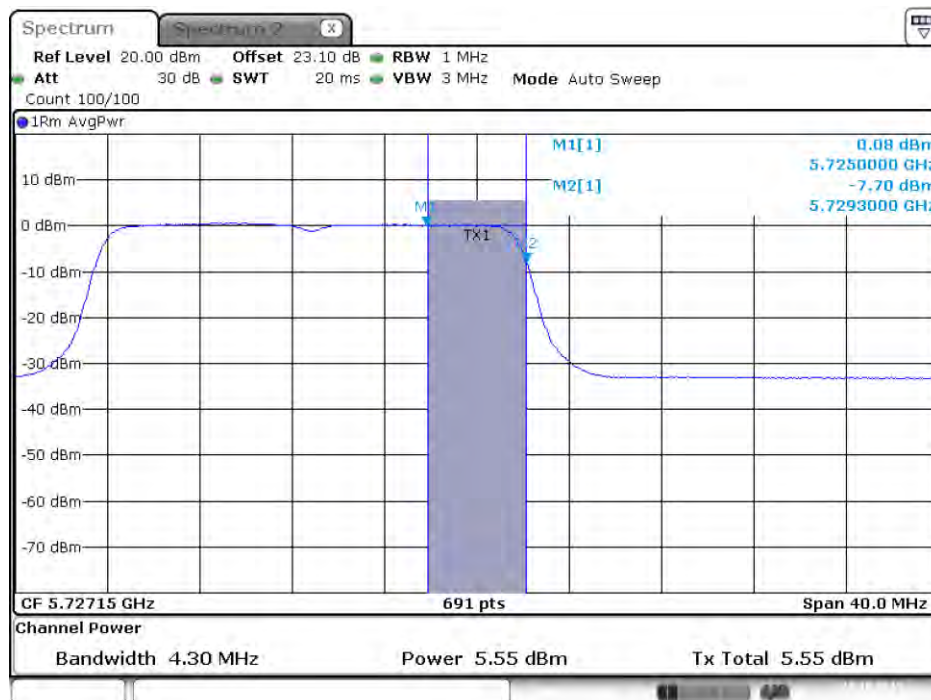

Date: 20.OCT.2015 23:01:09

Conducted Output Power Plot on Configuration IEEE 802.11ac MCS0/Nss1 VHT40 / Chain 1 / 5710 MHz (UNII 2C)

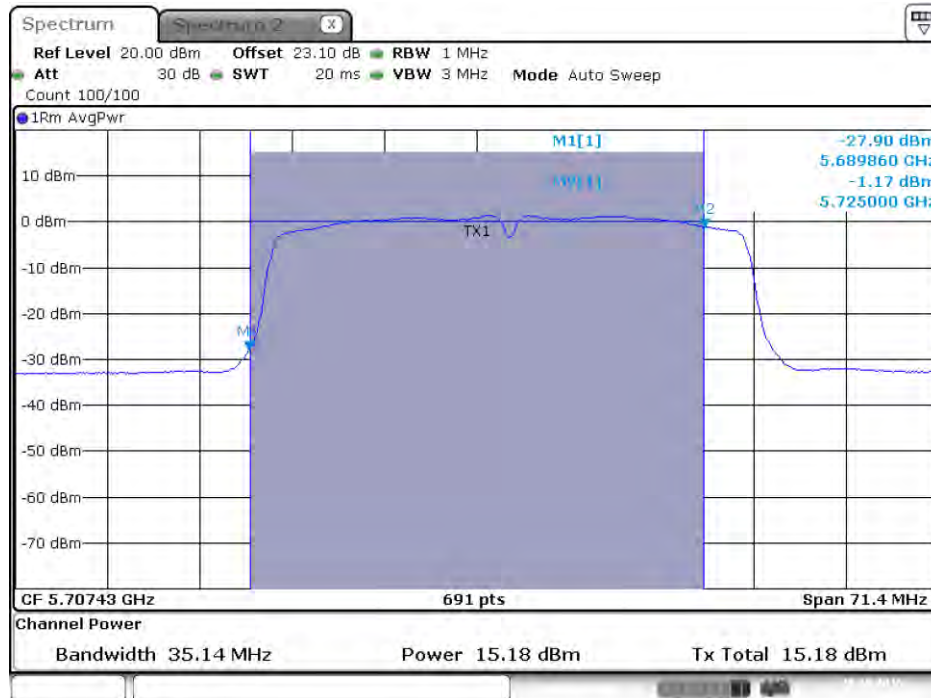

Date: 20.OCT.2015 22:46:40

Conducted Output Power Plot on Configuration IEEE 802.11ac MCS0/Nss1 VHT40 / Chain 2 / 5710 MHz (UNII 2C)

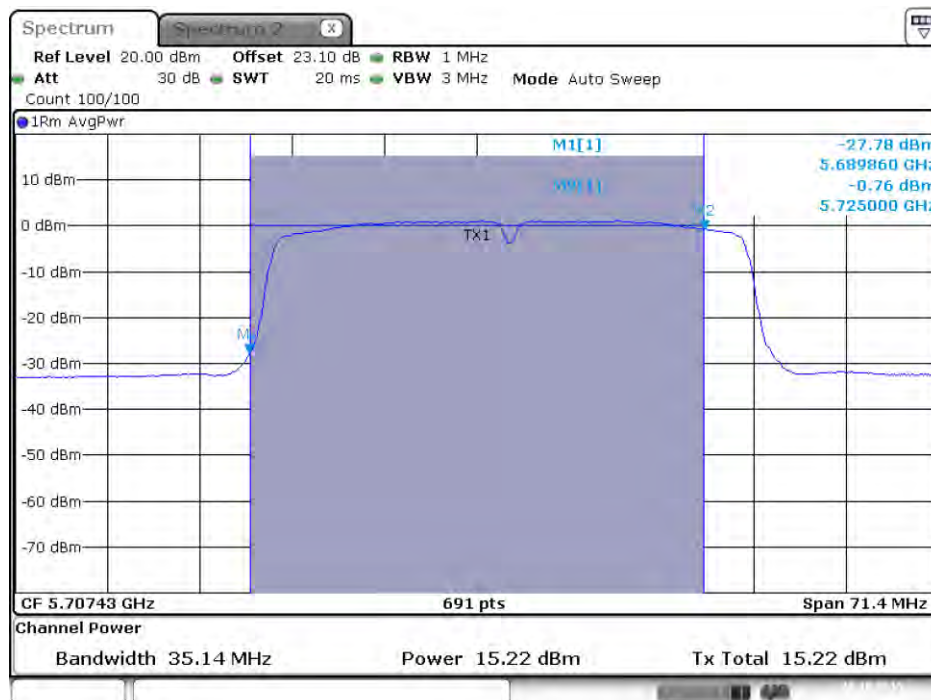

Date: 20.OCT.2015 22:46:47

Conducted Output Power Plot on Configuration IEEE 802.11ac MCS0/Nss1 VHT40 / Chain 3 / 5710 MHz (UNII 2C)

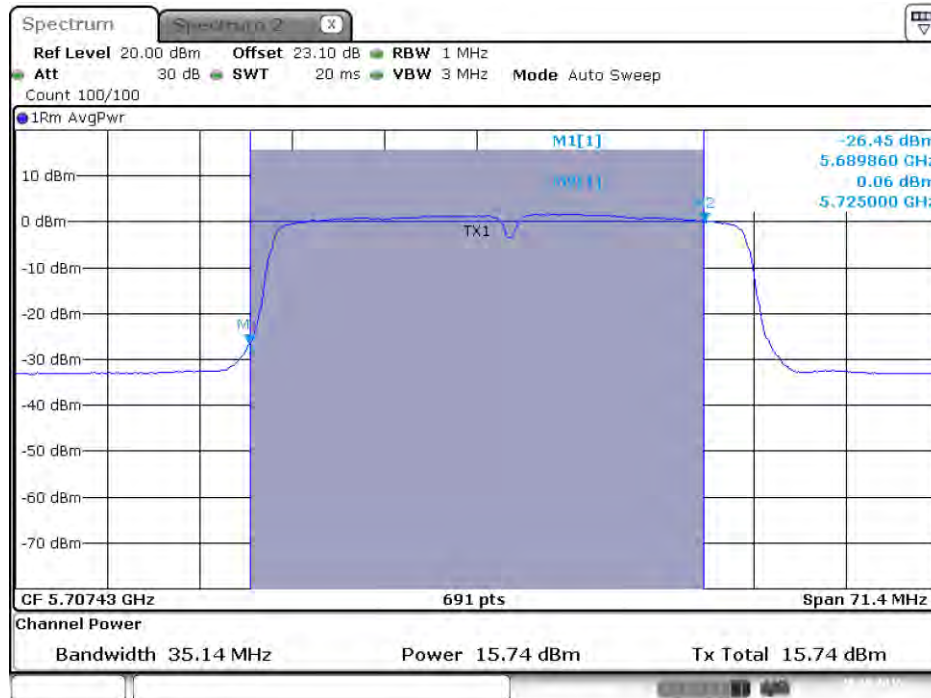

Date: 20 OCT 2015 22:46:54

Conducted Output Power Plot on Configuration IEEE 802.11ac MCS0/Nss1 VHT40 / Chain 4 / 5710 MHz (UNII 2C)

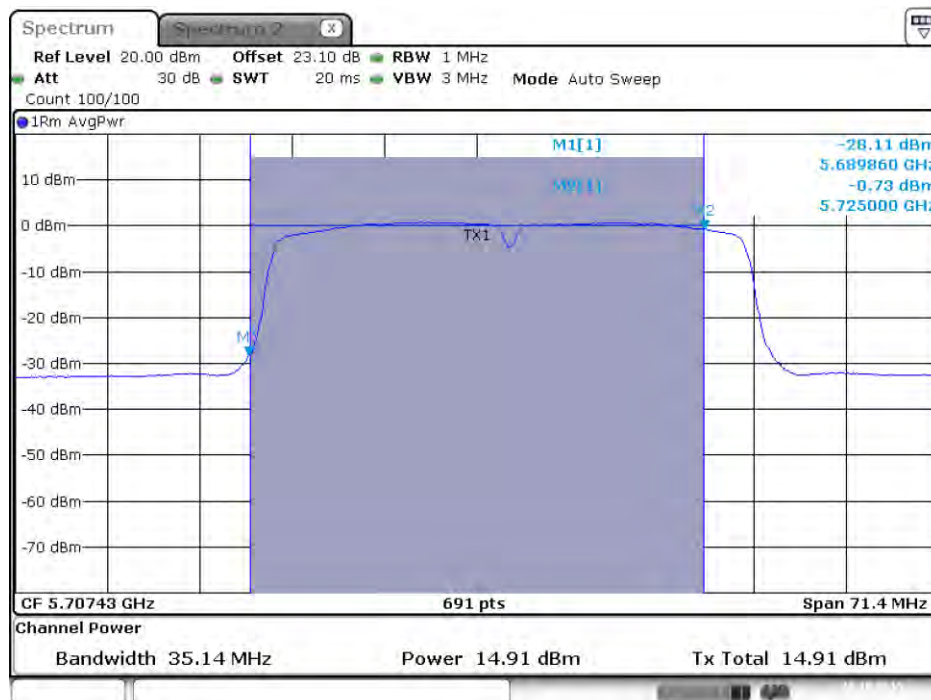

Date: 20.OCT.2015 22:47:01

Conducted Output Power Plot on Configuration IEEE 802.11ac MCS0/Nss1 VHT40 / Chain 1 / 5710 MHz (UNII 3)

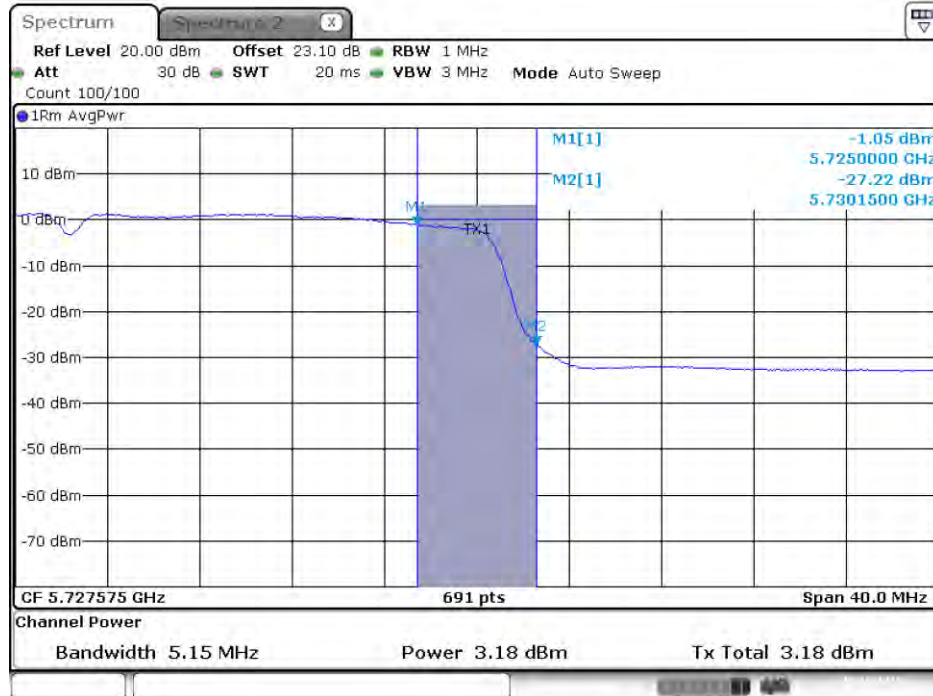

Date: 20.OCT.2015 22:46:44

Conducted Output Power Plot on Configuration IEEE 802.11ac MCS0/Nss1 VHT40 / Chain 2 / 5710 MHz (UNII 3)



Date: 20.OCT.2015 22:46:51

Conducted Output Power Plot on Configuration IEEE 802.11ac MCS0/Nss1 VHT40 / Chain 3 / 5710 MHz (UNII 3)

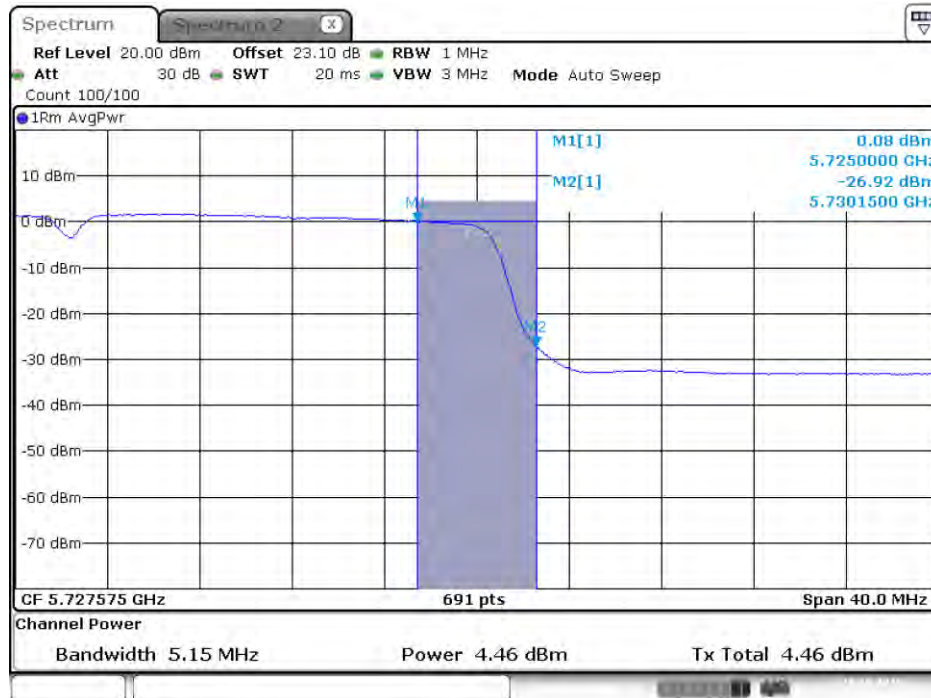

Date: 20.OCT.2015 22:46:58

Conducted Output Power Plot on Configuration IEEE 802.11ac MCS0/Nss1 VHT40 / Chain 4 / 5710 MHz (UNII 3)

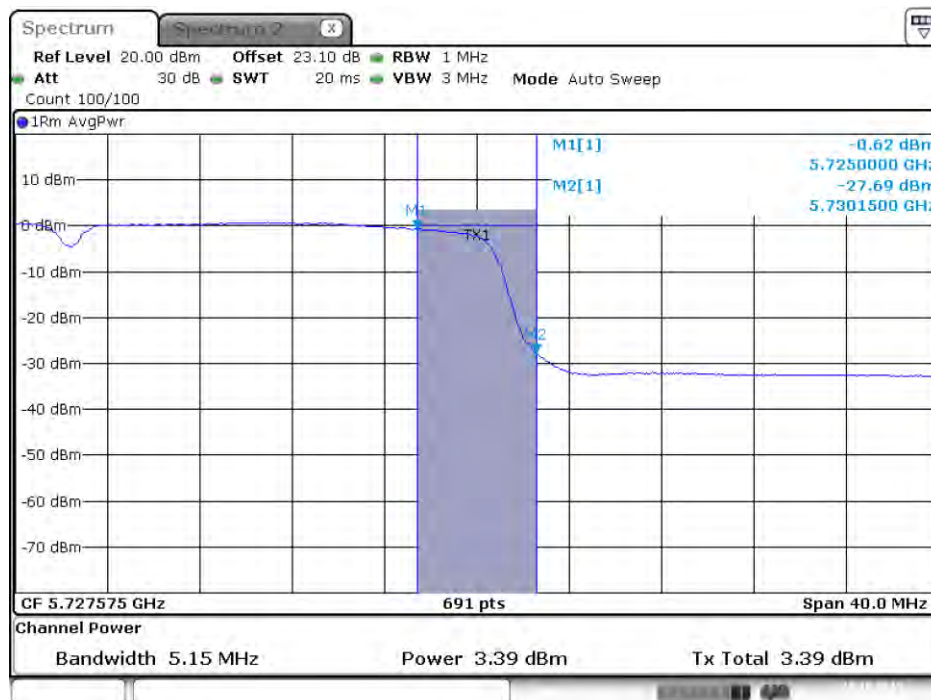

Date: 20.OCT.2015 22:47:05

Conducted Output Power Plot on Configuration IEEE 802.11ac MCS0/Nss1 VHT80 / Chain 1 / 5690 MHz (UNII 2C)

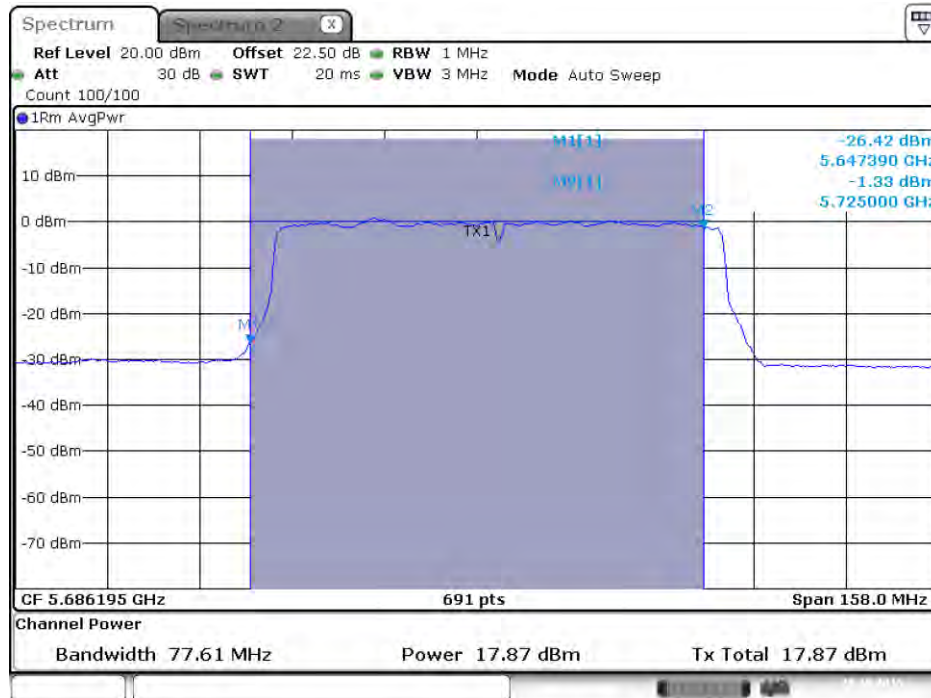

Date: 20.OCT.2015 22:49:49

Conducted Output Power Plot on Configuration IEEE 802.11ac MCS0/Nss1 VHT80 / Chain 2 / 5690 MHz (UNII 2C)

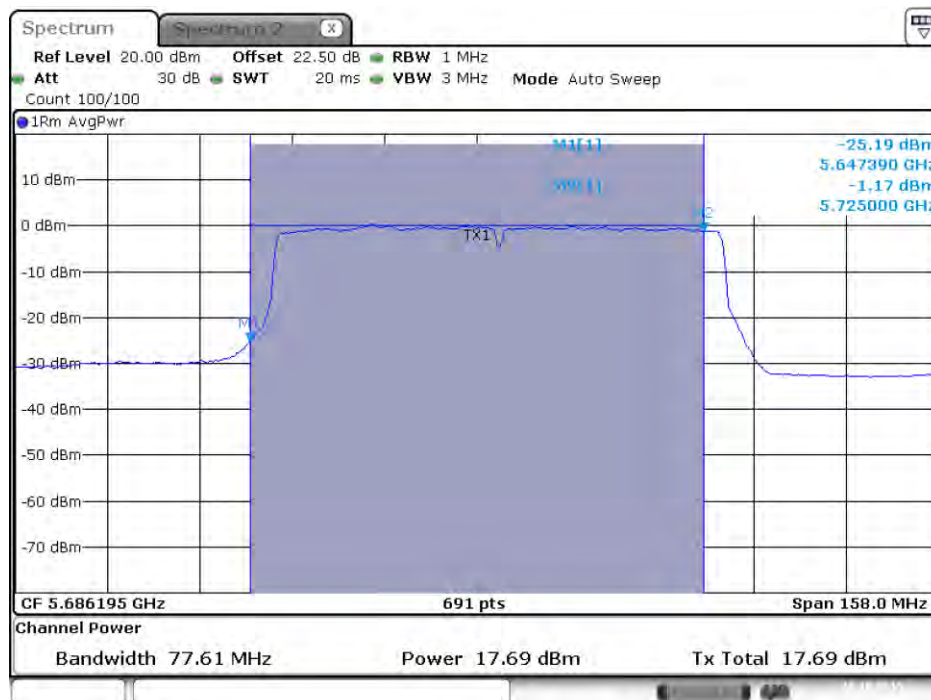

Date: 20.OCT.2015 22:49:56

Conducted Output Power Plot on Configuration IEEE 802.11ac MCS0/Nss1 VHT80 / Chain 3 / 5690 MHz (UNII 2C)

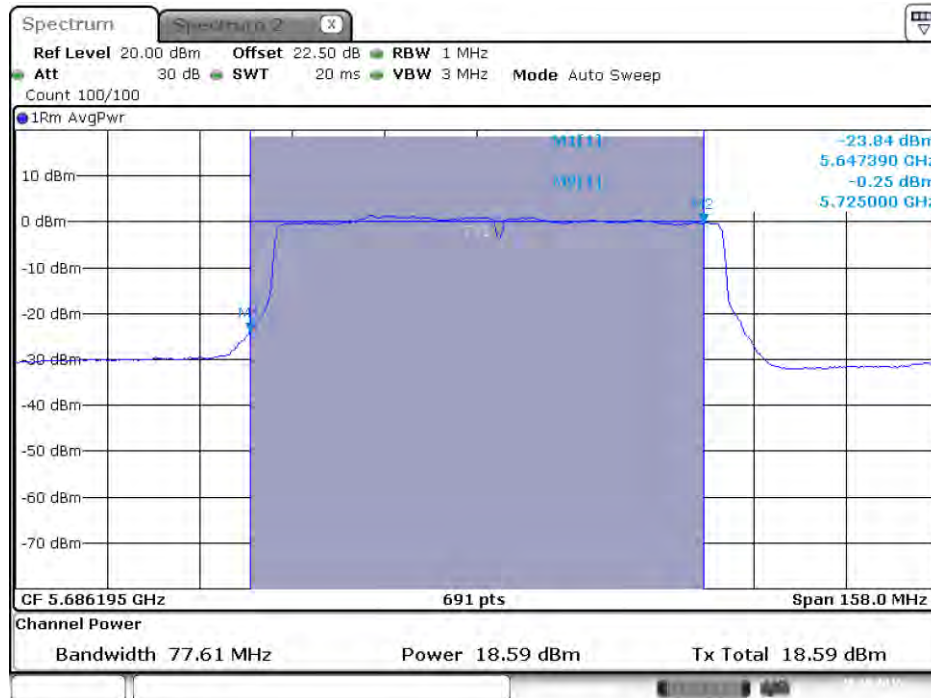

Date: 20.OCT.2015 22:50:03

Conducted Output Power Plot on Configuration IEEE 802.11ac MCS0/Nss1 VHT80 / Chain 4 / 5690 MHz (UNII 2C)

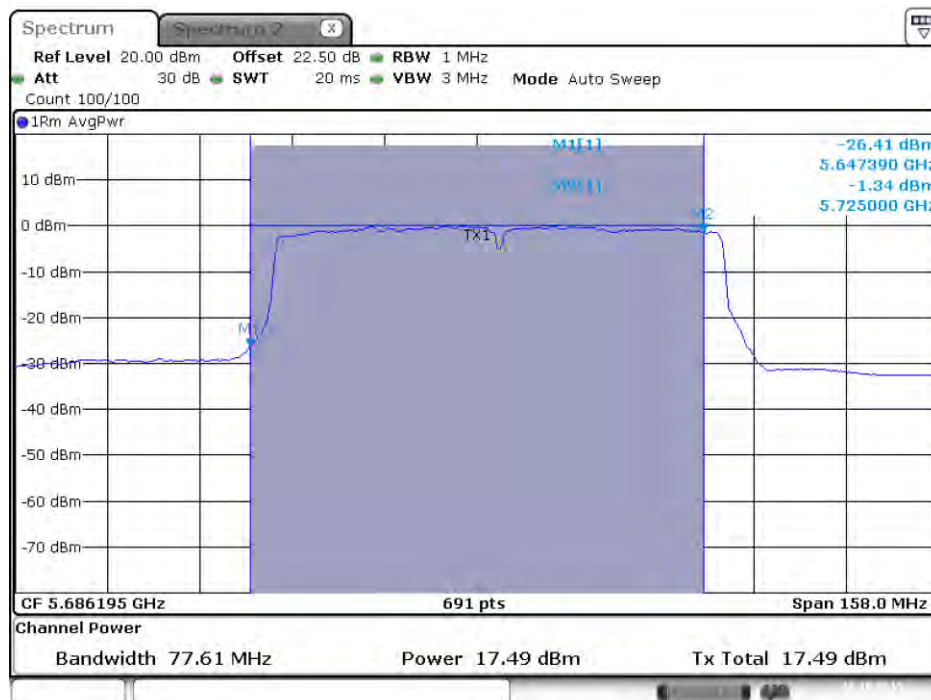

Date: 20.OCT.2015 22:50:10

Conducted Output Power Plot on Configuration IEEE 802.11ac MCS0/Nss1 VHT80 / Chain 1 / 5690 MHz (UNII 3)

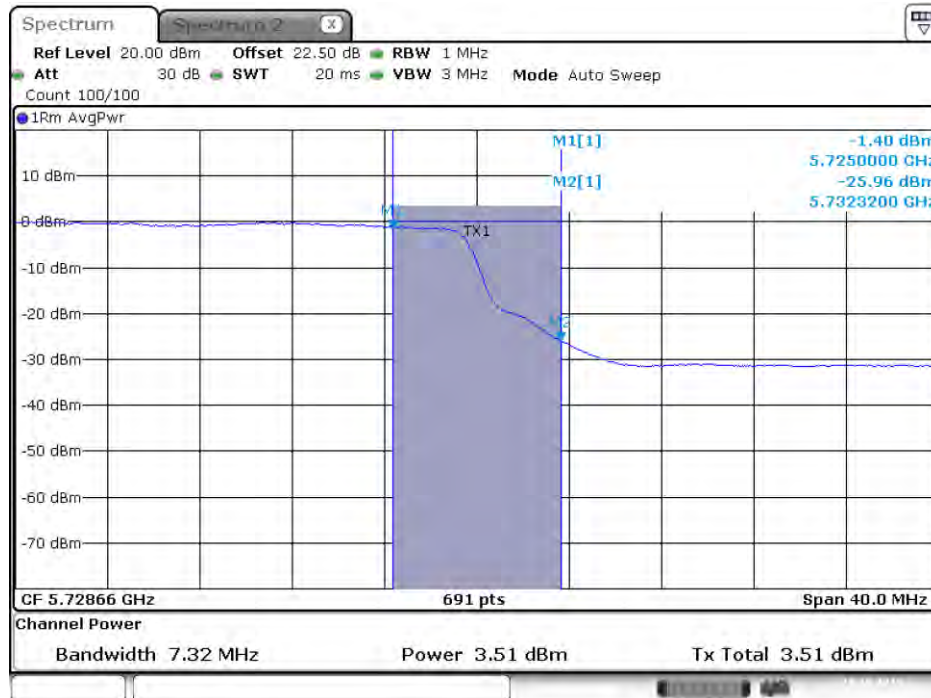

Date: 20.OCT.2015 22:49:52

Conducted Output Power Plot on Configuration IEEE 802.11ac MCS0/Nss1 VHT80 / Chain 2 / 5690 MHz (UNII 3)

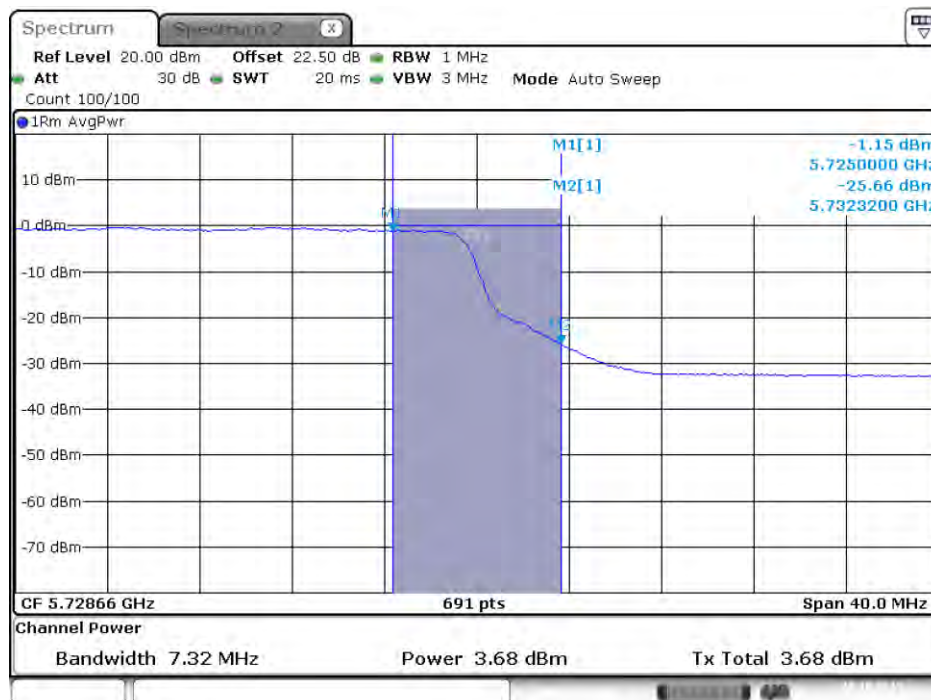

Date: 20.OCT.2015 22:49:59

Conducted Output Power Plot on Configuration IEEE 802.11ac MCS0/Nss1 VHT80 / Chain 3 / 5690 MHz (UNII 3)

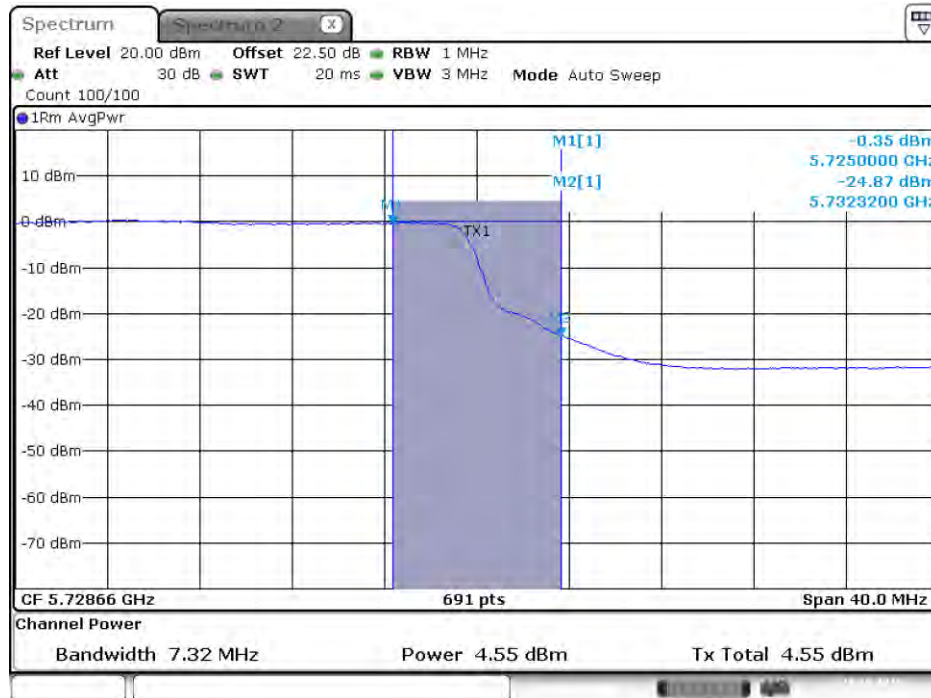

Date: 20.OCT.2015 22:50:06

Conducted Output Power Plot on Configuration IEEE 802.11ac MCS0/Nss1 VHT80 / Chain 4 / 5690 MHz (UNII 3)

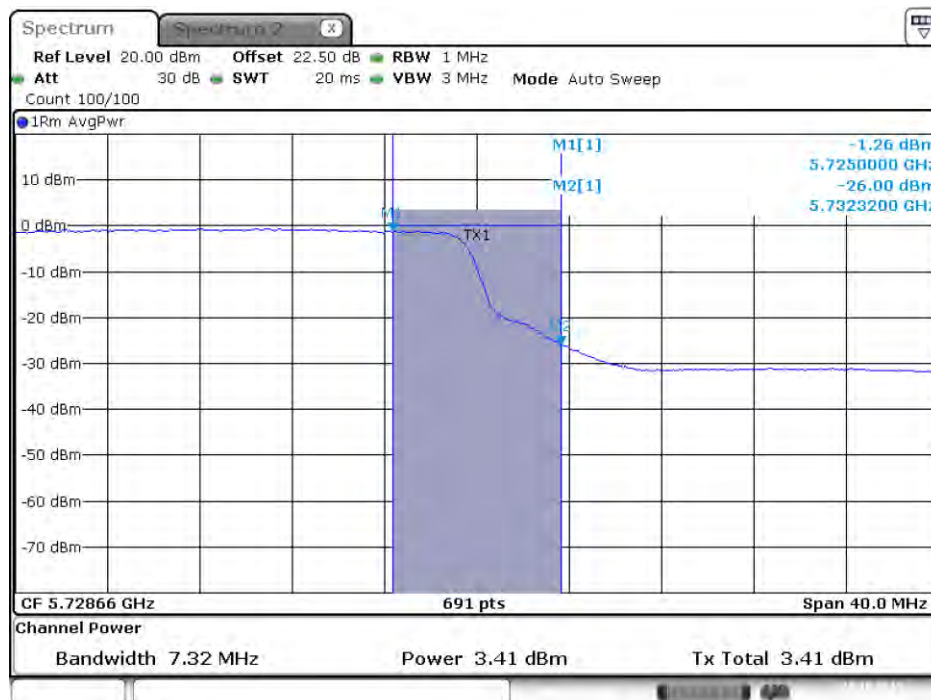

Date: 20.OCT.2015 22:50:13

4.5. Power Spectral Density Measurement

4.5.1. Limit

The following table is power spectral density limits and decrease power density limit rule refer to section 4.4.1.

Frequency Band		Limit
<input checked="" type="checkbox"/>	5.25-5.35 GHz	11 dBm/MHz
<input checked="" type="checkbox"/>	5.470-5.725 GHz	11 dBm/MHz

4.5.2. Measuring Instruments and Setting

Please refer to section 5 of equipments list in this report. The following table is the setting of the spectrum analyzer.

Spectrum Parameter	Setting
Attenuation	Auto
Span Frequency	Encompass the entire emissions bandwidth (EBW) of the signal
RBW	1000 kHz
VBW	3000 kHz
Detector	RMS
Trace	AVERAGE
Sweep Time	Auto
Trace Average	100 times

4.5.3. Test Procedures

1. The transmitter output (antenna port) was connected RF switch to the spectrum analyzer.
2. Test was performed in accordance with KDB789033 D02 v01 for Compliance Testing of Unlicensed National Information Infrastructure (U-NII) Devices - section (F) Maximum Power Spectral Density (PSD).
3. Multiple antenna systems was performed in accordance KDB662911 D01 v02r01 in-Band Power Spectral Density (PSD) Measurements (a) Measure and sum the spectra across the outputs.
4. When measuring first spectral bin of output 1 is summed with that in the first spectral bin of output 2 and that from the first spectral bin of output 3 and so on up to the Nth output to obtain the value for the first frequency bin of the summed spectrum. The summed spectrum value for each of the other frequency bins is computed in the same way.

4.5.4. Test Setup Layout

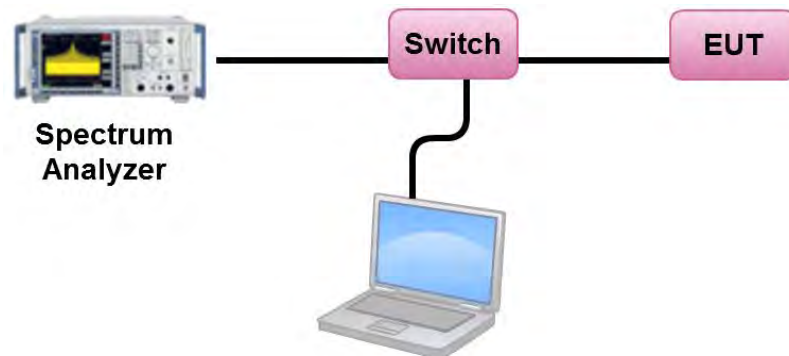

4.5.5. Test Deviation

There is no deviation with the original standard.

4.5.6. EUT Operation during Test

The EUT was programmed to be in continuously transmitting mode.

4.5.7. Test Result of Power Spectral Density

Temperature	25°C	Humidity	50%
Test Engineer	Eddie Weng & Lucas Huang		
Test Mode	Mode 1: PIFA Antenna / Chain1:5.84 dBi, Chain2:5.50 dBi, Chain3:5.84 dBi, Chain4:5.65 dBi		

Mode	Frequency	Power Density (dBm/MHz)	Max. Limit (dBm/MHz)	Result
802.11a	5260 MHz	5.03	5.27	Complies
	5300 MHz	5.10	5.27	Complies
	5320 MHz	5.26	5.27	Complies
	5500 MHz	5.20	5.27	Complies
	5580 MHz	5.04	5.27	Complies
	5700 MHz	5.03	5.27	Complies
802.11ac MCS0/Nss1 VHT20	5260 MHz	5.14	5.27	Complies
	5300 MHz	5.11	5.27	Complies
	5320 MHz	5.13	5.27	Complies
	5500 MHz	5.12	5.27	Complies
	5580 MHz	5.15	5.27	Complies
	5700 MHz	5.09	5.27	Complies
802.11ac MCS0/Nss1 VHT40	5270 MHz	5.04	5.27	Complies
	5310 MHz	0.56	5.27	Complies
	5510 MHz	3.89	5.27	Complies
	5550 MHz	5.18	5.27	Complies
	5670 MHz	5.14	5.27	Complies
802.11ac MCS0/Nss1 VHT80	5290 MHz	-2.68	5.27	Complies
	5530 MHz	-3.57	5.27	Complies
	5610 MHz	4.17	5.27	Complies

Note: $DirectionalGain = 10 \cdot \log \left[\frac{\sum_{j=1}^{N_{SS}} \left\{ \sum_{k=1}^{N_{ANT}} g_{j,k} \right\}^2}{N_{ANT}} \right] = 11.73\text{dBi} > 6\text{dBi}$, so the limit $11 - (11.73 - 6) = 5.27\text{dBm/MHz}$.

Straddle Channel
Configuration IEEE 802.11a / Chain 1 + Chain 2 + Chain 3 + Chain 4

Channel	Frequency	Power Density (dBm/MHz)	Max. Limit (dBm/MHz)	Result
144	5720 MHz (UNII 2C)	5.15	5.27	Complies

Note: $DirectionalGain = 10 \cdot \log \left[\frac{\sum_{j=1}^{N_{SS}} \left\{ \sum_{k=1}^{N_{ANT}} g_{j,k} \right\}^2}{N_{ANT}} \right] = 11.73\text{dBi} > 6\text{dBi}$, so the limit $11 - (11.73 - 6) = 5.27\text{dBm/MHz}$.

Channel	Frequency	Power Density (dBm/MHz)	10log(500kHz/RBW) Factor (dB)	Power Density (dBm/500kHz)	Power Density Limit (dBm/500kHz)	Result
144	5720 MHz (UNII 3)	4.62	-3.01	1.61	24.27	Complies

Note: $DirectionalGain = 10 \cdot \log \left[\frac{\sum_{j=1}^{N_{SS}} \left\{ \sum_{k=1}^{N_{ANT}} g_{j,k} \right\}^2}{N_{ANT}} \right] = 11.73\text{dBi} > 6\text{dBi}$, so the limit $30 - (11.73 - 6) = 24.27\text{dBm/500kHz}$.

Configuration IEEE 802.11ac MCS0/Nss1 VHT20 / Chain 1 + Chain 2 + Chain 3 + Chain 4

Channel	Frequency	Power Density (dBm/MHz)	Max. Limit (dBm/MHz)	Result
144	5720 MHz (UNII 2C)	5.01	5.27	Complies

Note: $DirectionalGain = 10 \cdot \log \left[\frac{\sum_{j=1}^{N_{SS}} \left\{ \sum_{k=1}^{N_{ANT}} g_{j,k} \right\}^2}{N_{ANT}} \right] = 11.73\text{dBi} > 6\text{dBi}$, so the limit $11 - (11.73 - 6) = 5.27\text{dBm/MHz}$.

Channel	Frequency	Power Density (dBm/MHz)	10log(500kHz/RBW) Factor (dB)	Power Density (dBm/500kHz)	Power Density Limit (dBm/500kHz)	Result
144	5720 MHz (UNII 3)	4.37	-3.01	1.36	24.27	Complies

Note: $DirectionalGain = 10 \cdot \log \left[\frac{\sum_{j=1}^{N_{SS}} \left\{ \sum_{k=1}^{N_{ANT}} g_{j,k} \right\}^2}{N_{ANT}} \right] = 11.73\text{dBi} > 6\text{dBi}$, so the limit $30 - (11.73 - 6) = 24.27\text{dBm/500kHz}$.

Configuration IEEE 802.11ac MCS0/Nss1 VHT40 / Chain 1 + Chain 2 + Chain 3 + Chain 4

Channel	Frequency	Power Density (dBm/MHz)	Max. Limit (dBm/MHz)	Result
142	5710 MHz (UNII 2C)	5.02	5.27	Complies

Note: $DirectionalGain = 10 \cdot \log \left[\frac{\sum_{j=1}^{N_{SS}} \left\{ \sum_{k=1}^{N_{ANT}} g_{j,k} \right\}^2}{N_{ANT}} \right] = 11.73\text{dBi} > 6\text{dBi}$, so the limit $11 - (11.73 - 6) = 5.27\text{dBm/MHz}$.

Channel	Frequency	Power Density (dBm/MHz)	10log(500kHz/RBW) Factor (dB)	Power Density (dBm/500kHz)	Power Density Limit (dBm/500kHz)	Result
142	5710 MHz (UNII 3)	3.39	-3.01	0.38	24.27	Complies

Note: $DirectionalGain = 10 \cdot \log \left[\frac{\sum_{j=1}^{N_{SS}} \left\{ \sum_{k=1}^{N_{ANT}} g_{j,k} \right\}^2}{N_{ANT}} \right] = 11.73\text{dBi} > 6\text{dBi}$, so the limit $30 - (11.73 - 6) = 24.27\text{dBm/500kHz}$.

Configuration IEEE 802.11ac MCS0/Nss1 VHT80 / Chain 1 + Chain 2 + Chain 3 + Chain 4

Channel	Frequency	Power Density (dBm/MHz)	Max. Limit (dBm/MHz)	Result
138	5690 MHz (UNII 2C)	5.20	5.27	Complies

Note: $DirectionalGain = 10 \cdot \log \left[\frac{\sum_{j=1}^{N_{SS}} \left\{ \sum_{k=1}^{N_{ANT}} g_{j,k} \right\}^2}{N_{ANT}} \right] = 11.73\text{dBi} > 6\text{dBi}$, so the limit $11 - (11.73 - 6) = 5.27\text{dBm/MHz}$.

Channel	Frequency	Power Density (dBm/MHz)	10log(500kHz/RBW) Factor (dB)	Power Density (dBm/500kHz)	Power Density Limit (dBm/500kHz)	Result
138	5690 MHz (UNII 3)	3.75	-3.01	0.74	24.27	Complies

Note: $DirectionalGain = 10 \cdot \log \left[\frac{\sum_{j=1}^{N_{SS}} \left\{ \sum_{k=1}^{N_{ANT}} g_{j,k} \right\}^2}{N_{ANT}} \right] = 11.73\text{dBi} > 6\text{dBi}$, so the limit $30 - (11.73 - 6) = 24.27\text{dBm/500kHz}$.

Note: All the test values were listed in the report.

For plots, only the channel with worse result was shown.

Mode 1: PIFA Antenna / Chain1:5.84 dBi, Chain2:5.50 dBi, Chain3:5.84 dBi, Chain4:5.65 dBi

Power Density Plot on Configuration IEEE 802.11a / Chain 1 + Chain 2 + Chain 3 + Chain 4 / 5320 MHz

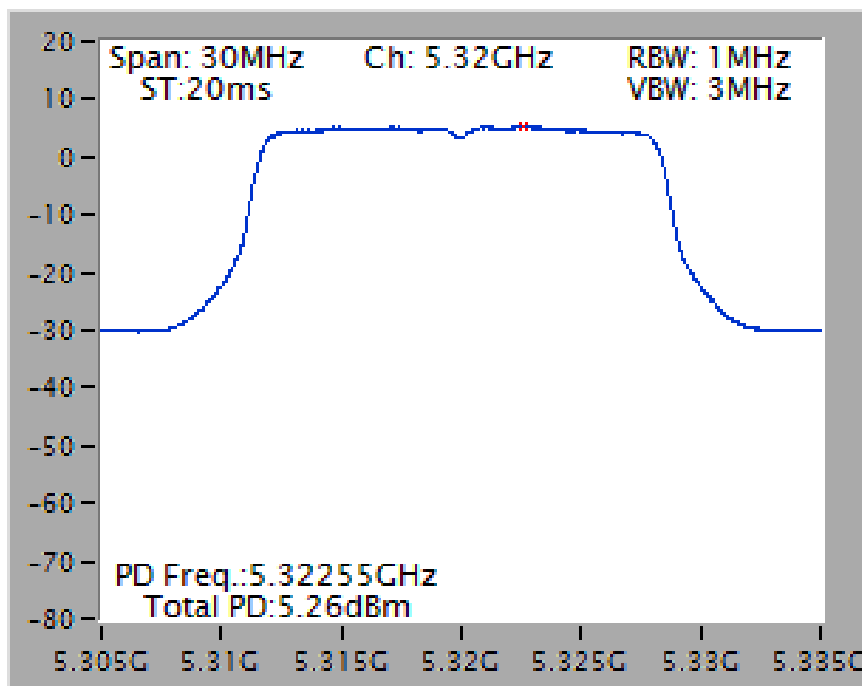

Power Density Plot on Configuration IEEE 802.11a / Chain 1 + Chain 2 + Chain 3 + Chain 4 / 5500 MHz

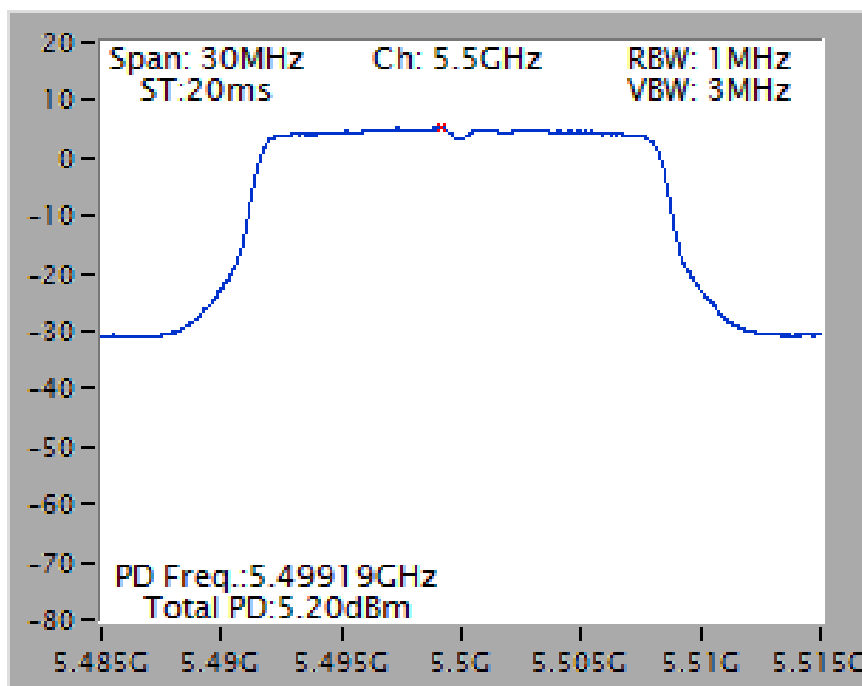

Power Density Plot on Configuration IEEE 802.11ac MCS0/Nss1 VHT20 / Chain 1 + Chain 2 + Chain 3 + Chain 4 / 5260 MHz

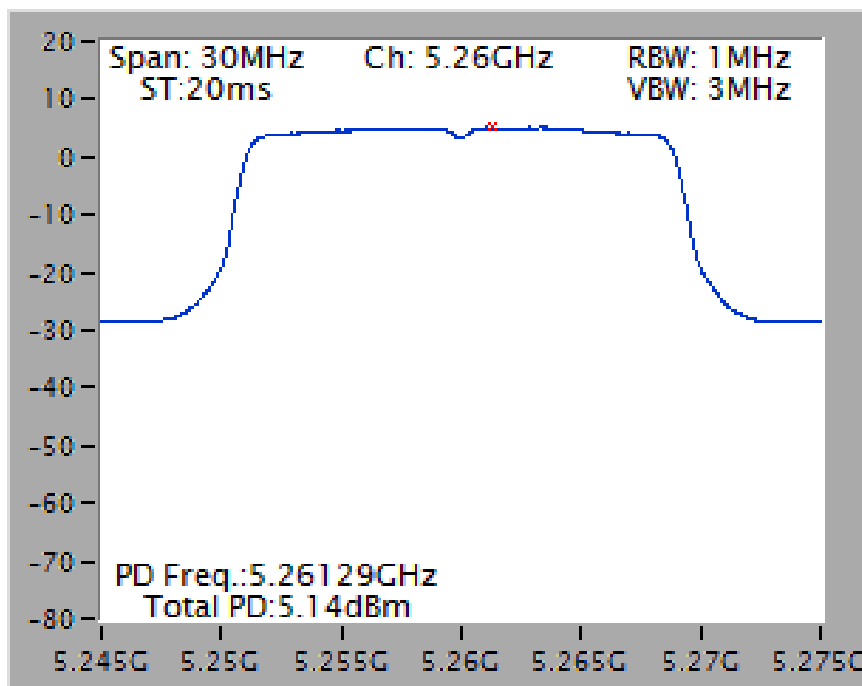

Power Density Plot on Configuration IEEE 802.11ac MCS0/Nss1 VHT20 / Chain 1 + Chain 2 + Chain 3 + Chain 4 / 5580 MHz

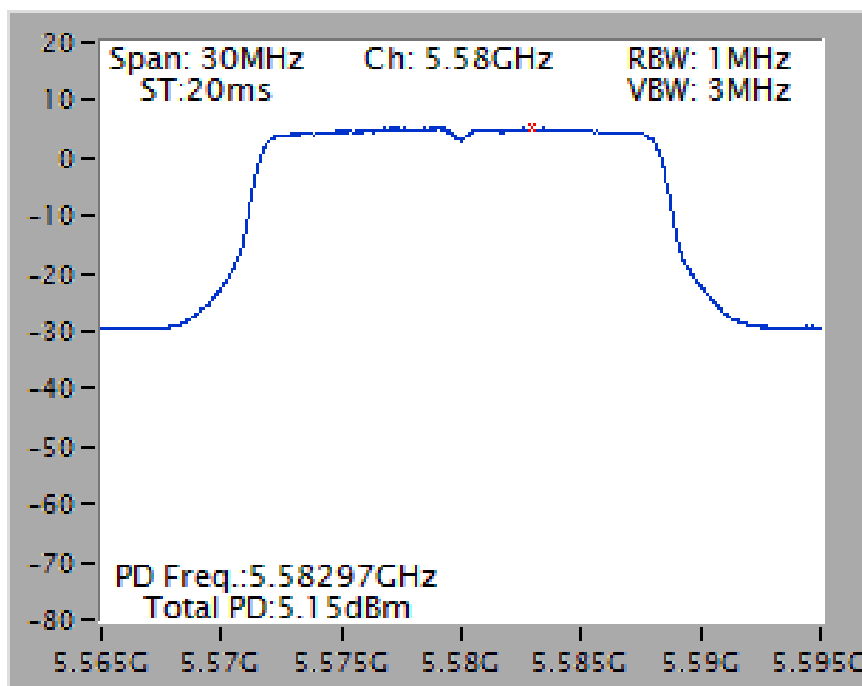

Power Density Plot on Configuration IEEE 802.11ac MCS0/Nss1 VHT40 / Chain 1 + Chain 2 + Chain 3 + Chain 4 / 5270 MHz

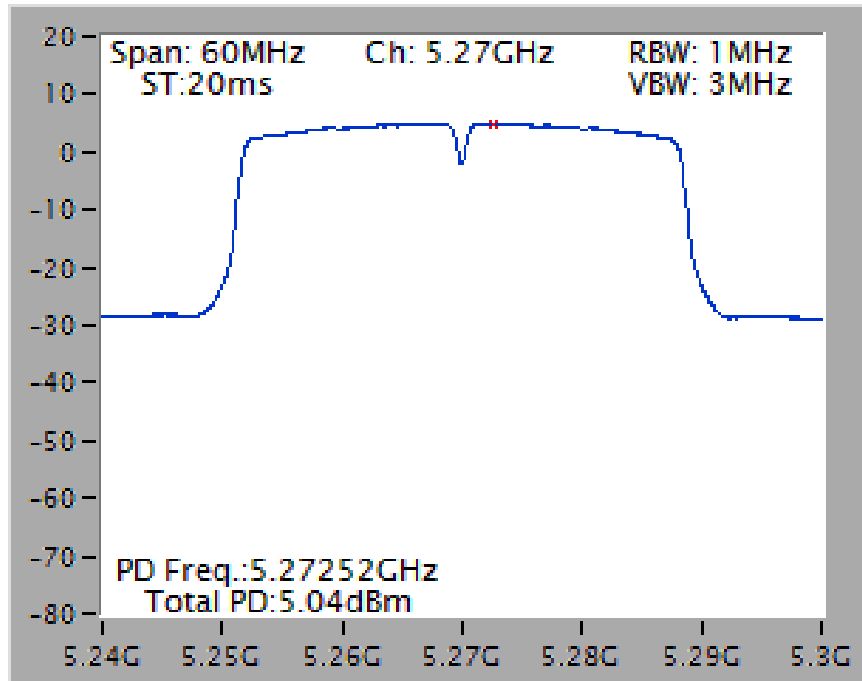

Power Density Plot on Configuration IEEE 802.11ac MCS0/Nss1 VHT40 / Chain 1 + Chain 2 + Chain 3 + Chain 4 / 5550 MHz

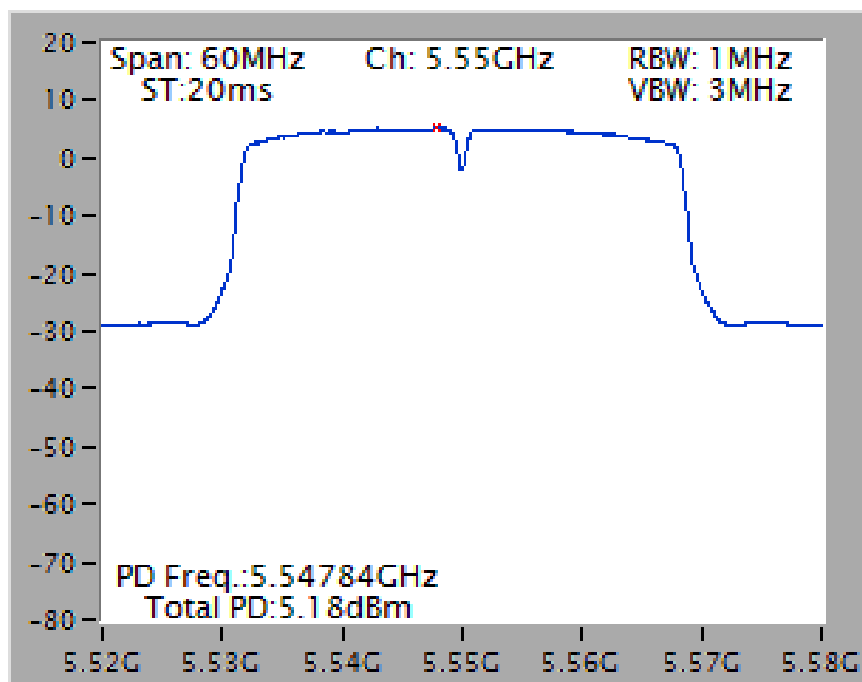

Power Density Plot on Configuration IEEE 802.11ac MCS0/Nss1 VHT80 / Chain 1 + Chain 2 + Chain 3 + Chain 4 / 5290 MHz

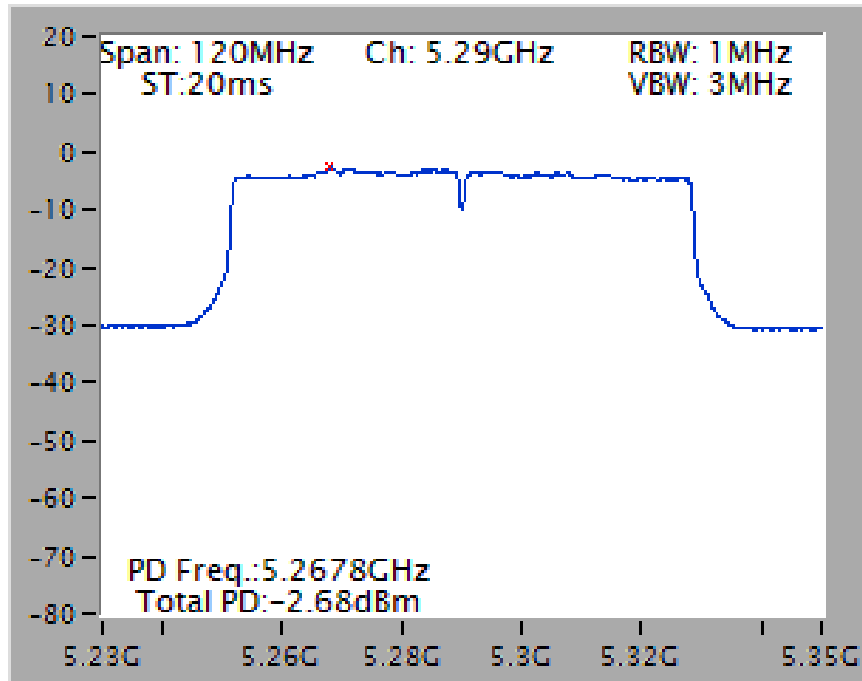

Power Density Plot on Configuration IEEE 802.11ac MCS0/Nss1 VHT80 / Chain 1 + Chain 2 + Chain 3 + Chain 4 / 5610 MHz

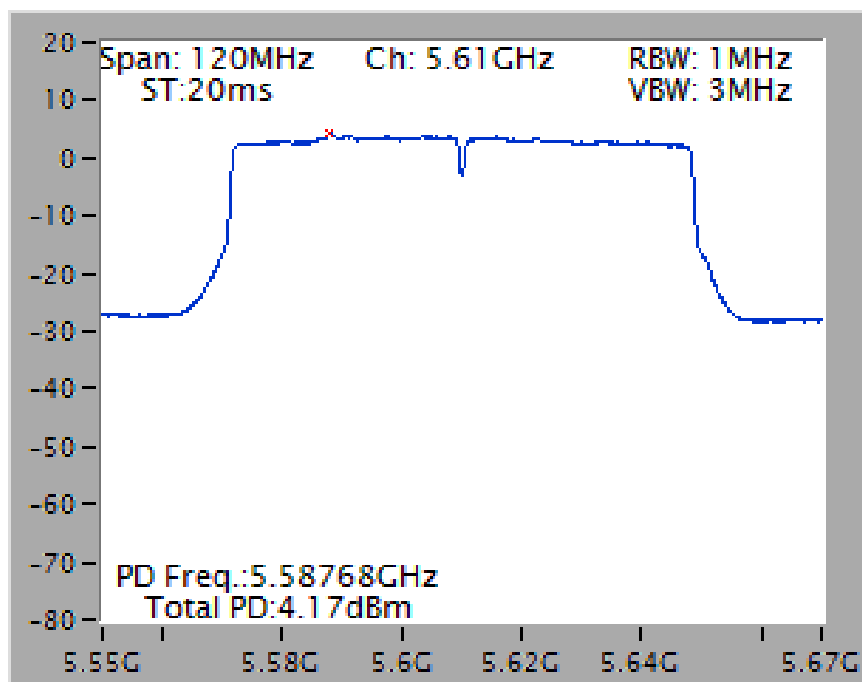

Straddle Channel

Power Density Plot on Configuration IEEE 802.11a / Chain 1 + Chain 2 + Chain 3 + Chain 4 / 5720 MHz (UNII 2C)

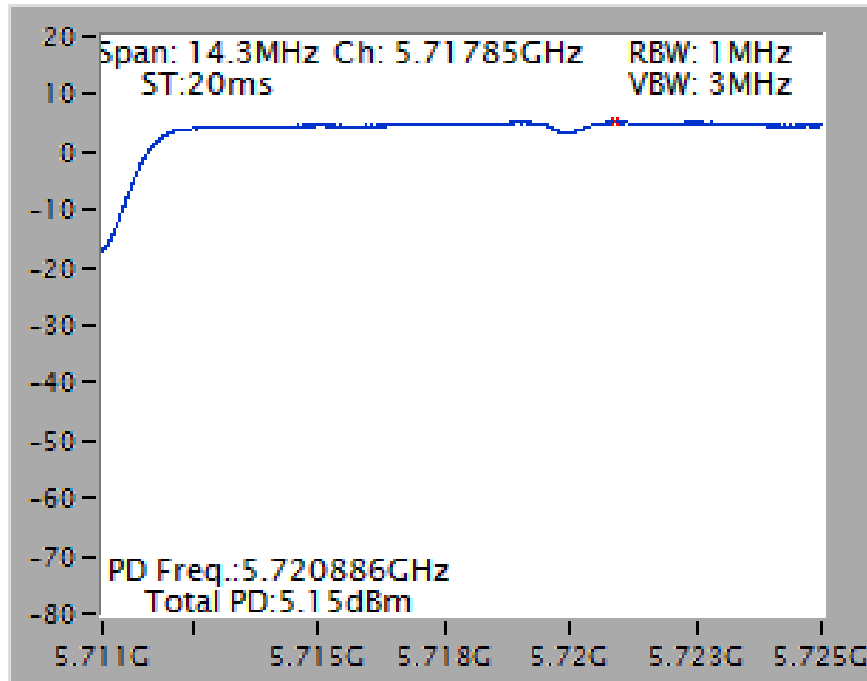

Power Density Plot on Configuration IEEE 802.11a / Chain 1 + Chain 2 + Chain 3 + Chain 4 / 5720 MHz (UNII 3)

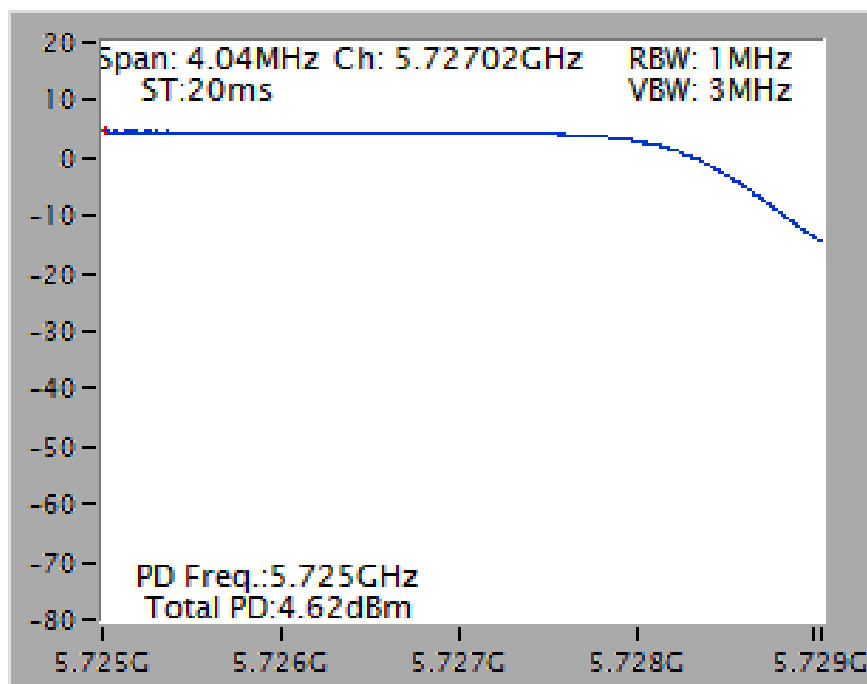

Power Density Plot on Configuration IEEE 802.11ac MCS0/Nss1 VHT20 / Chain 1 + Chain 2 + Chain 3 + Chain 4 / 5720 MHz (UNII 2C)

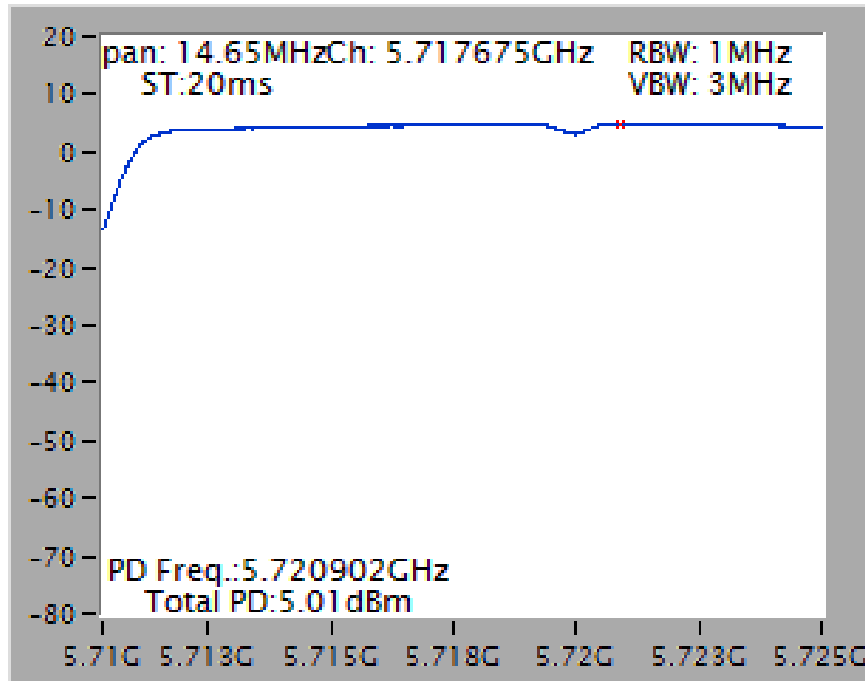

Power Density Plot on Configuration IEEE 802.11ac MCS0/Nss1 VHT20 / Chain 1 + Chain 2 + Chain 3 + Chain 4 / 5720 MHz (UNII 3)

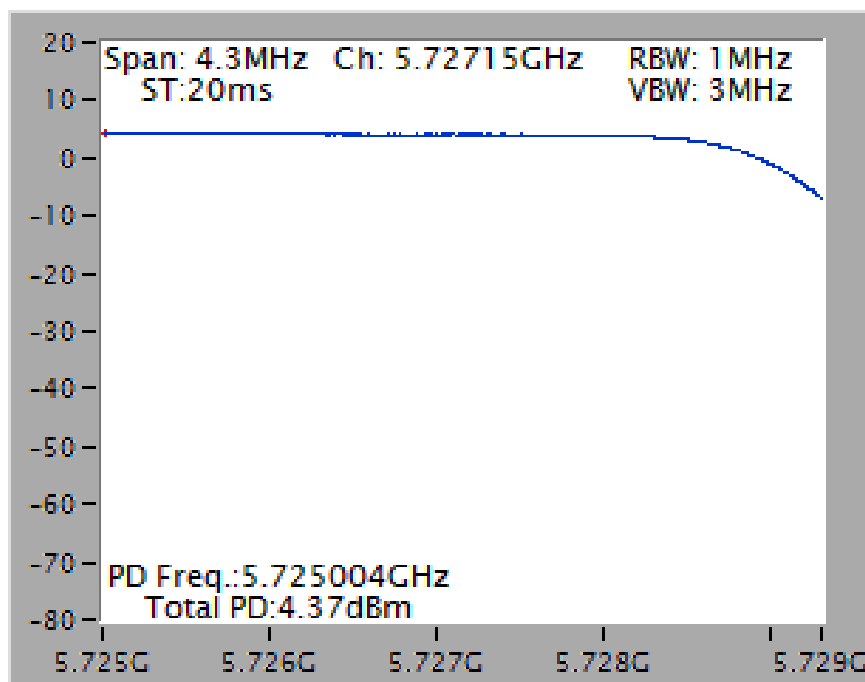

Power Density Plot on Configuration IEEE 802.11ac MCS0/Nss1 VHT40 / Chain 1 + Chain 2 + Chain 3 + Chain 4 / 5710 MHz (UNII 2C)

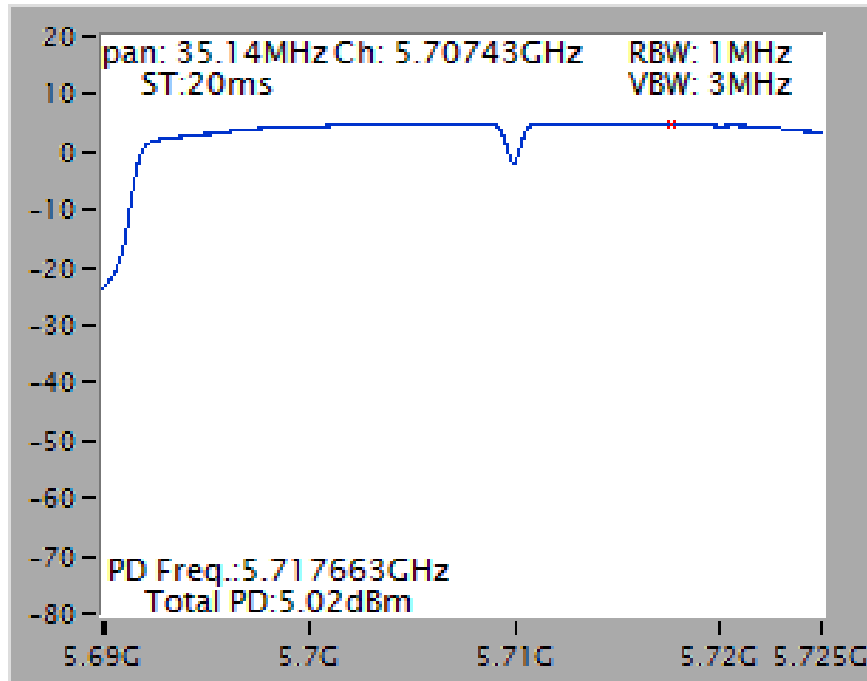

Power Density Plot on Configuration IEEE 802.11ac MCS0/Nss1 VHT40 / Chain 1 + Chain 2 + Chain 3 + Chain 4 / 5710 MHz (UNII 3)

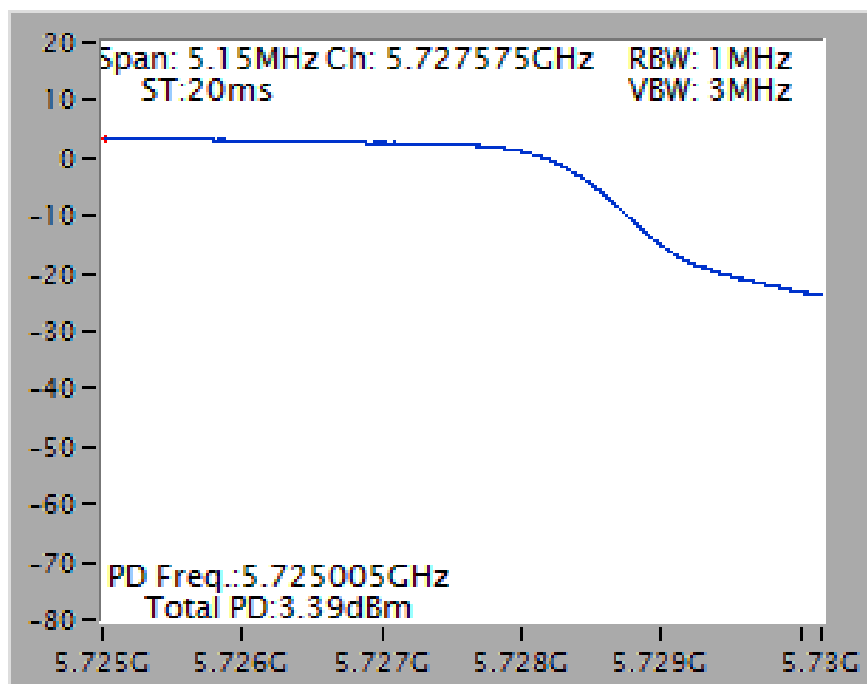

Power Density Plot on Configuration IEEE 802.11ac MCS0/Nss1 VHT80 / Chain 1 + Chain 2 + Chain 3 + Chain 4 / 5690 MHz (UNII 2C)

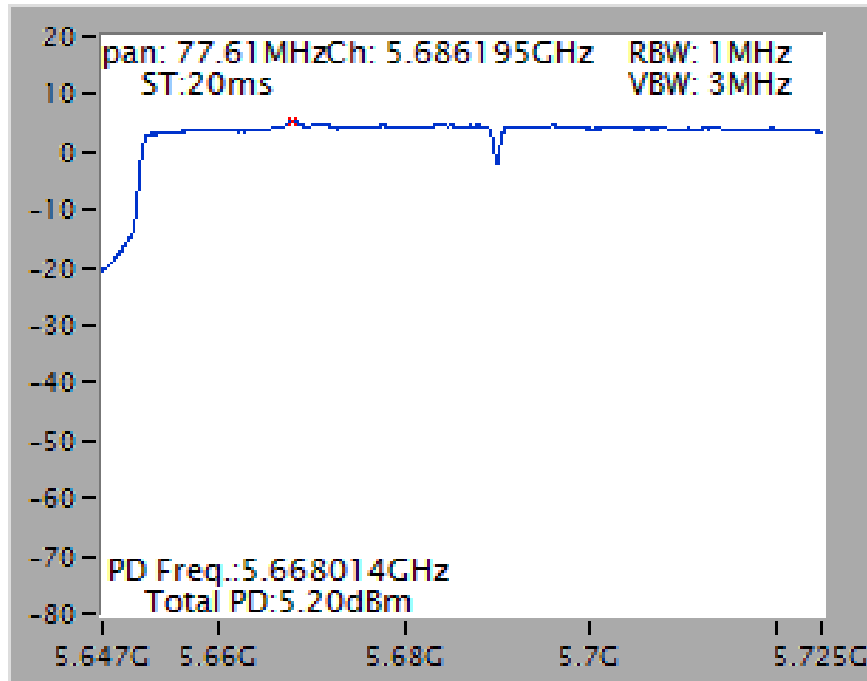

Power Density Plot on Configuration IEEE 802.11ac MCS0/Nss1 VHT80 / Chain 1 + Chain 2 + Chain 3 + Chain 4 / 5690 MHz (UNII 3)

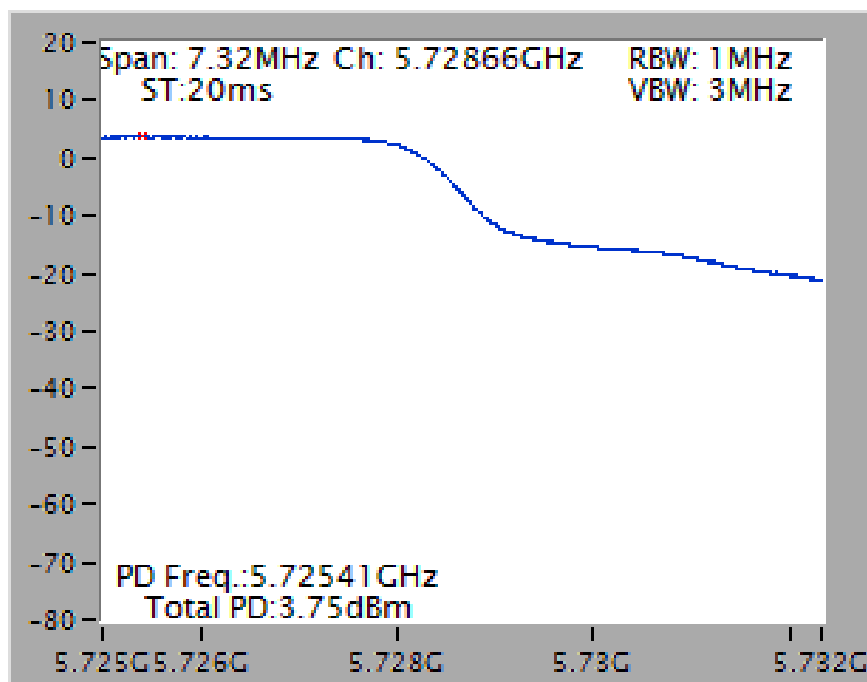

4.6. Radiated Emissions Measurement

4.6.1. Limit

For transmitters operating in the 5.25-5.35 GHz band: all emissions outside of the 5.15-5.35 GHz band shall not exceed an e.i.r.p. of -27 dBm/MHz.

For transmitters operating in the 5.470-5.725 GHz band: all emissions outside of the 5.47-5.725 GHz band shall not exceed an e.i.r.p. of -27 dBm/MHz.

In addition, In case the emission fall within the restricted band specified on 15.205(a), then the 15.209(a) limit in the table below has to be followed.

Frequencies (MHz)	Field Strength (micorvolts/meter)	Measurement Distance (meters)
0.009~0.490	2400/F(kHz)	300
0.490~1.705	24000/F(kHz)	30
1.705~30.0	30	30
30~88	100	3
88~216	150	3
216~960	200	3
Above 960	500	3

4.6.2. Measuring Instruments and Setting

Please refer to section 5 of equipments list in this report. The following table is the setting of spectrum analyzer and receiver.

Spectrum Parameter	Setting
Attenuation	Auto
Start Frequency	1000 MHz
Stop Frequency	40 GHz
RBW / VBW (Emission in restricted band)	1MHz / 3MHz for Peak, 1MHz / 1/T for Average
RBW / VBW (Emission in non-restricted band)	1MHz / 3MHz for peak

Receiver Parameter	Setting
Attenuation	Auto
Start ~ Stop Frequency	9kHz~150kHz / RBW 200Hz for QP
Start ~ Stop Frequency	150kHz~30MHz / RBW 9kHz for QP
Start ~ Stop Frequency	30MHz~1000MHz / RBW 120kHz for QP

4.6.3. Test Procedures

1. Configure the EUT according to ANSI C63.10. The EUT was placed on the top of the turntable 1.5 meter above ground. The phase center of the receiving antenna mounted on the top of a height-variable antenna tower was placed 1m & 3m far away from the turntable.
2. Power on the EUT and all the supporting units. The turntable was rotated by 360 degrees to determine the position of the highest radiation.
3. The height of the broadband receiving antenna was varied between one meter and four meters above ground to find the maximum emissions field strength of both horizontal and vertical polarization.
4. For each suspected emissions, the antenna tower was scan (from 1 M to 4 M) and then the turntable was rotated (from 0 degree to 360 degrees) to find the maximum reading.
5. Set the test-receiver system to Peak or CISPR quasi-peak Detect Function with specified bandwidth under Maximum Hold Mode.
6. For emissions above 1GHz, use 1MHz VBW and 3MHz RBW for peak reading. Then 1MHz RBW and 1/T VBW for average reading in spectrum analyzer.
7. If the emissions level of the EUT in peak mode was 3 dB lower than the average limit specified, then testing will be stopped and peak values of EUT will be reported, otherwise, the emissions which do not have 3 dB margin will be repeated one by one using the quasi-peak method for below 1GHz.
8. For testing above 1GHz, the emissions level of the EUT in peak mode was lower than average limit (that means the emissions level in peak mode also complies with the limit in average mode), then testing will be stopped and peak values of EUT will be reported, otherwise, the emissions will be measured in average mode again and reported.
9. In case the emission is lower than 30MHz, loop antenna has to be used for measurement and the recorded data should be QP measured by receiver. High – Low scan is not required in this case.

4.6.4. Test Setup Layout

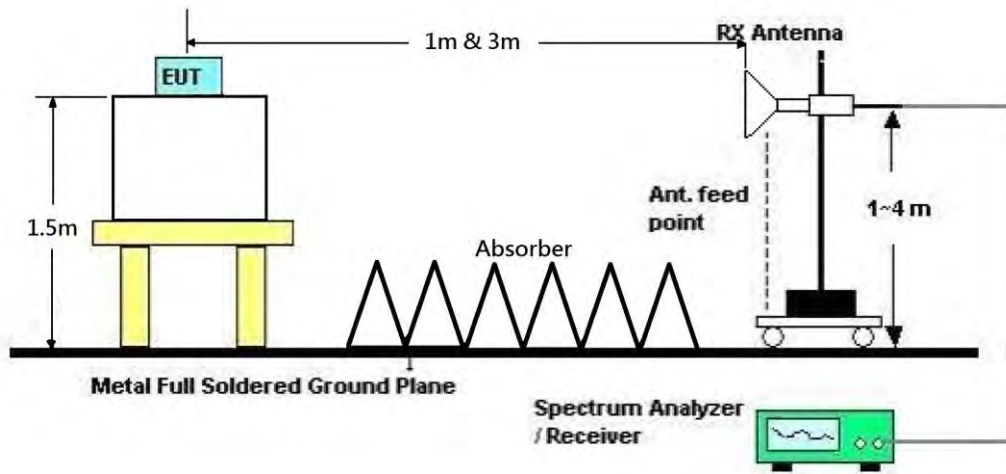

4.6.5. Test Deviation

There is no deviation with the original standard.

4.6.6. EUT Operation during Test

The EUT was programmed to be in continuously transmitting mode.

4.6.7. Results of Radiated Emissions (9kHz~30MHz)

Temperature	22.5°C	Humidity	55%
Test Engineer	Lynus Tsai	Configurations	Normal Link
Test Date	Oct. 12, 2017	Test Mode	Mode 1

Freq. (MHz)	Level (dBuV)	Over Limit (dB)	Limit Line (dBuV)	Remark
-	-	-	-	See Note

Note:

The amplitude of spurious emissions that are attenuated by more than 20dB below the permissible value has no need to be reported.

Distance extrapolation factor = $40 \log (\text{specific distance} / \text{test distance})$ (dB);

Limit line = specific limits (dBuV) + distance extrapolation factor.

4.6.8. Results of Radiated Emissions (30MHz~1GHz)

Temperature	22.5°C	Humidity	55%
Test Engineer	Lynus Tsai	Configurations	CTX
Test Mode	Mode 1		

Horizontal

802.11ac VHT80_Nss1,(MCS0)_4TX

5610MHz_Adapter

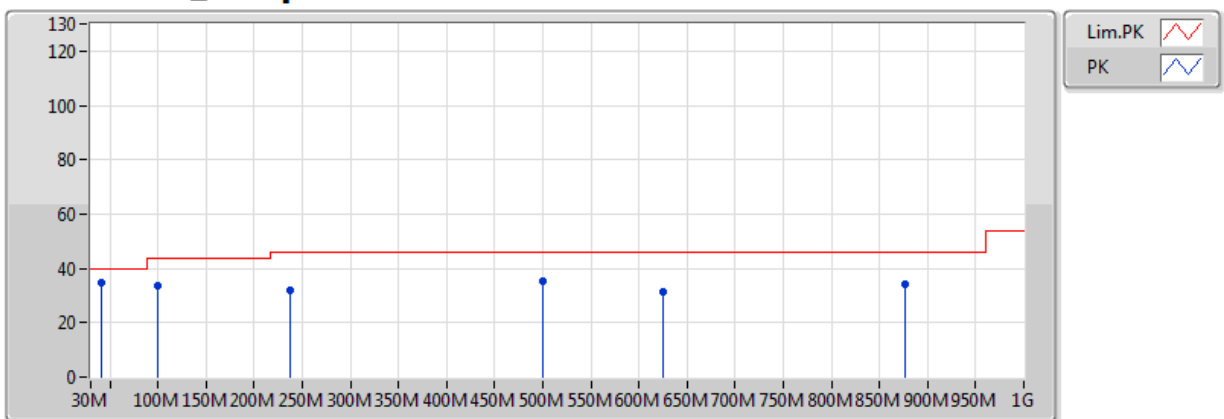

EUT = Z

Type	Freq (Hz)	Level (dBuV/m)	Limit (dBuV/m)	Margin (dB)	Factor (dB)	Dist (m)	Condition	Azimuth (°)	Height (m)	Comments
PK	41.64M	34.66	40.00	-5.34	-9.90	3	Horizontal	360	1.00	-
PK	99.84M	33.86	43.50	-9.64	-10.32	3	Horizontal	360	1.00	-
PK	237.58M	32.02	46.00	-13.98	-8.88	3	Horizontal	360	1.00	-
PK	499.48M	35.40	46.00	-10.60	-2.55	3	Horizontal	360	1.00	-
PK	625.58M	31.26	46.00	-14.74	-0.87	3	Horizontal	360	1.00	-
PK	875.84M	34.25	46.00	-11.75	2.78	3	Horizontal	360	1.00	-

Vertical

**802.11ac VHT80_Nss1,(MCS0)_4TX
5610MHz_Adapter**

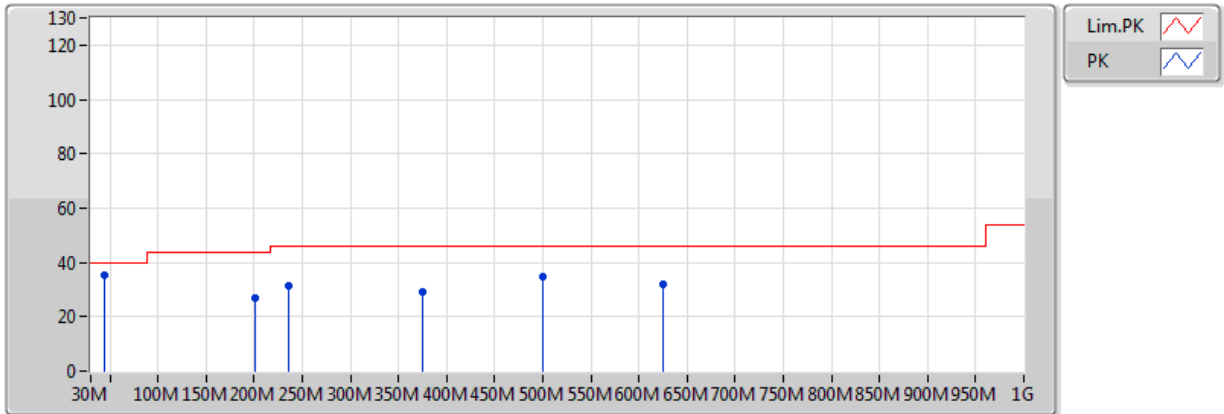

EUT = Z

Type	Freq (Hz)	Level (dBuV/m)	Limit (dBuV/m)	Margin (dB)	Factor (dB)	Dist (m)	Condition	Azimuth (°)	Height (m)	Comments
PK	43.58M	35.06	40.00	-4.94	-10.85	3	Vertical	0	1.00	-
PK	200.72M	26.91	43.50	-16.59	-10.77	3	Vertical	0	1.00	-
PK	235.64M	31.64	46.00	-14.36	-9.13	3	Vertical	0	1.00	-
PK	375.32M	28.96	46.00	-17.04	-5.07	3	Vertical	0	1.00	-
PK	499.48M	34.48	46.00	-11.52	-2.55	3	Vertical	0	1.00	-
PK	625.58M	31.73	46.00	-14.27	-0.87	3	Vertical	0	1.00	-

Note:

The amplitude of spurious emissions that are attenuated by more than 20dB below the permissible value has no need to be reported.

Emission level (dBuV/m) = 20 log Emission level (uV/m).

Horizontal

**802.11ac VHT80_Nss1,(MCS0)_4TX
5775MHz_Adapter**

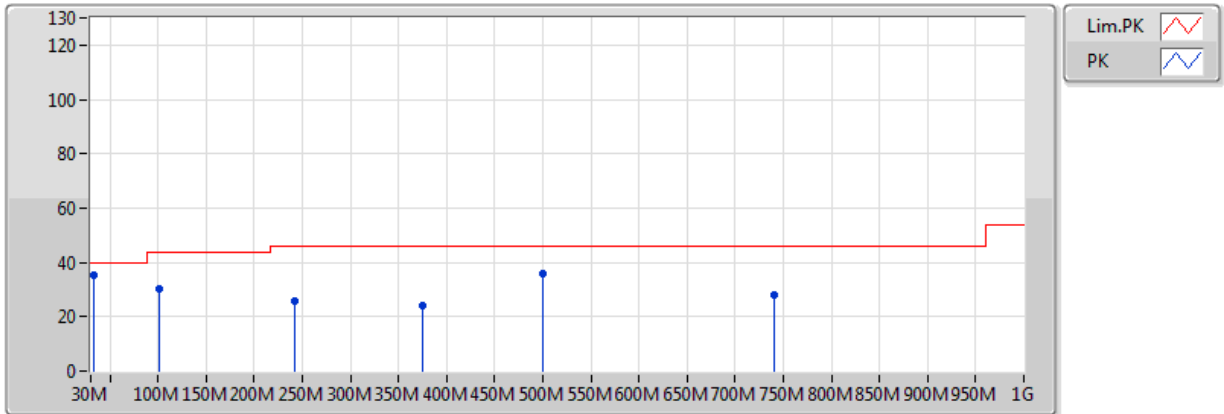

EUT = Z

Type	Freq (Hz)	Level (dBuV/m)	Limit (dBuV/m)	Margin (dB)	Factor (dB)	Dist (m)	Condition	Azimuth (°)	Height (m)	Comments
PK	33.88M	35.49	40.00	-4.51	-6.01	3	Horizontal	0	1.00	-
PK	101.78M	30.21	43.50	-13.29	-10.11	3	Horizontal	0	1.00	-
PK	241.46M	25.52	46.00	-20.48	-8.40	3	Horizontal	0	1.00	-
PK	375.32M	23.99	46.00	-22.01	-5.07	3	Horizontal	0	1.00	-
PK	499.48M	35.81	46.00	-10.19	-2.55	3	Horizontal	0	1.00	-
PK	740.04M	28.27	46.00	-17.73	0.94	3	Horizontal	0	1.00	-

Vertical

**802.11ac VHT80_Nss1,(MCS0)_4TX
5775MHz_Adapter**

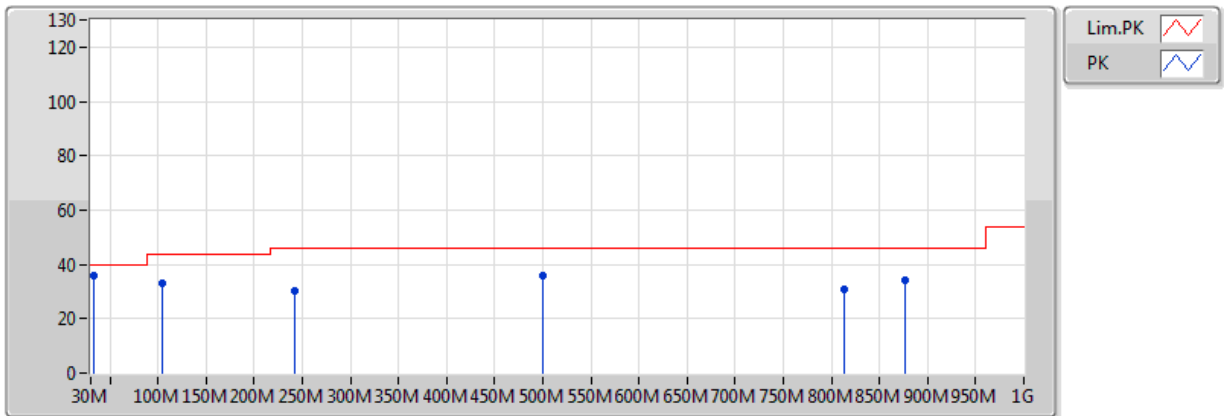

EUT = Z

Type	Freq (Hz)	Level (dBuV/m)	Limit (dBuV/m)	Margin (dB)	Factor (dB)	Dist (m)	Condition	Azimuth (°)	Height (m)	Comments
PK	103.72M	32.89	43.50	-10.61	-9.91	3	Vertical	360	1.00	-
PK	241.46M	30.23	46.00	-15.77	-8.40	3	Vertical	360	1.00	-
PK	499.48M	35.96	46.00	-10.04	-2.55	3	Vertical	360	1.00	-
PK	813.76M	31.02	46.00	-14.98	1.52	3	Vertical	360	1.00	-
PK	875.84M	33.91	46.00	-12.09	2.78	3	Vertical	360	1.00	-
QP	33.88M	35.93	40.00	-4.07	-6.01	3	Vertical	71	1.00	-

Note:

The amplitude of spurious emissions that are attenuated by more than 20dB below the permissible value has no need to be reported.

Emission level (dBuV/m) = 20 log Emission level (uV/m).

4.6.9. Corrected Reading: Antenna Factor + Cable Loss + Read Level - Preamp Factor = Level. Results for Radiated Emissions (1GHz~40GHz)

Temperature	25°C	Humidity	55%
Test Engineer	Stim Sung	Configurations	IEEE 802.11a CH 52 / Chain 1 + Chain 2 + Chain 3+ Chain 4
Test Date	Oct. 17, 2015		
Test Mode	Mode 1: PIFA Antenna / Chain1:5.84 dBi, Chain2:5.50 dBi, Chain3:5.84 dBi, Chain4:5.65 dBi		

Horizontal

	Freq	Level	Limit Line	Over Limit	Read Level	Cable Loss	Antenna Factor	Preamp Factor	Remark	A/Pos	T/Pos	Pol/Phase
	MHz	dBuV/m	dBuV/m	dB	dBuV	dB	dB/m	dB		cm	deg	
1	15779.17	43.78	54.00	-10.22	30.39	10.80	37.91	35.32	Average	178	94	HORIZONTAL
2	15781.51	56.00	74.00	-18.00	42.63	10.80	37.89	35.32	Peak	178	94	HORIZONTAL

Vertical

	Freq	Level	Limit Line	Over Limit	Read Level	Cable Loss	Antenna Factor	Preamp Factor	Remark	A/Pos	T/Pos	Pol/Phase
	MHz	dBuV/m	dBuV/m	dB	dBuV	dB	dB/m	dB		cm	deg	
1	15778.02	43.71	54.00	-10.29	30.32	10.80	37.91	35.32	Average	184	315	VERTICAL
2	15781.63	57.26	74.00	-16.74	43.89	10.80	37.89	35.32	Peak	184	315	VERTICAL



Temperature	25°C	Humidity	55%
Test Engineer	Stim Sung	Configurations	IEEE 802.11a CH 60 / Chain 1 + Chain 2 + Chain 3+ Chain 4
Test Date	Oct. 17, 2015		
Test Mode	Mode 1: PIFA Antenna / Chain1:5.84 dBi, Chain2:5.50 dBi, Chain3:5.84 dBi, Chain4:5.65 dBi		

Horizontal

	Freq	Level	Limit	Over	Read	CableAntenna	Preamp	Remark	A/Pos	T/Pos	Pol/Phase	
	MHz	dBuV/m	dBuV/m	dB	dBuV	dB	dB/m	dB	cm	deg		
1	10600.64	63.88	74.00	-10.12	51.62	8.64	38.58	34.96	Peak	223	309	HORIZONTAL
2	10600.96	49.25	54.00	-4.75	36.98	8.64	38.58	34.95	Average	223	309	HORIZONTAL
3	15899.15	44.04	54.00	-9.96	30.85	10.81	37.74	35.36	Average	189	337	HORIZONTAL
4	15900.09	56.49	74.00	-17.51	43.30	10.81	37.74	35.36	Peak	189	337	HORIZONTAL

Vertical

	Freq	Level	Limit	Over	Read	CableAntenna	Preamp	Remark	A/Pos	T/Pos	Pol/Phase	
	MHz	dBuV/m	dBuV/m	dB	dBuV	dB	dB/m	dB	cm	deg		
1	10600.66	59.78	74.00	-14.22	47.52	8.64	38.58	34.96	Peak	230	330	VERTICAL
2	10601.65	46.19	54.00	-7.81	33.92	8.64	38.58	34.95	Average	230	330	VERTICAL
3	15898.75	56.62	74.00	-17.38	43.43	10.81	37.74	35.36	Peak	182	291	VERTICAL
4	15899.25	43.91	54.00	-10.09	30.72	10.81	37.74	35.36	Average	182	291	VERTICAL



Temperature	25°C	Humidity	55%
Test Engineer	Stim Sung	Configurations	IEEE 802.11a CH 64 / Chain 1 + Chain 2 + Chain 3+ Chain 4
Test Date	Oct. 17, 2015		
Test Mode	Mode 1: PIFA Antenna / Chain1:5.84 dBi, Chain2:5.50 dBi, Chain3:5.84 dBi, Chain4:5.65 dBi		

Horizontal

	Freq	Level	Limit	Over	Read	CableAntenna	Preamp	Remark	A/Pos	T/Pos	Pol/Phase	
	MHz	dBuV/m	dBuV/m	dB	dBuV	dB	dB/m	dB	cm	deg		
1	10633.26	57.51	74.00	-16.49	45.22	8.66	38.57	34.94	Peak	156	284	HORIZONTAL
2	10633.83	44.16	54.00	-9.84	31.87	8.66	38.57	34.94	Average	156	284	HORIZONTAL
3	15724.83	55.50	74.00	-18.50	42.00	10.79	37.99	35.28	Peak	277	318	HORIZONTAL
4	15728.31	42.55	54.00	-11.45	29.06	10.79	37.99	35.29	Average	277	318	HORIZONTAL

Vertical

	Freq	Level	Limit	Over	Read	CableAntenna	Preamp	Remark	A/Pos	T/Pos	Pol/Phase	
	MHz	dBuV/m	dBuV/m	dB	dBuV	dB	dB/m	dB	cm	deg		
1	10481.91	39.95	54.00	-14.05	27.78	8.56	38.62	35.01	Average	211	143	VERTICAL
2	10482.95	52.29	74.00	-21.71	40.12	8.56	38.62	35.01	Peak	211	143	VERTICAL
3	15720.46	54.72	74.00	-19.28	41.22	10.79	37.99	35.28	Peak	164	270	VERTICAL
4	15722.84	42.50	54.00	-11.50	29.00	10.79	37.99	35.28	Average	164	270	VERTICAL

Temperature	25°C	Humidity	55%
Test Engineer	Stim Sung	Configurations	IEEE 802.11a CH 100 / Chain 1 + Chain 2 + Chain 3+ Chain 4
Test Date	Oct. 17, 2015		
Test Mode	Mode 1: PIFA Antenna / Chain1:5.84 dBi, Chain2:5.50 dBi, Chain3:5.84 dBi, Chain4:5.65 dBi		

Horizontal

	Freq	Level	Limit	Over	Read	CableAntenna	Preamp		A/Pos	T/Pos	Pol/Phase
	MHz	dBuV/m	dBuV/m	dB	dBuV	Loss	Factor	Factor	cm	deg	
1	10996.27	56.62	74.00	-17.38	43.98	8.93	38.50	34.79	158	283	HORIZONTAL
2	10997.51	43.74	54.00	-10.26	31.10	8.93	38.50	34.79	158	283	HORIZONTAL

Vertical

	Freq	Level	Limit	Over	Read	CableAntenna	Preamp		A/Pos	T/Pos	Pol/Phase
	MHz	dBuV/m	dBuV/m	dB	dBuV	Loss	Factor	Factor	cm	deg	
1	11002.52	52.54	74.00	-21.46	39.90	8.93	38.50	34.79	197	78	VERTICAL
2	11007.06	39.99	54.00	-14.01	27.32	8.94	38.52	34.79	197	78	VERTICAL

Temperature	25°C	Humidity	55%
Test Engineer	Stim Sung	Configurations	IEEE 802.11a CH 116 / Chain 1 + Chain 2 + Chain 3+ Chain 4
Test Date	Oct. 17, 2015		
Test Mode	Mode 1: PIFA Antenna / Chain1:5.84 dBi, Chain2:5.50 dBi, Chain3:5.84 dBi, Chain4:5.65 dBi		

Horizontal

	Freq	Level	Limit	Over	Read	CableAntenna	Preamp		A/Pos	T/Pos	Pol/Phase
	MHz	dBuV/m	dBuV/m	dB	dBuV	Loss	Factor	Factor	cm	deg	
1	11161.98	62.65	74.00	-11.35	49.70	9.04	38.70	34.79	239	277	HORIZONTAL
2	11162.03	48.11	54.00	-5.89	35.16	9.04	38.70	34.79	239	277	HORIZONTAL

Vertical

	Freq	Level	Limit	Over	Read	CableAntenna	Preamp		A/Pos	T/Pos	Pol/Phase
	MHz	dBuV/m	dBuV/m	dB	dBuV	Loss	Factor	Factor	cm	deg	
1	11157.50	59.24	74.00	-14.76	46.29	9.04	38.70	34.79	237	319	VERTICAL
2	11157.60	46.04	54.00	-7.96	33.09	9.04	38.70	34.79	237	319	VERTICAL

Temperature	25°C	Humidity	55%
Test Engineer	Stim Sung	Configurations	IEEE 802.11a CH 140 / Chain 1 + Chain 2 + Chain 3+ Chain 4
Test Date	Oct. 17, 2015		
Test Mode	Mode 1: PIFA Antenna / Chain1:5.84 dBi, Chain2:5.50 dBi, Chain3:5.84 dBi, Chain4:5.65 dBi		

Horizontal

	Freq	Level	Limit	Over	Read	CableAntenna	Preamp		A/Pos	T/Pos	Pol/Phase
	MHz	dBuV/m	dBuV/m	dB	dBuV	Loss	Factor	Factor	cm	deg	
1	11402.03	56.80	74.00	-17.20	43.43	9.19	38.98	34.80	234	339	HORIZONTAL
2	11402.37	43.77	54.00	-10.23	30.40	9.19	38.98	34.80	234	339	HORIZONTAL

Vertical

	Freq	Level	Limit	Over	Read	CableAntenna	Preamp		A/Pos	T/Pos	Pol/Phase
	MHz	dBuV/m	dBuV/m	dB	dBuV	Loss	Factor	Factor	cm	deg	
1	11400.75	54.95	74.00	-19.05	41.58	9.19	38.98	34.80	225	317	VERTICAL
2	11401.91	42.70	54.00	-11.30	29.33	9.19	38.98	34.80	225	317	VERTICAL

Temperature	25°C	Humidity	55%
Test Engineer	Stim Sung	Configurations	IEEE 802.11ac MCS0/Nss1 VHT20 CH 52 / Chain 1 + Chain 2 + Chain 3+ Chain 4
Test Date	Oct. 17, 2015		
Test Mode	Mode 1: PIFA Antenna / Chain1:5.84 dBi, Chain2:5.50 dBi, Chain3:5.84 dBi, Chain4:5.65 dBi		

Horizontal

	Freq	Level	Limit Line	Over Limit	Read Level	Cable Loss	Antenna Factor	Preamp Factor	Remark	A/Pos	T/Pos	Pol/Phase
	MHz	dBuV/m	dBuV/m	dB	dBuV	dB	dB/m	dB		cm	deg	
1	15778.81	43.66	54.00	-10.34	30.27	10.80	37.91	35.32	Average	164	102	HORIZONTAL
2	15780.02	56.78	74.00	-17.22	43.39	10.80	37.91	35.32	Peak	164	102	HORIZONTAL

Vertical

	Freq	Level	Limit Line	Over Limit	Read Level	Cable Loss	Antenna Factor	Preamp Factor	Remark	A/Pos	T/Pos	Pol/Phase
	MHz	dBuV/m	dBuV/m	dB	dBuV	dB	dB/m	dB		cm	deg	
1	15778.30	56.60	74.00	-17.40	43.21	10.80	37.91	35.32	Peak	185	314	VERTICAL
2	15780.25	43.45	54.00	-10.55	30.06	10.80	37.91	35.32	Average	185	314	VERTICAL



Temperature	25°C	Humidity	55%
Test Engineer	Stim Sung	Configurations	IEEE 802.11ac MCS0/Nss1 VHT20 CH 60 / Chain 1 + Chain 2 + Chain 3+ Chain 4
Test Date	Oct. 17, 2015		
Test Mode	Mode 1: PIFA Antenna / Chain1:5.84 dBi, Chain2:5.50 dBi, Chain3:5.84 dBi, Chain4:5.65 dBi		

Horizontal

	Freq	Level	Limit Line	Over Limit	Read Level	CableAntenna Loss	Antenna Factor	Preamp Factor	Remark	A/Pos	T/Pos	Pol/Phase
	MHz	dBuV/m	dBuV/m	dB	dBuV	dB	dB/m	dB		cm	deg	
1	10599.10	62.84	74.00	-11.16	50.58	8.64	38.58	34.96	Peak	225	307	HORIZONTAL
2	10599.46	47.91	54.00	-6.09	35.65	8.64	38.58	34.96	Average	225	307	HORIZONTAL
3	15898.26	43.71	54.00	-10.29	30.52	10.81	37.74	35.36	Average	186	114	HORIZONTAL
4	15900.38	57.50	74.00	-16.50	44.31	10.81	37.74	35.36	Peak	186	114	HORIZONTAL

Vertical

	Freq	Level	Limit Line	Over Limit	Read Level	CableAntenna Loss	Antenna Factor	Preamp Factor	Remark	A/Pos	T/Pos	Pol/Phase
	MHz	dBuV/m	dBuV/m	dB	dBuV	dB	dB/m	dB		cm	deg	
1	10600.16	45.09	54.00	-8.91	32.83	8.64	38.58	34.96	Average	220	330	VERTICAL
2	10600.42	58.16	74.00	-15.84	45.90	8.64	38.58	34.96	Peak	220	330	VERTICAL
3	15899.28	56.14	74.00	-17.86	42.95	10.81	37.74	35.36	Peak	186	322	VERTICAL
4	15901.24	43.78	54.00	-10.22	30.61	10.81	37.72	35.36	Average	186	322	VERTICAL

Temperature	25°C	Humidity	55%
Test Engineer	Stim Sung	Configurations	IEEE 802.11ac MCS0/Nss1 VHT20 CH 64 / Chain 1 + Chain 2 + Chain 3+ Chain 4
Test Date	Oct. 17, 2015		
Test Mode	Mode 1: PIFA Antenna / Chain1:5.84 dBi, Chain2:5.50 dBi, Chain3:5.84 dBi, Chain4:5.65 dBi		

Horizontal

	Freq	Level	Limit	Over	Read	CableAntenna	Preamp	Remark	A/Pos	T/Pos	Pol/Phase
	MHz	dBuV/m	dBuV/m	dB	dBuV	dB	dB/m	dB	cm	deg	
1	10638.46	57.25	74.00	-16.75	44.96	8.66	38.57	34.94	Peak	222	278 HORIZONTAL
2	10638.67	43.76	54.00	-10.24	31.47	8.66	38.57	34.94	Average	222	278 HORIZONTAL
3	15959.89	56.09	74.00	-17.91	43.02	10.82	37.65	35.40	Peak	170	96 HORIZONTAL
4	15961.62	43.08	54.00	-10.92	30.01	10.82	37.65	35.40	Average	170	96 HORIZONTAL

Vertical

	Freq	Level	Limit	Over	Read	CableAntenna	Preamp	Remark	A/Pos	T/Pos	Pol/Phase
	MHz	dBuV/m	dBuV/m	dB	dBuV	dB	dB/m	dB	cm	deg	
1	10637.54	42.27	54.00	-11.73	29.98	8.66	38.57	34.94	Average	226	343 VERTICAL
2	10638.47	54.61	74.00	-19.39	42.32	8.66	38.57	34.94	Peak	226	343 VERTICAL
3	15958.23	43.12	54.00	-10.88	30.05	10.82	37.65	35.40	Average	176	307 VERTICAL
4	15958.73	56.91	74.00	-17.09	43.84	10.82	37.65	35.40	Peak	176	307 VERTICAL

Temperature	25°C	Humidity	55%
Test Engineer	Stim Sung	Configurations	IEEE 802.11ac MCS0/Nss1 VHT20 CH 100 / Chain 1 + Chain 2 + Chain 3+ Chain 4
Test Date	Oct. 17, 2015		
Test Mode	Mode 1: PIFA Antenna / Chain1:5.84 dBi, Chain2:5.50 dBi, Chain3:5.84 dBi, Chain4:5.65 dBi		

Horizontal

	Freq	Level	Limit	Over	Read	CableAntenna	Preamp		A/Pos	T/Pos	Pol/Phase
	MHz	dBuV/m	dBuV/m	dB	dBuV	Loss	Factor	Factor	cm	deg	
1	10998.31	59.52	74.00	-14.48	46.88	8.93	38.50	34.79	218	310	HORIZONTAL
2	10998.73	44.64	54.00	-9.36	32.00	8.93	38.50	34.79	218	310	HORIZONTAL

Vertical

	Freq	Level	Limit	Over	Read	CableAntenna	Preamp		A/Pos	T/Pos	Pol/Phase
	MHz	dBuV/m	dBuV/m	dB	dBuV	Loss	Factor	Factor	cm	deg	
1	10997.58	41.80	54.00	-12.20	29.16	8.93	38.50	34.79	222	347	VERTICAL
2	10997.60	54.99	74.00	-19.01	42.35	8.93	38.50	34.79	222	347	VERTICAL

Temperature	25°C	Humidity	55%
Test Engineer	Stim Sung	Configurations	IEEE 802.11ac MCS0/Nss1 VHT20 CH 116 / Chain 1 + Chain 2 + Chain 3+ Chain 4
Test Date	Oct. 17, 2015		
Test Mode	Mode 1: PIFA Antenna / Chain1:5.84 dBi, Chain2:5.50 dBi, Chain3:5.84 dBi, Chain4:5.65 dBi		

Horizontal

	Freq	Level	Limit	Over	Read	CableAntenna	Preamp		A/Pos	T/Pos	Pol/Phase
	MHz	dBuV/m	dBuV/m	dB	dBuV	dB	dB/m	dB	cm	deg	
1	11157.51	61.63	74.00	-12.37	48.68	9.04	38.70	34.79	211	288	HORIZONTAL
2	11158.22	48.16	54.00	-5.84	35.21	9.04	38.70	34.79	211	288	HORIZONTAL

Vertical

	Freq	Level	Limit	Over	Read	CableAntenna	Preamp		A/Pos	T/Pos	Pol/Phase
	MHz	dBuV/m	dBuV/m	dB	dBuV	dB	dB/m	dB	cm	deg	
1	11161.64	57.77	74.00	-16.23	44.82	9.04	38.70	34.79	199	334	VERTICAL
2	11162.42	44.04	54.00	-9.96	31.09	9.04	38.70	34.79	199	334	VERTICAL

Temperature	25°C	Humidity	55%
Test Engineer	Stim Sung	Configurations	IEEE 802.11ac MCS0/Nss1 VHT20 CH 140 / Chain 1 + Chain 2 + Chain 3+ Chain 4
Test Date	Oct. 17, 2015		
Test Mode	Mode 1: PIFA Antenna / Chain1:5.84 dBi, Chain2:5.50 dBi, Chain3:5.84 dBi, Chain4:5.65 dBi		

Horizontal

	Freq	Level	Limit	Over	Read	CableAntenna	Preamp	Remark	A/Pos	T/Pos	Pol/Phase
	MHz	dBuV/m	dBuV/m	dB	dBuV	dB	dB/m	dB	cm	deg	
1	11398.21	57.35	74.00	-16.65	43.98	9.19	38.98	34.80	Peak	227	308 HORIZONTAL
2	11398.52	43.56	54.00	-10.44	30.19	9.19	38.98	34.80	Average	227	308 HORIZONTAL

Vertical

	Freq	Level	Limit	Over	Read	CableAntenna	Preamp	Remark	A/Pos	T/Pos	Pol/Phase
	MHz	dBuV/m	dBuV/m	dB	dBuV	dB	dB/m	dB	cm	deg	
1	11401.69	41.99	54.00	-12.01	28.62	9.19	38.98	34.80	Average	220	314 VERTICAL
2	11401.92	54.42	74.00	-19.58	41.05	9.19	38.98	34.80	Peak	220	314 VERTICAL



Temperature	25°C	Humidity	55%
Test Engineer	Stim Sung	Configurations	IEEE 802.11ac MCS0/Nss1 VHT40 CH 54 / Chain 1 + Chain 2 + Chain 3+ Chain 4
Test Date	Oct. 17, 2015		
Test Mode	Mode 1: PIFA Antenna / Chain1:5.84 dBi, Chain2:5.50 dBi, Chain3:5.84 dBi, Chain4:5.65 dBi		

Horizontal

	Freq	Level	Limit Line	Over Limit	Read Level	CableAntenna Loss	Antenna Factor	Preamp Factor	Remark	A/Pos	T/Pos	Pol/Phase
	MHz	dBuV/m	dBuV/m	dB	dBuV	dB	dB/m	dB		cm	deg	
1	15807.63	56.79	74.00	-17.21	43.45	10.80	37.87	35.33	Peak	175	90	HORIZONTAL
2	15807.84	43.48	54.00	-10.52	30.14	10.80	37.87	35.33	Average	175	90	HORIZONTAL

Vertical

	Freq	Level	Limit Line	Over Limit	Read Level	CableAntenna Loss	Antenna Factor	Preamp Factor	Remark	A/Pos	T/Pos	Pol/Phase
	MHz	dBuV/m	dBuV/m	dB	dBuV	dB	dB/m	dB		cm	deg	
1	15812.31	43.55	54.00	-10.45	30.21	10.80	37.87	35.33	Average	185	327	VERTICAL
2	15812.43	56.35	74.00	-17.65	43.01	10.80	37.87	35.33	Peak	185	327	VERTICAL



Temperature	25°C	Humidity	55%
Test Engineer	Stim Sung	Configurations	IEEE 802.11ac MCS0/Nss1 VHT40 CH 62 / Chain 1 + Chain 2 + Chain 3+ Chain 4
Test Date	Oct. 17, 2015		
Test Mode	Mode 1: PIFA Antenna / Chain1:5.84 dBi, Chain2:5.50 dBi, Chain3:5.84 dBi, Chain4:5.65 dBi		

Horizontal

	Freq	Level	Limit Line	Over Limit	Read Level	CableAntenna Loss	Antenna Factor	Preamp Factor	Remark	A/Pos	T/Pos	Pol/Phase
	MHz	dBuV/m	dBuV/m	dB	dBuV	dB	dB/m	dB		cm	deg	
1	10619.60	53.54	74.00	-20.46	41.26	8.65	38.58	34.95	Peak	230	292	HORIZONTAL
2	10620.16	40.75	54.00	-13.25	28.47	8.65	38.58	34.95	Average	230	292	HORIZONTAL
3	15931.01	43.29	54.00	-10.71	30.17	10.81	37.70	35.39	Average	183	109	HORIZONTAL
4	15932.47	55.90	74.00	-18.10	42.78	10.81	37.70	35.39	Peak	183	109	HORIZONTAL

Vertical

	Freq	Level	Limit Line	Over Limit	Read Level	CableAntenna Loss	Antenna Factor	Preamp Factor	Remark	A/Pos	T/Pos	Pol/Phase
	MHz	dBuV/m	dBuV/m	dB	dBuV	dB	dB/m	dB		cm	deg	
1	10618.11	40.65	54.00	-13.35	28.37	8.65	38.58	34.95	Average	230	321	VERTICAL
2	10622.47	52.90	74.00	-21.10	40.62	8.65	38.58	34.95	Peak	230	321	VERTICAL
3	15927.73	43.18	54.00	-10.82	30.05	10.81	37.70	35.38	Average	191	308	VERTICAL
4	15931.62	55.73	74.00	-18.27	42.61	10.81	37.70	35.39	Peak	191	308	VERTICAL

Temperature	25°C	Humidity	55%
Test Engineer	Stim Sung	Configurations	IEEE 802.11ac MCS0/Nss1 VHT40 CH 102 / Chain 1 + Chain 2 + Chain 3+ Chain 4
Test Date	Oct. 17, 2015		
Test Mode	Mode 1: PIFA Antenna / Chain1:5.84 dBi, Chain2:5.50 dBi, Chain3:5.84 dBi, Chain4:5.65 dBi		

Horizontal

	Freq	Level	Limit	Over	Read	CableAntenna	Preamp		A/Pos	T/Pos	
	MHz	dBuV/m	dBuV/m	dB	dBuV	dB	dB/m	dB	cm	deg	Pol/Phase
1	11019.00	41.08	54.00	-12.92	28.41	8.94	38.52	34.79	226	308	HORIZONTAL
2	11020.26	54.59	74.00	-19.41	41.92	8.94	38.52	34.79	226	308	HORIZONTAL

Vertical

	Freq	Level	Limit	Over	Read	CableAntenna	Preamp		A/Pos	T/Pos	
	MHz	dBuV/m	dBuV/m	dB	dBuV	dB	dB/m	dB	cm	deg	Pol/Phase
1	11018.46	40.63	54.00	-13.37	27.96	8.94	38.52	34.79	246	340	VERTICAL
2	11018.50	53.69	74.00	-20.31	41.02	8.94	38.52	34.79	246	340	VERTICAL

Temperature	25°C	Humidity	55%
Test Engineer	Stim Sung	Configurations	IEEE 802.11ac MCS0/Nss1 VHT40 CH 110 / Chain 1 + Chain 2 + Chain 3+ Chain 4
Test Date	Oct. 17, 2015		
Test Mode	Mode 1: PIFA Antenna / Chain1:5.84 dBi, Chain2:5.50 dBi, Chain3:5.84 dBi, Chain4:5.65 dBi		

Horizontal

	Freq	Level	Limit Line	Over Limit	Read Level	Cable Loss	Antenna Factor	Preamp Factor	Remark	A/Pos	T/Pos	Pol/Phase
	MHz	dBuV/m	dBuV/m	dB	dBuV	dB	dB/m	dB		cm	deg	
1	11099.05	45.59	54.00	-8.41	32.77	8.99	38.62	34.79	Average	216	312	HORIZONTAL
2	11099.15	57.82	74.00	-16.18	45.00	8.99	38.62	34.79	Peak	216	312	HORIZONTAL

Vertical

	Freq	Level	Limit Line	Over Limit	Read Level	Cable Loss	Antenna Factor	Preamp Factor	Remark	A/Pos	T/Pos	Pol/Phase
	MHz	dBuV/m	dBuV/m	dB	dBuV	dB	dB/m	dB		cm	deg	
1	11098.42	54.76	74.00	-19.24	41.94	8.99	38.62	34.79	Peak	215	325	VERTICAL
2	11099.93	42.50	54.00	-11.50	29.68	8.99	38.62	34.79	Average	215	325	VERTICAL



Temperature	25°C	Humidity	55%
Test Engineer	Stim Sung	Configurations	IEEE 802.11ac MCS0/Nss1 VHT40 CH 134 / Chain 1 + Chain 2 + Chain 3+ Chain 4
Test Date	Oct. 17, 2015		
Test Mode	Mode 1: PIFA Antenna / Chain1:5.84 dBi, Chain2:5.50 dBi, Chain3:5.84 dBi, Chain4:5.65 dBi		

Horizontal

	Freq	Level	Limit Line	Over Limit	Read Level	CableAntenna Loss	Antenna Factor	Preamp Factor	Remark	A/Pos	T/Pos	Pol/Phase
	MHz	dBuV/m	dBuV/m	dB	dBuV	dB	dB/m	dB		cm	deg	
1	11339.76	43.54	54.00	-10.46	30.30	9.14	38.90	34.80	Average	214	288	HORIZONTAL
2	11341.71	56.28	74.00	-17.72	43.04	9.14	38.90	34.80	Peak	214	288	HORIZONTAL

Vertical

	Freq	Level	Limit Line	Over Limit	Read Level	CableAntenna Loss	Antenna Factor	Preamp Factor	Remark	A/Pos	T/Pos	Pol/Phase
	MHz	dBuV/m	dBuV/m	dB	dBuV	dB	dB/m	dB		cm	deg	
1	11338.35	54.51	74.00	-19.49	41.27	9.14	38.90	34.80	Peak	220	319	VERTICAL
2	11339.28	41.66	54.00	-12.34	28.42	9.14	38.90	34.80	Average	220	319	VERTICAL

Temperature	25°C	Humidity	55%
Test Engineer	Stim Sung	Configurations	IEEE 802.11ac MCS0/Nss1 VHT80 CH 58 / Chain 1 + Chain 2 + Chain 3+ Chain 4
Test Date	Oct. 17, 2015		
Test Mode	Mode 1: PIFA Antenna / Chain1:5.84 dBi, Chain2:5.50 dBi, Chain3:5.84 dBi, Chain4:5.65 dBi		

Horizontal

	Freq	Level	Limit	Over	Read	CableAntenna	Preamp	Remark	A/Pos	T/Pos	Pol/Phase
	MHz	dBuV/m	dBuV/m	dB	dBuV	dB	dB/m	dB	cm	deg	
1	15871.93	56.61	74.00	-17.39	43.38	10.81	37.77	35.35	Peak	179	126 HORIZONTAL
2	15872.24	43.73	54.00	-10.27	30.50	10.81	37.77	35.35	Average	179	126 HORIZONTAL

Vertical

	Freq	Level	Limit	Over	Read	CableAntenna	Preamp	Remark	A/Pos	T/Pos	Pol/Phase
	MHz	dBuV/m	dBuV/m	dB	dBuV	dB	dB/m	dB	cm	deg	
1	15867.97	57.44	74.00	-16.56	44.21	10.81	37.77	35.35	Peak	194	314 VERTICAL
2	15868.04	43.71	54.00	-10.29	30.48	10.81	37.77	35.35	Average	194	314 VERTICAL



Temperature	25°C	Humidity	55%
Test Engineer	Stim Sung	Configurations	IEEE 802.11ac MCS0/Nss1 VHT80 CH 106 / Chain 1 + Chain 2 + Chain 3+ Chain 4
Test Date	Oct. 17, 2015		
Test Mode	Mode 1: PIFA Antenna / Chain1:5.84 dBi, Chain2:5.50 dBi, Chain3:5.84 dBi, Chain4:5.65 dBi		

Horizontal

	Freq	Level	Limit Line	Over Limit	Read Level	Cable Loss	Antenna Factor	Preamp Factor	Remark	A/Pos	T/Pos	Pol/Phase
	MHz	dBuV/m	dBuV/m	dB	dBuV	dB	dB/m	dB		cm	deg	
1	11059.91	40.38	54.00	-13.62	27.62	8.97	38.58	34.79	Average	232	315	HORIZONTAL
2	11062.29	53.92	74.00	-20.08	41.16	8.97	38.58	34.79	Peak	232	315	HORIZONTAL

Vertical

	Freq	Level	Limit Line	Over Limit	Read Level	Cable Loss	Antenna Factor	Preamp Factor	Remark	A/Pos	T/Pos	Pol/Phase
	MHz	dBuV/m	dBuV/m	dB	dBuV	dB	dB/m	dB		cm	deg	
1	11058.89	53.08	74.00	-20.92	40.32	8.97	38.58	34.79	Peak	226	305	VERTICAL
2	11061.07	40.45	54.00	-13.55	27.69	8.97	38.58	34.79	Average	226	305	VERTICAL

Temperature	25°C	Humidity	55%
Test Engineer	Stim Sung	Configurations	IEEE 802.11ac MCS0/Nss1 VHT80 CH 122 / Chain 1 + Chain 2 + Chain 3+ Chain 4
Test Date	Oct. 17, 2015		
Test Mode	Mode 1: PIFA Antenna / Chain1:5.84 dBi, Chain2:5.50 dBi, Chain3:5.84 dBi, Chain4:5.65 dBi		

Horizontal

	Freq	Level	Limit	Over	Read	CableAntenna	Preamp	Remark	A/Pos	T/Pos	Pol/Phase
	MHz	dBuV/m	dBuV/m	dB	dBuV	dB	dB/m	dB	cm	deg	
1	11218.76	54.38	74.00	-19.62	41.34	9.07	38.76	34.79	Peak	225	305 HORIZONTAL
2	11220.00	41.35	54.00	-12.65	28.31	9.07	38.76	34.79	Average	225	305 HORIZONTAL

Vertical

	Freq	Level	Limit	Over	Read	CableAntenna	Preamp	Remark	A/Pos	T/Pos	Pol/Phase
	MHz	dBuV/m	dBuV/m	dB	dBuV	dB	dB/m	dB	cm	deg	
1	11220.18	53.85	74.00	-20.15	40.81	9.07	38.76	34.79	Peak	237	310 VERTICAL
2	11222.37	41.09	54.00	-12.91	28.05	9.07	38.76	34.79	Average	237	310 VERTICAL

Note:

The amplitude of spurious emissions that are attenuated by more than 20dB below the permissible value has no need to be reported.

Emission level (dBuV/m) = 20 log Emission level (uV/m).

Corrected Reading: Antenna Factor + Cable Loss + Read Level - Preamp Factor = Level.



Straddle Channel

Temperature	25°C	Humidity	55%
Test Engineer	Stim Sung	Configurations	IEEE 802.11a CH 144 / Chain 1 + Chain 2 + Chain 3+ Chain 4
Test Date	Oct. 20, 2015		
Test Mode	Mode 1: PIFA Antenna / Chain1:5.84 dBi, Chain2:5.50 dBi, Chain3:5.84 dBi, Chain4:5.65 dBi		

Horizontal

	Freq	Level	Limit	Over	Read	Cable	Preamp	Antenna		A/Pos	T/Pos	Remark
	MHz	dBuV/m	dBuV/m	dB	dBuV	dB	dB	dB/m	Pol/Phase	cm	deg	
1	11418.00	44.44	54.00	-9.56	28.73	10.99	35.22	39.94	HORIZONTAL	224	246	Average
2	11418.00	54.68	74.00	-19.32	38.97	10.99	35.22	39.94	HORIZONTAL	224	246	Peak

Vertical

	Freq	Level	Limit	Over	Read	Cable	Preamp	Antenna		A/Pos	T/Pos	Remark
	MHz	dBuV/m	dBuV/m	dB	dBuV	dB	dB	dB/m	Pol/Phase	cm	deg	
1	11411.48	44.45	54.00	-9.55	28.72	10.99	35.22	39.96	VERTICAL	168	321	Average
2	11411.52	58.13	74.00	-15.87	42.40	10.99	35.22	39.96	VERTICAL	168	321	Peak

Temperature	25°C	Humidity	55%
Test Engineer	Stim Sung	Configuration	IEEE 802.11ac MCS0/Nss1 VHT20 CH 144 / Chain 1 + Chain 2 + Chain 3+ Chain 4
Test Date	Oct. 20, 2015		
Test Mode	Mode 1: PIFA Antenna / Chain1:5.84 dBi, Chain2:5.50 dBi, Chain3:5.84 dBi, Chain4:5.65 dBi		

Horizontal

	Freq	Level	Limit	Over	Read	Cable	Preamp	Antenna		A/Pos	T/Pos	Remark
	MHz	dBuV/m	dBuV/m	dB	dBuV	dB	dB	dB/m	Pol/Phase	cm	deg	
1	11411.92	44.65	54.00	-9.35	28.92	10.99	35.22	39.96	HORIZONTAL	199	171	Average
2	11416.72	57.63	74.00	-16.37	41.90	10.99	35.22	39.96	HORIZONTAL	199	171	Peak

Vertical

	Freq	Level	Limit	Over	Read	Cable	Preamp	Antenna		A/Pos	T/Pos	Remark
	MHz	dBuV/m	dBuV/m	dB	dBuV	dB	dB	dB/m	Pol/Phase	cm	deg	
1	11401.96	44.46	54.00	-9.54	28.74	10.98	35.22	39.96	VERTICAL	155	7	Average
2	11415.40	57.41	74.00	-16.59	41.68	10.99	35.22	39.96	VERTICAL	155	7	Peak

Temperature	25°C	Humidity	55%
Test Engineer	Stim Sung	Configurations	IEEE 802.11ac MCS0/Nss1 VHT40 CH 142 / Chain 1 + Chain 2 + Chain 3+ Chain 4
Test Date	Oct. 20, 2015		
Test Mode	Mode 1: PIFA Antenna / Chain1:5.84 dBi, Chain2:5.50 dBi, Chain3:5.84 dBi, Chain4:5.65 dBi		

Horizontal

	Freq	Level	Limit Line	Over Limit	Read Level	Cable Loss	Preamp Factor	Antenna Factor	Pol/Phase	A/Pos	T/Pos	Remark
	MHz	dBuV/m	dBuV/m	dB	dBuV	dB	dB	dB/m		cm	deg	
1	11417.52	44.31	54.00	-9.69	28.60	10.99	35.22	39.94	HORIZONTAL	180	216	Average
2	11426.12	56.78	74.00	-17.22	41.06	11.00	35.22	39.94	HORIZONTAL	180	216	Peak

Vertical

	Freq	Level	Limit Line	Over Limit	Read Level	Cable Loss	Preamp Factor	Antenna Factor	Pol/Phase	A/Pos	T/Pos	Remark
	MHz	dBuV/m	dBuV/m	dB	dBuV	dB	dB	dB/m		cm	deg	
1	11414.24	44.47	54.00	-9.53	28.74	10.99	35.22	39.96	VERTICAL	147	360	Average
2	11414.24	54.64	74.00	-19.36	38.91	10.99	35.22	39.96	VERTICAL	147	360	Peak

Temperature	25°C	Humidity	55%
Test Engineer	Stim Sung	Configurations	IEEE 802.11ac MCS0/Nss1 VHT80 CH 138 / Chain 1 + Chain 2 + Chain 3+ Chain 4
Test Date	Oct. 20, 2015 ~ Oct. 21, 2015		
Test Mode	Mode 1: PIFA Antenna / Chain1:5.84 dBi, Chain2:5.50 dBi, Chain3:5.84 dBi, Chain4:5.65 dBi		

Horizontal

	Freq	Level	Limit Line	Over Limit	Read Level	Cable Loss	Preamp Factor	Antenna Factor	Pol/Phase	A/Pos	T/Pos	Remark
	MHz	dBuV/m	dBuV/m	dB	dBuV	dB	dB	dB/m		cm	deg	
1	11378.88	45.15	54.00	-8.85	29.42	10.97	35.22	39.98	HORIZONTAL	171	257	Average
2	11386.12	58.86	74.00	-15.14	43.15	10.97	35.22	39.96	HORIZONTAL	171	257	Peak

Vertical

	Freq	Level	Limit Line	Over Limit	Read Level	Cable Loss	Preamp Factor	Antenna Factor	Pol/Phase	A/Pos	T/Pos	Remark
	MHz	dBuV/m	dBuV/m	dB	dBuV	dB	dB	dB/m		cm	deg	
1	11370.56	45.41	54.00	-8.59	29.69	10.96	35.22	39.98	VERTICAL	150	209	Average
2	11373.56	58.48	74.00	-15.52	42.75	10.97	35.22	39.98	VERTICAL	150	209	Peak

Note:

The amplitude of spurious emissions that are attenuated by more than 20dB below the permissible value has no need to be reported.

Emission level (dBuV/m) = 20 log Emission level (uV/m).

Corrected Reading: Antenna Factor + Cable Loss + Read Level - Preamp Factor = Level.

4.7. Band Edge Emissions Measurement

4.7.1. Limit

For transmitters operating in the 5.25-5.35 GHz band: all emissions outside of the 5.15-5.35 GHz band shall not exceed an e.i.r.p. of -27 dBm/MHz.

For transmitters operating in the 5.470-5.725 GHz band: all emissions outside of the 5.47-5.725 GHz band shall not exceed an e.i.r.p. of -27 dBm/MHz.

In addition, In case the emission fall within the restricted band specified on 15.205(a), then the 15.209(a) limit in the table below has to be followed.

Frequencies (MHz)	Field Strength (micorvolts/meter)	Measurement Distance (meters)
0.009~0.490	2400/F(kHz)	300
0.490~1.705	24000/F(kHz)	30
1.705~30.0	30	30
30~88	100	3
88~216	150	3
216~960	200	3
Above 960	500	3

4.7.2. Measuring Instruments and Setting

Please refer to section 5 of equipments list in this report. The following table is the setting of the spectrum analyzer.

Spectrum Parameter	Setting
Attenuation	Auto
Span Frequency	100 MHz
RBW / VBW (Emission in restricted band)	1MHz / 3MHz for Peak, 1MHz / 1/T for Average
RBW / VBW (Emission in non-restricted band)	1MHz / 3MHz for Peak

4.7.3. Test Procedures

1. The test procedure is the same as section 4.6.3.

4.7.4. Test Setup Layout

This test setup layout is the same as that shown in section 4.6.4.

4.7.5. Test Deviation

There is no deviation with the original standard.

4.7.6. EUT Operation during Test

The EUT was programmed to be in continuously transmitting mode.

4.7.7. Test Result of Band Edge and Fundamental Emissions

Temperature	25°C	Humidity	55%
Test Engineer	Stim Sung	Configurations	IEEE 802.11a CH 52, 60, 64 / Chain 1 + Chain 2 + Chain 3+ Chain 4
Test Date	Oct. 16, 2015 ~ Oct. 17, 2015		
Test Mode	Mode 1: PIFA Antenna / Chain1:5.84 dBi, Chain2:5.50 dBi, Chain3:5.84 dBi, Chain4:5.65 dBi		

Channel 52

	Freq	Level	Limit Line	Over Limit	Read Level	CableAntenna Loss	Antenna Factor	Preamp Factor	Remark	A/Pos	T/Pos	Pol/Phase
	MHz	dBuV/m	dBuV/m	dB	dBuV	dB	dB/m	dB		cm	deg	
1	5145.22	58.59	74.00	-15.41	53.42	6.13	34.04	35.00	Peak	300	303	HORIZONTAL
2	5150.00	45.80	54.00	-8.20	40.63	6.13	34.04	35.00	Average	300	303	HORIZONTAL
3	5265.21	110.43			104.99	6.21	34.23	35.00	Average	300	303	HORIZONTAL
4	5265.21	120.68			115.24	6.21	34.23	35.00	Peak	300	303	HORIZONTAL
5	5350.00	46.72	54.00	-7.28	41.10	6.26	34.36	35.00	Average	300	303	HORIZONTAL
6	5351.74	57.75	74.00	-16.25	52.13	6.26	34.36	35.00	Peak	300	303	HORIZONTAL

Item 3, 4 are the fundamental frequency at 5260 MHz.

Channel 60

	Freq	Level	Limit Line	Over Limit	Read Level	CableAntenna Loss	Antenna Factor	Preamp Factor	Remark	A/Pos	T/Pos	Pol/Phase
	MHz	dBuV/m	dBuV/m	dB	dBuV	dB	dB/m	dB		cm	deg	
1	5304.92	121.24			115.73	6.23	34.28	35.00	Peak	300	308	HORIZONTAL
2	5305.21	110.75			105.24	6.23	34.28	35.00	Average	300	308	HORIZONTAL
3	5352.03	51.46	54.00	-2.54	45.84	6.26	34.36	35.00	Average	300	308	HORIZONTAL
4	5352.03	67.83	74.00	-6.17	62.21	6.26	34.36	35.00	Peak	300	308	HORIZONTAL

Item 1, 2 are the fundamental frequency at 5300 MHz.

Channel 64

	Freq	Level	Limit Line	Over Limit	Read Level	CableAntenna Loss	Antenna Factor	Preamp Factor	Remark	A/Pos	T/Pos	Pol/Phase
	MHz	dBuV/m	dBuV/m	dB	dBuV	dB	dB/m	dB		cm	deg	
1	5322.75	106.29			100.74	6.24	34.31	35.00	Average	296	307	HORIZONTAL
2	5322.75	116.83			111.28	6.24	34.31	35.00	Peak	296	307	HORIZONTAL
3	5350.00	48.33	54.00	-5.67	42.71	6.26	34.36	35.00	Average	296	307	HORIZONTAL
4	5350.29	60.24	74.00	-13.76	54.62	6.26	34.36	35.00	Peak	296	307	HORIZONTAL

Item 1, 2 are the fundamental frequency at 5320 MHz.

Temperature	25°C	Humidity	55%
Test Engineer	Stim Sung	Configurations	IEEE 802.11a CH 100, 116, 140 / Chain 1 + Chain 2 + Chain 3+ Chain 4
Test Date	Oct. 17, 2015		
Test Mode	Mode 1: PIFA Antenna / Chain1:5.84 dBi, Chain2:5.50 dBi, Chain3:5.84 dBi, Chain4:5.65 dBi		

Channel 100

	Freq	Level	Limit	Over	Read	CableAntenna	Preamp	Remark	A/Pos	T/Pos	Pol/Phase	
	MHz	dBuV/m	dBuV/m	dB	dBuV	dB	dB/m	dB	cm	deg		
1	5456.24	60.14	74.00	-13.86	54.28	6.33	34.52	34.99	Peak	282	300	HORIZONTAL
2	5456.70	47.45	54.00	-6.55	41.59	6.33	34.52	34.99	Average	282	300	HORIZONTAL
3	5465.08	49.35	54.00	-4.65	43.45	6.34	34.55	34.99	Average	282	300	HORIZONTAL
4	5465.22	63.29	74.00	-10.71	57.39	6.34	34.55	34.99	Peak	282	300	HORIZONTAL
5	5502.75	117.56			111.60	6.36	34.60	35.00	Peak	282	300	HORIZONTAL
6	5503.33	106.90			100.94	6.36	34.60	35.00	Average	282	300	HORIZONTAL

Item 5, 6 are the fundamental frequency at 5500 MHz.

Channel 116

	Freq	Level	Limit	Over	Read	CableAntenna	Preamp	Remark	A/Pos	T/Pos	Pol/Phase	
	MHz	dBuV/m	dBuV/m	dB	dBuV	dB	dB/m	dB	cm	deg		
1	5459.13	59.73	74.00	-14.27	53.87	6.33	34.52	34.99	Peak	277	304	HORIZONTAL
2	5460.00	46.49	54.00	-7.51	40.63	6.33	34.52	34.99	Average	277	304	HORIZONTAL
3	5469.13	59.99	74.00	-14.01	54.09	6.34	34.55	34.99	Peak	277	304	HORIZONTAL
4	5470.00	47.03	54.00	-6.97	41.13	6.34	34.55	34.99	Average	277	304	HORIZONTAL
5	5582.60	111.30			105.30	6.39	34.62	35.01	Average	277	304	HORIZONTAL
6	5583.04	121.21			115.21	6.39	34.62	35.01	Peak	277	304	HORIZONTAL

Item 5, 6 are the fundamental frequency at 5580 MHz.

Channel 140

	Freq	Level	Limit	Over	Read	CableAntenna	Preamp	Remark	A/Pos	T/Pos	Pol/Phase	
	MHz	dBuV/m	dBuV/m	dB	dBuV	dB	dB/m	dB	cm	deg		
1	5702.60	116.31			110.26	6.44	34.64	35.03	Peak	274	300	HORIZONTAL
2	5702.89	104.14			98.09	6.44	34.64	35.03	Average	274	300	HORIZONTAL
3	5725.00	52.84	54.00	-1.16	46.78	6.45	34.64	35.03	Average	274	300	HORIZONTAL
4	5725.00	70.57	74.00	-3.43	64.51	6.45	34.64	35.03	Peak	274	300	HORIZONTAL

Item 1, 2 are the fundamental frequency at 5700 MHz.

Temperature	25°C	Humidity	55%
Test Engineer	Stim Sung	Configurations	IEEE 802.11ac MCS0/Nss1 VHT20 CH 52, 60, 64 / Chain 1 + Chain 2 + Chain 3+ Chain 4
Test Date	Oct. 16, 2015 ~ Oct. 17, 2015		
Test Mode	Mode 1: PIFA Antenna / Chain1:5.84 dBi, Chain2:5.50 dBi, Chain3:5.84 dBi, Chain4:5.65 dBi		

Channel 52

	Freq	Level	Limit	Over	Read	CableAntenna	Preamp	Remark	A/Pos	T/Pos	Pol/Phase
	MHz	dBuV/m	dBuV/m	dB	dBuV	dB	dB/m	dB	cm	deg	
1	5148.26	57.87	74.00	-16.13	52.70	6.13	34.04	35.00	Peak	299	303 HORIZONTAL
2	5150.00	45.45	54.00	-8.55	40.28	6.13	34.04	35.00	Average	299	303 HORIZONTAL
3	5263.91	120.90			115.46	6.21	34.23	35.00	Peak	299	303 HORIZONTAL
4	5265.21	109.25			103.81	6.21	34.23	35.00	Average	299	303 HORIZONTAL
5	5359.99	46.32	54.00	-7.68	40.70	6.26	34.36	35.00	Average	299	303 HORIZONTAL
6	5362.16	58.61	74.00	-15.39	52.95	6.27	34.39	35.00	Peak	299	303 HORIZONTAL

Item 3, 4 are the fundamental frequency at 5260 MHz.

Channel 60

	Freq	Level	Limit	Over	Read	CableAntenna	Preamp	Remark	A/Pos	T/Pos	Pol/Phase
	MHz	dBuV/m	dBuV/m	dB	dBuV	dB	dB/m	dB	cm	deg	
1	5305.21	109.51			104.00	6.23	34.28	35.00	Average	300	304 HORIZONTAL
2	5305.21	120.45			114.94	6.23	34.28	35.00	Peak	300	304 HORIZONTAL
3	5351.16	50.90	54.00	-3.10	45.28	6.26	34.36	35.00	Average	300	304 HORIZONTAL
4	5351.16	65.74	74.00	-8.26	60.12	6.26	34.36	35.00	Peak	300	304 HORIZONTAL

Item 1, 2 are the fundamental frequency at 5300 MHz.

Channel 64

	Freq	Level	Limit	Over	Read	CableAntenna	Preamp	Remark	A/Pos	T/Pos	Pol/Phase
	MHz	dBuV/m	dBuV/m	dB	dBuV	dB	dB/m	dB	cm	deg	
1	5322.60	116.64			111.09	6.24	34.31	35.00	Peak	295	308 HORIZONTAL
2	5322.75	104.72			99.17	6.24	34.31	35.00	Average	295	308 HORIZONTAL
3	5350.00	47.80	54.00	-6.20	42.18	6.26	34.36	35.00	Average	295	308 HORIZONTAL
4	5350.87	61.41	74.00	-12.59	55.79	6.26	34.36	35.00	Peak	295	308 HORIZONTAL

Item 1, 2 are the fundamental frequency at 5320 MHz.

Temperature	25°C	Humidity	55%
Test Engineer	Stim Sung	Configurations	IEEE 802.11ac MCS0/Nss1 VHT20 CH 100, 116, 140 / Chain 1 + Chain 2 + Chain 3+ Chain 4
Test Date	Oct. 17, 2015		
Test Mode	Mode 1: PIFA Antenna / Chain1:5.84 dBi, Chain2:5.50 dBi, Chain3:5.84 dBi, Chain4:5.65 dBi		

Channel 100

	Freq	Level	Limit Line	Over Limit	Read Level	CableAntenna Loss	Antenna Factor	Preamp Factor	Remark	A/Pos	T/Pos	Pol/Phase
	MHz	dBuV/m	dBuV/m	dB	dBuV	dB	dB/m	dB		cm	deg	
1	5456.38	60.84	74.00	-13.16	54.98	6.33	34.52	34.99	Peak	248	307	HORIZONTAL
2	5460.00	46.99	54.00	-7.01	41.13	6.33	34.52	34.99	Average	248	307	HORIZONTAL
3	5462.89	48.20	54.00	-5.80	42.30	6.34	34.55	34.99	Average	248	307	HORIZONTAL
4	5469.57	62.41	74.00	-11.59	56.51	6.34	34.55	34.99	Peak	248	307	HORIZONTAL
5	5502.60	105.58			99.62	6.36	34.60	35.00	Average	248	307	HORIZONTAL
6	5502.75	117.13			111.17	6.36	34.60	35.00	Peak	248	307	HORIZONTAL

Item 5, 6 are the fundamental frequency at 5500 MHz.

Channel 116

	Freq	Level	Limit Line	Over Limit	Read Level	CableAntenna Loss	Antenna Factor	Preamp Factor	Remark	A/Pos	T/Pos	Pol/Phase
	MHz	dBuV/m	dBuV/m	dB	dBuV	dB	dB/m	dB		cm	deg	
1	5456.09	59.89	74.00	-14.11	54.03	6.33	34.52	34.99	Peak	291	303	HORIZONTAL
2	5460.00	46.02	54.00	-7.98	40.16	6.33	34.52	34.99	Average	291	303	HORIZONTAL
3	5469.57	59.20	74.00	-14.80	53.30	6.34	34.55	34.99	Peak	291	303	HORIZONTAL
4	5470.00	46.24	54.00	-7.76	40.34	6.34	34.55	34.99	Average	291	303	HORIZONTAL
5	5581.74	120.59			114.59	6.39	34.62	35.01	Peak	291	303	HORIZONTAL
6	5582.17	108.77			102.77	6.39	34.62	35.01	Average	291	303	HORIZONTAL

Item 5, 6 are the fundamental frequency at 5580 MHz.

Channel 140

	Freq	Level	Limit Line	Over Limit	Read Level	CableAntenna Loss	Antenna Factor	Preamp Factor	Remark	A/Pos	T/Pos	Pol/Phase
	MHz	dBuV/m	dBuV/m	dB	dBuV	dB	dB/m	dB		cm	deg	
1	5702.89	116.25			110.20	6.44	34.64	35.03	Peak	274	303	HORIZONTAL
2	5703.18	104.16			98.11	6.44	34.64	35.03	Average	274	303	HORIZONTAL
3	5725.00	52.98	54.00	-1.02	46.92	6.45	34.64	35.03	Average	274	303	HORIZONTAL
4	5725.00	67.47	74.00	-6.53	61.41	6.45	34.64	35.03	Peak	274	303	HORIZONTAL

Item 1, 2 are the fundamental frequency at 5700 MHz.

Temperature	25°C	Humidity	55%
Test Engineer	Stim Sung	Configurations	IEEE 802.11ac MCS0/Nss1 VHT40 CH 54, 62 / Chain 1 + Chain 2 + Chain 3+ Chain 4
Test Date	Oct. 16, 2015 ~ Oct. 17, 2015		
Test Mode	Mode 1: PIFA Antenna / Chain1:5.84 dBi, Chain2:5.50 dBi, Chain3:5.84 dBi, Chain4:5.65 dBi		

Channel 54

	Freq	Level	Limit	Over	Read	CableAntenna	Preamp	Remark	A/Pos	T/Pos	Pol/Phase
	MHz	dBuV/m	dBuV/m	dB	dBuV	dB	dB/m	dB	cm	deg	
1	5141.32	58.76	74.00	-15.24	53.59	6.13	34.04	35.00	Peak	295	304 HORIZONTAL
2	5150.00	45.36	54.00	-8.64	40.19	6.13	34.04	35.00	Average	295	304 HORIZONTAL
3	5275.21	105.58			100.14	6.21	34.23	35.00	Average	295	304 HORIZONTAL
4	5275.64	116.29			110.82	6.22	34.25	35.00	Peak	295	304 HORIZONTAL
5	5354.34	67.08	74.00	-6.92	61.46	6.26	34.36	35.00	Peak	295	304 HORIZONTAL
6	5355.21	52.88	54.00	-1.12	47.26	6.26	34.36	35.00	Average	295	304 HORIZONTAL

Item 3, 4 are the fundamental frequency at 5270 MHz.

Channel 62

	Freq	Level	Limit	Over	Read	CableAntenna	Preamp	Remark	A/Pos	T/Pos	Pol/Phase
	MHz	dBuV/m	dBuV/m	dB	dBuV	dB	dB/m	dB	cm	deg	
1	5314.63	96.49			90.94	6.24	34.31	35.00	Average	287	297 HORIZONTAL
2	5314.92	107.38			101.83	6.24	34.31	35.00	Peak	287	297 HORIZONTAL
3	5351.16	59.90	74.00	-14.10	54.28	6.26	34.36	35.00	Peak	287	297 HORIZONTAL
4	5354.05	47.07	54.00	-6.93	41.45	6.26	34.36	35.00	Average	287	297 HORIZONTAL

Item 1, 2 are the fundamental frequency at 5310 MHz.

Temperature	25°C	Humidity	55%
Test Engineer	Stim Sung	Configurations	IEEE 802.11ac MCS0/Nss1 VHT40 CH 102, 110, 134 / Chain 1 + Chain 2 + Chain 3+ Chain 4
Test Date	Oct. 17, 2015		
Test Mode	Mode 1: PIFA Antenna / Chain1:5.84 dBi, Chain2:5.50 dBi, Chain3:5.84 dBi, Chain4:5.65 dBi		

Channel 102

	Freq	Level	Limit Line	Over Limit	Read Level	CableAntenna Loss	Antenna Factor	Preamp Factor	Remark	A/Pos	T/Pos	Pol/Phase
	MHz	dBuV/m	dBuV/m	dB	dBuV	dB	dB/m	dB		cm	deg	
1	5451.32	61.09	74.00	-12.91	55.23	6.33	34.52	34.99	Peak	247	309	VERTICAL
2	5451.90	46.95	54.00	-7.05	41.09	6.33	34.52	34.99	Average	247	309	VERTICAL
3	5470.00	49.26	54.00	-4.74	43.36	6.34	34.55	34.99	Average	247	309	VERTICAL
4	5470.00	61.18	74.00	-12.82	55.28	6.34	34.55	34.99	Peak	247	309	VERTICAL
5	5511.45	105.85			99.89	6.36	34.60	35.00	Peak	247	309	VERTICAL
6	5511.74	95.07			89.11	6.36	34.60	35.00	Average	247	309	VERTICAL

Item 5, 6 are the fundamental frequency at 5510 MHz.

Channel 110

	Freq	Level	Limit Line	Over Limit	Read Level	CableAntenna Loss	Antenna Factor	Preamp Factor	Remark	A/Pos	T/Pos	Pol/Phase
	MHz	dBuV/m	dBuV/m	dB	dBuV	dB	dB/m	dB		cm	deg	
1	5452.62	63.22	74.00	-10.78	57.36	6.33	34.52	34.99	Peak	270	302	HORIZONTAL
2	5453.05	52.41	54.00	-1.59	46.55	6.33	34.52	34.99	Average	270	302	HORIZONTAL
3	5470.00	52.98	54.00	-1.02	47.08	6.34	34.55	34.99	Average	270	302	HORIZONTAL
4	5470.00	67.52	74.00	-6.48	61.62	6.34	34.55	34.99	Peak	270	302	HORIZONTAL
5	5553.04	115.67			109.69	6.38	34.61	35.01	Peak	270	302	HORIZONTAL
6	5553.47	104.70			98.72	6.38	34.61	35.01	Average	270	302	HORIZONTAL

Item 5, 6 are the fundamental frequency at 5550 MHz.

Channel 134

	Freq	Level	Limit Line	Over Limit	Read Level	CableAntenna Loss	Antenna Factor	Preamp Factor	Remark	A/Pos	T/Pos	Pol/Phase
	MHz	dBuV/m	dBuV/m	dB	dBuV	dB	dB/m	dB		cm	deg	
1	5672.03	100.74			94.71	6.43	34.63	35.03	Average	278	299	HORIZONTAL
2	5672.03	112.06			106.03	6.43	34.63	35.03	Peak	278	299	HORIZONTAL
3	5727.60	52.86	54.00	-1.14	46.80	6.45	34.64	35.03	Average	278	299	HORIZONTAL
4	5727.60	67.71	74.00	-6.29	61.65	6.45	34.64	35.03	Peak	278	299	HORIZONTAL

Item 1, 2 are the fundamental frequency at 5670 MHz.

Temperature	25°C	Humidity	55%
Test Engineer	Stim Sung	Configurations	IEEE 802.11ac MCS0/Nss1 VHT80 CH 58, 106, 122 / Chain 1 + Chain 2 + Chain 3+ Chain 4
Test Date	Oct. 16, 2015 ~ Oct. 20, 2015		
Test Mode	Mode 1: PIFA Antenna / Chain1:5.84 dBi, Chain2:5.50 dBi, Chain3:5.84 dBi, Chain4:5.65 dBi		

Channel 58

	Freq	Level	Limit Line	Over Limit	Read Level	CableAntenna Loss	Antenna Factor	Preamp Factor	Remark	A/Pos	T/Pos	Pol/Phase
	MHz	dBuV/m	dBuV/m	dB	dBuV	dB	dB/m	dB		cm	deg	
1	5120.33	59.39	74.00	-14.61	54.29	6.11	33.99	35.00	Peak	285	58	HORIZONTAL
2	5149.28	45.75	54.00	-8.25	40.58	6.13	34.04	35.00	Average	285	58	HORIZONTAL
3	5270.46	103.30			97.86	6.21	34.23	35.00	Peak	285	58	HORIZONTAL
4	5288.55	93.90			88.43	6.22	34.25	35.00	Average	285	58	HORIZONTAL
5	5350.00	50.35	54.00	-3.65	44.73	6.26	34.36	35.00	Average	285	58	HORIZONTAL
6	5352.89	63.66	74.00	-10.34	58.04	6.26	34.36	35.00	Peak	285	58	HORIZONTAL

Item 3, 4 are the fundamental frequency at 5290 MHz.

Channel 106

	Freq	Level	Limit Line	Over Limit	Read Level	CableAntenna Loss	Antenna Factor	Preamp Factor	Remark	A/Pos	T/Pos	Pol/Phase
	MHz	dBuV/m	dBuV/m	dB	dBuV	dB	dB/m	dB		cm	deg	
1	5434.67	66.20	74.00	-7.80	60.38	6.32	34.49	34.99	Peak	280	304	HORIZONTAL
2	5454.21	52.48	54.00	-1.52	46.62	6.33	34.52	34.99	Average	280	304	HORIZONTAL
3	5460.72	47.27	54.00	-6.73	41.41	6.33	34.52	34.99	Average	280	304	HORIZONTAL
4	5464.21	61.09	74.00	-12.91	55.19	6.34	34.55	34.99	Peak	280	304	HORIZONTAL
5	5533.62	94.30			88.32	6.37	34.61	35.00	Average	280	304	HORIZONTAL
6	5534.34	103.97			97.99	6.37	34.61	35.00	Peak	280	304	HORIZONTAL
7	5725.72	44.27	54.00	-9.73	38.21	6.45	34.64	35.03	Average	280	304	HORIZONTAL
8	5769.14	59.71	74.00	-14.29	53.64	6.46	34.66	35.05	Peak	280	304	HORIZONTAL

Item 5, 6 are the fundamental frequency at 5530 MHz.

Channel 122

	Freq	Level	Limit Line	Over Limit	Read Level	CableAntenna Loss	Antenna Factor	Preamp Factor	Remark	A/Pos	T/Pos	Pol/Phase
	MHz	dBuV/m	dBuV/m	dB	dBuV	dB	dB/m	dB		cm	deg	
1	5450.59	49.77	54.00	-4.23	43.91	6.33	34.52	34.99	Average	268	305	HORIZONTAL
2	5451.32	64.16	74.00	-9.84	58.30	6.33	34.52	34.99	Peak	268	305	HORIZONTAL
3	5470.00	52.73	54.00	-1.27	46.83	6.34	34.55	34.99	Average	268	305	HORIZONTAL
4	5470.00	67.60	74.00	-6.40	61.70	6.34	34.55	34.99	Peak	268	305	HORIZONTAL
5	5591.19	99.53			93.53	6.39	34.62	35.01	Average	268	305	HORIZONTAL
6	5591.91	112.19			106.19	6.39	34.62	35.01	Peak	268	305	HORIZONTAL
7	5726.45	51.51	54.00	-2.49	45.45	6.45	34.64	35.03	Average	268	305	HORIZONTAL
8	5727.17	65.02	74.00	-8.98	58.96	6.45	34.64	35.03	Peak	268	305	HORIZONTAL

Item 5, 6 are the fundamental frequency at 5610 MHz.

Note:

Emission level (dBuV/m) = 20 log Emission level (uV/m)

Corrected Reading: Antenna Factor + Cable Loss + Read Level - Preamp Factor = Level

Straddle Channel

Temperature	25°C	Humidity	55%
Test Engineer	Stim Sung	Configurations	IEEE 802.11a CH 144 / Chain 1 + Chain 2 + Chain 3+ Chain 4
Test Date	Oct. 20, 2015		
Test Mode	Mode 1: PIFA Antenna / Chain1:5.84 dBi, Chain2:5.50 dBi, Chain3:5.84 dBi, Chain4:5.65 dBi		

Channel 144

	Freq	Level	Limit	Over	Read	Cable	Preamp	Antenna		A/Pos	T/Pos	Remark
	MHz	dBuV/m	dBuV/m	dB	dBuV	dB	dB	dB/m		cm	deg	
1	5727.00	98.97			92.11	7.79	33.01	32.08	VERTICAL	166	286	Average
2	5727.00	110.96			104.10	7.79	33.01	32.08	VERTICAL	166	286	Peak
3	5850.00	45.82	54.00	-8.18	38.78	7.87	33.05	32.22	VERTICAL	166	286	Average
4	5850.00	57.96	74.00	-16.04	50.92	7.87	33.05	32.22	VERTICAL	166	286	Peak

Item 1, 2 are the fundamental frequency at 5720 MHz.

Temperature	25°C	Humidity	55%
Test Engineer	Stim Sung	Configurations	IEEE 802.11ac MCS0/Nss1 VHT20 CH 144 / Chain 1 + Chain 2 + Chain 3+ Chain 4
Test Date	Oct. 20, 2015		
Test Mode	Mode 1: PIFA Antenna / Chain1:5.84 dBi, Chain2:5.50 dBi, Chain3:5.84 dBi, Chain4:5.65 dBi		

Channel 144

	Freq	Level	Limit	Over	Read	Cable	Preamp	Antenna		A/Pos	T/Pos	Remark
	MHz	dBuV/m	dBuV/m	dB	dBuV	dB	dB	dB/m		cm	deg	
1	5725.00	106.74			99.87	7.79	33.00	32.08	HORIZONTAL	258	68	Average
2	5726.00	116.90			110.03	7.79	33.00	32.08	HORIZONTAL	258	68	Peak
3	5850.00	46.43	54.00	-7.57	39.39	7.87	33.05	32.22	HORIZONTAL	258	68	Average
4	5851.00	58.61	74.00	-15.39	51.57	7.87	33.05	32.22	HORIZONTAL	258	68	Peak

Item 1, 2 are the fundamental frequency at 5720 MHz.

Temperature	25°C	Humidity	55%
Test Engineer	Stim Sung	Configuration	IEEE 802.11ac MCS0/Nss1 VHT40 CH 142 / Chain 1 + Chain 2 + Chain 3+ Chain 4
Test Date	Oct. 20, 2015		
Test Mode	Mode 1: PIFA Antenna / Chain1:5.84 dBi, Chain2:5.50 dBi, Chain3:5.84 dBi, Chain4:5.65 dBi		

Channel 142

	Freq	Level	Limit	Over	Read	Cable	Preamp	Antenna	Pol/Phase	A/Pos	T/Pos	Remark
	MHz	dBuV/m	dBuV/m	dB	dBuV	dB	dB	dB/m		cm	deg	
1	5718.00	100.04			93.19	7.79	33.00	32.06	VERTICAL	312	54	Average
2	5719.00	109.90			103.05	7.79	33.00	32.06	VERTICAL	312	54	Peak
3	5850.00	46.68	54.00	-7.32	39.64	7.87	33.05	32.22	VERTICAL	312	54	Average
4	5853.00	57.80	74.00	-16.20	50.76	7.87	33.05	32.22	VERTICAL	312	54	Peak

Item 1, 2 are the fundamental frequency at 5710 MHz.

Temperature	25°C	Humidity	55%
Test Engineer	Stim Sung	Configurations	IEEE 802.11ac MCS0/Nss1 VHT80 CH 138 / Chain 1 + Chain 2 + Chain 3+ Chain 4
Test Date	Oct. 20, 2015		
Test Mode	Mode 1: PIFA Antenna / Chain1:5.84 dBi, Chain2:5.50 dBi, Chain3:5.84 dBi, Chain4:5.65 dBi		

Channel 138

	Freq	Level	Limit	Over	Read	Cable	Preamp	Antenna	Pol/Phase	A/Pos	T/Pos	Remark
	MHz	dBuV/m	dBuV/m	dB	dBuV	dB	dB	dB/m		cm	deg	
1	5676.00	111.08			104.29	7.76	32.99	32.02	HORIZONTAL	261		58 Peak
2	5696.00	100.67			93.85	7.78	33.00	32.04	HORIZONTAL	261		58 Average
3	5857.00	52.98	54.00	-1.02	45.92	7.87	33.05	32.24	HORIZONTAL	261		58 Average
4	5857.00	66.63	74.00	-7.37	59.57	7.87	33.05	32.24	HORIZONTAL	261		58 Peak

Item 1, 2 are the fundamental frequency at 5690 MHz.

4.8. Frequency Stability Measurement

4.8.1. Limit

In-band emission is maintained within the band of operation under all conditions of normal operation as specified in the user's manual.

The transmitter center frequency tolerance shall be ± 20 ppm maximum for the 5 GHz band (IEEE 802.11n specification).

4.8.2. Measuring Instruments and Setting

Please refer to section 5 of equipments list in this report. The following table is the setting of the spectrum analyzer.

Spectrum Parameter	Setting
Attenuation	Auto
Span Frequency	Entire absence of modulation emissions bandwidth
RBW	10 kHz
VBW	10 kHz
Sweep Time	Auto

4.8.3. Test Procedures

1. The transmitter output (antenna port) was connected to the spectrum analyzer.
2. EUT have transmitted absence of modulation signal and fixed channelize.
3. Set the spectrum analyzer span to view the entire absence of modulation emissions bandwidth.
4. Set RBW = 10 kHz, VBW = 10 kHz with peak detector and maxhold settings.
5. f_c is declaring of channel frequency. Then the frequency error formula is $(f_c - f) / f_c \times 10^6$ ppm and the limit is less than ± 20 ppm (IEEE 802.11n specification).
6. Allow sufficient time (approximately 30 min) for the temperature of the chamber to stabilize, turn the EUT on and measure the operating frequency after 2, 5, and 10 minutes.
7. The test extreme voltage is to change the primary supply voltage from 85 to 115 percent of the nominal value
8. Extreme temperature is $-20^\circ\text{C} \sim 50^\circ\text{C}$.

4.8.4. Test Setup Layout

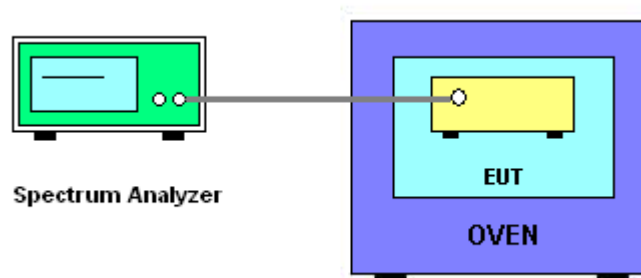

4.8.5. Test Deviation

There is no deviation with the original standard.

4.8.6. EUT Operation during Test

The EUT was programmed to be in continuously un-modulation transmitting mode.

4.8.7. Test Result of Frequency Stability

Temperature	25°C	Humidity	50%
Test Engineer	Eddie Weng & Lucas Huang	Test Date	Oct. 20, 2015
Test Mode	Mode 1: PIFA Antenna / Chain1:5.84 dBi, Chain2:5.50 dBi, Chain3:5.84 dBi, Chain4:5.65 dBi		

Mode: 20 MHz / Chain 4

Voltage vs. Frequency Stability

Voltage (V)	Measurement Frequency (MHz)			
	5300 MHz			
	0 Minute	2 Minute	5 Minute	10 Minute
126.50	5300.0481	5300.0467	5300.0449	5300.0428
110.00	5300.0469	5300.0456	5300.0440	5300.0421
93.50	5300.0455	5300.0444	5300.0432	5300.0410
Max. Deviation (MHz)	0.0481	0.0467	0.0449	0.0428
Max. Deviation (ppm)	9.08	8.81	8.47	8.08
Result	Complies			

Temperature vs. Frequency Stability

Temperature (°C)	Measurement Frequency (MHz)			
	5300 MHz			
	0 Minute	2 Minute	5 Minute	10 Minute
-20	5300.0523	5300.0510	5300.0493	5300.0469
-10	5300.0508	5300.0496	5300.0480	5300.0461
0	5300.0494	5300.0482	5300.0463	5300.0441
10	5300.0481	5300.0468	5300.0453	5300.0435
20	5300.0469	5300.0456	5300.0440	5300.0421
30	5300.0455	5300.0444	5300.0430	5300.0414
40	5300.0439	5300.0424	5300.0408	5300.0388
50	5300.0422	5300.0410	5300.0395	5300.0368
Max. Deviation (MHz)	0.0523	0.0510	0.0493	0.0469
Max. Deviation (ppm)	9.87	9.62	9.30	8.85
Result	Complies			

Voltage vs. Frequency Stability

Voltage	Measurement Frequency (MHz)			
(V)	5580 MHz			
	0 Minute	2 Minute	5 Minute	10 Minute
126.50	5580.0599	5580.0585	5580.0567	5580.0546
110.00	5580.0587	5580.0574	5580.0558	5580.0539
93.50	5580.0573	5580.0562	5580.0550	5580.0528
Max. Deviation (MHz)	0.0599	0.0585	0.0567	0.0546
Max. Deviation (ppm)	10.73	10.48	10.16	9.78
Result	Complies			

Temperature vs. Frequency Stability

Temperature	Measurement Frequency (MHz)			
(°C)	5580 MHz			
	0 Minute	2 Minute	5 Minute	10 Minute
-20	5580.0641	5580.0628	5580.0611	5580.0587
-10	5580.0626	5580.0614	5580.0598	5580.0579
0	5580.0612	5580.0600	5580.0581	5580.0559
10	5580.0599	5580.0586	5580.0571	5580.0553
20	5580.0587	5580.0574	5580.0558	5580.0539
30	5580.0573	5580.0562	5580.0548	5580.0532
40	5580.0557	5580.0542	5580.0526	5580.0506
50	5580.0540	5580.0528	5580.0513	5580.0486
Max. Deviation (MHz)	0.0641	0.0628	0.0611	0.0587
Max. Deviation (ppm)	11.49	11.25	10.95	10.52
Result	Complies			

Mode: 40 MHz / Chain 4
Voltage vs. Frequency Stability

Voltage	Measurement Frequency (MHz)			
	5310 MHz			
(V)	0 Minute	2 Minute	5 Minute	10 Minute
126.50	5310.0557	5310.0543	5310.0525	5310.0504
110.00	5310.0545	5310.0532	5310.0516	5310.0497
93.50	5310.0531	5310.0520	5310.0508	5310.0486
Max. Deviation (MHz)	0.0557	0.0543	0.0525	0.0504
Max. Deviation (ppm)	10.49	10.23	9.89	9.50
Result	Complies			

Temperature vs. Frequency Stability

Temperature	Measurement Frequency (MHz)			
	5310 MHz			
(°C)	0 Minute	2 Minute	5 Minute	10 Minute
-20	5310.0599	5310.0586	5310.0569	5310.0545
-10	5310.0584	5310.0572	5310.0556	5310.0537
0	5310.0570	5310.0558	5310.0539	5310.0517
10	5310.0557	5310.0544	5310.0529	5310.0511
20	5310.0545	5310.0532	5310.0516	5310.0497
30	5310.0531	5310.0520	5310.0506	5310.0490
40	5310.0515	5310.0500	5310.0484	5310.0464
50	5310.0498	5310.0486	5310.0471	5310.0444
Max. Deviation (MHz)	0.0599	0.0586	0.0569	0.0545
Max. Deviation (ppm)	11.28	11.04	10.72	10.26
Result	Complies			

Voltage vs. Frequency Stability

Voltage (V)	Measurement Frequency (MHz)			
	5550 MHz			
	0 Minute	2 Minute	5 Minute	10 Minute
126.50	5550.0589	5550.0575	5550.0557	5550.0536
110.00	5550.0577	5550.0564	5550.0548	5550.0529
93.50	5550.0563	5550.0552	5550.0540	5550.0518
Max. Deviation (MHz)	0.0589	0.0575	0.0557	0.0536
Max. Deviation (ppm)	10.61	10.36	10.04	9.66
Result	Complies			

Temperature vs. Frequency Stability

Temperature (°C)	Measurement Frequency (MHz)			
	5550 MHz			
	0 Minute	2 Minute	5 Minute	10 Minute
-20	5550.0631	5550.0618	5550.0601	5550.0577
-10	5550.0616	5550.0604	5550.0588	5550.0569
0	5550.0602	5550.0590	5550.0571	5550.0549
10	5550.0589	5550.0576	5550.0561	5550.0543
20	5550.0577	5550.0564	5550.0548	5550.0529
30	5550.0563	5550.0552	5550.0538	5550.0522
40	5550.0547	5550.0532	5550.0516	5550.0496
50	5550.0530	5550.0518	5550.0503	5550.0476
Max. Deviation (MHz)	0.0631	0.0618	0.0601	0.0577
Max. Deviation (ppm)	11.37	11.14	10.83	10.40
Result	Complies			

Mode: 80 MHz / Chain 4
Voltage vs. Frequency Stability

Voltage	Measurement Frequency (MHz)			
(V)	5290 MHz			
	0 Minute	2 Minute	5 Minute	10 Minute
126.50	5290.0574	5290.0560	5290.0542	5290.0521
110.00	5290.0562	5290.0549	5290.0533	5290.0514
93.50	5290.0548	5290.0537	5290.0525	5290.0503
Max. Deviation (MHz)	0.0574	0.0560	0.0542	0.0521
Max. Deviation (ppm)	10.85	10.59	10.25	9.85
Result	Complies			

Temperature vs. Frequency Stability

Temperature	Measurement Frequency (MHz)			
(°C)	5290 MHz			
	0 Minute	2 Minute	5 Minute	10 Minute
-20	5290.0616	5290.0603	5290.0586	5290.0562
-10	5290.0601	5290.0589	5290.0573	5290.0554
0	5290.0587	5290.0575	5290.0556	5290.0534
10	5290.0574	5290.0561	5290.0546	5290.0528
20	5290.0562	5290.0549	5290.0533	5290.0514
30	5290.0548	5290.0537	5290.0523	5290.0507
40	5290.0532	5290.0517	5290.0501	5290.0481
50	5290.0515	5290.0503	5290.0488	5290.0461
Max. Deviation (MHz)	0.0616	0.0603	0.0586	0.0562
Max. Deviation (ppm)	11.64	11.40	11.08	10.62
Result	Complies			

Voltage vs. Frequency Stability

Voltage (V)	Measurement Frequency (MHz)			
	5530 MHz			
	0 Minute	2 Minute	5 Minute	10 Minute
126.50	5530.0383	5530.0369	5530.0351	5530.0330
110.00	5530.0371	5530.0358	5530.0342	5530.0323
93.50	5530.0357	5530.0346	5530.0334	5530.0312
Max. Deviation (MHz)	0.0383	0.0369	0.0351	0.0330
Max. Deviation (ppm)	6.93	6.67	6.35	5.97
Result	Complies			

Temperature vs. Frequency Stability

Temperature (°C)	Measurement Frequency (MHz)			
	5530 MHz			
	0 Minute	2 Minute	5 Minute	10 Minute
-20	5530.0425	5530.0412	5530.0395	5530.0371
-10	5530.0410	5530.0398	5530.0382	5530.0363
0	5530.0396	5530.0384	5530.0365	5530.0343
10	5530.0383	5530.0370	5530.0355	5530.0337
20	5530.0371	5530.0358	5530.0342	5530.0323
30	5530.0357	5530.0346	5530.0332	5530.0316
40	5530.0341	5530.0326	5530.0310	5530.0290
50	5530.0324	5530.0312	5530.0297	5530.0270
Max. Deviation (MHz)	0.0425	0.0412	0.0395	0.0371
Max. Deviation (ppm)	7.69	7.45	7.14	6.71
Result	Complies			

4.9. Antenna Requirements

4.9.1. Limit

Except for special regulations, the Low-power Radio-frequency Devices must not be equipped with any jacket for installing an antenna with extension cable. An intentional radiator shall be designed to ensure that no antenna other than that furnished by the responsible party shall be used with the device. The use of a permanently attached antenna or of an antenna that uses a unique coupling to the intentional radiator shall be considered sufficient to comply with the provisions of this Section. The manufacturer may design the unit so that the user can replace a broken antenna, but the use of a standard antenna jack or electrical connector is prohibited. Further, this requirement does not apply to intentional radiators that must be professionally installed.

4.9.2. Antenna Connector Construction

Please refer to section 3.3 in this test report; antenna connector complied with the requirements.

5. LIST OF MEASURING EQUIPMENTS

Conducted Emission

Instrument	Manufacturer	Model No.	Serial No.	Characteristics	Calibration Date	Remark
EMC Receiver	R&S	ESR3	102051	9KHz ~ 3.6GHz	29/Apr/2017	Conduction (CO04-HY)
LISN	R&S	ENV216	101295	9kHz ~ 30MHz	15/Nov/2016	Conduction (CO04-HY)
RF Cable-CON	HUBER+SUHNER	RG213/U	07611832020001	9kHz ~ 30MHz	24/Oct/2016	Conduction (CO04-HY)
Impuls Begrenzer Pulse Limiter	R&S	ESH3-Z2	100921	10 kHz ~ 30 MHz	20/Oct/2016	Conduction (CO04-HY)

Radiated Emission Below 1GHz

Instrument	Manufacturer	Model No.	Serial No.	Characteristics	Calibration Date	Remark
Spectrum Analyzer	R&S	FSP40	100593	9KHz - 40GHz	Oct. 26, 2016	Radiation 03CH02-HY
3m Semi Anechoic	SIDT FRANKONIA	SAC-3M	03CH02-HY	30MHz-1GHz	Oct. 21, 2016	Radiation 03CH02-HY
Amplifier	Agilent	8447D	2944A11149	100KHz-1.3GHz	Jun. 29, 2017	Radiation 03CH02-HY
Bilog Antenna	SCHAFFNER	CBL6112B	2723	30MHz-1GHz	Oct. 01, 2016	Radiation 03CH02-HY
Loop Antenna	TESEQ	HLA 6120	31244	9KHz-30MHz	Mar. 02, 2017	Radiation 03CH02-HY
RF Cable-R03m	Jye Bao	RG142	CB017	9kHz ~ 1GHz	Jan. 26, 2017	Radiation 03CH02-HY
Receiver	R&S	ESU3	102052	9kHz ~ 3.6GHz	Apr. 29, 2017	Radiation 03CH02-HY

Radiated Emission above 1GHz

Instrument	Manufacturer	Model No.	Serial No.	Characteristics	Calibration Date	Remark
Horn Antenna	EMCO	3115	00075790	750MHz ~ 18GHz	Oct. 28, 2014	Radiation (03CH01-CB)
Horn Antenna	EMCO	3115	00075790	750MHz ~ 18GHz	Oct. 22, 2015	Radiation (03CH01-CB)
Horn Antenna	Schwarzbeck	BBHA 9170	BBHA9170252	15GHz ~ 40GHz	Jul. 21, 2015	Radiation (03CH01-CB)
Pre-Amplifier	Agilent	8449B	3008A02310	1GHz ~ 26.5GHz	Jan. 12, 2015	Radiation (03CH01-CB)
Pre-Amplifier	WM	TF-130N-R1	923365	26GHz ~ 40GHz	Feb.10, 2015	Radiation (03CH01-CB)
Spectrum Analyzer	R&S	FSP40	100056	9kHz ~ 40GHz	Nov. 06, 2014	Radiation (03CH01-CB)
Spectrum Analyzer	R&S	FSP40	100056	9kHz ~ 40GHz	Oct. 27, 2015	Radiation (03CH01-CB)
RF Cable-high	Woken	High Cable-16	N/A	1 GHz ~ 18 GHz	Nov. 15, 2014	Radiation (03CH01-CB)

Instrument	Manufacturer	Model No.	Serial No.	Characteristics	Calibration Date	Remark
RF Cable-high	Woken	High Cable-16	N/A	1 GHz ~ 18 GHz	Nov. 02, 2015	Radiation (03CH01-CB)
RF Cable-high	Woken	High Cable-17	N/A	1 GHz ~ 18 GHz	Nov. 15, 2014	Radiation (03CH01-CB)
RF Cable-high	Woken	High Cable-17	N/A	1 GHz ~ 18 GHz	Nov. 02, 2015	Radiation (03CH01-CB)
RF Cable-high	Woken	High Cable-40G-1	N/A	1 GHz ~ 40 GHz	Nov. 15, 2014	Radiation (03CH01-CB)
RF Cable-high	Woken	High Cable-40G-1	N/A	18GHz ~ 40 GHz	Nov. 02, 2015	Radiation (03CH01-CB)
RF Cable-high	Woken	High Cable-40G-2	N/A	1 GHz ~ 40 GHz	Nov. 15, 2014	Radiation (03CH01-CB)
RF Cable-high	Woken	High Cable-40G-2	N/A	18GHz ~ 40 GHz	Nov. 02, 2015	Radiation (03CH01-CB)
Test Software	Audix	E3	6.2009-10-7	N/A	N/A	Radiation (03CH01-CB)
Spectrum analyzer	R&S	FSV40	100979	9kHz~40GHz	Dec. 12, 2014	Conducted (TH01-CB)
Temp. and Humidity Chamber	Ten Billion	TTH-D3SP	TBN-931011	-30~100 degree	Jun. 02, 2015	Conducted (TH01-CB)
RF Cable-high	Woken	RG402	High Cable-7	1 GHz – 26.5 GHz	Nov. 15, 2014	Conducted (TH01-CB)
RF Cable-high	Woken	RG402	High Cable-7	1 GHz – 26.5 GHz	Nov. 02, 2015	Conducted (TH01-CB)
RF Cable-high	Woken	RG402	High Cable-8	1 GHz – 26.5 GHz	Nov. 15, 2014	Conducted (TH01-CB)
RF Cable-high	Woken	RG402	High Cable-8	1 GHz – 26.5 GHz	Nov. 02, 2015	Conducted (TH01-CB)
RF Cable-high	Woken	RG402	High Cable-9	1 GHz – 26.5 GHz	Nov. 15, 2014	Conducted (TH01-CB)
RF Cable-high	Woken	RG402	High Cable-9	1 GHz – 26.5 GHz	Nov. 02, 2015	Conducted (TH01-CB)
RF Cable-high	Woken	RG402	High Cable-10	1 GHz – 26.5 GHz	Nov. 15, 2014	Conducted (TH01-CB)
RF Cable-high	Woken	RG402	High Cable-10	1 GHz – 26.5 GHz	Nov. 02, 2015	Conducted (TH01-CB)
RF Cable-high	Woken	RG402	High Cable-6	1 GHz – 26.5 GHz	Nov. 15, 2014	Conducted (TH01-CB)
RF Cable-high	Woken	RG402	High Cable-6	1 GHz – 26.5 GHz	Nov. 02, 2015	Conducted (TH01-CB)
Power Sensor	Agilent	U2021XA	MY53410001	50MHz~18GHz	Nov. 03, 2014	Conducted (TH01-CB)
Power Sensor	Agilent	U2021XA	MY53410001	50MHz~18GHz	Nov. 02, 2015	Conducted (TH01-CB)

Note: Calibration Interval of instruments listed above is one year.

6. MEASUREMENT UNCERTAINTY

Test Items	Uncertainty	Remark
Radiated Emission (1GHz ~ 18GHz)	3.7 dB	Confidence levels of 95%
Radiated Emission (18GHz ~ 40GHz)	3.5 dB	Confidence levels of 95%
Conducted Emission	1.7 dB	Confidence levels of 95%

Appendix B. Radiated Emission Co-location Report

1. Results of Radiated Emissions for Co-located

Temperature	25°C	Humidity	55%
Test Engineer	Stim Sung	Configurations	2.4GHz + 5GHz

Horizontal

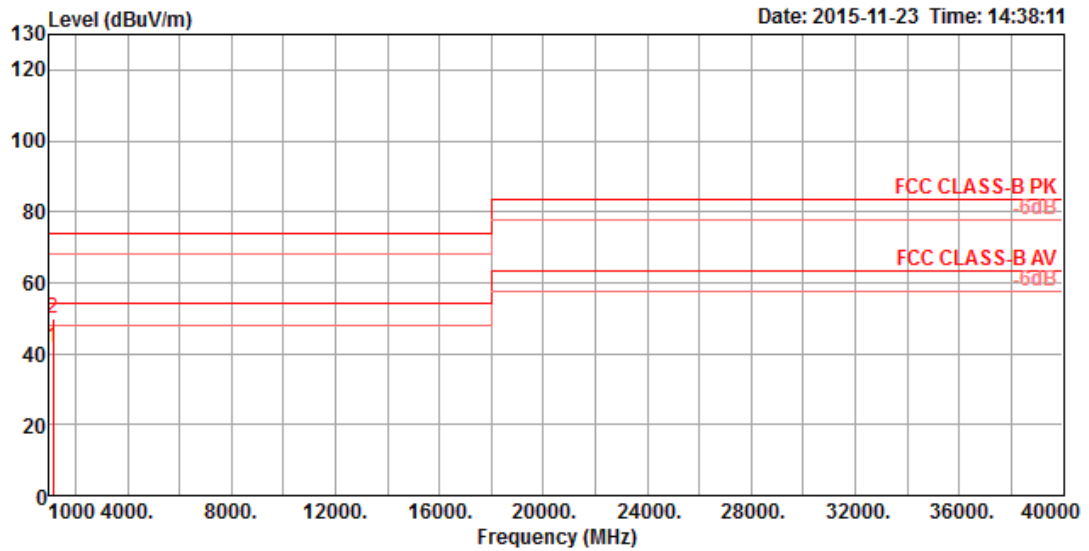

	Freq	Level	Limit Line	Over Limit	Read Level	CableAntenna Loss	Antenna Factor	Preamp Factor	A/Pos	T/Pos	Remark	Pol/Phase
	MHz	dBuV/m	dBuV/m	dB	dBuV	dB	dB/m	dB	cm	deg		
1	1129.38	41.78	54.00	-12.22	50.83	3.35	24.77	37.17	100	350	Average	HORIZONTAL
2	1129.38	49.78	74.00	-24.22	58.83	3.35	24.77	37.17	100	350	Peak	HORIZONTAL

Vertical

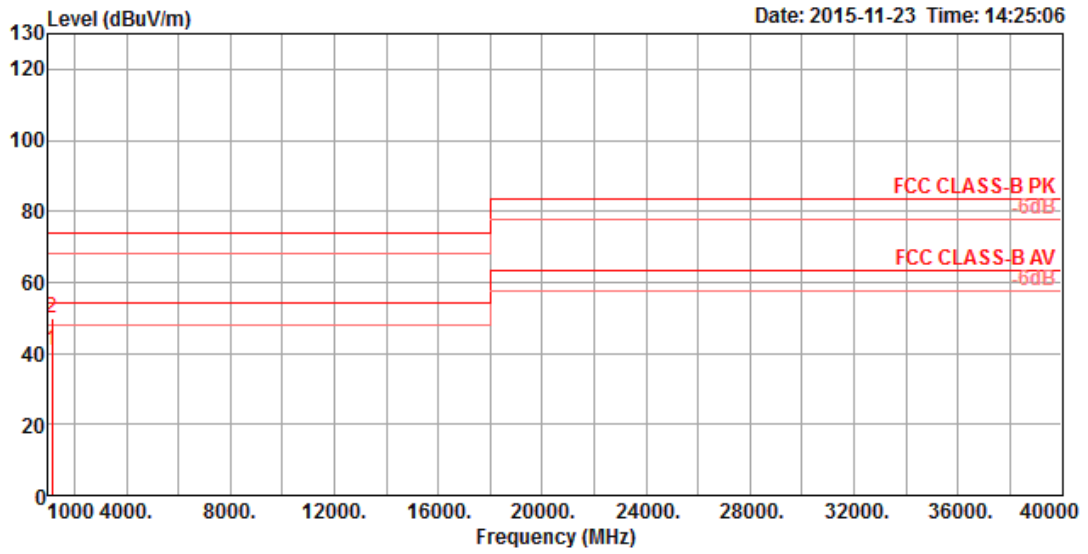

	Freq	Level	Limit Line	Over Limit	Read Level	CableAntenna Loss	Antenna Factor	Preamp Factor	A/Pos	T/Pos	Remark	Pol/Phase
	MHz	dBuV/m	dBuV/m	dB	dBuV	dB	dB/m	dB	cm	deg		
1	1129.38	41.00	54.00	-13.00	50.05	3.35	24.77	37.17	100	285	Average	VERTICAL
2	1129.38	50.00	74.00	-24.00	59.05	3.35	24.77	37.17	100	285	Peak	VERTICAL