



SPORTON International Inc.

No. 52, Huaya 1st Rd., Guishan Dist., Taoyuan City, Taiwan (R.O.C.)
Ph: 886-3-327-3456 / FAX: 886-3-327-0973 / www.sporton.com.tw

FCC RADIO TEST REPORT

Applicant's company	Allied Telesis K.K
Applicant Address	2nd. TOC Bldg. 7-21-11 Nishi-Gotanda, Shinagawa-ku, Tokyo Japan, 141-0031
FCC ID	RSL-MWS2533AP
Manufacturer's company	Senao Networks, Inc.
Manufacturer Address	3F, No. 529, Chung Cheng Rd., Hsintien, Taipei, Taiwan

Product Name	IEEE 802.a/b/g/n/ac Managed Wireless Access Point
Brand Name	
Model No.	AT-MWS2533AP
Test Rule Part(s)	47 CFR FCC Part 15 Subpart E § 15.407
Test Freq. Range	5150 ~ 5250 MHz / 5725 ~ 5850 MHz
Received Date	Oct. 15, 2015
Final Test Date	Aug. 15, 2017
Submission Type	Original Equipment

Statement

Test result included is for the IEEE 802.11n and IEEE 802.11a/ac of the product.

The test result in this report refers exclusively to the presented test model / sample.

Without written approval of SPORTON International Inc., the test report shall not be reproduced except in full.

The measurements and test results shown in this test report were made in accordance with the procedures and found in compliance with the limit given in **ANSI C63.10-2013,**

47 CFR FCC Part 15 Subpart E, KDB789033 D02 v01, KDB662911 D01 v02r01, KDB644545 D03 v01.

The test equipment used to perform the test is calibrated and traceable to NML/ROC.



Table of Contents

1. VERIFICATION OF COMPLIANCE	1
2. SUMMARY OF THE TEST RESULT	2
3. GENERAL INFORMATION	3
3.1. Product Details	3
3.2. Accessories	4
3.3. Table for Filed Antenna	5
3.4. Table for Carrier Frequencies	6
3.5. Table for Test Modes	7
3.6. Table for Testing Locations.....	10
3.7. Table for Supporting Units	11
3.8. Table for Parameters of Test Software Setting	12
3.9. EUT Operation during Test.....	12
3.10. Duty Cycle.....	12
3.11. Test Configurations.....	13
4. TEST RESULT	16
4.1. AC Power Line Conducted Emissions Measurement	16
4.2. 26dB Bandwidth and 99% Occupied Bandwidth Measurement	20
4.3. 6dB Spectrum Bandwidth Measurement	28
4.4. Maximum Conducted Output Power Measurement.....	32
4.5. Power Spectral Density Measurement.....	35
4.6. Radiated Emissions Measurement.....	42
4.7. Band Edge Emissions Measurement.....	61
4.8. Frequency Stability Measurement.....	68
4.9. Antenna Requirements	76
5. LIST OF MEASURING EQUIPMENTS.....	77
6. MEASUREMENT UNCERTAINTY	79
APPENDIX A. TEST PHOTOS	
APPENDIX B. RADIATED EMISSION CO-LOCATION REPORT	
PHOTOGRAPHS OF EUT V02	



History of This Test Report

REPORT NO.	VERSION	DESCRIPTION	ISSUED DATE
FR720735-01AD	Rev. 01	Initial issue of report	Sep. 12, 2017
FR720735-01AD	Rev. 02	Revise the test data	Oct. 13, 2017

1. VERIFICATION OF COMPLIANCE

Product Name : IEEE 802.a/b/g/n/ac Managed Wireless Access Point

Brand Name : 

Model No. : AT-MWS2533AP

Applicant : Allied Telesis K.K

Test Rule Part(s) : 47 CFR FCC Part 15 Subpart E § 15.407

Sporton International as requested by the applicant to evaluate the EMC performance of the product sample received on Oct. 15, 2015 would like to declare that the tested sample has been evaluated and found to be in compliance with the tested rule parts. The data recorded as well as the test configuration specified is true and accurate for showing the sample's EMC nature.

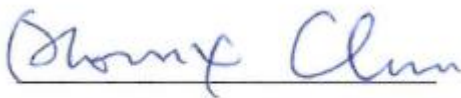

Phoenix Chen

SPORTON INTERNATIONAL INC.

2. SUMMARY OF THE TEST RESULT

Applied Standard: 47 CFR FCC Part 15 Subpart E				
Part	Rule Section	Description of Test	Result	Under Limit
4.1	15.207	AC Power Line Conducted Emissions	Complies	5.3 dB
4.2	15.407(a)	26dB Spectrum Bandwidth and 99% Occupied Bandwidth	Complies	-
4.3	15.407(e)	6dB Spectrum Bandwidth	Complies	-
4.4	15.407(a)	Maximum Conducted Output Power	Complies	0.01 dB
4.5	15.407(a)	Power Spectral Density	Complies	0.28 dB
4.6	15.407(b)	Radiated Emissions	Complies	3.05 dB
4.7	15.407(b)	Band Edge Emissions	Complies	1.02 dB
4.8	15.407(g)	Frequency Stability	Complies	-
4.9	15.203	Antenna Requirements	Complies	-

3. GENERAL INFORMATION

3.1. Product Details

Items	Description
Product Type	WLAN (4TX, 4RX)
Radio Type	Intentional Transceiver
Power Type	From power adapter or PoE
Modulation	IEEE 802.11a: OFDM IEEE 802.11n/ac: see the below table
Data Modulation	IEEE 802.11a/n: OFDM (BPSK / QPSK / 16QAM / 64QAM) IEEE 802.11ac: OFDM (BPSK / QPSK / 16QAM / 64QAM / 256QAM)
Data Rate (Mbps)	IEEE 802.11a: OFDM (6/9/12/18/24/36/48/54) IEEE 802.11n/ac: see the below table
Frequency Range	5150 ~ 5250 MHz / 5725 ~ 5850 MHz
Channel Number	9 for 20MHz bandwidth ; 4 for 40MHz bandwidth 2 for 80MHz bandwidth
Channel Band Width (99%)	Mode 1: PIFA Antenna / Chain1:5.84 dBi, Chain2:5.50 dBi, Chain3:5.84 dBi, Chain4:5.65 dBi Band 1: IEEE 802.11ac MCS0/Nss1 (VHT20): 18.06 MHz IEEE 802.11ac MCS0/Nss1 (VHT40): 37.19 MHz IEEE 802.11ac MCS0/Nss1 (VHT80): 76.12 MHz Band 4: IEEE 802.11ac MCS0/Nss1 (VHT20): 18.06 MHz IEEE 802.11ac MCS0/Nss1 (VHT40): 37.19 MHz IEEE 802.11ac MCS0/Nss1 (VHT80): 76.41 MHz
Maximum Conducted Output Power	Mode 1: PIFA Antenna / Chain1:5.84 dBi, Chain2:5.50 dBi, Chain3:5.84 dBi, Chain4:5.65 dBi Band 1: IEEE 802.11ac MCS0/Nss1 (VHT20): 24.24 dBm IEEE 802.11ac MCS0/Nss1 (VHT40): 24.00 dBm IEEE 802.11ac MCS0/Nss1 (VHT80): 15.75 dBm Band 4: IEEE 802.11ac MCS0/Nss1 (VHT20): 24.21 dBm IEEE 802.11ac MCS0/Nss1 (VHT40): 24.26 dBm IEEE 802.11ac MCS0/Nss1 (VHT80): 15.23 dBm
Carrier Frequencies	Please refer to section 3.4

Antenna	Please refer to section 3.3
---------	-----------------------------

Items	Description	
Communication Mode	<input checked="" type="checkbox"/> IP Based (Load Based)	<input type="checkbox"/> Frame Based
Beamforming Function	<input checked="" type="checkbox"/> With beamforming	<input type="checkbox"/> Without beamforming
Operating Mode	<input type="checkbox"/> Outdoor access point	
	<input checked="" type="checkbox"/> Indoor access point	
	<input type="checkbox"/> Fixed point-to-point access points	
	<input type="checkbox"/> Mobile and portable client devices	

Note1: The product has beamforming function for 802.11n/ac in 2.4G/5G.

Note2: Test results of non-beamforming are recorded in test report: FR720735-01AB. Test results of beamforming are recorded in this test report.

Antenna and Band width

Antenna	Four (TX)		
	20 MHz	40 MHz	80 MHz
IEEE 802.11a	V	X	X
IEEE 802.11n	V	V	X
IEEE 802.11ac	V	V	V

IEEE 11n/ac Spec.

Protocol	Number of Transmit Chains (NTX)	Data Rate / MCS
802.11n (HT20)	4	MCS 0-31
802.11n (HT40)	4	MCS 0-31
802.11ac (VHT20)	4	MCS 0-8/Nss1-4
802.11ac (VHT40)	4	MCS 0-9/Nss1-4
802.11ac (VHT80)	4	MCS 0-9/Nss1-4

Note 1: IEEE Std. 802.11n modulation consists of HT20 and HT40 (HT: High Throughput).

Then EUT supports HT20 and HT40.

Note 2: IEEE Std. 802.11ac modulation consists of VHT20, VHT40, VHT80 and VHT160 (VHT: Very High Throughput). Then EUT supports VHT20, VHT40 and VHT80 in 5GHz.

Note 3: Modulation modes consist of below configuration:

HT20/HT40: IEEE 802.11n, VHT20/VHT40/VHT80: IEEE 802.11ac

3.2. Accessories

N/A

3.3. Table for Filed Antenna

Set.	Brand Holder	Model Number (Part No.)	Extreme Part No. (Short Description)	Antenna Type	Connector	Polarized Antenna	Gain (dBi)	
							2.4GHz	5GHz
1	Senao Networks, Inc.	AP3935i	-	PIFA Antenna	IPEX	X	Note 1	

Note1:

Set.	Antenna Gain (dBi)							
	2.4GHz				5GHz			
	Chain 1	Chain 2	Chain 3	Chain 4	Chain 1	Chain 2	Chain 3	Chain 4
1	3.81	3.75	3.98	3.47	5.84	5.50	5.84	5.65

<For 2.4GHz Function>

For IEEE 802.11b/g/n/ac mode (4TX, 4RX):

Chain 1, Chain 2, Chain 3 and Chain 4 could transmit/receive simultaneously.

<For 5GHz Function>

For IEEE 802.11a/n/ac mode (4TX, 4RX):

Chain 1, Chain 2, Chain 3 and Chain 4 could transmit/receive simultaneously.

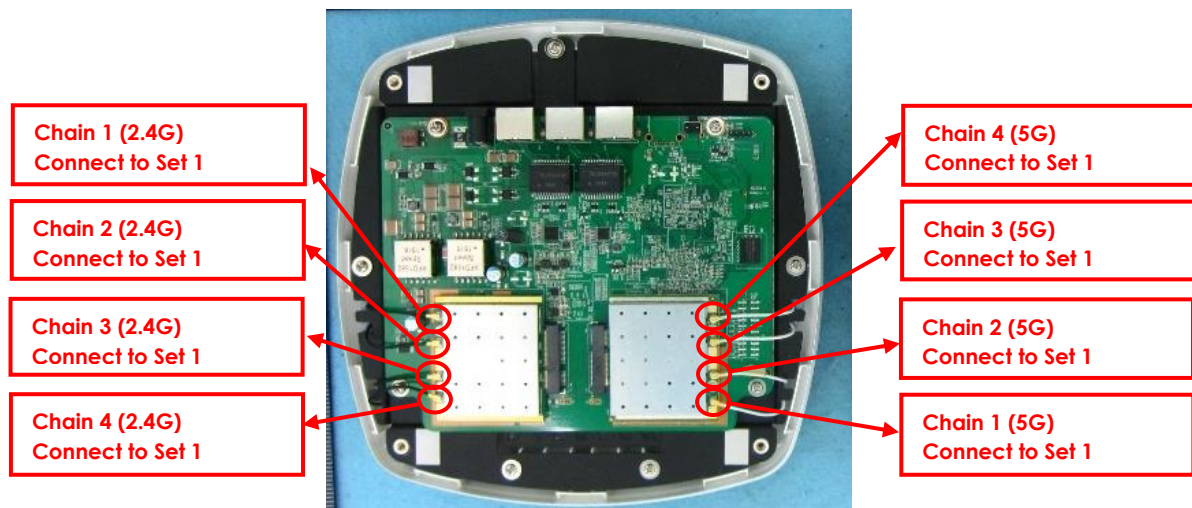

3.4. Table for Carrier Frequencies

There are three bandwidth systems.

For 20MHz bandwidth systems, use Channel 36, 40, 44, 48, 149, 153, 157, 161, 165.

For 40MHz bandwidth systems, use Channel 38, 46, 151, 159.

For 80MHz bandwidth systems, use Channel 42, 155.

Frequency Band	Channel No.	Frequency	Channel No.	Frequency
5150~5250 MHz Band 1	36	5180 MHz	44	5220 MHz
	38	5190 MHz	46	5230 MHz
	40	5200 MHz	48	5240 MHz
	42	5210 MHz	-	-
5725~5850 MHz Band 4	149	5745 MHz	157	5785 MHz
	151	5755 MHz	159	5795 MHz
	153	5765 MHz	161	5805 MHz
	155	5775 MHz	165	5825 MHz

3.5. Table for Test Modes

Preliminary tests were performed in different data rate to find the worst radiated emission. The data rate shown in the table below is the worst-case rate with respect to the specific test item. Investigation has been done on all the possible configurations for searching the worst cases. The following table is a list of the test modes shown in this test report.

Test Items	Mode		Data Rate	Channel	Chain
AC Power Conducted Emission	Normal Link		-	-	-
Max. Conducted Output Power	11ac VHT20	Band 1&4	MCS0/Nss 1	36/40/48/149/ 157/165	1+2+3+4
	11ac VHT40	Band 1&4	MCS0/Nss 1	38/46/151/15 9	1+2+3+4
	11ac VHT80	Band 1&4	MCS0/Nss 1	42/155	1+2+3+4
Power Spectral Density	11ac VHT20	Band 1&4	MCS0/Nss 1	36/40/48/149/ 157/165	1+2+3+4
	11ac VHT40	Band 1&4	MCS0/Nss 1	38/46/151/15 9	1+2+3+4
	11ac VHT80	Band 1&4	MCS0/Nss 1	42/155	1+2+3+4
26dB Spectrum Bandwidth & 99% Occupied Bandwidth Measurement	11ac VHT20	Band 1&4	MCS0/Nss 1	36/40/48/149/ 157/165	1+2+3+4
	11ac VHT40	Band 1&4	MCS0/Nss 1	38/46/151/15 9	1+2+3+4
	11ac VHT80	Band 1&4	MCS0/Nss 1	42/155	1+2+3+4
6dB Spectrum Bandwidth Measurement	11ac VHT20	Band 4	MCS0/Nss 1	149/157/165	1+2+3+4
	11ac VHT40	Band 4	MCS0/Nss 1	151/159	1+2+3+4
	11ac VHT80	Band 4	MCS0/Nss 1	155	1+2+3+4
Radiated Emission Below 1GHz	Normal Link		-	-	-
Radiated Emission Above 1GHz	11ac VHT20	Band 1&4	MCS0/Nss 1	36/40/48/149/ 157/165	1+2+3+4

	11ac VHT40	Band 1&4	MCS0/Nss 1	38/46/151/15 9	1+2+3+4
	11ac VHT80	Band 1&4	MCS0/Nss 1	42/155	1+2+3+4
Band Edge Emission	11ac VHT20	Band 1&4	MCS0/Nss 1	36/40/48/149/ 157/165	1+2+3+4
	11ac VHT40	Band 1&4	MCS0/Nss 1	38/46/151/15 9	1+2+3+4
	11ac VHT80	Band 1&4	MCS0/Nss 1	42/155	1+2+3+4
Frequency Stability	20 MHz	Band 1&4	-	40/157	3, 4
	40 MHz	Band 1&4	-	38/151	3, 4
	80 MHz	Band 1&4	-	42/155	3, 4

Note1: VHT20/VHT40 covers HT20/HT40, due to same modulation. The power setting for 802.11n HT20 and HT40 are the same or lower than 802.11ac VHT20 and VHT40.

Note2:

The adapter and PoE are for measurement only, would not be marketed.

The adapter and PoE information as below:

Power	Brand	Model
Adapter	APD	WA-24Q12R
PoE	Microsemi	PD-9001GR

Note3: All the specification of test configurations and test modes were based on customer's request.

Note4: The console port can not be used by end user. It is generally used for updating FW by professional installer.

The following test modes were performed for all tests:

For Conducted Emission test:

Mode 1. Normal Link + Adapter

For Radiated Emission Below 1GHz test:

Mode 1. Place EUT in Z axis + Adapter

Mode 2. Place EUT in Z axis + PoE

Mode 1 is the worst case, so it was selected to record in this test report.

For Radiated Emission Above 1GHz test:

The Mode 1 was performed at Y axis and Z axis position. Z axis has been evaluated to be the worst case, thus measurement will follow this same test mode.

Mode 1. Place EUT in Y axis

For Co-location MPE and Radiated Emission Co-location Test:

The EUT could be applied with 2.4GHz WLAN function and 5GHz WLAN function; therefore Co-location Maximum Permissible Exposure (Please refer to FA720735-01AB) and Radiated Emission Co-location (please refer to Appendix B) tests are added for simultaneously transmit between 2.4GHz WLAN function and 5GHz WLAN function.

3.6. Table for Testing Locations

Test Site Location					
Address:	No.8, Lane 724, Bo-ai St., Jhubei City, Hsinchu County 302, Taiwan, R.O.C.				
TEL:	886-3-656-9065				
FAX:	886-3-656-9085				
Test Site No.	Site Category	Location	FCC Reg. No.	IC File No.	VCCI Reg. No
03CH01-CB	SAC	Hsin Chu	262045	IC 4086D	-
TH01-CB	OVEN Room	Hsin Chu	-	-	-

Open Area Test Site (OATS); Semi Anechoic Chamber (SAC).

Testing Location			
<input checked="" type="checkbox"/>	HWA YA	ADD : No. 52, Huaya 1st Rd., Guishan Dist., Taoyuan City, Taiwan (R.O.C.)	
		TEL : 886-3-327-3456	FAX : 886-3-327-0973
Test site Designation No. TW1190 with FCC.			
Test site registered number IC 4086B-1 with Industry Canada.			

Test Condition	Test Site No.	Test Engineer	Test Environment	Test Date
Radiated	03CH02-HY	Thor Wei	23°C / 66%	12/Aug/2017
AC Conduction	CO04-HY	Teddy Chang	22°C / 55%	15/Aug/2017

3.7. Table for Supporting Units

For Test Site No: 03CH02-HY (For Below 1GHz)

Support Unit	Brand	Model	FCC ID
Load	-	-	N/A
Notebook	DELL	E6400	N/A
Adapter (Client Provided)	APD	WA-24Q12R	N/A

For Test Site No: 03CH01-CB (For Above 1GHz)

Support Unit	Brand	Model	FCC ID
Notebook*2	DELL	E4300	DoC
Device	Extreme Networks	31012	QXO-4411AC
Adapter (Client Provided)	APD	WA-24Q12R	N/A

For Test Site No: CO04-HY

Support Unit	Brand	Model	FCC ID
Adapter (Client Provided)	APD	WA-24Q12R	N/A
Dummy Load	-	-	N/A
Notebook	DELL	E5430	DoC
Notebook(2.4G)	DELL	P55G	DoC
Notebook(5G)	DELL	P55G	DoC

For Test Site No: TH01-CB

Support Unit	Brand	Model	FCC ID
Notebook	DELL	E4300	DoC
Adapter (Client Provided)	APD	WA-24Q12R	N/A

3.8. Table for Parameters of Test Software Setting

During testing, Channel and Power Controlling Software provided by the customer was used to control the operating channel as well as the output power level. The RF output power selection is for the setting of RF output power expected by the customer and is going to be fixed on the firmware of the final end product.

Mode 1: PIFA Antenna / Chain1:5.84 dBi, Chain2:5.50 dBi, Chain3:5.84 dBi, Chain4:5.65 dBi

Test Software Version	QCA VER3.0.144.0							
Mode	Test Frequency (MHz)							
	NCB: 20MHz							
	5180 MHz	5200 MHz	5240 MHz	5745 MHz	5785 MHz	5825 MHz		
802.11ac MCS0/Nss1 VHT20	18	18	18	17	18	18		
Mode	NCB: 40MHz							
802.11ac MCS0/Nss1 VHT40	5190 MHz		5230 MHz		5755 MHz		5795 MHz	
	15		17		11.5		17.5	
Mode	NCB: 80MHz							
802.11ac MCS0/Nss1 VHT80	5210 MHz			5775 MHz				
	9.5			9				

3.9. EUT Operation during Test

The EUT was programmed to be in continuously transmitting mode.

3.10. Duty Cycle

Mode	On Time (ms)	On+Off Time (ms)	Duty Cycle (%)	Duty Factor (dB)	1/T Minimum VBW (kHz)
802.11ac MCS0/Nss1 VHT20	1.770	1.940	91.24	0.40	0.56
802.11ac MCS0/Nss1 VHT40	1.664	1.840	90.43	0.44	0.60
802.11ac MCS0/Nss1 VHT80	1.920	2.224	86.33	0.64	0.52

3.11. Test Configurations

3.11.1. AC Power Line Conduction Emissions Test Configuration

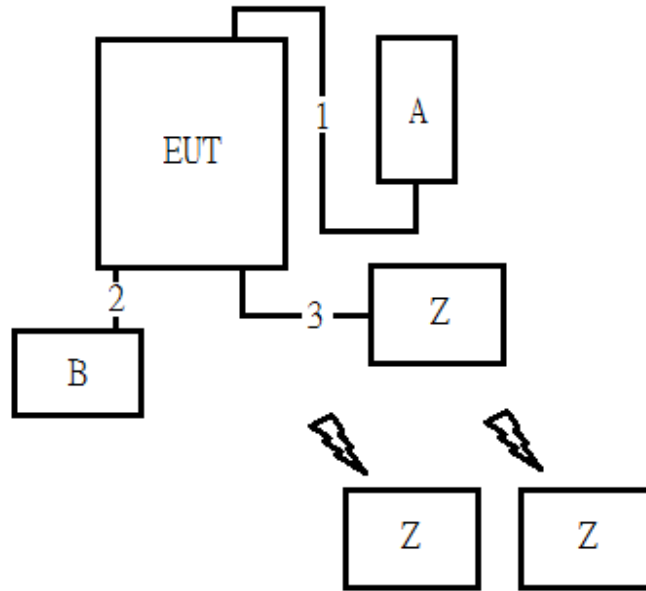

Item	Connection	Shielded	Length(m)
1	DC Power Cable	No	1.5
2	RJ45 Cable	No	1
3	RJ45 Cable	No	10

No.	Equipment	Brand	Model	FCC ID
A	Adapter	APD	WA-24Q12R	N/A
B	Dummy Load	-	-	N/A
Z	NoteBook	DELL	E5430	DoC
Z	NoteBook(2.4G)	DELL	P55G	DoC
Z	NoteBook(5G)	DELL	P55G	DoC

3.11.2. Radiation Emissions Test Configuration

Test Configuration: 30MHz ~1GHz

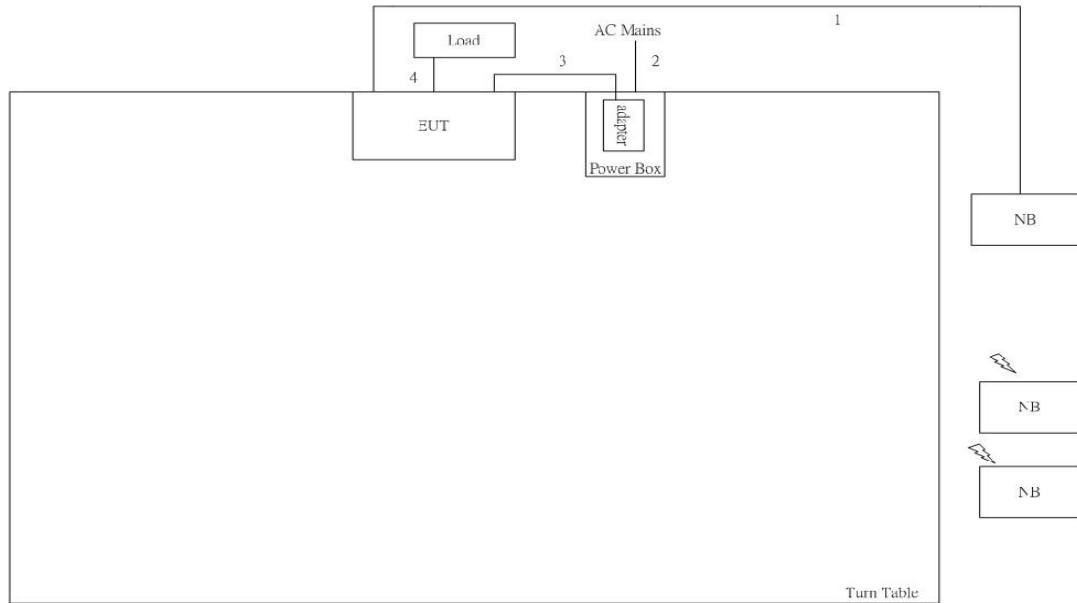

Item	Connection	Shielded	Length(m)
1	LAN Cable	No	10
2	AC Power line	No	1.8
3	DC Power line	No	1.5
4	LAN line	No	3

Test Configuration: above 1GHz

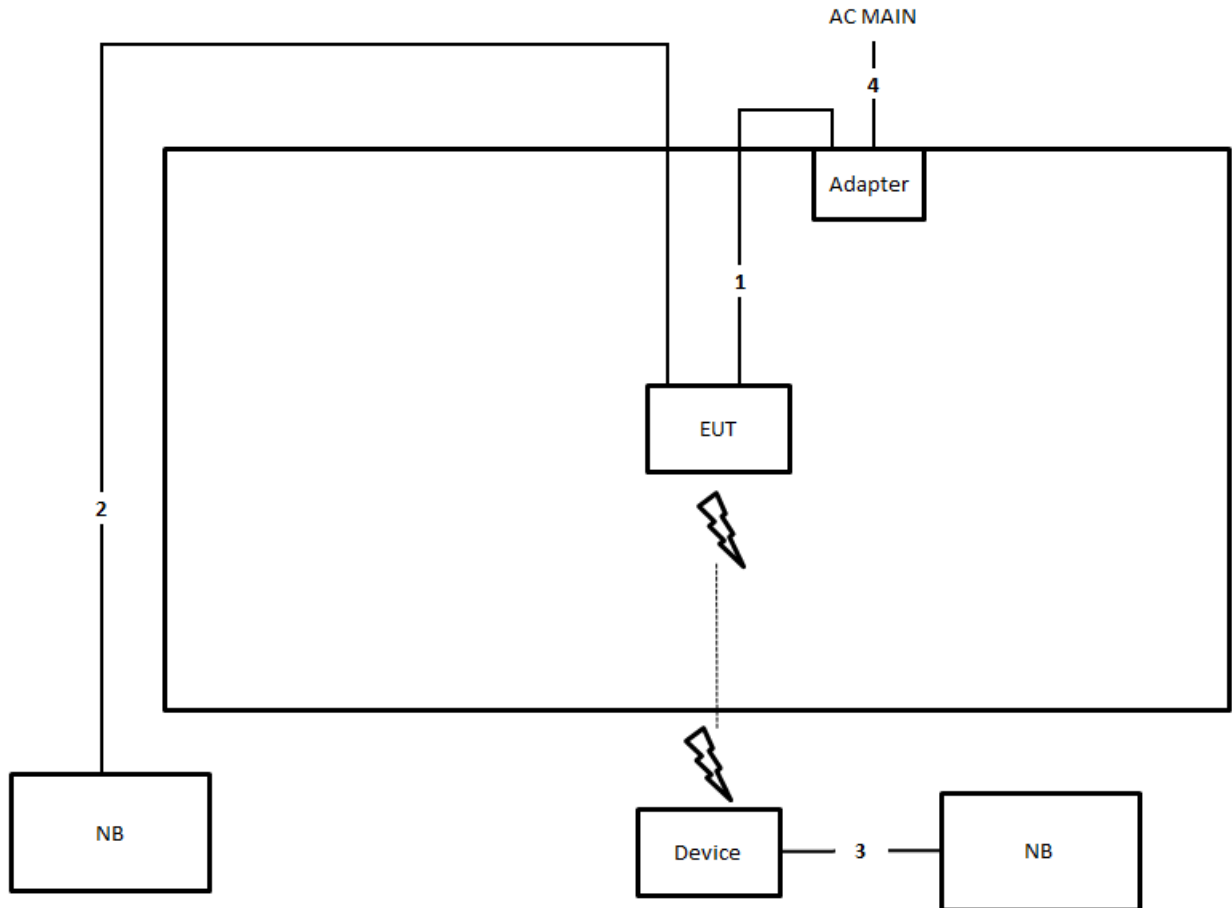

Item	Connection	Shielded	Length(m)
1	DC Power cable	No	1.2
2	RJ-45 cable	No	10
3	RJ-45 cable	No	1.5
4	AC Power cable	No	1.8

4. TEST RESULT

4.1. AC Power Line Conducted Emissions Measurement

4.1.1. Limit

For this product that is designed to connect to the AC power line, the radio frequency voltage that is conducted back onto the AC power line on any frequency or frequencies within the band 150 kHz to 30 MHz shall not exceed below limits table.

Frequency (MHz)	QP Limit (dBuV)	AV Limit (dBuV)
0.15~0.5	66~56	56~46
0.5~5	56	46
5~30	60	50

4.1.2. Measuring Instruments and Setting

Please refer to section 5 of equipments list in this report. The following table is the setting of the receiver.

Receiver Parameters	Setting
Attenuation	10 dB
Start Frequency	0.15 MHz
Stop Frequency	30 MHz
IF Bandwidth	9 kHz

4.1.3. Test Procedures

1. Configure the EUT according to ANSI C63.10. The EUT or host of EUT has to be placed 0.4 meter far from the conducting wall of the shielding room and at least 80 centimeters from any other grounded conducting surface.
2. Connect EUT or host of EUT to the power mains through a line impedance stabilization network (LISN).
3. All the support units are connected to the other LISNs. The LISN should provide 50uH/50ohms coupling impedance.
4. The frequency range from 150 kHz to 30 MHz was searched.
5. Set the test-receiver system to Peak Detect Function and Specified Bandwidth with Maximum Hold Mode.
6. The measurement has to be done between each power line and ground at the power terminal.

4.1.4. Test Setup Layout

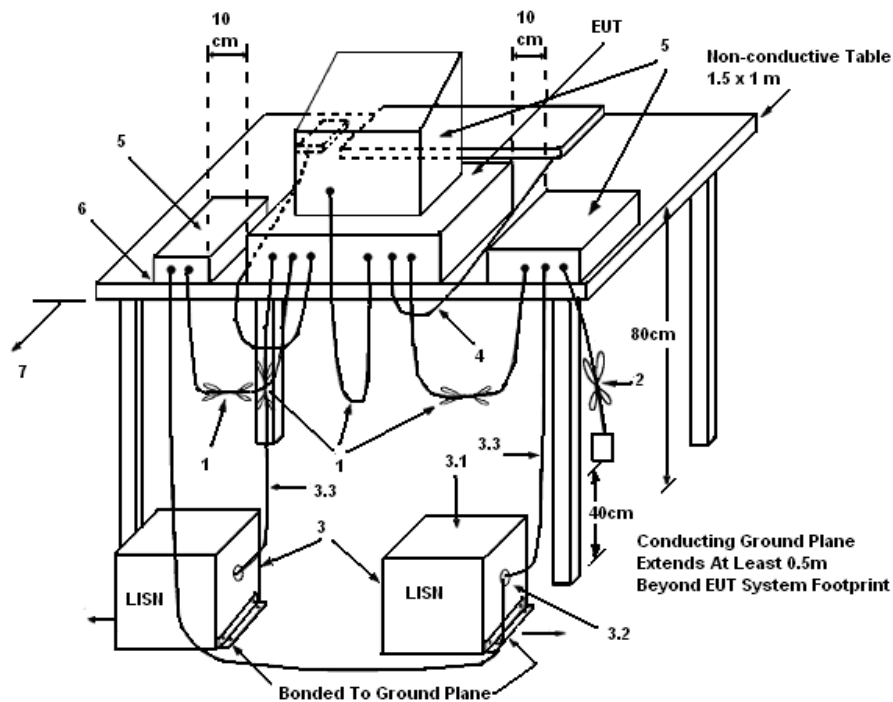

LEGEND:

- (1) Interconnecting cables that hang closer than 40 cm to the ground plane shall be folded back and forth in the center forming a bundle 30 to 40 cm long.
- (2) I/O cables that are not connected to a peripheral shall be bundled in the center. The end of the cable may be terminated, if required, using the correct terminating impedance. The overall length shall not exceed 1 m.
- (3) EUT connected to one LISN. Unused LISN measuring port connectors shall be terminated in 50 Ω . LISN can be placed on top of, or immediately beneath, reference ground plane.
 - (3.1) All other equipment powered from additional LISN(s).
 - (3.2) Multiple outlet strip can be used for multiple power cords of non-EUT equipment.
 - (3.3) LISN at least 80 cm from nearest part of EUT chassis.
- (4) Cables of hand-operated devices, such as keyboards, mice, etc., shall be placed as for normal use.
- (5) Non-EUT components of EUT system being tested.
- (6) Rear of EUT, including peripherals, shall all be aligned and flush with rear of tabletop.
- (7) Rear of tabletop shall be 40 cm removed from a vertical conducting plane that is bonded to the ground plane.

4.1.5. Test Deviation

There is no deviation with the original standard.

4.1.6. EUT Operation during Test

The EUT was placed on the test table and programmed in normal function.

4.1.7. Results of AC Power Line Conducted Emissions Measurement

Temperature	22°C	Humidity	55%
Test Engineer	Teddy Chang	Phase	Line
Configuration	Normal Link	Test Mode	Mode 1

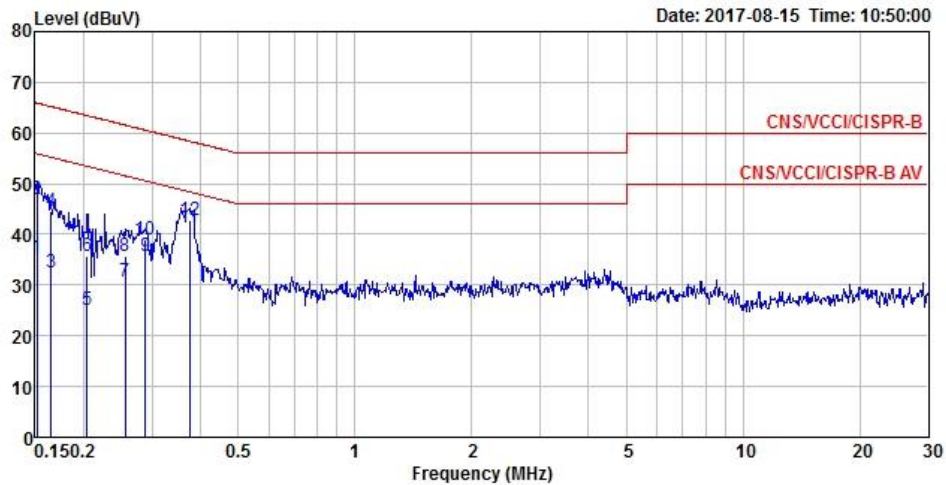

	Freq	Level	Over	Limit	Read	LISN	Cable	Remark
	MHz	dBuV	Limit	Line	Level	Factor	Loss	
			dB	dBuV	dBuV	dB	dB	
1	0.15	35.31	-20.60	55.91	25.43	9.66	0.22	Average
2	0.15	46.88	-19.03	65.91	37.00	9.66	0.22	QP
3	0.17	32.33	-22.88	55.21	22.42	9.66	0.25	Average
4	0.17	44.48	-20.73	65.21	34.57	9.66	0.25	QP
5	0.20	25.00	-28.45	53.45	15.06	9.65	0.29	Average
6	0.20	35.68	-27.77	63.45	25.74	9.65	0.29	QP
7	0.26	30.65	-20.91	51.56	20.76	9.66	0.23	Average
8	0.26	35.75	-25.81	61.56	25.86	9.66	0.23	QP
9	0.29	35.66	-14.93	50.59	25.79	9.67	0.20	Average
10	0.29	38.83	-21.76	60.59	28.96	9.67	0.20	QP
11 MAX	0.38	41.35	-7.04	48.39	31.55	9.68	0.12	Average
12	0.38	42.86	-15.53	58.39	33.06	9.68	0.12	QP

Temperature	22°C	Humidity	55%
Test Engineer	Teddy Chang	Phase	Neutral
Configuration	Normal Link	Test Mode	Mode 1

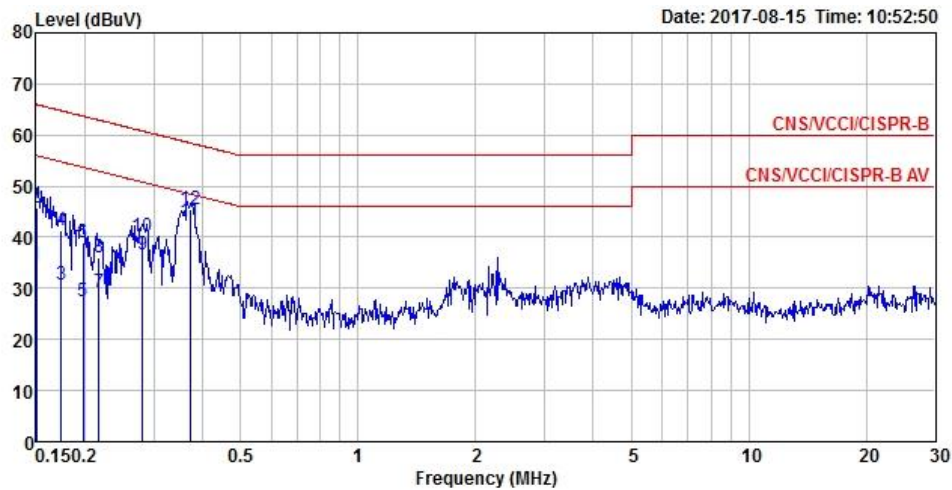

	Freq	Level	Over	Limit	Read	LISN	Cable	Remark
	MHz	dBuV	Limit	Line	Level	Factor	Loss	
			dB	dBuV	dBuV	dB	dB	
1	0.15	34.62	-21.38	56.00	24.80	9.60	0.22	Average
2	0.15	45.82	-20.18	66.00	36.00	9.60	0.22	QP
3	0.17	30.67	-24.10	54.77	20.77	9.64	0.26	Average
4	0.17	41.35	-23.42	64.77	31.45	9.64	0.26	QP
5	0.20	27.43	-26.28	53.71	17.46	9.67	0.30	Average
6	0.20	39.01	-24.70	63.71	29.04	9.67	0.30	QP
7	0.22	29.30	-23.62	52.92	19.37	9.66	0.27	Average
8	0.22	36.02	-26.90	62.92	26.09	9.66	0.27	QP
9	0.28	36.73	-14.08	50.81	26.88	9.65	0.20	Average
10	0.28	40.02	-20.79	60.81	30.17	9.65	0.20	QP
11 MAX	0.37	43.17	-5.30	48.47	33.42	9.63	0.12	Average
12	0.37	45.52	-12.95	58.47	35.77	9.63	0.12	QP

Note:

Level = Read Level + LISN Factor + Cable Loss.

4.2. 26dB Bandwidth and 99% Occupied Bandwidth Measurement

4.2.1. Limit

No restriction limits.

4.2.2. Measuring Instruments and Setting

Please refer to section 5 of equipments list in this report. The following table is the setting of the spectrum analyzer.

26dB Bandwidth	
Spectrum Parameters	Setting
Attenuation	Auto
Span Frequency	> 26dB Bandwidth
RBW	Approximately 1% of the emission bandwidth
VBW	VBW > RBW
Detector	Peak
Trace	Max Hold
Sweep Time	Auto
99% Occupied Bandwidth	
Spectrum Parameters	Setting
Span	1.5 times to 5.0 times the OBW
RBW	1 % to 5 % of the OBW
VBW	$\geq 3 \times$ RBW
Detector	Peak
Trace	Max Hold

4.2.3. Test Procedures

For Radiated 26dB Bandwidth and 99% Occupied Bandwidth Measurement:

1. The transmitter was radiated to the spectrum analyzer in peak hold mode.
2. Measure the maximum width of the emission that is 26 dB down from the peak of the emission. Compare this with the RBW setting of the analyzer. Readjust RBW and repeat measurement as needed until the RBW/EBW ratio is approximately 1%.

4.2.4. Test Setup Layout

For Radiated 26dB Bandwidth and 99% Occupied Bandwidth Measurement:

This test setup layout is the same as that shown in section 4.6.4.

4.2.5. Test Deviation

There is no deviation with the original standard.

4.2.6. EUT Operation during Test

The EUT was programmed to be in continuously transmitting mode.

4.2.7. Test Result of 26dB Bandwidth and 99% Occupied Bandwidth

Temperature	25°C	Humidity	50%
Test Engineer	Eddie Weng & Lucas Huang		
Test Mode	Mode 1: PIFA Antenna / Chain1:5.84 dBi, Chain2:5.50 dBi, Chain3:5.84 dBi, Chain4:5.65 dBi		

Mode	Frequency	26dB Bandwidth (MHz)	99% Occupied Bandwidth (MHz)
802.11ac MCS0/Nss1 VHT20	5180 MHz	22.70	18.06
	5200 MHz	22.87	18.06
	5240 MHz	22.87	18.06
	5745 MHz	22.17	17.97
	5785 MHz	22.26	18.06
	5825 MHz	22.17	18.06
802.11ac MCS0/Nss1 VHT40	5190 MHz	44.06	37.05
	5230 MHz	44.49	37.19
	5755 MHz	43.77	37.19
	5795 MHz	49.28	37.19
802.11ac MCS0/Nss1 VHT80	5210 MHz	85.22	76.12
	5775 MHz	86.67	76.41

**Mode 1: PIFA Antenna / Chain1:5.84 dBi, Chain2:5.50 dBi, Chain3:5.84 dBi, Chain4:5.65 dBi
26dB Bandwidth and 99% Occupied Bandwidth Plot on Configuration IEEE 802.11ac MCS0/Nss1
VHT20 / Chain 1 + Chain 2 + Chain 3 + Chain 4 / 5180 MHz**

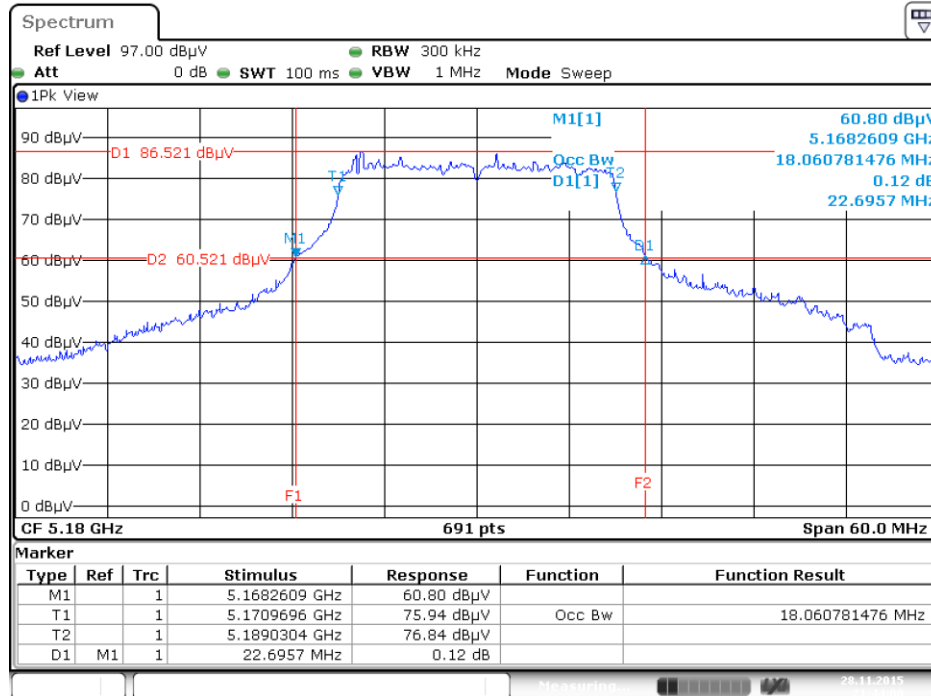

Date: 28.NOV.2015 21:44:00

**26dB Bandwidth and 99% Occupied Bandwidth Plot on Configuration IEEE 802.11ac MCS0/Nss1
VHT20 / Chain 1 + Chain 2 + Chain 3 + Chain 4 / 5200 MHz**

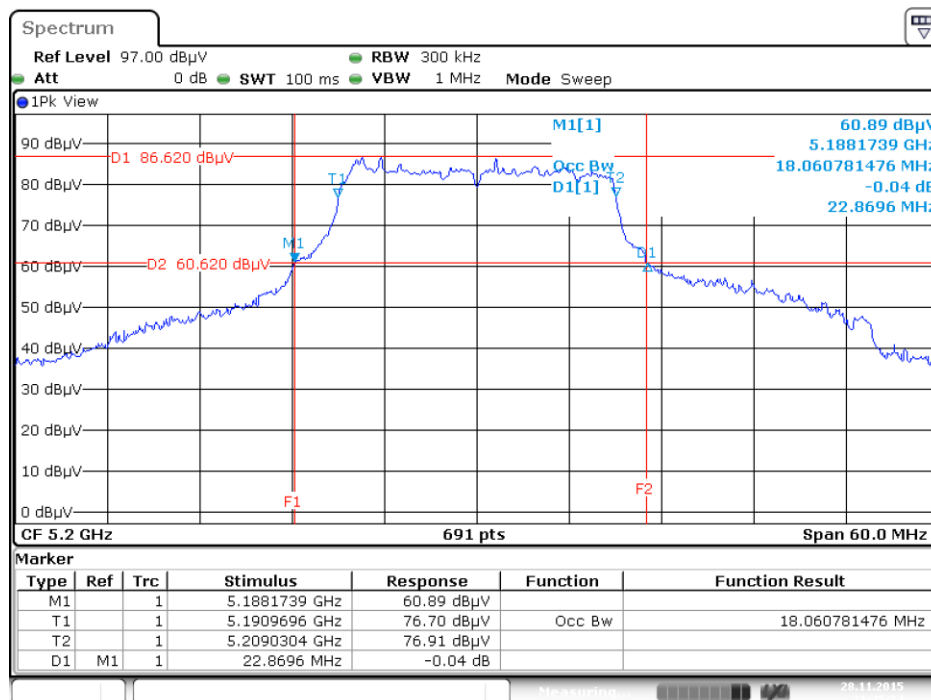

Date: 28.NOV.2015 21:45:24

26dB Bandwidth and 99% Occupied Bandwidth Plot on Configuration IEEE 802.11ac MCS0/Nss1 VHT20 / Chain 1 + Chain 2 + Chain 3 + Chain 4 / 5240 MHz

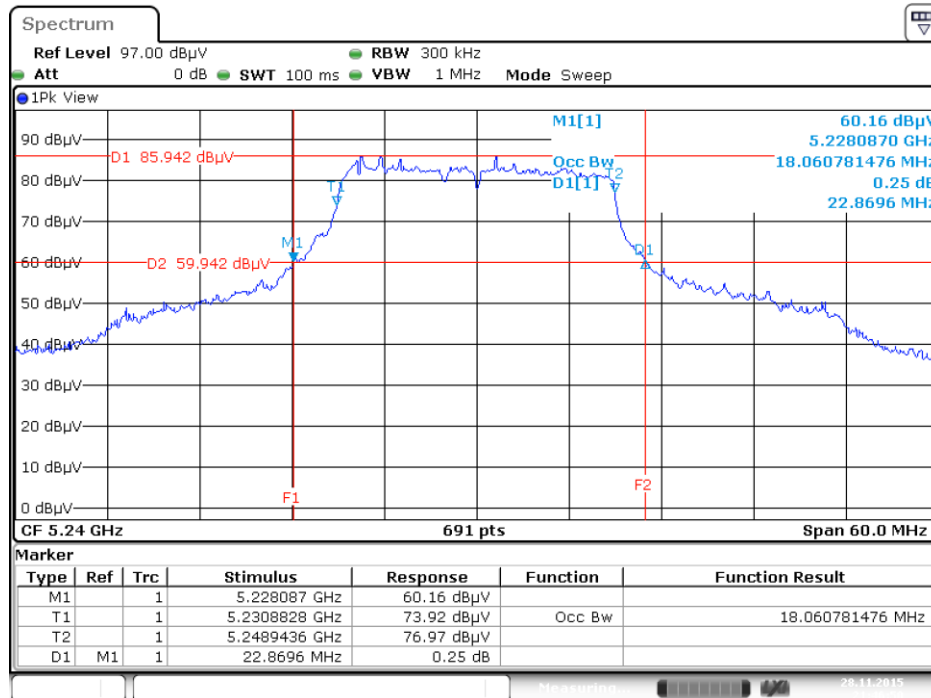

Date: 28.NOV.2015 21:46:50

26dB Bandwidth and 99% Occupied Bandwidth Plot on Configuration IEEE 802.11ac MCS0/Nss1 VHT20 / Chain 1 + Chain 2 + Chain 3 + Chain 4 / 5745 MHz

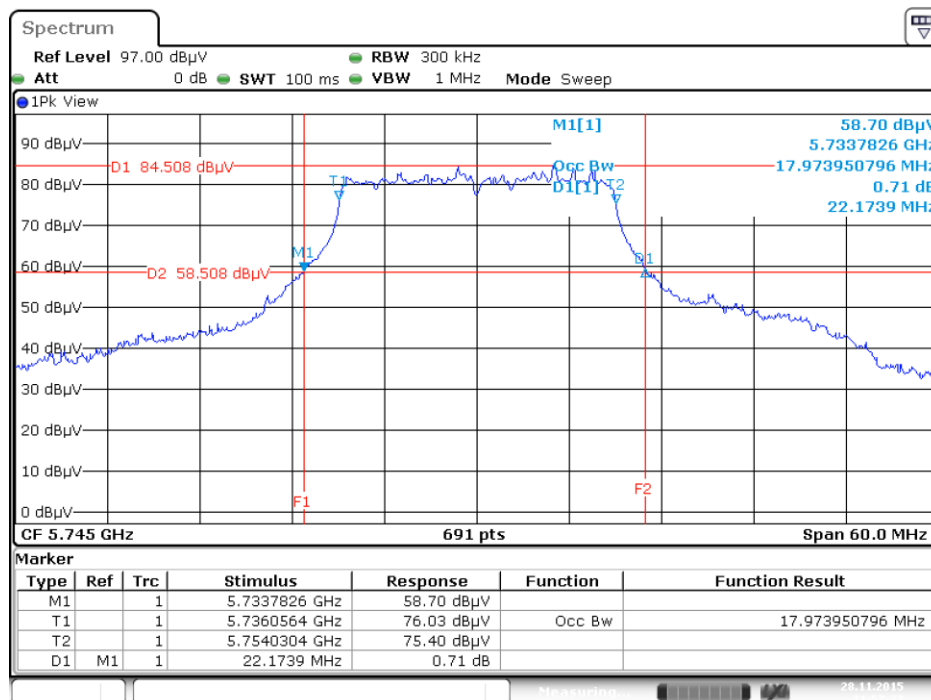

Date: 28.NOV.2015 21:57:27

26dB Bandwidth and 99% Occupied Bandwidth Plot on Configuration IEEE 802.11ac MCS0/Nss1 VHT20 / Chain 1 + Chain 2 + Chain 3 + Chain 4 / 5785 MHz

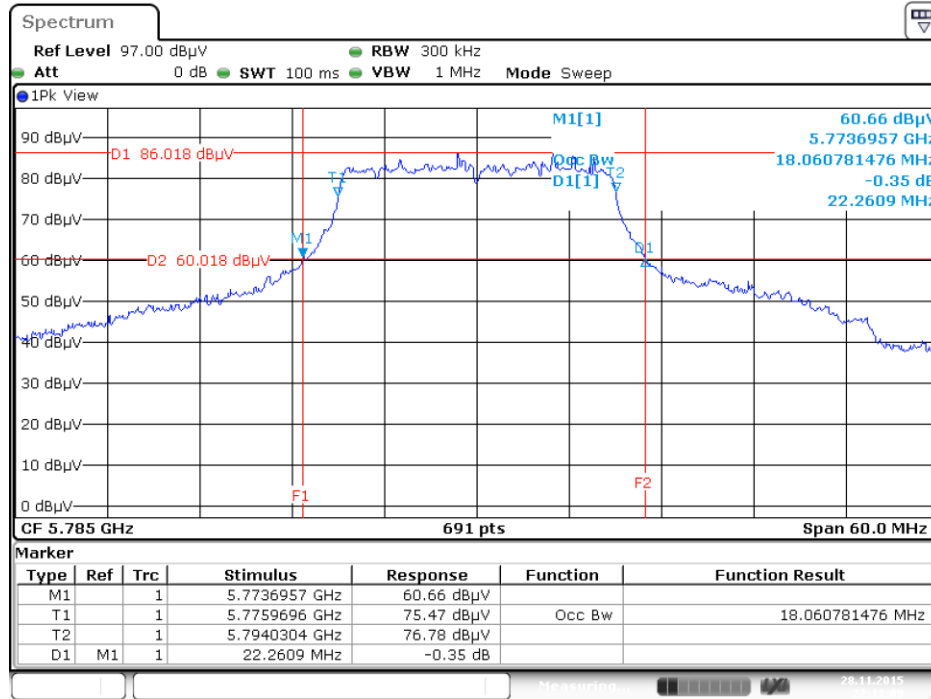

Date: 28.NOV.2015 22:11:09

26dB Bandwidth and 99% Occupied Bandwidth Plot on Configuration IEEE 802.11ac MCS0/Nss1 VHT20 / Chain 1 + Chain 2 + Chain 3 + Chain 4 / 5825 MHz

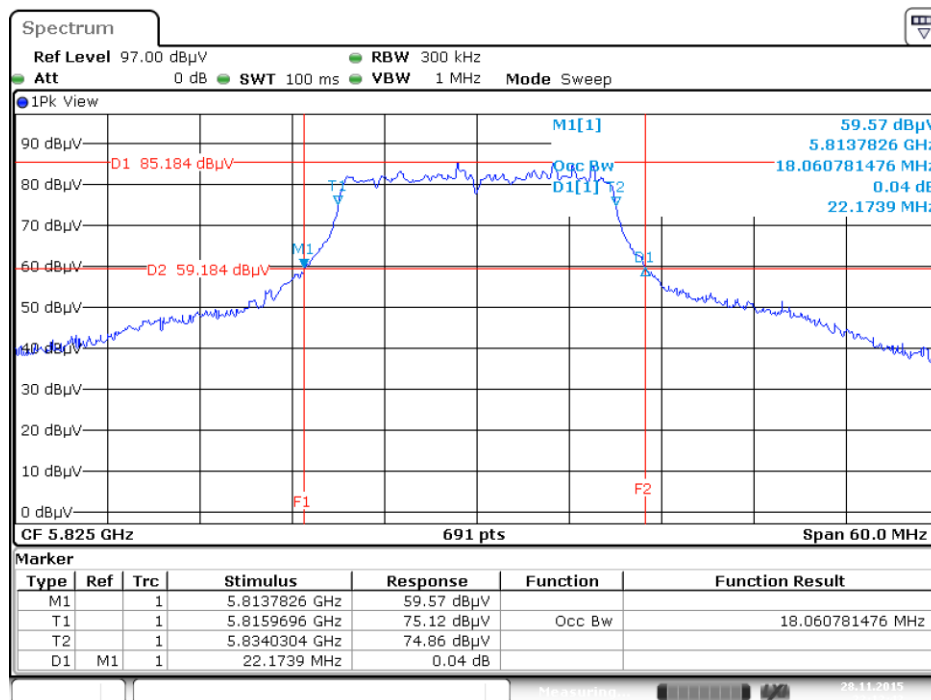

Date: 28.NOV.2015 22:12:42

26dB Bandwidth and 99% Occupied Bandwidth Plot on Configuration IEEE 802.11ac MCS0/Nss1 VHT40 / Chain 1 + Chain 2 + Chain 3 + Chain 4 / 5190 MHz

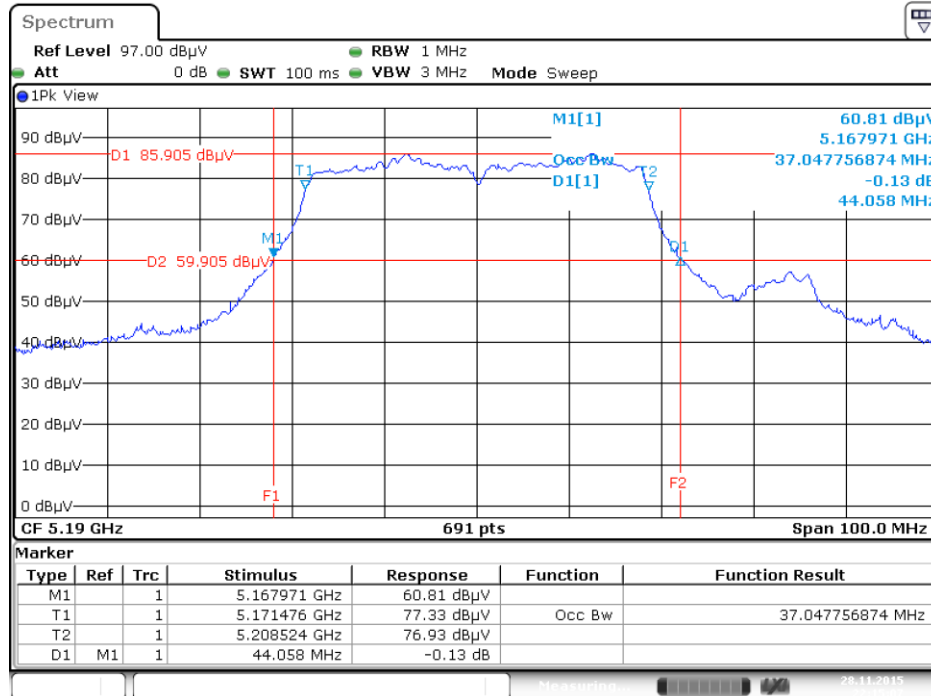

Date: 28.NOV.2015 22:15:07

26dB Bandwidth and 99% Occupied Bandwidth Plot on Configuration IEEE 802.11ac MCS0/Nss1 VHT40 / Chain 1 + Chain 2 + Chain 3 + Chain 4 / 5230 MHz

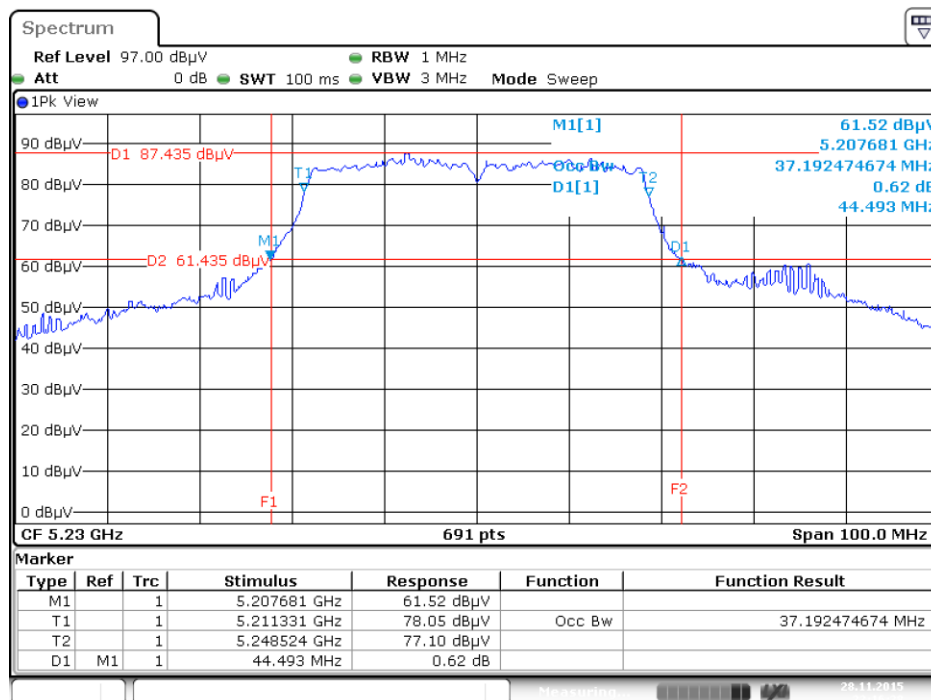

Date: 28.NOV.2015 22:16:28

26dB Bandwidth and 99% Occupied Bandwidth Plot on Configuration IEEE 802.11ac MCS0/Nss1 VHT40 / Chain 1 + Chain 2 + Chain 3 + Chain 4 / 5755 MHz

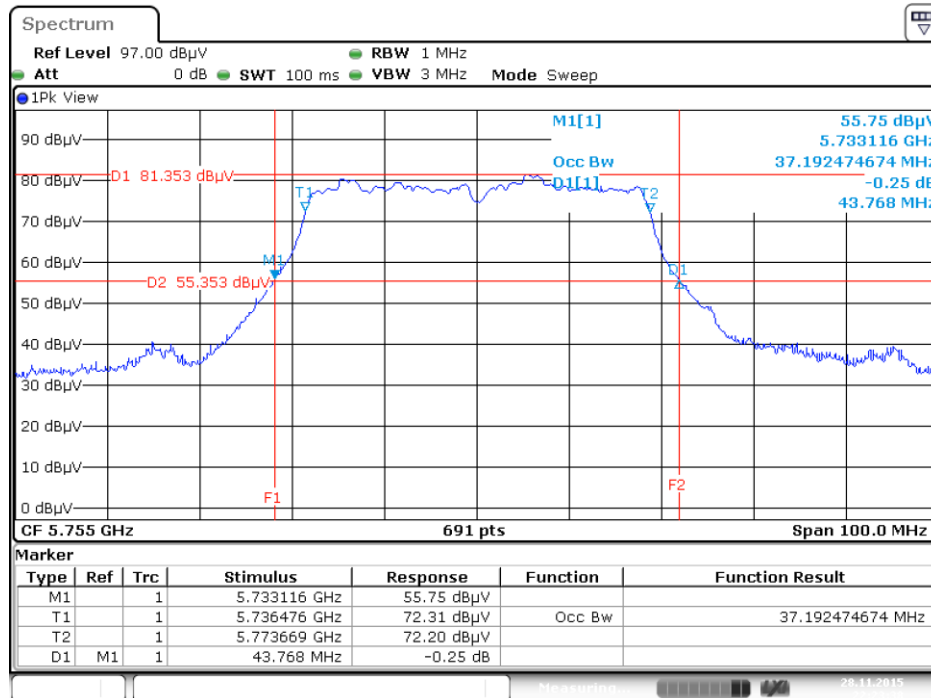

Date: 28.NOV.2015 22:23:38

26dB Bandwidth and 99% Occupied Bandwidth Plot on Configuration IEEE 802.11ac MCS0/Nss1 VHT40 / Chain 1 + Chain 2 + Chain 3 + Chain 4 / 5795 MHz

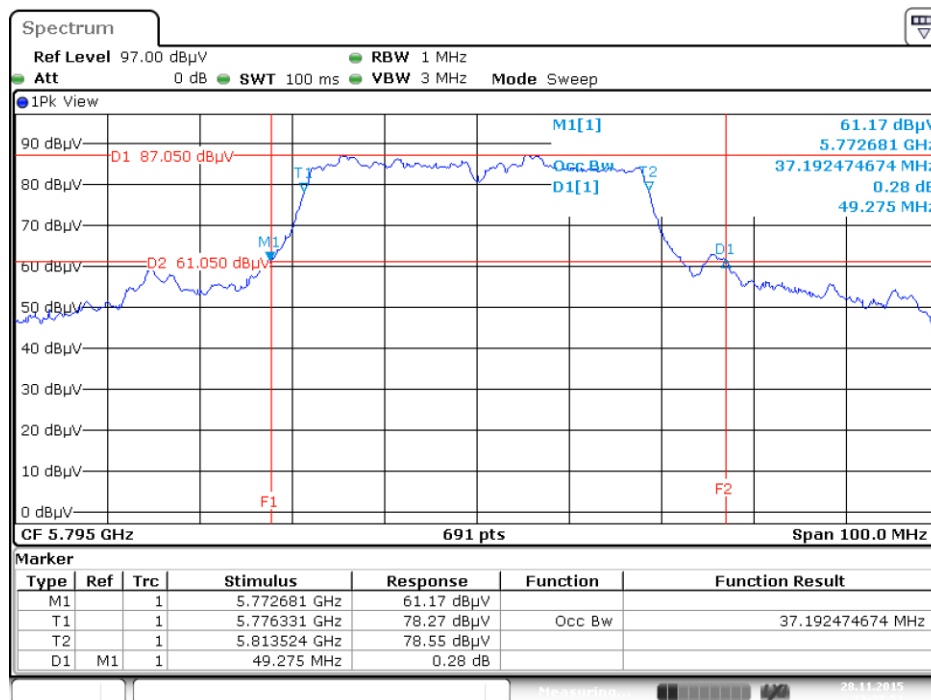

Date: 28.NOV.2015 22:27:51

26dB Bandwidth and 99% Occupied Bandwidth Plot on Configuration IEEE 802.11ac MCS0/Nss1 VHT80 / Chain 1 + Chain 2 + Chain 3 + Chain 4 / 5210 MHz

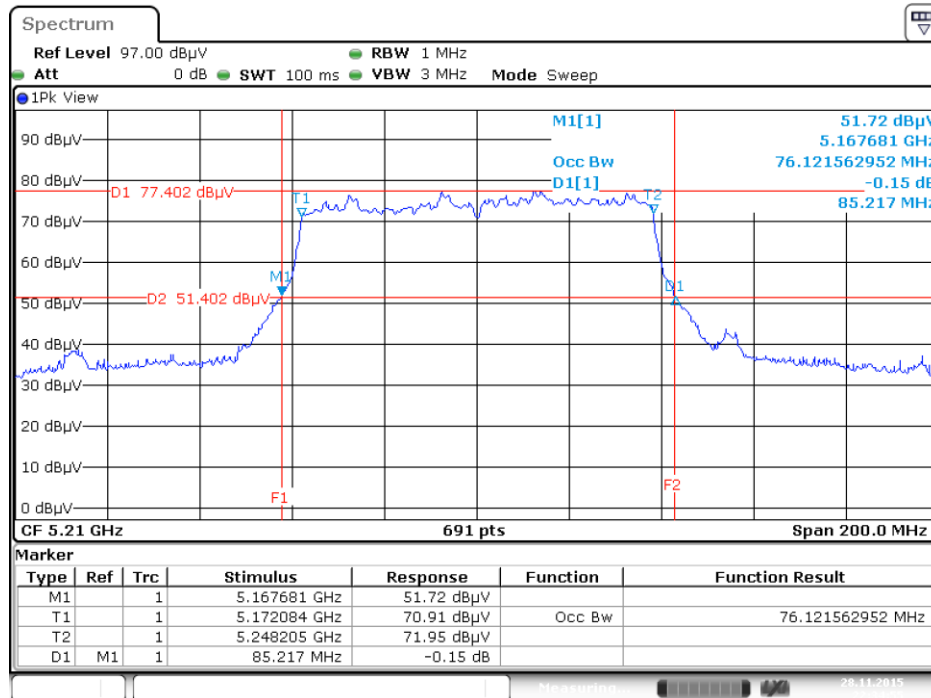

Date: 28.NOV.2015 22:34:55

26dB Bandwidth and 99% Occupied Bandwidth Plot on Configuration IEEE 802.11ac MCS0/Nss1 VHT80 / Chain 1 + Chain 2 + Chain 3 + Chain 4 / 5775 MHz

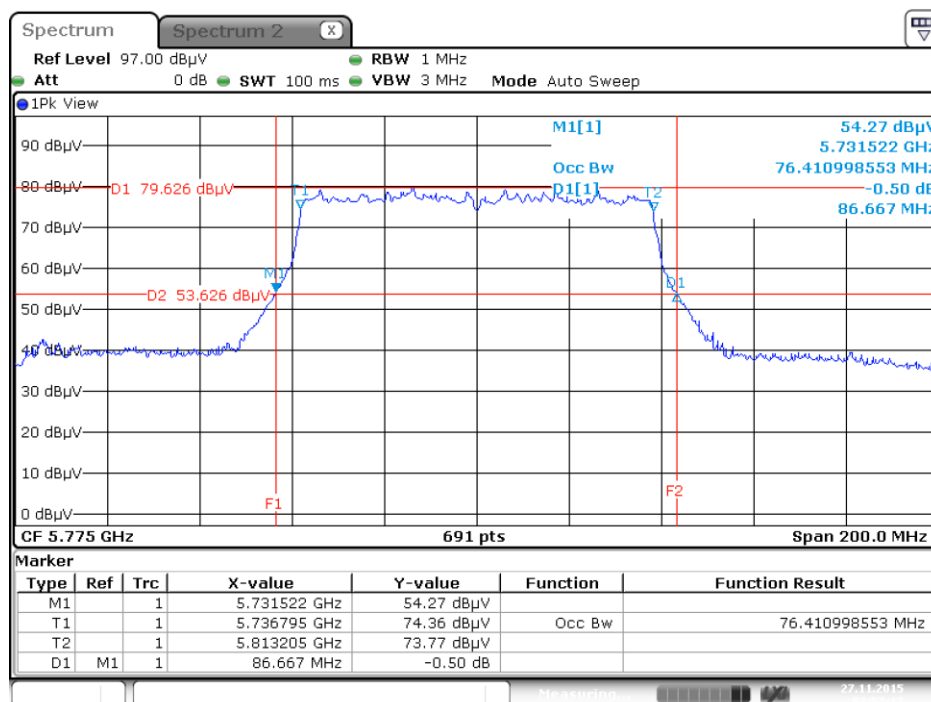

Date: 27.NOV.2015 02:57:17

4.3. 6dB Spectrum Bandwidth Measurement

4.3.1. Limit

For digital modulation systems, the minimum 6dB bandwidth shall be at least 500 kHz.

4.3.2. Measuring Instruments and Setting

Please refer to section 5 of equipments list in this report. The following table is the setting of spectrum analyzer.

6dB Spectrum Bandwidth	
Spectrum Parameters	Setting
Attenuation	Auto
Span Frequency	> 6dB Bandwidth
RBW	100kHz
VBW	$\geq 3 \times \text{RBW}$
Detector	Peak
Trace	Max Hold
Sweep Time	Auto

4.3.3. Test Procedures

For Radiated 6dB Bandwidth Measurement:

1. The transmitter was radiated to the spectrum analyzer in peak hold mode.
2. Test was performed in accordance with KDB789033 D02 v01 for Compliance Testing of Unlicensed National Information Infrastructure (U-NII) Devices - section (C) Emission Bandwidth.
3. Multiple antenna system was performed in accordance with KDB662911 D01 v02r01 Emissions Testing of Transmitters with Multiple Outputs in the Same Band.
4. Measured the spectrum width with power higher than 6dB below carrier.

4.3.4. Test Setup Layout

For Radiated 6dB Bandwidth Measurement:

This test setup layout is the same as that shown in section 4.6.4.

4.3.5. Test Deviation

There is no deviation with the original standard.

4.3.6. EUT Operation during Test

The EUT was programmed to be in continuously transmitting mode.

4.3.7. Test Result of 6dB Spectrum Bandwidth

Temperature	25°C	Humidity	50%
Test Engineer	Eddie Weng & Lucas Huang		
Test Mode	Mode 1: PIFA Antenna / Chain1:5.84 dBi, Chain2:5.50 dBi, Chain3:5.84 dBi, Chain4:5.65 dBi		

Mode	Frequency	6dB Bandwidth (MHz)	Min. Limit (kHz)	Test Result
802.11ac MCS0/Nss1 VHT20	5745 MHz	16.35	500	Complies
	5785 MHz	15.01	500	Complies
	5825 MHz	12.58	500	Complies
802.11ac MCS0/Nss1 VHT40	5755 MHz	25.16	500	Complies
	5795 MHz	31.42	500	Complies
802.11ac MCS0/Nss1 VHT80	5775 MHz	71.30	500	Complies

Note: All the test values were listed in the report.

For plots, only the channel with worse result was shown.

Mode 1: PIFA Antenna / Chain1:5.84 dBi, Chain2:5.50 dBi, Chain3:5.84 dBi, Chain4:5.65 dBi

6 dB Bandwidth Plot on Configuration IEEE 802.11ac MCS0/Nss1 VHT20 / Chain 1 + Chain 2 + Chain 3 + Chain 4 / 5825 MHz

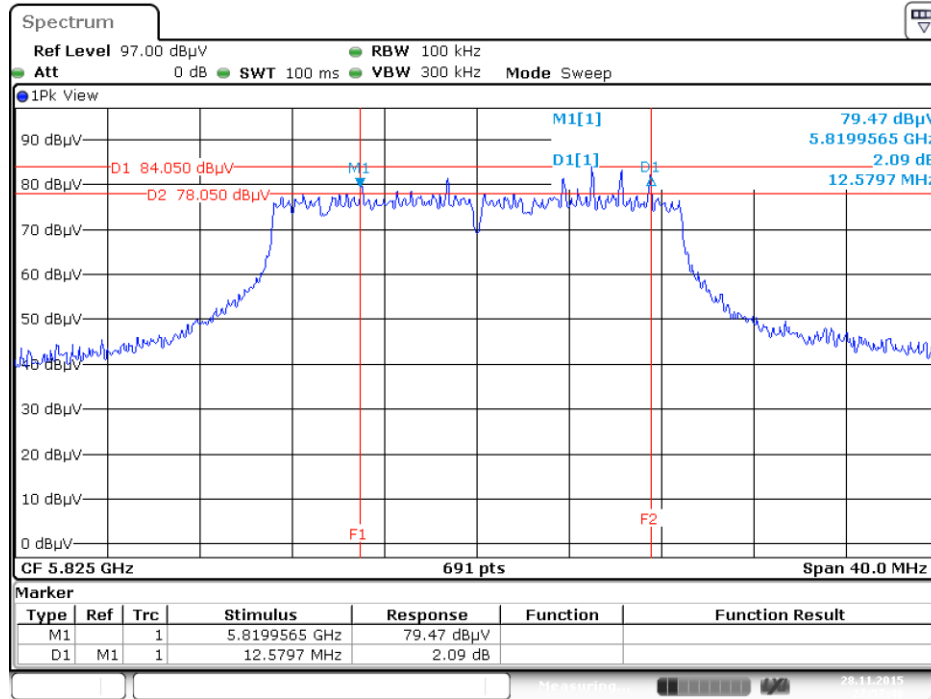

Date: 28.NOV.2015 22:57:48

6 dB Bandwidth Plot on Configuration IEEE 802.11ac MCS0/Nss1 VHT40 / Chain 1 + Chain 2 + Chain 3 + Chain 4 / 5755 MHz

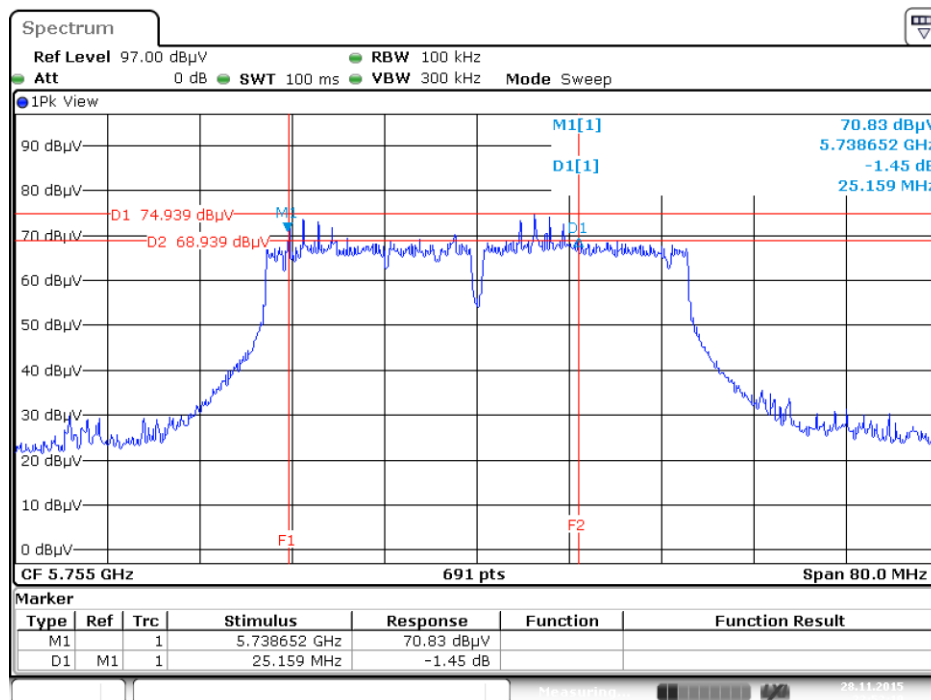

Date: 28.NOV.2015 22:52:11

6 dB Bandwidth Plot on Configuration IEEE 802.11ac MCS0/Nss1 VHT80 / Chain 1 + Chain 2 + Chain 3 + Chain 4 / 5775 MHz

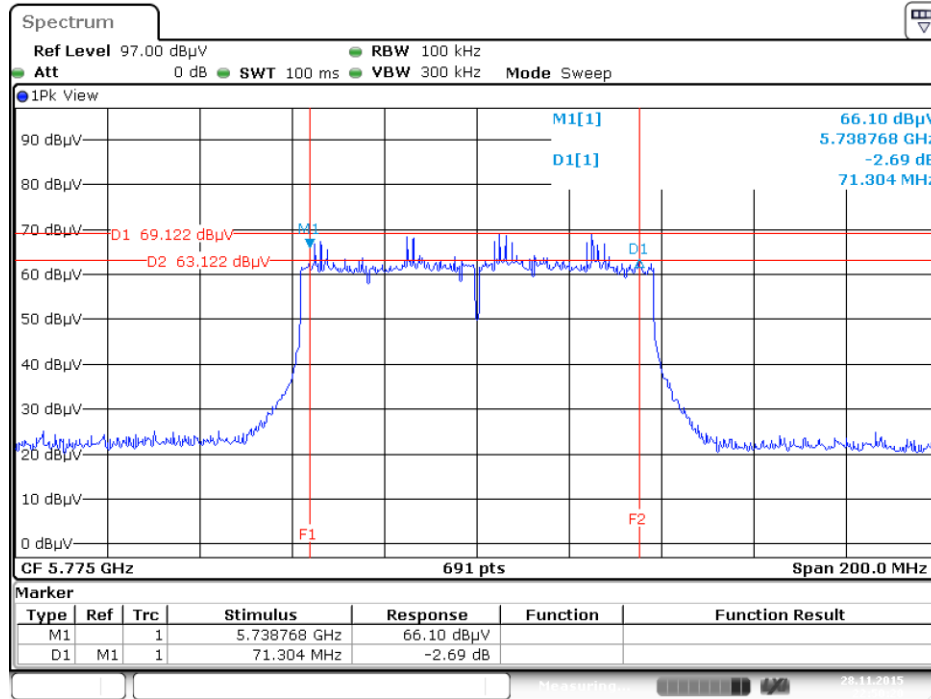

Date: 28.NOV.2015 22:50:21

4.4. Maximum Conducted Output Power Measurement

4.4.1. Limit

Frequency Band	Limit
<input checked="" type="checkbox"/> 5.15~5.25 GHz	
Operating Mode	
<input type="checkbox"/> Outdoor access point	<p>The maximum conducted output power over the frequency band of operation shall not exceed 1 W (30dBm) provided the maximum antenna gain does not exceed 6 dBi. If transmitting antennas of directional gain greater than 6 dBi are used, both the maximum conducted output power and the maximum power spectral density shall be reduced by the amount in dB that the directional gain of the antenna exceeds 6 dBi. The maximum e.i.r.p. at any elevation angle above 30 degrees as measured from the horizon must not exceed 125 mW (21 dBm).</p>
<input checked="" type="checkbox"/> Indoor access point	<p>The maximum conducted output power over the frequency band of operation shall not exceed 1 W (30dBm) provided the maximum antenna gain does not exceed 6 dBi. If transmitting antennas of directional gain greater than 6 dBi are used, both the maximum conducted output power and the maximum power spectral density shall be reduced by the amount in dB that the directional gain of the antenna exceeds 6 dBi.</p>
<input type="checkbox"/> Fixed point-to-point access points	<p>The maximum conducted output power over the frequency band of operation shall not exceed 1 W (30dBm). Fixed point-to-point U-NII devices may employ antennas with directional gain up to 23 dBi without any corresponding reduction in the maximum conducted output power or maximum power spectral density. For fixed point-to-point transmitters that employ a directional antenna gain greater than 23 dBi, a 1 dB reduction in maximum conducted output power and maximum power spectral density is required for each 1 dB of antenna gain in excess of 23 dBi.</p>
<input type="checkbox"/> Mobile and portable client devices	<p>The maximum conducted output power over the frequency band of operation shall not exceed 250 mW (24dBm) provided the maximum antenna gain does not exceed 6 dBi. If transmitting antennas of directional gain greater than 6 dBi are used, both the maximum conducted output power and the maximum power spectral density shall be reduced by the amount in dB that the directional gain of the antenna exceeds 6 dBi.</p>

☒	5.725~5.85 GHz	The maximum conducted output power over the frequency band of operation shall not exceed 1 W (30dBm). If transmitting antennas of directional gain greater than 6 dBi are used, both the maximum conducted output power and the maximum power spectral density shall be reduced by the amount in dB that the directional gain of the antenna exceeds 6 dBi. However, fixed point-to-point U-NII devices operating in this band may employ transmitting antennas with directional gain greater than 6 dBi without any corresponding reduction in transmitter conducted power.
---	----------------	--

4.4.2. Measuring Instruments and Setting

Please refer to section 5 of equipments list in this report. The following table is the setting of the power meter.

Power Meter Parameter	Setting
Detector	AVERAGE

4.4.3. Test Procedures

1. The transmitter output (antenna port) was connected to the power meter.
2. Test was performed in accordance with KDB789033 D02 v01 for Compliance Testing of Unlicensed National Information Infrastructure (U-NII) Devices - section (E) Maximum conducted output power =>3. Measurement using a Power Meter (PM) =>b) Method PM-G (Measurement using a gated RF average power meter).
3. Multiple antenna systems was performed in accordance with KDB662911 D01 v02r01 Emissions Testing of Transmitters with Multiple Outputs in the Same Band.
4. When measuring maximum conducted output power with multiple antenna systems, add every result of the values by mathematic formula.

4.4.4. Test Setup Layout

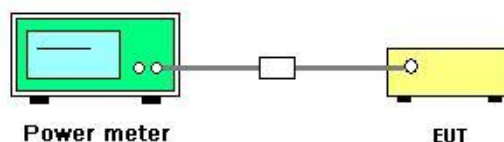

4.4.5. Test Deviation

There is no deviation with the original standard.

4.4.6. EUT Operation during Test

The EUT was programmed to be in continuously transmitting mode.

4.4.7. Test Result of Maximum Conducted Output Power

Temperature	25°C	Humidity	50%
Test Engineer	Eddie Weng & Lucas Huang	Test Date	Nov. 28, 2015
Test Mode	Mode 1: PIFA Antenna / Chain1:5.84 dBi, Chain2:5.50 dBi, Chain3:5.84 dBi, Chain4:5.65 dBi		

Mode	Frequency	Conducted Power (dBm)					Max. Limit (dBm)	Result
		Chain 1	Chain 2	Chain 3	Chain 4	Total		
802.11ac MCS0/Nss1 VHT20	5180 MHz	18.05	18.37	17.92	18.01	24.11	24.27	Complies
	5200 MHz	18.05	18.19	17.99	18.22	24.13	24.27	Complies
	5240 MHz	18.05	18.17	18.22	18.43	24.24	24.27	Complies
	5745 MHz	16.90	16.67	16.97	16.89	22.88	24.27	Complies
	5785 MHz	17.89	18.02	18.12	17.95	24.02	24.27	Complies
	5825 MHz	18.55	18.39	18.02	17.75	24.21	24.27	Complies
802.11ac MCS0/Nss1 VHT40	5190 MHz	15.79	15.81	15.93	15.74	21.84	24.27	Complies
	5230 MHz	17.91	17.97	17.85	18.18	24.00	24.27	Complies
	5755 MHz	12.06	11.89	12.28	11.94	18.07	24.27	Complies
	5795 MHz	18.33	18.21	18.18	18.22	24.26	24.27	Complies
802.11ac MCS0/Nss1 VHT80	5210 MHz	9.64	9.95	9.74	9.58	15.75	24.27	Complies
	5775 MHz	9.15	9.10	9.40	9.18	15.23	24.27	Complies

Note: $DirectionalGain = 10 \cdot \log \left[\frac{\sum_{j=1}^{N_{SS}} \left\{ \sum_{k=1}^{N_{ANT}} g_{j,k} \right\}^2}{N_{ANT}} \right] = 11.73\text{dBi} > 6\text{dBi}$, So Limit = $30 - (11.73 - 6) = 24.27\text{dBm}$.

4.5. Power Spectral Density Measurement

4.5.1. Limit

The following table is power spectral density limits and decrease power density limit rule refer to section 4.4.1.

Frequency Band		Limit
<input checked="" type="checkbox"/>	5.15~5.25 GHz	
	Operating Mode	
<input type="checkbox"/>	Outdoor access point	17 dBm/MHz
<input checked="" type="checkbox"/>	Indoor access point	17 dBm/MHz
<input type="checkbox"/>	Fixed point-to-point access points	17 dBm/MHz
<input type="checkbox"/>	Mobile and portable client devices	11 dBm/MHz
<input checked="" type="checkbox"/>	5.725~5.85 GHz	30 dBm/500kHz

4.5.2. Measuring Instruments and Setting

Please refer to section 5 of equipments list in this report. The following table is the setting of the spectrum analyzer.

Spectrum Parameter	Setting
Attenuation	Auto
Span Frequency	Encompass the entire emissions bandwidth (EBW) of the signal
RBW	1000 kHz
VBW	3000 kHz
Detector	RMS
Trace	AVERAGE
Sweep Time	Auto
Trace Average	100 times
Note: If measurement bandwidth of Maximum PSD is specified in 500 kHz, add $10\log(500\text{kHz}/\text{RBW})$ to the measured result, whereas RBW (< 500 kHz) is the reduced resolution bandwidth of the spectrum analyzer set during measurement.	

4.5.3. Test Procedures

1. The transmitter output (antenna port) was connected RF switch to the spectrum analyzer.
2. Test was performed in accordance with KDB789033 D02 v01 for Compliance Testing of Unlicensed National Information Infrastructure (U-NII) Devices - section (F) Maximum Power Spectral Density (PSD).
3. Multiple antenna systems was performed in accordance KDB662911 D01 v02r01 in-Band Power Spectral Density (PSD) Measurements (a) Measure and sum the spectra across the outputs.
4. When measuring first spectral bin of output 1 is summed with that in the first spectral bin of output 2 and that from the first spectral bin of output 3 and so on up to the Nth output to obtain the value for the first frequency bin of the summed spectrum. The summed spectrum value for each of the other frequency bins is computed in the same way.
5. For 5.725~5.85 GHz, the measured result of PSD level must add $10\log(500\text{kHz}/\text{RBW})$ and the final result should ≤ 30 dBm.

4.5.4. Test Setup Layout

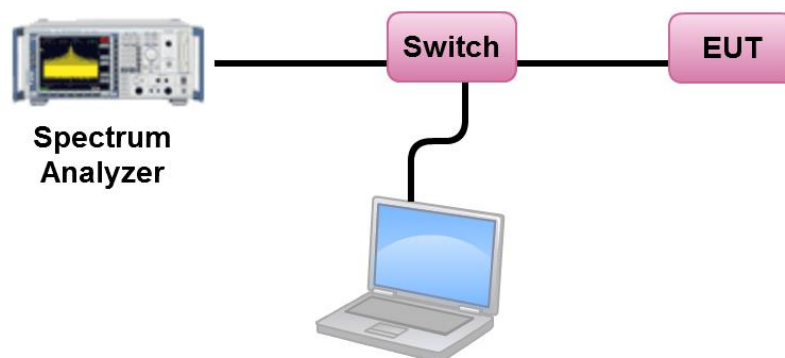

4.5.5. Test Deviation

There is no deviation with the original standard.

4.5.6. EUT Operation during Test

The EUT was programmed to be in continuously transmitting mode.

4.5.7. Test Result of Power Spectral Density

Temperature	25°C	Humidity	50%
Test Engineer	Eddie Weng & Lucas Huang	Test Date	Nov. 28, 2015
Test Mode	Mode 1: PIFA Antenna / Chain1:5.84 dBi, Chain2:5.50 dBi, Chain3:5.84 dBi, Chain4:5.65 dBi		

Configuration IEEE 802.11ac MCS0/Nss1 VHT20 / Chain 1 + Chain 2 + Chain 3 + Chain 4

Channel	Frequency	Power Density (dBm/MHz)	Max. Limit (dBm/MHz)	Result
36	5180 MHz	10.90	11.27	Complies
40	5200 MHz	10.99	11.27	Complies
48	5240 MHz	10.99	11.27	Complies

Note: $DirectionalGain = 10 \cdot \log \left[\frac{\sum_{j=1}^{N_{SS}} \left\{ \sum_{k=1}^{N_{ANT}} g_{j,k} \right\}^2}{N_{ANT}} \right] = 11.73\text{dBi} > 6\text{dBi}$, So Limit = 17 - (11.73 - 6) = 11.27 dBm/MHz.

Channel	Frequency	Power Density (dBm/MHz)	10log(500kHz/RBW) Factor (dB)	Power Density (dBm/500kHz)	Power Density Limit (dBm/500kHz)	Result
149	5745 MHz	9.68	-3.01	6.67	24.27	Complies
157	5785 MHz	10.90	-3.01	7.89	24.27	Complies
165	5825 MHz	10.81	-3.01	7.80	24.27	Complies

Note: $DirectionalGain = 10 \cdot \log \left[\frac{\sum_{j=1}^{N_{SS}} \left\{ \sum_{k=1}^{N_{ANT}} g_{j,k} \right\}^2}{N_{ANT}} \right] = 11.73\text{dBi} > 6\text{dBi}$, So Limit = 30 - (11.73 - 6) = 24.27 dBm/500kHz.

Configuration IEEE 802.11ac MCS0/Nss1 VHT40 / Chain 1 + Chain 2 + Chain 3 + Chain 4

Channel	Frequency	Power Density (dBm/MHz)	Max. Limit (dBm/MHz)	Result
38	5190 MHz	5.64	11.27	Complies
46	5230 MHz	7.83	11.27	Complies

Note: $DirectionalGain = 10 \cdot \log \left[\frac{\sum_{j=1}^{N_{SS}} \left\{ \sum_{k=1}^{N_{ANT}} g_{j,k} \right\}^2}{N_{ANT}} \right] = 11.73\text{dBi} > 6\text{dBi}$, So Limit = 17-(11.73-6)=11.27dBm/MHz.

Channel	Frequency	Power Density (dBm/MHz)	10log(500kHz/RBW) Factor (dB)	Power Density (dBm/500kHz)	Power Density Limit (dBm/500kHz)	Result
151	5755 MHz	1.82	-3.01	-1.19	24.27	Complies
159	5795 MHz	7.88	-3.01	4.87	24.27	Complies

Note: $DirectionalGain = 10 \cdot \log \left[\frac{\sum_{j=1}^{N_{SS}} \left\{ \sum_{k=1}^{N_{ANT}} g_{j,k} \right\}^2}{N_{ANT}} \right] = 11.73\text{dBi} > 6\text{dBi}$, So Limit = 30-(11.73-6)=24.27dBm/500kHz.

Configuration IEEE 802.11ac MCS0/Nss1 VHT80 / Chain 1 + Chain 2 + Chain 3 + Chain 4

Channel	Frequency	Power Density (dBm/MHz)	Max. Limit (dBm/MHz)	Result
42	5210 MHz	-3.32	11.27	Complies

Note: $DirectionalGain = 10 \cdot \log \left[\frac{\sum_{j=1}^{N_{SS}} \left\{ \sum_{k=1}^{N_{ANT}} g_{j,k} \right\}^2}{N_{ANT}} \right] = 11.73\text{dBi} > 6\text{dBi}$, So Limit = 17-(11.73-6)=11.27dBm/MHz.

Channel	Frequency	Power Density (dBm/MHz)	10log(500kHz/RBW) Factor (dB)	Power Density (dBm/500kHz)	Power Density Limit (dBm/500kHz)	Result
155	5775 MHz	-4.18	-3.01	-7.19	24.27	Complies

Note: $DirectionalGain = 10 \cdot \log \left[\frac{\sum_{j=1}^{N_{SS}} \left\{ \sum_{k=1}^{N_{ANT}} g_{j,k} \right\}^2}{N_{ANT}} \right] = 11.73\text{dBi} > 6\text{dBi}$, So Limit = 30-(11.73-6)=24.27dBm/500kHz.

Note: All the test values were listed in the report.

For plots, only the channel with worse result was shown.

Mode 1: PIFA Antenna / Chain1:5.84 dBi, Chain2:5.50 dBi, Chain3:5.84 dBi, Chain4:5.65 dBi

Power Density Plot on Configuration IEEE 802.11ac MCS0/Nss1 VHT20 / Chain 1 + Chain 2 + Chain 3 + Chain 4 / 5200 MHz

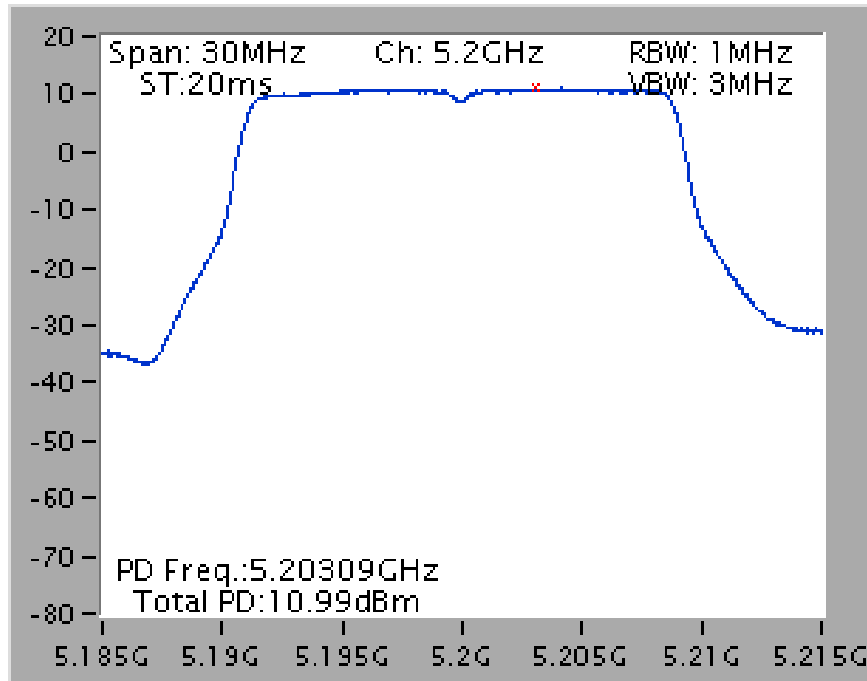

Power Density Plot on Configuration IEEE 802.11ac MCS0/Nss1 VHT20 / Chain 1 + Chain 2 + Chain 3 + Chain 4 / 5785 MHz

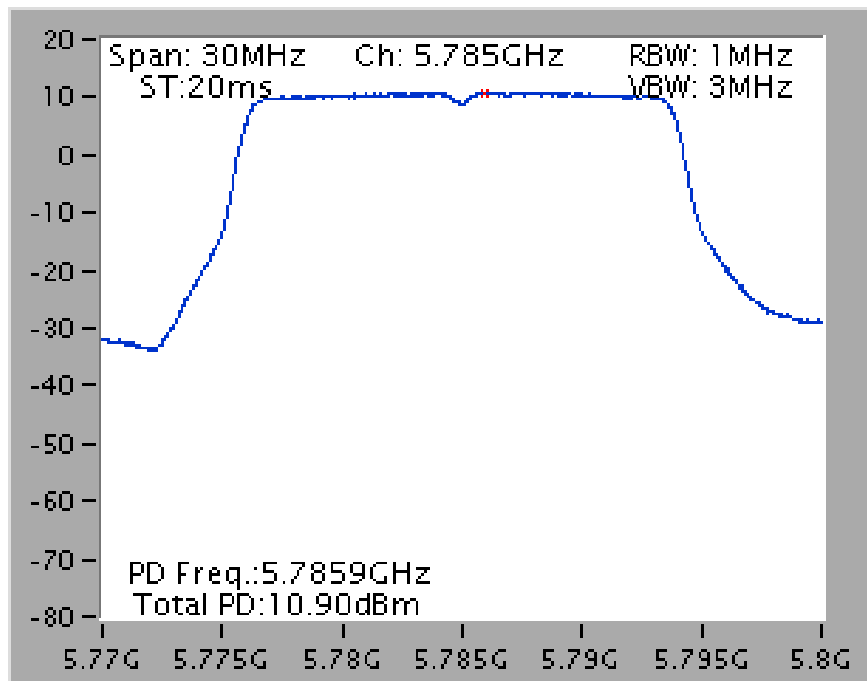

Power Density Plot on Configuration IEEE 802.11ac MCS0/Nss1 VHT40 / Chain 1 + Chain 2 + Chain 3 + Chain 4 / 5230 MHz

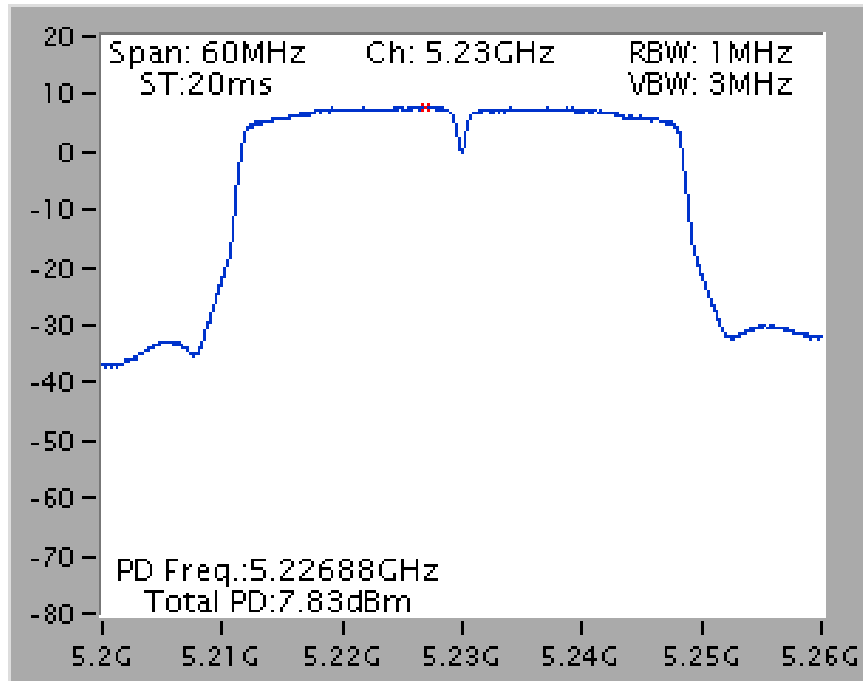

Power Density Plot on Configuration IEEE 802.11ac MCS0/Nss1 VHT40 / Chain 1 + Chain 2 + Chain 3 + Chain 4 / 5795 MHz

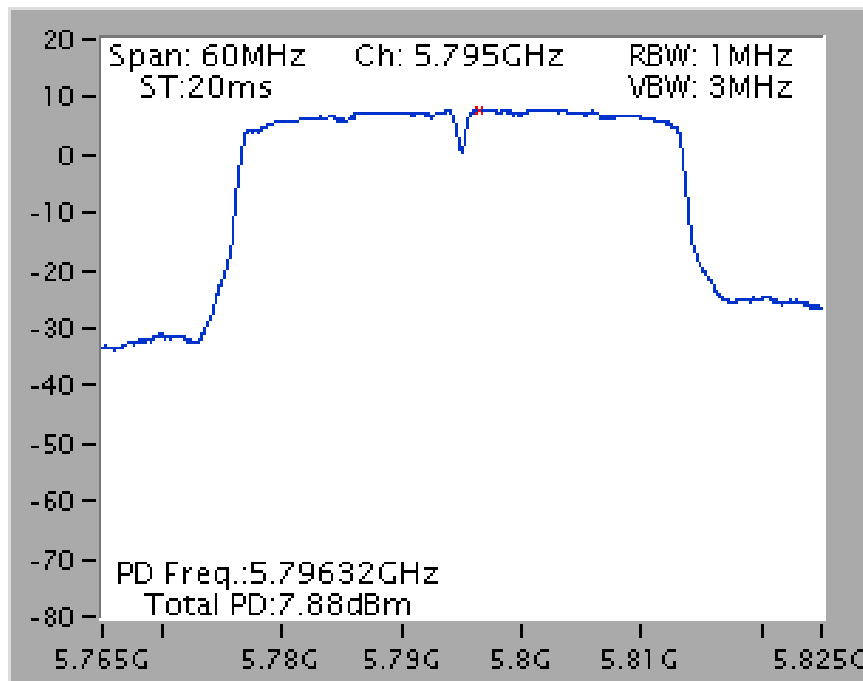

Power Density Plot on Configuration IEEE 802.11ac MCS0/Nss1 VHT80 / Chain 1 + Chain 2 + Chain 3 + Chain 4 / 5210 MHz

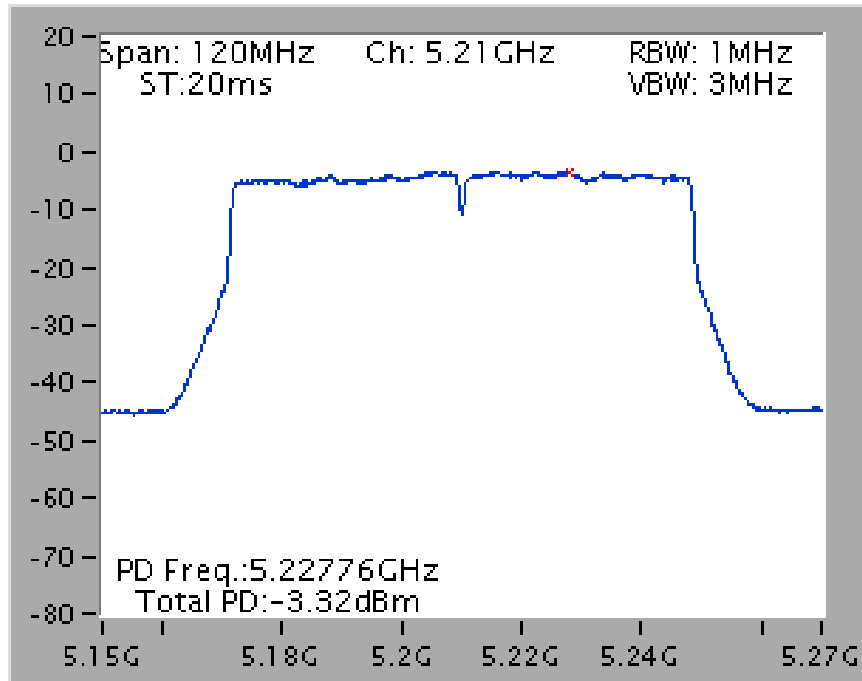

Power Density Plot on Configuration IEEE 802.11ac MCS0/Nss1 VHT80 / Chain 1 + Chain 2 + Chain 3 + Chain 4 / 5775 MHz

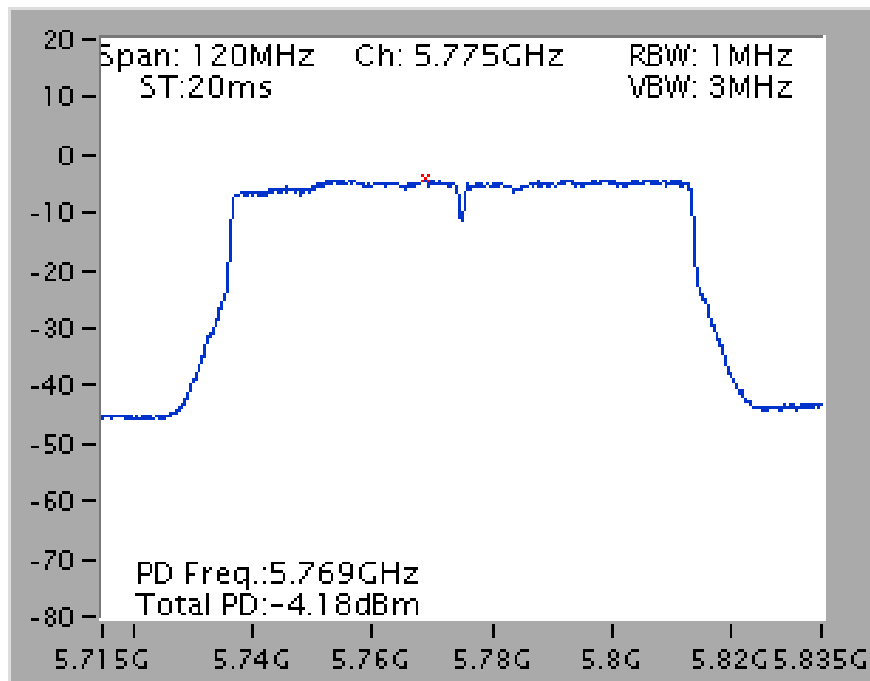

4.6. Radiated Emissions Measurement

4.6.1. Limit

For transmitters operating in the 5.15-5.25 GHz band: all emissions outside of the 5.15-5.35 GHz band shall not exceed an e.i.r.p. of -27 dBm/MHz.

For transmitters operating in the 5.725-5.85 GHz band: all emissions within the frequency range from the band edge to 10 MHz above or below the band edge shall not exceed an e.i.r.p. of -17 dBm/MHz; for frequencies 10 MHz or greater above or below the band edge, emissions shall not exceed an e.i.r.p. of -27 dBm/MHz.

In addition, In case the emission fall within the restricted band specified on 15.205(a), then the 15.209(a) limit in the table below has to be followed.

Frequencies (MHz)	Field Strength (micorvolts/meter)	Measurement Distance (meters)
0.009~0.490	2400/F(kHz)	300
0.490~1.705	24000/F(kHz)	30
1.705~30.0	30	30
30~88	100	3
88~216	150	3
216~960	200	3
Above 960	500	3

4.6.2. Measuring Instruments and Setting

Please refer to section 5 of equipments list in this report. The following table is the setting of spectrum analyzer and receiver.

Spectrum Parameter	Setting
Attenuation	Auto
Start Frequency	1000 MHz
Stop Frequency	40 GHz
RBW / VBW (Emission in restricted band)	1MHz / 3MHz for Peak, 1MHz / 1/T for Average
RBW / VBW (Emission in non-restricted band)	1MHz / 3MHz for peak

Receiver Parameter	Setting
Attenuation	Auto
Start ~ Stop Frequency	9kHz~150kHz / RBW 200Hz for QP
Start ~ Stop Frequency	150kHz~30MHz / RBW 9kHz for QP
Start ~ Stop Frequency	30MHz~1000MHz / RBW 120kHz for QP

4.6.3. Test Procedures

1. Configure the EUT according to ANSI C63.10. The EUT was placed on the top of the turntable 1.5 meter above ground. The phase center of the receiving antenna mounted on the top of a height-variable antenna tower was placed 1m & 3m far away from the turntable.
2. Power on the EUT and all the supporting units. The turntable was rotated by 360 degrees to determine the position of the highest radiation.
3. The height of the broadband receiving antenna was varied between one meter and four meters above ground to find the maximum emissions field strength of both horizontal and vertical polarization.
4. For each suspected emissions, the antenna tower was scan (from 1 M to 4 M) and then the turntable was rotated (from 0 degree to 360 degrees) to find the maximum reading.
5. Set the test-receiver system to Peak or CISPR quasi-peak Detect Function with specified bandwidth under Maximum Hold Mode.
6. For emissions above 1GHz, use 1MHz VBW and 3MHz RBW for peak reading. Then 1MHz RBW and 1/T VBW for average reading in spectrum analyzer.
7. If the emissions level of the EUT in peak mode was 3 dB lower than the average limit specified, then testing will be stopped and peak values of EUT will be reported, otherwise, the emissions which do not have 3 dB margin will be repeated one by one using the quasi-peak method for below 1GHz.
8. For testing above 1GHz, the emissions level of the EUT in peak mode was lower than average limit (that means the emissions level in peak mode also complies with the limit in average mode), then testing will be stopped and peak values of EUT will be reported, otherwise, the emissions will be measured in average mode again and reported.
9. In case the emission is lower than 30MHz, loop antenna has to be used for measurement and the recorded data should be QP measured by receiver. High – Low scan is not required in this case.

4.6.4. Test Setup Layout

For Radiated Emissions: 9kHz ~30MHz

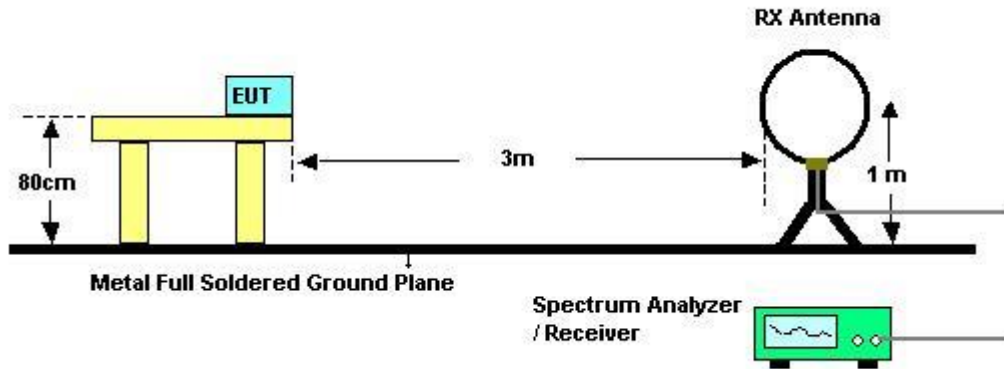

For Radiated Emissions: 30MHz~1GHz

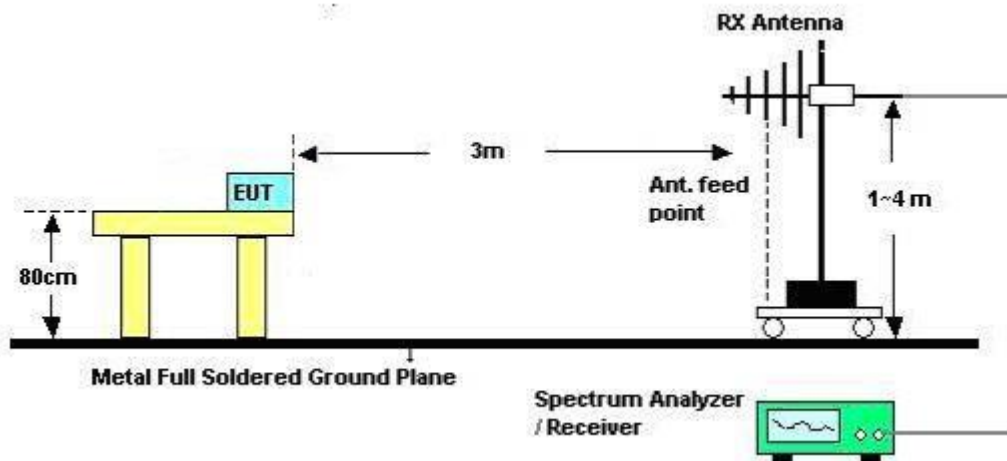

For Radiated Emissions: Above 1GHz

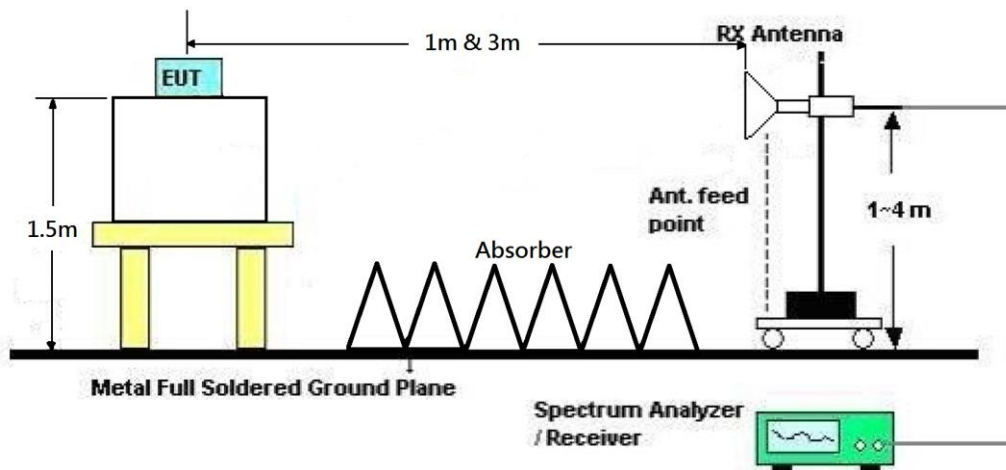

4.6.5. Test Deviation

There is no deviation with the original standard.

4.6.6. EUT Operation during Test

The EUT was programmed to be in continuously transmitting mode.

4.6.7. Results of Radiated Emissions (9kHz~30MHz)

Temperature	23°C	Humidity	66%
Test Engineer	Thor Wei	Configurations	Normal Link
Test Date	Aug. 12, 2017	Test Mode	Mode 1

Freq. (MHz)	Level (dBuV)	Over Limit (dB)	Limit Line (dBuV)	Remark
-	-	-	-	See Note

Note:

The amplitude of spurious emissions that are attenuated by more than 20dB below the permissible value has no need to be reported.

Distance extrapolation factor = $40 \log (\text{specific distance} / \text{test distance})$ (dB);

Limit line = specific limits (dBuV) + distance extrapolation factor.

4.6.8. Results of Radiated Emissions (30MHz~1GHz)

Temperature	23°C	Humidity	66%
Test Engineer	Thor Wei	Configurations	Normal Link
Test Mode	Mode 1		

Horizontal

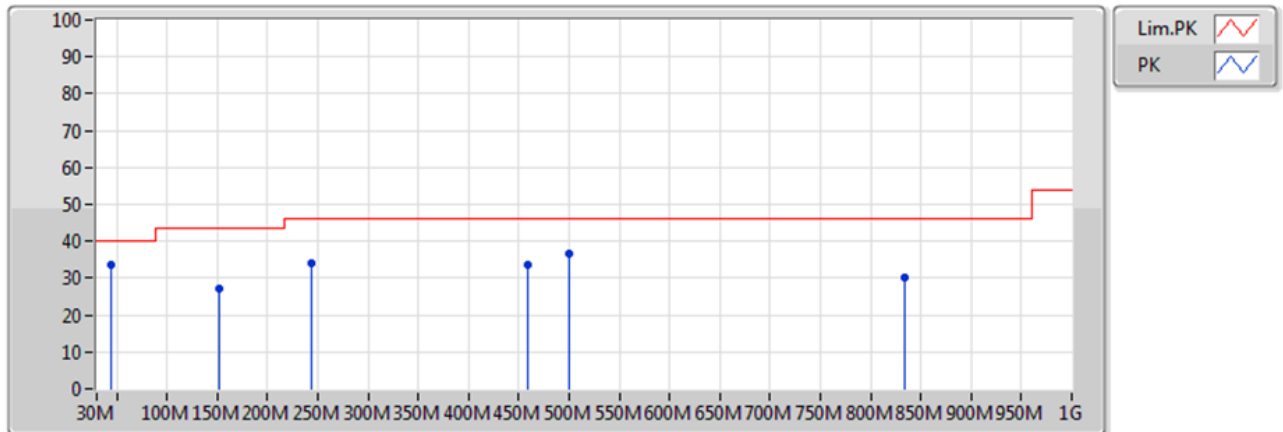

EUT=Z

Type	Freq (Hz)	Level (dBuV/m)	Limit (dBuV/m)	Margin (dB)	Factor (dB)	Dist (m)	Condition	Azimuth (°)	Height (m)	Comments	Raw (dBuV)	AF (dB)	CL (dB)	PA (dB)
PK	43.58M	33.60	40.00	-6.40	-10.94	3	Horizontal	0	1.00	-	44.54	15.73	0.98	27.65
PK	152.22M	27.12	43.50	-16.38	-10.49	3	Horizontal	0	1.00	-	37.61	15.38	1.76	27.62
PK	243.4M	33.90	46.00	-12.10	-8.38	3	Horizontal	0	1.00	-	42.28	16.75	2.21	27.33
PK	458.74M	33.80	46.00	-12.20	-3.04	3	Horizontal	0	1.00	-	36.84	21.95	3.28	28.27
PK	499.48M	36.45	46.00	-9.55	-2.57	3	Horizontal	0	1.00	-	39.02	22.53	3.39	28.49
PK	833.16M	30.05	46.00	-15.95	1.77	3	Horizontal	0	1.00	-	28.28	25.11	4.60	27.94

Vertical

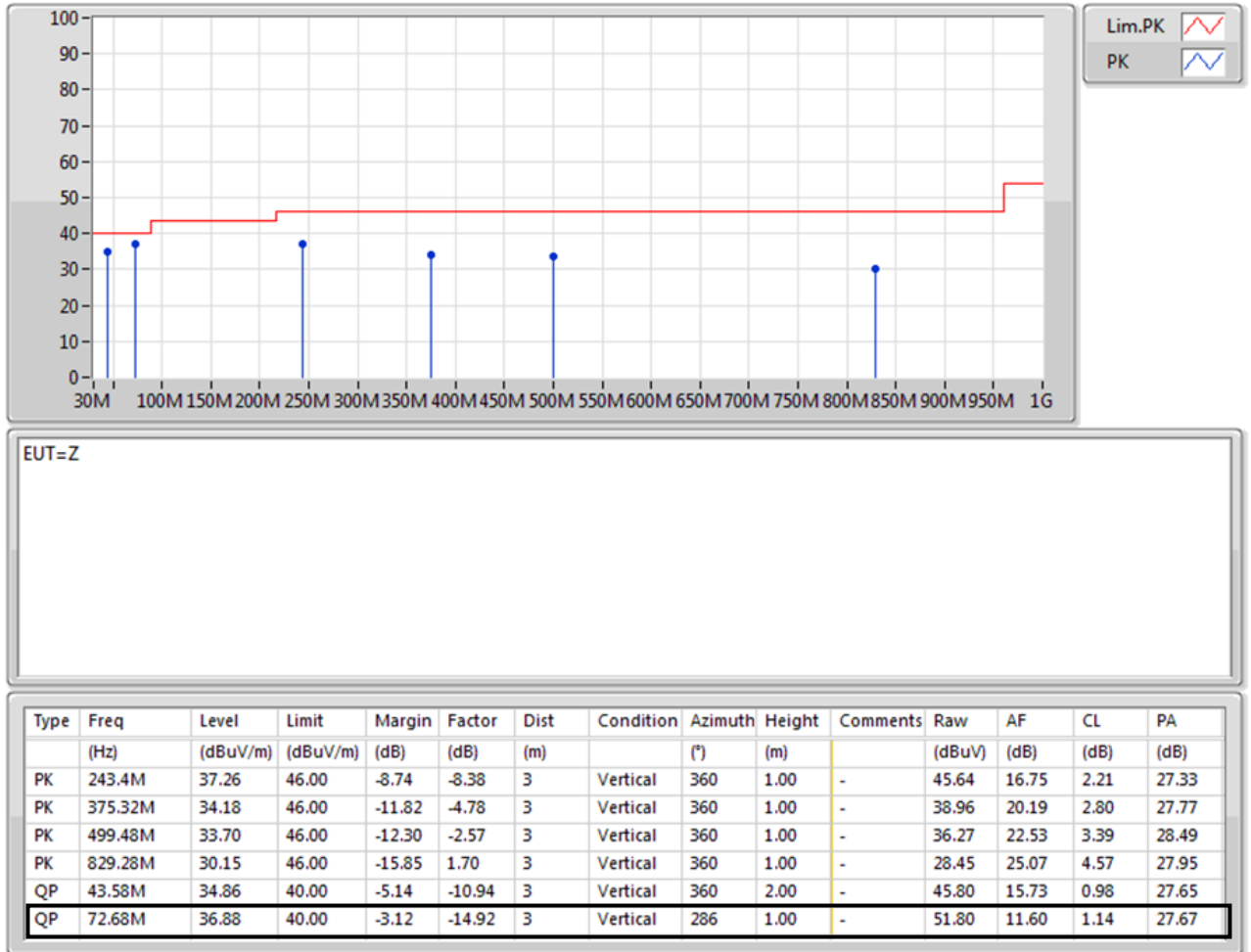

Note:

The amplitude of spurious emissions that are attenuated by more than 20dB below the permissible value has no need to be reported.

Emission level (dBuV/m) = 20 log Emission level (uV/m).

Corrected Reading: Antenna Factor + Cable Loss + Read Level - Preamp Factor = Level.

4.6.9. Results for Radiated Emissions (1GHz~40GHz)

Temperature	25°C	Humidity	55%
Test Engineer	Stim Sung	Configurations	IEEE 802.11ac MCS0/Nss1 VHT20 CH 36 / Chain 1 + Chain 2 + Chain 3 + Chain 4
Test Date	Nov. 20, 2015		
Test Mode	Mode 1: PIFA Antenna / Chain1:5.84 dBi, Chain2:5.50 dBi, Chain3:5.84 dBi, Chain4:5.65 dBi		

Horizontal

	Freq	Level	Limit Line	Over Limit	Read Level	CableAntenna Loss	Antenna Factor	Preamp Factor	A/Pos	T/Pos	Remark	Pol/Phase
	MHz	dBuV/m	dBuV/m	dB	dBuV	dB	dB/m	dB	cm	deg		
1	15545.76	64.59	74.00	-9.41	43.82	16.37	38.13	33.73	211	80	Peak	HORIZONTAL
2	15547.55	50.78	54.00	-3.22	30.01	16.37	38.13	33.73	211	80	Average	HORIZONTAL

Vertical

	Freq	Level	Limit Line	Over Limit	Read Level	CableAntenna Loss	Antenna Factor	Preamp Factor	A/Pos	T/Pos	Remark	Pol/Phase
	MHz	dBuV/m	dBuV/m	dB	dBuV	dB	dB/m	dB	cm	deg		
1	15541.30	64.54	74.00	-9.46	43.77	16.37	38.13	33.73	183	107	Peak	VERTICAL
2	15545.88	50.51	54.00	-3.49	29.74	16.37	38.13	33.73	183	107	Average	VERTICAL

Temperature	25°C	Humidity	55%
Test Engineer	Stim Sung	Configurations	IEEE 802.11ac MCS0/Nss1 VHT20 CH 40 / Chain 1 + Chain 2 + Chain 3 + Chain 4
Test Date	Nov. 20, 2015		
Test Mode	Mode 1: PIFA Antenna / Chain1:5.84 dBi, Chain2:5.50 dBi, Chain3:5.84 dBi, Chain4:5.65 dBi		

Horizontal

	Freq	Level	Limit Line	Over Limit	Read Level	CableAntenna Loss	Antenna Factor	Preamp Factor	A/Pos	T/Pos	Remark	Pol/Phase
	MHz	dBuV/m	dBuV/m	dB	dBuV	dB	dB/m	dB	cm	deg		
1	15596.99	63.71	74.00	-10.29	43.03	16.40	38.05	33.77	183	110	Peak	HORIZONTAL
2	15598.52	49.98	54.00	-4.02	29.30	16.40	38.05	33.77	183	110	Average	HORIZONTAL

Vertical

	Freq	Level	Limit Line	Over Limit	Read Level	CableAntenna Loss	Antenna Factor	Preamp Factor	A/Pos	T/Pos	Remark	Pol/Phase
	MHz	dBuV/m	dBuV/m	dB	dBuV	dB	dB/m	dB	cm	deg		
1	15596.73	50.35	54.00	-3.65	29.67	16.40	38.05	33.77	192	102	Average	VERTICAL
2	15609.90	63.96	74.00	-10.04	43.37	16.43	37.98	33.82	192	102	Peak	VERTICAL

Temperature	25°C	Humidity	55%
Test Engineer	Stim Sung	Configurations	IEEE 802.11ac MCS0/Nss1 VHT20 CH 48 / Chain 1 + Chain 2 + Chain 3 + Chain 4
Test Date	Nov. 20, 2015		
Test Mode	Mode 1: PIFA Antenna / Chain1:5.84 dBi, Chain2:5.50 dBi, Chain3:5.84 dBi, Chain4:5.65 dBi		

Horizontal

	Freq	Level	Limit	Over	Read	Cable	Antenna	Preamp	A/Pos	T/Pos	Remark	Pol/Phase
	MHz	dBuV/m	dBuV/m	dB	dBuV	dB	dB/m	dB	cm	deg		
1	15722.75	50.16	54.00	-3.84	29.76	16.48	37.84	33.92	176	116	Average	HORIZONTAL
2	15726.74	63.02	74.00	-10.98	42.62	16.48	37.84	33.92	176	116	Peak	HORIZONTAL

Vertical

	Freq	Level	Limit	Over	Read	Cable	Antenna	Preamp	A/Pos	T/Pos	Remark	Pol/Phase
	MHz	dBuV/m	dBuV/m	dB	dBuV	dB	dB/m	dB	cm	deg		
1	15719.51	50.07	54.00	-3.93	29.67	16.48	37.84	33.92	171	120	Average	VERTICAL
2	15726.69	64.53	74.00	-9.47	44.13	16.48	37.84	33.92	171	120	Peak	VERTICAL

Temperature	25°C	Humidity	55%
Test Engineer	Stim Sung	Configurations	IEEE 802.11ac MCS0/Nss1 VHT20 CH 149 / Chain 1 + Chain 2 + Chain 3 + Chain 4
Test Date	Nov. 20, 2015		
Test Mode	Mode 1: PIFA Antenna / Chain1:5.84 dBi, Chain2:5.50 dBi, Chain3:5.84 dBi, Chain4:5.65 dBi		

Horizontal

	Freq	Level	Limit	Over	Read	Cable	Antenna	Preamp	A/Pos	T/Pos	Remark	Pol/Phase
	MHz	dBuV/m	dBuV/m	dB	dBuV	dB	dB/m	dB	cm	deg		
1	11495.76	61.36	74.00	-12.64	41.29	14.24	39.20	33.37	225	118	Peak	HORIZONTAL
2	11499.72	48.55	54.00	-5.45	28.48	14.24	39.20	33.37	225	118	Average	HORIZONTAL

Vertical

	Freq	Level	Limit	Over	Read	Cable	Antenna	Preamp	A/Pos	T/Pos	Remark	Pol/Phase
	MHz	dBuV/m	dBuV/m	dB	dBuV	dB	dB/m	dB	cm	deg		
1	11485.46	61.28	74.00	-12.72	41.21	14.24	39.20	33.37	210	102	Peak	VERTICAL
2	11495.50	48.30	54.00	-5.70	28.23	14.24	39.20	33.37	210	102	Average	VERTICAL

Temperature	25°C	Humidity	55%
Test Engineer	Stim Sung	Configurations	IEEE 802.11ac MCS0/Nss1 VHT20 CH 157 / Chain 1 + Chain 2 + Chain 3 + Chain 4
Test Date	Nov. 20, 2015		
Test Mode	Mode 1: PIFA Antenna / Chain1:5.84 dBi, Chain2:5.50 dBi, Chain3:5.84 dBi, Chain4:5.65 dBi		

Horizontal

	Freq	Level	Limit	Over	Read	Cable	Antenna	Preamp	A/Pos	T/Pos	Remark	Pol/Phase
	MHz	dBuV/m	dBuV/m	dB	dBuV	dB	dB/m	dB	cm	deg		
1	11565.28	61.79	74.00	-12.21	41.63	14.35	39.20	33.39	240	139	Peak	HORIZONTAL
2	11565.49	48.26	54.00	-5.74	28.10	14.35	39.20	33.39	240	137	Average	HORIZONTAL

Vertical

	Freq	Level	Limit	Over	Read	Cable	Antenna	Preamp	A/Pos	T/Pos	Remark	Pol/Phase
	MHz	dBuV/m	dBuV/m	dB	dBuV	dB	dB/m	dB	cm	deg		
1	11563.00	62.00	74.00	-12.00	41.84	14.35	39.20	33.39	218	95	Peak	VERTICAL
2	11566.04	48.24	54.00	-5.76	28.08	14.35	39.20	33.39	218	95	Average	VERTICAL

Temperature	25°C	Humidity	55%
Test Engineer	Stim Sung	Configurations	IEEE 802.11ac MCS0/Nss1 VHT20 CH 165 / Chain 1 + Chain 2 + Chain 3 + Chain 4
Test Date	Nov. 20, 2015		
Test Mode	Mode 1: PIFA Antenna / Chain1:5.84 dBi, Chain2:5.50 dBi, Chain3:5.84 dBi, Chain4:5.65 dBi		

Horizontal

	Freq	Level	Limit	Over	Read	CableAntenna	Preamp	A/Pos	T/Pos	Remark	Pol/Phase
	MHz	dBuV/m	dBuV/m	dB	dBuV	dB	dB/m	dB	cm	deg	
1	11643.66	48.65	54.00	-5.35	28.41	14.45	39.20	33.41	229	126 Average	HORIZONTAL
2	11649.94	61.79	74.00	-12.21	41.55	14.45	39.20	33.41	229	126 Peak	HORIZONTAL

Vertical

	Freq	Level	Limit	Over	Read	CableAntenna	Preamp	A/Pos	T/Pos	Remark	Pol/Phase
	MHz	dBuV/m	dBuV/m	dB	dBuV	dB	dB/m	dB	cm	deg	
1	11640.22	48.64	54.00	-5.36	28.40	14.45	39.20	33.41	237	117 Average	VERTICAL
2	11654.37	61.79	74.00	-12.21	41.49	14.51	39.20	33.41	237	117 Peak	VERTICAL

Temperature	25°C	Humidity	55%
Test Engineer	Stim Sung	Configurations	IEEE 802.11ac MCS0/Nss1 VHT40 CH 38 / Chain 1 + Chain 2 + Chain 3 + Chain 4
Test Date	Nov. 20, 2015		
Test Mode	Mode 1: PIFA Antenna / Chain1:5.84 dBi, Chain2:5.50 dBi, Chain3:5.84 dBi, Chain4:5.65 dBi		

Horizontal

	Freq	Level	Limit	Over	Read	CableAntenna	Preamp	A/Pos	T/Pos	Remark	Pol/Phase
	MHz	dBuV/m	dBuV/m	dB	dBuV	dB	dB/m	dB	cm	deg	
1	15562.47	50.44	54.00	-3.56	29.76	16.40	38.05	33.77	200	104 Average	HORIZONTAL
2	15579.03	63.25	74.00	-10.75	42.57	16.40	38.05	33.77	200	104 Peak	HORIZONTAL

Vertical

	Freq	Level	Limit	Over	Read	CableAntenna	Preamp	A/Pos	T/Pos	Remark	Pol/Phase
	MHz	dBuV/m	dBuV/m	dB	dBuV	dB	dB/m	dB	cm	deg	
1	15562.50	50.58	54.00	-3.42	29.90	16.40	38.05	33.77	203	103 Average	VERTICAL
2	15574.60	63.00	74.00	-11.00	42.32	16.40	38.05	33.77	203	103 Peak	VERTICAL

Temperature	25°C	Humidity	55%
Test Engineer	Stim Sung	Configurations	IEEE 802.11ac MCS0/Nss1 VHT40 CH 46 / Chain 1 + Chain 2 + Chain 3 + Chain 4
Test Date	Nov. 20, 2015		
Test Mode	Mode 1: PIFA Antenna / Chain1:5.84 dBi, Chain2:5.50 dBi, Chain3:5.84 dBi, Chain4:5.65 dBi		

Horizontal

	Freq	Level	Limit	Over	Read	CableAntenna	Preamp	A/Pos	T/Pos	Remark	Pol/Phase	
	MHz	dBuV/m	dBuV/m	dB	dBuV	dB	dB/m	dB	cm	deg		
1	15683.55	50.23	54.00	-3.77	29.74	16.45	37.91	33.87	211	115	Average	HORIZONTAL
2	15691.33	63.53	74.00	-10.47	43.08	16.48	37.84	33.87	211	115	Peak	HORIZONTAL

Vertical

	Freq	Level	Limit	Over	Read	CableAntenna	Preamp	A/Pos	T/Pos	Remark	Pol/Phase	
	MHz	dBuV/m	dBuV/m	dB	dBuV	dB	dB/m	dB	cm	deg		
1	15682.01	63.23	74.00	-10.77	42.74	16.45	37.91	33.87	160	126	Peak	VERTICAL
2	15687.80	50.21	54.00	-3.79	29.72	16.45	37.91	33.87	160	126	Average	VERTICAL

Temperature	25°C	Humidity	55%
Test Engineer	Stim Sung	Configurations	IEEE 802.11ac MCS0/Nss1 VHT40 CH 151 / Chain 1 + Chain 2 + Chain 3 + Chain 4
Test Date	Nov. 20, 2015		
Test Mode	Mode 1: PIFA Antenna / Chain1:5.84 dBi, Chain2:5.50 dBi, Chain3:5.84 dBi, Chain4:5.65 dBi		

Horizontal

	Freq	Level	Limit Line	Over Limit	Read Level	Cable Loss	Antenna Factor	Preamp Factor	A/Pos	T/Pos	Remark	Pol/Phase
	MHz	dBuV/m	dBuV/m	dB	dBuV	dB	dB/m	dB	cm	deg		
1	11507.28	62.07	74.00	-11.93	42.00	14.24	39.20	33.37	221	121	Peak	HORIZONTAL
2	11507.34	48.49	54.00	-5.51	28.42	14.24	39.20	33.37	221	121	Average	HORIZONTAL

Vertical

	Freq	Level	Limit Line	Over Limit	Read Level	Cable Loss	Antenna Factor	Preamp Factor	A/Pos	T/Pos	Remark	Pol/Phase
	MHz	dBuV/m	dBuV/m	dB	dBuV	dB	dB/m	dB	cm	deg		
1	11501.69	61.24	74.00	-12.76	41.17	14.24	39.20	33.37	212	124	Peak	VERTICAL
2	11509.51	48.44	54.00	-5.56	28.38	14.24	39.20	33.38	212	124	Average	VERTICAL

Temperature	25°C	Humidity	55%
Test Engineer	Stim Sung	Configuration	IEEE 802.11ac MCS0/Nss1 VHT40 CH 159 / Chain 1 + Chain 2 + Chain 3 + Chain 4
Test Date	Nov. 20, 2015		
Test Mode	Mode 1: PIFA Antenna / Chain1:5.84 dBi, Chain2:5.50 dBi, Chain3:5.84 dBi, Chain4:5.65 dBi		

Horizontal

	Freq	Level	Limit	Over	Read	CableAntenna	Preamp	A/Pos	T/Pos	Remark	Pol/Phase
	MHz	dBuV/m	dBuV/m	dB	dBuV	dB	dB/m	dB	cm	deg	
1	11588.21	61.49	74.00	-12.51	41.29	14.40	39.20	33.40	206	130 Peak	HORIZONTAL
2	11591.74	48.51	54.00	-5.49	28.31	14.40	39.20	33.40	206	130 Average	HORIZONTAL

Vertical

	Freq	Level	Limit	Over	Read	CableAntenna	Preamp	A/Pos	T/Pos	Remark	Pol/Phase
	MHz	dBuV/m	dBuV/m	dB	dBuV	dB	dB/m	dB	cm	deg	
1	11594.31	61.73	74.00	-12.27	41.53	14.40	39.20	33.40	208	134 Peak	VERTICAL
2	11598.68	48.26	54.00	-5.74	28.06	14.40	39.20	33.40	208	134 Average	VERTICAL

Temperature	25°C	Humidity	55%
Test Engineer	Stim Sung	Configurations	IEEE 802.11ac MCS0/Nss1 VHT80 CH 42 / Chain 1 + Chain 2 + Chain 3 + Chain 4
Test Date	Nov. 20, 2015		
Test Mode	Mode 1: PIFA Antenna / Chain1:5.84 dBi, Chain2:5.50 dBi, Chain3:5.84 dBi, Chain4:5.65 dBi		

Horizontal

	Freq	Level	Limit Line	Over Limit	Read Level	CableAntenna Loss	Antenna Factor	Preamp Factor	A/Pos	T/Pos	Remark	Pol/Phase
	MHz	dBuV/m	dBuV/m	dB	dBuV	dB	dB/m	dB	cm	deg		
1	15629.25	63.82	74.00	-10.18	43.23	16.43	37.98	33.82	139	303	Peak	HORIZONTAL
2	15630.64	50.90	54.00	-3.10	30.31	16.43	37.98	33.82	139	303	Average	HORIZONTAL

Vertical

	Freq	Level	Limit Line	Over Limit	Read Level	CableAntenna Loss	Antenna Factor	Preamp Factor	A/Pos	T/Pos	Remark	Pol/Phase
	MHz	dBuV/m	dBuV/m	dB	dBuV	dB	dB/m	dB	cm	deg		
1	15629.50	64.77	74.00	-9.23	44.18	16.43	37.98	33.82	142	310	Peak	VERTICAL
2	15630.16	50.95	54.00	-3.05	30.36	16.43	37.98	33.82	142	310	Average	VERTICAL

Temperature	25°C	Humidity	55%
Test Engineer	Stim Sung	Configurations	IEEE 802.11ac MCS0/Nss1 VHT80 CH 155 / Chain 1 + Chain 2 + Chain 3 + Chain 4
Test Date	Nov. 20, 2015		
Test Mode	Mode 1: PIFA Antenna / Chain1:5.84 dBi, Chain2:5.50 dBi, Chain3:5.84 dBi, Chain4:5.65 dBi		

Horizontal

	Freq	Level	Limit	Over	Read	Cable	Antenna	Preamp	A/Pos	T/Pos	Remark	Pol/Phase
	MHz	dBuV/m	dBuV/m	dB	dBuV	dB	dB/m	dB	cm	deg		
1	11549.72	47.11	54.00	-6.89	27.01	14.29	39.20	33.39	118	302	Average	HORIZONTAL
2	11550.86	59.78	74.00	-14.22	39.62	14.35	39.20	33.39	118	302	Peak	HORIZONTAL

Vertical

	Freq	Level	Limit	Over	Read	Cable	Antenna	Preamp	A/Pos	T/Pos	Remark	Pol/Phase
	MHz	dBuV/m	dBuV/m	dB	dBuV	dB	dB/m	dB	cm	deg		
1	11549.19	46.76	54.00	-7.24	26.66	14.29	39.20	33.39	124	298	Average	VERTICAL
2	11549.90	60.20	74.00	-13.80	40.10	14.29	39.20	33.39	124	298	Peak	VERTICAL

Note:

The amplitude of spurious emissions that are attenuated by more than 20dB below the permissible value has no need to be reported.

Emission level (dBuV/m) = 20 log Emission level (uV/m).

Corrected Reading: Antenna Factor + Cable Loss + Read Level - Preamp Factor = Level.

4.7. Band Edge Emissions Measurement

4.7.1. Limit

For transmitters operating in the 5.15-5.25 GHz band: all emissions outside of the 5.15-5.35 GHz band shall not exceed an e.i.r.p. of -27 dBm/MHz.

For transmitters operating in the 5.725-5.85 GHz band: all emissions within the frequency range from the band edge to 10 MHz above or below the band edge shall not exceed an e.i.r.p. of -17 dBm/MHz; for frequencies 10 MHz or greater above or below the band edge, emissions shall not exceed an e.i.r.p. of -27 dBm/MHz.

In addition, In case the emission fall within the restricted band specified on 15.205(a), then the 15.209(a) limit in the table below has to be followed.

Frequencies (MHz)	Field Strength (micorvolts/meter)	Measurement Distance (meters)
0.009~0.490	2400/F(kHz)	300
0.490~1.705	24000/F(kHz)	30
1.705~30.0	30	30
30~88	100	3
88~216	150	3
216~960	200	3
Above 960	500	3

4.7.2. Measuring Instruments and Setting

Please refer to section 5 of equipments list in this report. The following table is the setting of the spectrum analyzer.

Spectrum Parameter	Setting
Attenuation	Auto
Span Frequency	100 MHz
RBW / VBW (Emission in restricted band)	1MHz / 3MHz for Peak, 1MHz / 1/T for Average
RBW / VBW (Emission in non-restricted band)	1MHz / 3MHz for Peak

4.7.3. Test Procedures

1. The test procedure is the same as section 4.6.3.

4.7.4. Test Setup Layout

This test setup layout is the same as that shown in section 4.6.4.

4.7.5. Test Deviation

There is no deviation with the original standard.

4.7.6. EUT Operation during Test

The EUT was programmed to be in continuously transmitting mode.

4.7.7. Test Result of Band Edge and Fundamental Emissions

Temperature	25°C	Humidity	55%
Test Engineer	Stim Sung	Configurations	IEEE 802.11ac MCS0/Nss1 VHT20 CH 36, 40, 48 / Chain 1 + Chain 2 + Chain 3 + Chain 4
Test Date	Nov. 20, 2015		
Test Mode	Mode 1: PIFA Antenna / Chain1:5.84 dBi, Chain2:5.50 dBi, Chain3:5.84 dBi, Chain4:5.65 dBi		

Channel 36

	Freq	Level	Limit	Over	Read	Cable	Antenna	Preamp	A/Pos	T/Pos	Remark	Pol/Phase
	MHz	dBuV/m	dBuV/m	dB	dBuV	Loss	Factor	Factor	cm	deg		
1	5147.60	64.53	74.00	-9.47	55.69	8.15	33.74	33.05	182	297	Peak	HORIZONTAL
2	5148.20	52.33	54.00	-1.67	43.49	8.15	33.74	33.05	182	297	Average	HORIZONTAL
3	5177.00	107.05			98.05	8.26	33.79	33.05	182	297	Average	HORIZONTAL
4	5183.80	119.79			110.79	8.26	33.79	33.05	182	297	Peak	HORIZONTAL

Item 3, 4 are the fundamental frequency at 5180 MHz.

Channel 40

	Freq	Level	Limit	Over	Read	Cable	Antenna	Preamp	A/Pos	T/Pos	Remark	Pol/Phase
	MHz	dBuV/m	dBuV/m	dB	dBuV	Loss	Factor	Factor	cm	deg		
1	5146.80	48.54	54.00	-5.46	39.70	8.15	33.74	33.05	189	69	Average	HORIZONTAL
2	5148.00	60.57	74.00	-13.43	51.73	8.15	33.74	33.05	189	69	Peak	HORIZONTAL
3	5193.20	105.88			96.79	8.32	33.82	33.05	189	69	Average	HORIZONTAL
4	5196.40	117.21			108.12	8.32	33.82	33.05	189	69	Peak	HORIZONTAL

Item 3, 4 are the fundamental frequency at 5200 MHz.

Channel 48

	Freq	Level	Limit	Over	Read	Cable	Antenna	Preamp	A/Pos	T/Pos	Remark	Pol/Phase
	MHz	dBuV/m	dBuV/m	dB	dBuV	Loss	Factor	Factor	cm	deg		
1	5124.20	60.04	74.00	-13.96	51.37	8.03	33.69	33.05	184	303	Peak	HORIZONTAL
2	5135.60	47.80	54.00	-6.20	39.04	8.09	33.72	33.05	184	303	Average	HORIZONTAL
3	5242.40	120.80			111.68	8.29	33.89	33.06	184	303	Peak	HORIZONTAL
4	5242.40	108.75			99.63	8.29	33.89	33.06	184	303	Average	HORIZONTAL
5	5354.80	60.92	74.00	-13.08	51.71	8.19	34.08	33.06	184	303	Peak	HORIZONTAL
6	5367.80	48.17	54.00	-5.83	38.96	8.19	34.08	33.06	184	303	Average	HORIZONTAL

Item 3, 4 are the fundamental frequency at 5240 MHz.

Temperature	25°C	Humidity	55%
Test Engineer	Stim Sung	Configurations	IEEE 802.11ac MCS0/Nss1 VHT20 CH 149, 157, 165 / Chain 1 + Chain 2 + Chain 3 + Chain 4
Test Date	Nov. 20, 2015		
Test Mode	Mode 1: PIFA Antenna / Chain1:5.84 dBi, Chain2:5.50 dBi, Chain3:5.84 dBi, Chain4:5.65 dBi		

Channel 149

	Freq	Level	Limit	Over	Read	CableAntenna	Preamp	A/Pos	T/Pos	Remark	Pol/Phase
	MHz	dBuV/m	dBuV/m	dB	dBuV	dB	dB/m	dB	cm	deg	
1	5713.80	67.18	68.20	-1.02	57.37	8.51	34.43	33.13	193	320 Peak	HORIZONTAL
2	5724.20	72.40	78.20	-5.80	62.62	8.47	34.44	33.13	193	320 Peak	HORIZONTAL
3	5750.20	118.08			108.34	8.43	34.45	33.14	193	320 Peak	HORIZONTAL
4	5750.60	106.05			96.31	8.43	34.45	33.14	193	320 Average	HORIZONTAL

Item 3, 4 are the fundamental frequency at 5745 MHz.

Channel 157

	Freq	Level	Limit	Over	Read	CableAntenna	Preamp	A/Pos	T/Pos	Remark	Pol/Phase
	MHz	dBuV/m	dBuV/m	dB	dBuV	dB	dB/m	dB	cm	deg	
1	5709.80	61.60	68.20	-6.60	51.79	8.51	34.43	33.13	258	298 Peak	VERTICAL
2	5718.20	61.31	78.20	-16.89	51.50	8.51	34.43	33.13	258	298 Peak	VERTICAL
3	5781.40	104.87			95.20	8.35	34.47	33.15	258	298 Average	VERTICAL
4	5782.20	116.84			107.17	8.35	34.47	33.15	258	298 Peak	VERTICAL
5	5850.00	60.61	78.20	-17.59	50.71	8.56	34.51	33.17	258	298 Peak	VERTICAL
6	5868.60	62.48	68.20	-5.72	52.50	8.64	34.52	33.18	258	298 Peak	VERTICAL

Item 3, 4 are the fundamental frequency at 5785 MHz.

Channel 165

	Freq	Level	Limit	Over	Read	CableAntenna	Preamp	A/Pos	T/Pos	Remark	Pol/Phase
	MHz	dBuV/m	dBuV/m	dB	dBuV	dB	dB/m	dB	cm	deg	
1	5827.40	117.96			108.16	8.47	34.50	33.17	204	53 Peak	HORIZONTAL
2	5830.60	106.59			96.79	8.47	34.50	33.17	204	53 Average	HORIZONTAL
3	5850.00	75.67	78.20	-2.53	65.77	8.56	34.51	33.17	204	53 Peak	HORIZONTAL
4	5861.00	62.85	68.20	-5.35	52.87	8.64	34.52	33.18	204	53 Peak	HORIZONTAL

Item 1, 2 are the fundamental frequency at 5825 MHz.

Temperature	25°C	Humidity	55%
Test Engineer	Stim Sung	Configurations	IEEE 802.11ac MCS0/Nss1 VHT40 CH 38, 46 / Chain 1 + Chain 2 + Chain 3 + Chain 4
Test Date	Nov. 20, 2015		
Test Mode	Mode 1: PIFA Antenna / Chain1:5.84 dBi, Chain2:5.50 dBi, Chain3:5.84 dBi, Chain4:5.65 dBi		

Channel 38

	Freq	Level	Limit	Over	Read	CableAntenna	Preamp	A/Pos	T/Pos	Remark	Pol/Phase	
	MHz	dBuV/m	dBuV/m	dB	dBuV	dB	dB/m	dB	cm	deg		
1	5148.40	64.86	74.00	-9.14	56.02	8.15	33.74	33.05	190	293	Peak	HORIZONTAL
2	5148.60	52.86	54.00	-1.14	44.02	8.15	33.74	33.05	190	293	Average	HORIZONTAL
3	5192.40	102.60			93.51	8.32	33.82	33.05	190	293	Average	HORIZONTAL
4	5196.40	113.67			104.58	8.32	33.82	33.05	190	293	Peak	HORIZONTAL

Item 3, 4 are the fundamental frequency at 5190 MHz.

Channel 46

	Freq	Level	Limit	Over	Read	CableAntenna	Preamp	A/Pos	T/Pos	Remark	Pol/Phase	
	MHz	dBuV/m	dBuV/m	dB	dBuV	dB	dB/m	dB	cm	deg		
1	5136.00	65.11	74.00	-8.89	56.35	8.09	33.72	33.05	191	54	Peak	HORIZONTAL
2	5146.00	51.90	54.00	-2.10	43.06	8.15	33.74	33.05	191	54	Average	HORIZONTAL
3	5222.80	117.84			108.73	8.30	33.86	33.05	191	54	Peak	HORIZONTAL
4	5227.20	107.01			97.90	8.30	33.86	33.05	191	54	Average	HORIZONTAL

Item 3, 4 are the fundamental frequency at 5230 MHz.

Temperature	25°C	Humidity	55%
Test Engineer	Stim Sung	Configurations	IEEE 802.11ac MCS0/Nss1 VHT40 CH 151, 159 / Chain 1 + Chain 2 + Chain 3 + Chain 4
Test Date	Nov. 20, 2015		
Test Mode	Mode 1: PIFA Antenna / Chain1:5.84 dBi, Chain2:5.50 dBi, Chain3:5.84 dBi, Chain4:5.65 dBi		

Channel 151

	Freq	Level	Limit	Over	Read	CableAntenna	Preamp	A/Pos	T/Pos	Remark	Pol/Phase
	MHz	dBuV/m	dBuV/m	dB	dBuV	dB	dB/m	dB	cm	deg	
1	5714.20	66.81	68.20	-1.39	57.00	8.51	34.43	33.13	200	76 Peak	HORIZONTAL
2	5723.80	70.64	78.20	-7.56	60.86	8.47	34.44	33.13	200	76 Peak	HORIZONTAL
3	5762.60	110.27			100.56	8.39	34.46	33.14	200	76 Peak	HORIZONTAL
4	5763.00	98.84			89.13	8.39	34.46	33.14	200	76 Average	HORIZONTAL

Item 3, 4 are the fundamental frequency at 5755 MHz.

Channel 159

	Freq	Level	Limit	Over	Read	CableAntenna	Preamp	A/Pos	T/Pos	Remark	Pol/Phase
	MHz	dBuV/m	dBuV/m	dB	dBuV	dB	dB/m	dB	cm	deg	
1	5781.00	115.96			106.29	8.35	34.47	33.15	226	78 Peak	HORIZONTAL
2	5783.80	105.45			95.78	8.35	34.47	33.15	226	78 Average	HORIZONTAL
3	5850.00	68.26	78.20	-9.94	58.36	8.56	34.51	33.17	226	78 Peak	HORIZONTAL
4	5860.00	67.07	68.20	-1.13	57.09	8.64	34.52	33.18	226	78 Peak	HORIZONTAL

Item 1, 2 are the fundamental frequency at 5795 MHz.

Temperature	25°C	Humidity	55%
Test Engineer	Stim Sung	Configurations	IEEE 802.11ac MCS0/Nss1 VHT80 CH 42, 155 / Chain 1 + Chain 2 + Chain 3 + Chain 4
Test Date	Nov. 20, 2015		
Test Mode	Mode 1: PIFA Antenna / Chain1:5.84 dBi, Chain2:5.50 dBi, Chain3:5.84 dBi, Chain4:5.65 dBi		

Channel 42

	Freq	Level	Limit	Over	Read	CableAntenna	Preamp	A/Pos	T/Pos	Remark	Pol/Phase
	MHz	dBuV/m	dBuV/m	dB	dBuV	dB	dB/m	dB	cm	deg	
1	5144.93	52.98	54.00	-1.02	44.14	8.15	33.74	33.05	219	50 Average	HORIZONTAL
2	5146.38	63.59	74.00	-10.41	54.75	8.15	33.74	33.05	219	50 Peak	HORIZONTAL
3	5226.64	105.62			96.51	8.30	33.86	33.05	219	50 Peak	HORIZONTAL
4	5226.64	95.64			86.53	8.30	33.86	33.05	219	50 Average	HORIZONTAL
5	5350.00	48.87	54.00	-5.13	39.67	8.20	34.06	33.06	219	50 Average	HORIZONTAL
6	5381.11	63.06	74.00	-10.94	53.83	8.18	34.11	33.06	219	50 Peak	HORIZONTAL

Item 3, 4 are the fundamental frequency at 5210 MHz.

Channel 155

	Freq	Level	Limit	Over	Read	CableAntenna	Preamp	A/Pos	T/Pos	Remark	Pol/Phase
	MHz	dBuV/m	dBuV/m	dB	dBuV	dB	dB/m	dB	cm	deg	
1	5711.38	66.79	68.20	-1.41	56.98	8.51	34.43	33.13	207	318 Peak	HORIZONTAL
2	5725.00	67.06	78.20	-11.14	57.28	8.47	34.44	33.13	207	318 Peak	HORIZONTAL
3	5764.15	93.34			83.64	8.39	34.46	33.15	207	318 Average	HORIZONTAL
4	5767.04	103.32			93.62	8.39	34.46	33.15	207	318 Peak	HORIZONTAL
5	5851.45	63.56	78.20	-14.64	53.66	8.56	34.51	33.17	207	318 Peak	HORIZONTAL
6	5860.00	63.34	68.20	-4.86	53.36	8.64	34.52	33.18	207	318 Peak	HORIZONTAL

Item 3, 4 are the fundamental frequency at 5775 MHz.

Note:

Emission level (dBuV/m) = 20 log Emission level (uV/m)

Corrected Reading: Antenna Factor + Cable Loss + Read Level - Preamp Factor = Level

4.8. Frequency Stability Measurement

4.8.1. Limit

In-band emission is maintained within the band of operation under all conditions of normal operation as specified in the user's manual.

The transmitter center frequency tolerance shall be ± 20 ppm maximum for the 5 GHz band (IEEE 802.11n specification).

4.8.2. Measuring Instruments and Setting

Please refer to section 5 of equipments list in this report. The following table is the setting of the spectrum analyzer.

Spectrum Parameter	Setting
Attenuation	Auto
Span Frequency	Entire absence of modulation emissions bandwidth
RBW	10 kHz
VBW	10 kHz
Sweep Time	Auto

4.8.3. Test Procedures

1. The transmitter output (antenna port) was connected to the spectrum analyzer.
2. EUT have transmitted absence of modulation signal and fixed channelize.
3. Set the spectrum analyzer span to view the entire absence of modulation emissions bandwidth.
4. Set RBW = 10 kHz, VBW = 10 kHz with peak detector and maxhold settings.
5. f_c is declaring of channel frequency. Then the frequency error formula is $(f_c - f) / f_c \times 10^6$ ppm and the limit is less than ± 20 ppm (IEEE 802.11n specification).
6. Allow sufficient time (approximately 30 min) for the temperature of the chamber to stabilize, turn the EUT on and measure the operating frequency after 2, 5, and 10 minutes.
7. The test extreme voltage is to change the primary supply voltage from 85 to 115 percent of the nominal value
8. Extreme temperature is $-20^\circ\text{C} \sim 50^\circ\text{C}$.

4.8.4. Test Setup Layout

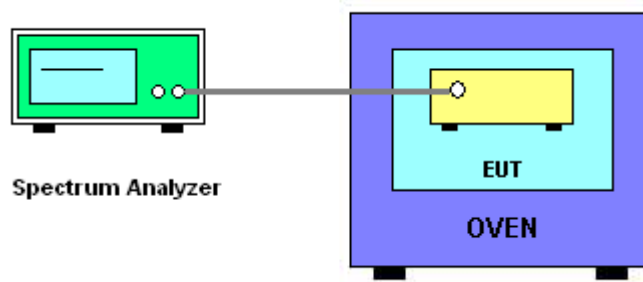

4.8.5. Test Deviation

There is no deviation with the original standard.

4.8.6. EUT Operation during Test

The EUT was programmed to be in continuously un-modulation transmitting mode.

4.8.7. Test Result of Frequency Stability

Temperature	25°C	Humidity	50%
Test Engineer	Eddie Weng & Lucas Huang	Test Date	Oct. 20, 2015
Test Mode	Mode 1: PIFA Antenna / Chain1:5.84 dBi, Chain2:5.50 dBi, Chain3:5.84 dBi, Chain4:5.65 dBi		

Mode: 20 MHz / Chain 4

Voltage vs. Frequency Stability

Voltage (V)	Measurement Frequency (MHz)			
	5200 MHz			
	0 Minute	2 Minute	5 Minute	10 Minute
126.50	5200.0559	5200.0545	5200.0527	5200.0506
110.00	5200.0547	5200.0534	5200.0518	5200.0499
93.50	5200.0533	5200.0522	5200.0510	5200.0488
Max. Deviation (MHz)	0.0559	0.0545	0.0527	0.0506
Max. Deviation (ppm)	10.75	10.48	10.13	9.73
Result	Complies			

Temperature vs. Frequency Stability

Temperature (°C)	Measurement Frequency (MHz)			
	5200 MHz			
	0 Minute	2 Minute	5 Minute	10 Minute
-20	5200.0601	5200.0588	5200.0571	5200.0547
-10	5200.0586	5200.0574	5200.0558	5200.0539
0	5200.0572	5200.0560	5200.0541	5200.0519
10	5200.0559	5200.0546	5200.0531	5200.0513
20	5200.0547	5200.0534	5200.0518	5200.0499
30	5200.0533	5200.0522	5200.0508	5200.0492
40	5200.0517	5200.0502	5200.0486	5200.0466
50	5200.0500	5200.0488	5200.0473	5200.0446
Max. Deviation (MHz)	0.0601	0.0588	0.0571	0.0547
Max. Deviation (ppm)	11.56	11.31	10.98	10.52
Result	Complies			

Voltage vs. Frequency Stability

Voltage	Measurement Frequency (MHz)			
(V)	5785 MHz			
	0 Minute	2 Minute	5 Minute	10 Minute
126.50	5785.0586	5785.0572	5785.0554	5785.0533
110.00	5785.0574	5785.0561	5785.0545	5785.0526
93.50	5785.0560	5785.0549	5785.0537	5785.0515
Max. Deviation (MHz)	0.0586	0.0572	0.0554	0.0533
Max. Deviation (ppm)	10.13	9.89	9.58	9.21
Result	Complies			

Temperature vs. Frequency Stability

Temperature	Measurement Frequency (MHz)			
(°C)	5785 MHz			
	0 Minute	2 Minute	5 Minute	10 Minute
-20	5785.0628	5785.0615	5785.0598	5785.0574
-10	5785.0613	5785.0601	5785.0585	5785.0566
0	5785.0599	5785.0587	5785.0568	5785.0546
10	5785.0586	5785.0573	5785.0558	5785.0540
20	5785.0574	5785.0561	5785.0545	5785.0526
30	5785.0560	5785.0549	5785.0535	5785.0519
40	5785.0544	5785.0529	5785.0513	5785.0493
50	5785.0527	5785.0515	5785.0500	5785.0473
Max. Deviation (MHz)	0.0628	0.0615	0.0598	0.0574
Max. Deviation (ppm)	10.86	10.63	10.34	9.92
Result	Complies			

Mode: 40 MHz / Chain 4
Voltage vs. Frequency Stability

Voltage	Measurement Frequency (MHz)			
(V)	5190 MHz			
	0 Minute	2 Minute	5 Minute	10 Minute
126.50	5190.0510	5190.0496	5190.0478	5190.0457
110.00	5190.0498	5190.0485	5190.0469	5190.0450
93.50	5190.0484	5190.0473	5190.0461	5190.0439
Max. Deviation (MHz)	0.0510	0.0496	0.0478	0.0457
Max. Deviation (ppm)	9.83	9.56	9.21	8.81
Result	Complies			

Temperature vs. Frequency Stability

Temperature	Measurement Frequency (MHz)			
(°C)	5190 MHz			
	0 Minute	2 Minute	5 Minute	10 Minute
-20	5190.0552	5190.0539	5190.0522	5190.0498
-10	5190.0537	5190.0525	5190.0509	5190.0490
0	5190.0523	5190.0511	5190.0492	5190.0470
10	5190.0510	5190.0497	5190.0482	5190.0464
20	5190.0498	5190.0485	5190.0469	5190.0450
30	5190.0484	5190.0473	5190.0459	5190.0443
40	5190.0468	5190.0453	5190.0437	5190.0417
50	5190.0451	5190.0439	5190.0424	5190.0397
Max. Deviation (MHz)	0.0552	0.0539	0.0522	0.0498
Max. Deviation (ppm)	10.64	10.39	10.06	9.60
Result	Complies			

Voltage vs. Frequency Stability

Voltage	Measurement Frequency (MHz)			
(V)	5755 MHz			
	0 Minute	2 Minute	5 Minute	10 Minute
126.50	5755.0635	5755.0621	5755.0603	5755.0582
110.00	5755.0623	5755.0610	5755.0594	5755.0575
93.50	5755.0609	5755.0598	5755.0586	5755.0564
Max. Deviation (MHz)	0.0635	0.0621	0.0603	0.0582
Max. Deviation (ppm)	11.03	10.79	10.48	10.11
Result	Complies			

Temperature vs. Frequency Stability

Temperature	Measurement Frequency (MHz)			
(°C)	5755 MHz			
	0 Minute	2 Minute	5 Minute	10 Minute
-20	5755.0677	5755.0664	5755.0647	5755.0623
-10	5755.0662	5755.0650	5755.0634	5755.0615
0	5755.0648	5755.0636	5755.0617	5755.0595
10	5755.0635	5755.0622	5755.0607	5755.0589
20	5755.0623	5755.0610	5755.0594	5755.0575
30	5755.0609	5755.0598	5755.0584	5755.0568
40	5755.0593	5755.0578	5755.0562	5755.0542
50	5755.0576	5755.0564	5755.0549	5755.0522
Max. Deviation (MHz)	0.0677	0.0664	0.0647	0.0623
Max. Deviation (ppm)	11.76	11.54	11.24	10.83
Result	Complies			

Mode: 80 MHz / Chain 4
Voltage vs. Frequency Stability

Voltage	Measurement Frequency (MHz)			
(V)	5210 MHz			
	0 Minute	2 Minute	5 Minute	10 Minute
126.50	5210.0603	5210.0589	5210.0571	5210.0550
110.00	5210.0591	5210.0578	5210.0562	5210.0543
93.50	5210.0577	5210.0566	5210.0554	5210.0532
Max. Deviation (MHz)	0.0603	0.0589	0.0571	0.0550
Max. Deviation (ppm)	11.57	11.31	10.96	10.56
Result	Complies			

Temperature vs. Frequency Stability

Temperature	Measurement Frequency (MHz)			
(°C)	5210 MHz			
	0 Minute	2 Minute	5 Minute	10 Minute
-20	5210.0645	5210.0632	5210.0615	5210.0591
-10	5210.0630	5210.0618	5210.0602	5210.0583
0	5210.0616	5210.0604	5210.0585	5210.0563
10	5210.0603	5210.0590	5210.0575	5210.0557
20	5210.0591	5210.0578	5210.0562	5210.0543
30	5210.0577	5210.0566	5210.0552	5210.0536
40	5210.0561	5210.0546	5210.0530	5210.0510
50	5210.0544	5210.0532	5210.0517	5210.0490
Max. Deviation (MHz)	0.0645	0.0632	0.0615	0.0591
Max. Deviation (ppm)	12.38	12.13	11.80	11.34
Result	Complies			

Voltage vs. Frequency Stability

Voltage (V)	Measurement Frequency (MHz)			
	5775 MHz			
	0 Minute	2 Minute	5 Minute	10 Minute
126.50	5775.0427	5775.0413	5775.0395	5775.0374
110.00	5775.0415	5775.0402	5775.0386	5775.0367
93.50	5775.0401	5775.0390	5775.0378	5775.0356
Max. Deviation (MHz)	0.0427	0.0413	0.0395	0.0374
Max. Deviation (ppm)	7.39	7.15	6.84	6.48
Result	Complies			

Temperature vs. Frequency Stability

Temperature (°C)	Measurement Frequency (MHz)			
	5775 MHz			
	0 Minute	2 Minute	5 Minute	10 Minute
-20	5775.0469	5775.0456	5775.0439	5775.0415
-10	5775.0454	5775.0442	5775.0426	5775.0407
0	5775.0440	5775.0428	5775.0409	5775.0387
10	5775.0427	5775.0414	5775.0399	5775.0381
20	5775.0415	5775.0402	5775.0386	5775.0367
30	5775.0401	5775.0390	5775.0376	5775.0360
40	5775.0385	5775.0370	5775.0354	5775.0334
50	5775.0368	5775.0356	5775.0341	5775.0314
Max. Deviation (MHz)	0.0469	0.0456	0.0439	0.0415
Max. Deviation (ppm)	8.12	7.90	7.60	7.19
Result	Complies			

4.9. Antenna Requirements

4.9.1. Limit

Except for special regulations, the Low-power Radio-frequency Devices must not be equipped with any jacket for installing an antenna with extension cable. An intentional radiator shall be designed to ensure that no antenna other than that furnished by the responsible party shall be used with the device. The use of a permanently attached antenna or of an antenna that uses a unique coupling to the intentional radiator shall be considered sufficient to comply with the provisions of this Section. The manufacturer may design the unit so that the user can replace a broken antenna, but the use of a standard antenna jack or electrical connector is prohibited. Further, this requirement does not apply to intentional radiators that must be professionally installed.

4.9.2. Antenna Connector Construction

Please refer to section 3.3 in this test report; antenna connector complied with the requirements.

5. LIST OF MEASURING EQUIPMENTS

Conducted Emission

Instrument	Manufacturer	Model No.	Serial No.	Characteristics	Calibration Date	Remark
EMC Receiver	R&S	ESR3	102051	9KHz ~ 3.6GHz	29/Apr/2017	Conduction (CO04-HY)
LISN	R&S	ENV216	101295	9kHz ~ 30MHz	15/Nov/2016	Conduction (CO04-HY)
RF Cable-CON	HUBER+SUHNER	RG213/U	07611832020001	9kHz ~ 30MHz	24/Oct/2016	Conduction (CO04-HY)
Impuls Begrenzer Pulse Limiter	R&S	ESH3-Z2	100921	10 kHz ~ 30 MHz	20/Oct/2016	Conduction (CO04-HY)

Radiated Emission Below 1GHz

Instrument	Manufacturer	Model No.	Serial No.	Characteristics	Calibration Date	Remark
Spectrum Analyzer	R&S	FSP40	100593	9KHz - 40GHz	26/Oct/2016	03CH02-HY
3m Semi Anechoic	SIDT FRANKONIA	SAC-3M	03CH02-HY	30MHz-1GHz	21/Oct/2016	03CH02-HY
Amplifier	Agilent	8447D	2944A11149	100KHz-1.3GHz	29/Jun/2017	03CH02-HY
Bilog Antenna	SCHAFFNER	CBL6112B	2723	30MHz-1GHz	01/Oct/2016	03CH02-HY
RF Cable-R03m	Jye Bao	RG142	CB017	9kHz ~ 1GHz	26/Jan/2017	03CH02-HY
Receiver	R&S	ESU-26	100422/026	20Hz ~ 26.5GHz	21/Sep/2016	03CH02-HY
Loop Antenna	TESEQ	HLA 6120	24155	9 kHz~30 MHz	02/Mar/2017	03CH02-HY

Radiated Emission Above 1GHz

Instrument	Manufacturer	Model No.	Serial No.	Characteristics	Calibration Date	Remark
Horn Antenna	EMCO	3115	00075790	750MHz ~ 18GHz	Oct. 28, 2014	Radiation (03CH01-CB)
Horn Antenna	EMCO	3115	00075790	750MHz ~ 18GHz	Oct. 22, 2015	Radiation (03CH01-CB)
Pre-Amplifier	Agilent	8449B	3008A02310	1GHz ~ 26.5GHz	Jan. 12, 2015	Radiation (03CH01-CB)
Pre-Amplifier	WM	TF-130N-R1	923365	26GHz ~ 40GHz	Feb.10, 2015	Radiation (03CH01-CB)
Spectrum Analyzer	R&S	FSP40	100056	9kHz ~ 40GHz	Oct. 27, 2015	Radiation (03CH01-CB)
RF Cable-high	Woken	High Cable-16	N/A	1 GHz ~ 18 GHz	Nov. 02, 2015	Radiation (03CH01-CB)
RF Cable-high	Woken	High Cable-17	N/A	1 GHz ~ 18 GHz	Nov. 02, 2015	Radiation (03CH01-CB)
RF Cable-high	Woken	High Cable-40G-1	N/A	18GHz ~ 40 GHz	Nov. 02, 2015	Radiation (03CH01-CB)
RF Cable-high	Woken	High Cable-40G-2	N/A	18GHz ~ 40 GHz	Nov. 02, 2015	Radiation (03CH01-CB)

Conducted

Instrument	Manufacturer	Model No.	Serial No.	Characteristics	Calibration Date	Remark
Spectrum analyzer	R&S	FSV40	100979	9kHz~40GHz	Dec. 12, 2014	Conducted (TH01-CB)
Temp. and Humidity Chamber	Ten Billion	TTH-D3SP	TBN-931011	-30~100 degree	Jun. 02, 2015	Conducted (TH01-CB)
RF Cable-high	Woken	RG402	High Cable-7	1 GHz – 26.5 GHz	Nov. 15, 2014	Conducted (TH01-CB)
RF Cable-high	Woken	RG402	High Cable-7	1 GHz – 26.5 GHz	Nov. 02, 2015	Conducted (TH01-CB)
RF Cable-high	Woken	RG402	High Cable-8	1 GHz – 26.5 GHz	Nov. 15, 2014	Conducted (TH01-CB)
RF Cable-high	Woken	RG402	High Cable-8	1 GHz – 26.5 GHz	Nov. 02, 2015	Conducted (TH01-CB)
RF Cable-high	Woken	RG402	High Cable-9	1 GHz – 26.5 GHz	Nov. 15, 2014	Conducted (TH01-CB)
RF Cable-high	Woken	RG402	High Cable-9	1 GHz – 26.5 GHz	Nov. 02, 2015	Conducted (TH01-CB)
RF Cable-high	Woken	RG402	High Cable-10	1 GHz – 26.5 GHz	Nov. 15, 2014	Conducted (TH01-CB)
RF Cable-high	Woken	RG402	High Cable-10	1 GHz – 26.5 GHz	Nov. 02, 2015	Conducted (TH01-CB)
RF Cable-high	Woken	RG402	High Cable-6	1 GHz – 26.5 GHz	Nov. 15, 2014	Conducted (TH01-CB)
RF Cable-high	Woken	RG402	High Cable-6	1 GHz – 26.5 GHz	Nov. 02, 2015	Conducted (TH01-CB)
Power Sensor	Agilent	U2021XA	MY53410001	50MHz~18GHz	Nov. 03, 2014	Conducted (TH01-CB)
Power Sensor	Agilent	U2021XA	MY53410001	50MHz~18GHz	Nov. 02, 2015	Conducted (TH01-CB)

Note: Calibration Interval of instruments listed above is one year.

“*” Calibration Interval of instruments listed above is two years.

N.C.R. means Non-Calibration required.

6. MEASUREMENT UNCERTAINTY

Test Items	Uncertainty	Remark
Conducted Emission (150kHz ~ 30MHz)	2.2 dB	Confidence levels of 95%
Radiated Emission (30MHz ~ 1,000MHz)	2.1 dB	Confidence levels of 95%
Radiated Emission (1GHz ~ 18GHz)	3.7 dB	Confidence levels of 95%
Radiated Emission (18GHz ~ 40GHz)	3.5 dB	Confidence levels of 95%
Conducted Emission	1.7 dB	Confidence levels of 95%

Appendix B. Radiated Emission Co-location Report

1. Results of Radiated Emissions for Co-located

Temperature	25°C	Humidity	55%
Test Engineer	Stim Sung	Configurations	2.4GHz + 5GHz

Horizontal

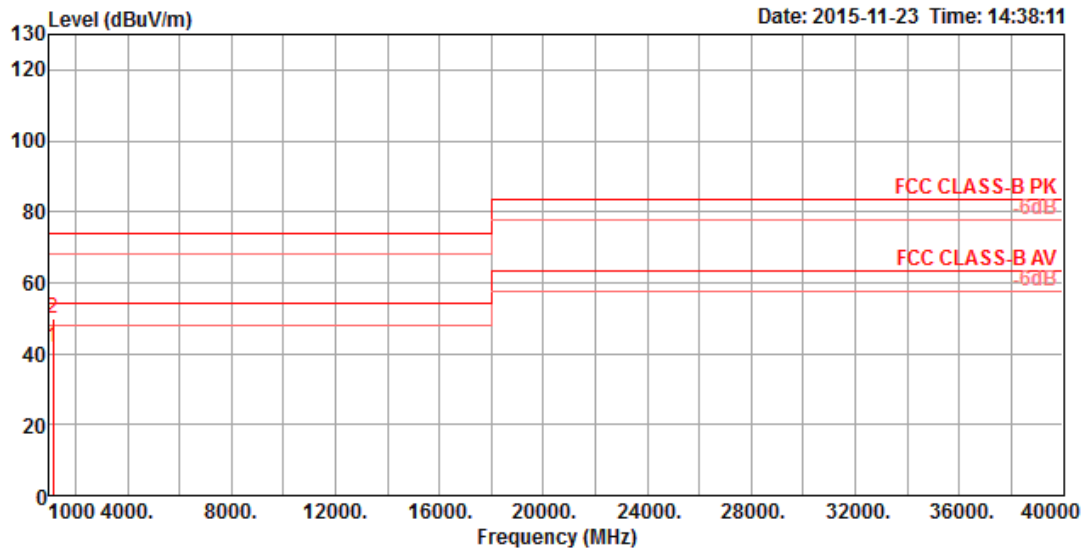

	Freq	Level	Limit Line	Over Limit	Read Level	CableAntenna Loss	Antenna Factor	Preamp Factor	A/Pos	T/Pos	Remark	Pol/Phase
	MHz	dBuV/m	dBuV/m	dB	dBuV	dB	dB/m	dB	cm	deg		
1	1129.38	41.78	54.00	-12.22	50.83	3.35	24.77	37.17	100	350	Average	HORIZONTAL
2	1129.38	49.78	74.00	-24.22	58.83	3.35	24.77	37.17	100	350	Peak	HORIZONTAL

Vertical

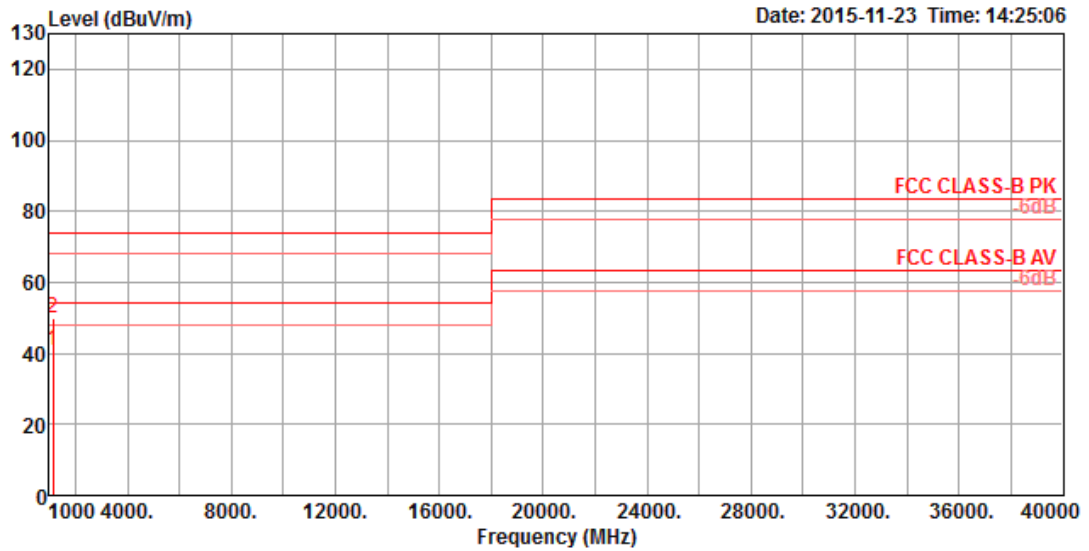

	Freq	Level	Limit Line	Over Limit	Read Level	CableAntenna Loss	Antenna Factor	Preamp Factor	A/Pos	T/Pos	Remark	Pol/Phase
	MHz	dBuV/m	dBuV/m	dB	dBuV	dB	dB/m	dB	cm	deg		
1	1129.38	41.00	54.00	-13.00	50.05	3.35	24.77	37.17	100	285	Average	VERTICAL
2	1129.38	50.00	74.00	-24.00	59.05	3.35	24.77	37.17	100	285	Peak	VERTICAL