



SPORTON International Inc.

No. 52, Huaya 1st Rd., Guishan Dist., Taoyuan City, Taiwan (R.O.C.)
Ph: 886-3-327-3456 / FAX: 886-3-327-0973 / www.sporton.com.tw

FCC RADIO TEST REPORT

Applicant's company	Allied Telesis K.K
Applicant Address	2nd. TOC Bldg. 7-21-11 Nishi-Gotanda, Shinagawa-ku, Tokyo Japan, 141-0031
FCC ID	RSL-MWS2533AP
Manufacturer's company	Senao Networks, Inc.
Manufacturer Address	3F, No. 529, Chung Cheng Rd., Hsintien, Taipei, Taiwan

Product Name	IEEE 802.a/b/g/n/ac Managed Wireless Access Point
Brand Name	
Model No.	AT-MWS2533AP
Test Rule Part(s)	47 CFR FCC Part 15 Subpart C § 15.247
Test Freq. Range	2400 ~ 2483.5MHz
Received Date	Oct. 15, 2015
Final Test Date	Aug. 15, 2017
Submission Type	Original Equipment

Statement

Test result included is only for the IEEE 802.11b/g, IEEE 802.11n and IEEE 802.11ac of the product.

The test result in this report refers exclusively to the presented test model / sample.

Without written approval of SPORTON International Inc., the test report shall not be reproduced except in full.

The measurements and test results shown in this test report were made in accordance with the procedures and found in compliance with the limit given in **ANSI C63.10-2013**,

47 CFR FCC Part 15 Subpart C, KDB558074 D01 v04 and KDB 662911 D01 v02r01, KDB644545 D03 v01.

The test equipment used to perform the test is calibrated and traceable to NML/ROC.



Table of Contents

1. VERIFICATION OF COMPLIANCE	1
2. SUMMARY OF THE TEST RESULT	2
3. GENERAL INFORMATION	3
3.1. Product Details	3
3.2. Accessories	4
3.3. Table for Filed Antenna	5
3.4. Table for Carrier Frequencies	6
3.5. Table for Test Modes	7
3.6. Table for Testing Locations.....	9
3.7. Table for Supporting Units	10
3.8. Table for Parameters of Test Software Setting	11
3.9. EUT Operation during Test	11
3.10. Duty Cycle.....	11
3.11. Test Configurations.....	12
4. TEST RESULT.....	15
4.1. AC Power Line Conducted Emissions Measurement	15
4.2. Maximum Conducted Output Power Measurement.....	19
4.3. Power Spectral Density Measurement.....	21
4.4. 6dB Spectrum Bandwidth Measurement	28
4.5. Radiated Emissions Measurement.....	33
4.6. Emissions Measurement.....	46
4.7. Antenna Requirements	56
5. LIST OF MEASURING EQUIPMENTS.....	57
6. MEASUREMENT UNCERTAINTY	59
APPENDIX A. TEST PHOTOS	
APPENDIX B. RADIATED EMISSION CO-LOCATION REPORT	
PHOTOGRAPHS OF EUT V02	



History of This Test Report

REPORT NO.	VERSION	DESCRIPTION	ISSUED DATE
FR720735-01AC	Rev. 01	Initial issue of report	Sep. 12, 2017
FR720735-01AC	Rev. 02	Revise the test data	Oct. 13, 2017

1. VERIFICATION OF COMPLIANCE

Product Name : IEEE 802.a/b/g/n/ac Managed Wireless Access Point

Brand Name : 

Model No. : AT-MWS2533AP

Applicant : Allied Telesis K.K

Test Rule Part(s) : 47 CFR FCC Part 15 Subpart C § 15.247

Sporton International as requested by the applicant to evaluate the EMC performance of the product sample received on Oct. 15, 2015 would like to declare that the tested sample has been evaluated and found to be in compliance with the tested rule parts. The data recorded as well as the test configuration specified is true and accurate for showing the sample's EMC nature.

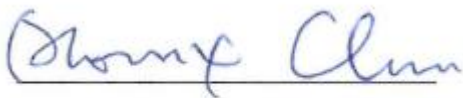

Phoenix Chen

SPORTON INTERNATIONAL INC.

2. SUMMARY OF THE TEST RESULT

Applied Standard: 47 CFR FCC Part 15 Subpart C				
Part	Rule Section	Description of Test	Result	Under Limit
4.1	15.207	AC Power Line Conducted Emissions	Complies	5.3 dB
4.2	15.247(b)(3)	Maximum Conducted Output Power	Complies	0.81 dB
4.3	15.247(e)	Power Spectral Density	Complies	7.09 dB
4.4	15.247(a)(2)	6dB Spectrum Bandwidth	Complies	-
4.5	15.247(d)	Radiated Emissions	Complies	3.12 dB
4.6	15.247(d)	Band Edge Emissions	Complies	1.07 dB
4.7	15.203	Antenna Requirements	Complies	-

3. GENERAL INFORMATION

3.1. Product Details

Items	Description
Product Type	WLAN (4TX, 4RX)
Radio Type	Intentional Transceiver
Power Type	From power adapter or PoE
Modulation	IEEE 802.11b: DSSS IEEE 802.11g: OFDM IEEE 802.11n/ac: see the below table
Data Modulation	IEEE 802.11b: DSSS (BPSK / QPSK / CCK) IEEE 802.11g/n: OFDM (BPSK / QPSK / 16QAM / 64QAM) IEEE 802.11ac: OFDM (BPSK / QPSK / 16QAM / 64QAM / 256QAM)
Data Rate (Mbps)	IEEE 802.11b: DSSS (1/ 2/ 5.5/11) IEEE 802.11g: OFDM (6/9/12/18/24/36/48/54) IEEE 802.11n/ac: see the below table
Frequency Range	2400 ~ 2483.5MHz
Channel Number	11 for 20MHz bandwidth ; 7 for 40MHz bandwidth
Channel Band Width (99%)	Mode 1: PIFA Antenna / Chain1:3.81 dBi, Chain2:3.75 dBi, Chain3:3.98 dBi, Chain4:3.47 dBi IEEE 802.11ac MCS0/Nss1 (VHT20): 18.06 MHz IEEE 802.11ac MCS0/Nss1 (VHT40): 37.05 MHz
Maximum Conducted Output Power	Mode 1: PIFA Antenna / Chain1:3.81 dBi, Chain2:3.75 dBi, Chain3:3.98 dBi, Chain4:3.47 dBi IEEE 802.11ac MCS0/Nss1 (VHT20): 25.41 dBm IEEE 802.11ac MCS0/Nss1 (VHT40): 19.60 dBm
Carrier Frequencies	Please refer to section 3.4
Antenna	Please refer to section 3.3

Items	Description
Beamforming Function	<input checked="" type="checkbox"/> With beamforming <input type="checkbox"/> Without beamforming

Note1: The product has beamforming function for 802.11n/ac in 2.4G/5G.

Note2: Test results of non-beamforming are recorded in test report: FR720735-01AA. Test results of beamforming are recorded in this test report.

Antenna and Band width

Antenna	Four (TX)	
	20 MHz	40 MHz
IEEE 802.11b	√	X
IEEE 802.11g	√	X
IEEE 802.11n	√	√
IEEE 802.11ac	√	√

IEEE 11n/ac Spec.

Protocol	Number of Transmit Chains (NTX)	Data Rate / MCS
802.11n (HT20)	4	MCS 0-31
802.11n (HT40)	4	MCS 0-31
802.11ac (VHT20)	4	MCS 0-8/Nss1-4
802.11ac (VHT40)	4	MCS 0-9/Nss1-4

Note 1: IEEE Std. 802.11n modulation consists of HT20 and HT40 (HT: High Throughput).

Then EUT supports HT20 and HT40.

Note 2: IEEE Std. 802.11ac modulation consists of VHT20, VHT40, VHT80 and VHT160 (VHT: Very High Throughput). Then EUT supports VHT20 and VHT40 in 2.4GHz.

Note 3: Modulation modes consist of below configuration:

HT20/HT40: IEEE 802.11n, VHT20/VHT40: IEEE 802.11ac

3.2. Accessories

N/A

3.3. Table for Filed Antenna

Set.	Brand Holder	Model Number (Part No.)	Extreme Part No. (Short Description)	Antenna Type	Connector	Polarized Antenna	Gain (dBi)	
							2.4GHz	5GHz
1	Senao Networks, Inc.	AP3935i	-	PIFA Antenna	IPEX	X	Note 1	

Note1:

Set.	Antenna Gain (dBi)							
	2.4GHz				5GHz			
	Chain 1	Chain 2	Chain 3	Chain 4	Chain 1	Chain 2	Chain 3	Chain 4
1	3.81	3.75	3.98	3.47	5.84	5.50	5.84	5.65

<For 2.4GHz Function>

For IEEE 802.11b/g/n/ac mode (4TX, 4RX):

Chain 1, Chain 2, Chain 3 and Chain 4 could transmit/receive simultaneously.

<For 5GHz Function>

For IEEE 802.11a/n/ac mode (4TX, 4RX):

Chain 1, Chain 2, Chain 3 and Chain 4 could transmit/receive simultaneously.

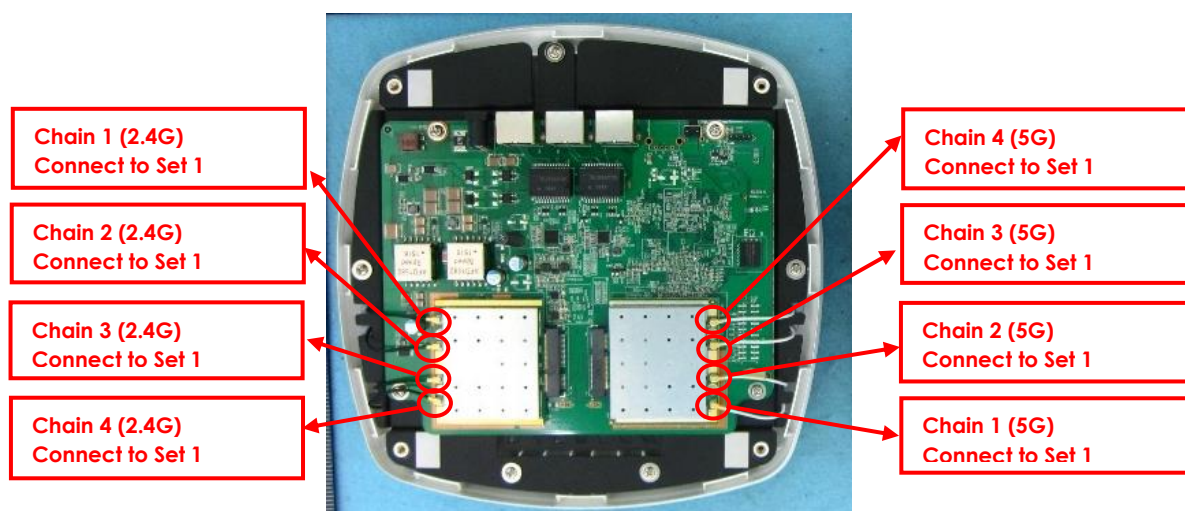

3.4. Table for Carrier Frequencies

There are two bandwidth systems.

For 20MHz bandwidth systems, use Channel 1~Channel 11.

For 40MHz bandwidth systems, use Channel 3~Channel 9.

Frequency Band	Channel No.	Frequency	Channel No.	Frequency
2400~2483.5MHz	1	2412 MHz	7	2442 MHz
	2	2417 MHz	8	2447 MHz
	3	2422 MHz	9	2452 MHz
	4	2427 MHz	10	2457 MHz
	5	2432 MHz	11	2462 MHz
	6	2437 MHz	-	-

3.5. Table for Test Modes

Preliminary tests were performed in different data rate to find the worst radiated emission. The data rate shown in the table below is the worst-case rate with respect to the specific test item. Investigation has been done on all the possible configurations for searching the worst cases. The following table is a list of the test modes shown in this test report.

Test Items	Mode	Data Rate	Channel	Chain
AC Power Line Conducted Emissions	Normal Link	-	-	-
Maximum Conducted Output Power	11ac VHT20	MCS0/Nss1	1/6/11	1+2+3+4
	11ac VHT40	MCS0/Nss1	3/6/9	1+2+3+4
Power Spectral Density	11ac VHT20	MCS0/Nss1	1/6/11	1+2+3+4
	11ac VHT40	MCS0/Nss1	3/6/9	1+2+3+4
6dB Spectrum Bandwidth	11ac VHT20	MCS0/Nss1	1/6/11	1+2+3+4
	11ac VHT40	MCS0/Nss1	3/6/9	1+2+3+4
Radiated Emissions 9kHz~1GHz	Normal Link	-	-	-
Radiated Emissions 1GHz~10 th Harmonic	11ac VHT20	MCS0/Nss1	1/6/11	1+2+3+4
	11ac VHT40	MCS0/Nss1	3/6/9	1+2+3+4
Band Edge Emissions	11ac VHT20	MCS0/Nss1	1/6/11	1+2+3+4
	11ac VHT40	MCS0/Nss1	3/6/9	1+2+3+4

Note1: VHT20/VHT40 covers HT20/HT40, due to same modulation. The power setting for 802.11n HT20 and HT40 are the same or lower than 802.11ac VHT20 and VHT40.

Note2:

The adapter and PoE are for measurement only, would not be marketed.

The adapter and PoE information as below:

Power	Brand	Model
Adapter	APD	WA-24Q12R
PoE	Microsemi	PD-9001GR

Note3: All the specification of test configurations and test modes were based on customer's request.

Note4: The console port can not be used by end user. It is generally used for updating FW by professional installer.

The following test modes were performed for all tests:

For Conducted Emission test:

Mode 1. Normal Link + Adapter

For Radiated Emission Below 1GHz test:

Mode 1. Place EUT in Z axis + Adapter

Mode 2. Place EUT in Z axis + PoE

Mode 1 is the worst case, so it was selected to record in this test report.

For Radiated Emission Above 1GHz test:

The EUT was performed at Y axis and Z axis position. Y axis has been evaluated to be the worst case, thus measurement will follow this same test mode.

Mode 1. Place EUT in Y axis

For Co-location MPE and Radiated Emission Co-location Test:

The EUT could be applied with 2.4GHz WLAN function and 5GHz WLAN function; therefore Co-location Maximum Permissible Exposure (Please refer to FA720735-01AB) and Radiated Emission Co-location (please refer to Appendix B) tests are added for simultaneously transmit between 2.4GHz WLAN function and 5GHz WLAN function.

3.6. Table for Testing Locations

Test Site Location				
Address:	No.8, Lane 724, Bo-ai St., Jhubei City, Hsinchu County 302, Taiwan, R.O.C.			
TEL:	886-3-656-9065			
FAX:	886-3-656-9085			
Test Site No.	Site Category	Location	FCC Reg. No.	IC File No.
03CH01-CB	SAC	Hsin Chu	262045	IC 4086D
TH01-CB	OVEN Room	Hsin Chu	-	-

Open Area Test Site (OATS); Semi Anechoic Chamber (SAC).

Testing Location			
<input checked="" type="checkbox"/>	HWA YA	ADD : No. 52, Huaya 1st Rd., Guishan Dist., Taoyuan City, Taiwan (R.O.C.)	
		TEL : 886-3-327-3456	FAX : 886-3-327-0973
Test site Designation No. TW1190 with FCC.			
Test site registered number IC 4086B-1 with Industry Canada.			

Test Condition	Test Site No.	Test Engineer	Test Environment	Test Date
Radiated	03CH02-HY	Thor Wei	23°C / 66%	12/Aug/2017
AC Conduction	CO04-HY	Teddy Chang	22°C / 55%	15/Aug/2017

3.7. Table for Supporting Units

For Test Site No: 03CH02-HY (For Below 1GHz)

Support Unit	Brand	Model	FCC ID
Load	-	-	N/A
Notebook	DELL	E6400	N/A
Adapter (Client Provided)	APD	WA-24Q12R	N/A

For Test Site No: 03CH01-CB (For Above 1GHz)

Support Unit	Brand	Model	FCC ID
Notebook*2	DELL	E4300	DoC
Device	Extreme Networks	31012	QXO-4411AC
Adapter (Client Provided)	APD	WA-24Q12R	N/A

For Test Site No: CO04-HY

Support Unit	Brand	Model	FCC ID
Adapter (Client Provided)	APD	WA-24Q12R	N/A
Dummy Load	-	-	N/A
Notebook	DELL	E5430	DoC
Notebook(2.4G)	DELL	P55G	DoC
Notebook(5G)	DELL	P55G	DoC

For Test Site No: TH01-CB

Support Unit	Brand	Model	FCC ID
Notebook	DELL	E4300	DoC
Adapter (Client Provided)	APD	WA-24Q12R	N/A

3.8. Table for Parameters of Test Software Setting

During testing, Channel and Power Controlling Software provided by the customer was used to control the operating channel as well as the output power level. The RF output power selection is for the setting of RF output power expected by the customer and is going to be fixed on the firmware of the final end product.

Mode 1: PIFA Antenna / Chain1:3.81 dBi, Chain2:3.75 dBi, Chain3:3.98 dBi, Chain4:3.47 dBi

Test Software Version		QCA VER3.0.144.0					
Mode		Test Frequency (MHz)					
		NCB: 20MHz			NCB: 40MHz		
		2412 MHz	2437 MHz	2462 MHz	2422 MHz	2437 MHz	2452 MHz
802.11ac VHT20	MCS0/Nss1	15	18	14	-	-	-
802.11ac VHT40	MCS0/Nss1	-	-	-	12.5	12	11.5

3.9. EUT Operation during Test

The EUT was programmed to be in continuously transmitting mode.

3.10. Duty Cycle

Mode	On Time (ms)	On+Off Time (ms)	Duty Cycle (%)	Duty Factor (dB)	1/T Minimum VBW (kHz)
802.11ac MCS0/Nss1 VHT20	1.728	1.914	90.28	0.44	0.58
802.11ac MCS0/Nss1 VHT40	1.632	1.824	89.47	0.48	0.61

3.11. Test Configurations

3.11.1. AC Power Line Conduction Emissions Test Configuration

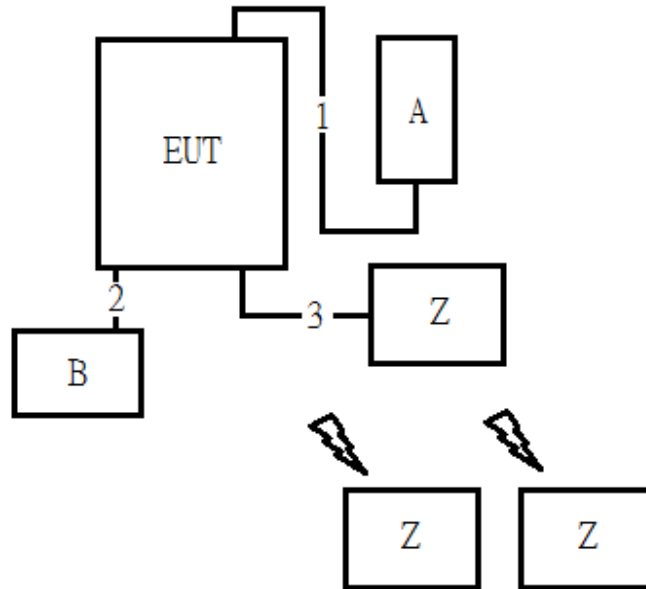

Item	Connection	Shielded	Length(m)
1	DC Power Cable	No	1.5
2	RJ45 Cable	No	1
3	RJ45 Cable	No	10

No.	Equipment	Brand	Model	FCC ID
A	Adapter	APD	WA-24Q12R	N/A
B	Dummy Load	-	-	N/A
Z	NoteBook	DELL	E5430	DoC
Z	NoteBook(2.4G)	DELL	P55G	DoC
Z	NoteBook(5G)	DELL	P55G	DoC

3.11.2. Radiation Emissions Test Configuration

Test Configuration: 30MHz~1GHz

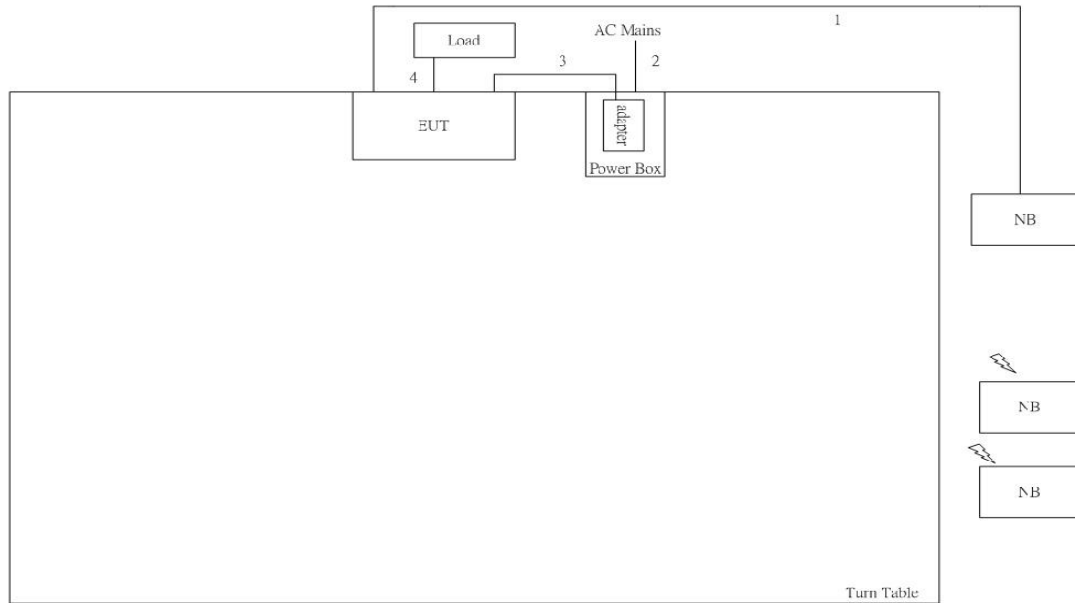

Item	Connection	Shielded	Length(m)
1	LAN Cable	No	10
2	AC Power line	No	1.8
3	DC Power line	No	1.5
4	LAN line	No	3

Test Configuration: above 1GHz

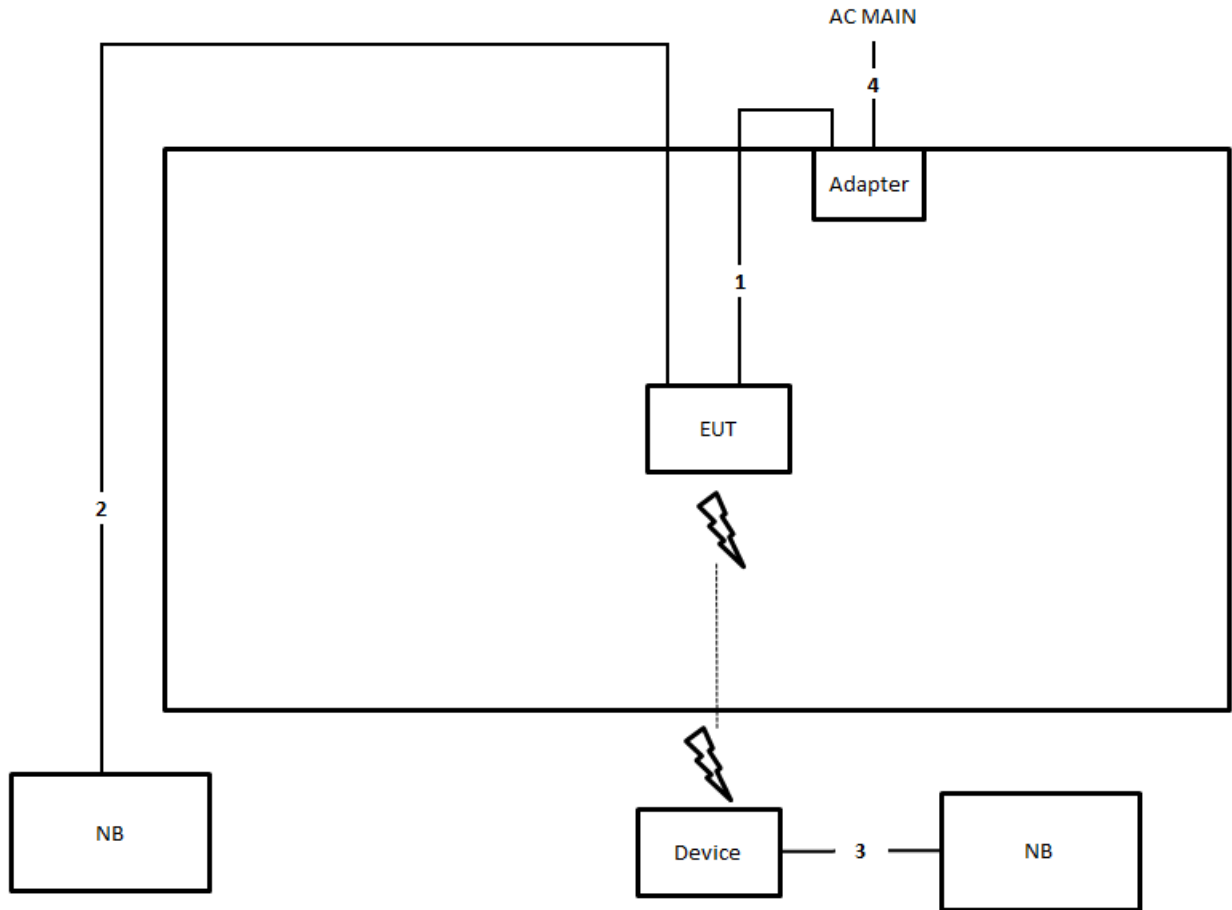

Item	Connection	Shielded	Length(m)
1	DC Power cable	No	1.2
2	RJ-45 cable	No	10
3	RJ-45 cable	No	1.5
4	AC Power cable	No	1.8

4. TEST RESULT

4.1. AC Power Line Conducted Emissions Measurement

4.1.1. Limit

For this product which is designed to be connected to the AC power line, the radio frequency voltage that is conducted back onto the AC power line on any frequency or frequencies within the band 150 kHz to 30 MHz shall not exceed below limits table.

Frequency (MHz)	QP Limit (dBuV)	AV Limit (dBuV)
0.15~0.5	66~56	56~46
0.5~5	56	46
5~30	60	50

4.1.2. Measuring Instruments and Setting

Please refer to section 5 of equipments list in this report. The following table is the setting of the receiver.

Receiver Parameters	Setting
Attenuation	10 dB
Start Frequency	0.15 MHz
Stop Frequency	30 MHz
IF Bandwidth	9 kHz

4.1.3. Test Procedures

1. Configure the EUT according to ANSI C63.10. The EUT or host of EUT has to be placed 0.4 meter far from the conducting wall of the shielding room and at least 80 centimeters from any other grounded conducting surface.
2. Connect EUT or host of EUT to the power mains through a line impedance stabilization network (LISN).
3. All the support units are connected to the other LISNs. The LISN should provide 50uH/50ohms coupling impedance.
4. The frequency range from 150 kHz to 30 MHz was searched.
5. Set the test-receiver system to Peak Detect Function and Specified Bandwidth with Maximum Hold Mode.
6. The measurement has to be done between each power line and ground at the power terminal.

4.1.4. Test Setup Layout

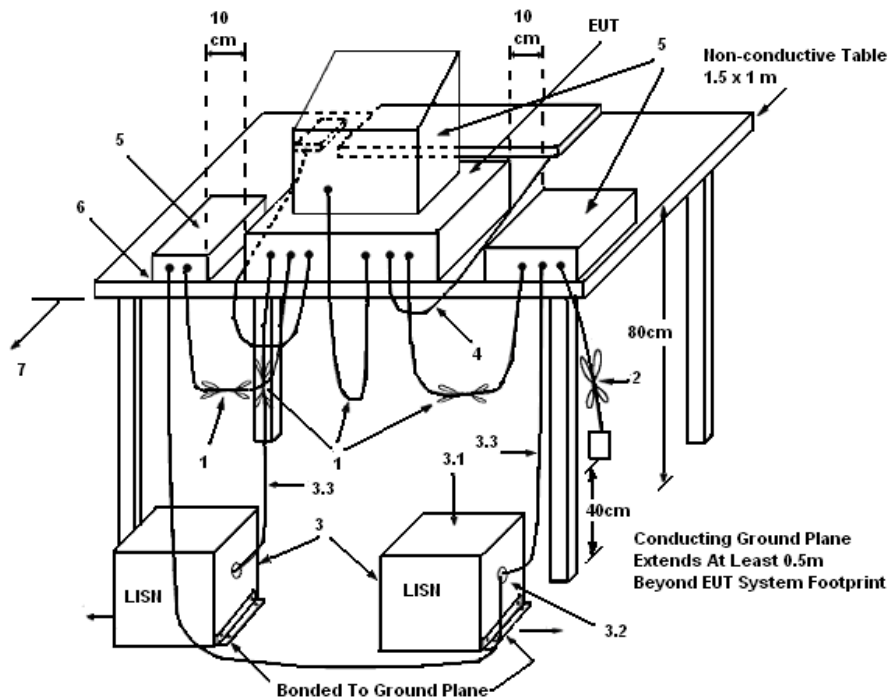

LEGEND:

- (1) Interconnecting cables that hang closer than 40 cm to the ground plane shall be folded back and forth in the center forming a bundle 30 to 40 cm long.
- (2) I/O cables that are not connected to a peripheral shall be bundled in the center. The end of the cable may be terminated, if required, using the correct terminating impedance. The overall length shall not exceed 1 m.
- (3) EUT connected to one LISN. Unused LISN measuring port connectors shall be terminated in 50 Ω . LISN can be placed on top of, or immediately beneath, reference ground plane.
 - (3.1) All other equipment powered from additional LISN(s).
 - (3.2) Multiple outlet strip can be used for multiple power cords of non-EUT equipment.
 - (3.3) LISN at least 80 cm from nearest part of EUT chassis.
- (4) Cables of hand-operated devices, such as keyboards, mice, etc., shall be placed as for normal use.
- (5) Non-EUT components of EUT system being tested.
- (6) Rear of EUT, including peripherals, shall all be aligned and flush with rear of tabletop.
- (7) Rear of tabletop shall be 40 cm removed from a vertical conducting plane that is bonded to the ground plane.

4.1.5. Test Deviation

There is no deviation with the original standard.

4.1.6. EUT Operation during Test

The EUT was placed on the test table and programmed in normal function.

4.1.7. Results of AC Power Line Conducted Emissions Measurement

Temperature	22°C	Humidity	55%
Test Engineer	Teddy Chang	Phase	Line
Configuration	Normal Link	Test Mode	Mode 1

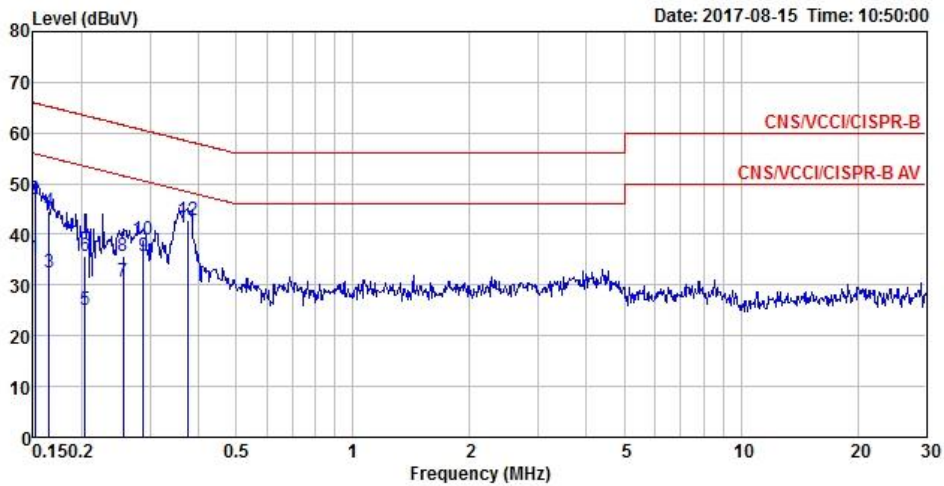

	Freq	Level	Over Limit	Limit Line	Read Level	LISN Factor	Cable Loss	Remark
	MHz	dBuV	dB	dBuV	dBuV	dB	dB	
1	0.15	35.31	-20.60	55.91	25.43	9.66	0.22	Average
2	0.15	46.88	-19.03	65.91	37.00	9.66	0.22	QP
3	0.17	32.33	-22.88	55.21	22.42	9.66	0.25	Average
4	0.17	44.48	-20.73	65.21	34.57	9.66	0.25	QP
5	0.20	25.00	-28.45	53.45	15.06	9.65	0.29	Average
6	0.20	35.68	-27.77	63.45	25.74	9.65	0.29	QP
7	0.26	30.65	-20.91	51.56	20.76	9.66	0.23	Average
8	0.26	35.75	-25.81	61.56	25.86	9.66	0.23	QP
9	0.29	35.66	-14.93	50.59	25.79	9.67	0.20	Average
10	0.29	38.83	-21.76	60.59	28.96	9.67	0.20	QP
11 MAX	0.38	41.35	-7.04	48.39	31.55	9.68	0.12	Average
12	0.38	42.86	-15.53	58.39	33.06	9.68	0.12	QP

Temperature	22°C	Humidity	55%
Test Engineer	Teddy Chang	Phase	Neutral
Configuration	Normal Link	Test Mode	Mode 1

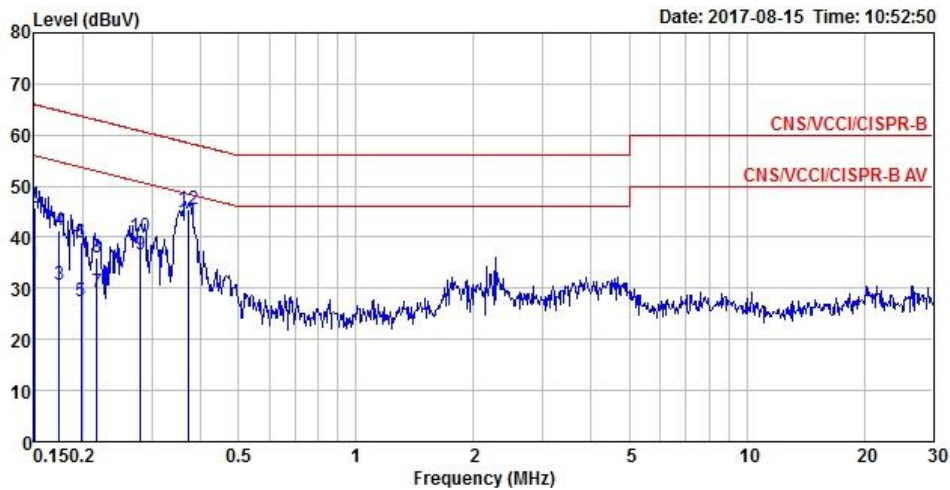

	Freq	Level	Over	Limit	Read	LISN	Cable	Remark
	MHz	dBuV	Limit	Line	Level	Factor	Loss	
			dB	dBuV	dBuV	dB	dB	
1	0.15	34.62	-21.38	56.00	24.80	9.60	0.22	Average
2	0.15	45.82	-20.18	66.00	36.00	9.60	0.22	QP
3	0.17	30.67	-24.10	54.77	20.77	9.64	0.26	Average
4	0.17	41.35	-23.42	64.77	31.45	9.64	0.26	QP
5	0.20	27.43	-26.28	53.71	17.46	9.67	0.30	Average
6	0.20	39.01	-24.70	63.71	29.04	9.67	0.30	QP
7	0.22	29.30	-23.62	52.92	19.37	9.66	0.27	Average
8	0.22	36.02	-26.90	62.92	26.09	9.66	0.27	QP
9	0.28	36.73	-14.08	50.81	26.88	9.65	0.20	Average
10	0.28	40.02	-20.79	60.81	30.17	9.65	0.20	QP
11 MAX	0.37	43.17	-5.30	48.47	33.42	9.63	0.12	Average
12	0.37	45.52	-12.95	58.47	35.77	9.63	0.12	QP

Note:

Level = Read Level + LISN Factor + Cable Loss.

4.2. Maximum Conducted Output Power Measurement

4.2.1. Limit

The limit for output power is 30dBm.

4.2.2. Measuring Instruments and Setting

Please refer to section 5 of equipments list in this report. The following table is the setting of the power meter.

Power Meter Parameter	Setting
Bandwidth	50MHz bandwidth is greater than the EUT emission bandwidth
Detector	Average

4.2.3. Test Procedures

1. Test procedures refer KDB558074 D01 v04 section 9.2.3.2 Measurement using a power meter (PM).
2. Multiple antenna systems was performed in accordance with KDB 662911 D01 v02r01 Emissions Testing of Transmitters with Multiple Outputs in the Same Band.
3. This procedure provides an alternative for determining the RMS output power using a broadband RF average power meter with a thermocouple detector.

4.2.4. Test Setup Layout

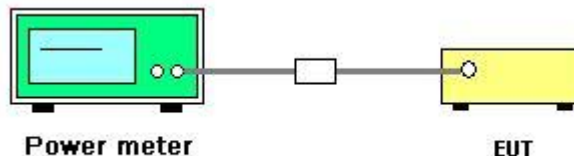

4.2.5. Test Deviation

There is no deviation with the original standard.

4.2.6. EUT Operation during Test

The EUT was programmed to be in continuously transmitting mode.

4.2.7. Test Result of Maximum Conducted Output Power

Temperature	25°C	Humidity	50%
Test Engineer	Eddie Weng & Lucas Huang	Test Date	Nov. 27, 2015
Test Mode	Mode 1: PIFA Antenna / Chain1:3.81 dBi, Chain2:3.75 dBi, Chain3:3.98 dBi, Chain4:3.47 dBi		

Mode	Frequency	Conducted Power (dBm)					Max. Limit (dBm)	Result
		Chain 1	Chain 2	Chain 3	Chain 4	Total		
802.11ac MCS0/Nss1 VHT20	2412 MHz	17.12	15.25	15.87	15.47	22.01	26.22	Complies
	2437 MHz	18.54	21.32	18.36	18.56	25.41	26.22	Complies
	2462 MHz	14.22	15.08	14.36	17.1	21.37	26.22	Complies
802.11ac MCS0/Nss1 VHT40	2422 MHz	13.58	13.37	13.72	13.64	19.60	26.22	Complies
	2437 MHz	12.91	13.33	13.68	13.02	19.27	26.22	Complies
	2452 MHz	12.45	12.75	13.89	12.33	18.92	26.22	Complies

Note: $DirectionalGain = 10 \cdot \log \left[\frac{\sum_{j=1}^{N_{SS}} \left\{ \sum_{k=1}^{N_{ANT}} g_{j,k} \right\}^2}{N_{ANT}} \right] = 9.78\text{dBi} > 6\text{dBi}$, So Limit = $30 - (9.78 - 6) = 26.22\text{dBm}$.

4.3. Power Spectral Density Measurement

4.3.1. Limit

For digitally modulated systems, the power spectral density conducted from the intentional radiator to the antenna shall not be greater than 8 dBm in any 3 kHz band during any time interval of continuous transmission.

4.3.2. Measuring Instruments and Setting

Please refer to section 5 of equipments list in this report. The following table is the setting of the spectrum analyzer.

Spectrum Parameter	Setting
Attenuation	Auto
Span Frequency	Set the span to 1.5 times the DTS channel bandwidth.
RBW	$3 \text{ kHz} \leq \text{RBW} \leq 100\text{kHz}$
VBW	$\geq 3 \times \text{RBW}$
Detector	Peak
Trace	Max Hold
Sweep Time	Auto couple

4.3.3. Test Procedures

1. Test was performed in accordance with KDB558074 D01 v04 for Performing Compliance Measurements on Digital Transmission Systems (DTS) - section 10.2 Method PKPSD (peak PSD) and KDB 662911 D01 v02r01 section In-Band Power Spectral Density (PSD) Measurements option (b) Measure and sum spectral maximal across the outputs.
2. Use this procedure when the maximum conducted output power in the fundamental emission is used to demonstrate compliance. The EUT must be configured to transmit continuously at full power over the measurement duration.
3. Ensure that the number of measurement points in the sweep $\geq 2 \times \text{span}/\text{RBW}$ (use of a greater number of measurement points than this minimum requirement is recommended).
4. Use the peak marker function to determine the maximum level in any 3 kHz band segment within the fundamental EBW.
5. The resulting PSD level must be $\leq 8 \text{ dBm}$.

4.3.4. Test Setup Layout

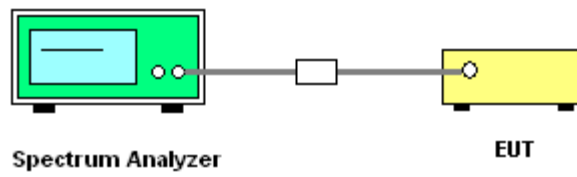

4.3.5. Test Deviation

There is no deviation with the original standard.

4.3.6. EUT Operation during Test

The EUT was programmed to be in continuously transmitting mode.

4.3.7. Test Result of Power Spectral Density

Temperature	25°C	Humidity	50%
Test Engineer	Eddie Weng & Lucas Huang		
Test Mode	Mode 1: PIFA Antenna / Chain1:3.81 dBi, Chain2:3.75 dBi, Chain3:3.98 dBi, Chain4:3.47 dBi		

Mode	Frequency	Power Density (dBm/3kHz)					Power Density Limit (dBm/3kHz)	Result
		Chain 1	Chain 2	Chain 3	Chain 4	Total		
802.11ac MCS0/Nss1 VHT20	2412 MHz	-12.33	-12.96	-11.30	-12.51	-6.21	4.22	Complies
	2437 MHz	-8.11	-9.00	-8.76	-9.87	-2.87	4.22	Complies
	2462 MHz	-12.93	-11.64	-13.15	-14.87	-6.98	4.22	Complies
802.11ac MCS0/Nss1 VHT40	2422 MHz	-16.55	-15.58	-15.77	-15.83	-9.90	4.22	Complies
	2437 MHz	-16.78	-17.20	-17.21	-17.96	-11.25	4.22	Complies
	2452 MHz	-18.08	-16.14	-16.83	-18.71	-11.30	4.22	Complies

Note: $DirectionalGain = 10 \cdot \log \left[\frac{\sum_{j=1}^{N_{SS}} \left\{ \sum_{k=1}^{N_{ANT}} g_{j,k} \right\}^2}{N_{ANT}} \right] = 9.78\text{dBi} > 6\text{dBi}$, So Limit = $8 - (9.78 - 6) = 4.22\text{dBm}/3\text{kHz}$.

Note: All the test values were listed in the report.

For plots, only the channel with worse result was shown.

Mode 1: PIFA Antenna / Chain1:3.81 dBi, Chain2:3.75 dBi, Chain3:3.98 dBi, Chain4:3.47 dBi
Power Density Plot on Configuration IEEE 802.11ac MCS0/Nss1 VHT20 / 2437 MHz / Chain 1

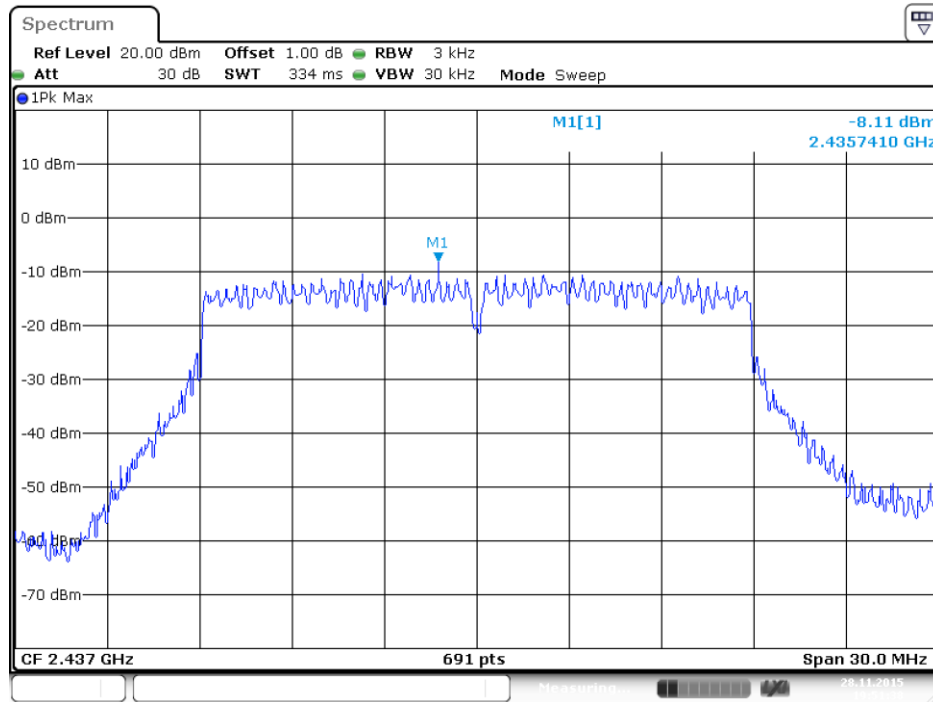

Power Density Plot on Configuration IEEE 802.11ac MCS0/Nss1 VHT20 / 2437 MHz / Chain 2

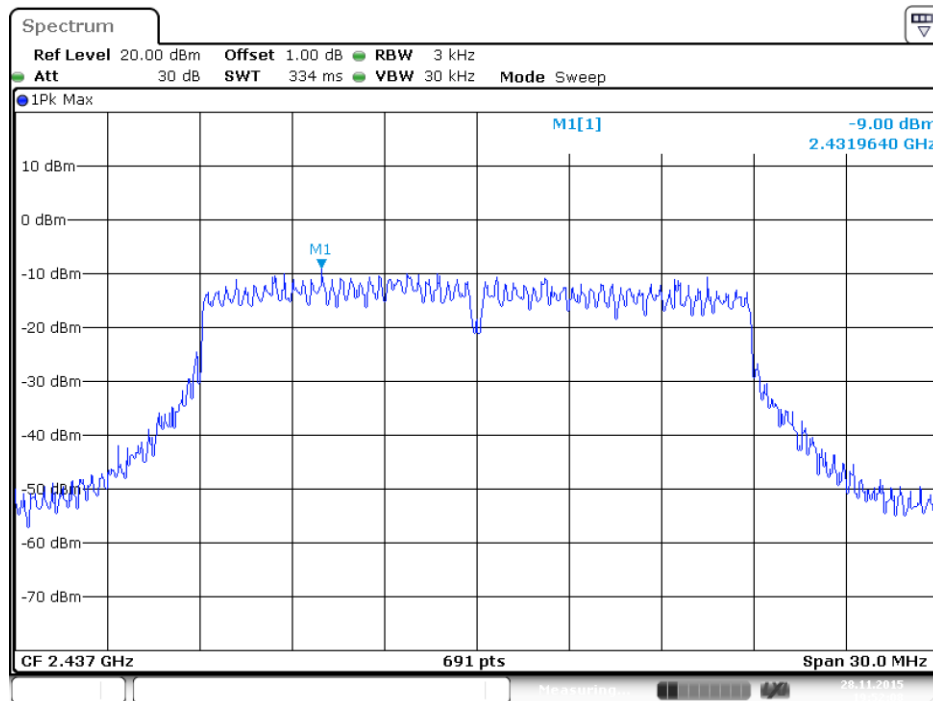

Power Density Plot on Configuration IEEE 802.11ac MCS0/Nss1 VHT20 / 2437 MHz / Chain 3

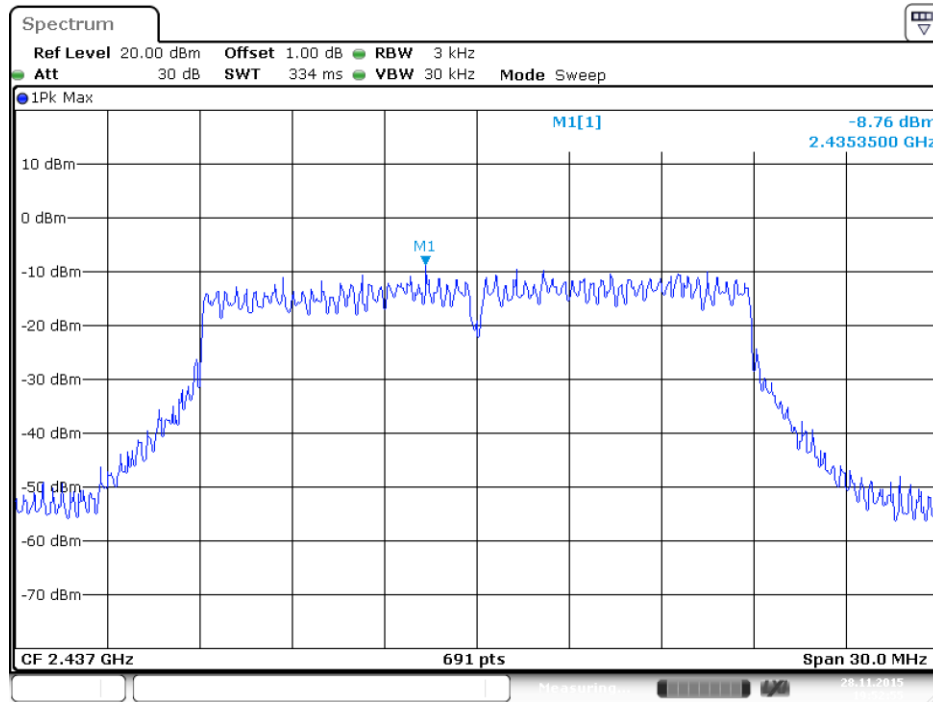

Power Density Plot on Configuration IEEE 802.11ac MCS0/Nss1 VHT20 / 2437 MHz / Chain 4

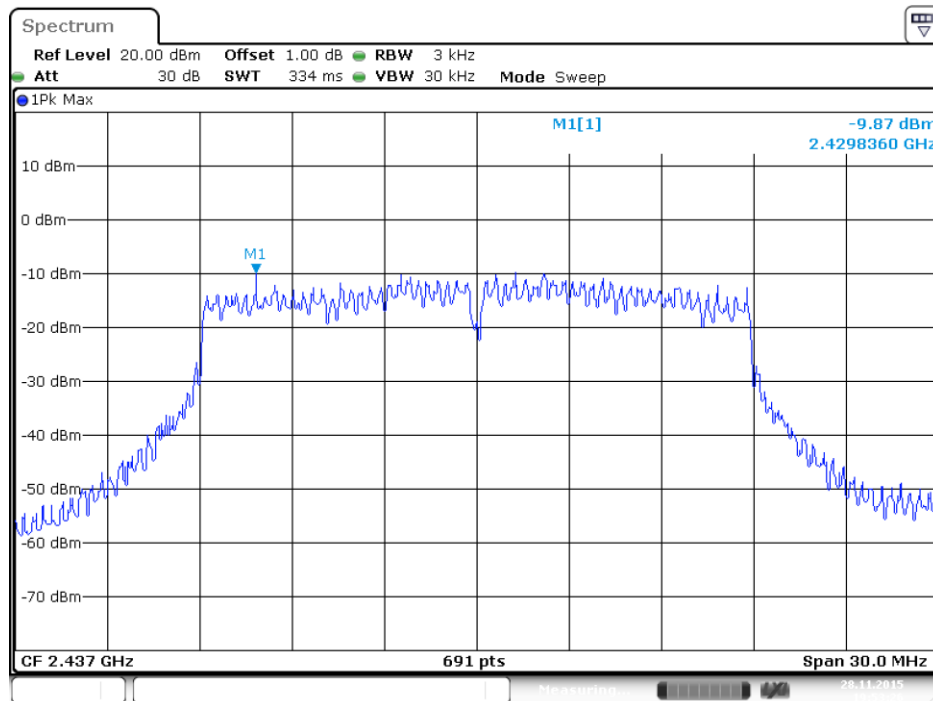

Power Density Plot on Configuration IEEE 802.11ac MCS0/Nss1 VHT40 / 2422 MHz / Chain 1

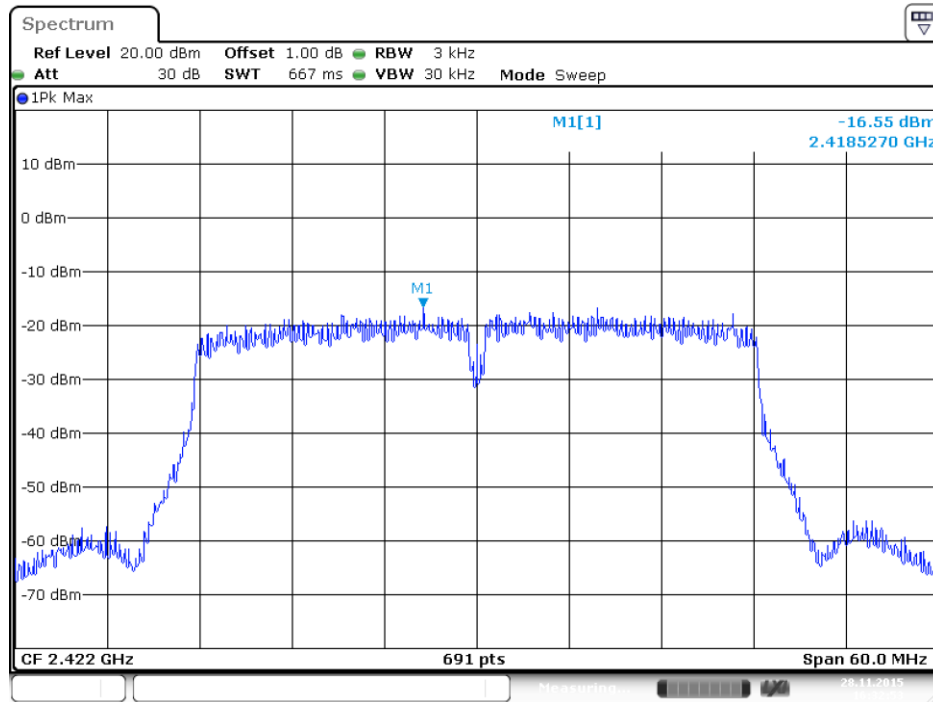

Power Density Plot on Configuration IEEE 802.11ac MCS0/Nss1 VHT40 / 2422 MHz / Chain 2

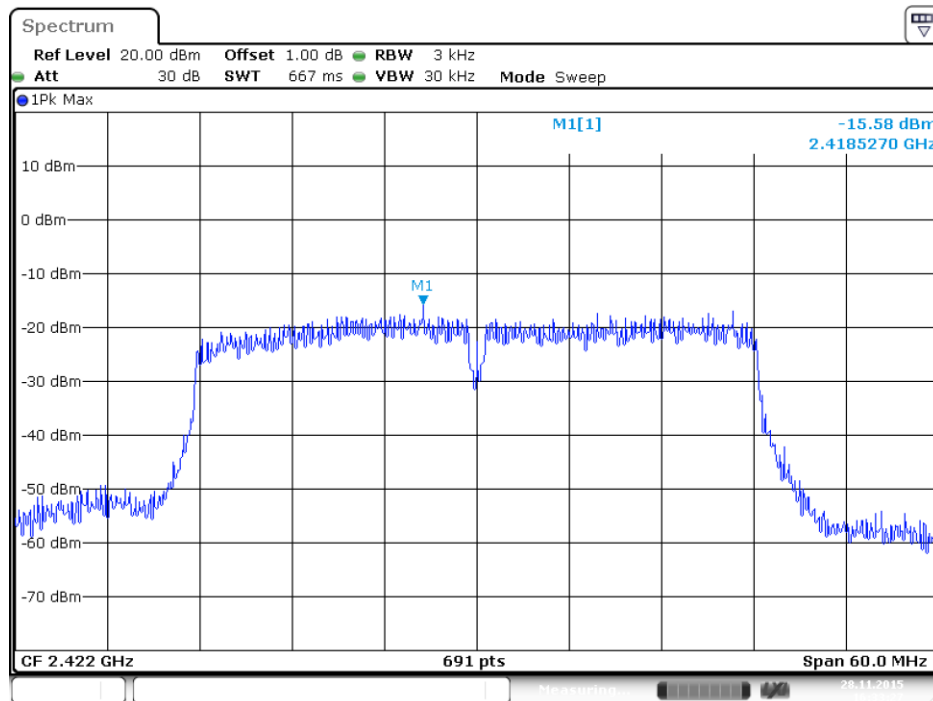

Power Density Plot on Configuration IEEE 802.11ac MCS0/Nss1 VHT40 / 2422 MHz / Chain 3

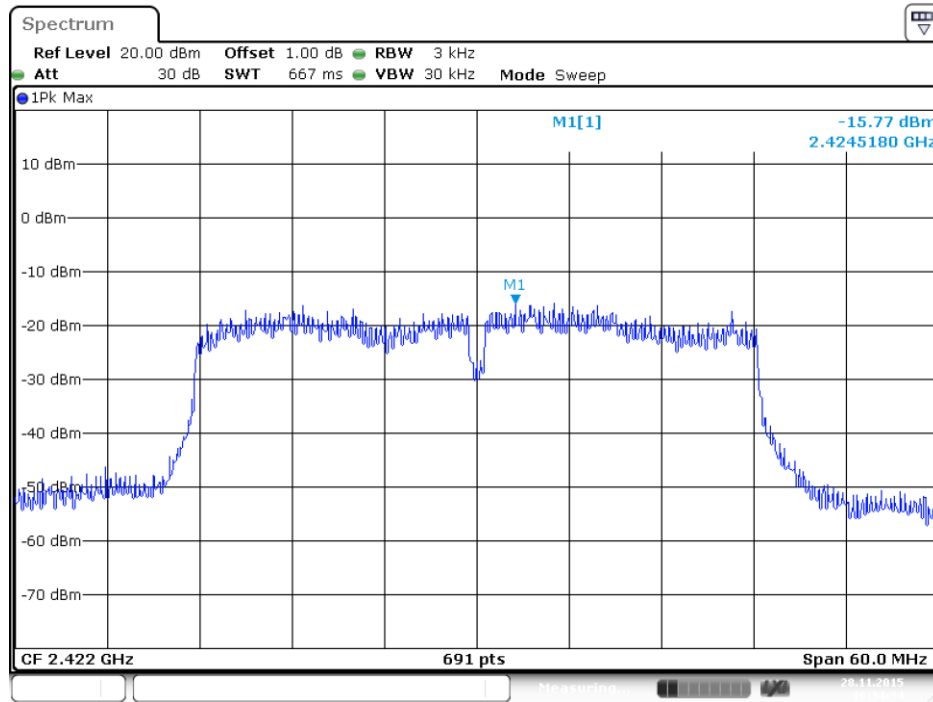

Power Density Plot on Configuration IEEE 802.11ac MCS0/Nss1 VHT40 / 2422 MHz / Chain 4

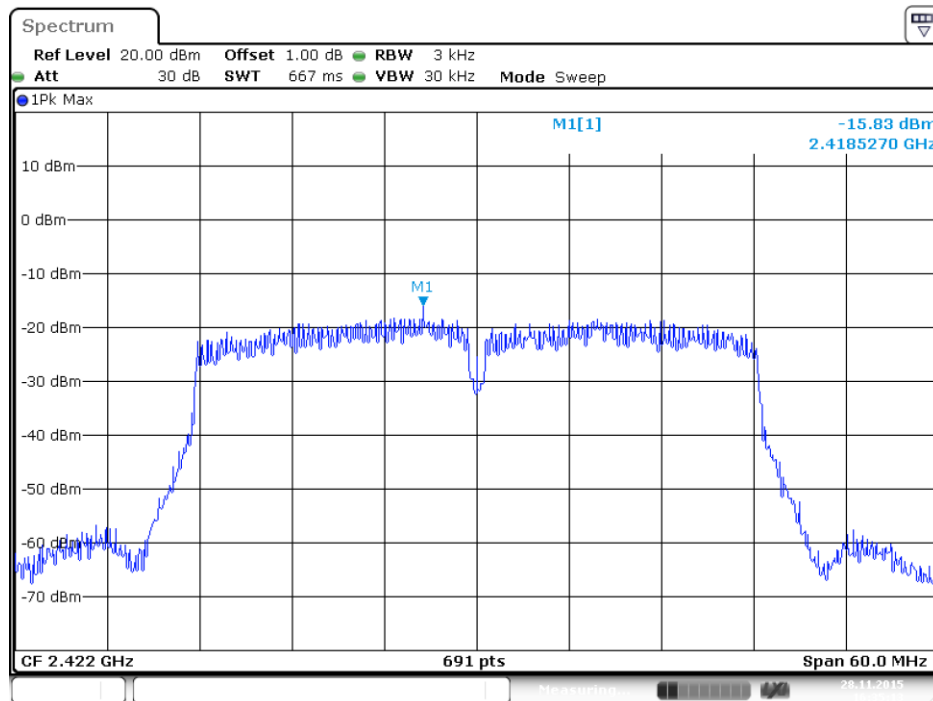

4.4. 6dB Spectrum Bandwidth Measurement

4.4.1. Limit

For digital modulation systems, the minimum 6 dB bandwidth shall be at least 500 kHz.

4.4.2. Measuring Instruments and Setting

Please refer to section 5 of equipments list in this report. The following table is the setting of the Spectrum Analyzer.

6dB Spectrum Bandwidth	
Spectrum Parameters	Setting
Attenuation	Auto
Span Frequency	> 6dB Bandwidth
RBW	100kHz
VBW	$\geq 3 \times \text{RBW}$
Detector	Peak
Trace	Max Hold
Sweep Time	Auto
99% Occupied Bandwidth	
Spectrum Parameters	Setting
Span	1.5 times to 5.0 times the OBW
RBW	1 % to 5 % of the OBW
VBW	$\geq 3 \times \text{RBW}$
Detector	Peak
Trace	Max Hold

4.4.3. Test Procedures

For Radiated 6dB Bandwidth Measurement:

1. The transmitter was radiated to the spectrum analyzer in peak hold mode.
2. Test was performed in accordance with KDB558074 D01 v04 for Performing Compliance Measurements on Digital Transmission Systems (DTS) - section 8.0 DTS bandwidth=> 8.1 Option 1.
3. Multiple antenna system was performed in accordance with KDB 662911 D01 v02r01 Emissions Testing of Transmitters with Multiple Outputs in the Same Band.
4. Measured the spectrum width with power higher than 6dB below carrier.

4.4.4. Test Setup Layout

For Radiated 6dB Bandwidth Measurement:

This test setup layout is the same as that shown in section 4.5.4.

4.4.5. Test Deviation

There is no deviation with the original standard.

4.4.6. EUT Operation during Test

The EUT was programmed to be in continuously transmitting mode.

4.4.7. Test Result of 6dB Spectrum Bandwidth

Temperature	25°C	Humidity	50%
Test Engineer	Eddie Weng & Lucas Huang		
Test Mode	Mode 1: PIFA Antenna / Chain1:3.81 dBi, Chain2:3.75 dBi, Chain3:3.98 dBi, Chain4:3.47 dBi		

Mode	Frequency	6dB Bandwidth (MHz)	99% Occupied Bandwidth (MHz)	Min. Limit (kHz)	Test Result
802.11ac MCS0/Nss1 VHT20	2412 MHz	13.57	18.06	500	Complies
	2437 MHz	14.14	17.97	500	Complies
	2462 MHz	16.64	17.97	500	Complies
802.11ac MCS0/Nss1 VHT40	2422 MHz	30.26	37.05	500	Complies
	2437 MHz	28.87	37.05	500	Complies
	2452 MHz	28.99	36.76	500	Complies

Note: All the test values were listed in the report.

For plots, only the channel with worse result was shown.

Mode 1: PIFA Antenna / Chain1:3.81 dBi, Chain2:3.75 dBi, Chain3:3.98 dBi, Chain4:3.47 dBi
6 dB Bandwidth Plot on Configuration IEEE 802.11ac MCS0/Nss1 VHT20 / 2412 MHz / Chain 1 +
Chain 2 + Chain 3 + Chain 4

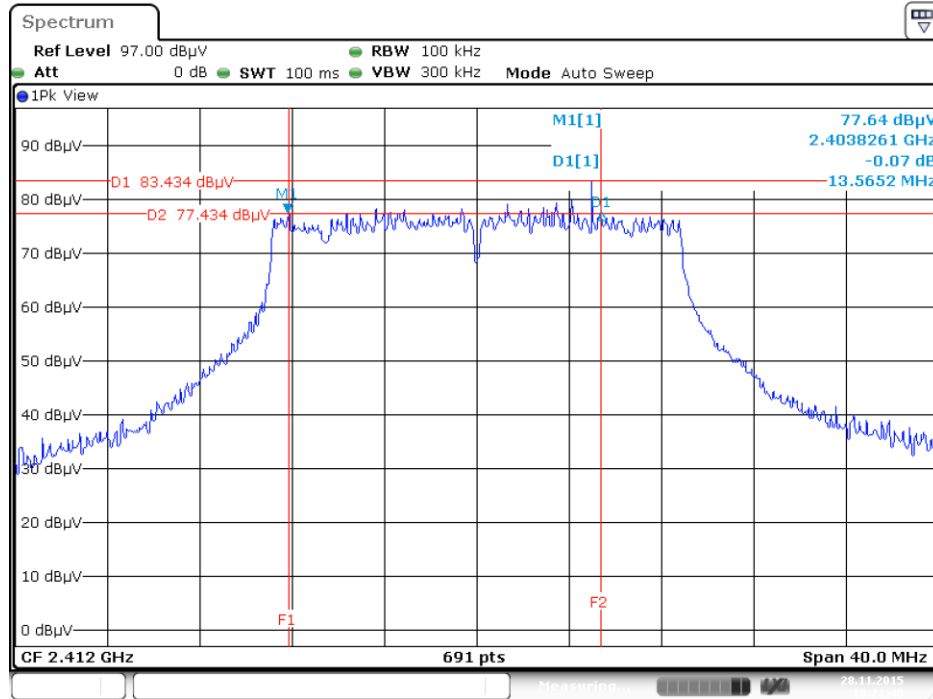

Date: 28.NOV.2015 18:21:40

99% Occupied Bandwidth Plot on Configuration IEEE 802.11ac MCS0/Nss1 VHT20 / 2412 MHz /
Chain 1 + Chain 2 + Chain 3 + Chain 4

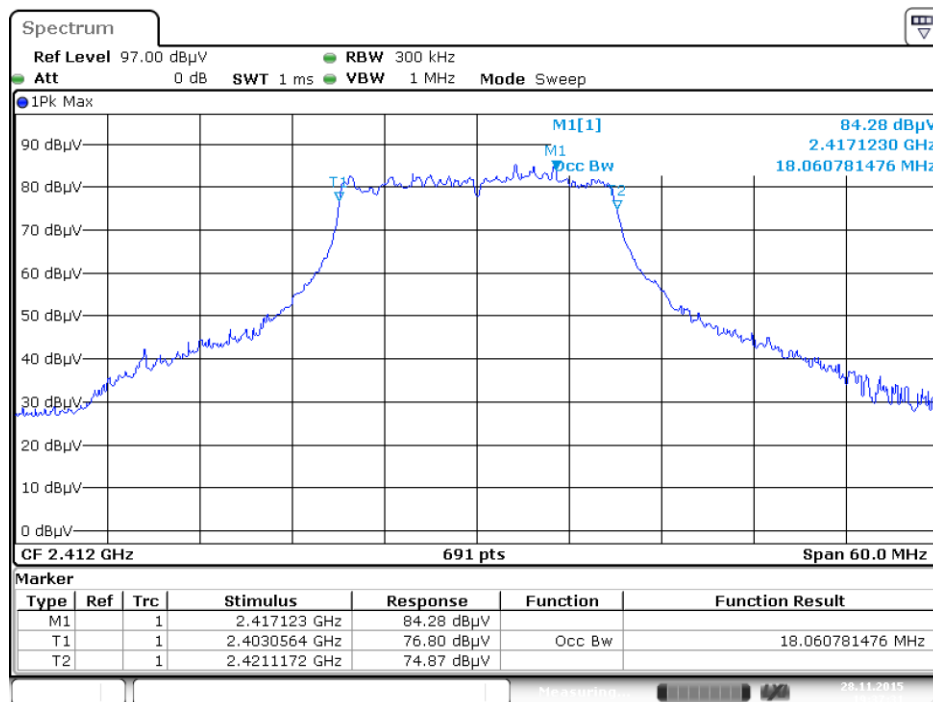

Date: 28.NOV.2015 19:37:31

6 dB Bandwidth Plot on Configuration IEEE 802.11ac MCS0/Nss1 VHT40 / 2437 MHz / Chain 1 + Chain 2 + Chain 3 + Chain 4

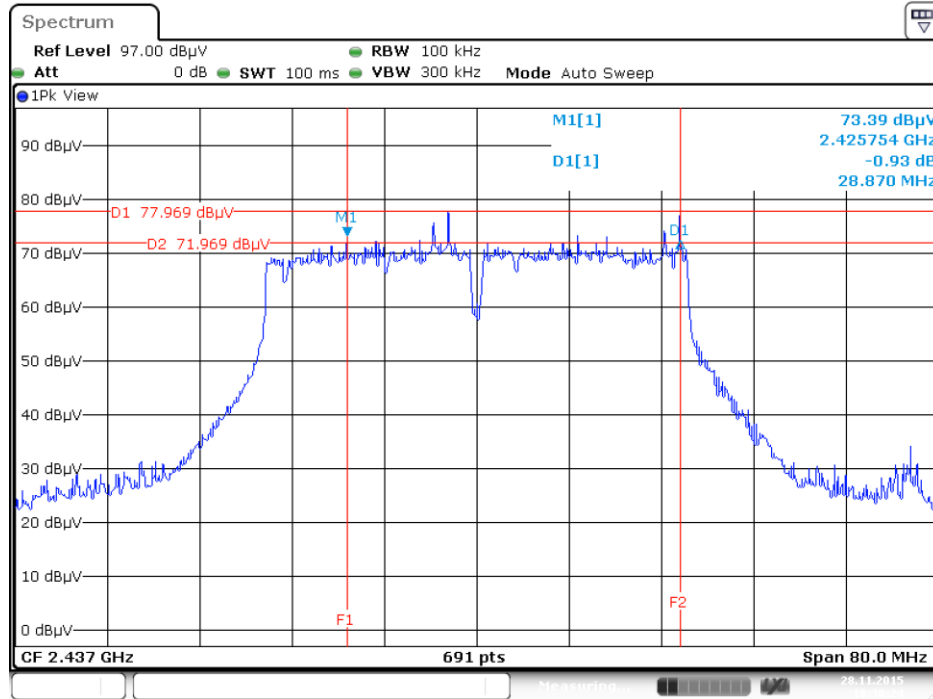

Date: 28.NOV.2015 18:30:24

99% Occupied Bandwidth Plot on Configuration IEEE 802.11ac MCS0/Nss1 VHT40 / 2422 MHz / Chain 1 + Chain 2 + Chain 3 + Chain 4

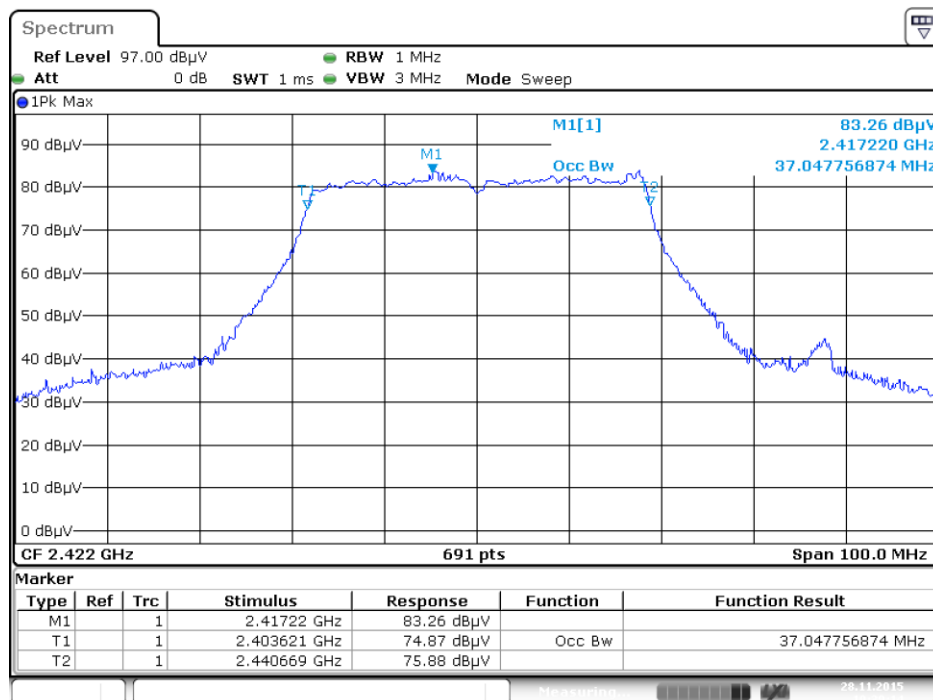

Date: 28.NOV.2015 19:39:14

4.5. Radiated Emissions Measurement

4.5.1. Limit

30dBc in any 100 kHz bandwidth outside the operating frequency band. In case the emission fall within the restricted band specified on 15.205(a), then the 15.209(a) limit in the table below has to be followed.

Frequencies (MHz)	Field Strength (micровolts/meter)	Measurement Distance (meters)
0.009~0.490	2400/F(kHz)	300
0.490~1.705	24000/F(kHz)	30
1.705~30.0	30	30
30~88	100	3
88~216	150	3
216~960	200	3
Above 960	500	3

4.5.2. Measuring Instruments and Setting

Please refer to section 5 of equipments list in this report. The following table is the setting of spectrum analyzer and receiver.

Spectrum Parameter	Setting
Attenuation	Auto
Start Frequency	1000 MHz
Stop Frequency	10th carrier harmonic
RBW / VBW (Emission in restricted band)	1MHz / 3MHz for Peak, 1MHz / 1/T for Average
RBW / VBW (Emission in non-restricted band)	100kHz / 300kHz for peak

Receiver Parameter	Setting
Attenuation	Auto
Start ~ Stop Frequency	9kHz~150kHz / RBW 200Hz for QP
Start ~ Stop Frequency	150kHz~30MHz / RBW 9kHz for QP
Start ~ Stop Frequency	30MHz~1000MHz / RBW 120kHz for QP

4.5.3. Test Procedures

1. Configure the EUT according to ANSI C63.10. The EUT was placed on the top of the turntable 1.5 meter above ground. The phase center of the receiving antenna mounted on the top of a height-variable antenna tower was placed 1m & 3m far away from the turntable.
2. Power on the EUT and all the supporting units. The turntable was rotated by 360 degrees to determine the position of the highest radiation.
3. The height of the broadband receiving antenna was varied between one meter and four meters above ground to find the maximum emissions field strength of both horizontal and vertical polarization.
4. For each suspected emissions, the antenna tower was scan (from 1 m to 4 m) and then the turntable was rotated (from 0 degree to 360 degrees) to find the maximum reading.
5. Set the test-receiver system to Peak or CISPR quasi-peak Detect Function with specified bandwidth under Maximum Hold Mode.
6. For emissions above 1GHz, use 1MHz VBW and 3MHz RBW for peak reading. Then 1MHz RBW and 1/T VBW for average reading in spectrum analyzer.
7. If the emissions level of the EUT in peak mode was 3 dB lower than the average limit specified, then testing will be stopped and peak values of EUT will be reported, otherwise, the emissions which do not have 3 dB margin will be repeated one by one using the quasi-peak method for below 1GHz.
8. For testing above 1GHz, the emissions level of the EUT in peak mode was lower than average limit (that means the emissions level in peak mode also complies with the limit in average mode), then testing will be stopped and peak values of EUT will be reported, otherwise, the emissions will be measured in average mode again and reported.
9. In case the emission is lower than 30MHz, loop antenna has to be used for measurement and the recorded data should be QP measured by receiver. High – Low scan is not required in this case.

4.5.4. Test Setup Layout

For Radiated Emissions: 9kHz ~30MHz

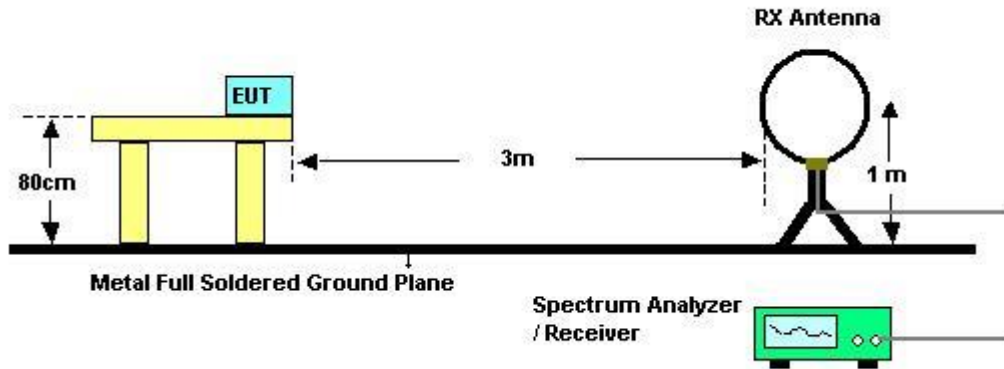

For Radiated Emissions: 30MHz~1GHz

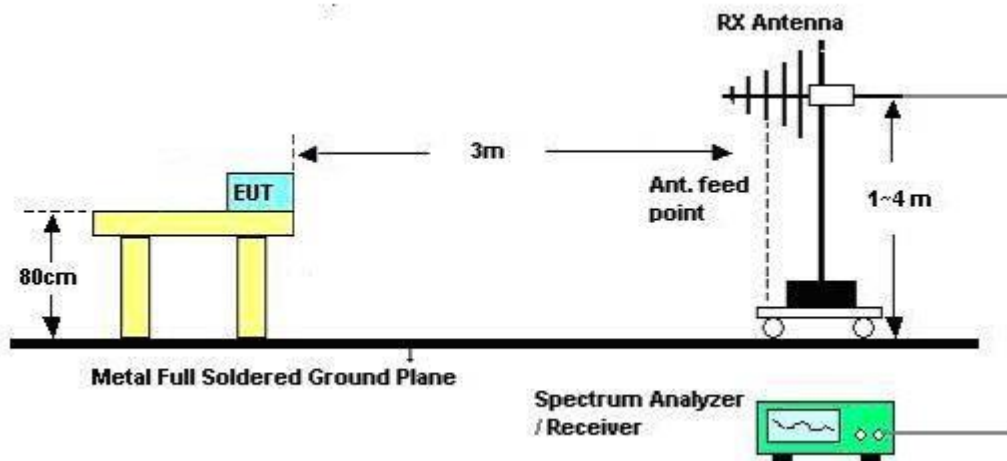

For Radiated Emissions: Above 1GHz

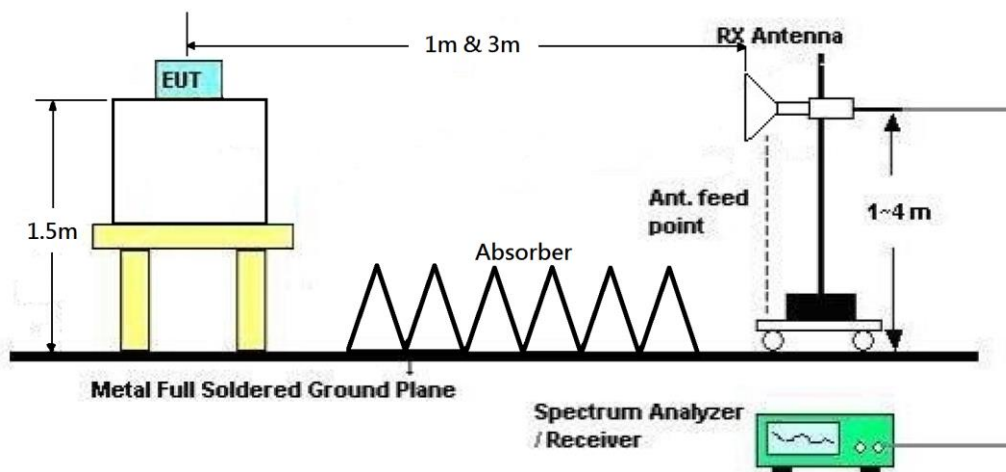

4.5.5. Test Deviation

There is no deviation with the original standard.

4.5.6. EUT Operation during Test

The EUT was programmed to be in continuously transmitting mode.

4.5.7. Results of Radiated Emissions (9kHz~30MHz)

Temperature	23°C	Humidity	66%
Test Engineer	Thor Wei	Configurations	Normal Link
Test Date	Aug. 12, 2017	Test Mode	Mode 1

Freq. (MHz)	Level (dBuV)	Over Limit (dB)	Limit Line (dBuV)	Remark
-	-	-	-	See Note

Note:

The amplitude of spurious emissions which are attenuated by more than 20 dB below the permissible value has no need to be reported.

Distance extrapolation factor = $40 \log (\text{specific distance} / \text{test distance})$ (dB);

Limit line = specific limits (dBuV) + distance extrapolation factor.

4.5.8. Results of Radiated Emissions (30MHz~1GHz)

Temperature	23°C	Humidity	66%
Test Engineer	Thor Wei	Configurations	Normal Link
Test Mode	Mode 1		

Horizontal

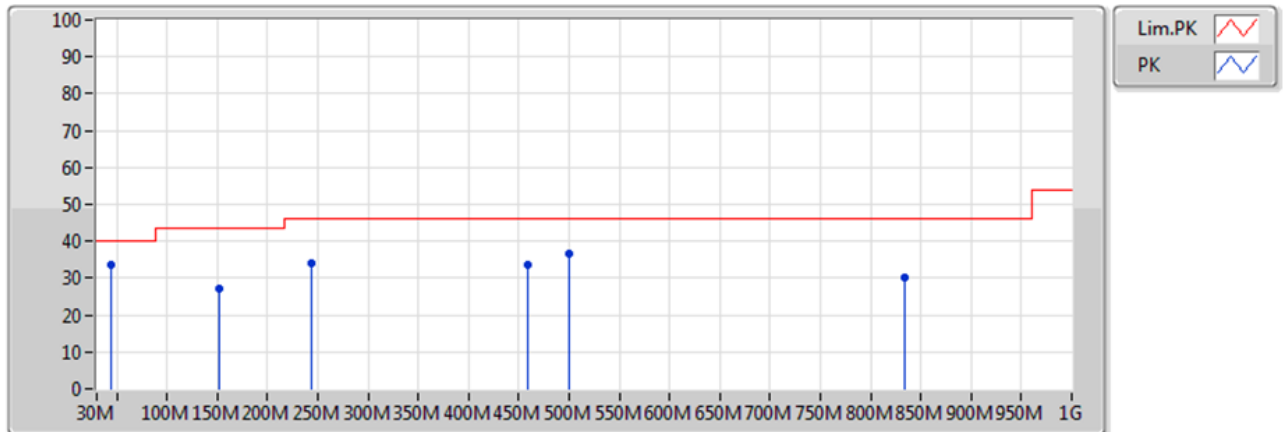

EUT=Z

Type	Freq (Hz)	Level (dBuV/m)	Limit (dBuV/m)	Margin (dB)	Factor (dB)	Dist (m)	Condition	Azimuth (°)	Height (m)	Comments	Raw (dBuV)	AF (dB)	CL (dB)	PA (dB)
PK	43.58M	33.60	40.00	-6.40	-10.94	3	Horizontal	0	1.00	-	44.54	15.73	0.98	27.65
PK	152.22M	27.12	43.50	-16.38	-10.49	3	Horizontal	0	1.00	-	37.61	15.38	1.76	27.62
PK	243.4M	33.90	46.00	-12.10	-8.38	3	Horizontal	0	1.00	-	42.28	16.75	2.21	27.33
PK	458.74M	33.80	46.00	-12.20	-3.04	3	Horizontal	0	1.00	-	36.84	21.95	3.28	28.27
PK	499.48M	36.45	46.00	-9.55	-2.57	3	Horizontal	0	1.00	-	39.02	22.53	3.39	28.49
PK	833.16M	30.05	46.00	-15.95	1.77	3	Horizontal	0	1.00	-	28.28	25.11	4.60	27.94

Vertical

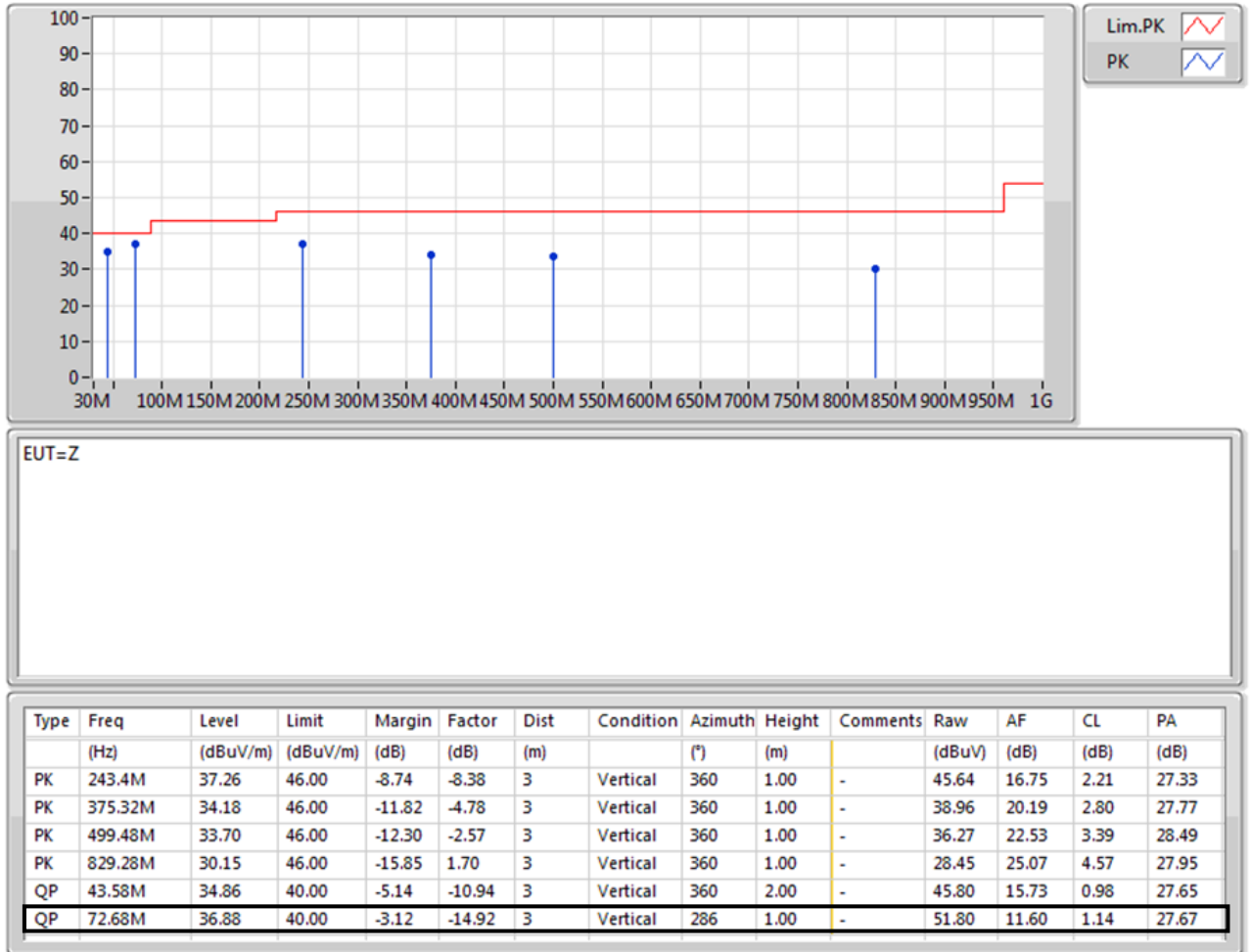

Note:

The amplitude of spurious emissions which are attenuated by more than 20 dB below the permissible value has no need to be reported.

Emission level (dBuV/m) = 20 log Emission level (uV/m).

Corrected Reading: Antenna Factor + Cable Loss + Read Level - Preamp Factor = Level.

4.5.9. Results for Radiated Emissions (1GHz~10th Harmonic)

Temperature	25°C	Humidity	55%
Test Engineer	Stim Sung	Configurations	IEEE 802.11ac MCS0/Nss1 VHT20 CH 1 / Chain 1 + Chain 2 + Chain 3 + Chain 4
Test Date	Nov. 19, 2015		
Test Mode	Mode 1: PIFA Antenna / Chain1:3.81 dBi, Chain2:3.75 dBi, Chain3:3.98 dBi, Chain4:3.47 dBi		

Horizontal

	Freq	Level	Limit Line	Over Limit	Read Level	CableAntenna Loss	Antenna Factor	Preamp Factor	A/Pos	T/Pos	Remark	Pol/Phase
	MHz	dBuV/m	dBuV/m	dB	dBuV	dB	dB/m	dB	cm	deg		
1	4823.99	36.00	54.00	-18.00	27.86	8.11	33.11	33.08	156	278	Average	HORIZONTAL
2	4824.79	48.53	74.00	-25.47	40.39	8.11	33.11	33.08	156	278	Peak	HORIZONTAL

Vertical

	Freq	Level	Limit Line	Over Limit	Read Level	CableAntenna Loss	Antenna Factor	Preamp Factor	A/Pos	T/Pos	Remark	Pol/Phase
	MHz	dBuV/m	dBuV/m	dB	dBuV	dB	dB/m	dB	cm	deg		
1	4823.22	35.32	54.00	-18.68	27.18	8.11	33.11	33.08	153	270	Average	VERTICAL
2	4824.91	48.18	74.00	-25.82	40.04	8.11	33.11	33.08	153	270	Peak	VERTICAL

Temperature	25°C	Humidity	55%
Test Engineer	Stim Sung	Configurations	IEEE 802.11ac MCS0/Nss1 VHT20 CH 6 / Chain 1 + Chain 2 + Chain 3 + Chain 4
Test Date	Nov. 19, 2015		
Test Mode	Mode 1: PIFA Antenna / Chain1:3.81 dBi, Chain2:3.75 dBi, Chain3:3.98 dBi, Chain4:3.47 dBi		

Horizontal

	Freq	Level	Limit	Over	Read	CableAntenna	Preamp	A/Pos	T/Pos	Remark	Pol/Phase	
	MHz	dBuV/m	dBuV/m	dB	dBuV	dB	dB/m	dB	cm	deg		
1	4874.17	35.38	54.00	-18.62	27.29	7.94	33.23	33.08	151	265	Average	HORIZONTAL
2	4874.59	48.06	74.00	-25.94	39.97	7.94	33.23	33.08	151	265	Peak	HORIZONTAL

Vertical

	Freq	Level	Limit	Over	Read	CableAntenna	Preamp	A/Pos	T/Pos	Remark	Pol/Phase	
	MHz	dBuV/m	dBuV/m	dB	dBuV	dB	dB/m	dB	cm	deg		
1	4873.20	47.97	74.00	-26.03	39.88	7.94	33.23	33.08	148	255	Peak	VERTICAL
2	4874.69	35.29	54.00	-18.71	27.20	7.94	33.23	33.08	148	255	Average	VERTICAL

Temperature	25°C	Humidity	55%
Test Engineer	Stim Sung	Configurations	IEEE 802.11ac MCS0/Nss1 VHT20 CH 11 / Chain 1 + Chain 2 + Chain 3 + Chain 4
Test Date	Nov. 19, 2015		
Test Mode	Mode 1: PIFA Antenna / Chain1:3.81 dBi, Chain2:3.75 dBi, Chain3:3.98 dBi, Chain4:3.47 dBi		

Horizontal

	Freq	Level	Limit	Over	Read	CableAntenna	Preamp	A/Pos	T/Pos	Remark	Pol/Phase	
	MHz	dBuV/m	dBuV/m	dB	dBuV	dB	dB/m	dB	cm	deg		
1	4924.39	35.72	54.00	-18.28	27.66	7.78	33.35	33.07	144	242	Average	HORIZONTAL
2	4924.99	48.54	74.00	-25.46	40.48	7.78	33.35	33.07	144	242	Peak	HORIZONTAL

Vertical

	Freq	Level	Limit	Over	Read	CableAntenna	Preamp	A/Pos	T/Pos	Remark	Pol/Phase	
	MHz	dBuV/m	dBuV/m	dB	dBuV	dB	dB/m	dB	cm	deg		
1	4924.66	48.82	74.00	-25.18	40.76	7.78	33.35	33.07	142	237	Peak	VERTICAL
2	4924.78	35.50	54.00	-18.50	27.44	7.78	33.35	33.07	142	237	Average	VERTICAL

Temperature	25°C	Humidity	55%
Test Engineer	Stim Sung	Configurations	IEEE 802.11ac MCS0/Nss1 VHT40 CH 3 / Chain 1 + Chain 2 + Chain 3 + Chain 4
Test Date	Nov. 19, 2015		
Test Mode	Mode 1: PIFA Antenna / Chain1:3.81 dBi, Chain2:3.75 dBi, Chain3:3.98 dBi, Chain4:3.47 dBi		

Horizontal

	Freq	Level	Limit	Over	Read	Cable	Antenna	Preamp	A/Pos	T/Pos	Remark	Pol/Phase
	MHz	dBuV/m	dBuV/m	dB	dBuV	Loss	Factor	Factor	cm	deg		
1	4843.80	35.19	54.00	-18.81	27.07	8.03	33.17	33.08	139	228	Average	HORIZONTAL
2	4844.32	48.16	74.00	-25.84	40.04	8.03	33.17	33.08	139	228	Peak	HORIZONTAL

Vertical

	Freq	Level	Limit	Over	Read	Cable	Antenna	Preamp	A/Pos	T/Pos	Remark	Pol/Phase
	MHz	dBuV/m	dBuV/m	dB	dBuV	Loss	Factor	Factor	cm	deg		
1	4843.53	48.35	74.00	-25.65	40.23	8.03	33.17	33.08	144	221	Peak	VERTICAL
2	4844.55	35.07	54.00	-18.93	26.95	8.03	33.17	33.08	144	221	Average	VERTICAL

Temperature	25°C	Humidity	55%
Test Engineer	Stim Sung	Configurations	IEEE 802.11ac MCS0/Nss1 VHT40 CH 6 / Chain 1 + Chain 2 + Chain 3 + Chain 4
Test Date	Nov. 19, 2015		
Test Mode	Mode 1: PIFA Antenna / Chain1:3.81 dBi, Chain2:3.75 dBi, Chain3:3.98 dBi, Chain4:3.47 dBi		

Horizontal

	Freq	Level	Limit Line	Over Limit	Read Level	Cable Loss	Antenna Factor	Preamp Factor	A/Pos	T/Pos	Remark	Pol/Phase
	MHz	dBuV/m	dBuV/m	dB	dBuV	dB	dB/m	dB	cm	deg		
1	4873.53	48.31	74.00	-25.69	40.22	7.94	33.23	33.08	146	228	Peak	HORIZONTAL
2	4874.36	35.50	54.00	-18.50	27.41	7.94	33.23	33.08	146	228	Average	HORIZONTAL

Vertical

	Freq	Level	Limit Line	Over Limit	Read Level	Cable Loss	Antenna Factor	Preamp Factor	A/Pos	T/Pos	Remark	Pol/Phase
	MHz	dBuV/m	dBuV/m	dB	dBuV	dB	dB/m	dB	cm	deg		
1	4873.67	35.23	54.00	-18.77	27.14	7.94	33.23	33.08	141	210	Average	VERTICAL
2	4874.66	48.33	74.00	-25.67	40.24	7.94	33.23	33.08	141	210	Peak	VERTICAL

Temperature	25°C	Humidity	55%
Test Engineer	Stim Sung	Configurations	IEEE 802.11ac MCS0/Nss1 VHT40 CH 9 / Chain 1 + Chain 2 + Chain 3 + Chain 4
Test Date	Nov. 19, 2015		
Test Mode	Mode 1: PIFA Antenna / Chain1:3.81 dBi, Chain2:3.75 dBi, Chain3:3.98 dBi, Chain4:3.47 dBi		

Horizontal

	Freq	Level	Limit Line	Over Limit	Read Level	CableAntenna Loss	Antenna Factor	Preamp Factor	A/Pos	T/Pos	Remark	Pol/Phase
	MHz	dBuV/m	dBuV/m	dB	dBuV	dB	dB/m	dB	cm	deg		
1	4903.72	48.64	74.00	-25.36	40.56	7.86	33.29	33.07	139	202	Peak	HORIZONTAL
2	4904.02	35.48	54.00	-18.52	27.40	7.86	33.29	33.07	139	202	Average	HORIZONTAL

Vertical

	Freq	Level	Limit Line	Over Limit	Read Level	CableAntenna Loss	Antenna Factor	Preamp Factor	A/Pos	T/Pos	Remark	Pol/Phase
	MHz	dBuV/m	dBuV/m	dB	dBuV	dB	dB/m	dB	cm	deg		
1	4903.56	48.51	74.00	-25.49	40.43	7.86	33.29	33.07	137	199	Peak	VERTICAL
2	4904.78	35.41	54.00	-18.59	27.33	7.86	33.29	33.07	137	199	Average	VERTICAL

Note:

The amplitude of spurious emissions that are attenuated by more than 20dB below the permissible value has no need to be reported.

Emission level (dBuV/m) = 20 log Emission level (uV/m).

Corrected Reading: Antenna Factor + Cable Loss + Read Level - Preamp Factor = Level.

4.6. Emissions Measurement

4.6.1. Limit

30dBc in any 100 kHz bandwidth outside the operating frequency band. In case the emission fall within the restricted band specified on 15.205(a), then the 15.209(a) limit in the table below has to be followed.

Frequencies (MHz)	Field Strength (microrvolts/meter)	Measurement Distance (meters)
0.009~0.490	2400/F(kHz)	300
0.490~1.705	24000/F(kHz)	30
1.705~30.0	30	30
30~88	100	3
88~216	150	3
216~960	200	3
Above 960	500	3

4.6.2. Measuring Instruments and Setting

Please refer to section 5 of equipments list in this report. The following table is the setting of the spectrum analyzer.

Spectrum Parameter	Setting
Attenuation	Auto
Span Frequency	100 MHz
RBW / VBW (Emission in restricted band)	1 MHz / 3MHz for Peak, 1 MHz / 1/T for Average
RBW / VBW (30dBc in any 100 kHz bandwidth emission)	100 kHz / 300 kHz for Peak

4.6.3. Test Procedures

For Radiated band edges Measurement:

1. The test procedure is the same as section 4.5.3.

For Radiated Out of Band Emission Measurement:

1. Test was performed in accordance with KDB558074 D01 v04 for Performing Compliance Measurements on Digital Transmission Systems (DTS) Operating Under §15.247 section 10.1 Unwanted Emissions into Non-Restricted Frequency Bands Measurement Procedure.

4.6.4. Test Setup Layout

For Radiated band edges Measurement:

This test setup layout is the same as that shown in section 4.5.4.

For Radiated Out of Band Emission Measurement:

This test setup layout is the same as that shown in section 4.5.4.

4.6.5. Test Deviation

There is no deviation with the original standard.

4.6.6. EUT Operation during Test

The EUT was programmed to be in continuously transmitting mode.

4.6.7. Test Result of Band Edge and Fundamental Emissions

Temperature	25°C	Humidity	55%
Test Engineer	Stim Sung	Configurations	IEEE 802.11ac MCS0/Nss1 VHT20 CH 1, 6, 11 / Chain 1 + Chain 2 + Chain 3 + Chain 4
Test Date	Nov. 19, 2015		
Test Mode	Mode 1: PIFA Antenna / Chain1:3.81 dBi, Chain2:3.75 dBi, Chain3:3.98 dBi, Chain4:3.47 dBi		

Channel 1

	Freq	Level	Limit Line	Over Limit	Read Level	CableAntenna Loss	Preamp Factor	A/Pos	T/Pos	Remark	Pol/Phase	
	MHz	dBuV/m	dBuV/m	dB	dBuV	dB	dB/m	dB	cm	deg		
1	2390.00	63.37	74.00	-10.63	30.05	5.01	28.31	0.00	228	357	Peak	VERTICAL
2	2390.00	52.29	54.00	-1.71	18.97	5.01	28.31	0.00	228	357	Average	VERTICAL
3	2404.00	112.24			78.87	5.03	28.34	0.00	228	357	Peak	VERTICAL
4	2404.20	102.40			69.03	5.03	28.34	0.00	228	357	Average	VERTICAL

Item 3, 4 are the fundamental frequency at 2412 MHz.

Channel 6

	Freq	Level	Limit Line	Over Limit	Read Level	CableAntenna Loss	Preamp Factor	A/Pos	T/Pos	Remark	Pol/Phase	
	MHz	dBuV/m	dBuV/m	dB	dBuV	dB	dB/m	dB	cm	deg		
1	2352.60	59.40	74.00	-14.60	26.19	4.96	28.25	0.00	212	360	Peak	VERTICAL
2	2358.20	47.86	54.00	-6.14	14.62	4.97	28.27	0.00	212	360	Average	VERTICAL
3	2439.40	116.25			82.76	5.08	28.41	0.00	212	360	Peak	VERTICAL
4	2440.60	106.30			72.81	5.08	28.41	0.00	212	360	Average	VERTICAL
5	2493.40	58.59	74.00	-15.41	24.97	5.13	28.49	0.00	212	360	Peak	VERTICAL
6	2517.80	47.83	54.00	-6.17	14.13	5.15	28.55	0.00	212	360	Average	VERTICAL

Item 3, 4 are the fundamental frequency at 2437 MHz.

Channel 11

	Freq	Level	Limit Line	Over Limit	Read Level	CableAntenna Loss	Preamp Factor	A/Pos	T/Pos	Remark	Pol/Phase	
	MHz	dBuV/m	dBuV/m	dB	dBuV	dB	dB/m	dB	cm	deg		
1	2464.80	104.39			70.85	5.10	28.44	0.00	275	309	Average	HORIZONTAL
2	2465.60	117.76			84.22	5.10	28.44	0.00	275	309	Peak	HORIZONTAL
3	2483.50	65.06	74.00	-8.94	31.46	5.12	28.48	0.00	275	309	Peak	HORIZONTAL
4	2483.50	52.61	54.00	-1.39	19.01	5.12	28.48	0.00	275	309	Average	HORIZONTAL

Item 1, 2 are the fundamental frequency at 2462 MHz.

Temperature	25°C	Humidity	55%
Test Engineer	Stim Sung	Configurations	IEEE 802.11ac MCS0/Nss1 VHT40 CH 3, 6, 9 / Chain 1 + Chain 2 + Chain 3 + Chain 4
Test Date	Nov. 19, 2015		
Test Mode	Mode 1: PIFA Antenna / Chain1:3.81 dBi, Chain2:3.75 dBi, Chain3:3.98 dBi, Chain4:3.47 dBi		

Channel 3

	Freq	Level	Limit Line	Over Limit	Read Level	CableAntenna Loss	Antenna Factor	Preamp Factor	A/Pos	T/Pos	Remark	Pol/Phase
	MHz	dBuV/m	dBuV/m	dB	dBuV	dB	dB/m	dB	cm	deg		
1	2388.80	70.91	74.00	-3.09	37.59	5.01	28.31	0.00	228	308	Peak	HORIZONTAL
2	2388.80	52.84	54.00	-1.16	19.52	5.01	28.31	0.00	228	308	Average	HORIZONTAL
3	2409.20	103.36			69.97	5.04	28.35	0.00	228	308	Average	HORIZONTAL
4	2425.60	112.62			79.18	5.06	28.38	0.00	228	308	Peak	HORIZONTAL

Item 3, 4 are the fundamental frequency at 2422 MHz.

Channel 6

	Freq	Level	Limit Line	Over Limit	Read Level	CableAntenna Loss	Antenna Factor	Preamp Factor	A/Pos	T/Pos	Remark	Pol/Phase
	MHz	dBuV/m	dBuV/m	dB	dBuV	dB	dB/m	dB	cm	deg		
1	2389.80	46.69	54.00	-7.31	13.37	5.01	28.31	0.00	202	310	Average	HORIZONTAL
2	2390.00	58.45	74.00	-15.55	25.13	5.01	28.31	0.00	202	310	Peak	HORIZONTAL
3	2430.20	99.92			66.48	5.06	28.38	0.00	202	310	Average	HORIZONTAL
4	2449.40	111.94			78.44	5.08	28.42	0.00	202	310	Peak	HORIZONTAL
5	2483.50	67.44	74.00	-6.56	33.84	5.12	28.48	0.00	202	310	Peak	HORIZONTAL
6	2483.50	52.93	54.00	-1.07	19.33	5.12	28.48	0.00	202	310	Average	HORIZONTAL

Item 3, 4 are the fundamental frequency at 2437 MHz.

Channel 9

	Freq	Level	Limit Line	Over Limit	Read Level	CableAntenna Loss	Antenna Factor	Preamp Factor	A/Pos	T/Pos	Remark	Pol/Phase
	MHz	dBuV/m	dBuV/m	dB	dBuV	dB	dB/m	dB	cm	deg		
1	2440.80	101.58			68.09	5.08	28.41	0.00	212	303	Average	HORIZONTAL
2	2459.60	110.77			77.25	5.09	28.43	0.00	212	303	Peak	HORIZONTAL
3	2484.00	68.09	74.00	-5.91	34.49	5.12	28.48	0.00	212	303	Peak	HORIZONTAL
4	2484.00	52.68	54.00	-1.32	19.08	5.12	28.48	0.00	212	303	Average	HORIZONTAL

Item 1, 2 are the fundamental frequency at 2452 MHz.

Note:

Emission level (dBuV/m) = 20 log Emission level (uV/m).

Corrected Reading: Antenna Factor + Cable Loss + Read Level - Preamp Factor = Level.

For Emission not in Restricted Band

Mode 1: PIFA Antenna / Chain1:3.81 dBi, Chain2:3.75 dBi, Chain3:3.98 dBi, Chain4:3.47 dBi

Plot on Configuration IEEE 802.11ac MCS0/Nss1 VHT20 / Reference Level

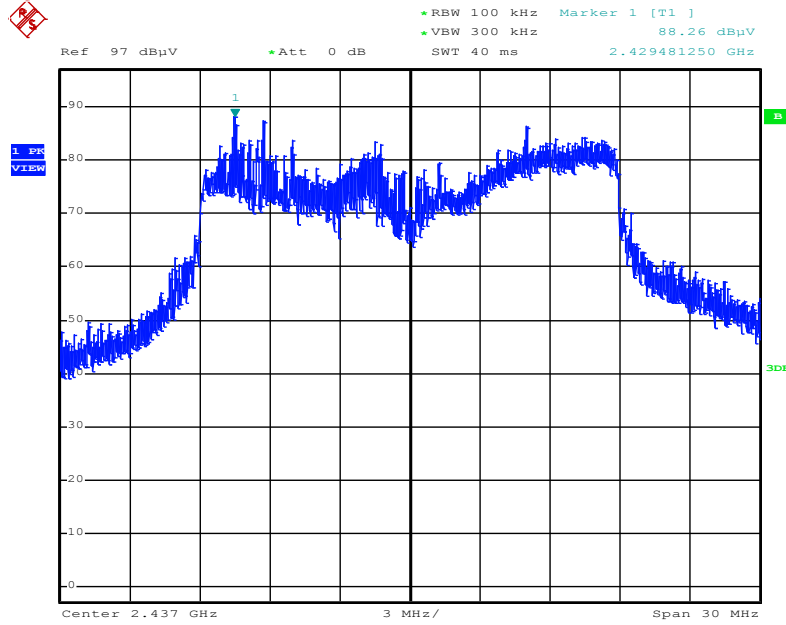

Date: 19.NOV.2015 22:22:42

Plot on Configuration IEEE 802.11ac MCS0/Nss1 VHT20 / CH 1 / 30MHz~2400MHz (down 30dBc)

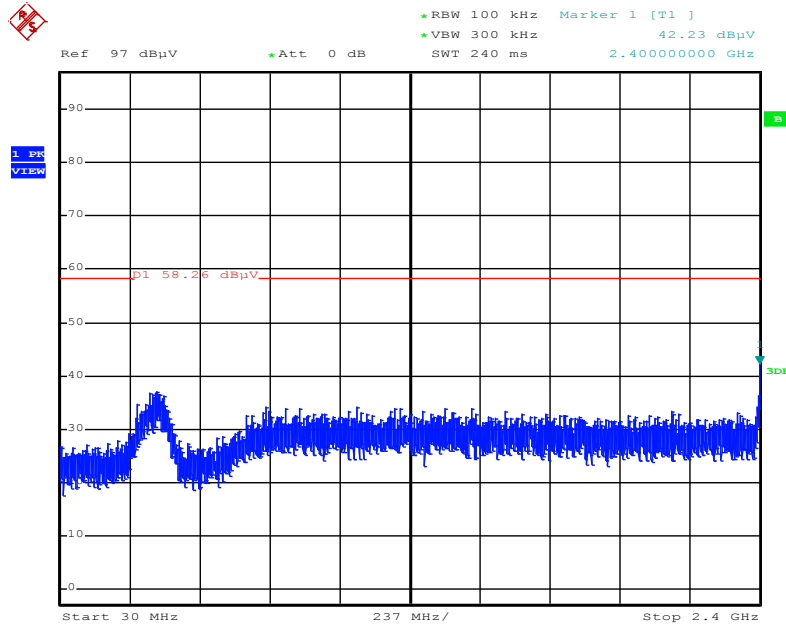

Date: 19.NOV.2015 22:24:17

Plot on Configuration IEEE 802.11ac MCS0/Nss1 VHT20 / CH 1 / 2500MHz~26500MHz (down 30dBc)

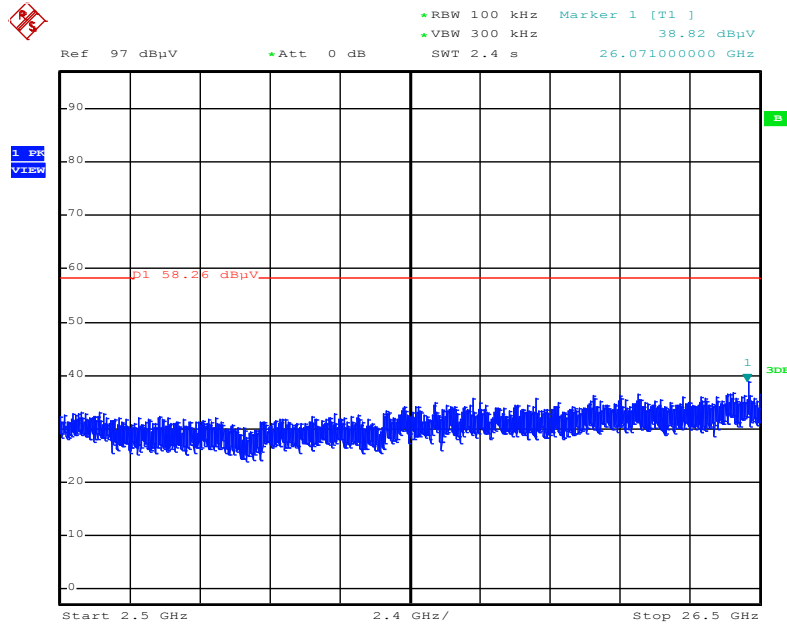

Date: 19.NOV.2015 22:24:42

Plot on Configuration IEEE 802.11ac MCS0/Nss1 VHT20 / CH 11 / 30MHz~2400MHz (down 30dBc)

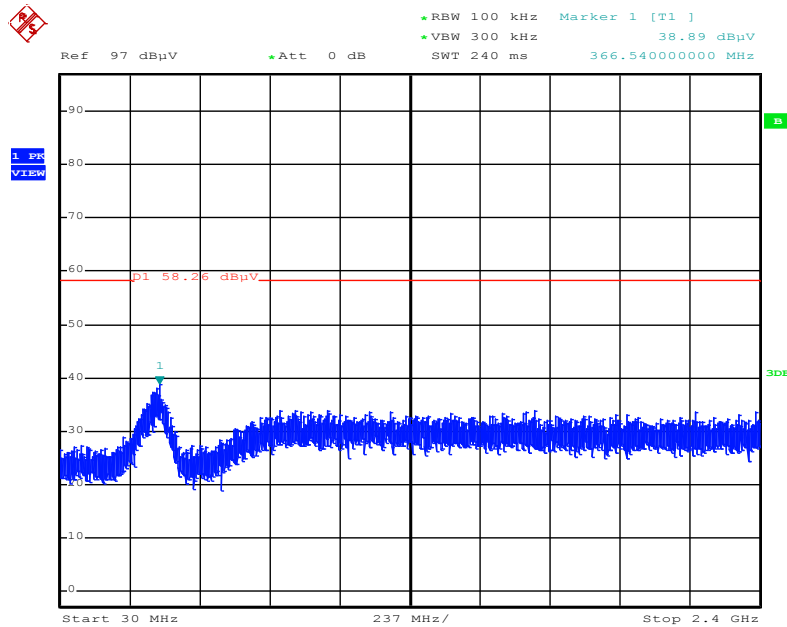

Date: 19.NOV.2015 22:26:34

Plot on Configuration IEEE 802.11ac MCS0/Nss1 VHT20 / CH 11 / 2500MHz~26500MHz (down 30dBc)

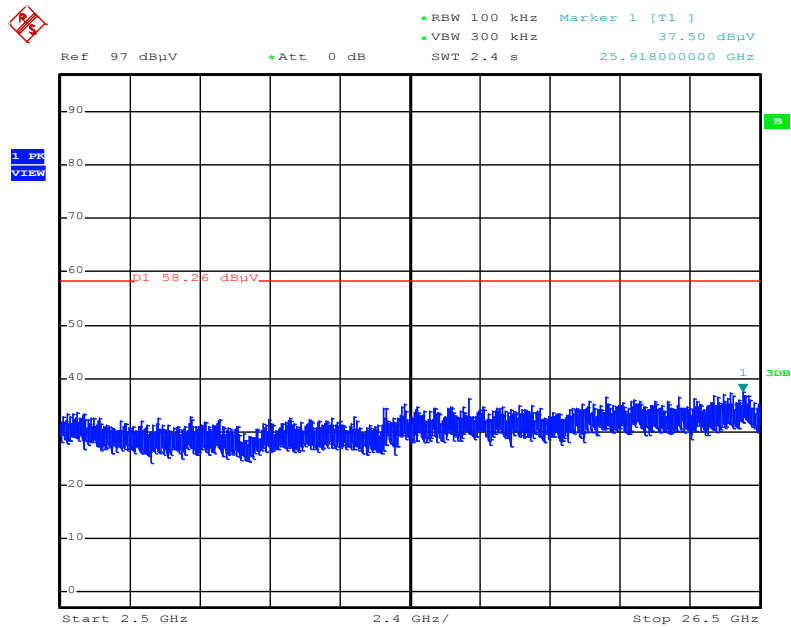

Date: 19.NOV.2015 22:26:11

Plot on Configuration IEEE 802.11ac MCS0/Nss1 VHT40 / Reference Level

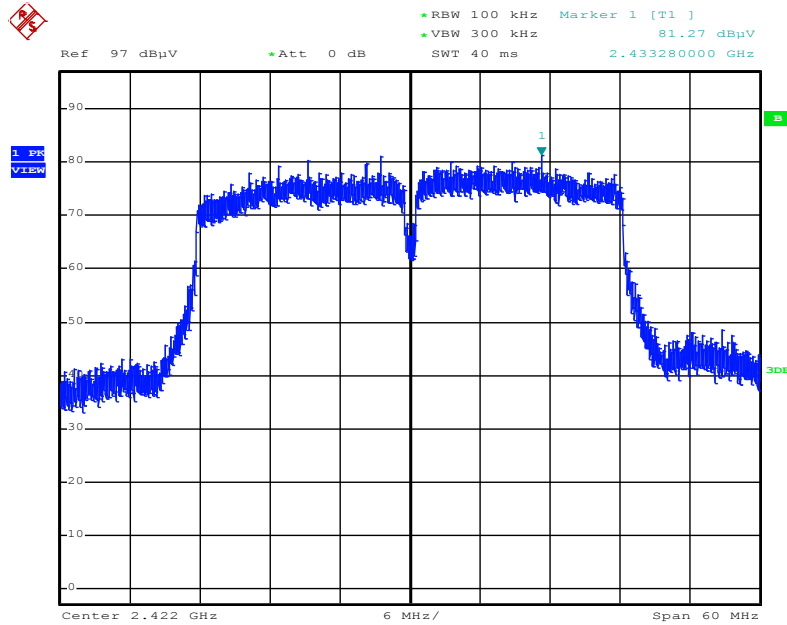

Date: 19.NOV.2015 22:29:40

Plot on Configuration IEEE 802.11ac MCS0/Nss1 VHT40 / CH 3 / 30MHz~2400MHz (down 30dBc)

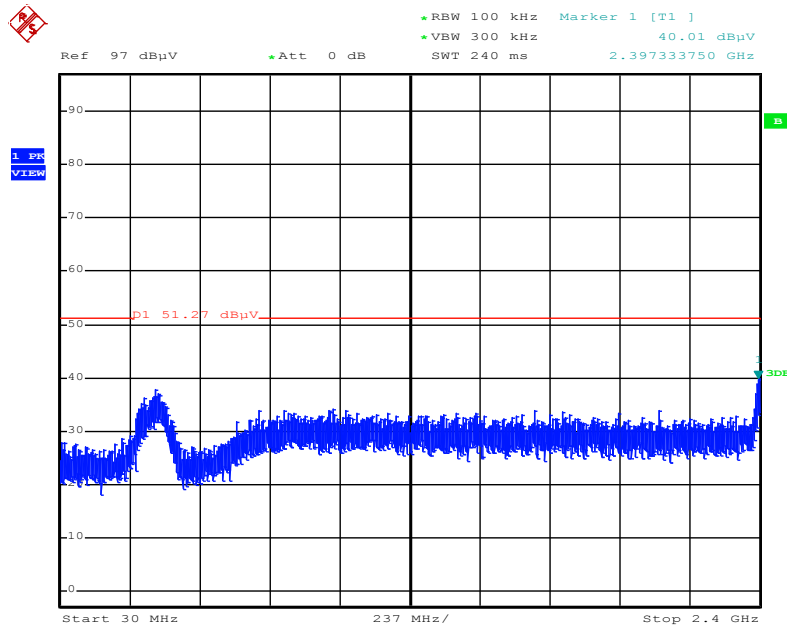

Date: 19.NOV.2015 22:31:00

Plot on Configuration IEEE 802.11ac MCS0/Nss1 VHT40 / CH 3 / 2500MHz~26500MHz (down 30dBc)

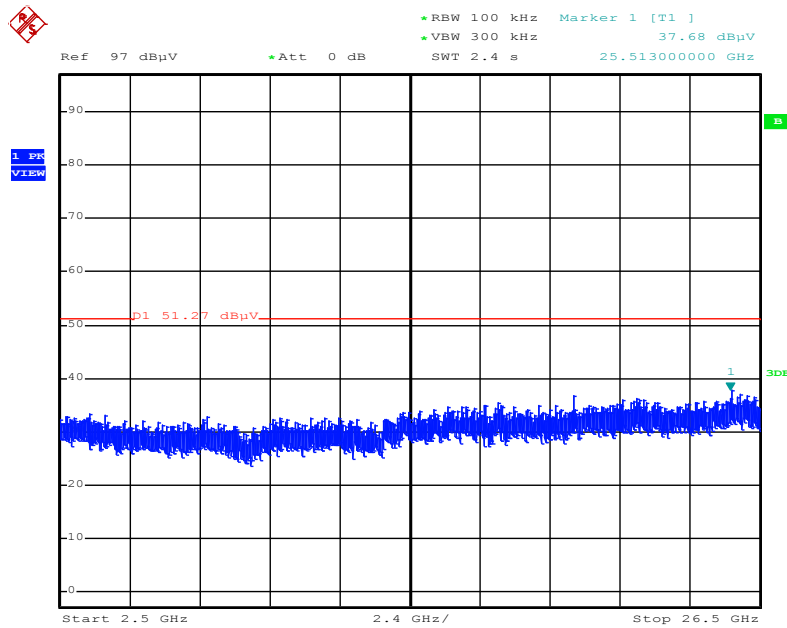

Date: 19.NOV.2015 22:32:21

Plot on Configuration IEEE 802.11ac MCS0/Nss1 VHT40 / CH 9 / 30MHz~2400MHz (down 30dBc)

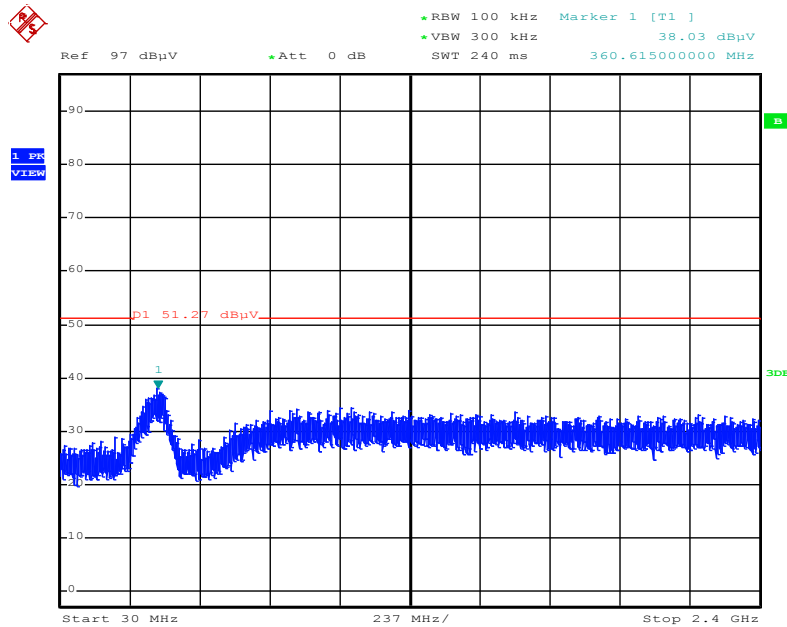

Date: 19.NOV.2015 22:36:09

Plot on Configuration IEEE 802.11ac MCS0/Nss1 VHT40 / CH 9 / 2500MHz~26500MHz (down 30dBc)

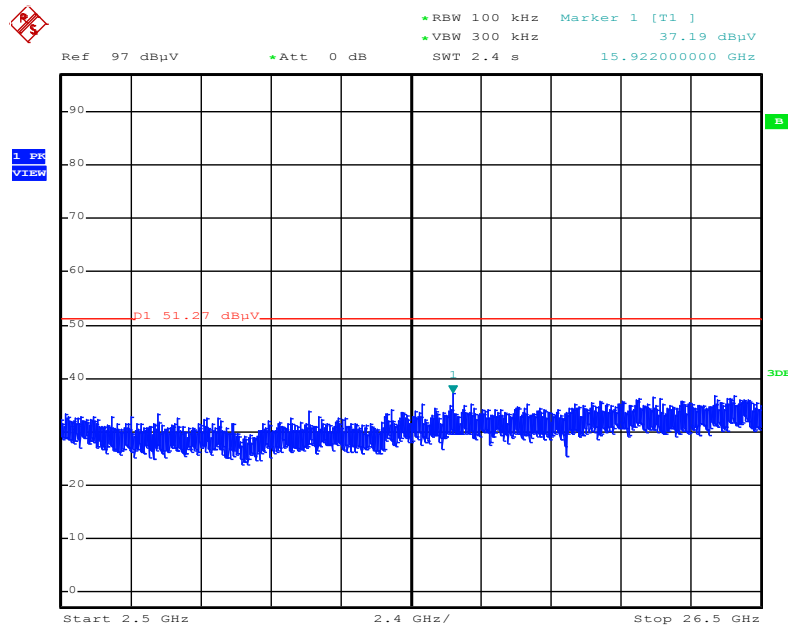

Date: 19.NOV.2015 22:35:36

4.7. Antenna Requirements

4.7.1. Limit

Except for special regulations, the Low-power Radio-frequency Devices must not be equipped with any jacket for installing an antenna with extension cable. An intentional radiator shall be designed to ensure that no antenna other than that furnished by the responsible party shall be used with the device. The use of a permanently attached antenna or of an antenna that uses a unique coupling to the intentional radiator shall be considered sufficient to comply with the provisions of this Section. The manufacturer may design the unit so that the user can replace a broken antenna, but the use of a standard antenna jack or electrical connector is prohibited. Further, this requirement does not apply to intentional radiators that must be professionally installed.

4.7.2. Antenna Connector Construction

Please refer to section 3.3 in this test report; antenna connector complied with the requirements.

5. LIST OF MEASURING EQUIPMENTS

Conducted Emission

Instrument	Manufacturer	Model No.	Serial No.	Characteristics	Calibration Date	Remark
EMC Receiver	R&S	ESR3	102051	9KHz ~ 3.6GHz	29/Apr/2017	Conduction (CO04-HY)
LISN	R&S	ENV216	101295	9kHz ~ 30MHz	15/Nov/2016	Conduction (CO04-HY)
RF Cable-CON	HUBER+SUHNER	RG213/U	07611832020001	9kHz ~ 30MHz	24/Oct/2016	Conduction (CO04-HY)
Impuls Begrenzer Pulse Limiter	R&S	ESH3-Z2	100921	10 kHz ~ 30 MHz	20/Oct/2016	Conduction (CO04-HY)

Radiated Emission Below 1GHz

Instrument	Manufacturer	Model No.	Serial No.	Characteristics	Calibration Date	Remark
Spectrum Analyzer	R&S	FSP40	100593	9KHz - 40GHz	26/Oct/2016	03CH02-HY
3m Semi Anechoic	SIDT FRANKONIA	SAC-3M	03CH02-HY	30MHz-1GHz	21/Oct/2016	03CH02-HY
Amplifier	Agilent	8447D	2944A11149	100KHz-1.3GHz	29/Jun/2017	03CH02-HY
Bilog Antenna	SCHAFFNER	CBL6112B	2723	30MHz-1GHz	01/Oct/2016	03CH02-HY
RF Cable-R03m	Jye Bao	RG142	CB017	9kHz ~ 1GHz	26/Jan/2017	03CH02-HY
Receiver	R&S	ESU-26	100422/026	20Hz ~ 26.5GHz	21/Sep/2016	03CH02-HY
Loop Antenna	TESEQ	HLA 6120	24155	9 kHz~30 MHz	02/Mar/2017	03CH02-HY

Radiated Emission Above 1GHz

Instrument	Manufacturer	Model No.	Serial No.	Characteristics	Calibration Date	Remark
Horn Antenna	EMCO	3115	00075790	750MHz ~ 18GHz	Oct. 22, 2015	Radiation (03CH01-CB)
Horn Antenna	Schwarzbeck	BBHA 9170	BBHA9170252	15GHz ~ 40GHz	Jul. 21, 2015	Radiation (03CH01-CB)
Pre-Amplifier	Agilent	8449B	3008A02310	1GHz ~ 26.5GHz	Jan. 12, 2015	Radiation (03CH01-CB)
Pre-Amplifier	WM	TF-130N-R1	923365	26GHz ~ 40GHz	Feb.10, 2015	Radiation (03CH01-CB)
Spectrum Analyzer	R&S	FSP40	100056	9kHz ~ 40GHz	Oct. 27, 2015	Radiation (03CH01-CB)
RF Cable-high	Woken	High Cable-16	N/A	1 GHz ~ 18 GHz	Nov. 02, 2015	Radiation (03CH01-CB)
RF Cable-high	Woken	High Cable-17	N/A	1 GHz ~ 18 GHz	Nov. 02, 2015	Radiation (03CH01-CB)
RF Cable-high	Woken	High Cable-40G-1	N/A	18GHz ~ 40 GHz	Nov. 02, 2015	Radiation (03CH01-CB)
RF Cable-high	Woken	High Cable-40G-2	N/A	18GHz ~ 40 GHz	Nov. 02, 2015	Radiation (03CH01-CB)

Conducted

Instrument	Manufacturer	Model No.	Serial No.	Characteristics	Calibration Date	Remark
Spectrum analyzer	R&S	FSV40	100979	9kHz~40GHz	Dec. 12, 2014	Conducted (TH01-CB)
Temp. and Humidity Chamber	Ten Billion	TTH-D3SP	TBN-931011	-30~100 degree	Jun. 02, 2015	Conducted (TH01-CB)
RF Cable-high	Woken	RG402	High Cable-7	1 GHz – 26.5 GHz	Nov. 02, 2015	Conducted (TH01-CB)
RF Cable-high	Woken	RG402	High Cable-8	1 GHz – 26.5 GHz	Nov. 02, 2015	Conducted (TH01-CB)
RF Cable-high	Woken	RG402	High Cable-9	1 GHz – 26.5 GHz	Nov. 02, 2015	Conducted (TH01-CB)
RF Cable-high	Woken	RG402	High Cable-10	1 GHz – 26.5 GHz	Nov. 02, 2015	Conducted (TH01-CB)
RF Cable-high	Woken	RG402	High Cable-6	1 GHz – 26.5 GHz	Nov. 02, 2015	Conducted (TH01-CB)
Power Sensor	Agilent	U2021XA	MY53410001	50MHz~18GHz	Nov. 02, 2015	Conducted (TH01-CB)

Note: Calibration Interval of instruments listed above is one year.

“*” Calibration Interval of instruments listed above is two years.

N.C.R. means Non-Calibration required.

6. MEASUREMENT UNCERTAINTY

Test Items	Uncertainty	Remark
Conducted Emission (150kHz ~ 30MHz)	2.2 dB	Confidence levels of 95%
Radiated Emission (30MHz ~ 1,000MHz)	2.1 dB	Confidence levels of 95%
Radiated Emission (1GHz ~ 18GHz)	3.7 dB	Confidence levels of 95%
Radiated Emission (18GHz ~ 40GHz)	3.5 dB	Confidence levels of 95%
Conducted Emission	1.7 dB	Confidence levels of 95%

Appendix B. Radiated Emission Co-location Report

1. Results of Radiated Emissions for Co-located

Temperature	25°C	Humidity	55%
Test Engineer	Stim Sung	Configurations	2.4GHz + 5GHz

Horizontal

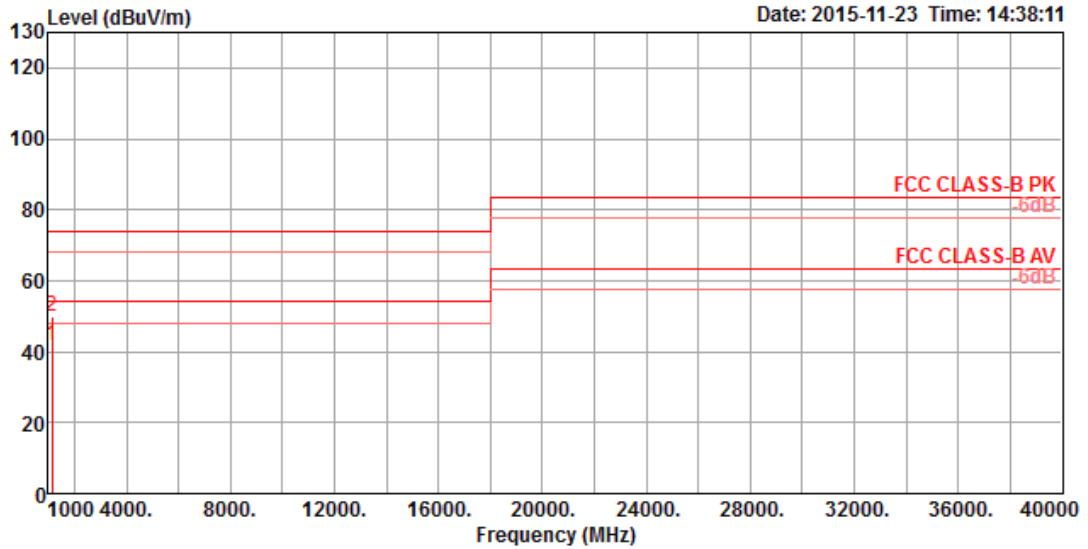

	Freq	Level	Limit Line	Over Limit	Read Level	CableAntenna Loss	Antenna Factor	Preamp Factor	A/Pos	T/Pos	Remark	Pol/Phase
	MHz	dBuV/m	dBuV/m	dB	dBuV	dB	dB/m	dB	cm	deg		
1	1129.38	41.78	54.00	-12.22	50.83	3.35	24.77	37.17	100	350	Average	HORIZONTAL
2	1129.38	49.78	74.00	-24.22	58.83	3.35	24.77	37.17	100	350	Peak	HORIZONTAL

Vertical

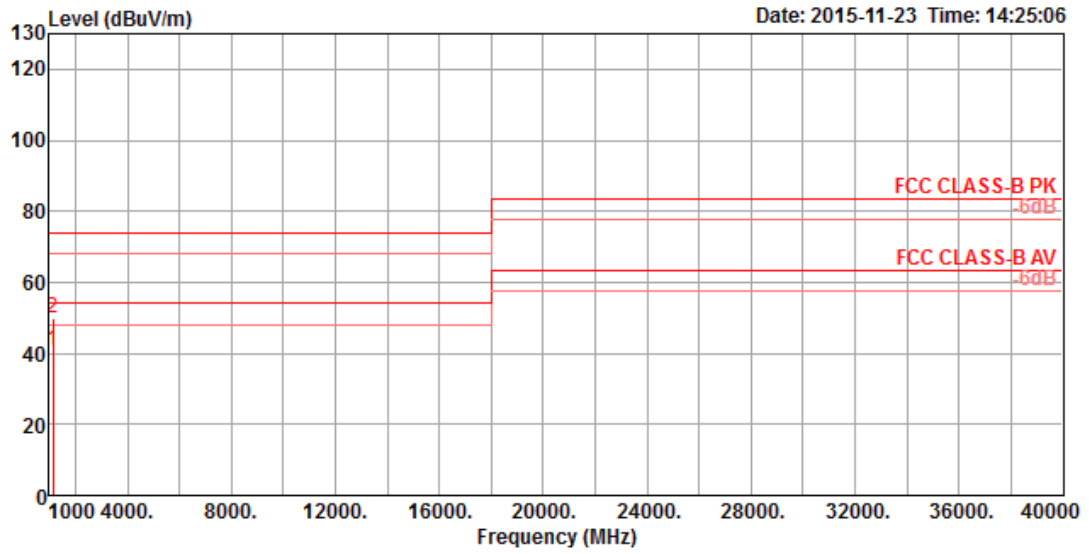

	Freq	Level	Limit Line	Over Limit	Read Level	CableAntenna Loss	Antenna Factor	Preamp Factor	A/Pos	T/Pos	Remark	Pol/Phase
	MHz	dBuV/m	dBuV/m	dB	dBuV	dB	dB/m	dB	cm	deg		
1	1129.38	41.00	54.00	-13.00	50.05	3.35	24.77	37.17	100	285	Average	VERTICAL
2	1129.38	50.00	74.00	-24.00	59.05	3.35	24.77	37.17	100	285	Peak	VERTICAL