



SPORTON International Inc.

No. 52, Huaya 1st Rd., Guishan Dist., Taoyuan City, Taiwan (R.O.C.)
Ph: 886-3-327-3456 / FAX: 886-3-327-0973 / www.sporton.com.tw

FCC RADIO TEST REPORT

Applicant's company	Allied Telesis K.K
Applicant Address	2nd. TOC Bldg. 7-21-11 Nishi-Gotanda, Shinagawa-ku, Tokyo Japan, 141-0031
FCC ID	RSL-MWS2533AP
Manufacturer's company	Senao Networks, Inc.
Manufacturer Address	3F, No. 529, Chung Cheng Rd., Hsintien, Taipei, Taiwan

Product Name	IEEE 802.a/b/g/n/ac Managed Wireless Access Point
Brand Name	
Model No.	AT-MWS2533AP
Test Rule Part(s)	47 CFR FCC Part 15 Subpart E § 15.407
Test Freq. Range	5150 ~ 5250 MHz / 5725 ~ 5850 MHz
Received Date	Oct. 15, 2015
Final Test Date	Aug. 15, 2017
Submission Type	Original Equipment

Statement

Test result included is for the IEEE 802.11n and IEEE 802.11a/ac of the product.

The test result in this report refers exclusively to the presented test model / sample.

Without written approval of SPORTON International Inc., the test report shall not be reproduced except in full.

The measurements and test results shown in this test report were made in accordance with the procedures and found in compliance with the limit given in **ANSI C63.10-2013,**

47 CFR FCC Part 15 Subpart E, KDB789033 D02 v01, KDB662911 D01 v02r01, KDB644545 D03 v01.

The test equipment used to perform the test is calibrated and traceable to NML/ROC.



Table of Contents

1. VERIFICATION OF COMPLIANCE	1
2. SUMMARY OF THE TEST RESULT	2
3. GENERAL INFORMATION	3
3.1. Product Details	3
3.2. Accessories	8
3.3. Table for Filed Antenna	9
3.4. Table for Carrier Frequencies	11
3.5. Table for Test Modes	12
3.6. Table for Testing Locations	15
3.7. Table for Multiple Listing	15
3.8. Table for Supporting Units	16
3.9. Table for Parameters of Test Software Setting	17
3.10. EUT Operation during Test	21
3.11. Duty Cycle	21
3.12. Test Configurations	22
4. TEST RESULT	25
4.1. AC Power Line Conducted Emissions Measurement	25
4.2. 26dB Bandwidth and 99% Occupied Bandwidth Measurement	29
4.3. 6dB Spectrum Bandwidth Measurement	86
4.4. Maximum Conducted Output Power Measurement	111
4.5. Power Spectral Density Measurement	121
4.6. Radiated Emissions Measurement	163
4.7. Band Edge Emissions Measurement	266
4.8. Frequency Stability Measurement	308
4.9. Antenna Requirements	322
5. LIST OF MEASURING EQUIPMENTS	323
6. MEASUREMENT UNCERTAINTY	325
APPENDIX A. TEST PHOTOS	
APPENDIX B. RADIATED EMISSION CO-LOCATION REPORT	
PHOTOGRAPHS OF EUT V01	



History of This Test Report

REPORT NO.	VERSION	DESCRIPTION	ISSUED DATE
FR720735-01AD	Rev. 01	Initial issue of report	Sep. 12, 2017

1. VERIFICATION OF COMPLIANCE

Product Name : IEEE 802.a/b/g/n/ac Managed Wireless Access Point

Brand Name : 

Model No. : AT-MWS2533AP

Applicant : Allied Telesis K.K

Test Rule Part(s) : 47 CFR FCC Part 15 Subpart E § 15.407

Sporton International as requested by the applicant to evaluate the EMC performance of the product sample received on Oct. 15, 2015 would like to declare that the tested sample has been evaluated and found to be in compliance with the tested rule parts. The data recorded as well as the test configuration specified is true and accurate for showing the sample's EMC nature.

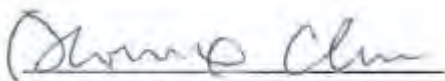

Phoenix Chen

SPORTON INTERNATIONAL INC.

2. SUMMARY OF THE TEST RESULT

Applied Standard: 47 CFR FCC Part 15 Subpart E				
Part	Rule Section	Description of Test	Result	Under Limit
4.1	15.207	AC Power Line Conducted Emissions	Complies	5.3 dB
4.2	15.407(a)	26dB Spectrum Bandwidth and 99% Occupied Bandwidth	Complies	-
4.3	15.407(e)	6dB Spectrum Bandwidth	Complies	-
4.4	15.407(a)	Maximum Conducted Output Power	Complies	0.01 dB
4.5	15.407(a)	Power Spectral Density	Complies	0.28 dB
4.6	15.407(b)	Radiated Emissions	Complies	2.11 dB
4.7	15.407(b)	Band Edge Emissions	Complies	1.01 dB
4.8	15.407(g)	Frequency Stability	Complies	-
4.9	15.203	Antenna Requirements	Complies	-

3. GENERAL INFORMATION

3.1. Product Details

Items	Description
Product Type	WLAN (4TX, 4RX)
Radio Type	Intentional Transceiver
Power Type	From power adapter or PoE
Modulation	IEEE 802.11a: OFDM IEEE 802.11n/ac: see the below table
Data Modulation	IEEE 802.11a/n: OFDM (BPSK / QPSK / 16QAM / 64QAM) IEEE 802.11ac: OFDM (BPSK / QPSK / 16QAM / 64QAM / 256QAM)
Data Rate (Mbps)	IEEE 802.11a: OFDM (6/9/12/18/24/36/48/54) IEEE 802.11n/ac: see the below table
Frequency Range	5150 ~ 5250 MHz / 5725 ~ 5850 MHz
Channel Number	9 for 20MHz bandwidth ; 4 for 40MHz bandwidth 2 for 80MHz bandwidth
Channel Band Width (99%)	<p>Mode 1: EUT 1 + Set 1 Ceiling Mount Omni Antenna / 7 dBi</p> <p>Band 1:</p> <p>IEEE 802.11ac MCS0/Nss1 (VHT20): 17.89 MHz IEEE 802.11ac MCS0/Nss1 (VHT40): 37.19 MHz IEEE 802.11ac MCS0/Nss1 (VHT80): 76.12 MHz</p> <p>Band 4:</p> <p>IEEE 802.11ac MCS0/Nss1 (VHT20): 18.15 MHz IEEE 802.11ac MCS0/Nss1 (VHT40): 37.34 MHz IEEE 802.11ac MCS0/Nss1 (VHT80): 76.12 MHz</p> <p>Mode 2: EUT 1 + Set 2 Sector Antenna / 6.5 dBi</p> <p>Band 1:</p> <p>IEEE 802.11ac MCS0/Nss1 (VHT20): 17.89 MHz IEEE 802.11ac MCS0/Nss1 (VHT40): 37.05 MHz IEEE 802.11ac MCS0/Nss1 (VHT80): 76.41 MHz</p> <p>Band 4:</p> <p>IEEE 802.11ac MCS0/Nss1 (VHT20): 18.32 MHz IEEE 802.11ac MCS0/Nss1 (VHT40): 37.48 MHz IEEE 802.11ac MCS0/Nss1 (VHT80): 75.83 MHz</p> <p>Mode 3: EUT 1 + Set 3 Sector Antenna / 5.5 dBi</p> <p>Band 1:</p> <p>IEEE 802.11ac MCS0/Nss1 (VHT20): 17.89 MHz</p>

	<p>IEEE 802.11ac MCS0/Nss1 (VHT40): 37.05 MHz IEEE 802.11ac MCS0/Nss1 (VHT80): 76.12 MHz Band 4: IEEE 802.11ac MCS0/Nss1 (VHT20): 18.32 MHz IEEE 802.11ac MCS0/Nss1 (VHT40): 38.21 MHz IEEE 802.11ac MCS0/Nss1 (VHT80): 76.12 MHz Mode 4: EUT 1 + Set 4 Sector Antenna / 7.5 dBi Band 1: IEEE 802.11ac MCS0/Nss1 (VHT20): 17.97 MHz IEEE 802.11ac MCS0/Nss1 (VHT40): 37.05 MHz IEEE 802.11ac MCS0/Nss1 (VHT80): 76.12 MHz Band 4: IEEE 802.11ac MCS0/Nss1 (VHT20): 18.23 MHz IEEE 802.11ac MCS0/Nss1 (VHT40): 37.77 MHz IEEE 802.11ac MCS0/Nss1 (VHT80): 76.12 MHz Mode 5: EUT 1 + Set 5 Sector Antenna / 4.5 dBi Band 1: IEEE 802.11ac MCS0/Nss1 (VHT20): 17.97 MHz IEEE 802.11ac MCS0/Nss1 (VHT40): 37.05 MHz IEEE 802.11ac MCS0/Nss1 (VHT80): 76.12 MHz Band 4: IEEE 802.11ac MCS0/Nss1 (VHT20): 18.41 MHz IEEE 802.11ac MCS0/Nss1 (VHT40): 38.35 MHz IEEE 802.11ac MCS0/Nss1 (VHT80): 76.41 MHz Mode 6: EUT 1 + Set 6 Sector Antenna / 4 dBi Band 1: IEEE 802.11ac MCS0/Nss1 (VHT20): 17.97 MHz IEEE 802.11ac MCS0/Nss1 (VHT40): 37.19 MHz IEEE 802.11ac MCS0/Nss1 (VHT80): 76.12 MHz Band 4: IEEE 802.11ac MCS0/Nss1 (VHT20): 18.32 MHz IEEE 802.11ac MCS0/Nss1 (VHT40): 37.92 MHz IEEE 802.11ac MCS0/Nss1 (VHT80): 76.12 MHz Mode 7: EUT 1 + Set 9 Dipole Antenna / 4.67 dBi Band 1: IEEE 802.11ac MCS0/Nss1 (VHT20): 17.97 MHz IEEE 802.11ac MCS0/Nss1 (VHT40): 37.05 MHz IEEE 802.11ac MCS0/Nss1 (VHT80): 76.12 MHz</p>
--	--

	<p>Band 4:</p> <p>IEEE 802.11ac MCS0/Nss1 (VHT20): 18.23 MHz</p> <p>IEEE 802.11ac MCS0/Nss1 (VHT40): 37.77 MHz</p> <p>IEEE 802.11ac MCS0/Nss1 (VHT80): 76.41 MHz</p> <p>Mode 8: EUT 2 + Set 10 PIFA Antenna / Chain1:5.84 dBi, Chain2:5.50 dBi, Chain3:5.84 dBi, Chain4:5.65 dBi</p> <p>Band 1:</p> <p>IEEE 802.11ac MCS0/Nss1 (VHT20): 18.06 MHz</p> <p>IEEE 802.11ac MCS0/Nss1 (VHT40): 37.19 MHz</p> <p>IEEE 802.11ac MCS0/Nss1 (VHT80): 76.12 MHz</p> <p>Band 4:</p> <p>IEEE 802.11ac MCS0/Nss1 (VHT20): 18.06 MHz</p> <p>IEEE 802.11ac MCS0/Nss1 (VHT40): 37.19 MHz</p> <p>IEEE 802.11ac MCS0/Nss1 (VHT80): 76.41 MHz</p>
<p>Maximum Conducted Output Power</p>	<p>Mode 1: EUT 1 + Set 1 Ceiling Mount Omni Antenna / 7 dBi</p> <p>Band 1:</p> <p>IEEE 802.11ac MCS0/Nss1 (VHT20): 24.04 dBm</p> <p>IEEE 802.11ac MCS0/Nss1 (VHT40): 24.74 dBm</p> <p>IEEE 802.11ac MCS0/Nss1 (VHT80): 13.01 dBm</p> <p>Band 4:</p> <p>IEEE 802.11ac MCS0/Nss1 (VHT20): 23.53 dBm</p> <p>IEEE 802.11ac MCS0/Nss1 (VHT40): 21.12 dBm</p> <p>IEEE 802.11ac MCS0/Nss1 (VHT80): 14.91 dBm</p> <p>Mode 2: EUT 1 + Set 2 Sector Antenna / 6.5 dBi</p> <p>Band 1:</p> <p>IEEE 802.11ac MCS0/Nss1 (VHT20): 24.04 dBm</p> <p>IEEE 802.11ac MCS0/Nss1 (VHT40): 24.74 dBm</p> <p>IEEE 802.11ac MCS0/Nss1 (VHT80): 13.01 dBm</p> <p>Band 4:</p> <p>IEEE 802.11ac MCS0/Nss1 (VHT20): 23.53 dBm</p> <p>IEEE 802.11ac MCS0/Nss1 (VHT40): 22.62 dBm</p> <p>IEEE 802.11ac MCS0/Nss1 (VHT80): 15.46 dBm</p> <p>Mode 3: EUT 1 + Set 3 Sector Antenna / 5.5 dBi</p> <p>Band 1:</p> <p>IEEE 802.11ac MCS0/Nss1 (VHT20): 24.04 dBm</p> <p>IEEE 802.11ac MCS0/Nss1 (VHT40): 24.74 dBm</p> <p>IEEE 802.11ac MCS0/Nss1 (VHT80): 14.32 dBm</p>

	<p>Band 4: IEEE 802.11ac MCS0/Nss1 (VHT20): 23.53 dBm IEEE 802.11ac MCS0/Nss1 (VHT40): 23.89 dBm IEEE 802.11ac MCS0/Nss1 (VHT80): 16.87 dBm Mode 4: EUT 1 + Set 4 Sector Antenna / 7.5 dBi</p> <p>Band 1: IEEE 802.11ac MCS0/Nss1 (VHT20): 24.04 dBm IEEE 802.11ac MCS0/Nss1 (VHT40): 24.74 dBm IEEE 802.11ac MCS0/Nss1 (VHT80): 15.44 dBm</p> <p>Band 4: IEEE 802.11ac MCS0/Nss1 (VHT20): 23.53 dBm IEEE 802.11ac MCS0/Nss1 (VHT40): 23.06 dBm IEEE 802.11ac MCS0/Nss1 (VHT80): 14.74 dBm Mode 5: EUT 1 + Set 5 Sector Antenna / 4.5 dBi</p> <p>Band 1: IEEE 802.11ac MCS0/Nss1 (VHT20): 24.04 dBm IEEE 802.11ac MCS0/Nss1 (VHT40): 24.74 dBm IEEE 802.11ac MCS0/Nss1 (VHT80): 16.91 dBm</p> <p>Band 4: IEEE 802.11ac MCS0/Nss1 (VHT20): 23.53 dBm IEEE 802.11ac MCS0/Nss1 (VHT40): 23.89 dBm IEEE 802.11ac MCS0/Nss1 (VHT80): 18.20 dBm Mode 6: EUT 1 + Set 6 Sector Antenna / 4 dBi</p> <p>Band 1: IEEE 802.11ac MCS0/Nss1 (VHT20): 24.04 dBm IEEE 802.11ac MCS0/Nss1 (VHT40): 24.74 dBm IEEE 802.11ac MCS0/Nss1 (VHT80): 15.85 dBm</p> <p>Band 4: IEEE 802.11ac MCS0/Nss1 (VHT20): 23.53 dBm IEEE 802.11ac MCS0/Nss1 (VHT40): 23.89 dBm IEEE 802.11ac MCS0/Nss1 (VHT80): 15.29 dBm Mode 7: EUT 1 + Set 9 Dipole Antenna / 4.67 dBi</p> <p>Band 1: IEEE 802.11ac MCS0/Nss1 (VHT20): 24.04 dBm IEEE 802.11ac MCS0/Nss1 (VHT40): 24.74 dBm IEEE 802.11ac MCS0/Nss1 (VHT80): 14.73 dBm</p> <p>Band 4:</p>
--	---

	IEEE 802.11ac MCS0/Nss1 (VHT20): 24.13 dBm IEEE 802.11ac MCS0/Nss1 (VHT40): 23.89 dBm IEEE 802.11ac MCS0/Nss1 (VHT80): 17.34 dBm Mode 8: EUT 2 + Set 10 PIFA Antenna / Chain1:5.84 dBi, Chain2:5.50 dBi, Chain3:5.84 dBi, Chain4:5.65 dBi Band 1: IEEE 802.11ac MCS0/Nss1 (VHT20): 24.24 dBm IEEE 802.11ac MCS0/Nss1 (VHT40): 24.00 dBm IEEE 802.11ac MCS0/Nss1 (VHT80): 15.75 dBm Band 4: IEEE 802.11ac MCS0/Nss1 (VHT20): 24.21 dBm IEEE 802.11ac MCS0/Nss1 (VHT40): 24.26 dBm IEEE 802.11ac MCS0/Nss1 (VHT80): 15.23 dBm
Carrier Frequencies	Please refer to section 3.4
Antenna	Please refer to section 3.3

Items	Description	
Communication Mode	<input checked="" type="checkbox"/> IP Based (Load Based)	<input type="checkbox"/> Frame Based
Beamforming Function	<input checked="" type="checkbox"/> With beamforming	<input type="checkbox"/> Without beamforming
Operating Mode	<input type="checkbox"/> Outdoor access point	
	<input checked="" type="checkbox"/> Indoor access point	
	<input type="checkbox"/> Fixed point-to-point access points	
	<input type="checkbox"/> Mobile and portable client devices	

Note1: The product has beamforming function for 802.11n/ac in 2.4G/5G.

Note2: Test results of non-beamforming are recorded in test report: FR541527-01AB. Test results of beamforming are recorded in this test report.

Antenna and Band width

Antenna	Four (TX)		
	20 MHz	40 MHz	80 MHz
Band width Mode	20 MHz	40 MHz	80 MHz
IEEE 802.11a	√	X	X
IEEE 802.11n	√	√	X
IEEE 802.11ac	√	√	√

IEEE 11n/ac Spec.

Protocol	Number of Transmit Chains (NTX)	Data Rate / MCS
802.11n (HT20)	4	MCS 0-31
802.11n (HT40)	4	MCS 0-31
802.11ac (VHT20)	4	MCS 0-9/Nss1-4
802.11ac (VHT40)	4	MCS 0-9/Nss1-4
802.11ac (VHT80)	4	MCS 0-9/Nss1-4

Note 1: IEEE Std. 802.11n modulation consists of HT20 and HT40 (HT: High Throughput).
Then EUT supports HT20 and HT40.

Note 2: IEEE Std. 802.11ac modulation consists of VHT20, VHT40, VHT80 and VHT160 (VHT: Very High Throughput). Then EUT supports VHT20, VHT40 and VHT80 in 5GHz.

Note 3: Modulation modes consist of below configuration:
HT20/HT40: IEEE 802.11n, VHT20/VHT40/VHT80: IEEE 802.11ac

3.2. Accessories

N/A

3.3. Table for Filed Antenna

Set.	Brand Holder	Model Number (Part No.)	Extreme Part No. (Short Description)	Antenna Type	Connector	Polarized Antenna	Gain (dBi)	
							2.4GHz	5GHz
1	PCTEL Inc.	WS-AI-DQ04360	WS-AI-DQ04360 (WS-AI-DQ04360)	Ceiling Mount Omni	RP SMA Male	V	4	7
2	PCTEL Inc.	908403-10	30705 (WS-AI-DE07025)	Sector Antenna	RP SMA Male	V	7.5	6.5
3	PCTEL Inc.	908400-10	30702 (WS-AI-DQ05120)	Sector Antenna	RP SMA Male	V	5.5	5.5
4	PCTEL Inc.	908405-10	30707 (WS-AI-DE10055)	Sector Antenna	RP SMA Male	V	10.5	7.5
5	PCTEL Inc.	908404-10	30706 (WS-AI-5Q05025)	Sector Antenna	RP SMA Male	V	-	4.5
6	PCTEL Inc.	908401-10	30703 (WS-AI-5Q04060)	Sector Antenna	RP SMA Male	V	-	4
7	PCTEL Inc.	908402-10	30704 (WS-AI-2Q05060)	Sector Antenna	RP SMA Male	V	5	-
8	Master Wave Technology Co., Ltd.	98152MRSX015	30709 (WS-ANT-2DIP-4)	Dipole Antenna	RP SMA Male	X	4.66	-
9	Master Wave Technology Co., Ltd.	98152URSX009	30710 (WS-ANT-5DIP-4)	Dipole Antenna	RP SMA Male	X	-	4.67
10	Senao Networks, Inc.	AP3935i	-	PIFA Antenna	IPEX	X	Note 1	

Note1:

Set.	Antenna Gain (dBi)							
	2.4GHz				5GHz			
	Chain 1	Chain 2	Chain 3	Chain 4	Chain 1	Chain 2	Chain 3	Chain 4
10	3.81	3.75	3.98	3.47	5.84	5.50	5.84	5.65

Note2:

The EUT has ten sets of antennas.

<For 2.4GHz Function>

For IEEE 802.11b/g/n/ac mode (4TX, 4RX):

Chain 1, Chain 2, Chain 3 and Chain 4 could transmit/receive simultaneously.

<For 5GHz Function>

For IEEE 802.11a/n/ac mode (4TX, 4RX):

Chain 1, Chain 2, Chain 3 and Chain 4 could transmit/receive simultaneously.

For EUT 1:

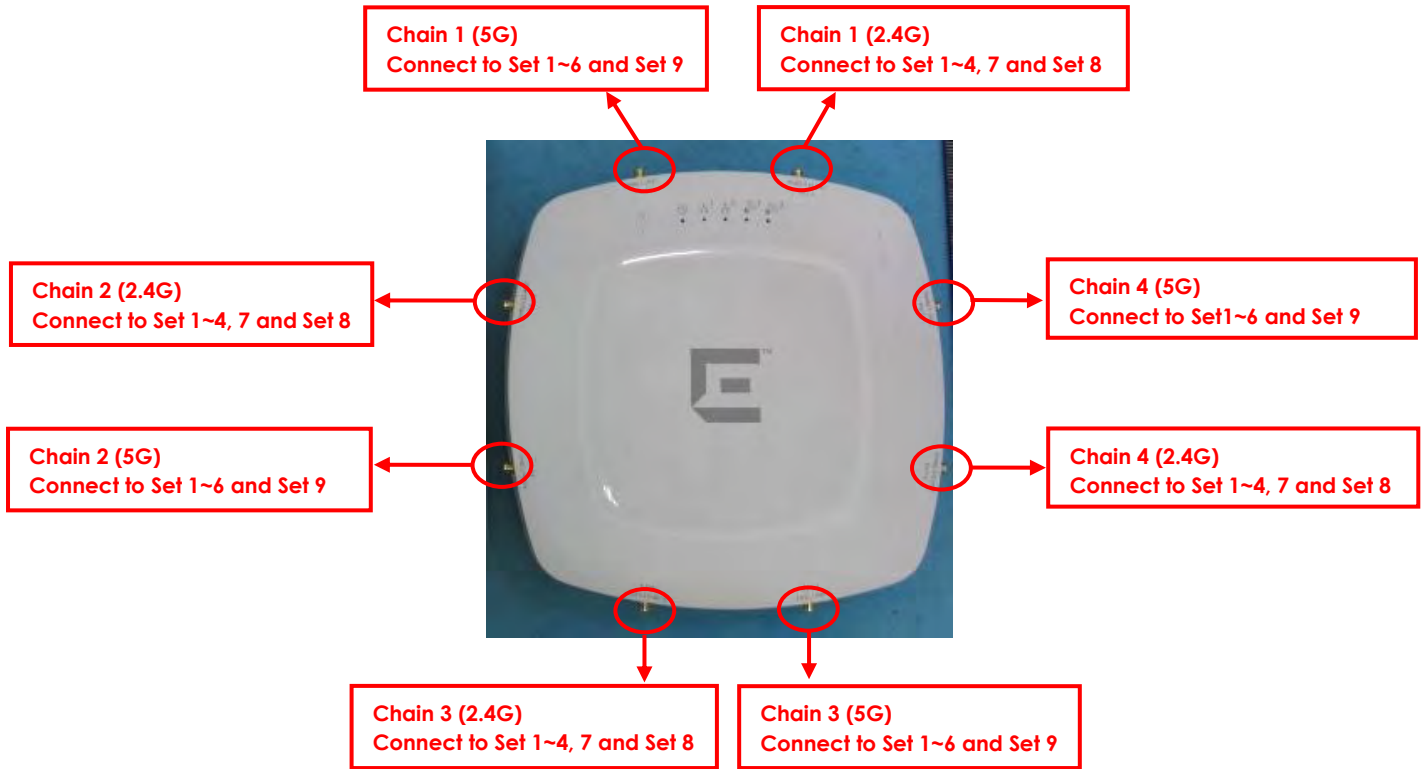

For EUT 2:

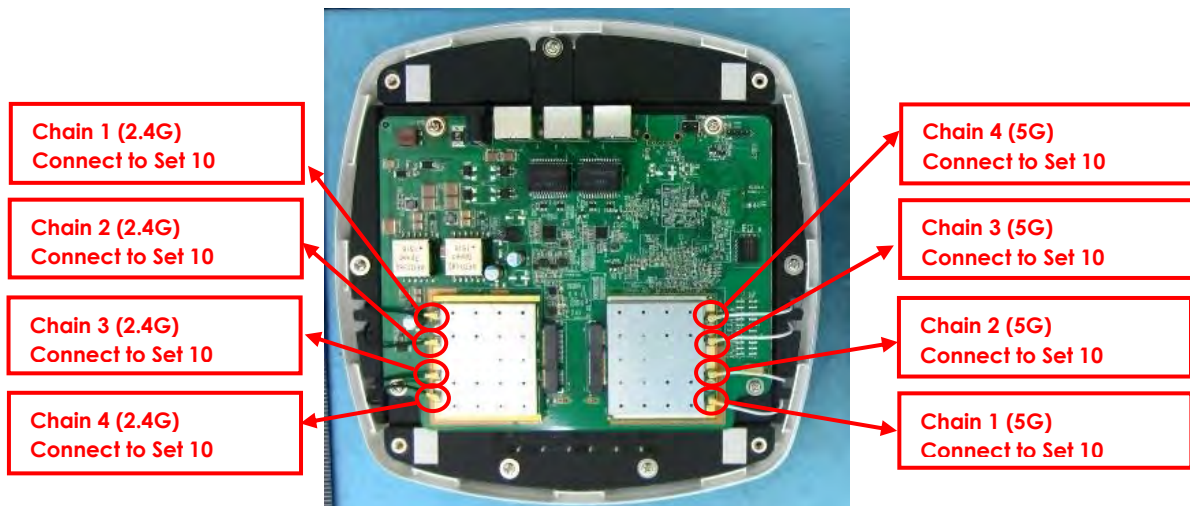

3.4. Table for Carrier Frequencies

There are three bandwidth systems.

For 20MHz bandwidth systems, use Channel 36, 40, 44, 48, 149, 153, 157, 161, 165.

For 40MHz bandwidth systems, use Channel 38, 46, 151, 159.

For 80MHz bandwidth systems, use Channel 42, 155.

Frequency Band	Channel No.	Frequency	Channel No.	Frequency
5150~5250 MHz Band 1	36	5180 MHz	44	5220 MHz
	38	5190 MHz	46	5230 MHz
	40	5200 MHz	48	5240 MHz
	42	5210 MHz	-	-
5725~5850 MHz Band 4	149	5745 MHz	157	5785 MHz
	151	5755 MHz	159	5795 MHz
	153	5765 MHz	161	5805 MHz
	155	5775 MHz	165	5825 MHz

3.5. Table for Test Modes

Preliminary tests were performed in different data rate to find the worst radiated emission. The data rate shown in the table below is the worst-case rate with respect to the specific test item. Investigation has been done on all the possible configurations for searching the worst cases. The following table is a list of the test modes shown in this test report.

Test Items	Mode		Data Rate	Channel	Chain
AC Power Conducted Emission	Normal Link		-	-	-
Max. Conducted Output Power	11ac VHT20	Band 1&4	MCS0/Nss 1	36/40/48/149/ 157/165	1+2+3+4
	11ac VHT40	Band 1&4	MCS0/Nss 1	38/46/151/15 9	1+2+3+4
	11ac VHT80	Band 1&4	MCS0/Nss 1	42/155	1+2+3+4
Power Spectral Density	11ac VHT20	Band 1&4	MCS0/Nss 1	36/40/48/149/ 157/165	1+2+3+4
	11ac VHT40	Band 1&4	MCS0/Nss 1	38/46/151/15 9	1+2+3+4
	11ac VHT80	Band 1&4	MCS0/Nss 1	42/155	1+2+3+4
26dB Spectrum Bandwidth & 99% Occupied Bandwidth Measurement	11ac VHT20	Band 1&4	MCS0/Nss 1	36/40/48/149/ 157/165	1+2+3+4
	11ac VHT40	Band 1&4	MCS0/Nss 1	38/46/151/15 9	1+2+3+4
	11ac VHT80	Band 1&4	MCS0/Nss 1	42/155	1+2+3+4
6dB Spectrum Bandwidth Measurement	11ac VHT20	Band 4	MCS0/Nss 1	149/157/165	1+2+3+4
	11ac VHT40	Band 4	MCS0/Nss 1	151/159	1+2+3+4
	11ac VHT80	Band 4	MCS0/Nss 1	155	1+2+3+4
Radiated Emission Below 1GHz	Normal Link		-	-	-
Radiated Emission Above 1GHz	11ac VHT20	Band 1&4	MCS0/Nss 1	36/40/48/149/ 157/165	1+2+3+4

	11ac VHT40	Band 1&4	MCS0/Nss 1	38/46/151/15 9	1+2+3+4
	11ac VHT80	Band 1&4	MCS0/Nss 1	42/155	1+2+3+4
Band Edge Emission	11ac VHT20	Band 1&4	MCS0/Nss 1	36/40/48/149/ 157/165	1+2+3+4
	11ac VHT40	Band 1&4	MCS0/Nss 1	38/46/151/15 9	1+2+3+4
	11ac VHT80	Band 1&4	MCS0/Nss 1	42/155	1+2+3+4
Frequency Stability	20 MHz	Band 1&4	-	40/157	3, 4
	40 MHz	Band 1&4	-	38/151	3, 4
	80 MHz	Band 1&4	-	42/155	3, 4

Note1: VHT20/VHT40 covers HT20/HT40, due to same modulation. The power setting for 802.11n HT20 and HT40 are the same or lower than 802.11ac VHT20 and VHT40.

Note2:

The adapter and PoE are for measurement only, would not be marketed.

The adapter and PoE information as below:

Power	Brand	Model
Adapter	APD	WA-24Q12R
PoE	Microsemi	PD-9001GR

Note3: All the specification of test configurations and test modes were based on customer's request.

Note4: The console port can not be used by end user. It is generally used for updating FW by professional installer.

The following test modes were performed for all tests:

For Conducted Emission test:

Mode 1. Normal Link - EUT 1+ Adapter

Mode 2. Normal Link - EUT 2+ Adapter

Mode 1 is the worst case, so it was selected to record in this test report.

For Radiated Emission Below 1GHz test:

Mode 1. Place EUT 1 in Y axis + Set 4 + Adapter

Mode 2. Place EUT 1 in Z axis + Set 4 + Adapter

Mode 2 has been evaluated to be the worst case among Mode 1~2, thus measurement for Mode 3~5 will follow this same test mode.

Mode 3. Place EUT 1 in Z axis + Set 4 + PoE

Mode 4. Place EUT 2 in Z axis + Set 10 + Adapter

Mode 5. Place EUT 2 in Z axis + Set 10 + PoE

Mode 2 is the worst case, so it was selected to record in this test report.

For Radiated Emission Above 1GHz test:

The Mode 1~6 and Mode 8 was performed at Y axis and Z axis position. Y axis has been evaluated to be the worst case, thus measurement will follow this same test mode.

The Mode 7 was performed at Y axis and Z axis position. Z axis has been evaluated to be the worst case, thus measurement will follow this same test mode.

Mode 1. Place EUT 1 in Y axis + Set 1

Mode 2. Place EUT 1 in Y axis + Set 2

Mode 3. Place EUT 1 in Y axis + Set 3

Mode 4. Place EUT 1 in Y axis + Set 4

Mode 5. Place EUT 1 in Y axis + Set 5

Mode 6. Place EUT 1 in Y axis + Set 6

Mode 7. Place EUT 1 in Z axis + Set 9

Mode 8. Place EUT 2 in Y axis + Set 10

For Co-location MPE and Radiated Emission Co-location Test:

The EUT could be applied with 2.4GHz WLAN function and 5GHz WLAN function; therefore Co-location Maximum Permissible Exposure (Please refer to FA541527-01AB) and Radiated Emission Co-location (please refer to Appendix B) tests are added for simultaneously transmit between 2.4GHz WLAN function and 5GHz WLAN function.

3.6. Table for Testing Locations

Test Site Location					
Address:	No.8, Lane 724, Bo-ai St., Jhubei City, Hsinchu County 302, Taiwan, R.O.C.				
TEL:	886-3-656-9065				
FAX:	886-3-656-9085				
Test Site No.	Site Category	Location	FCC Reg. No.	IC File No.	VCCI Reg. No
03CH01-CB	SAC	Hsin Chu	262045	IC 4086D	-
TH01-CB	OVEN Room	Hsin Chu	-	-	-

Open Area Test Site (OATS); Semi Anechoic Chamber (SAC).

Testing Location		
<input checked="" type="checkbox"/>	HWA YA	ADD : No. 52, Huaya 1st Rd., Guishan Dist., Taoyuan City, Taiwan (R.O.C.)
		TEL : 886-3-327-3456 FAX : 886-3-327-0973
Test site Designation No. TW1190 with FCC.		
Test site registered number IC 4086B-1 with Industry Canada.		

Test Condition	Test Site No.	Test Engineer	Test Environment	Test Date
Radiated	03CH02-HY	Thor Wei	23°C / 66%	12/Aug/2017
AC Conduction	CO04-HY	Teddy Chang	22°C / 55%	15/Aug/2017

3.7. Table for Multiple Listing

The model names are identical to each other in all aspects except for the following table:

Equipment	EUT	Product Name	Model Name	Internal Antenna	External Antenna	Equipped Antenna
Wireless 802.11a/AC+ b/g/n Access Point	1	WS-AP3935e-FCC	31014	X	V	Set 1~9
	2	WS-AP3935i-FCC	31012	V	X	Set 10

3.8. Table for Supporting Units

For Test Site No: 03CH02-HY (For Below 1GHz)

Support Unit	Brand	Model	FCC ID
Load	-	-	N/A
Notebook	DELL	E6400	N/A
Adapter (Client Provided)	APD	WA-24Q12R	N/A

For Test Site No: 03CH01-CB (For Above 1GHz)

Support Unit	Brand	Model	FCC ID
Notebook*2	DELL	E4300	DoC
Device	Extreme Networks	31012	QXO-4411AC
Adapter (Client Provided)	APD	WA-24Q12R	N/A

For Test Site No: CO04-HY

Support Unit	Brand	Model	FCC ID
Adapter (Client Provided)	APD	WA-24Q12R	N/A
Dummy Load	-	-	N/A
Notebook	DELL	E5430	DoC
Notebook(2.4G)	DELL	P55G	DoC
Notebook(5G)	DELL	P55G	DoC

For Test Site No: TH01-CB

Support Unit	Brand	Model	FCC ID
Notebook	DELL	E4300	DoC
Adapter (Client Provided)	APD	WA-24Q12R	N/A

3.9. Table for Parameters of Test Software Setting

During testing, Channel and Power Controlling Software provided by the customer was used to control the operating channel as well as the output power level. The RF output power selection is for the setting of RF output power expected by the customer and is going to be fixed on the firmware of the final end product.

Mode 1: EUT 1 + Set 1 Ceiling Mount Omni Antenna / 7 dBi

Test Software Version	QCA VER3.0.144.0							
Mode	Test Frequency (MHz)							
	NCB: 20MHz							
	5180 MHz	5200 MHz	5240 MHz	5745 MHz	5785 MHz	5825 MHz		
802.11ac MCS0/Nss1 VHT20	16.5	18	18	14	18	16.5		
Mode	NCB: 40MHz							
802.11ac MCS0/Nss1 VHT40	5190 MHz		5230 MHz		5755 MHz		5795 MHz	
	10		18		10		15	
Mode	NCB: 80MHz							
802.11ac MCS0/Nss1 VHT80	5210 MHz			5775 MHz				
	7.5			10				

Mode 2: EUT 1 + Set 2 Sector Antenna / 6.5 dBi

Test Software Version	QCA VER3.0.144.0							
Mode	Test Frequency (MHz)							
	NCB: 20MHz							
	5180 MHz	5200 MHz	5240 MHz	5745 MHz	5785 MHz	5825 MHz		
802.11ac MCS0/Nss1 VHT20	16.5	18	18	15	18	17		
Mode	NCB: 40MHz							
802.11ac MCS0/Nss1 VHT40	5190 MHz		5230 MHz		5755 MHz		5795 MHz	
	10.5		18		11.5		16.5	
Mode	NCB: 80MHz							
802.11ac MCS0/Nss1 VHT80	5210 MHz			5775 MHz				
	7.5			11				

Mode 3: EUT 1 + Set 3 Sector Antenna / 5.5 dBi

Test Software Version		QCA VER3.0.144.0							
Mode		Test Frequency (MHz)							
		NCB: 20MHz							
		5180 MHz	5200 MHz	5240 MHz	5745 MHz	5785 MHz	5825 MHz		
802.11ac VHT20	MCS0/Nss1	18	18	18	16	18	17		
Mode		NCB: 40MHz							
802.11ac VHT40	MCS0/Nss1	5190 MHz		5230 MHz		5755 MHz		5795 MHz	
		11.5		18		11.5		18	
Mode		NCB: 80MHz							
802.11ac VHT80	MCS0/Nss1	5210 MHz			5775 MHz				
		9			11.5				

Mode 4: EUT 1 + Set 4 Sector Antenna / 7.5 dBi

Test Software Version		QCA VER3.0.144.0							
Mode		Test Frequency (MHz)							
		NCB: 20MHz							
		5180 MHz	5200 MHz	5240 MHz	5745 MHz	5785 MHz	5825 MHz		
802.11ac VHT20	MCS0/Nss1	17.5	18	18	13.5	18	17		
Mode		NCB: 40MHz							
802.11ac VHT40	MCS0/Nss1	5190 MHz		5230 MHz		5755 MHz		5795 MHz	
		10.5		18		11		17	
Mode		NCB: 80MHz							
802.11ac VHT80	MCS0/Nss1	5210 MHz			5775 MHz				
		9.5			10				

Mode 5: EUT 1 + Set 5 Sector Antenna / 4.5 dBi

Test Software Version		QCA VER3.0.144.0							
Mode		Test Frequency (MHz)							
		NCB: 20MHz							
		5180 MHz	5200 MHz	5240 MHz	5745 MHz	5785 MHz	5825 MHz		
802.11ac VHT20	MCS0/Nss1	18	18	18	15.5	18	17		
Mode		NCB: 40MHz							
802.11ac VHT40	MCS0/Nss1	5190 MHz		5230 MHz		5755 MHz		5795 MHz	
		15		18		13		18	
Mode		NCB: 80MHz							
802.11ac VHT80	MCS0/Nss1	5210 MHz			5775 MHz				
		12			12.5				

Mode 6: EUT 1 + Set 6 Sector Antenna / 4 dBi

Test Software Version		QCA VER3.0.144.0							
Mode		Test Frequency (MHz)							
		NCB: 20MHz							
		5180 MHz	5200 MHz	5240 MHz	5745 MHz	5785 MHz	5825 MHz		
802.11ac VHT20	MCS0/Nss1	16.5	18	18	15	18	17		
Mode		NCB: 40MHz							
802.11ac VHT40	MCS0/Nss1	5190 MHz		5230 MHz		5755 MHz		5795 MHz	
		11.5		18		11.5		18	
Mode		NCB: 80MHz							
802.11ac VHT80	MCS0/Nss1	5210 MHz			5775 MHz				
		11			10.5				

Mode 7: EUT 1 + Set 9 Dipole Antenna / 4.67 dBi

Test Software Version		QCA VER3.0.144.0							
Mode		Test Frequency (MHz)							
		NCB: 20MHz							
		5180 MHz	5200 MHz	5240 MHz	5745 MHz	5785 MHz	5825 MHz		
802.11ac VHT20	MCS0/Nss1	18	18	18	16	18	18		
Mode		NCB: 40MHz							
802.11ac VHT40	MCS0/Nss1	5190 MHz		5230 MHz		5755 MHz		5795 MHz	
		13		18		12.5		18	
Mode		NCB: 80MHz							
802.11ac VHT80	MCS0/Nss1	5210 MHz			5775 MHz				
		9.5			12				

Mode 8: EUT 2 + Set 10 PIFA Antenna / Chain1:5.84 dBi, Chain2:5.50 dBi, Chain3:5.84 dBi, Chain4:5.65 dBi

Test Software Version		QCA VER3.0.144.0							
Mode		Test Frequency (MHz)							
		NCB: 20MHz							
		5180 MHz	5200 MHz	5240 MHz	5745 MHz	5785 MHz	5825 MHz		
802.11ac VHT20	MCS0/Nss1	18	18	18	17	18	18		
Mode		NCB: 40MHz							
802.11ac VHT40	MCS0/Nss1	5190 MHz		5230 MHz		5755 MHz		5795 MHz	
		15		17		11.5		17.5	
Mode		NCB: 80MHz							
802.11ac VHT80	MCS0/Nss1	5210 MHz			5775 MHz				
		9.5			9				

3.10. EUT Operation during Test

The EUT was programmed to be in continuously transmitting mode.

3.11. Duty Cycle

Mode	On Time (ms)	On+Off Time (ms)	Duty Cycle (%)	Duty Factor (dB)	1/T Minimum VBW (kHz)
802.11ac MCS0/Nss1 VHT20	1.770	1.940	91.24	0.40	0.56
802.11ac MCS0/Nss1 VHT40	1.664	1.840	90.43	0.44	0.60
802.11ac MCS0/Nss1 VHT80	1.920	2.224	86.33	0.64	0.52

3.12. Test Configurations

3.12.1. AC Power Line Conduction Emissions Test Configuration

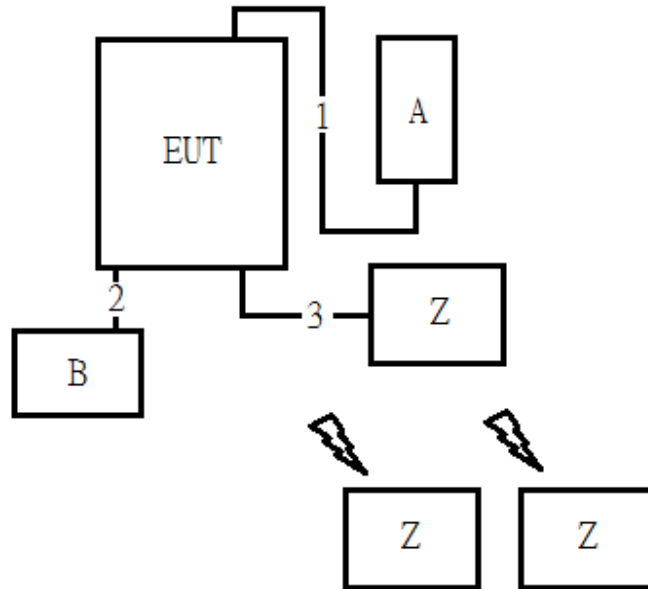

Item	Connection	Shielded	Length(m)
1	DC Power Cable	No	1.5
2	RJ45 Cable	No	1
3	RJ45 Cable	No	10

No.	Equipment	Brand	Model	FCC ID
A	Adapter	APD	WA-24Q12R	N/A
B	Dummy Load	-	-	N/A
Z	NoteBook	DELL	E5430	DoC
Z	NoteBook(2.4G)	DELL	P55G	DoC
Z	NoteBook(5G)	DELL	P55G	DoC

3.12.2. Radiation Emissions Test Configuration

Test Configuration: 30MHz ~1GHz

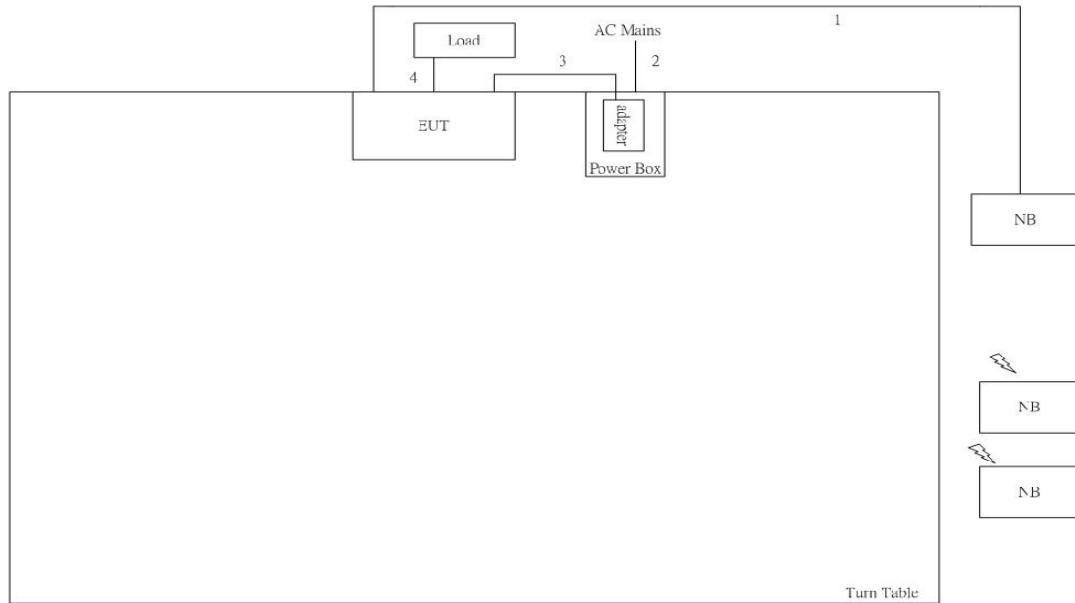

Item	Connection	Shielded	Length(m)
1	LAN Cable	No	10
2	AC Power line	No	1.8
3	DC Power line	No	1.5
4	LAN line	No	3

Test Configuration: above 1GHz

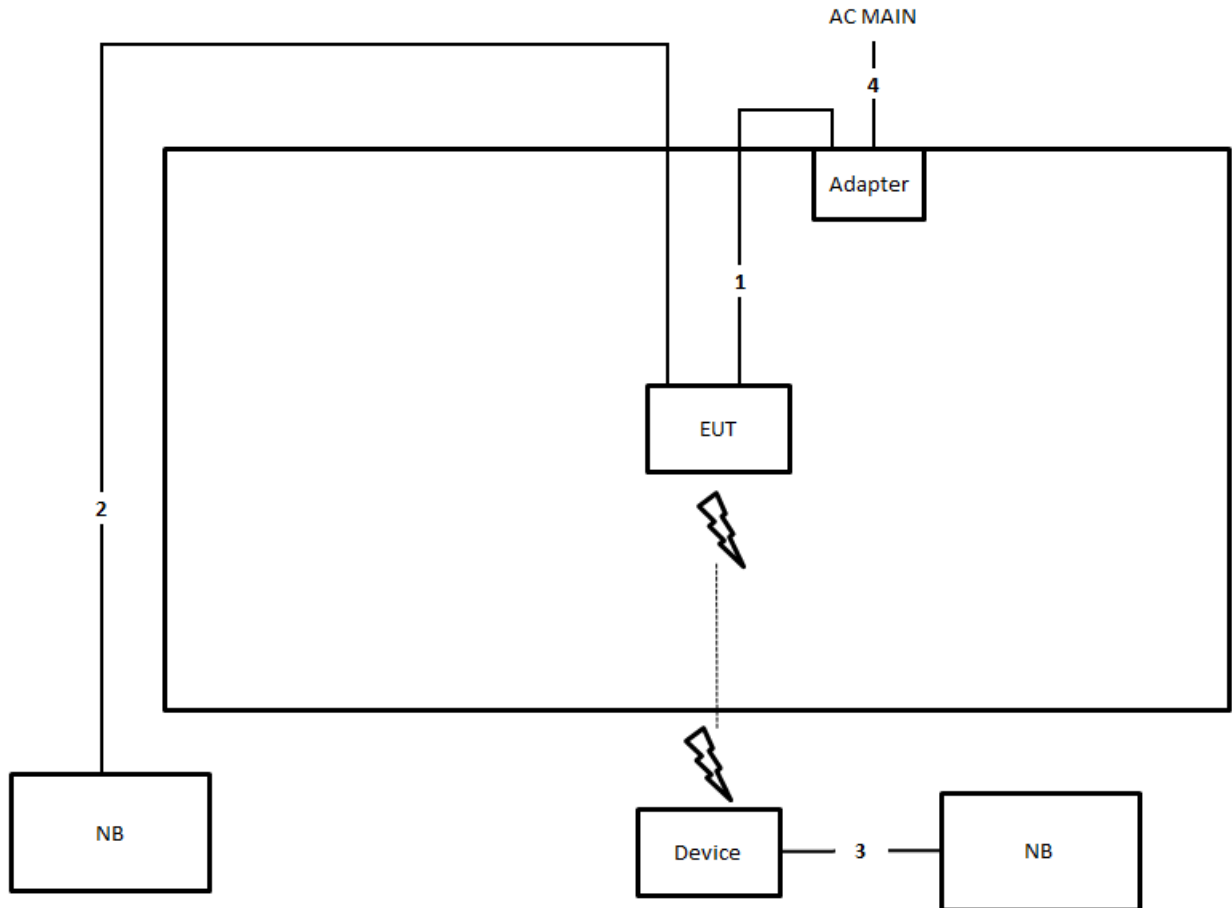

Item	Connection	Shielded	Length(m)
1	DC Power cable	No	1.2
2	RJ-45 cable	No	10
3	RJ-45 cable	No	1.5
4	AC Power cable	No	1.8

4. TEST RESULT

4.1. AC Power Line Conducted Emissions Measurement

4.1.1. Limit

For this product that is designed to connect to the AC power line, the radio frequency voltage that is conducted back onto the AC power line on any frequency or frequencies within the band 150 kHz to 30 MHz shall not exceed below limits table.

Frequency (MHz)	QP Limit (dBuV)	AV Limit (dBuV)
0.15~0.5	66~56	56~46
0.5~5	56	46
5~30	60	50

4.1.2. Measuring Instruments and Setting

Please refer to section 5 of equipments list in this report. The following table is the setting of the receiver.

Receiver Parameters	Setting
Attenuation	10 dB
Start Frequency	0.15 MHz
Stop Frequency	30 MHz
IF Bandwidth	9 kHz

4.1.3. Test Procedures

1. Configure the EUT according to ANSI C63.10. The EUT or host of EUT has to be placed 0.4 meter far from the conducting wall of the shielding room and at least 80 centimeters from any other grounded conducting surface.
2. Connect EUT or host of EUT to the power mains through a line impedance stabilization network (LISN).
3. All the support units are connected to the other LISNs. The LISN should provide 50uH/50ohms coupling impedance.
4. The frequency range from 150 kHz to 30 MHz was searched.
5. Set the test-receiver system to Peak Detect Function and Specified Bandwidth with Maximum Hold Mode.
6. The measurement has to be done between each power line and ground at the power terminal.

4.1.4. Test Setup Layout

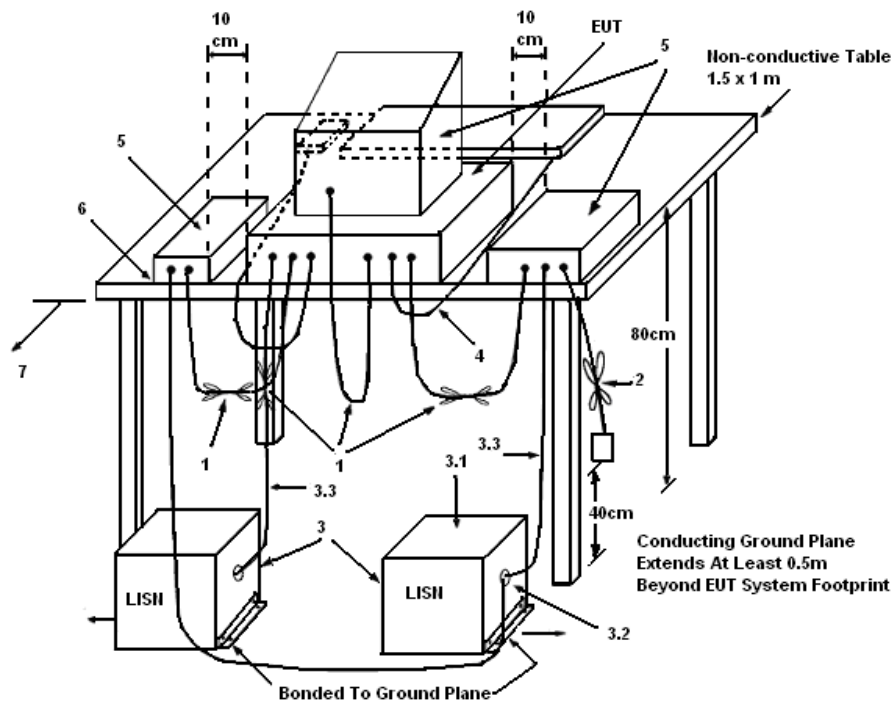

LEGEND:

- (1) Interconnecting cables that hang closer than 40 cm to the ground plane shall be folded back and forth in the center forming a bundle 30 to 40 cm long.
- (2) I/O cables that are not connected to a peripheral shall be bundled in the center. The end of the cable may be terminated, if required, using the correct terminating impedance. The overall length shall not exceed 1 m.
- (3) EUT connected to one LISN. Unused LISN measuring port connectors shall be terminated in 50 Ω . LISN can be placed on top of, or immediately beneath, reference ground plane.
 - (3.1) All other equipment powered from additional LISN(s).
 - (3.2) Multiple outlet strip can be used for multiple power cords of non-EUT equipment.
 - (3.3) LISN at least 80 cm from nearest part of EUT chassis.
- (4) Cables of hand-operated devices, such as keyboards, mice, etc., shall be placed as for normal use.
- (5) Non-EUT components of EUT system being tested.
- (6) Rear of EUT, including peripherals, shall all be aligned and flush with rear of tabletop.
- (7) Rear of tabletop shall be 40 cm removed from a vertical conducting plane that is bonded to the ground plane.

4.1.5. Test Deviation

There is no deviation with the original standard.

4.1.6. EUT Operation during Test

The EUT was placed on the test table and programmed in normal function.

4.1.7. Results of AC Power Line Conducted Emissions Measurement

Temperature	22°C	Humidity	55%
Test Engineer	Teddy Chang	Phase	Line
Configuration	Normal Link	Test Mode	Mode 1

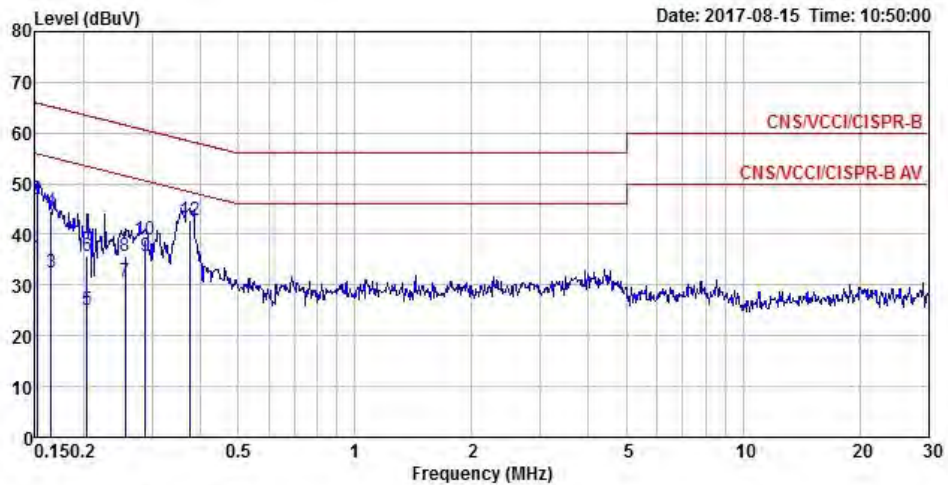

	Freq	Level	Over	Limit	Read	LISN	Cable	Remark
	MHz	dBuV	Limit	Line	Level	Factor	Loss	
			dB	dBuV	dBuV	dB	dB	
1	0.15	35.31	-20.60	55.91	25.43	9.66	0.22	Average
2	0.15	46.88	-19.03	65.91	37.00	9.66	0.22	QP
3	0.17	32.33	-22.88	55.21	22.42	9.66	0.25	Average
4	0.17	44.48	-20.73	65.21	34.57	9.66	0.25	QP
5	0.20	25.00	-28.45	53.45	15.06	9.65	0.29	Average
6	0.20	35.68	-27.77	63.45	25.74	9.65	0.29	QP
7	0.26	30.65	-20.91	51.56	20.76	9.66	0.23	Average
8	0.26	35.75	-25.81	61.56	25.86	9.66	0.23	QP
9	0.29	35.66	-14.93	50.59	25.79	9.67	0.20	Average
10	0.29	38.83	-21.76	60.59	28.96	9.67	0.20	QP
11	0.38	41.35	-7.04	48.39	31.55	9.68	0.12	Average
12	0.38	42.86	-15.53	58.39	33.06	9.68	0.12	QP

Temperature	22°C	Humidity	55%
Test Engineer	Teddy Chang	Phase	Neutral
Configuration	Normal Link	Test Mode	Mode 1

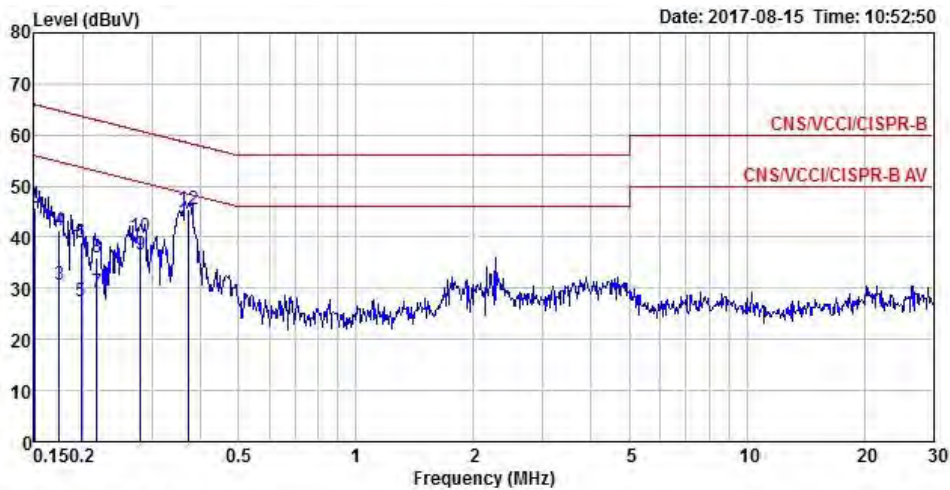

	Freq	Level	Over	Limit	Read	LISN	Cable	Remark
	MHz	dBuV	Limit	Line	Level	Factor	Loss	
			dB	dBuV	dBuV	dB	dB	
1	0.15	34.62	-21.38	56.00	24.80	9.60	0.22	Average
2	0.15	45.82	-20.18	66.00	36.00	9.60	0.22	QP
3	0.17	30.67	-24.10	54.77	20.77	9.64	0.26	Average
4	0.17	41.35	-23.42	64.77	31.45	9.64	0.26	QP
5	0.20	27.43	-26.28	53.71	17.46	9.67	0.30	Average
6	0.20	39.01	-24.70	63.71	29.04	9.67	0.30	QP
7	0.22	29.30	-23.62	52.92	19.37	9.66	0.27	Average
8	0.22	36.02	-26.90	62.92	26.09	9.66	0.27	QP
9	0.28	36.73	-14.08	50.81	26.88	9.65	0.20	Average
10	0.28	40.02	-20.79	60.81	30.17	9.65	0.20	QP
11	0.37	43.17	-5.30	48.47	33.42	9.63	0.12	Average
12	0.37	45.52	-12.95	58.47	35.77	9.63	0.12	QP

Note:

Level = Read Level + LISN Factor + Cable Loss.

4.2. 26dB Bandwidth and 99% Occupied Bandwidth Measurement

4.2.1. Limit

No restriction limits.

4.2.2. Measuring Instruments and Setting

Please refer to section 5 of equipments list in this report. The following table is the setting of the spectrum analyzer.

26dB Bandwidth	
Spectrum Parameters	Setting
Attenuation	Auto
Span Frequency	> 26dB Bandwidth
RBW	Approximately 1% of the emission bandwidth
VBW	VBW > RBW
Detector	Peak
Trace	Max Hold
Sweep Time	Auto
99% Occupied Bandwidth	
Spectrum Parameters	Setting
Span	1.5 times to 5.0 times the OBW
RBW	1 % to 5 % of the OBW
VBW	$\geq 3 \times$ RBW
Detector	Peak
Trace	Max Hold

4.2.3. Test Procedures

For Radiated 26dB Bandwidth and 99% Occupied Bandwidth Measurement:

1. The transmitter was radiated to the spectrum analyzer in peak hold mode.
2. Measure the maximum width of the emission that is 26 dB down from the peak of the emission. Compare this with the RBW setting of the analyzer. Readjust RBW and repeat measurement as needed until the RBW/EBW ratio is approximately 1%.

4.2.4. Test Setup Layout

For Radiated 26dB Bandwidth and 99% Occupied Bandwidth Measurement:

This test setup layout is the same as that shown in section 4.6.4.

4.2.5. Test Deviation

There is no deviation with the original standard.

4.2.6. EUT Operation during Test

The EUT was programmed to be in continuously transmitting mode.

4.2.7. Test Result of 26dB Bandwidth and 99% Occupied Bandwidth

Temperature	25°C	Humidity	50%
Test Engineer	Eddie Weng & Lucas Huang		
Test Mode	Mode 1: EUT 1 + Set 1 Ceiling Mount Omni Antenna / 7 dBi		

Mode	Frequency	26dB Bandwidth (MHz)	99% Occupied Bandwidth (MHz)
802.11ac MCS0/Nss1 VHT20	5180 MHz	20.87	17.89
	5200 MHz	21.22	17.80
	5240 MHz	21.65	17.80
	5745 MHz	22.96	18.06
	5785 MHz	23.48	18.15
	5825 MHz	21.91	17.89
802.11ac MCS0/Nss1 VHT40	5190 MHz	44.35	37.19
	5230 MHz	43.48	37.05
	5755 MHz	46.23	37.05
	5795 MHz	47.25	37.34
802.11ac MCS0/Nss1 VHT80	5210 MHz	86.96	76.12
	5775 MHz	86.38	76.12

Temperature	25°C	Humidity	50%
Test Engineer	Eddie Weng & Lucas Huang		
Test Mode	Mode 2: EUT 1 + Set 2 Sector Antenna / 6.5 dBi		

Mode	Frequency	26dB Bandwidth (MHz)	99% Occupied Bandwidth (MHz)
802.11ac MCS0/Nss1 VHT20	5180 MHz	21.39	17.89
	5200 MHz	21.04	17.80
	5240 MHz	21.91	17.80
	5745 MHz	22.61	17.89
	5785 MHz	28.17	18.32
	5825 MHz	31.39	18.15
802.11ac MCS0/Nss1 VHT40	5190 MHz	43.91	36.90
	5230 MHz	43.62	37.05
	5755 MHz	45.94	37.19
	5795 MHz	53.48	37.48
802.11ac MCS0/Nss1 VHT80	5210 MHz	84.93	76.41
	5775 MHz	85.80	75.83

Temperature	25°C	Humidity	50%
Test Engineer	Eddie Weng & Lucas Huang		
Test Mode	Mode 3: EUT 1 + Set 3 Sector Antenna / 5.5 dBi		

Mode	Frequency	26dB Bandwidth (MHz)	99% Occupied Bandwidth (MHz)
802.11ac MCS0/Nss1 VHT20	5180 MHz	21.74	17.80
	5200 MHz	21.39	17.89
	5240 MHz	21.39	17.80
	5745 MHz	24.00	18.06
	5785 MHz	28.87	18.32
	5825 MHz	26.52	17.97
802.11ac MCS0/Nss1 VHT40	5190 MHz	44.49	36.90
	5230 MHz	43.77	37.05
	5755 MHz	46.09	37.34
	5795 MHz	74.20	38.21
802.11ac MCS0/Nss1 VHT80	5210 MHz	84.64	76.12
	5775 MHz	88.12	76.12

Temperature	25°C	Humidity	50%
Test Engineer	Eddie Weng & Lucas Huang		
Test Mode	Mode 4: EUT 1 + Set 4 Sector Antenna / 7.5 dBi		

Mode	Frequency	26dB Bandwidth (MHz)	99% Occupied Bandwidth (MHz)
802.11ac MCS0/Nss1 VHT20	5180 MHz	21.57	17.97
	5200 MHz	20.96	17.80
	5240 MHz	21.57	17.89
	5745 MHz	22.78	18.06
	5785 MHz	27.30	18.23
	5825 MHz	26.70	17.97
802.11ac MCS0/Nss1 VHT40	5190 MHz	43.19	36.90
	5230 MHz	43.91	37.05
	5755 MHz	45.36	37.34
	5795 MHz	55.65	37.77
802.11ac MCS0/Nss1 VHT80	5210 MHz	84.35	76.12
	5775 MHz	87.54	76.12

Temperature	25°C	Humidity	50%
Test Engineer	Eddie Weng & Lucas Huang		
Test Mode	Mode 5: EUT 1 + Set 5 Sector Antenna / 4.5 dBi		

Mode	Frequency	26dB Bandwidth (MHz)	99% Occupied Bandwidth (MHz)
802.11ac MCS0/Nss1 VHT20	5180 MHz	20.87	17.97
	5200 MHz	22.09	17.97
	5240 MHz	21.74	17.89
	5745 MHz	22.96	17.97
	5785 MHz	31.57	18.41
	5825 MHz	33.74	18.32
802.11ac MCS0/Nss1 VHT40	5190 MHz	44.93	37.05
	5230 MHz	44.64	37.05
	5755 MHz	47.97	37.19
	5795 MHz	75.94	38.35
802.11ac MCS0/Nss1 VHT80	5210 MHz	84.64	76.12
	5775 MHz	88.12	76.41

Temperature	25°C	Humidity	50%
Test Engineer	Eddie Weng & Lucas Huang		
Test Mode	Mode 6: EUT 1 + Set 6 Sector Antenna / 4 dBi		

Mode	Frequency	26dB Bandwidth (MHz)	99% Occupied Bandwidth (MHz)
802.11ac MCS0/Nss1 VHT20	5180 MHz	21.91	17.97
	5200 MHz	21.91	17.80
	5240 MHz	22.00	17.80
	5745 MHz	23.74	18.15
	5785 MHz	28.87	18.32
	5825 MHz	24.09	18.15
802.11ac MCS0/Nss1 VHT40	5190 MHz	44.49	37.19
	5230 MHz	43.91	36.90
	5755 MHz	53.04	37.63
	5795 MHz	66.96	37.92
802.11ac MCS0/Nss1 VHT80	5210 MHz	86.38	76.12
	5775 MHz	86.09	76.12

Temperature	25°C	Humidity	50%
Test Engineer	Eddie Weng & Lucas Huang		
Test Mode	Mode 7: EUT 1 + Set 9 Dipole Antenna / 4.67 dBi		

Mode	Frequency	26dB Bandwidth (MHz)	99% Occupied Bandwidth (MHz)
802.11ac MCS0/Nss1 VHT20	5180 MHz	21.57	17.97
	5200 MHz	20.96	17.80
	5240 MHz	21.57	17.89
	5745 MHz	22.78	18.15
	5785 MHz	27.30	18.23
	5825 MHz	27.22	18.15
802.11ac MCS0/Nss1 VHT40	5190 MHz	43.19	36.90
	5230 MHz	43.91	37.05
	5755 MHz	46.81	37.34
	5795 MHz	60.15	37.77
802.11ac MCS0/Nss1 VHT80	5210 MHz	84.35	76.12
	5775 MHz	88.70	76.41

Temperature	25°C	Humidity	50%
Test Engineer	Eddie Weng & Lucas Huang		
Test Mode	Mode 8: EUT 2 + Set 10 PIFA Antenna / Chain1:5.84 dBi, Chain2:5.50 dBi, Chain3:5.84 dBi, Chain4:5.65 dBi		

Mode	Frequency	26dB Bandwidth (MHz)	99% Occupied Bandwidth (MHz)
802.11ac MCS0/Nss1 VHT20	5180 MHz	22.70	18.06
	5200 MHz	22.87	18.06
	5240 MHz	22.87	18.06
	5745 MHz	22.17	17.97
	5785 MHz	22.26	18.06
	5825 MHz	22.17	18.06
802.11ac MCS0/Nss1 VHT40	5190 MHz	44.06	37.05
	5230 MHz	44.49	37.19
	5755 MHz	43.77	37.19
	5795 MHz	49.28	37.19
802.11ac MCS0/Nss1 VHT80	5210 MHz	85.22	76.12
	5775 MHz	86.67	76.41

Mode 1: EUT 1 + Set 1 Ceiling Mount Omni Antenna / 7 dBi

26dB Bandwidth and 99% Occupied Bandwidth Plot on Configuration IEEE 802.11ac MCS0/Nss1 VHT20 / Chain 1 + Chain 2 + Chain 3 + Chain 4 / 5180 MHz

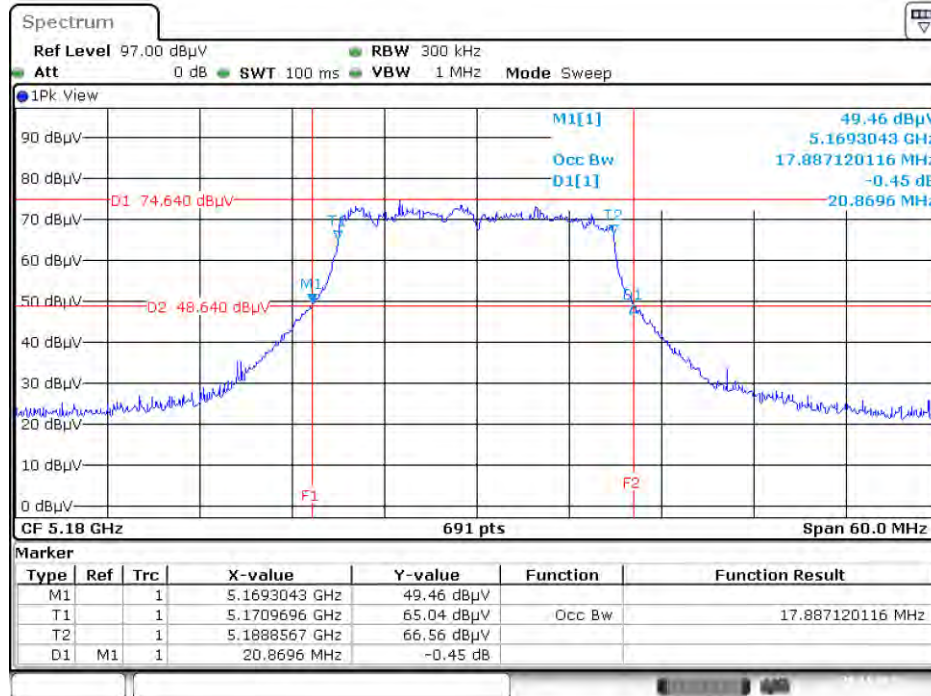

Date: 28 NOV. 2015 01:28:52

26dB Bandwidth and 99% Occupied Bandwidth Plot on Configuration IEEE 802.11ac MCS0/Nss1 VHT20 / Chain 1 + Chain 2 + Chain 3 + Chain 4 / 5200 MHz

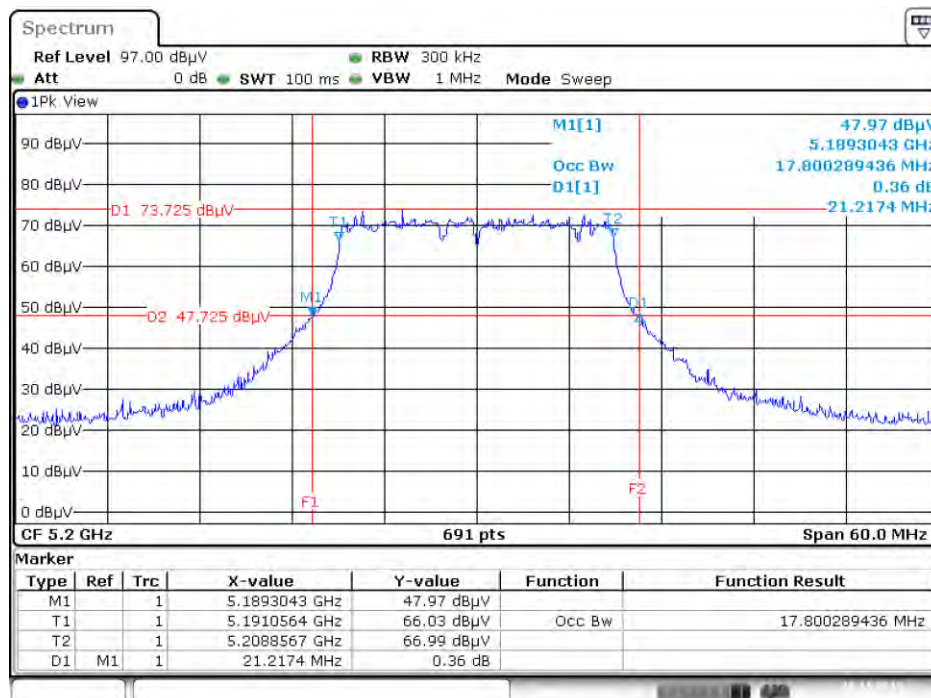

Date: 28 NOV. 2015 01:29:50

26dB Bandwidth and 99% Occupied Bandwidth Plot on Configuration IEEE 802.11ac MCS0/Nss1 VHT20 / Chain 1 + Chain 2 + Chain 3 + Chain 4 / 5240 MHz

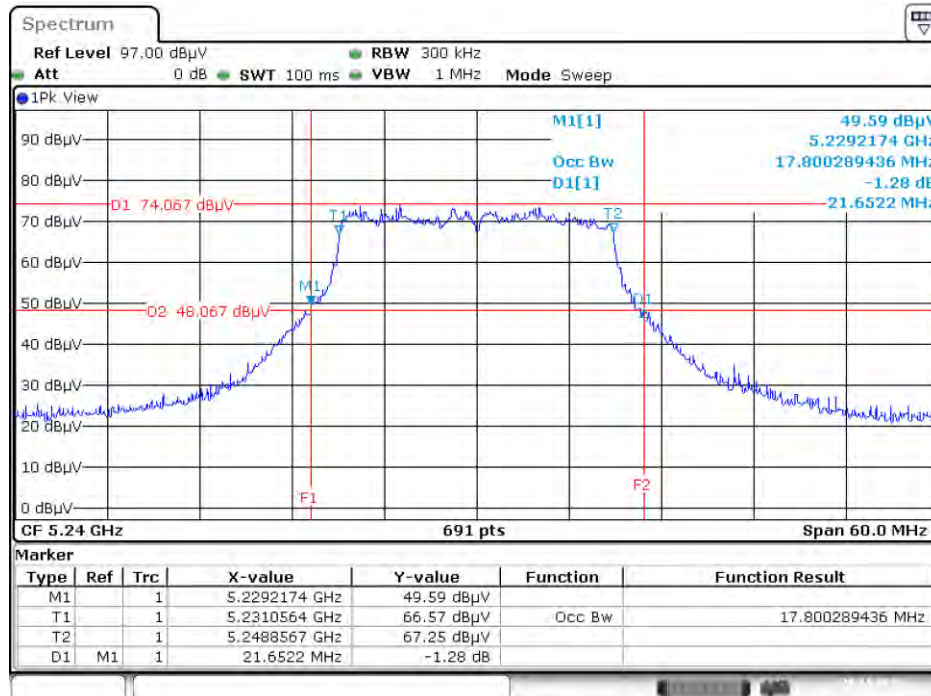

Date: 28.NOV.2015 01:30:23

26dB Bandwidth and 99% Occupied Bandwidth Plot on Configuration IEEE 802.11ac MCS0/Nss1 VHT20 / Chain 1 + Chain 2 + Chain 3 + Chain 4 / 5745 MHz

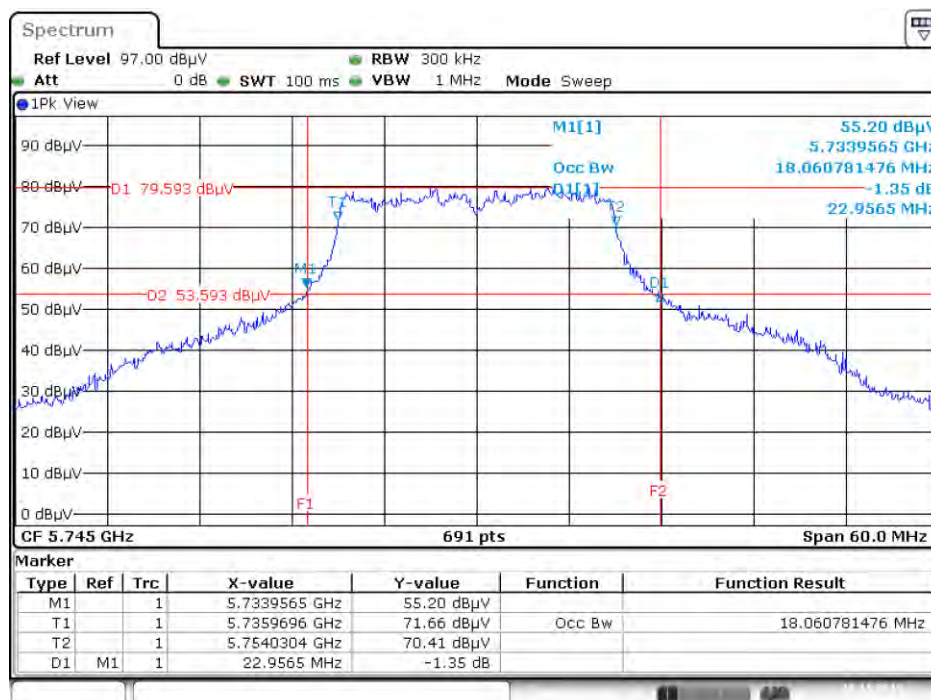

Date: 28.NOV.2015 01:33:48

26dB Bandwidth and 99% Occupied Bandwidth Plot on Configuration IEEE 802.11ac MCS0/Nss1 VHT20 / Chain 1 + Chain 2 + Chain 3 + Chain 4 / 5785 MHz

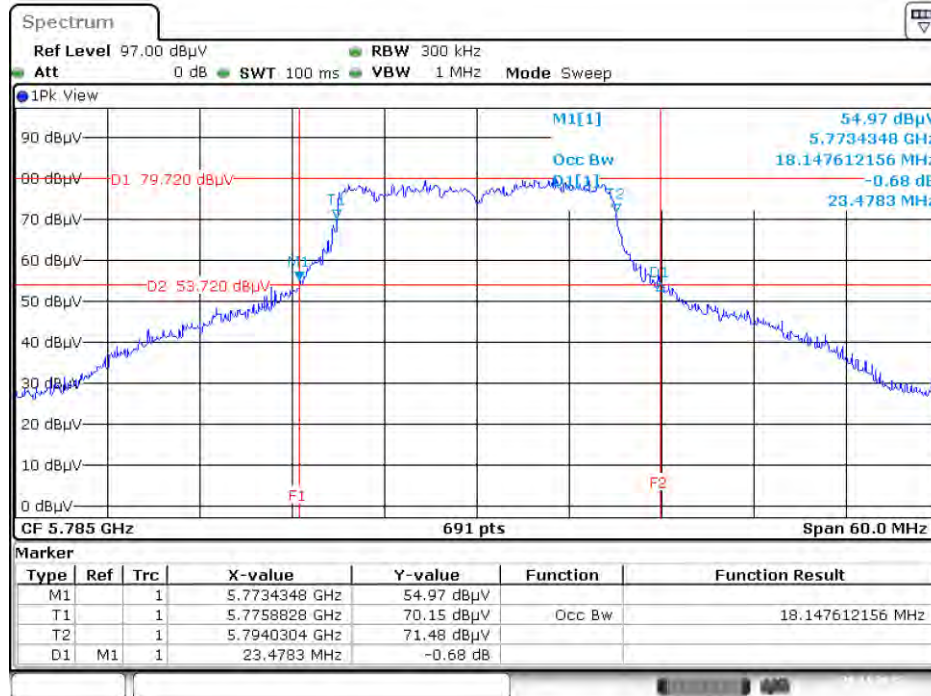

Date: 28.NOV.2015 01:34:16

26dB Bandwidth and 99% Occupied Bandwidth Plot on Configuration IEEE 802.11ac MCS0/Nss1 VHT20 / Chain 1 + Chain 2 + Chain 3 + Chain 4 / 5825 MHz

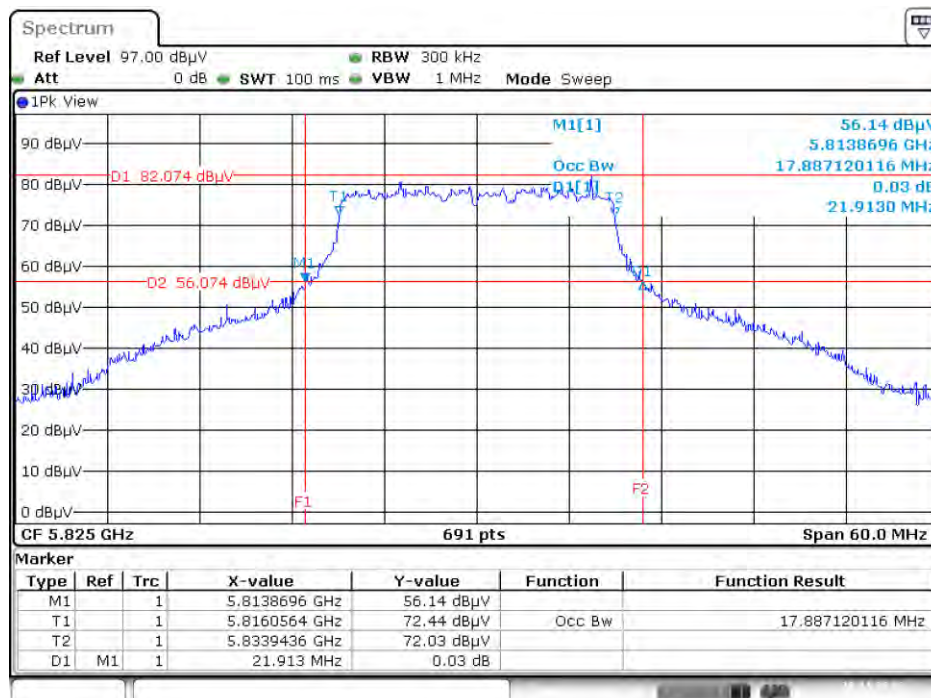

Date: 28.NOV.2015 01:34:41

26dB Bandwidth and 99% Occupied Bandwidth Plot on Configuration IEEE 802.11ac MCS0/Nss1 VHT40 / Chain 1 + Chain 2 + Chain 3 + Chain 4 / 5190 MHz

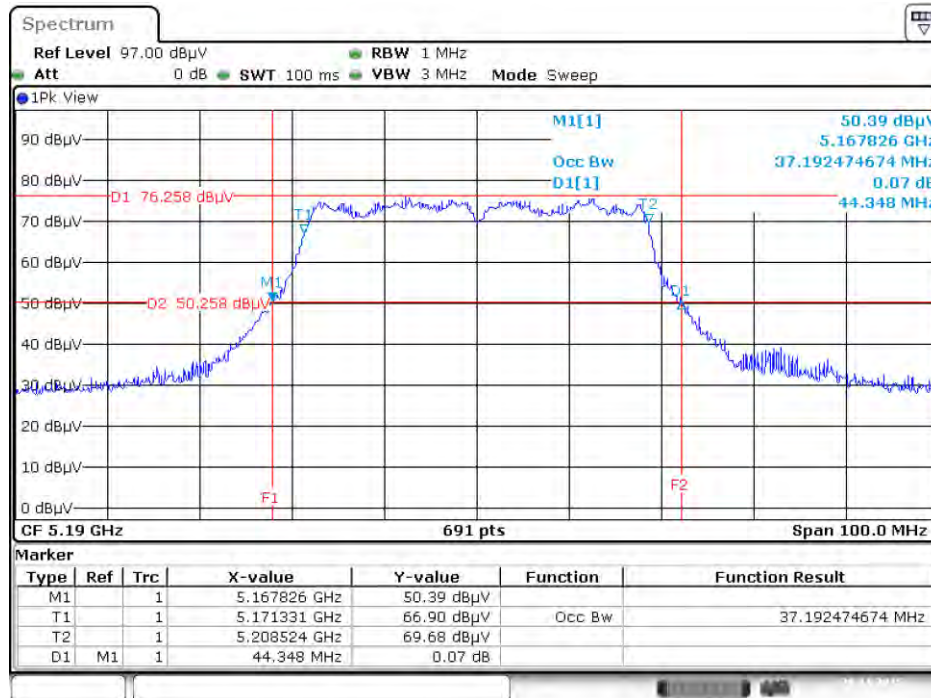

Date: 28 NOV. 2015 01:35:27

26dB Bandwidth and 99% Occupied Bandwidth Plot on Configuration IEEE 802.11ac MCS0/Nss1 VHT40 / Chain 1 + Chain 2 + Chain 3 + Chain 4 / 5230 MHz

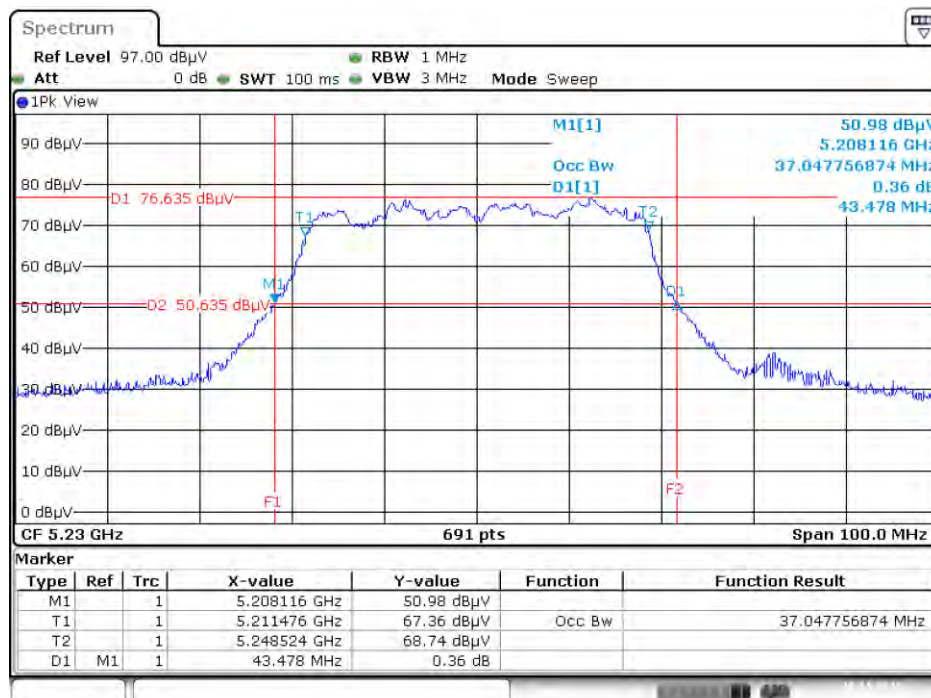

Date: 28 NOV. 2015 01:35:58

26dB Bandwidth and 99% Occupied Bandwidth Plot on Configuration IEEE 802.11ac MCS0/Nss1 VHT40 / Chain 1 + Chain 2 + Chain 3 + Chain 4 / 5755 MHz

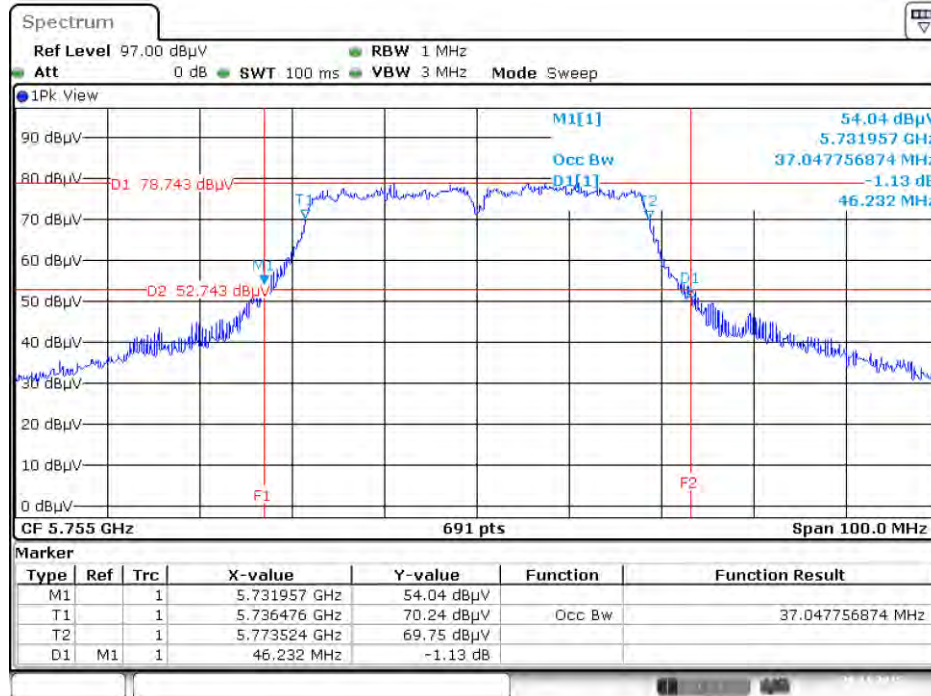

Date: 28.NOV.2015 01:50:05

26dB Bandwidth and 99% Occupied Bandwidth Plot on Configuration IEEE 802.11ac MCS0/Nss1 VHT40 / Chain 1 + Chain 2 + Chain 3 + Chain 4 / 5795 MHz

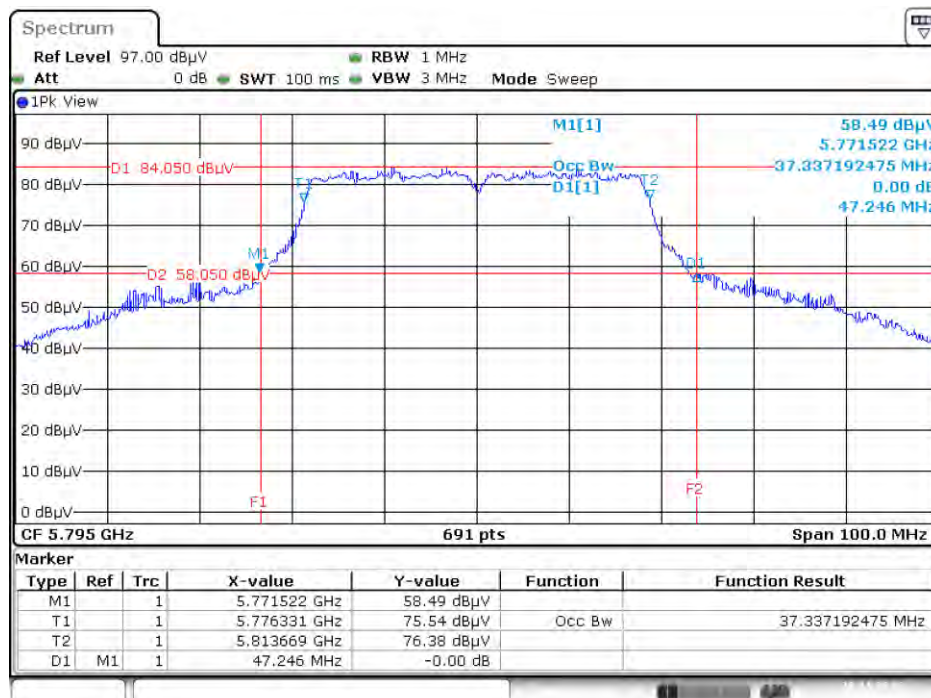

Date: 28.NOV.2015 01:50:33

26dB Bandwidth and 99% Occupied Bandwidth Plot on Configuration IEEE 802.11ac MCS0/Nss1 VHT80 / Chain 1 + Chain 2 + Chain 3 + Chain 4 / 5210 MHz

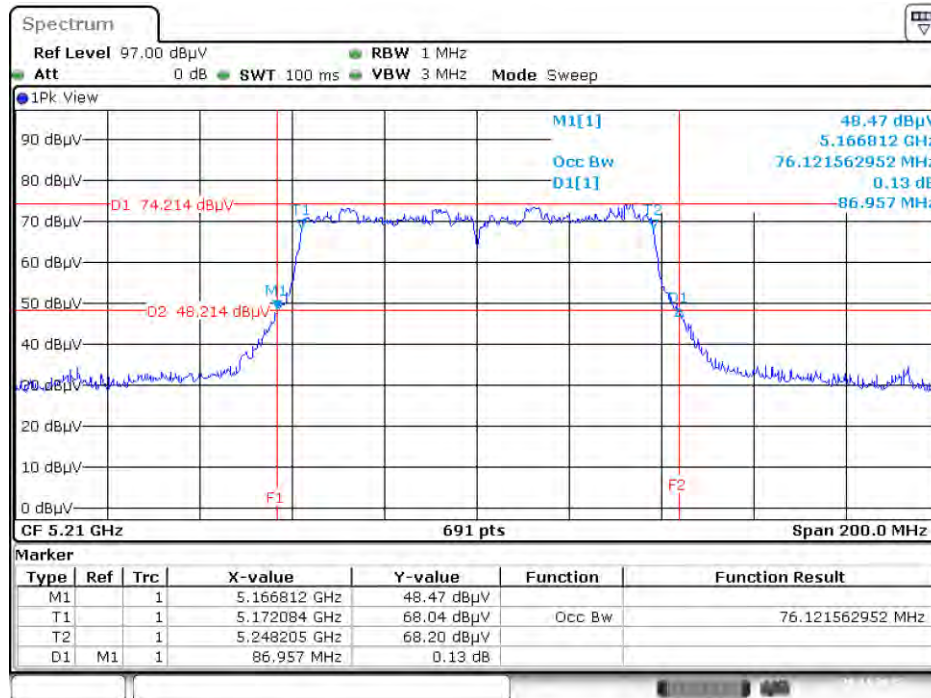

Date: 28 NOV. 2015 01:51:10

26dB Bandwidth and 99% Occupied Bandwidth Plot on Configuration IEEE 802.11ac MCS0/Nss1 VHT80 / Chain 1 + Chain 2 + Chain 3 + Chain 4 / 5775 MHz

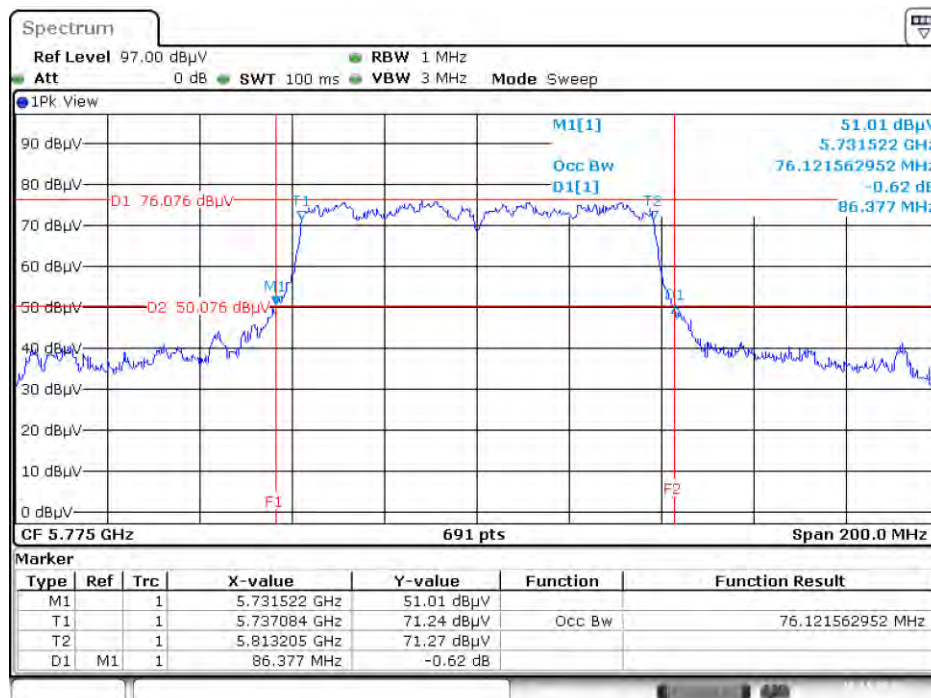

Date: 28 NOV. 2015 01:52:51

Mode 2: EUT 1 + Set 2 Sector Antenna / 6.5 dBi

26dB Bandwidth and 99% Occupied Bandwidth Plot on Configuration IEEE 802.11ac MCS0/Nss1 VHT20 / Chain 1 + Chain 2 + Chain 3 + Chain 4 / 5180 MHz

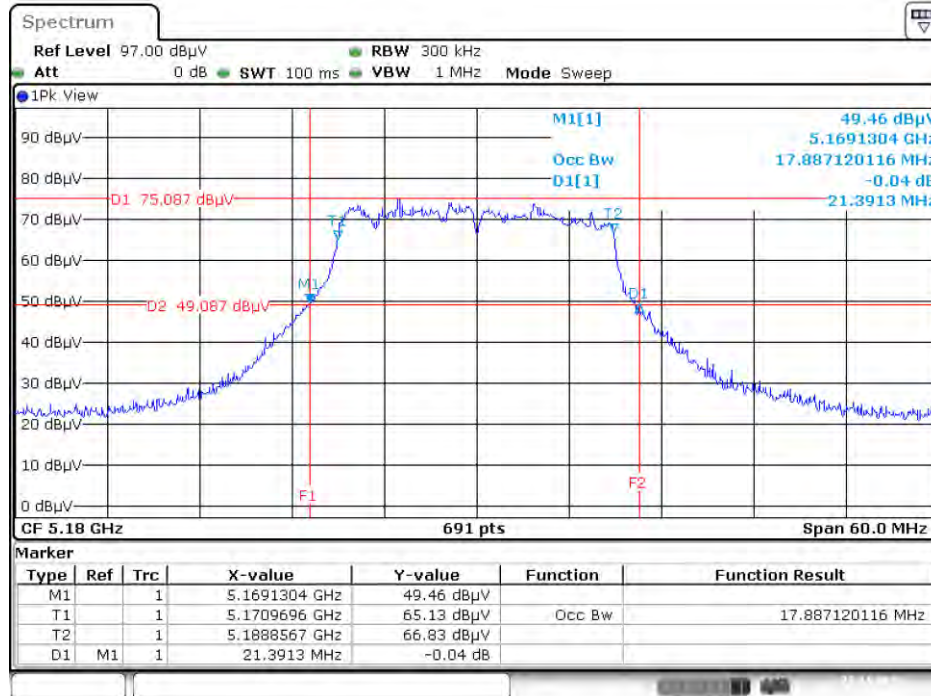

Date: 27. NOV. 2015 22:16:51

26dB Bandwidth and 99% Occupied Bandwidth Plot on Configuration IEEE 802.11ac MCS0/Nss1 VHT20 / Chain 1 + Chain 2 + Chain 3 + Chain 4 / 5200 MHz

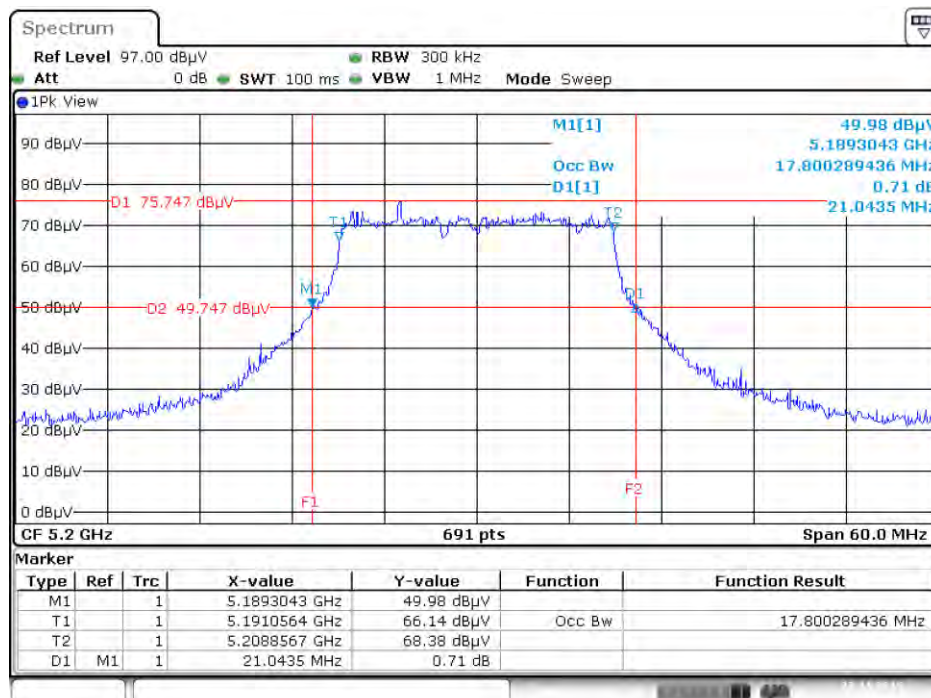

Date: 27. NOV. 2015 22:41:29

26dB Bandwidth and 99% Occupied Bandwidth Plot on Configuration IEEE 802.11ac MCS0/Nss1 VHT20 / Chain 1 + Chain 2 + Chain 3 + Chain 4 / 5240 MHz

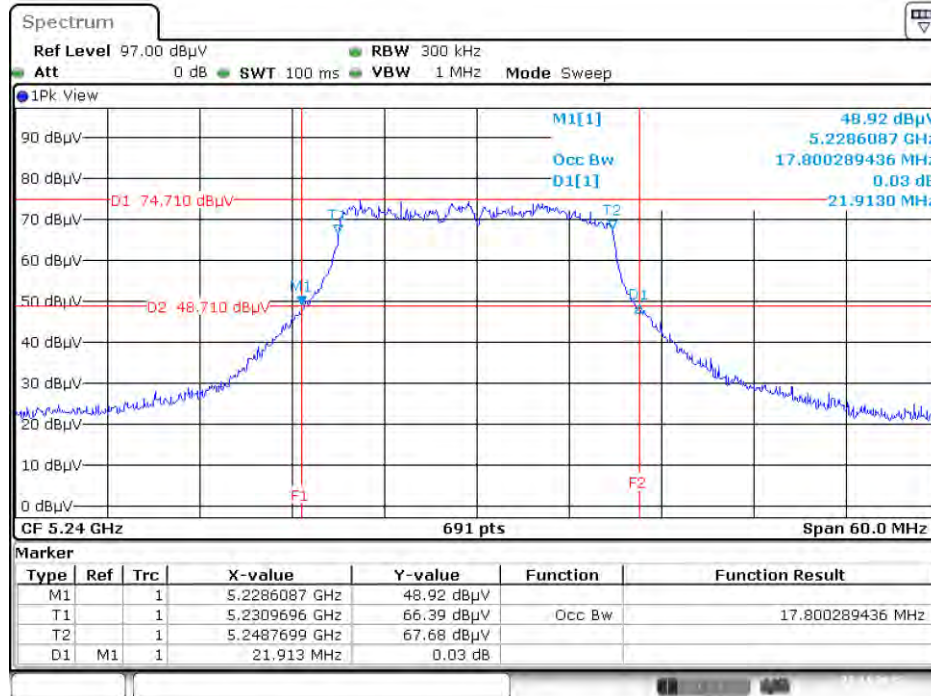

Date: 27. NOV. 2015 22:41:52

26dB Bandwidth and 99% Occupied Bandwidth Plot on Configuration IEEE 802.11ac MCS0/Nss1 VHT20 / Chain 1 + Chain 2 + Chain 3 + Chain 4 / 5745 MHz

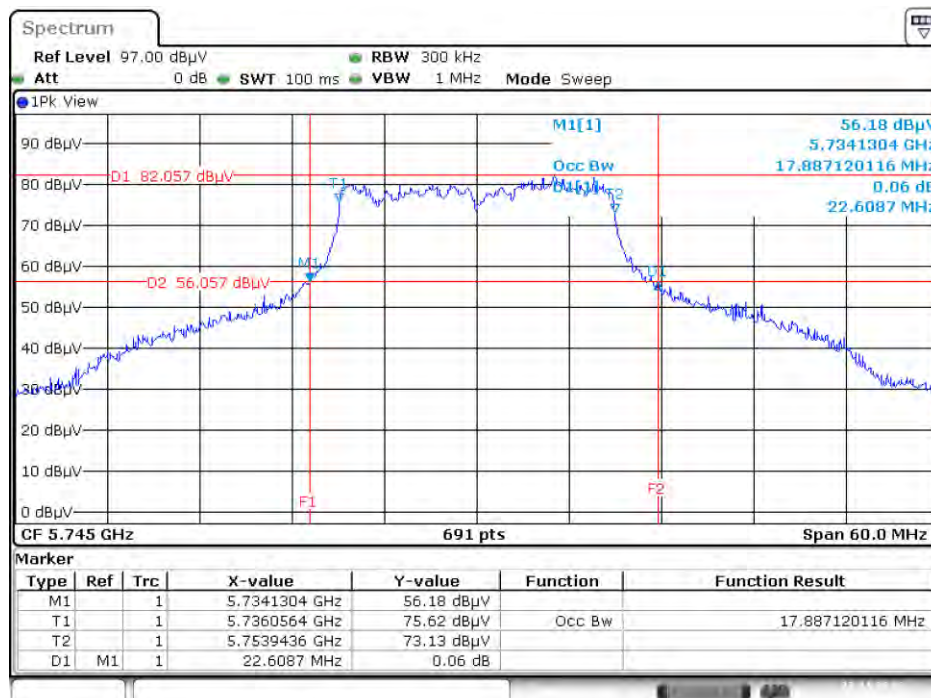

Date: 27. NOV. 2015 23:16:49

26dB Bandwidth and 99% Occupied Bandwidth Plot on Configuration IEEE 802.11ac MCS0/Nss1 VHT20 / Chain 1 + Chain 2 + Chain 3 + Chain 4 / 5785 MHz

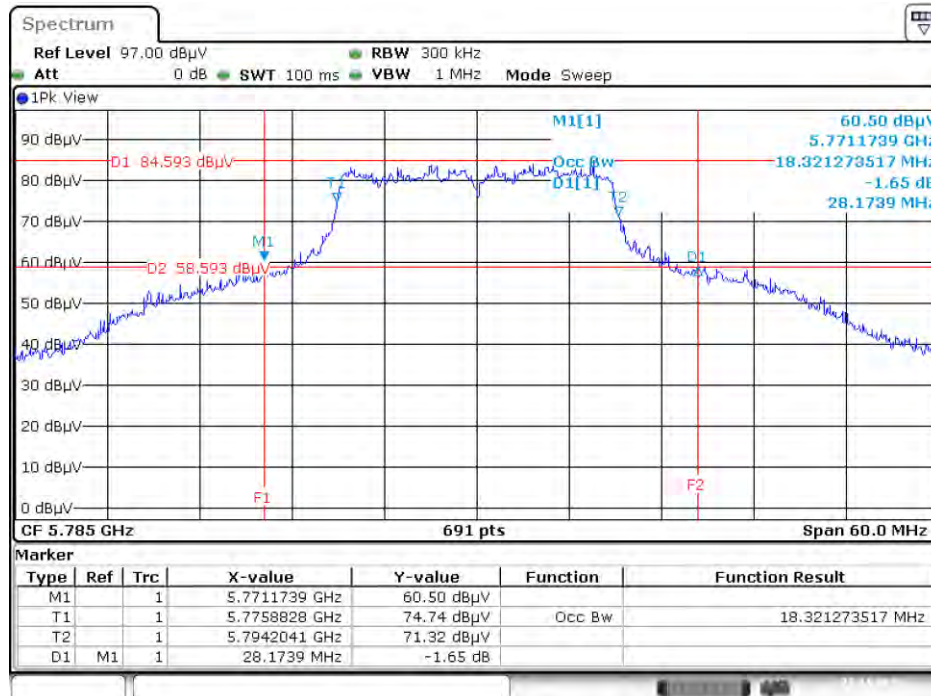

Date: 27. NOV. 2015 23:17:13

26dB Bandwidth and 99% Occupied Bandwidth Plot on Configuration IEEE 802.11ac MCS0/Nss1 VHT20 / Chain 1 + Chain 2 + Chain 3 + Chain 4 / 5825 MHz

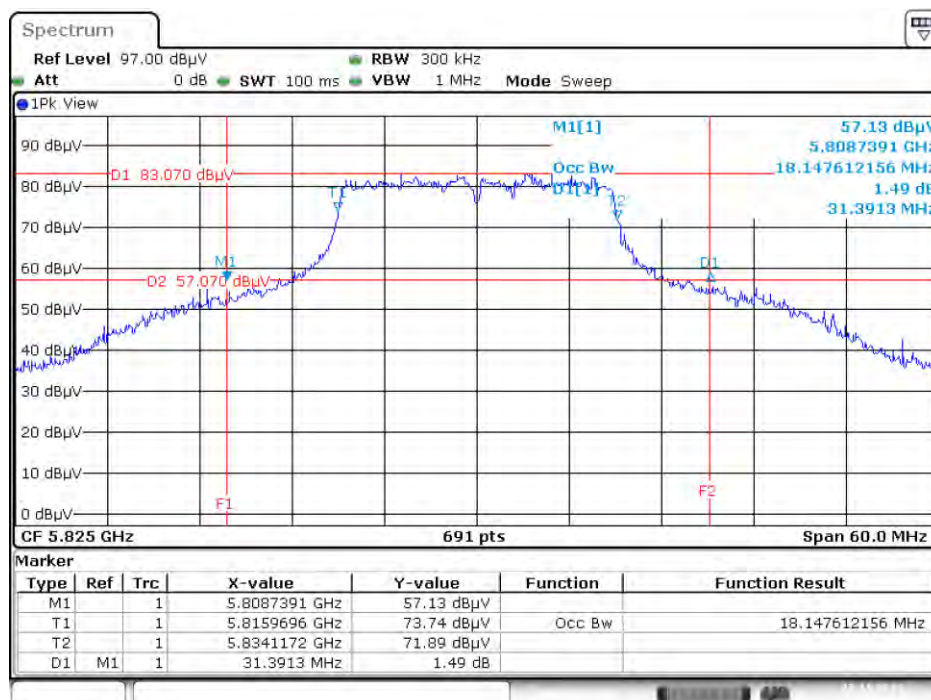

Date: 27. NOV. 2015 23:17:40

26dB Bandwidth and 99% Occupied Bandwidth Plot on Configuration IEEE 802.11ac MCS0/Nss1 VHT40 / Chain 1 + Chain 2 + Chain 3 + Chain 4 / 5190 MHz

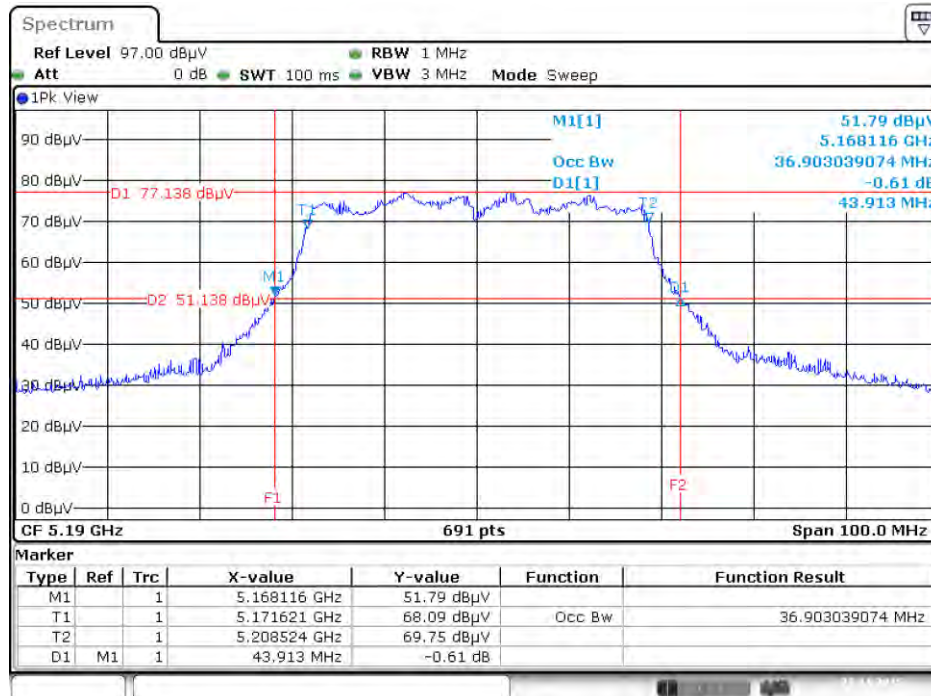

Date: 27. NOV. 2015 23:18:57

26dB Bandwidth and 99% Occupied Bandwidth Plot on Configuration IEEE 802.11ac MCS0/Nss1 VHT40 / Chain 1 + Chain 2 + Chain 3 + Chain 4 / 5230 MHz

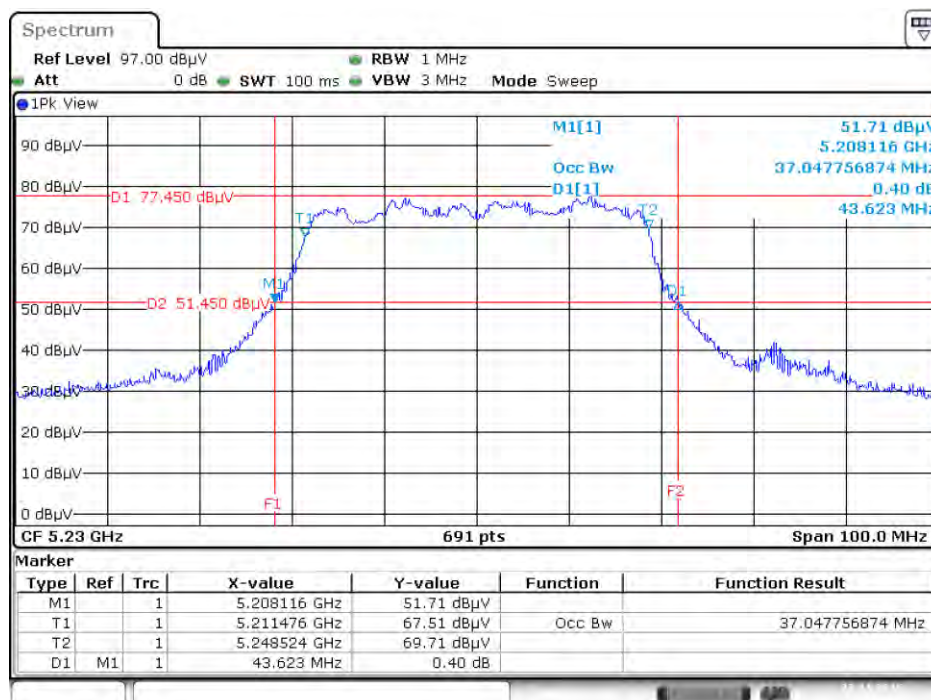

Date: 27. NOV. 2015 23:19:21

26dB Bandwidth and 99% Occupied Bandwidth Plot on Configuration IEEE 802.11ac MCS0/Nss1 VHT40 / Chain 1 + Chain 2 + Chain 3 + Chain 4 / 5755 MHz

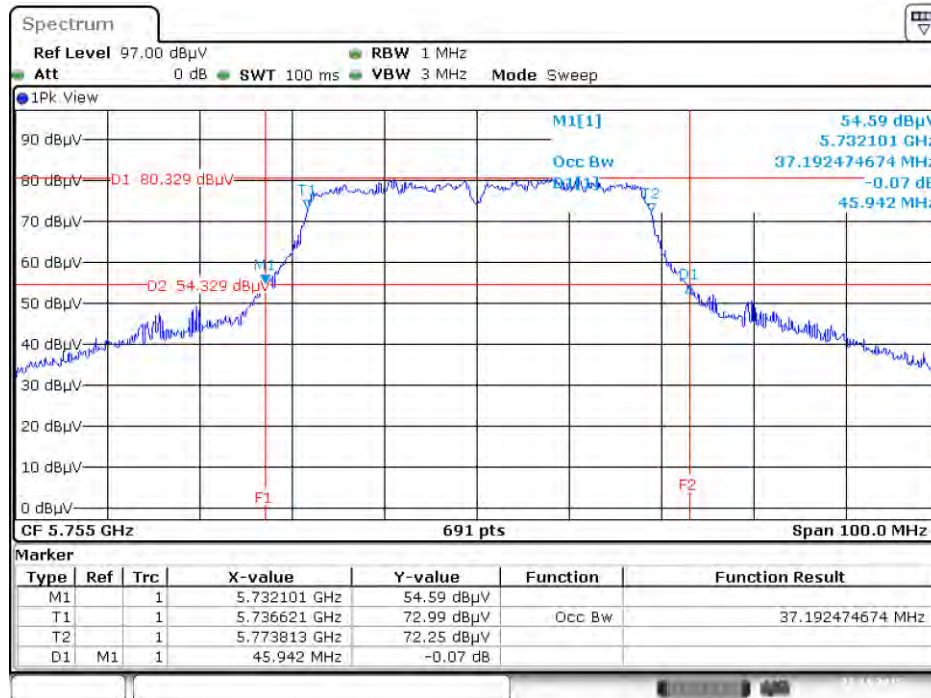

Date: 27. NOV. 2015 23:22:50

26dB Bandwidth and 99% Occupied Bandwidth Plot on Configuration IEEE 802.11ac MCS0/Nss1 VHT40 / Chain 1 + Chain 2 + Chain 3 + Chain 4 / 5795 MHz

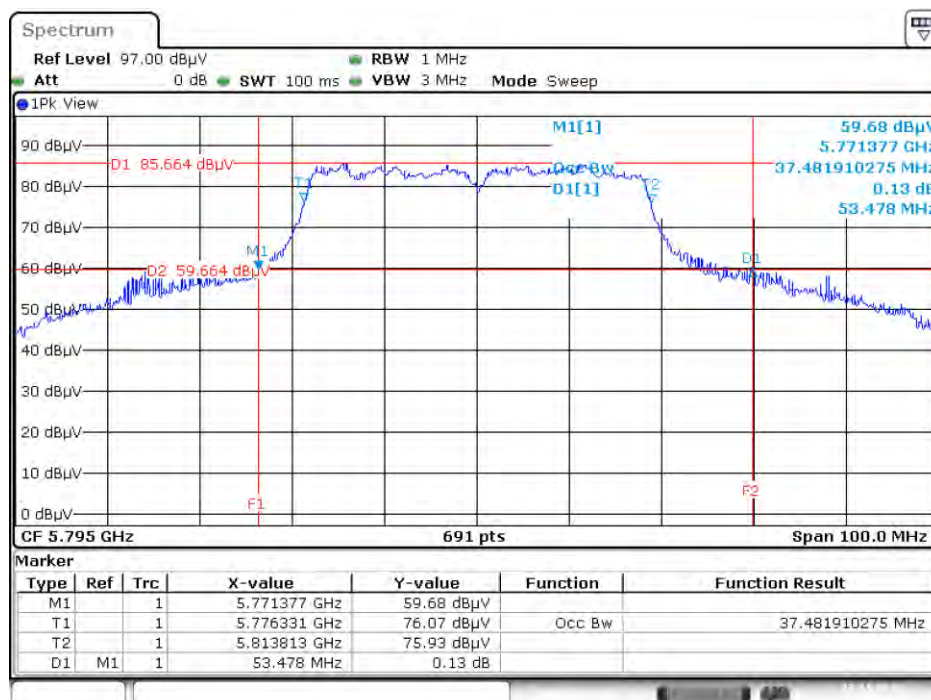

Date: 27. NOV. 2015 23:23:17

26dB Bandwidth and 99% Occupied Bandwidth Plot on Configuration IEEE 802.11ac MCS0/Nss1 VHT80 / Chain 1 + Chain 2 + Chain 3 + Chain 4 / 5210 MHz

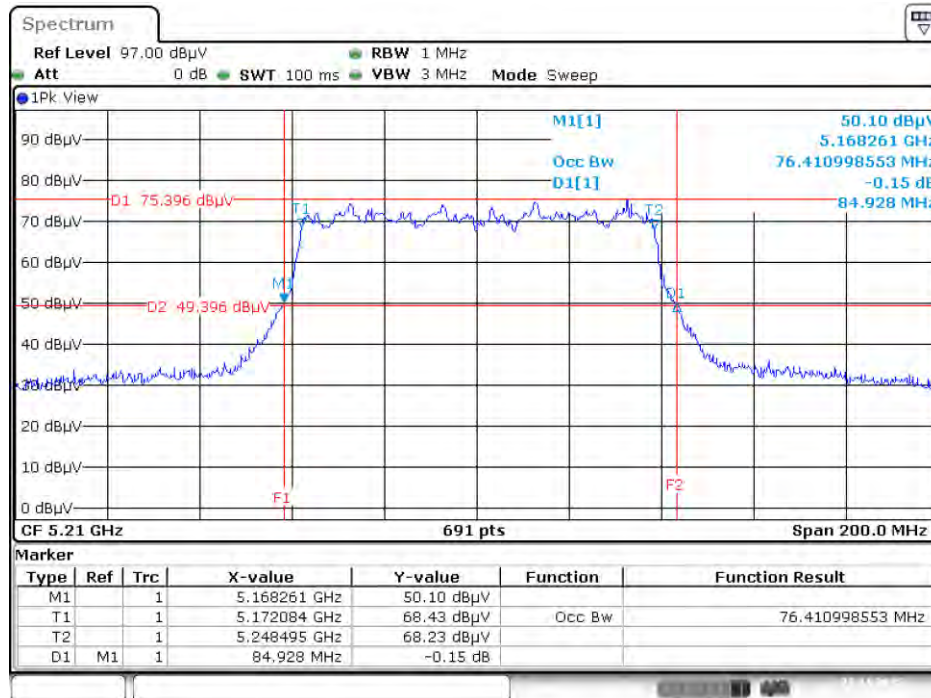

Date: 27. NOV. 2015 23:24:00

26dB Bandwidth and 99% Occupied Bandwidth Plot on Configuration IEEE 802.11ac MCS0/Nss1 VHT80 / Chain 1 + Chain 2 + Chain 3 + Chain 4 / 5775 MHz

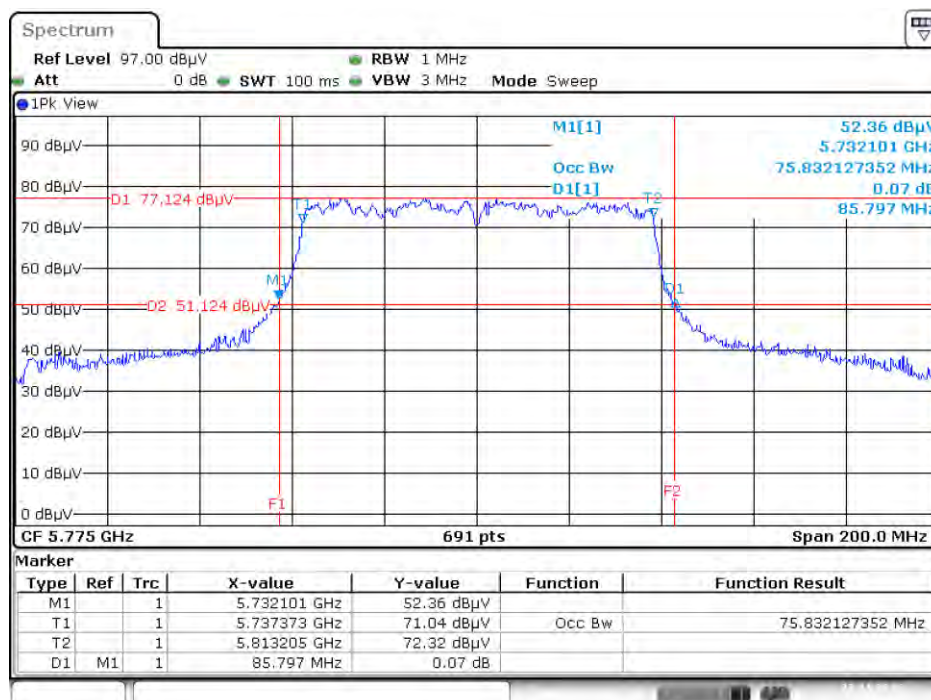

Date: 27. NOV. 2015 23:25:57

Mode 3: EUT 1 + Set 3 Sector Antenna / 5.5 dBi

26dB Bandwidth and 99% Occupied Bandwidth Plot on Configuration IEEE 802.11ac MCS0/Nss1 VHT20 / Chain 1 + Chain 2 + Chain 3 + Chain 4 / 5180 MHz

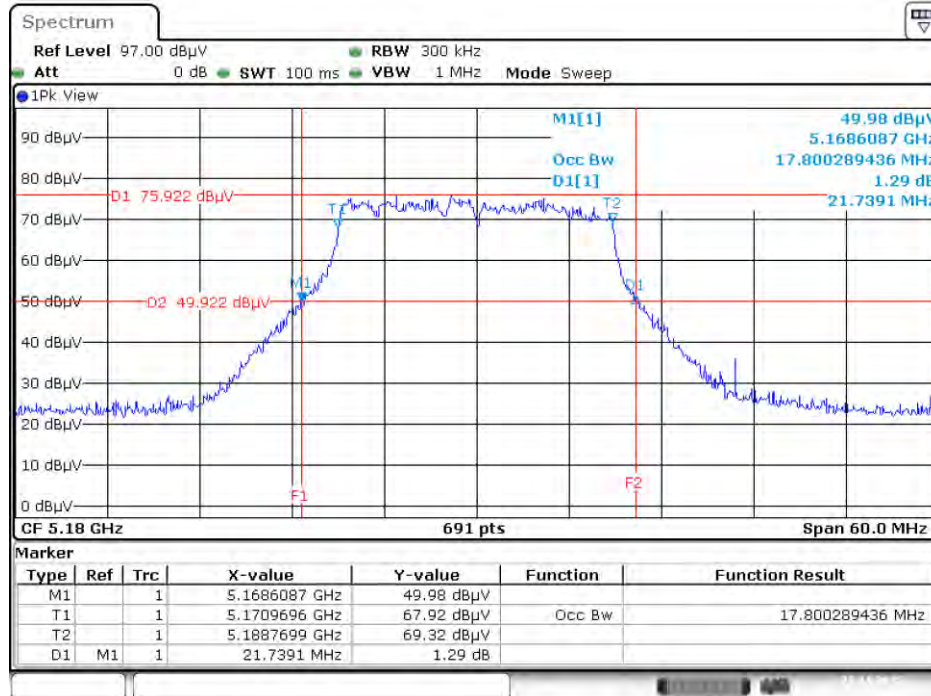

Date: 27.NOV.2015 21:15:22

26dB Bandwidth and 99% Occupied Bandwidth Plot on Configuration IEEE 802.11ac MCS0/Nss1 VHT20 / Chain 1 + Chain 2 + Chain 3 + Chain 4 / 5200 MHz

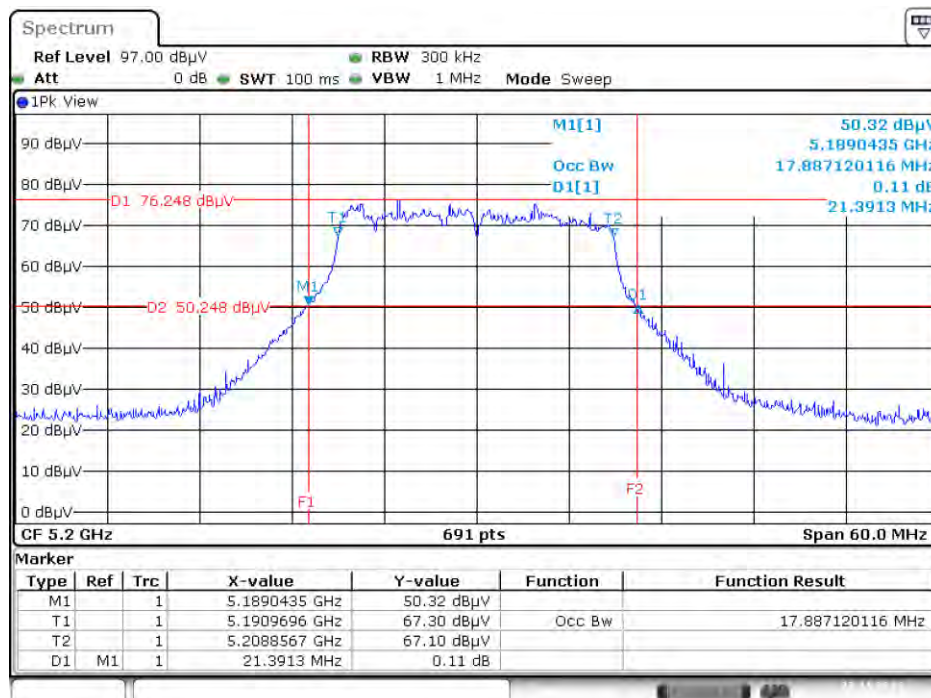

Date: 27.NOV.2015 21:16:08

26dB Bandwidth and 99% Occupied Bandwidth Plot on Configuration IEEE 802.11ac MCS0/Nss1 VHT20 / Chain 1 + Chain 2 + Chain 3 + Chain 4 / 5240 MHz

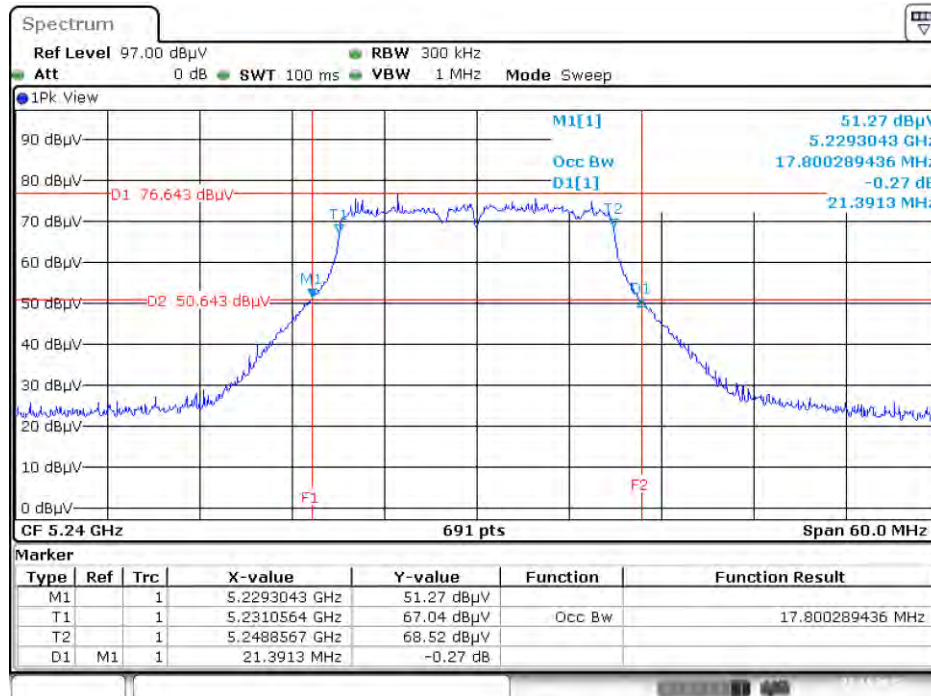

Date: 27.NOV.2015 21:16:44

26dB Bandwidth and 99% Occupied Bandwidth Plot on Configuration IEEE 802.11ac MCS0/Nss1 VHT20 / Chain 1 + Chain 2 + Chain 3 + Chain 4 / 5745 MHz

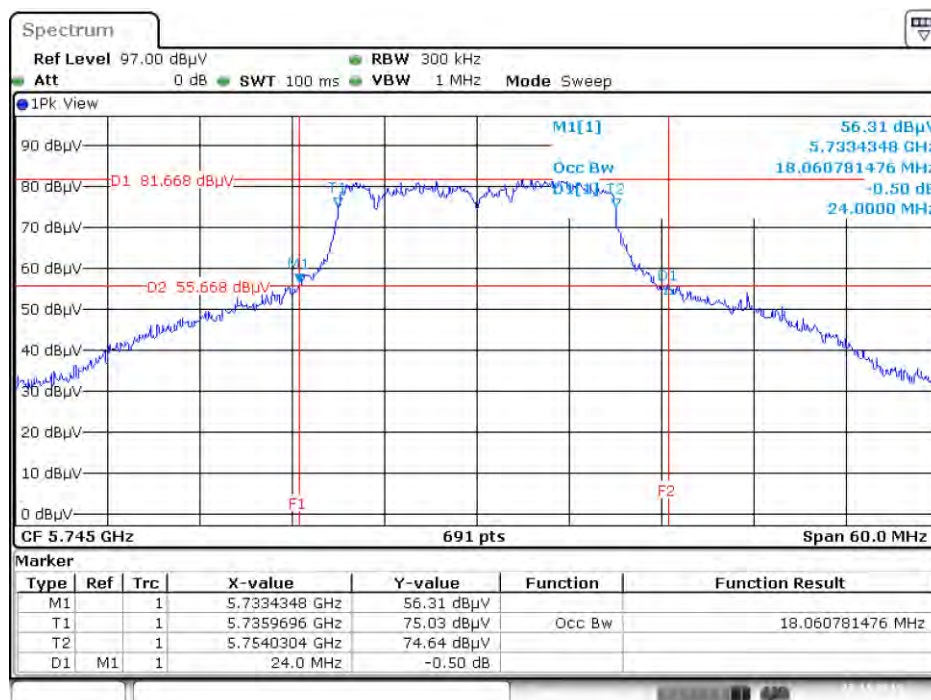

Date: 27.NOV.2015 21:21:57

26dB Bandwidth and 99% Occupied Bandwidth Plot on Configuration IEEE 802.11ac MCS0/Nss1 VHT20 / Chain 1 + Chain 2 + Chain 3 + Chain 4 / 5785 MHz

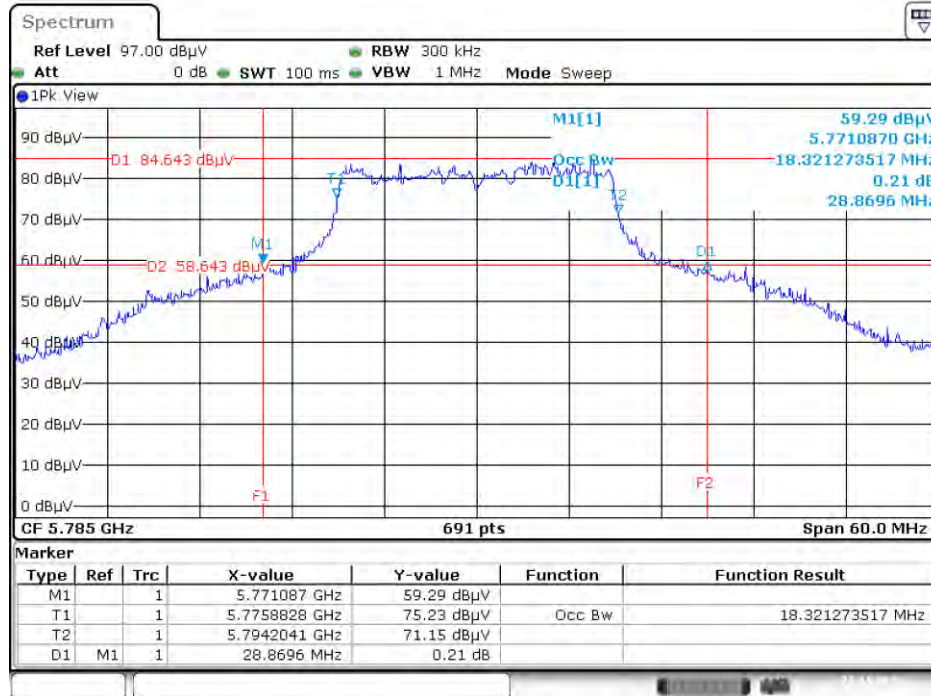

Date: 27.NOV.2015 21:22:40

26dB Bandwidth and 99% Occupied Bandwidth Plot on Configuration IEEE 802.11ac MCS0/Nss1 VHT20 / Chain 1 + Chain 2 + Chain 3 + Chain 4 / 5825 MHz

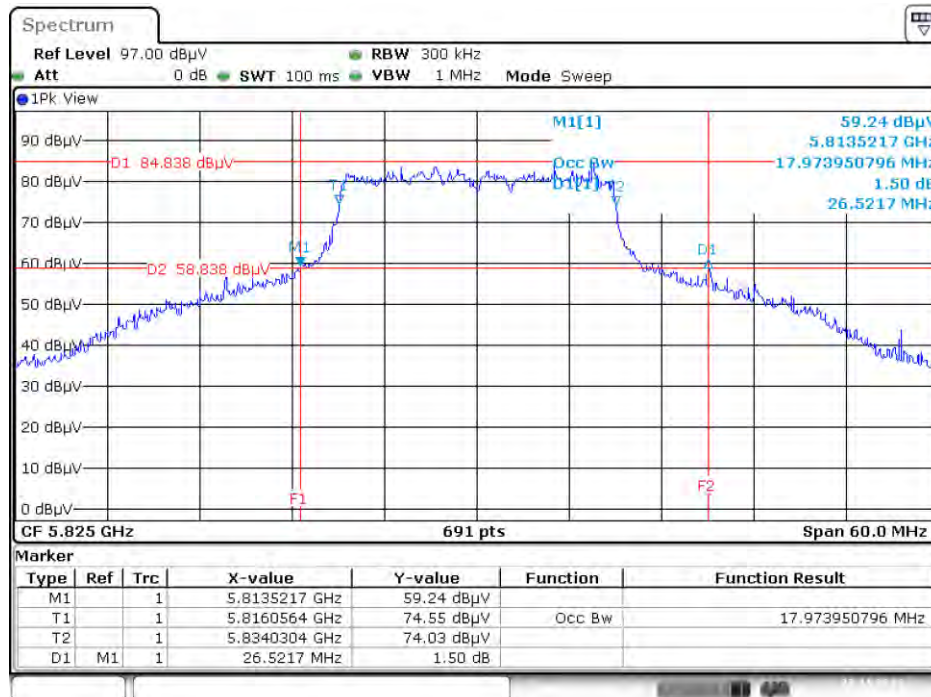

Date: 27.NOV.2015 21:23:17

26dB Bandwidth and 99% Occupied Bandwidth Plot on Configuration IEEE 802.11ac MCS0/Nss1 VHT40 / Chain 1 + Chain 2 + Chain 3 + Chain 4 / 5190 MHz

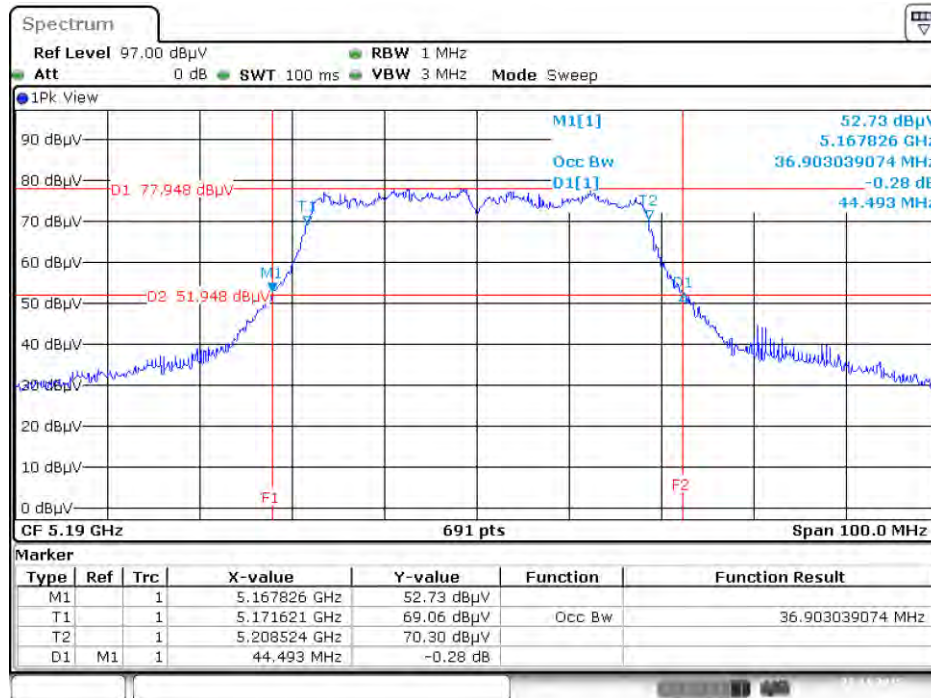

Date: 27. NOV. 2015 21:24:23

26dB Bandwidth and 99% Occupied Bandwidth Plot on Configuration IEEE 802.11ac MCS0/Nss1 VHT40 / Chain 1 + Chain 2 + Chain 3 + Chain 4 / 5230 MHz

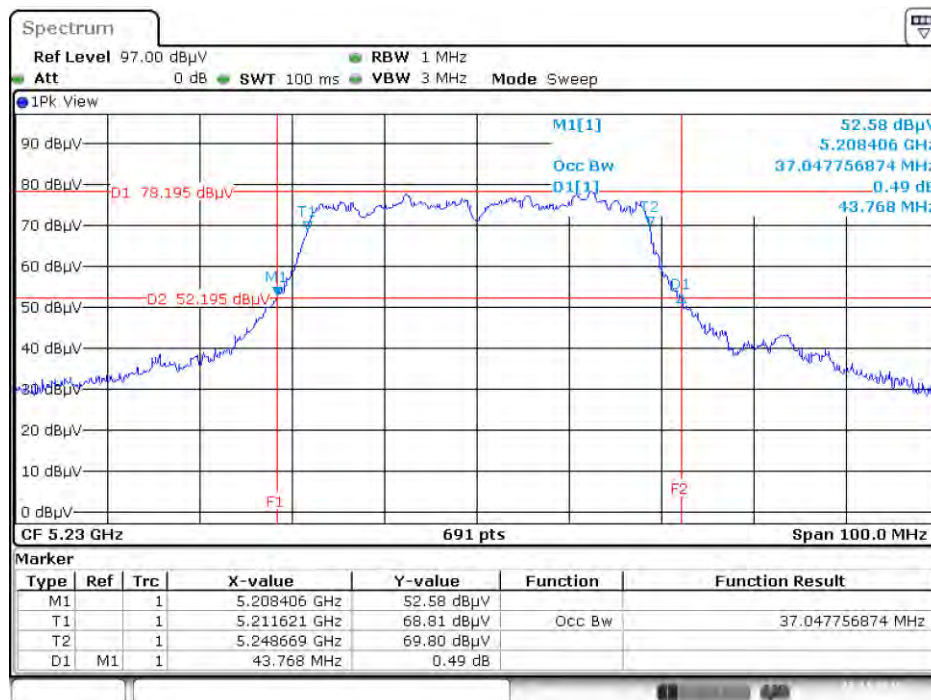

Date: 27. NOV. 2015 21:24:58

26dB Bandwidth and 99% Occupied Bandwidth Plot on Configuration IEEE 802.11ac MCS0/Nss1 VHT40 / Chain 1 + Chain 2 + Chain 3 + Chain 4 / 5755 MHz

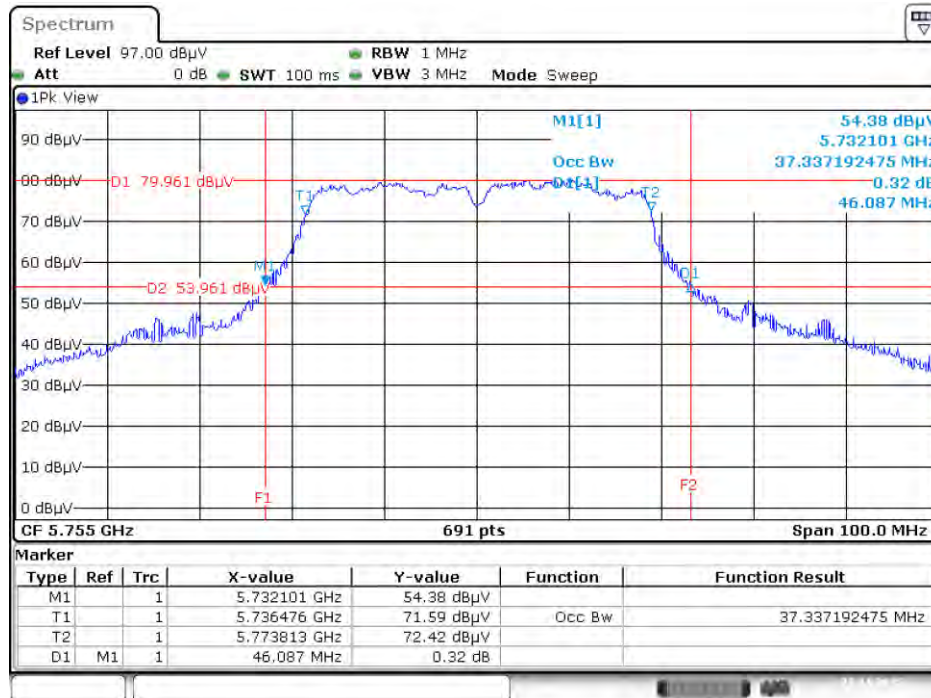

Date: 27.NOV.2015 21:30:15

26dB Bandwidth and 99% Occupied Bandwidth Plot on Configuration IEEE 802.11ac MCS0/Nss1 VHT40 / Chain 1 + Chain 2 + Chain 3 + Chain 4 / 5795 MHz

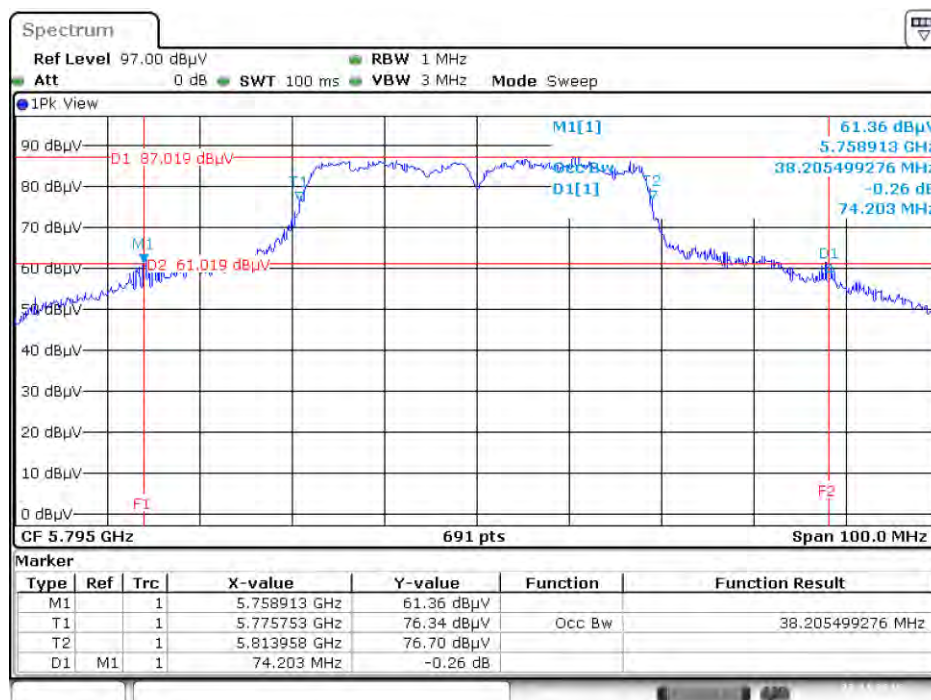

Date: 27.NOV.2015 21:31:51

26dB Bandwidth and 99% Occupied Bandwidth Plot on Configuration IEEE 802.11ac MCS0/Nss1 VHT80 / Chain 1 + Chain 2 + Chain 3 + Chain 4 / 5210 MHz

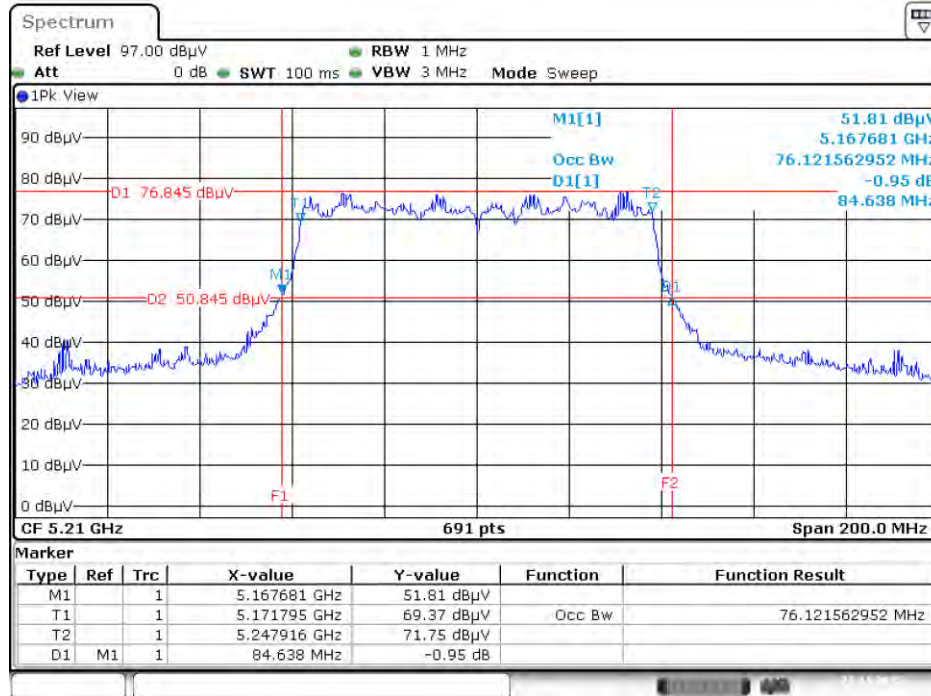

Date: 27.NOV.2015 21:33:26

26dB Bandwidth and 99% Occupied Bandwidth Plot on Configuration IEEE 802.11ac MCS0/Nss1 VHT80 / Chain 1 + Chain 2 + Chain 3 + Chain 4 / 5775 MHz

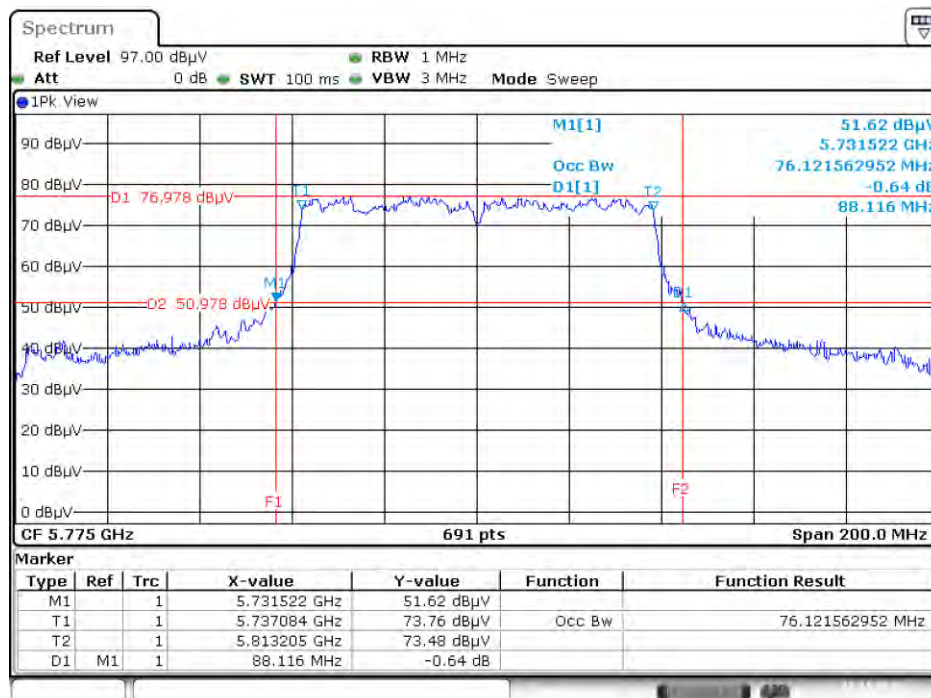

Date: 27.NOV.2015 21:36:17

Mode 4: EUT 1 + Set 4 Sector Antenna / 7.5 dBi

26dB Bandwidth and 99% Occupied Bandwidth Plot on Configuration IEEE 802.11ac MCS0/Nss1 VHT20 / Chain 1 + Chain 2 + Chain 3 + Chain 4 / 5180 MHz

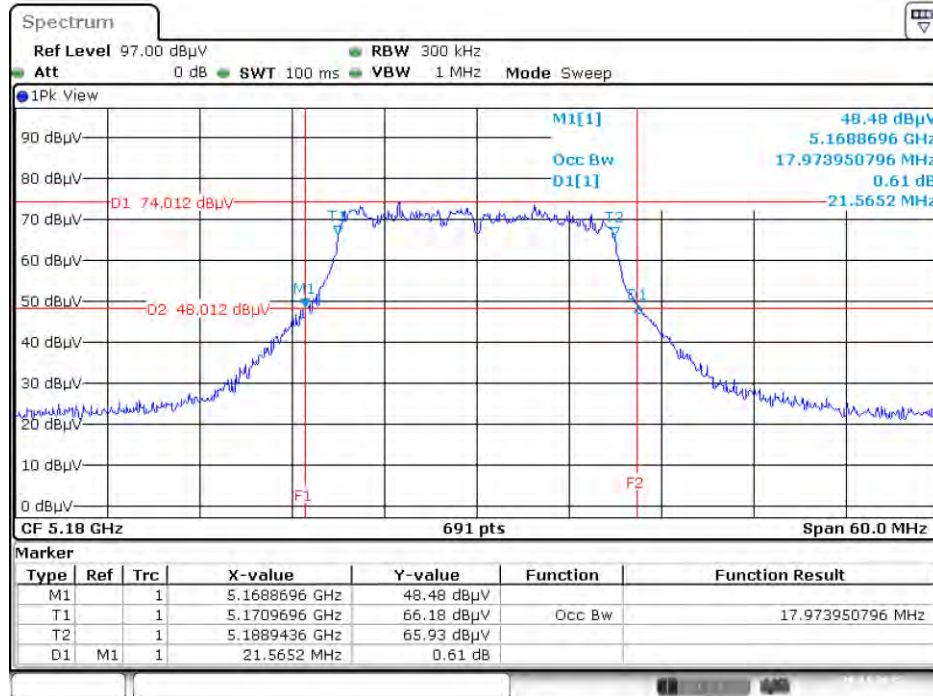

Date: 28 NOV. 2015 00:18:23

26dB Bandwidth and 99% Occupied Bandwidth Plot on Configuration IEEE 802.11ac MCS0/Nss1 VHT20 / Chain 1 + Chain 2 + Chain 3 + Chain 4 / 5200 MHz

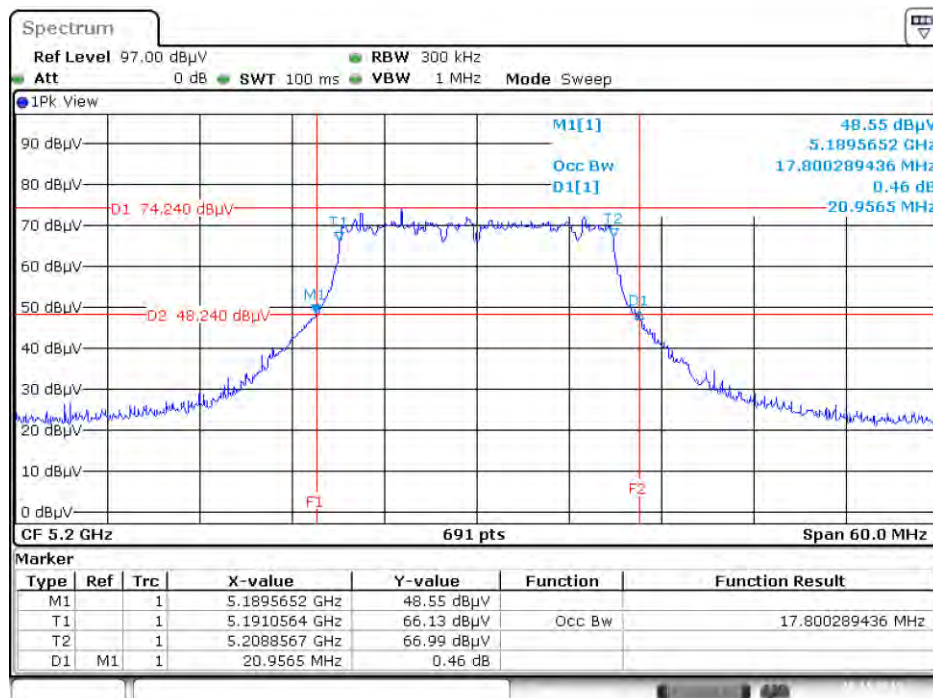

Date: 28 NOV. 2015 00:18:51

26dB Bandwidth and 99% Occupied Bandwidth Plot on Configuration IEEE 802.11ac MCS0/Nss1 VHT20 / Chain 1 + Chain 2 + Chain 3 + Chain 4 / 5240 MHz

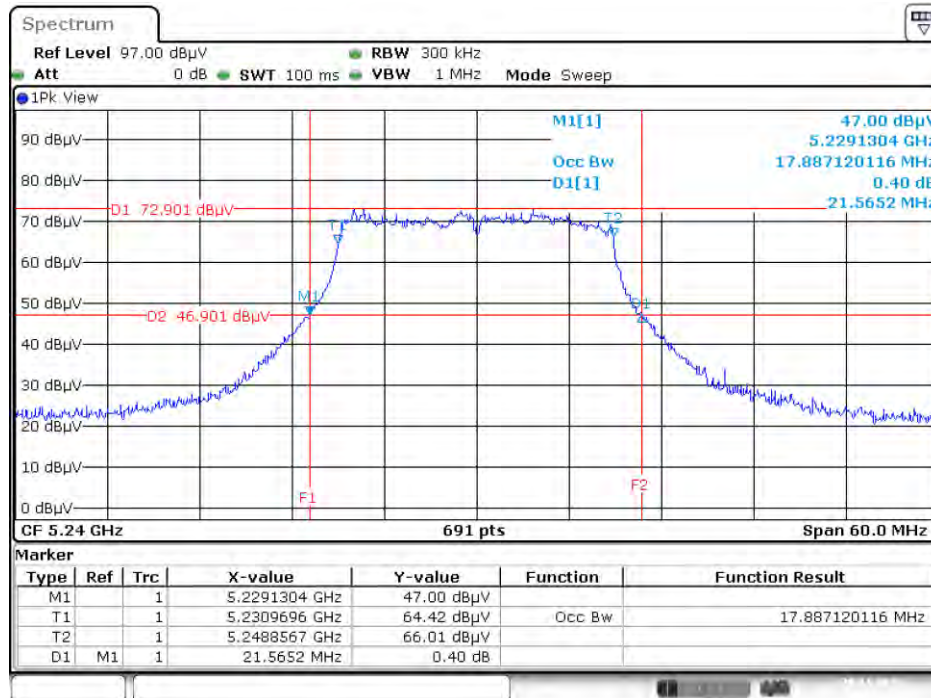

Date: 28 NOV. 2015 00:19:11

26dB Bandwidth and 99% Occupied Bandwidth Plot on Configuration IEEE 802.11ac MCS0/Nss1 VHT20 / Chain 1 + Chain 2 + Chain 3 + Chain 4 / 5745 MHz

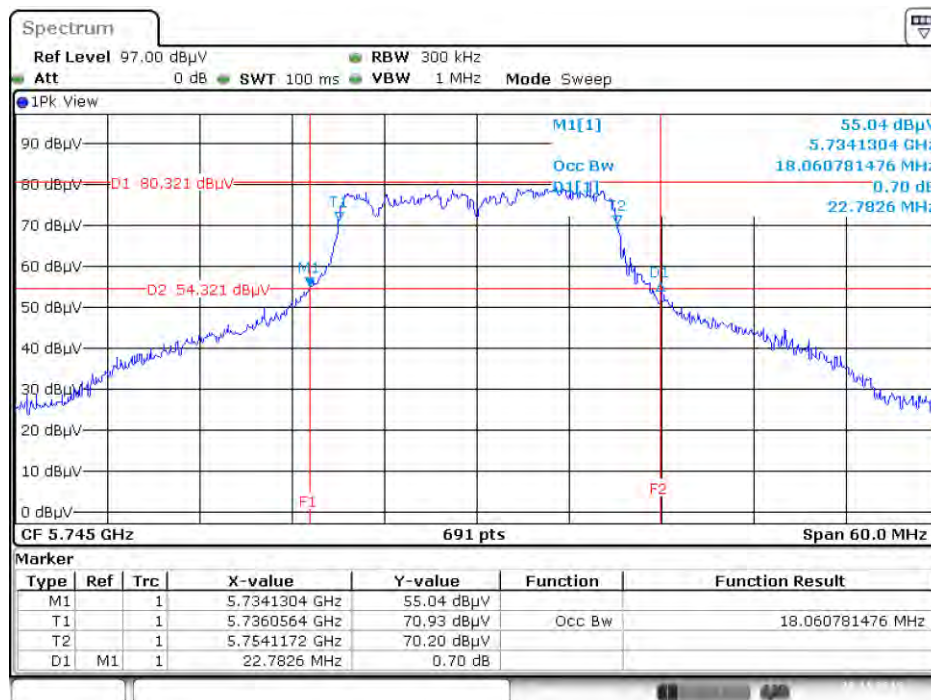

Date: 28 NOV. 2015 00:22:57

26dB Bandwidth and 99% Occupied Bandwidth Plot on Configuration IEEE 802.11ac MCS0/Nss1 VHT20 / Chain 1 + Chain 2 + Chain 3 + Chain 4 / 5785 MHz

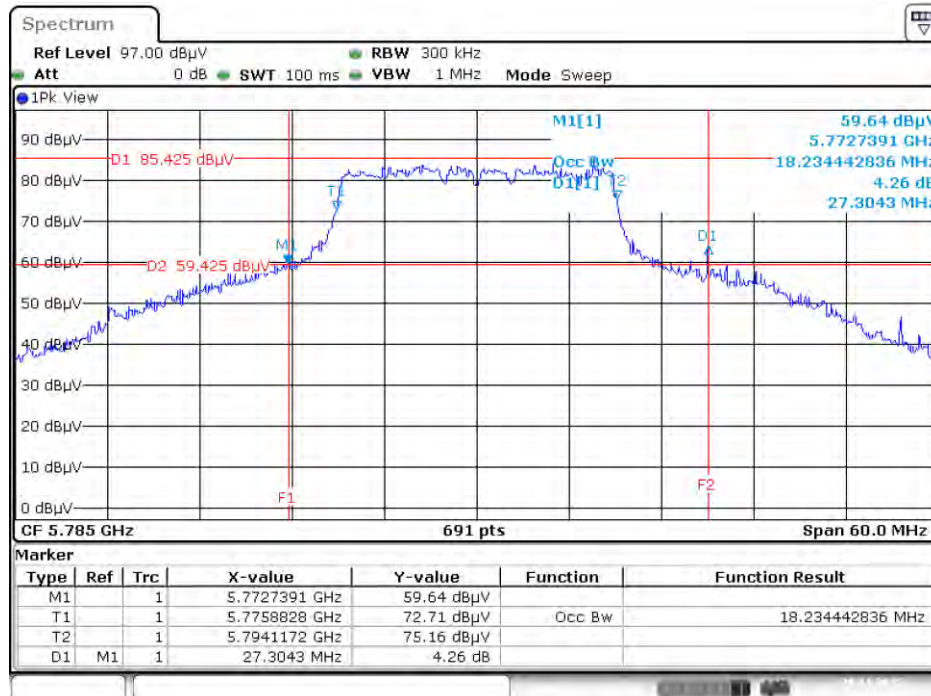

Date: 28.NOV.2015 00:23:25

26dB Bandwidth and 99% Occupied Bandwidth Plot on Configuration IEEE 802.11ac MCS0/Nss1 VHT20 / Chain 1 + Chain 2 + Chain 3 + Chain 4 / 5825 MHz

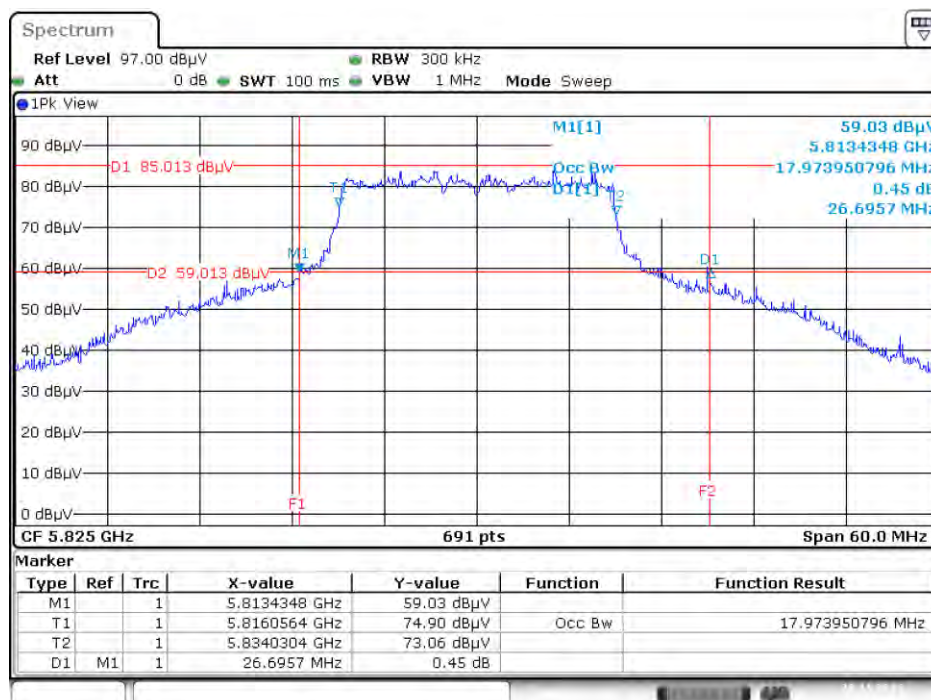

Date: 28.NOV.2015 00:23:51

26dB Bandwidth and 99% Occupied Bandwidth Plot on Configuration IEEE 802.11ac MCS0/Nss1 VHT40 / Chain 1 + Chain 2 + Chain 3 + Chain 4 / 5190 MHz

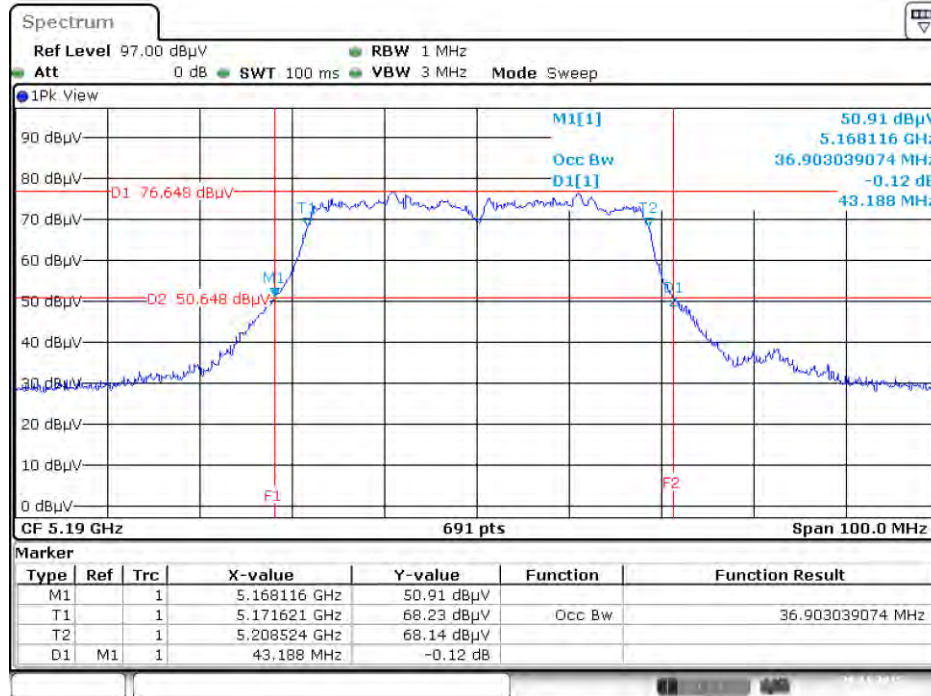

Date: 28 NOV. 2015 00:24:37

26dB Bandwidth and 99% Occupied Bandwidth Plot on Configuration IEEE 802.11ac MCS0/Nss1 VHT40 / Chain 1 + Chain 2 + Chain 3 + Chain 4 / 5230 MHz

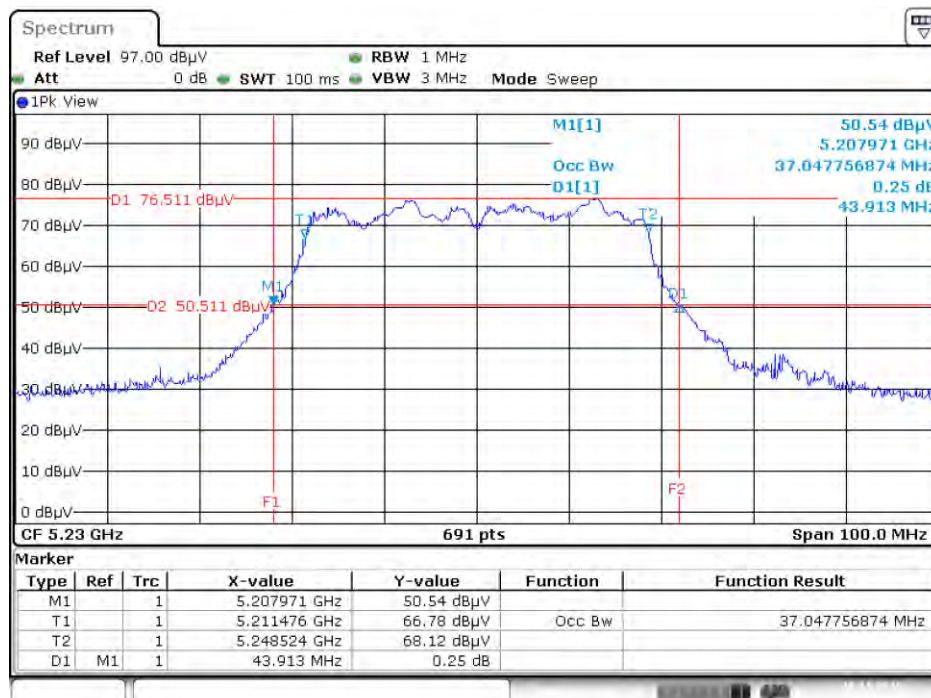

Date: 28 NOV. 2015 00:25:09

26dB Bandwidth and 99% Occupied Bandwidth Plot on Configuration IEEE 802.11ac MCS0/Nss1 VHT40 / Chain 1 + Chain 2 + Chain 3 + Chain 4 / 5755 MHz

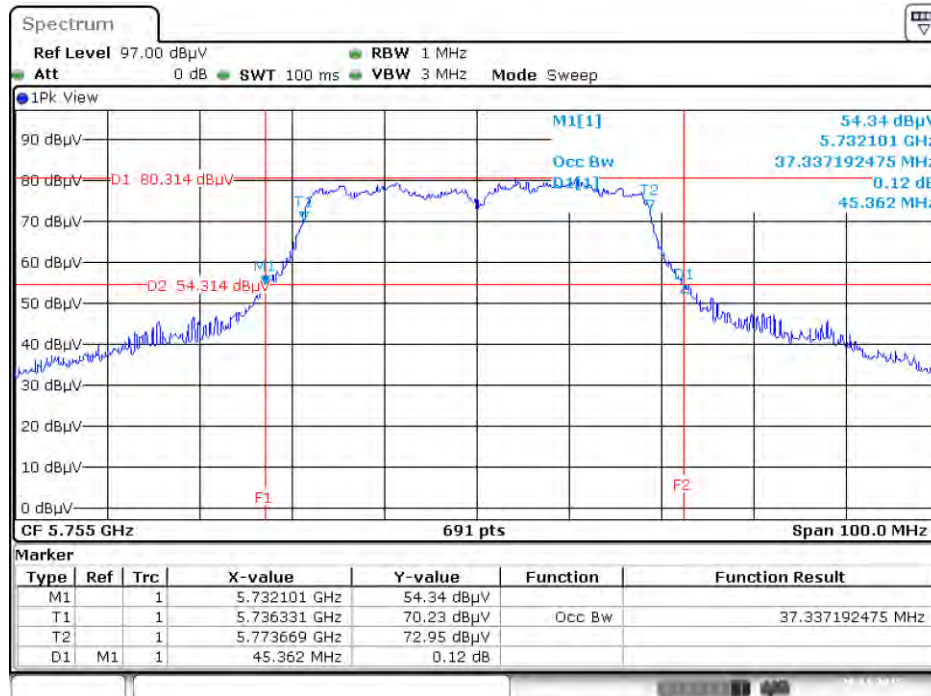

Date: 28 NOV. 2015 00:28:41

26dB Bandwidth and 99% Occupied Bandwidth Plot on Configuration IEEE 802.11ac MCS0/Nss1 VHT40 / Chain 1 + Chain 2 + Chain 3 + Chain 4 / 5795 MHz

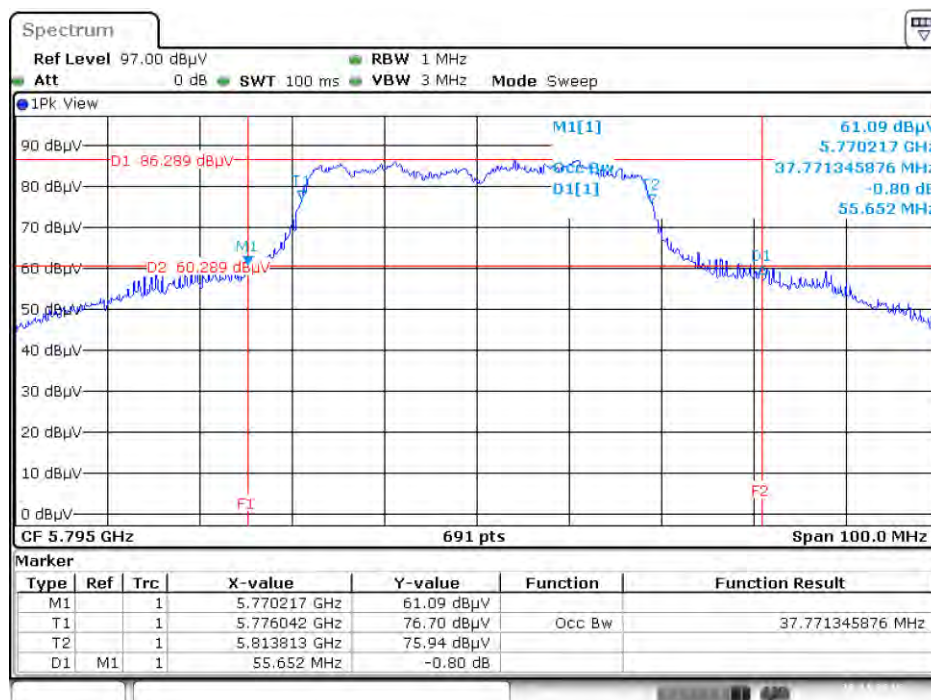

Date: 28 NOV. 2015 00:29:08

26dB Bandwidth and 99% Occupied Bandwidth Plot on Configuration IEEE 802.11ac MCS0/Nss1 VHT80 / Chain 1 + Chain 2 + Chain 3 + Chain 4 / 5210 MHz

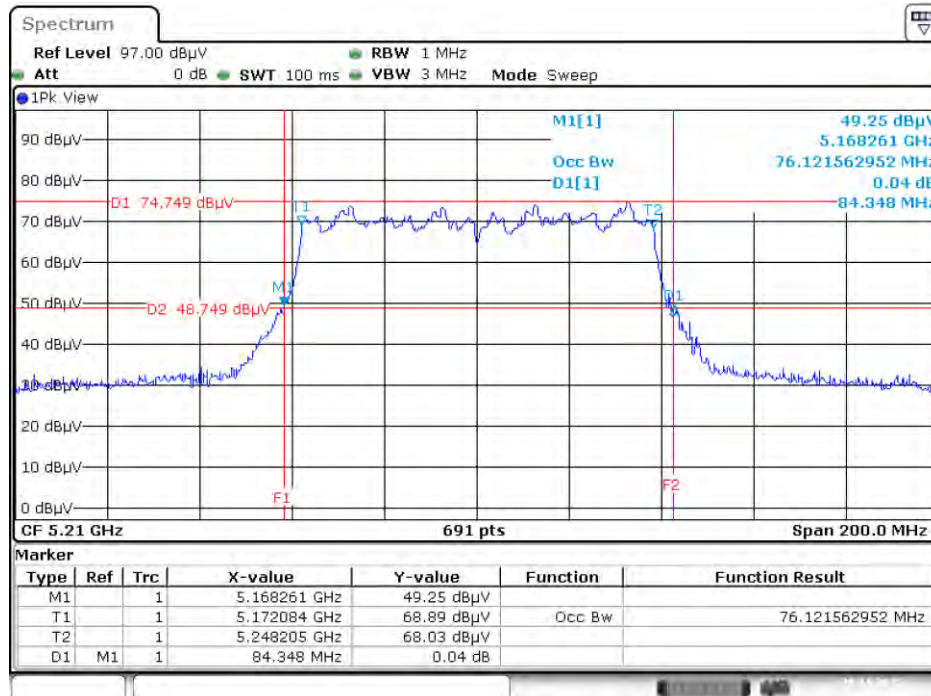

Date: 28 NOV. 2015 00:29:50

26dB Bandwidth and 99% Occupied Bandwidth Plot on Configuration IEEE 802.11ac MCS0/Nss1 VHT80 / Chain 1 + Chain 2 + Chain 3 + Chain 4 / 5775 MHz

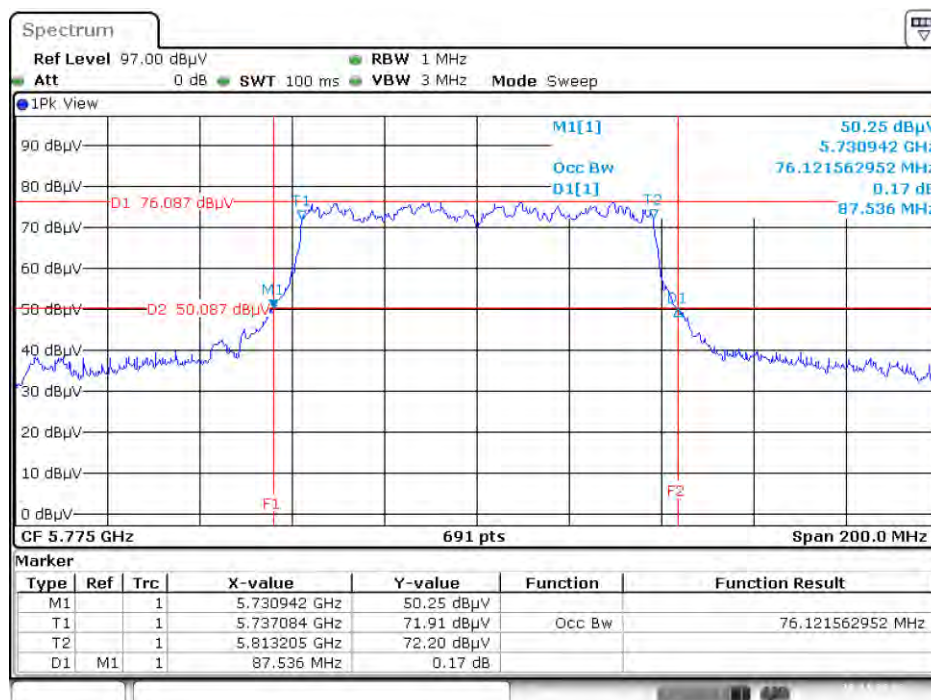

Date: 28 NOV. 2015 00:31:38

Mode 5: EUT 1 + Set 5 Sector Antenna / 4.5 dBi

26dB Bandwidth and 99% Occupied Bandwidth Plot on Configuration IEEE 802.11ac MCS0/Nss1 VHT20 / Chain 1 + Chain 2 + Chain 3 + Chain 4 / 5180 MHz

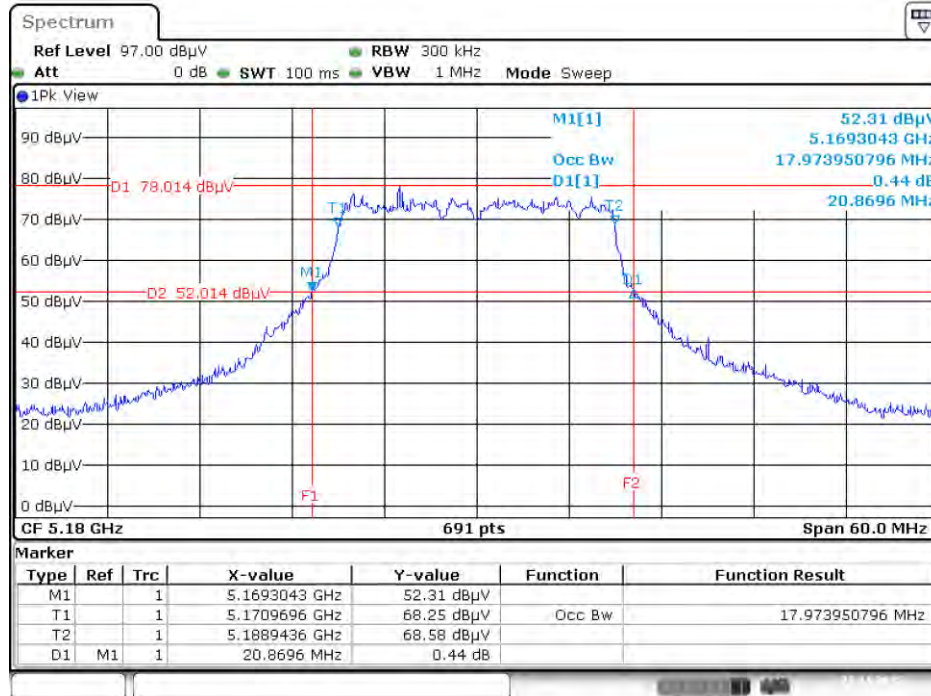

Date: 27.NOV.2015 23:30:14

26dB Bandwidth and 99% Occupied Bandwidth Plot on Configuration IEEE 802.11ac MCS0/Nss1 VHT20 / Chain 1 + Chain 2 + Chain 3 + Chain 4 / 5200 MHz

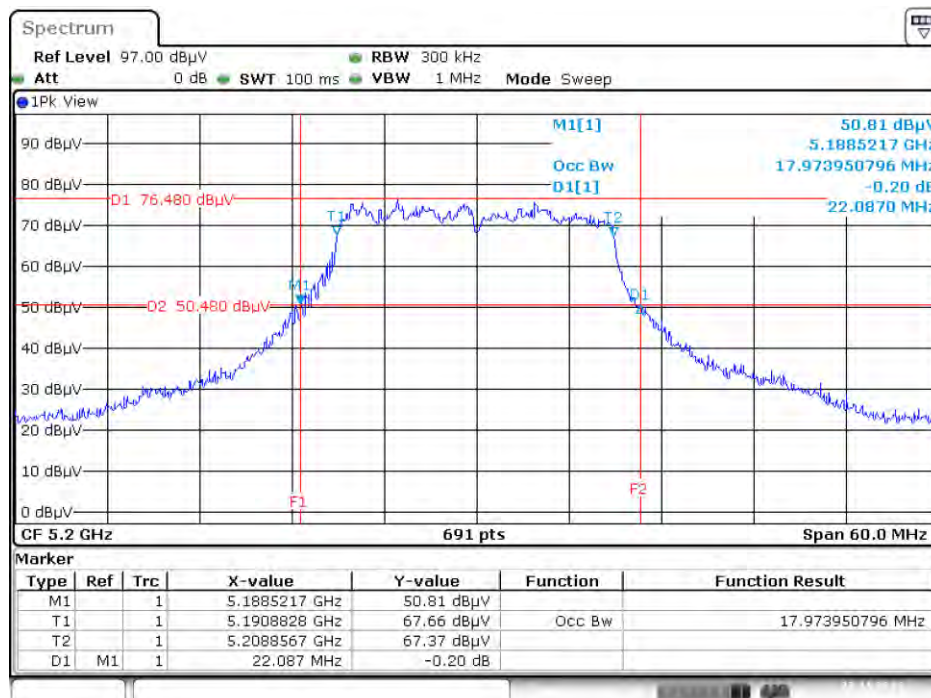

Date: 27.NOV.2015 23:30:38

26dB Bandwidth and 99% Occupied Bandwidth Plot on Configuration IEEE 802.11ac MCS0/Nss1 VHT20 / Chain 1 + Chain 2 + Chain 3 + Chain 4 / 5240 MHz

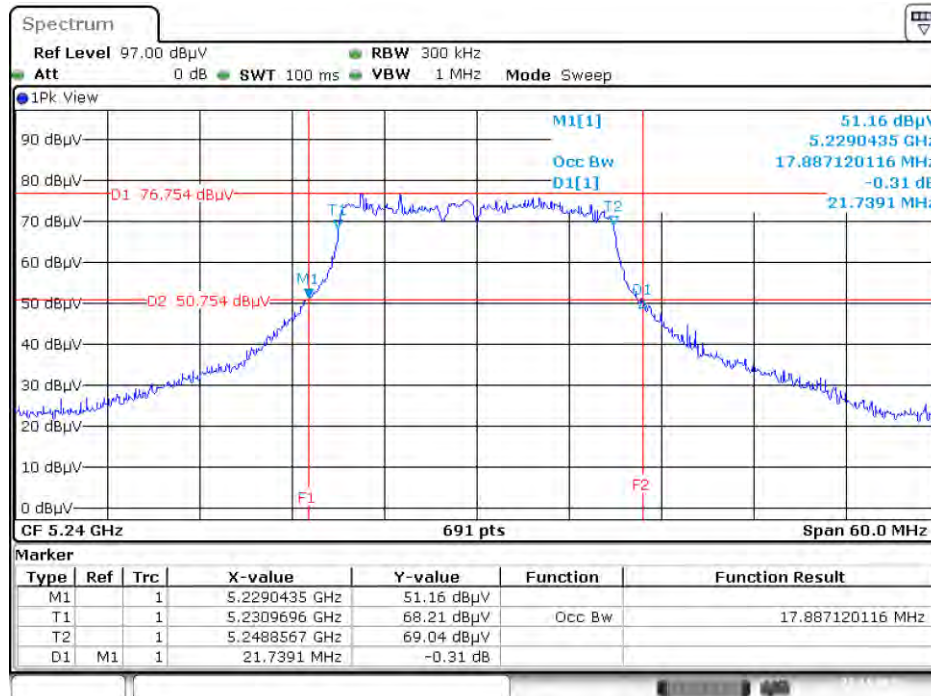

Date: 27. NOV. 2015 23:31:04

26dB Bandwidth and 99% Occupied Bandwidth Plot on Configuration IEEE 802.11ac MCS0/Nss1 VHT20 / Chain 1 + Chain 2 + Chain 3 + Chain 4 / 5745 MHz

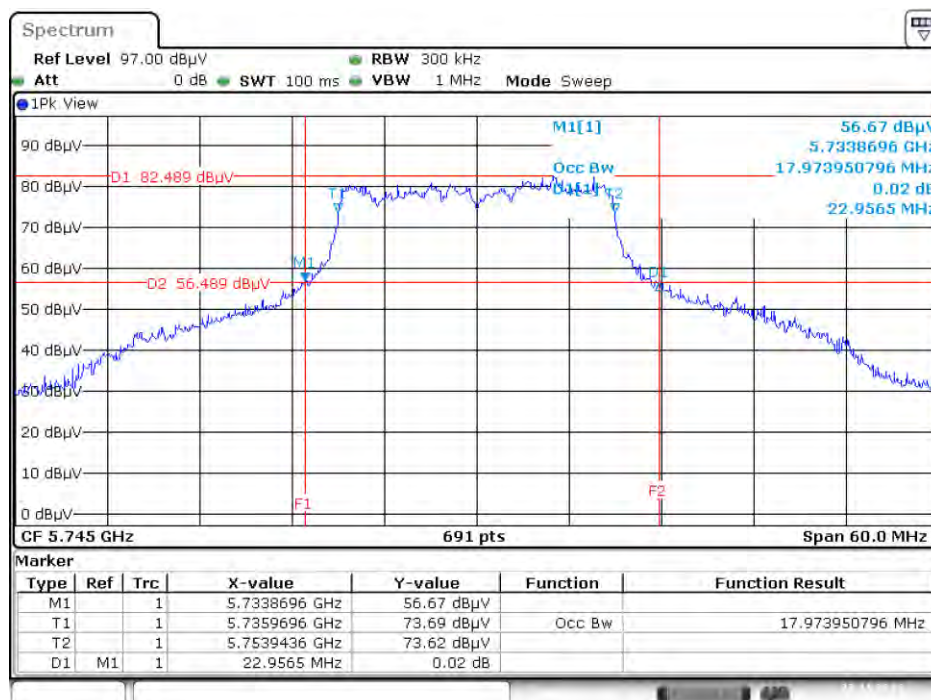

Date: 27. NOV. 2015 23:36:21

26dB Bandwidth and 99% Occupied Bandwidth Plot on Configuration IEEE 802.11ac MCS0/Nss1 VHT20 / Chain 1 + Chain 2 + Chain 3 + Chain 4 / 5785 MHz

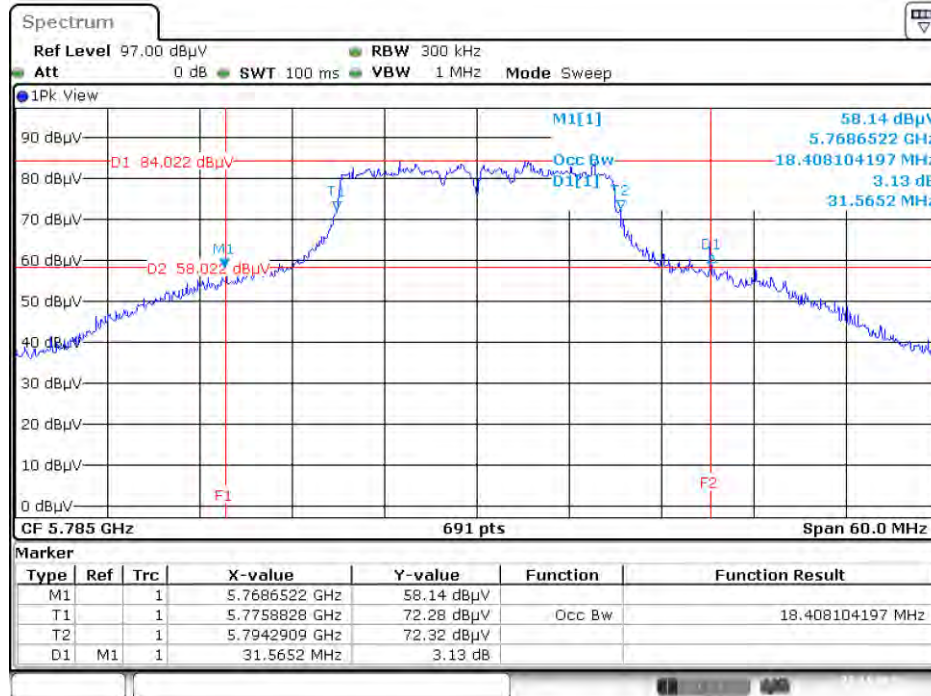

Date: 27.NOV.2015 23:36:55

26dB Bandwidth and 99% Occupied Bandwidth Plot on Configuration IEEE 802.11ac MCS0/Nss1 VHT20 / Chain 1 + Chain 2 + Chain 3 + Chain 4 / 5825 MHz

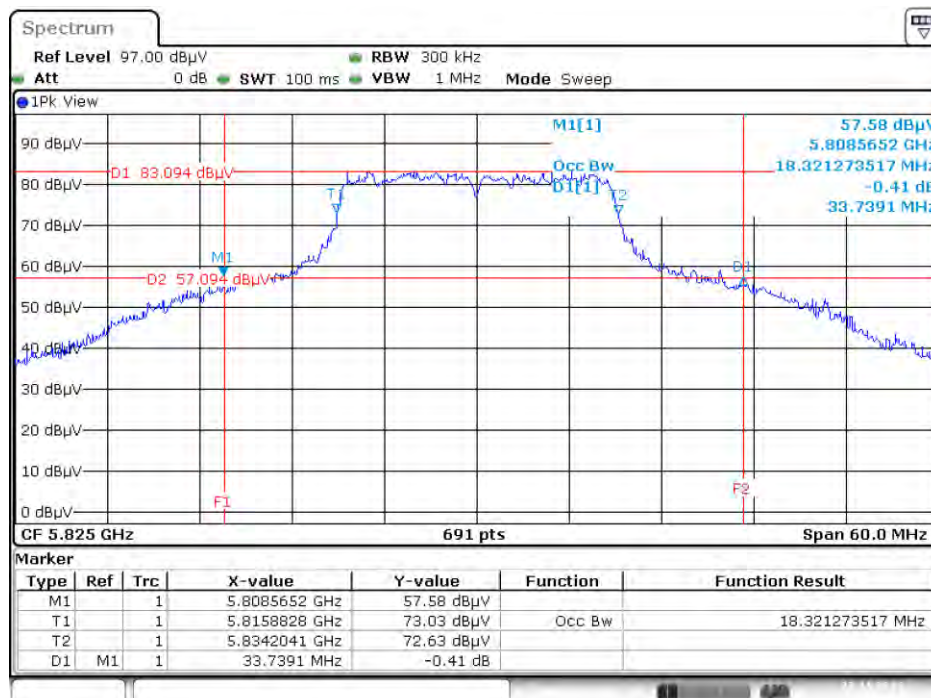

Date: 27.NOV.2015 23:37:19

26dB Bandwidth and 99% Occupied Bandwidth Plot on Configuration IEEE 802.11ac MCS0/Nss1 VHT40 / Chain 1 + Chain 2 + Chain 3 + Chain 4 / 5190 MHz

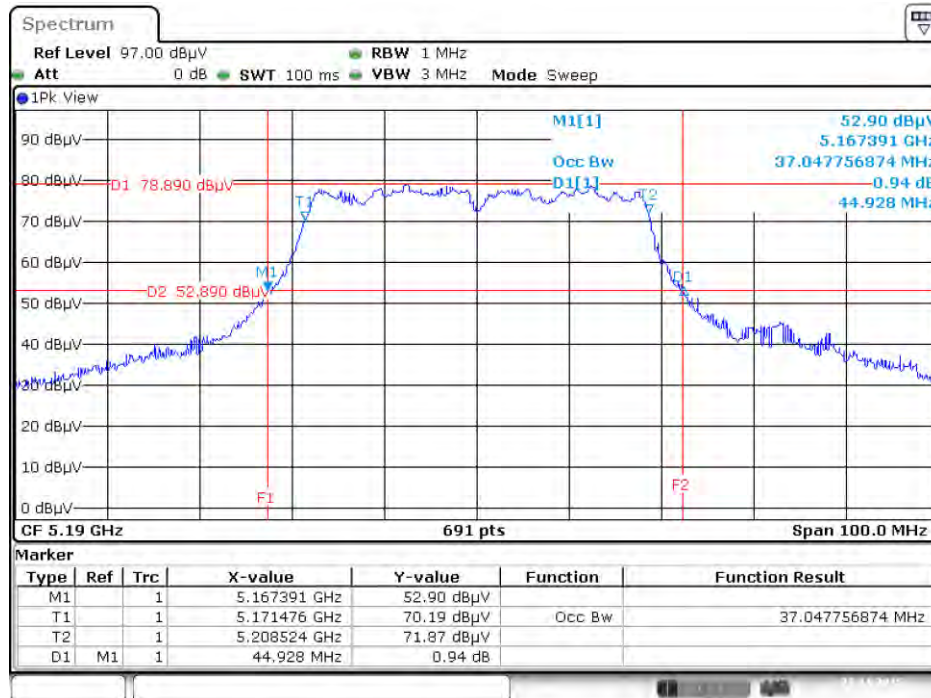

Date: 27.NOV.2015 23:38:34

26dB Bandwidth and 99% Occupied Bandwidth Plot on Configuration IEEE 802.11ac MCS0/Nss1 VHT40 / Chain 1 + Chain 2 + Chain 3 + Chain 4 / 5230 MHz

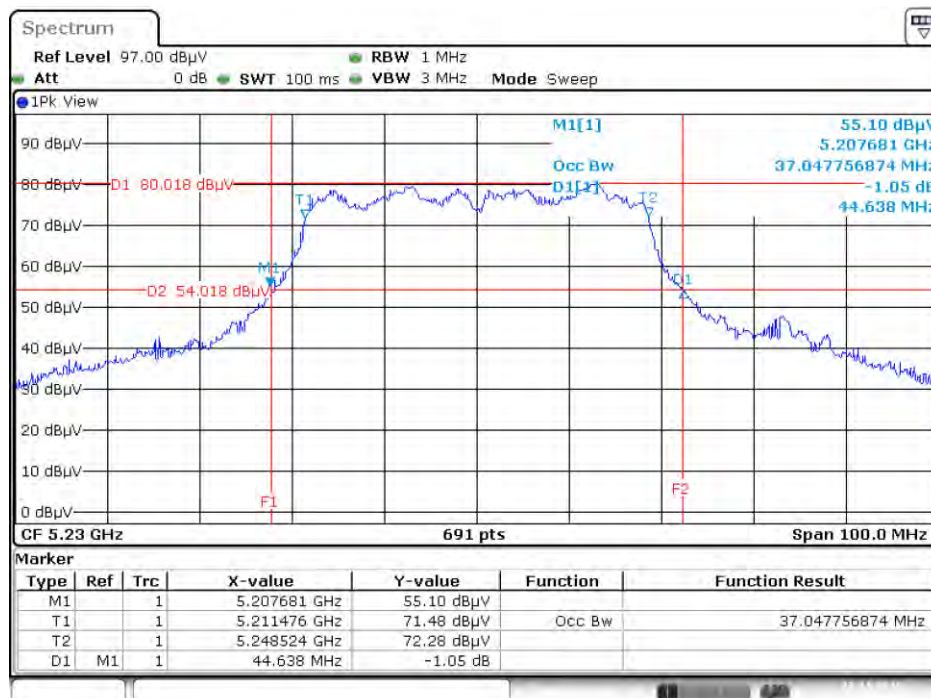

Date: 27.NOV.2015 23:39:05

26dB Bandwidth and 99% Occupied Bandwidth Plot on Configuration IEEE 802.11ac MCS0/Nss1 VHT40 / Chain 1 + Chain 2 + Chain 3 + Chain 4 / 5755 MHz

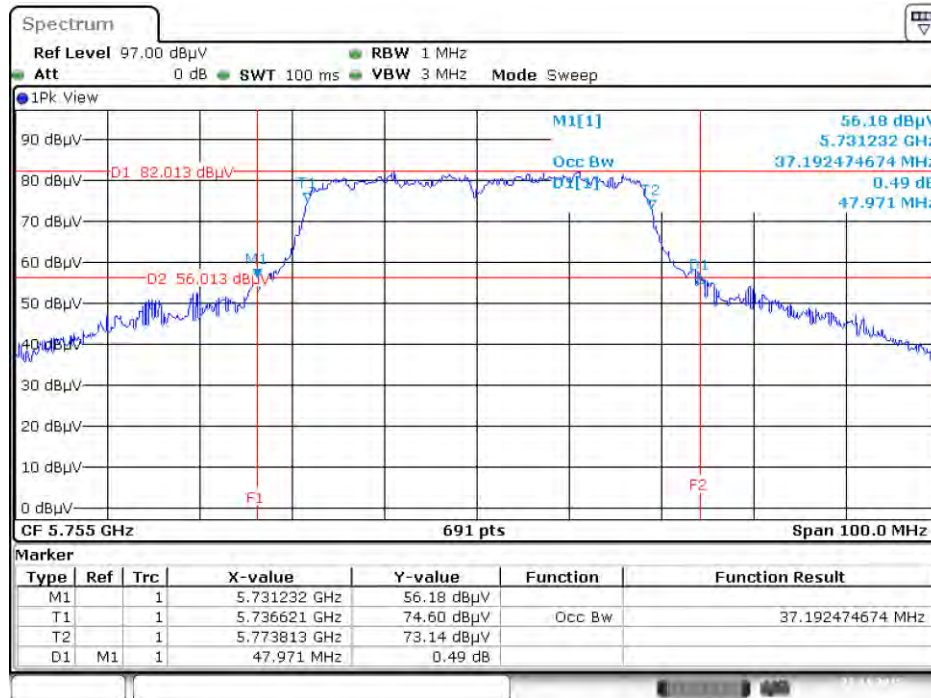

Date: 27. NOV. 2015 23:44:49

26dB Bandwidth and 99% Occupied Bandwidth Plot on Configuration IEEE 802.11ac MCS0/Nss1 VHT40 / Chain 1 + Chain 2 + Chain 3 + Chain 4 / 5795 MHz

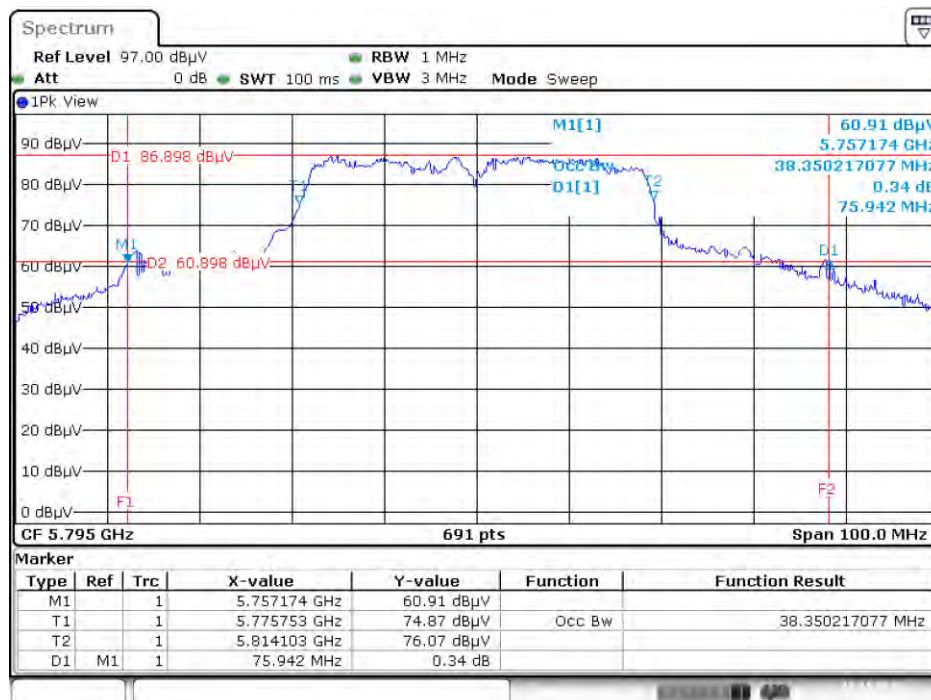

Date: 27. NOV. 2015 23:45:33

26dB Bandwidth and 99% Occupied Bandwidth Plot on Configuration IEEE 802.11ac MCS0/Nss1 VHT80 / Chain 1 + Chain 2 + Chain 3 + Chain 4 / 5210 MHz

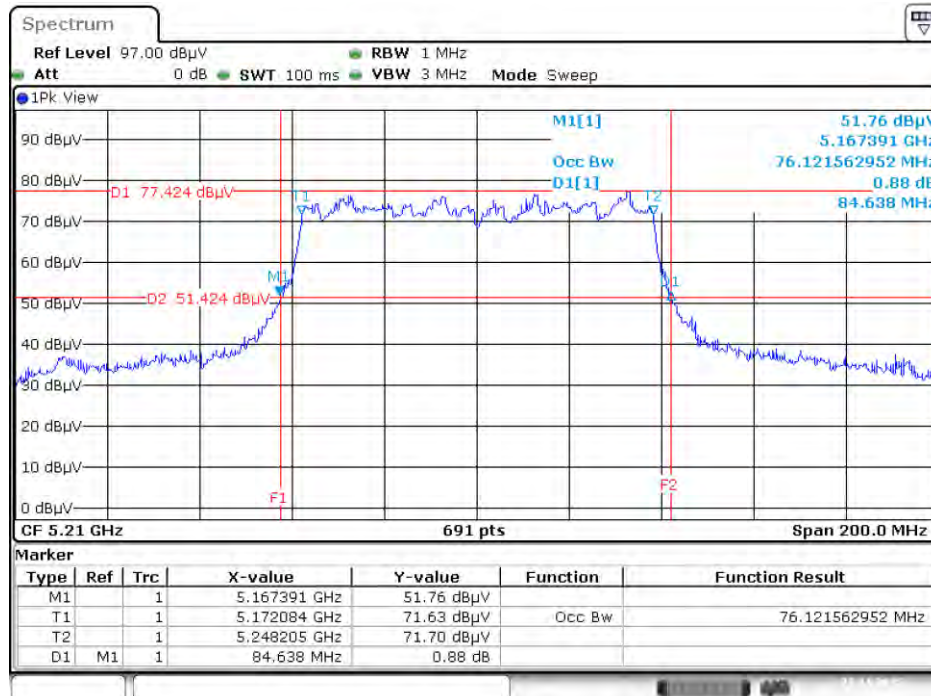

Date: 27. NOV. 2015 23:46:32

26dB Bandwidth and 99% Occupied Bandwidth Plot on Configuration IEEE 802.11ac MCS0/Nss1 VHT80 / Chain 1 + Chain 2 + Chain 3 + Chain 4 / 5775 MHz

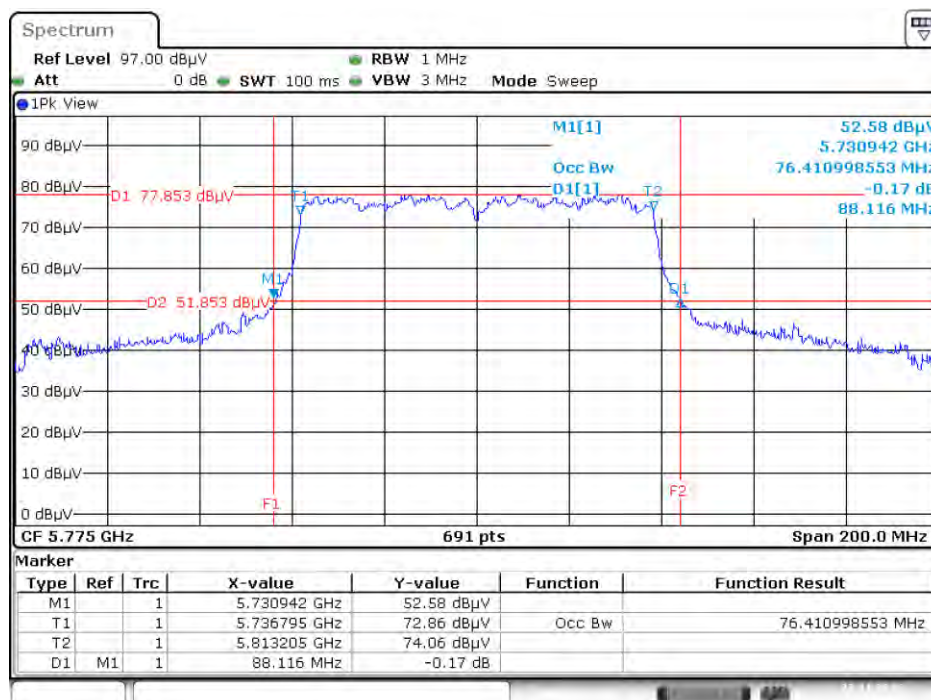

Date: 27. NOV. 2015 23:48:47

Mode 6: EUT 1 + Set 6 Sector Antenna / 4 dBi

26dB Bandwidth and 99% Occupied Bandwidth Plot on Configuration IEEE 802.11ac MCS0/Nss1 VHT20 / Chain 1 + Chain 2 + Chain 3 + Chain 4 / 5180 MHz

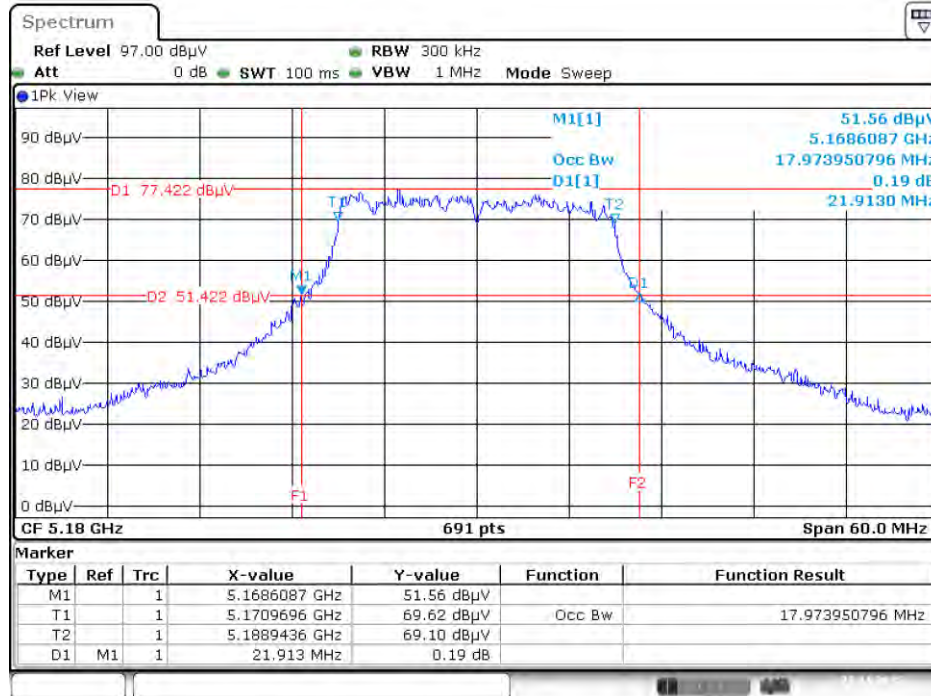

Date: 27.NOV.2015 21:51:21

26dB Bandwidth and 99% Occupied Bandwidth Plot on Configuration IEEE 802.11ac MCS0/Nss1 VHT20 / Chain 1 + Chain 2 + Chain 3 + Chain 4 / 5200 MHz

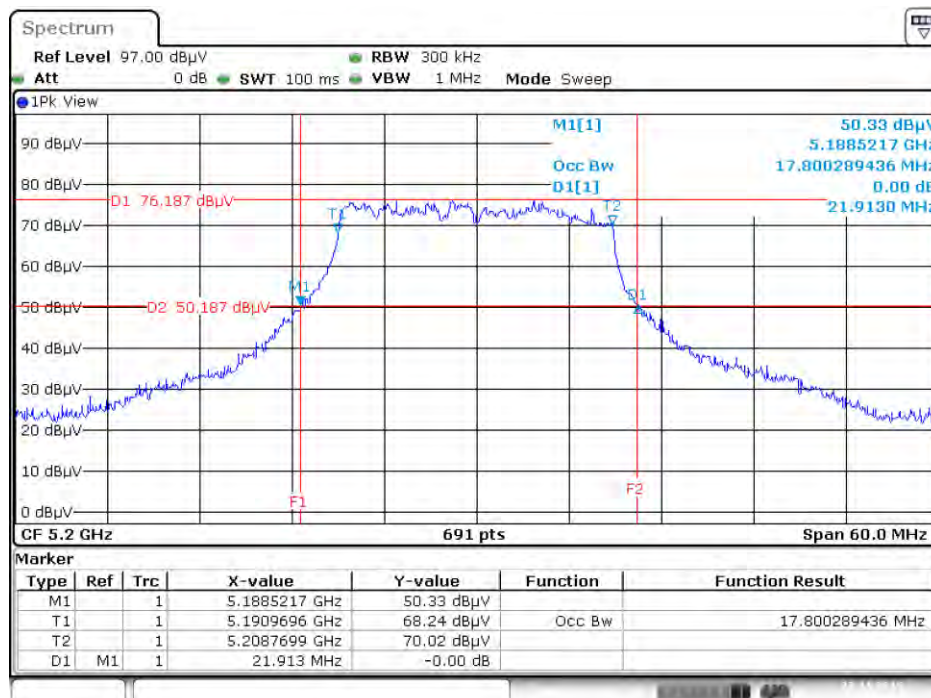

Date: 27.NOV.2015 21:51:43

26dB Bandwidth and 99% Occupied Bandwidth Plot on Configuration IEEE 802.11ac MCS0/Nss1 VHT20 / Chain 1 + Chain 2 + Chain 3 + Chain 4 / 5240 MHz

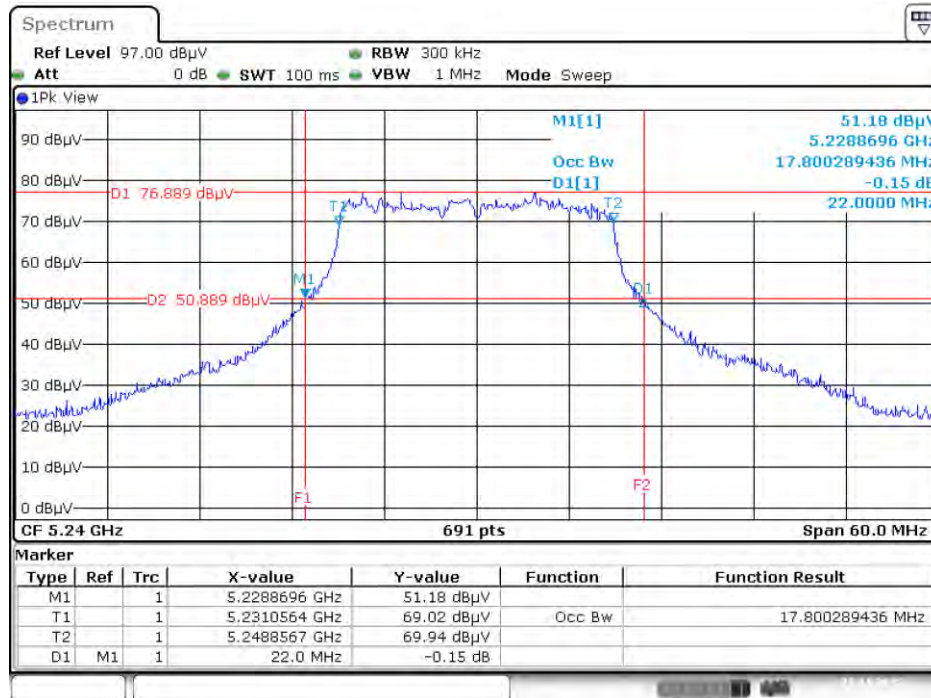

Date: 27.NOV.2015 21:52:17

26dB Bandwidth and 99% Occupied Bandwidth Plot on Configuration IEEE 802.11ac MCS0/Nss1 VHT20 / Chain 1 + Chain 2 + Chain 3 + Chain 4 / 5745 MHz

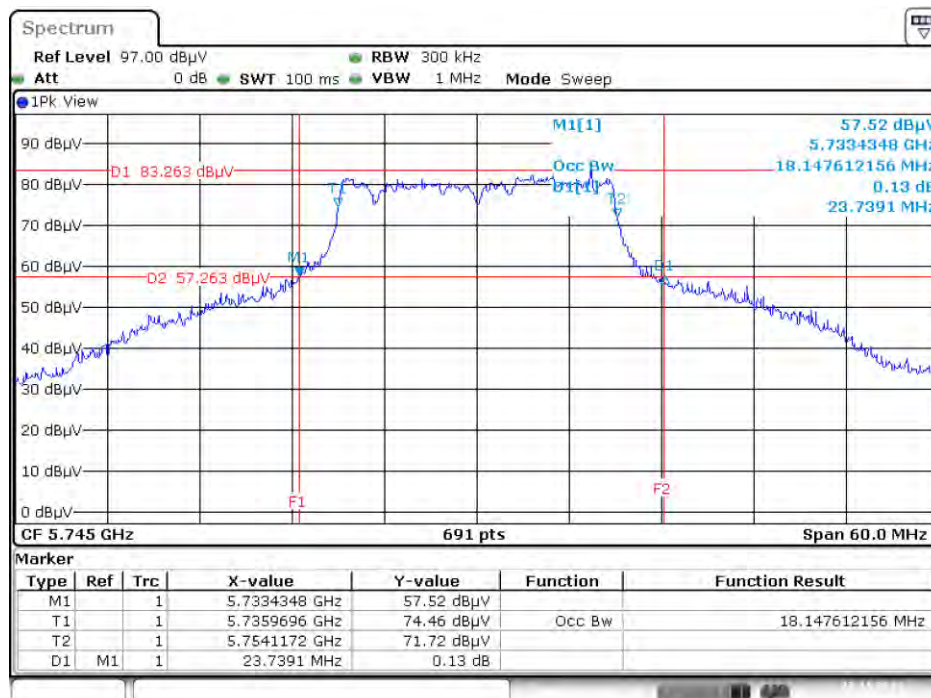

Date: 27.NOV.2015 21:59:44

26dB Bandwidth and 99% Occupied Bandwidth Plot on Configuration IEEE 802.11ac MCS0/Nss1 VHT20 / Chain 1 + Chain 2 + Chain 3 + Chain 4 / 5785 MHz

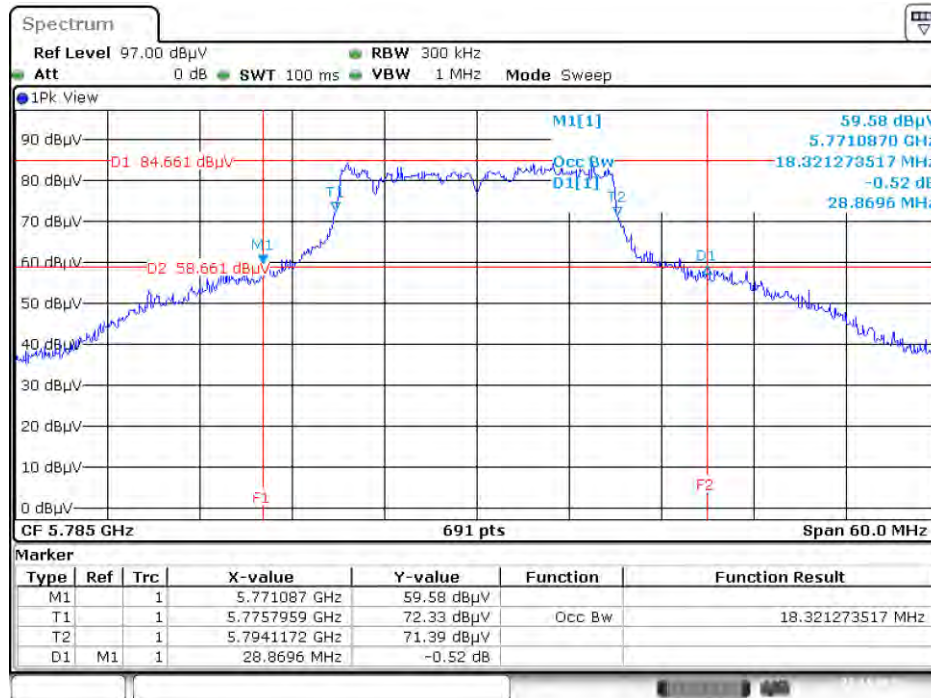

Date: 27.NOV.2015 22:00:37

26dB Bandwidth and 99% Occupied Bandwidth Plot on Configuration IEEE 802.11ac MCS0/Nss1 VHT20 / Chain 1 + Chain 2 + Chain 3 + Chain 4 / 5825 MHz

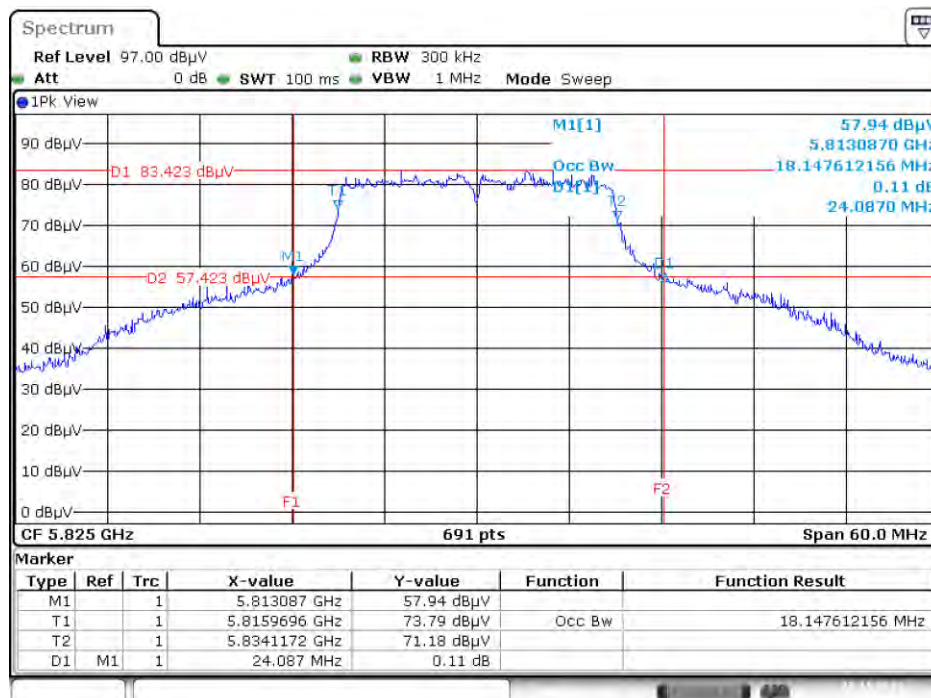

Date: 27.NOV.2015 22:01:06

26dB Bandwidth and 99% Occupied Bandwidth Plot on Configuration IEEE 802.11ac MCS0/Nss1 VHT40 / Chain 1 + Chain 2 + Chain 3 + Chain 4 / 5190 MHz

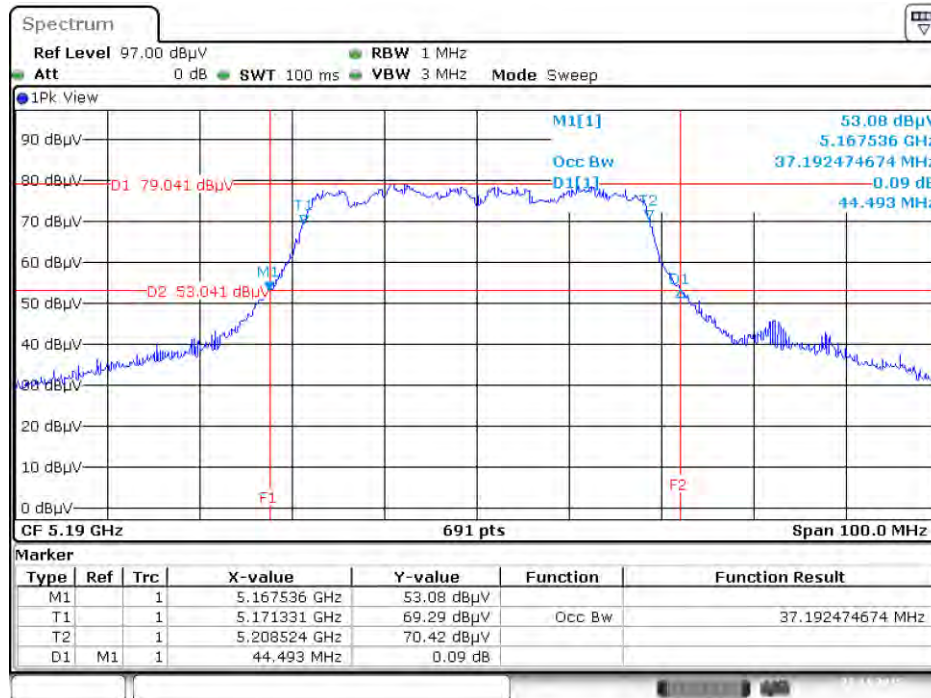

Date: 27.NOV.2015 22:04:23

26dB Bandwidth and 99% Occupied Bandwidth Plot on Configuration IEEE 802.11ac MCS0/Nss1 VHT40 / Chain 1 + Chain 2 + Chain 3 + Chain 4 / 5230 MHz

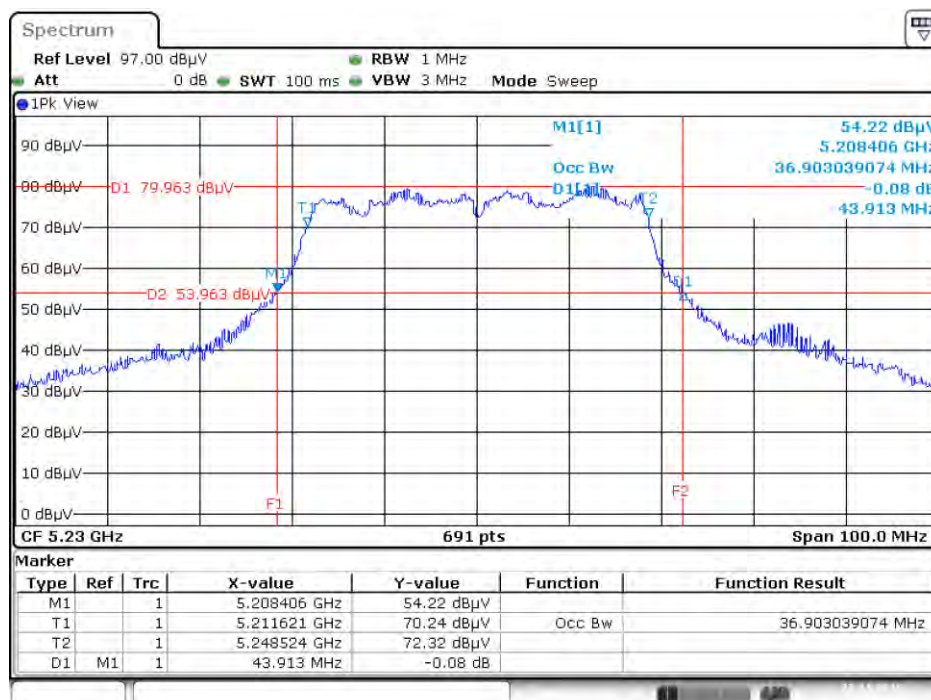

Date: 27.NOV.2015 22:04:50

26dB Bandwidth and 99% Occupied Bandwidth Plot on Configuration IEEE 802.11ac MCS0/Nss1 VHT40 / Chain 1 + Chain 2 + Chain 3 + Chain 4 / 5755 MHz

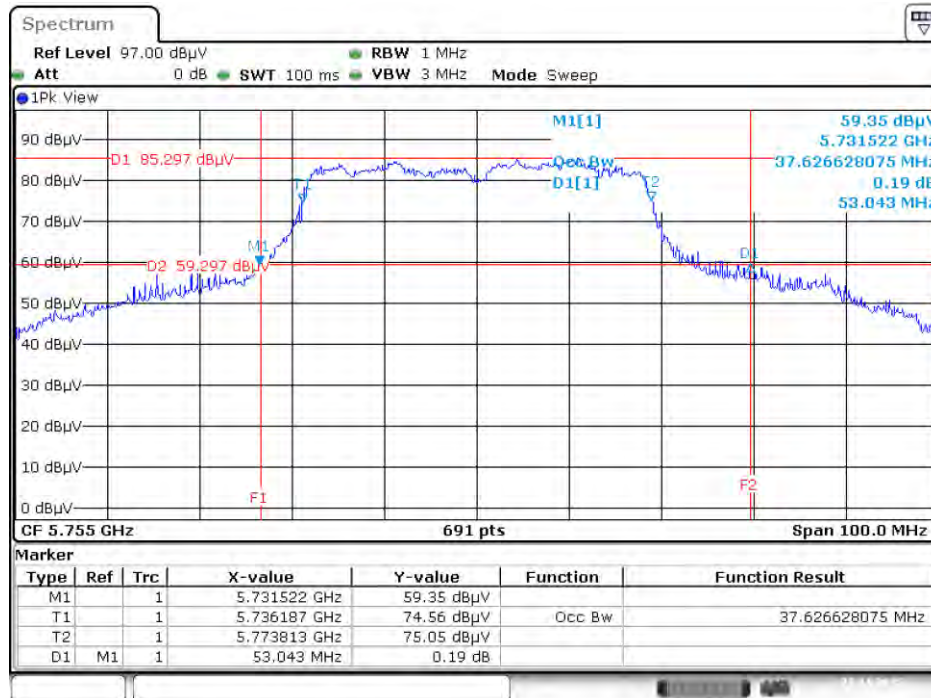

Date: 27.NOV.2015 22:08:09

26dB Bandwidth and 99% Occupied Bandwidth Plot on Configuration IEEE 802.11ac MCS0/Nss1 VHT40 / Chain 1 + Chain 2 + Chain 3 + Chain 4 / 5795 MHz

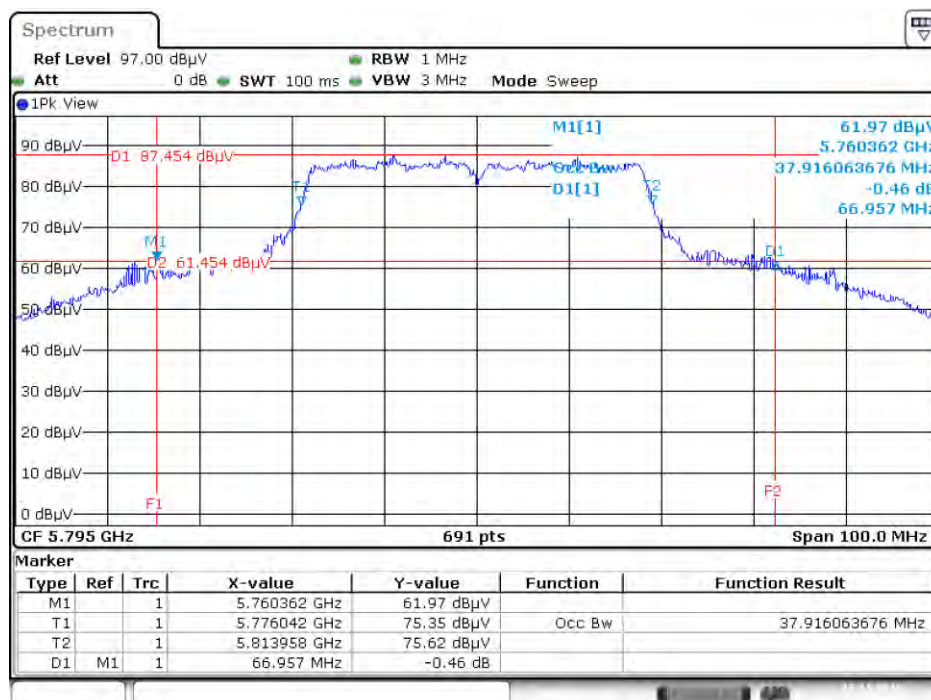

Date: 27.NOV.2015 22:08:40

26dB Bandwidth and 99% Occupied Bandwidth Plot on Configuration IEEE 802.11ac MCS0/Nss1 VHT80 / Chain 1 + Chain 2 + Chain 3 + Chain 4 / 5210 MHz

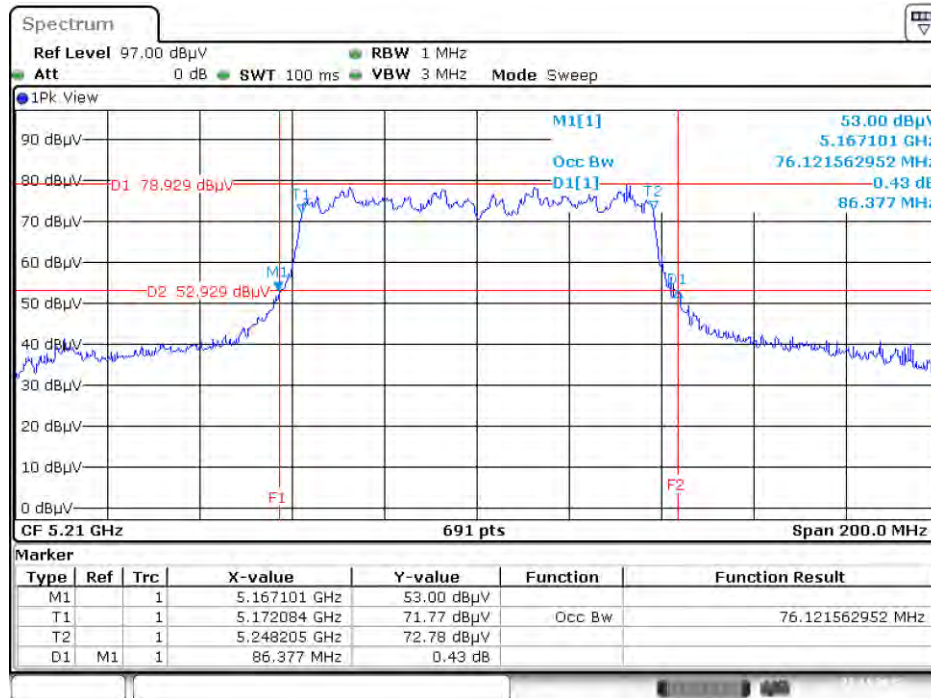

Date: 27.NOV.2015 22:11:34

26dB Bandwidth and 99% Occupied Bandwidth Plot on Configuration IEEE 802.11ac MCS0/Nss1 VHT80 / Chain 1 + Chain 2 + Chain 3 + Chain 4 / 5775 MHz

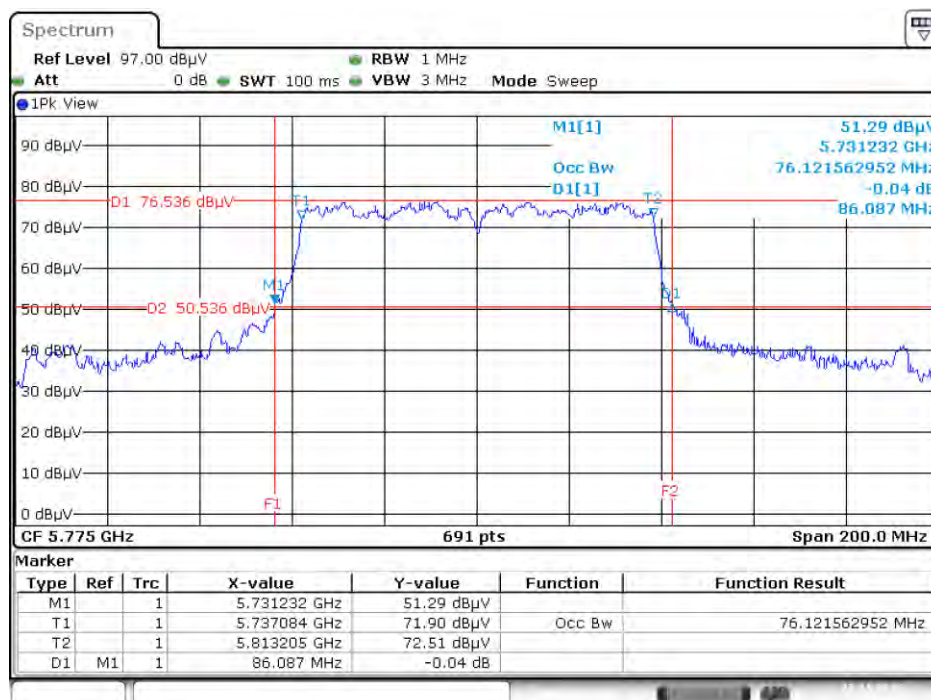

Date: 27.NOV.2015 22:14:23

Mode 7: EUT 1 + Set 9 Dipole Antenna / 4.67 dBi

26dB Bandwidth and 99% Occupied Bandwidth Plot on Configuration IEEE 802.11ac MCS0/Nss1 VHT20 / Chain 1 + Chain 2 + Chain 3 + Chain 4 / 5180 MHz

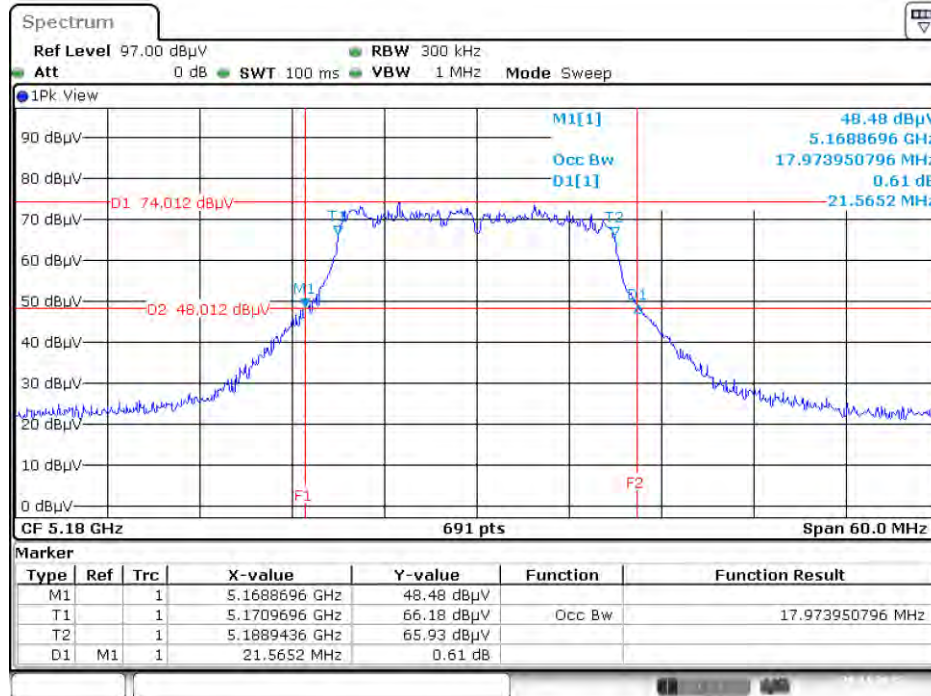

Date: 28 NOV. 2015 00:18:23

26dB Bandwidth and 99% Occupied Bandwidth Plot on Configuration IEEE 802.11ac MCS0/Nss1 VHT20 / Chain 1 + Chain 2 + Chain 3 + Chain 4 / 5200 MHz

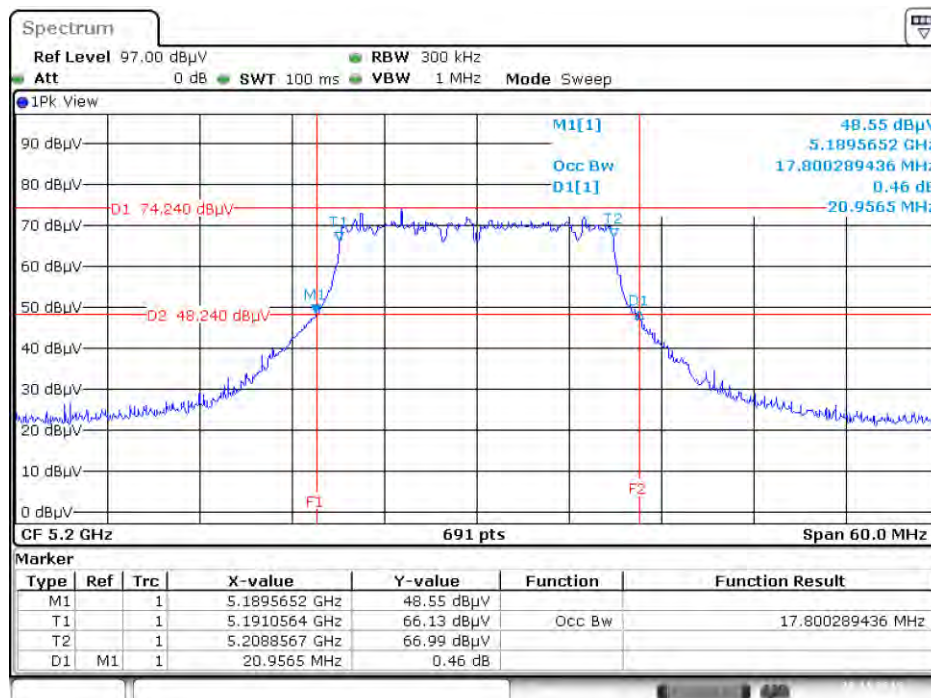

Date: 28 NOV. 2015 00:18:51

26dB Bandwidth and 99% Occupied Bandwidth Plot on Configuration IEEE 802.11ac MCS0/Nss1 VHT20 / Chain 1 + Chain 2 + Chain 3 + Chain 4 / 5240 MHz

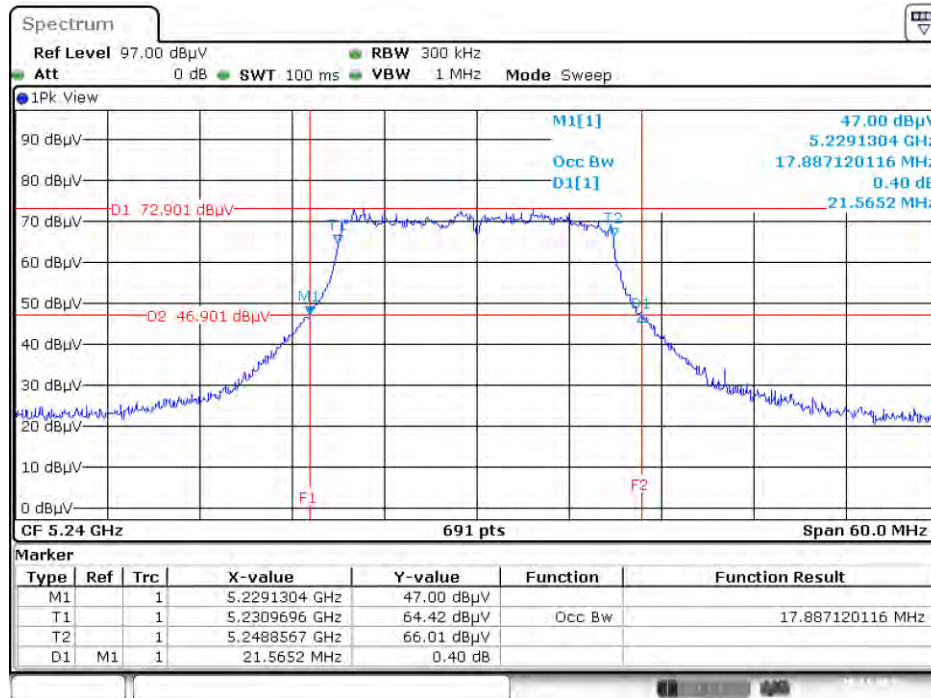

Date: 28 NOV. 2015 00:19:11

26dB Bandwidth and 99% Occupied Bandwidth Plot on Configuration IEEE 802.11ac MCS0/Nss1 VHT20 / Chain 1 + Chain 2 + Chain 3 + Chain 4 / 5745 MHz

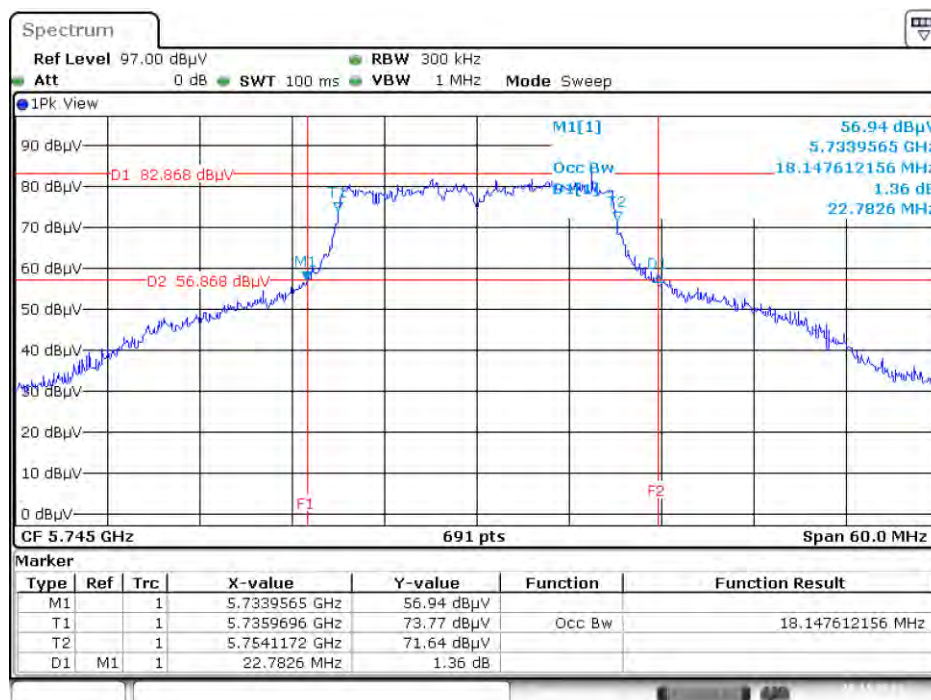

Date: 28 NOV. 2015 01:13:56

26dB Bandwidth and 99% Occupied Bandwidth Plot on Configuration IEEE 802.11ac MCS0/Nss1 VHT20 / Chain 1 + Chain 2 + Chain 3 + Chain 4 / 5785 MHz

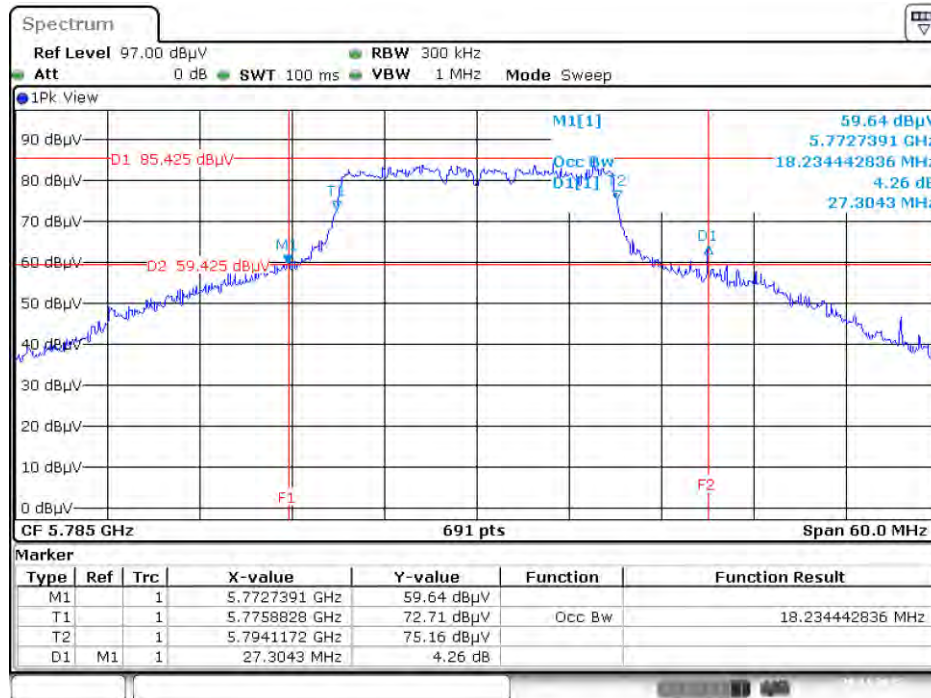

Date: 28.NOV.2015 00:23:25

26dB Bandwidth and 99% Occupied Bandwidth Plot on Configuration IEEE 802.11ac MCS0/Nss1 VHT20 / Chain 1 + Chain 2 + Chain 3 + Chain 4 / 5825 MHz

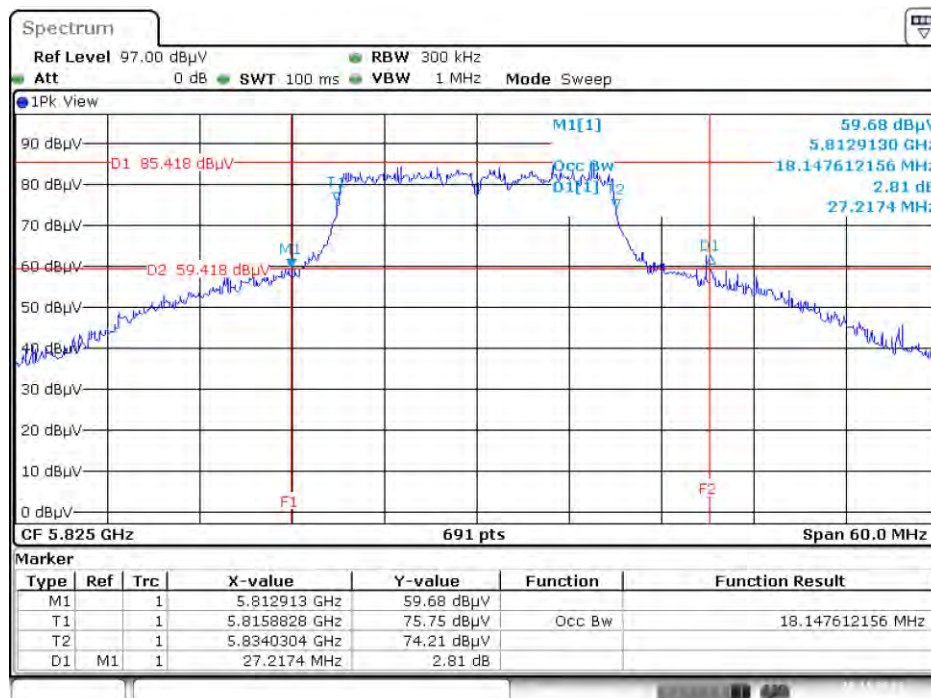

Date: 28.NOV.2015 01:14:34

26dB Bandwidth and 99% Occupied Bandwidth Plot on Configuration IEEE 802.11ac MCS0/Nss1 VHT40 / Chain 1 + Chain 2 + Chain 3 + Chain 4 / 5190 MHz

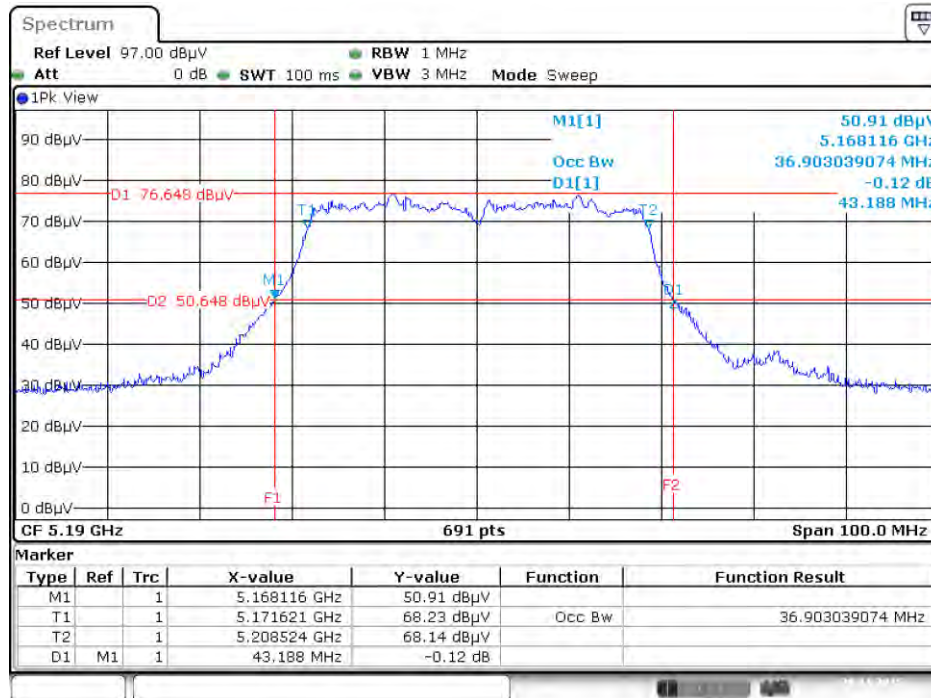

Date: 28 NOV. 2015 00:24:37

26dB Bandwidth and 99% Occupied Bandwidth Plot on Configuration IEEE 802.11ac MCS0/Nss1 VHT40 / Chain 1 + Chain 2 + Chain 3 + Chain 4 / 5230 MHz

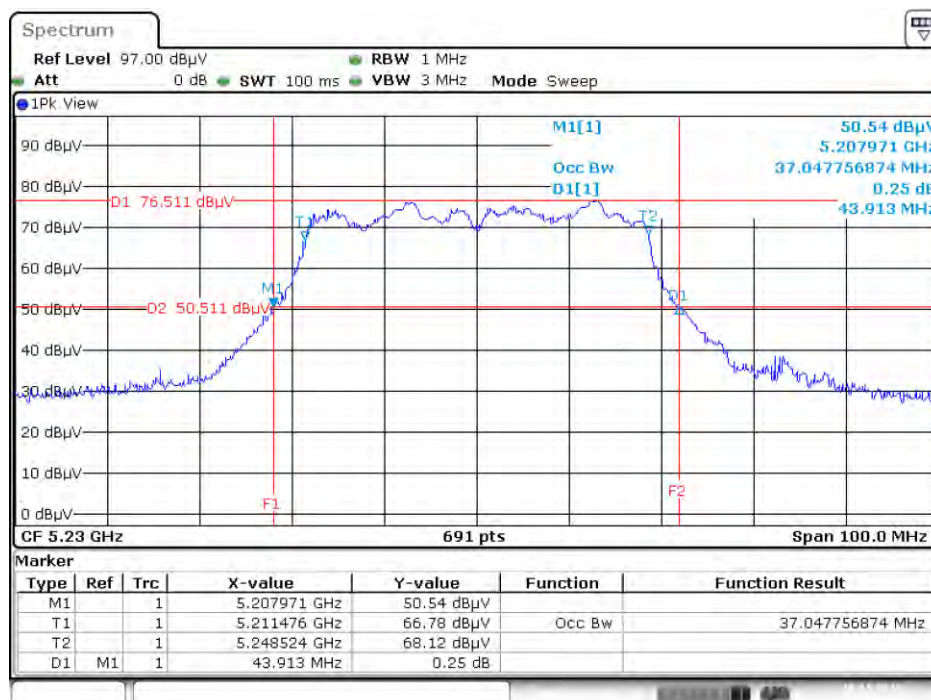

Date: 28 NOV. 2015 00:25:09

26dB Bandwidth and 99% Occupied Bandwidth Plot on Configuration IEEE 802.11ac MCS0/Nss1 VHT40 / Chain 1 + Chain 2 + Chain 3 + Chain 4 / 5755 MHz

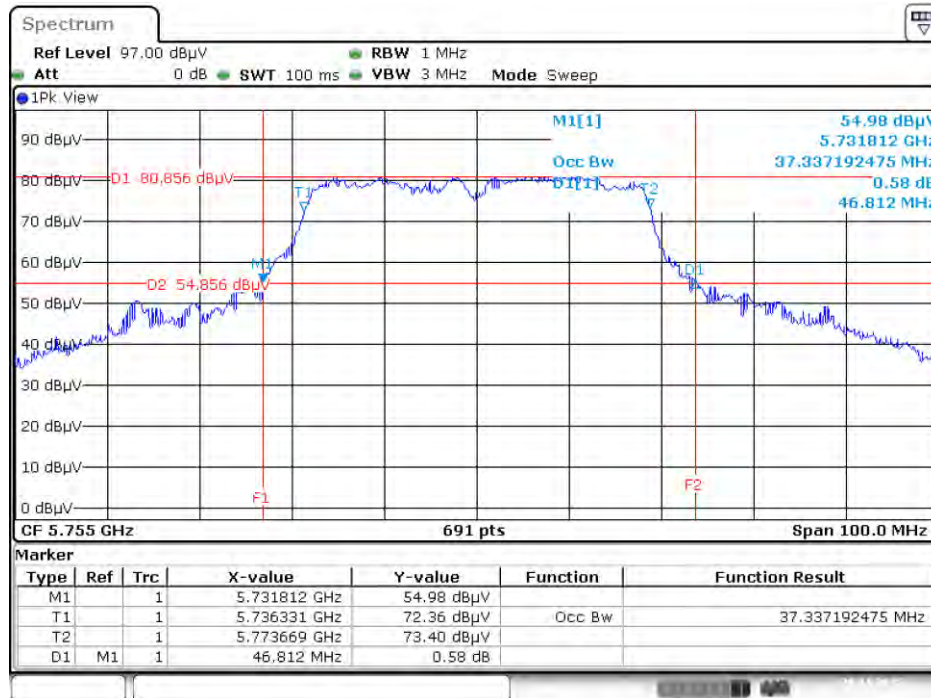

Date: 28.NOV.2015 01:16:00

26dB Bandwidth and 99% Occupied Bandwidth Plot on Configuration IEEE 802.11ac MCS0/Nss1 VHT40 / Chain 1 + Chain 2 + Chain 3 + Chain 4 / 5795 MHz

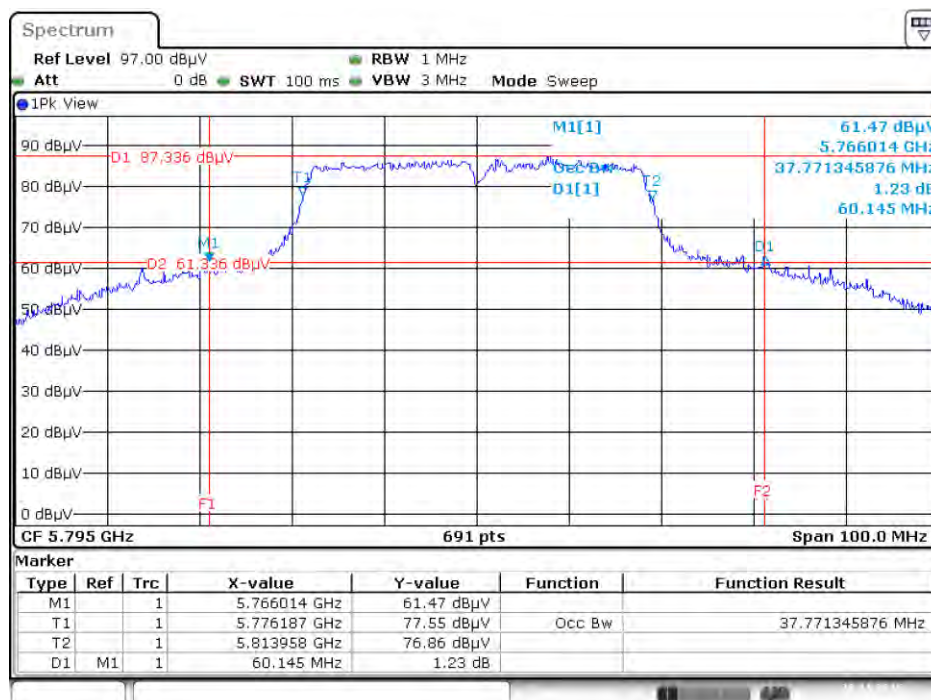

Date: 28.NOV.2015 01:16:39

26dB Bandwidth and 99% Occupied Bandwidth Plot on Configuration IEEE 802.11ac MCS0/Nss1 VHT80 / Chain 1 + Chain 2 + Chain 3 + Chain 4 / 5210 MHz

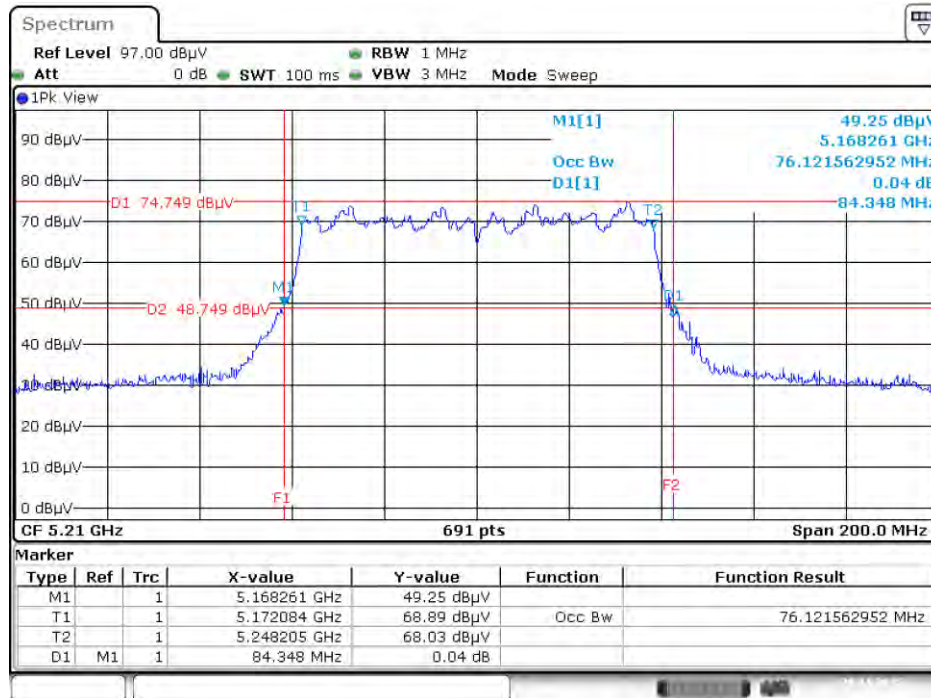

Date: 28 NOV. 2015 00:29:50

26dB Bandwidth and 99% Occupied Bandwidth Plot on Configuration IEEE 802.11ac MCS0/Nss1 VHT80 / Chain 1 + Chain 2 + Chain 3 + Chain 4 / 5775 MHz

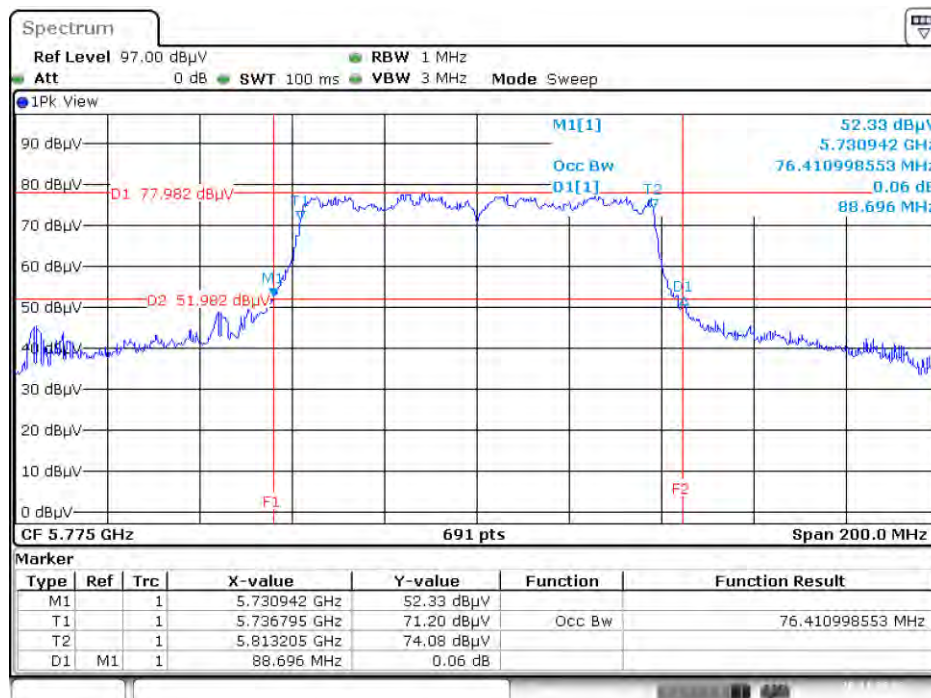

Date: 28 NOV. 2015 01:19:17

Mode 8: EUT 2 + Set 10 PIFA Antenna / Chain1:5.84 dBi, Chain2:5.50 dBi, Chain3:5.84 dBi, Chain4:5.65 dBi

26dB Bandwidth and 99% Occupied Bandwidth Plot on Configuration IEEE 802.11ac MCS0/Nss1 VHT20 / Chain 1 + Chain 2 + Chain 3 + Chain 4 / 5180 MHz

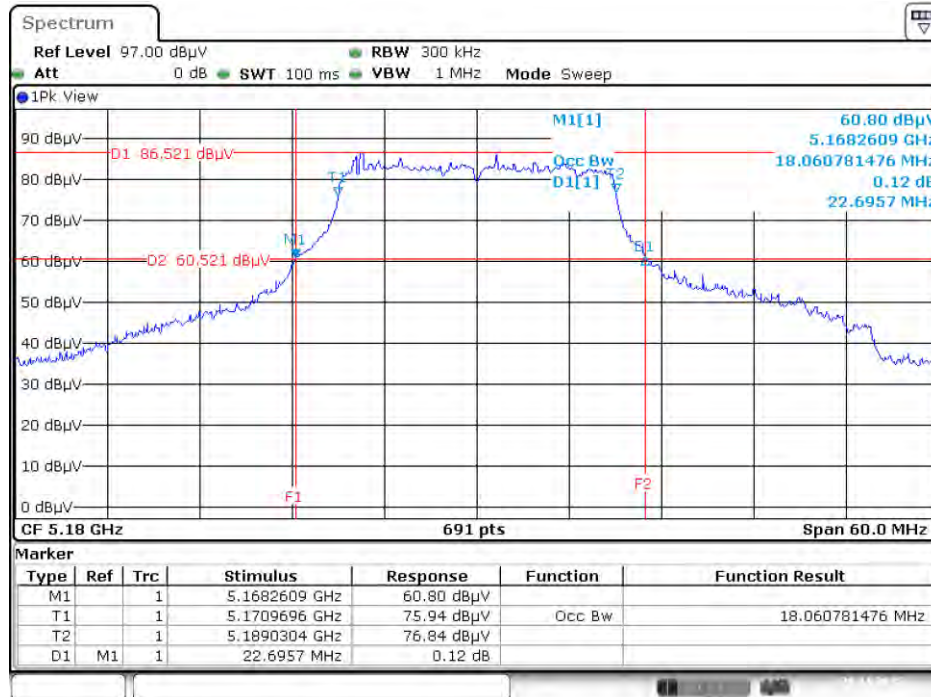

Date: 28.NOV.2015 21:44:00

26dB Bandwidth and 99% Occupied Bandwidth Plot on Configuration IEEE 802.11ac MCS0/Nss1 VHT20 / Chain 1 + Chain 2 + Chain 3 + Chain 4 / 5200 MHz

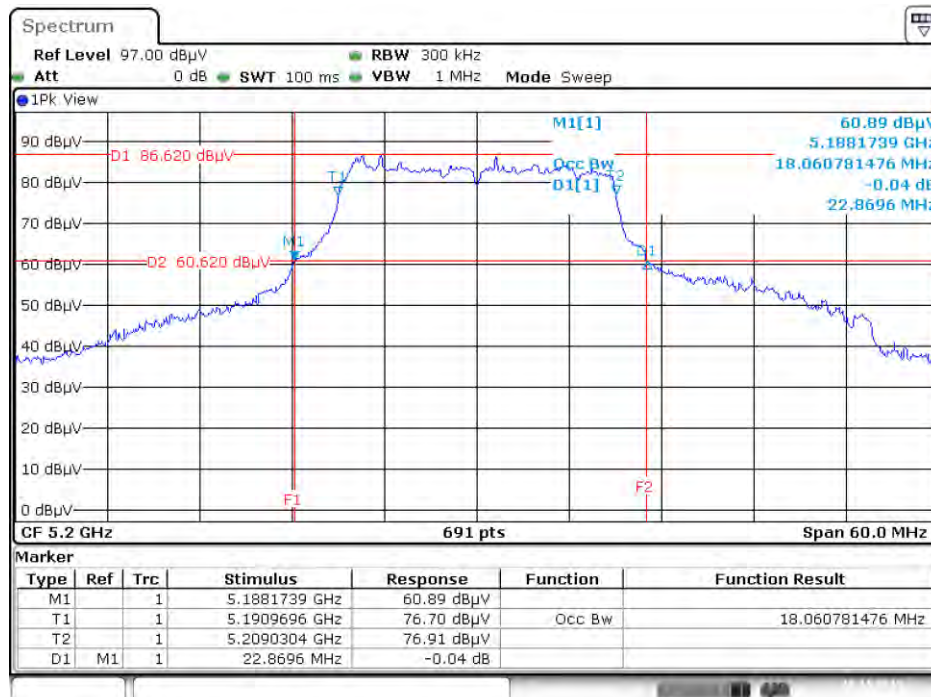

Date: 28.NOV.2015 21:45:24

26dB Bandwidth and 99% Occupied Bandwidth Plot on Configuration IEEE 802.11ac MCS0/Nss1 VHT20 / Chain 1 + Chain 2 + Chain 3 + Chain 4 / 5240 MHz

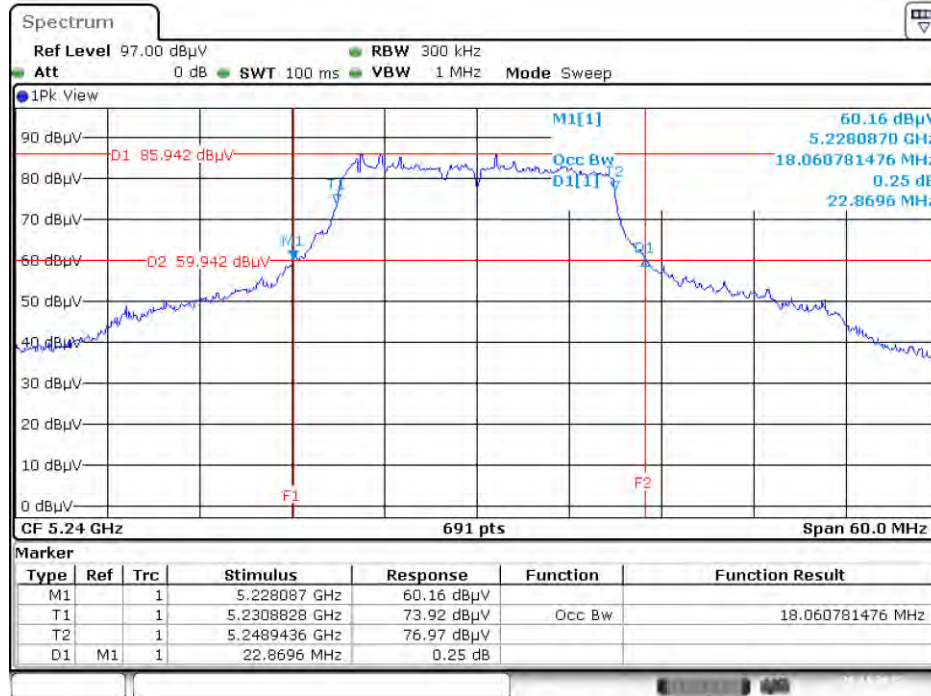

Date: 28.NOV.2015 21:46:50

26dB Bandwidth and 99% Occupied Bandwidth Plot on Configuration IEEE 802.11ac MCS0/Nss1 VHT20 / Chain 1 + Chain 2 + Chain 3 + Chain 4 / 5745 MHz

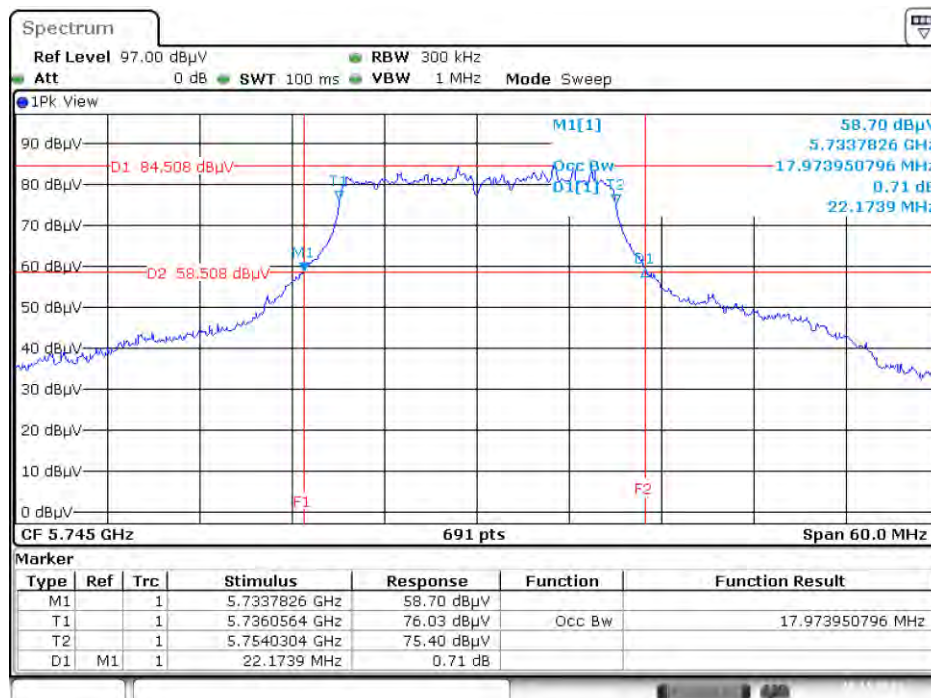

Date: 28.NOV.2015 21:57:27

26dB Bandwidth and 99% Occupied Bandwidth Plot on Configuration IEEE 802.11ac MCS0/Nss1 VHT20 / Chain 1 + Chain 2 + Chain 3 + Chain 4 / 5785 MHz

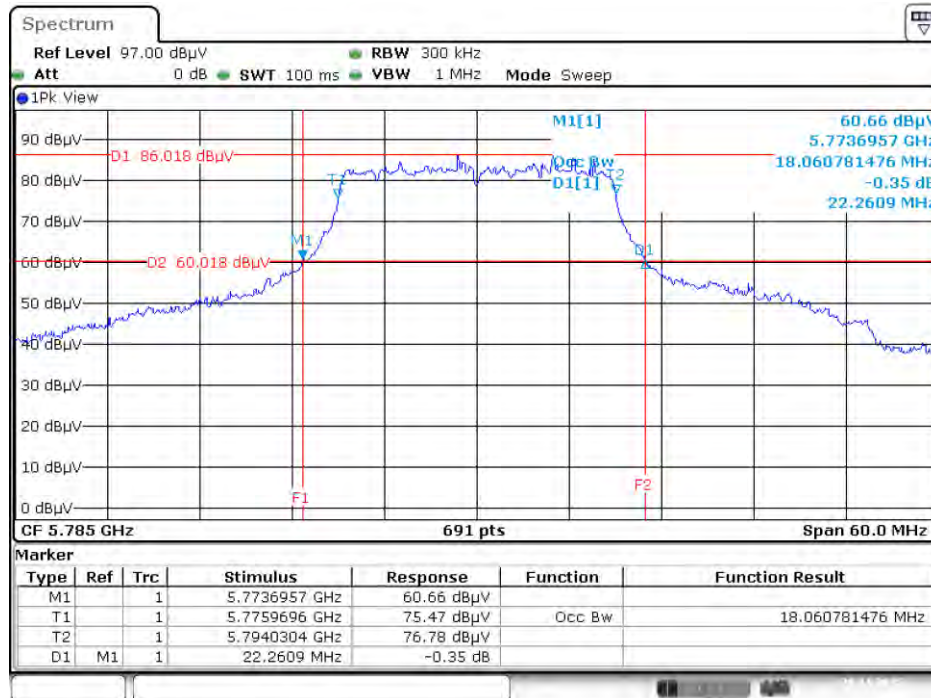

Date: 28.NOV.2015 22:11:09

26dB Bandwidth and 99% Occupied Bandwidth Plot on Configuration IEEE 802.11ac MCS0/Nss1 VHT20 / Chain 1 + Chain 2 + Chain 3 + Chain 4 / 5825 MHz

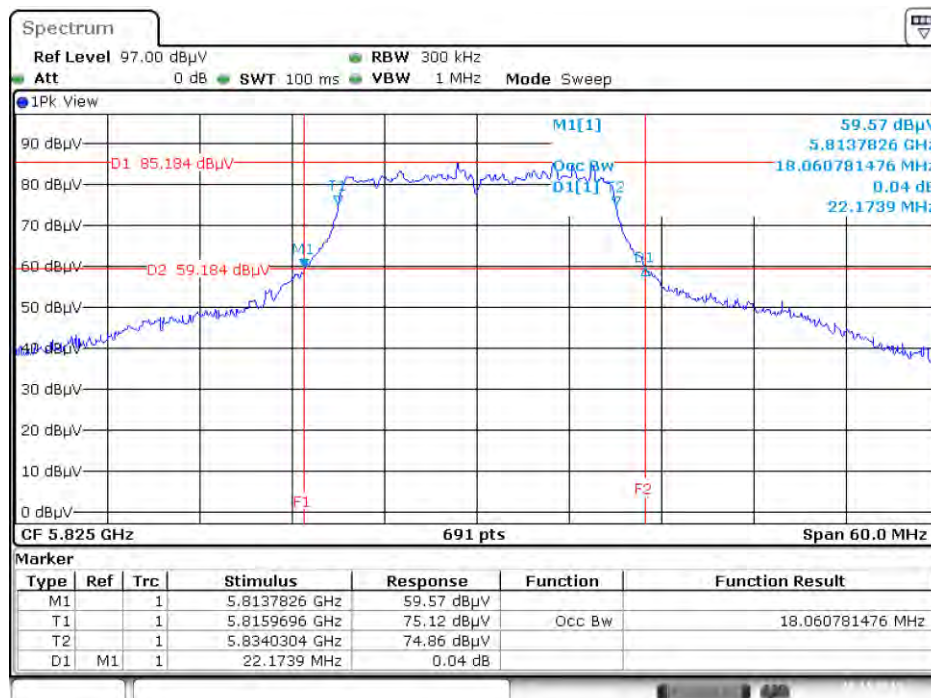

Date: 28.NOV.2015 22:12:42

26dB Bandwidth and 99% Occupied Bandwidth Plot on Configuration IEEE 802.11ac MCS0/Nss1 VHT40 / Chain 1 + Chain 2 + Chain 3 + Chain 4 / 5190 MHz

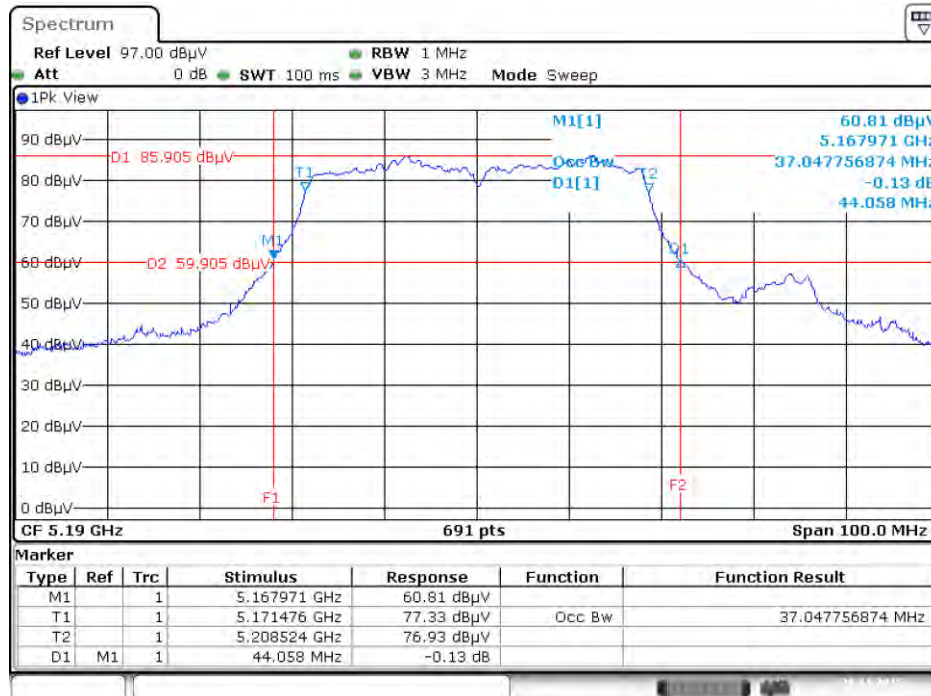

Date: 28.NOV.2015 22:15:07

26dB Bandwidth and 99% Occupied Bandwidth Plot on Configuration IEEE 802.11ac MCS0/Nss1 VHT40 / Chain 1 + Chain 2 + Chain 3 + Chain 4 / 5230 MHz

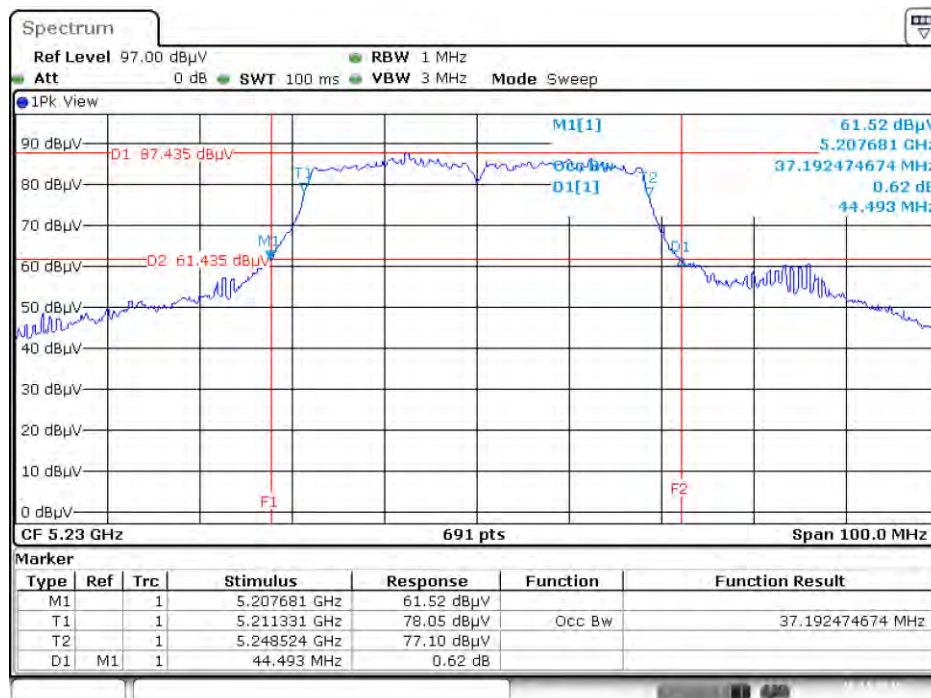

Date: 28.NOV.2015 22:16:28

26dB Bandwidth and 99% Occupied Bandwidth Plot on Configuration IEEE 802.11ac MCS0/Nss1 VHT40 / Chain 1 + Chain 2 + Chain 3 + Chain 4 / 5755 MHz

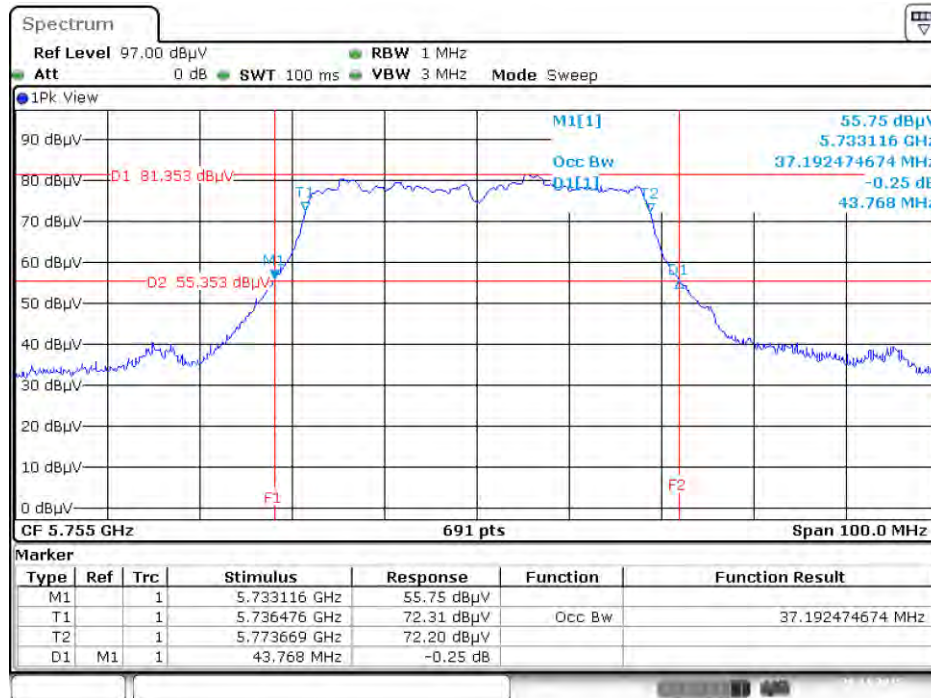

Date: 28.NOV.2015 22:23:38

26dB Bandwidth and 99% Occupied Bandwidth Plot on Configuration IEEE 802.11ac MCS0/Nss1 VHT40 / Chain 1 + Chain 2 + Chain 3 + Chain 4 / 5795 MHz

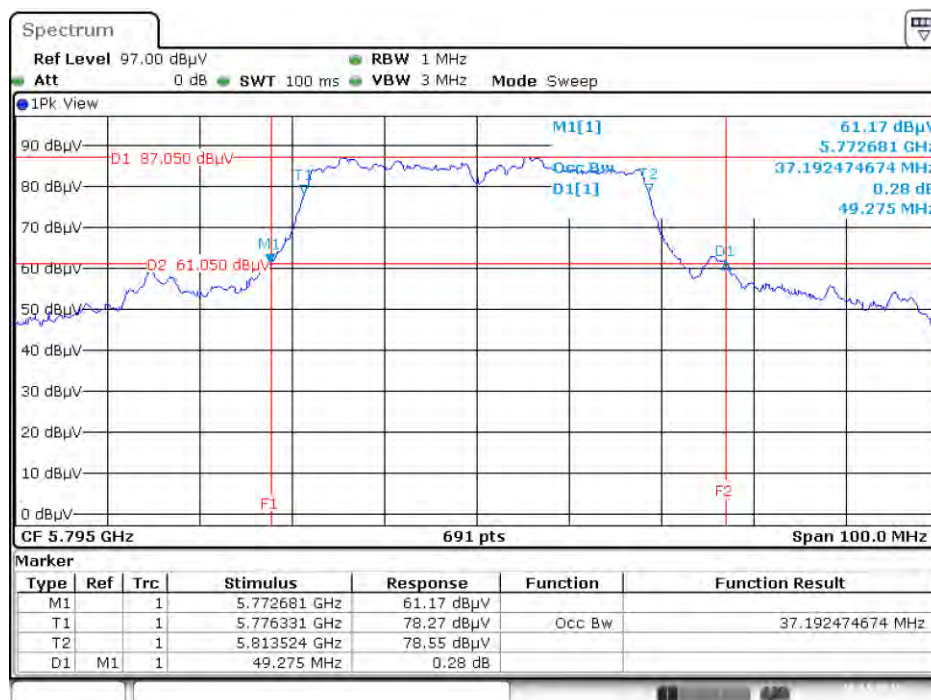

Date: 28.NOV.2015 22:27:51

26dB Bandwidth and 99% Occupied Bandwidth Plot on Configuration IEEE 802.11ac MCS0/Nss1 VHT80 / Chain 1 + Chain 2 + Chain 3 + Chain 4 / 5210 MHz

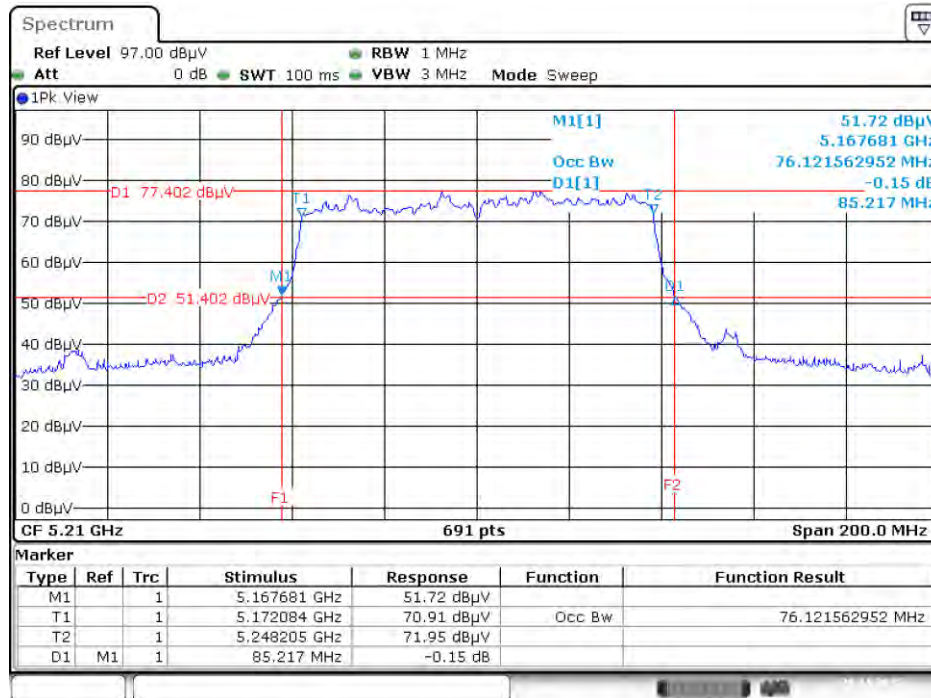

Date: 28.NOV.2015 22:34:55

26dB Bandwidth and 99% Occupied Bandwidth Plot on Configuration IEEE 802.11ac MCS0/Nss1 VHT80 / Chain 1 + Chain 2 + Chain 3 + Chain 4 / 5775 MHz

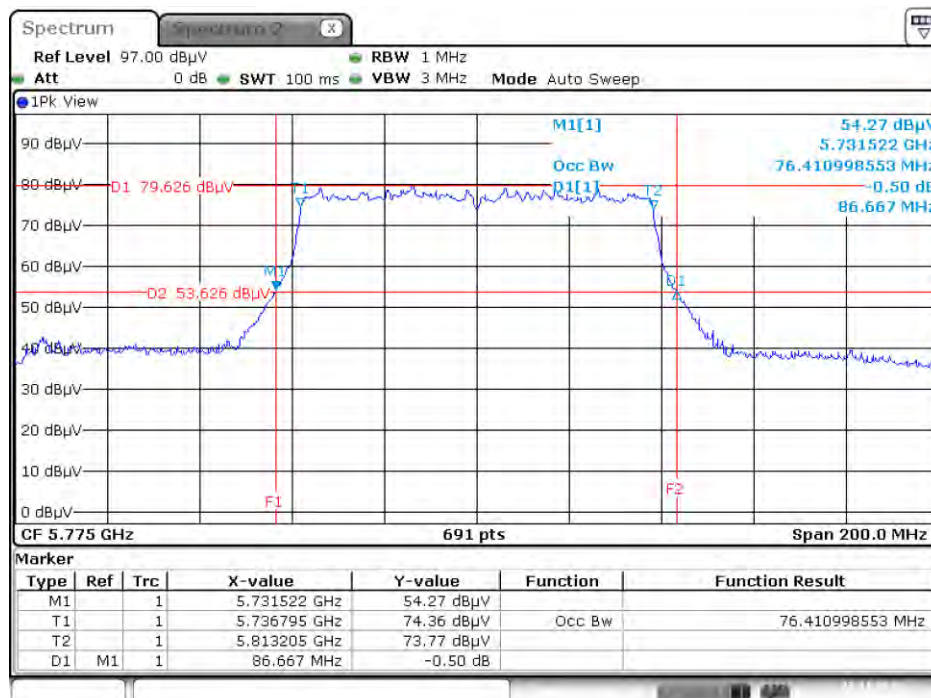

Date: 27.NOV.2015 02:57:17

4.3. 6dB Spectrum Bandwidth Measurement

4.3.1. Limit

For digital modulation systems, the minimum 6dB bandwidth shall be at least 500 kHz.

4.3.2. Measuring Instruments and Setting

Please refer to section 5 of equipments list in this report. The following table is the setting of spectrum analyzer.

6dB Spectrum Bandwidth	
Spectrum Parameters	Setting
Attenuation	Auto
Span Frequency	> 6dB Bandwidth
RBW	100kHz
VBW	$\geq 3 \times \text{RBW}$
Detector	Peak
Trace	Max Hold
Sweep Time	Auto

4.3.3. Test Procedures

For Radiated 6dB Bandwidth Measurement:

1. The transmitter was radiated to the spectrum analyzer in peak hold mode.
2. Test was performed in accordance with KDB789033 D02 v01 for Compliance Testing of Unlicensed National Information Infrastructure (U-NII) Devices - section (C) Emission Bandwidth.
3. Multiple antenna system was performed in accordance with KDB662911 D01 v02r01 Emissions Testing of Transmitters with Multiple Outputs in the Same Band.
4. Measured the spectrum width with power higher than 6dB below carrier.

4.3.4. Test Setup Layout

For Radiated 6dB Bandwidth Measurement:

This test setup layout is the same as that shown in section 4.6.4.

4.3.5. Test Deviation

There is no deviation with the original standard.

4.3.6. EUT Operation during Test

The EUT was programmed to be in continuously transmitting mode.

4.3.7. Test Result of 6dB Spectrum Bandwidth

Temperature	25°C	Humidity	50%
Test Engineer	Eddie Weng & Lucas Huang		
Test Mode	Mode 1: EUT 1 + Set 1 Ceiling Mount Omni Antenna / 7 dBi		

Mode	Frequency	6dB Bandwidth (MHz)	Min. Limit (kHz)	Test Result
802.11ac MCS0/Nss1 VHT20	5745 MHz	17.80	500	Complies
	5785 MHz	17.74	500	Complies
	5825 MHz	17.74	500	Complies
802.11ac MCS0/Nss1 VHT40	5755 MHz	30.84	500	Complies
	5795 MHz	32.00	500	Complies
802.11ac MCS0/Nss1 VHT80	5775 MHz	72.36	500	Complies

Temperature	25°C	Humidity	50%
Test Engineer	Eddie Weng & Lucas Huang		
Test Mode	Mode 2: EUT 1 + Set 2 Sector Antenna / 6.5 dBi		

Mode	Frequency	6dB Bandwidth (MHz)	Min. Limit (kHz)	Test Result
802.11ac MCS0/Nss1 VHT20	5745 MHz	17.68	500	Complies
	5785 MHz	17.74	500	Complies
	5825 MHz	17.74	500	Complies
802.11ac MCS0/Nss1 VHT40	5755 MHz	29.33	500	Complies
	5795 MHz	32.00	500	Complies
802.11ac MCS0/Nss1 VHT80	5775 MHz	75.65	500	Complies

Temperature	25°C	Humidity	50%
Test Engineer	Eddie Weng & Lucas Huang		
Test Mode	Mode 3: EUT 1 + Set 3 Sector Antenna / 5.5 dBi		

Mode	Frequency	6dB Bandwidth (MHz)	Min. Limit (kHz)	Test Result
802.11ac MCS0/Nss1 VHT20	5745 MHz	17.80	500	Complies
	5785 MHz	17.74	500	Complies
	5825 MHz	17.74	500	Complies
802.11ac MCS0/Nss1 VHT40	5755 MHz	29.33	500	Complies
	5795 MHz	36.17	500	Complies
802.11ac MCS0/Nss1 VHT80	5775 MHz	76.52	500	Complies

Temperature	25°C	Humidity	50%
Test Engineer	Eddie Weng & Lucas Huang		
Test Mode	Mode 4: EUT 1 + Set 4 Sector Antenna / 7.5 dBi		

Mode	Frequency	6dB Bandwidth (MHz)	Min. Limit (kHz)	Test Result
802.11ac MCS0/Nss1 VHT20	5745 MHz	17.74	500	Complies
	5785 MHz	17.74	500	Complies
	5825 MHz	17.74	500	Complies
802.11ac MCS0/Nss1 VHT40	5755 MHz	34.55	500	Complies
	5795 MHz	30.84	500	Complies
802.11ac MCS0/Nss1 VHT80	5775 MHz	72.46	500	Complies

Temperature	25°C	Humidity	50%
Test Engineer	Eddie Weng & Lucas Huang		
Test Mode	Mode 5: EUT 1 + Set 5 Sector Antenna / 4.5 dBi		

Mode	Frequency	6dB Bandwidth (MHz)	Min. Limit (kHz)	Test Result
802.11ac MCS0/Nss1 VHT20	5745 MHz	17.74	500	Complies
	5785 MHz	17.74	500	Complies
	5825 MHz	17.74	500	Complies
802.11ac MCS0/Nss1 VHT40	5755 MHz	31.88	500	Complies
	5795 MHz	36.17	500	Complies
802.11ac MCS0/Nss1 VHT80	5775 MHz	75.65	500	Complies

Temperature	25°C	Humidity	50%
Test Engineer	Eddie Weng & Lucas Huang		
Test Mode	Mode 6: EUT 1 + Set 6 Sector Antenna / 4 dBi		

Mode	Frequency	6dB Bandwidth (MHz)	Min. Limit (kHz)	Test Result
802.11ac MCS0/Nss1 VHT20	5745 MHz	17.68	500	Complies
	5785 MHz	17.74	500	Complies
	5825 MHz	17.74	500	Complies
802.11ac MCS0/Nss1 VHT40	5755 MHz	29.33	500	Complies
	5795 MHz	36.17	500	Complies
802.11ac MCS0/Nss1 VHT80	5775 MHz	75.94	500	Complies

Temperature	25°C	Humidity	50%
Test Engineer	Eddie Weng & Lucas Huang		
Test Mode	Mode 7: EUT 1 + Set 9 Dipole Antenna / 4.67 dBi		

Mode	Frequency	6dB Bandwidth (MHz)	Min. Limit (kHz)	Test Result
802.11ac MCS0/Nss1 VHT20	5745 MHz	17.80	500	Complies
	5785 MHz	17.74	500	Complies
	5825 MHz	17.80	500	Complies
802.11ac MCS0/Nss1 VHT40	5755 MHz	35.59	500	Complies
	5795 MHz	36.17	500	Complies
802.11ac MCS0/Nss1 VHT80	5775 MHz	76.52	500	Complies

Temperature	25°C	Humidity	50%
Test Engineer	Eddie Weng & Lucas Huang		
Test Mode	Mode 8: EUT 2 + Set 10 PIFA Antenna / Chain1:5.84 dBi, Chain2:5.50 dBi, Chain3:5.84 dBi, Chain4:5.65 dBi		

Mode	Frequency	6dB Bandwidth (MHz)	Min. Limit (kHz)	Test Result
802.11ac MCS0/Nss1 VHT20	5745 MHz	16.35	500	Complies
	5785 MHz	15.01	500	Complies
	5825 MHz	12.58	500	Complies
802.11ac MCS0/Nss1 VHT40	5755 MHz	25.16	500	Complies
	5795 MHz	31.42	500	Complies
802.11ac MCS0/Nss1 VHT80	5775 MHz	71.30	500	Complies

Note: All the test values were listed in the report.

For plots, only the channel with worse result was shown.

Mode 1: EUT 1 + Set 1 Ceiling Mount Omni Antenna / 7 dBi

6 dB Bandwidth Plot on Configuration IEEE 802.11ac MCS0/Nss1 VHT20 / Chain 1 + Chain 2 + Chain 3 + Chain 4 / 5785 MHz

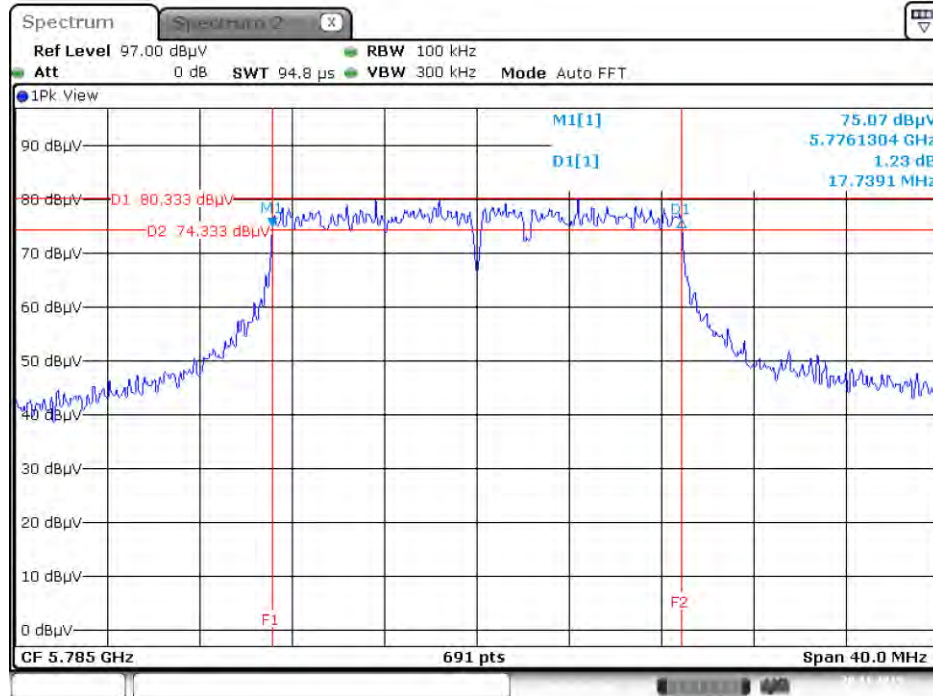

Date: 28 NOV. 2015 15:16:05

6 dB Bandwidth Plot on Configuration IEEE 802.11ac MCS0/Nss1 VHT40 / Chain 1 + Chain 2 + Chain 3 + Chain 4 / 5755 MHz

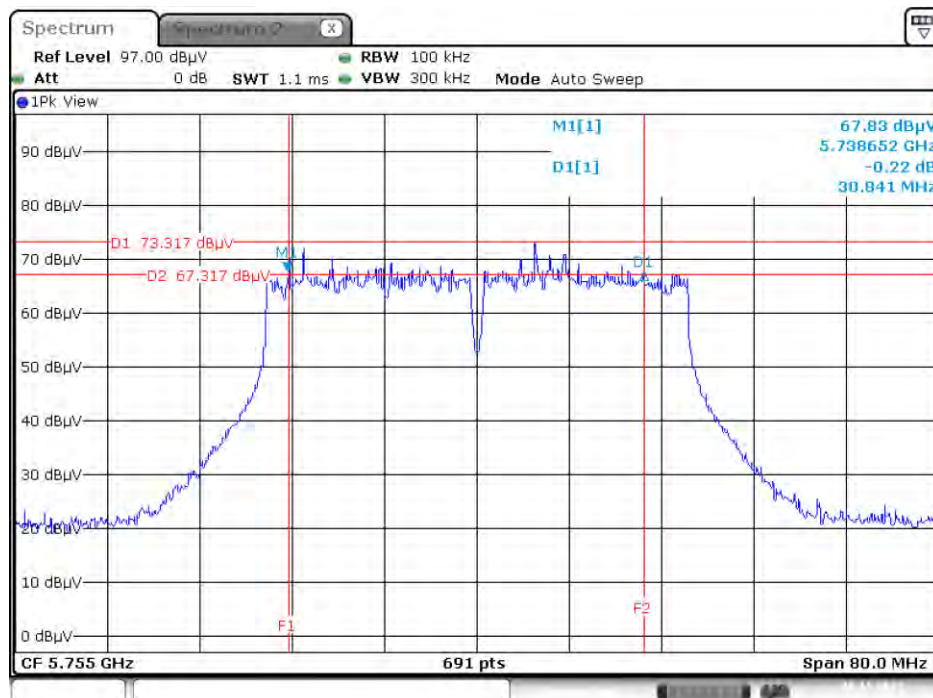

Date: 28 NOV. 2015 15:59:23

6 dB Bandwidth Plot on Configuration IEEE 802.11ac MCS0/Nss1 VHT80 / Chain 1 + Chain 2 + Chain 3 + Chain 4 / 5775 MHz

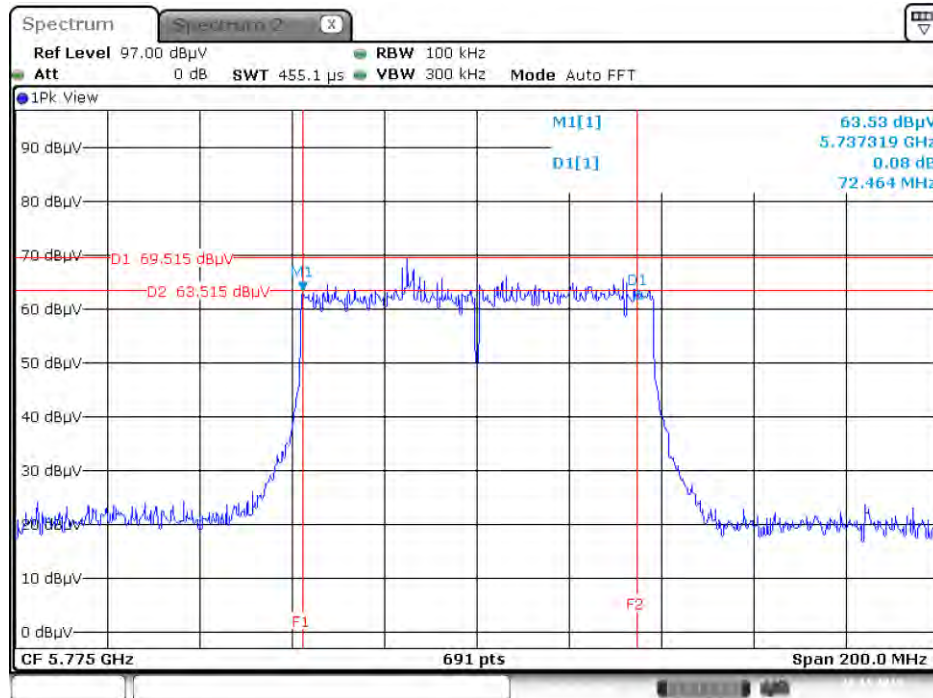

Date: 28.NOV.2015 15:13:06

Mode 2: EUT 1 + Set 2 Sector Antenna / 6.5 dBi

6 dB Bandwidth Plot on Configuration IEEE 802.11ac MCS0/Nss1 VHT20 / Chain 1 + Chain 2 + Chain 3 + Chain 4 / 5745 MHz

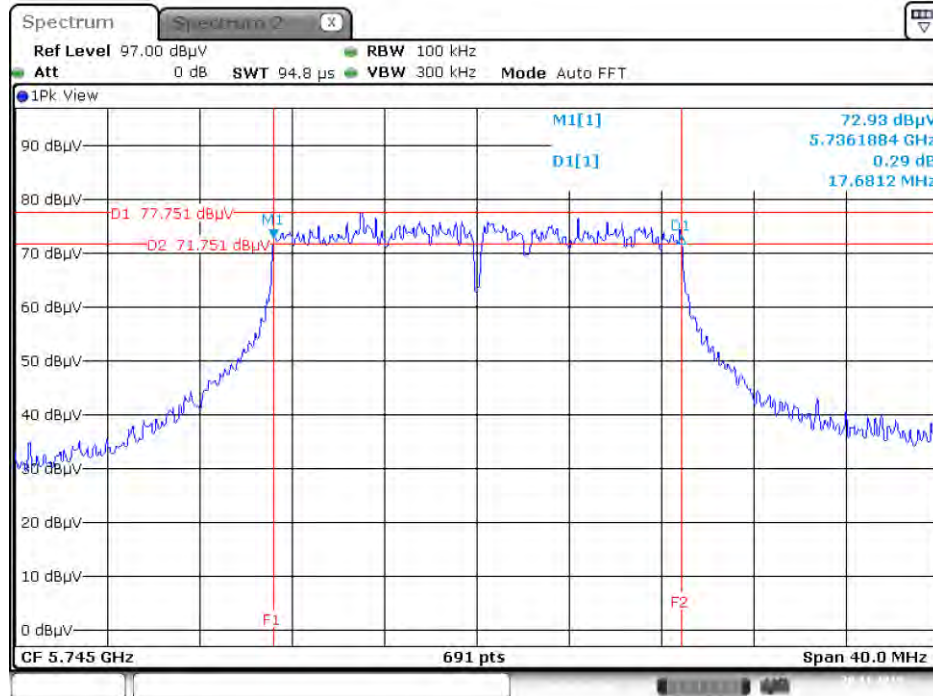

Date: 28 NOV. 2015 14:41:49

6 dB Bandwidth Plot on Configuration IEEE 802.11ac MCS0/Nss1 VHT40 / Chain 1 + Chain 2 + Chain 3 + Chain 4 / 5755 MHz

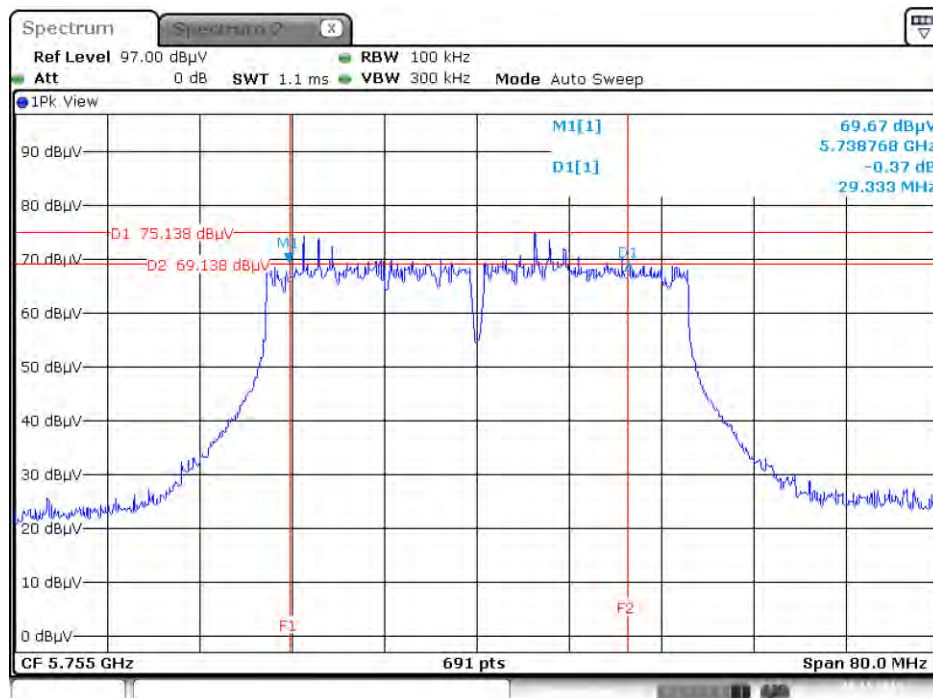

Date: 28 NOV. 2015 14:44:04

6 dB Bandwidth Plot on Configuration IEEE 802.11ac MCS0/Nss1 VHT80 / Chain 1 + Chain 2 + Chain 3 + Chain 4 / 5775 MHz

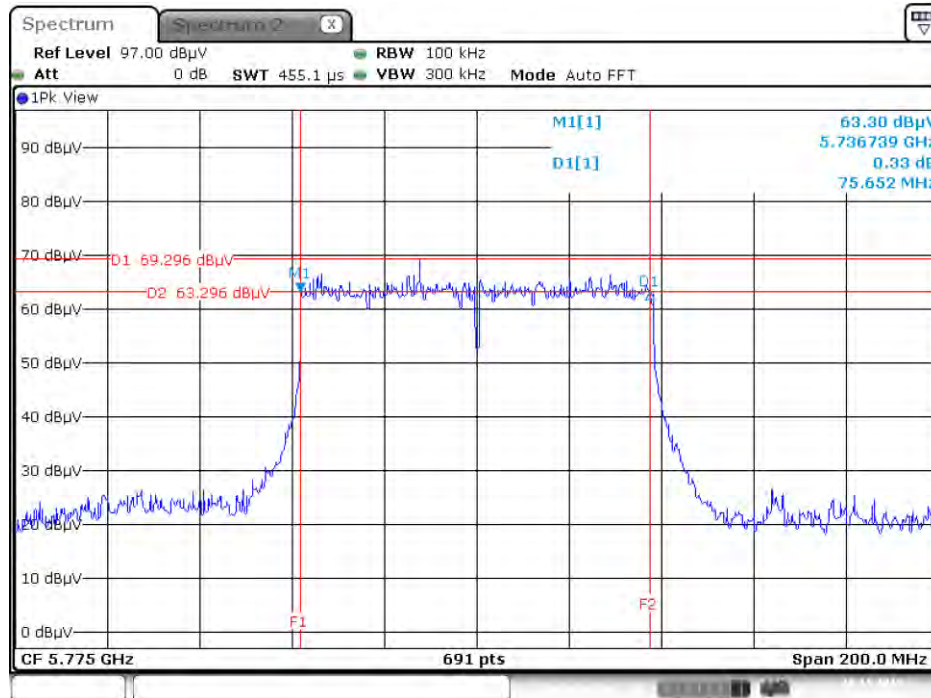

Date: 28.NOV.2015 14:45:29

Mode 3: EUT 1 + Set 3 Sector Antenna / 5.5 dBi

6 dB Bandwidth Plot on Configuration IEEE 802.11ac MCS0/Nss1 VHT20 / Chain 1 + Chain 2 + Chain 3 + Chain 4 / 5785 MHz

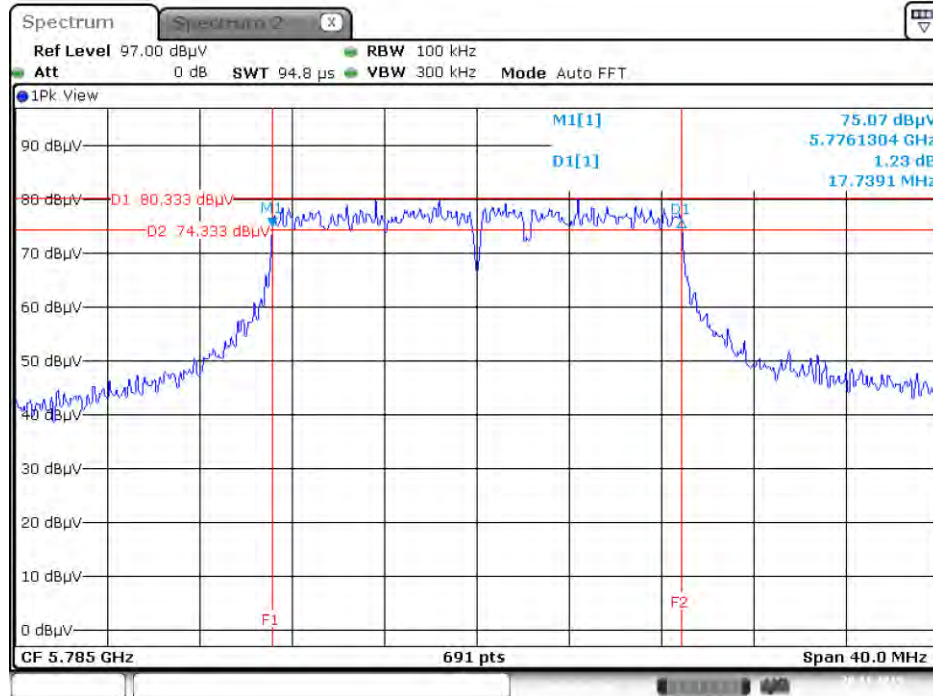

Date: 28 NOV. 2015 15:16:05

6 dB Bandwidth Plot on Configuration IEEE 802.11ac MCS0/Nss1 VHT40 / Chain 1 + Chain 2 + Chain 3 + Chain 4 / 5755 MHz

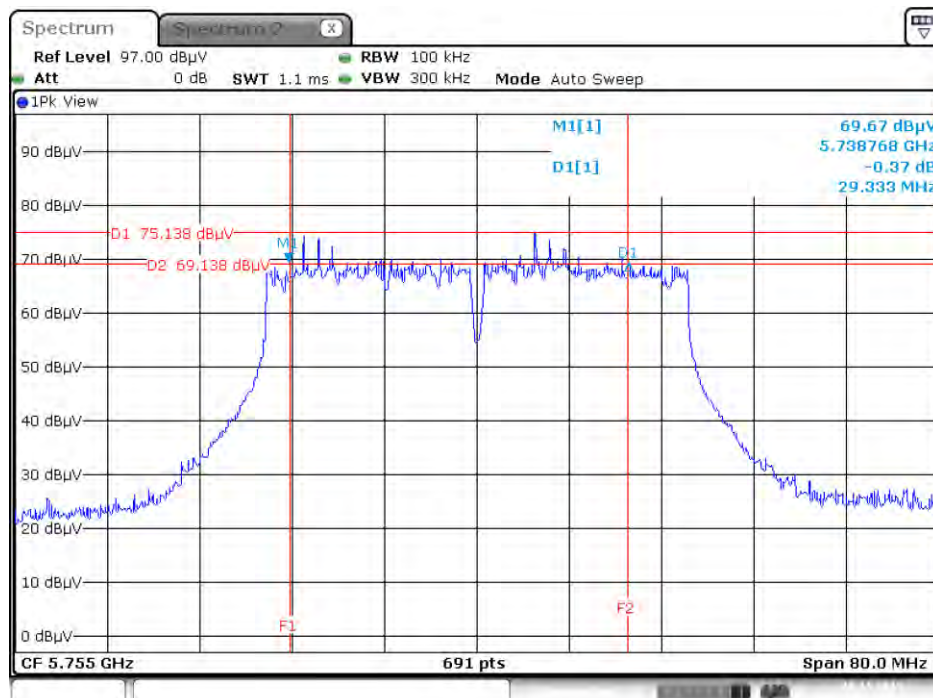

Date: 28 NOV. 2015 14:44:04

6 dB Bandwidth Plot on Configuration IEEE 802.11ac MCS0/Nss1 VHT80 / Chain 1 + Chain 2 + Chain 3 + Chain 4 / 5775 MHz

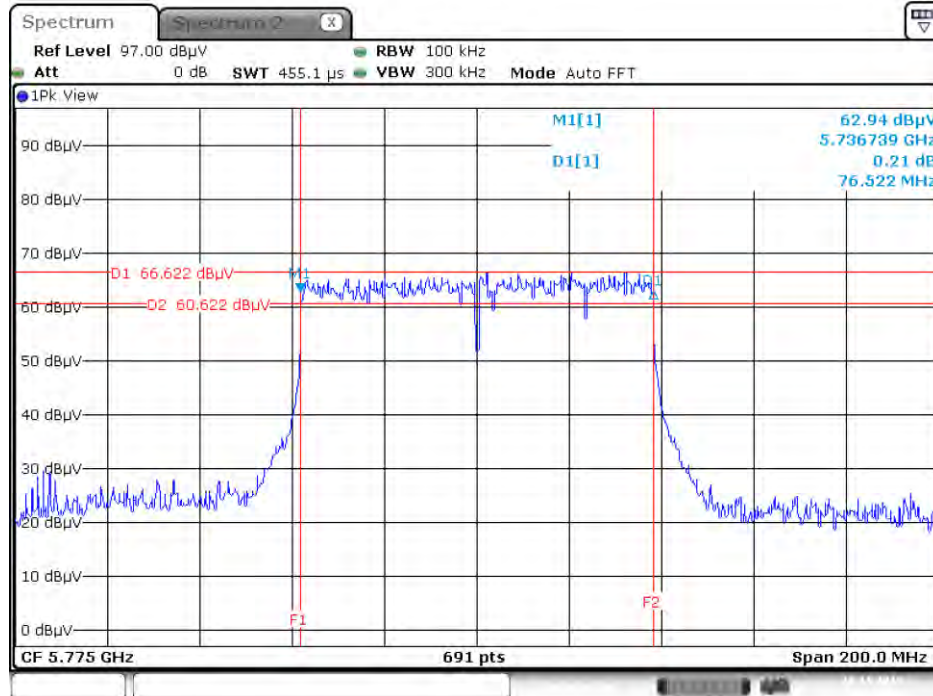

Date: 28.NOV.2015 14:24:19

Mode 4: EUT 1 + Set 4 Sector Antenna / 7.5 dBi

6 dB Bandwidth Plot on Configuration IEEE 802.11ac MCS0/Nss1 VHT20 / Chain 1 + Chain 2 + Chain 3 + Chain 4 / 5745 MHz

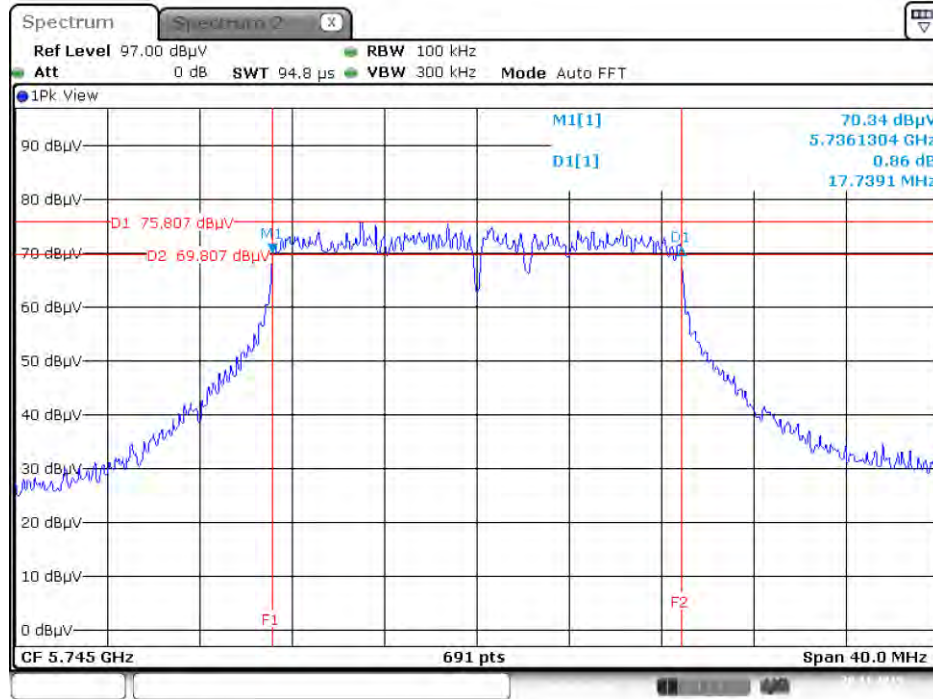

Date: 28 NOV. 2015 15:15:38

6 dB Bandwidth Plot on Configuration IEEE 802.11ac MCS0/Nss1 VHT40 / Chain 1 + Chain 2 + Chain 3 + Chain 4 / 5795 MHz

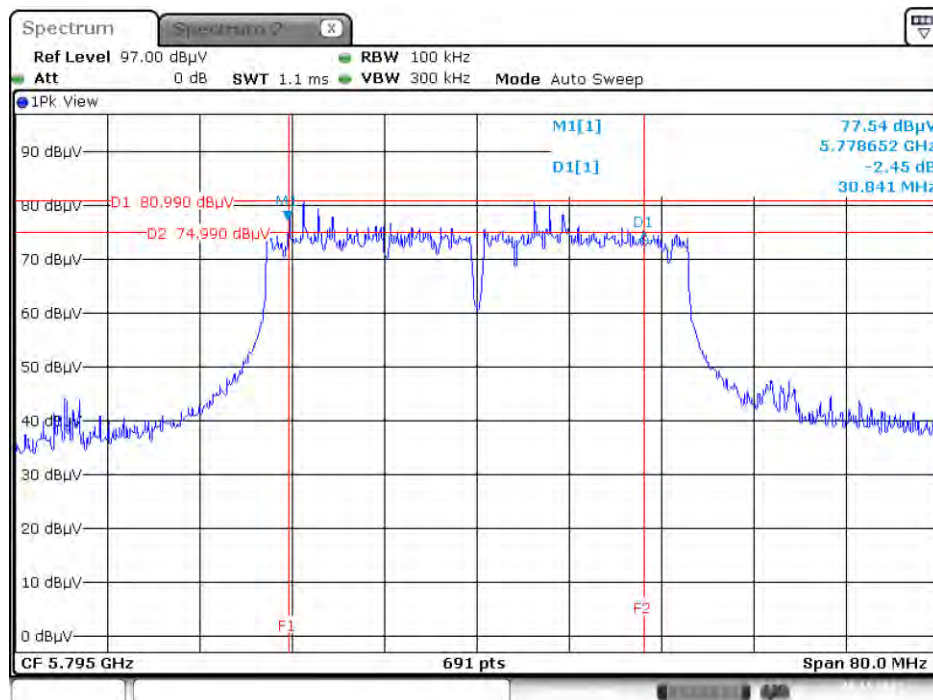

Date: 28 NOV. 2015 15:14:03

6 dB Bandwidth Plot on Configuration IEEE 802.11ac MCS0/Nss1 VHT80 / Chain 1 + Chain 2 + Chain 3 + Chain 4 / 5775 MHz

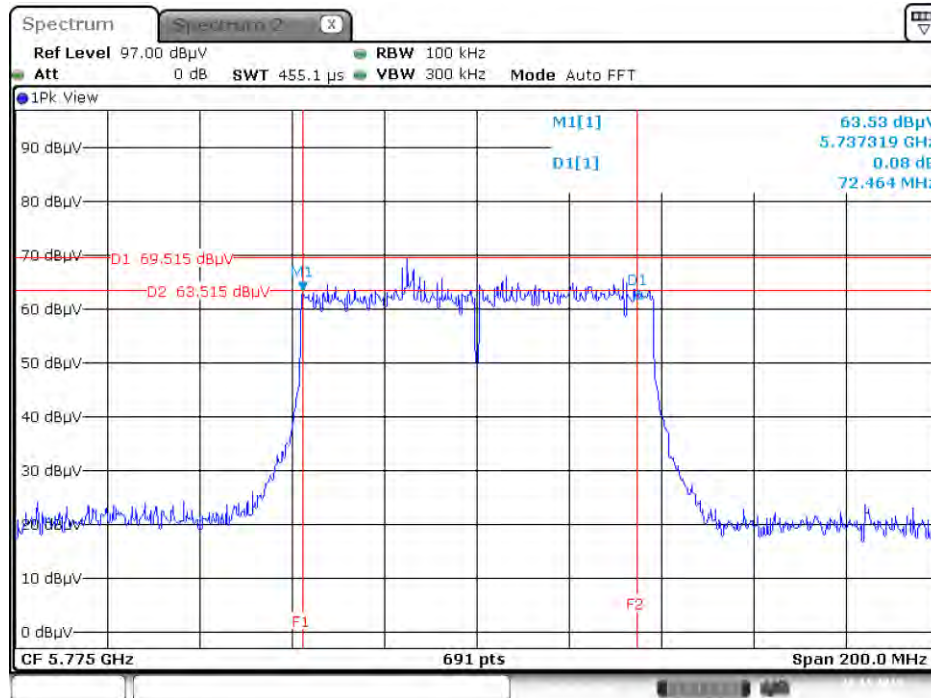

Date: 28.NOV.2015 15:13:06

Mode 5: EUT 1 + Set 5 Sector Antenna / 4.5 dBi

6 dB Bandwidth Plot on Configuration IEEE 802.11ac MCS0/Nss1 VHT20 / Chain 1 + Chain 2 + Chain 3 + Chain 4 / 5745 MHz

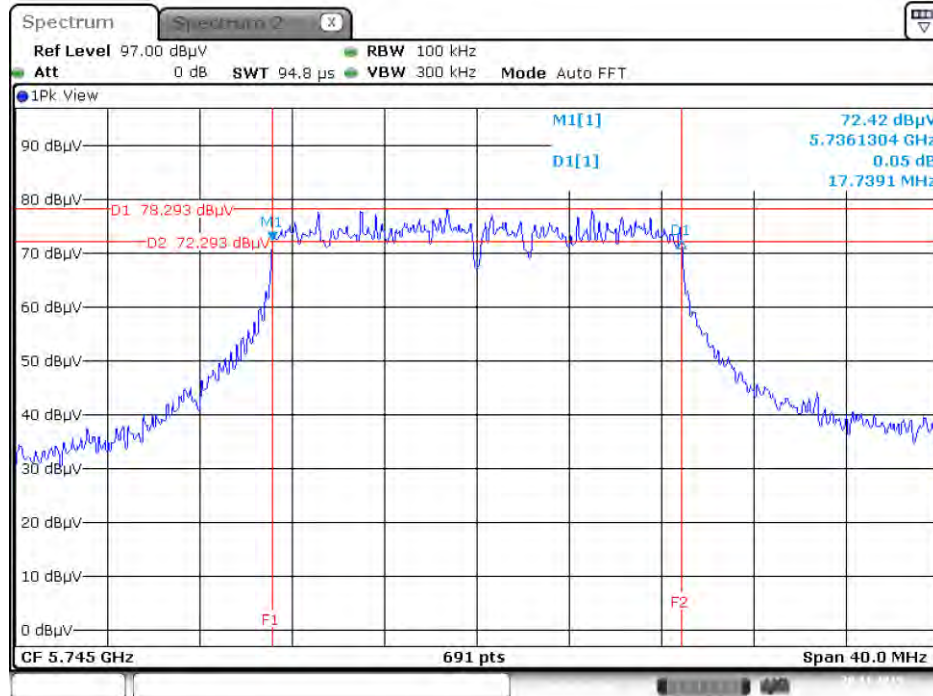

Date: 28 NOV. 2015 15:07:35

6 dB Bandwidth Plot on Configuration IEEE 802.11ac MCS0/Nss1 VHT40 / Chain 1 + Chain 2 + Chain 3 + Chain 4 / 5755 MHz

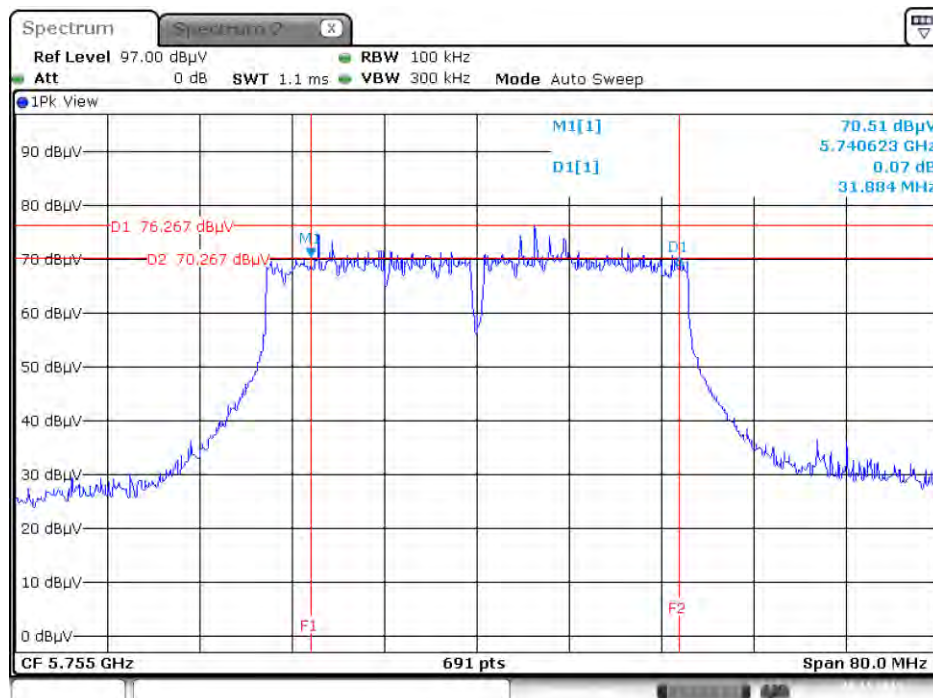

Date: 28 NOV. 2015 15:09:18

6 dB Bandwidth Plot on Configuration IEEE 802.11ac MCS0/Nss1 VHT80 / Chain 1 + Chain 2 + Chain 3 + Chain 4 / 5775 MHz

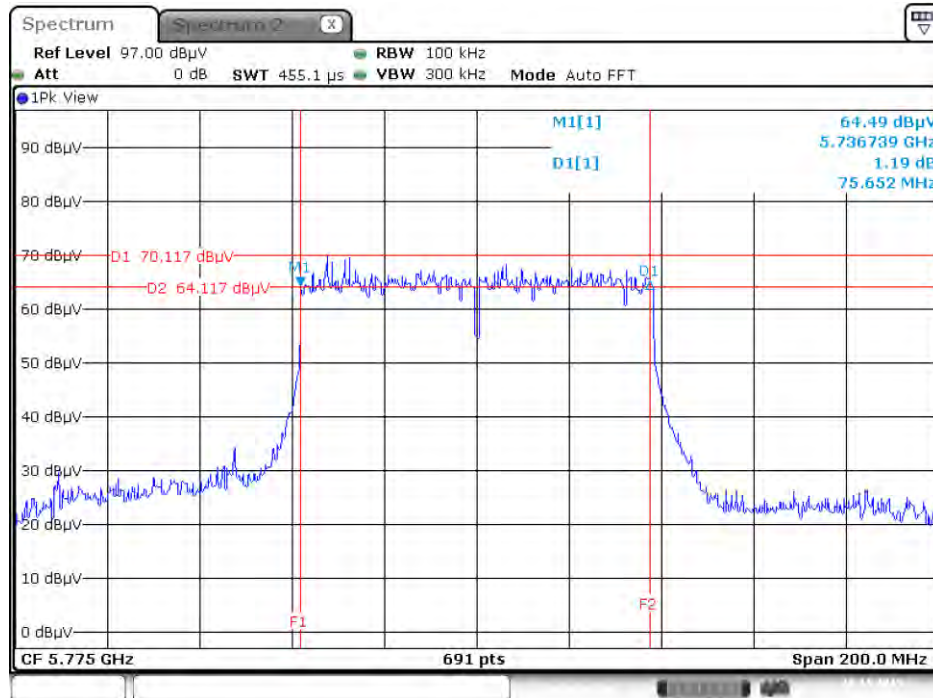

Date: 28.NOV.2015 15:10:31

Mode 6: EUT 1 + Set 6 Sector Antenna / 4 dBi

6 dB Bandwidth Plot on Configuration IEEE 802.11ac MCS0/Nss1 VHT20 / Chain 1 + Chain 2 + Chain 3 + Chain 4 / 5745 MHz

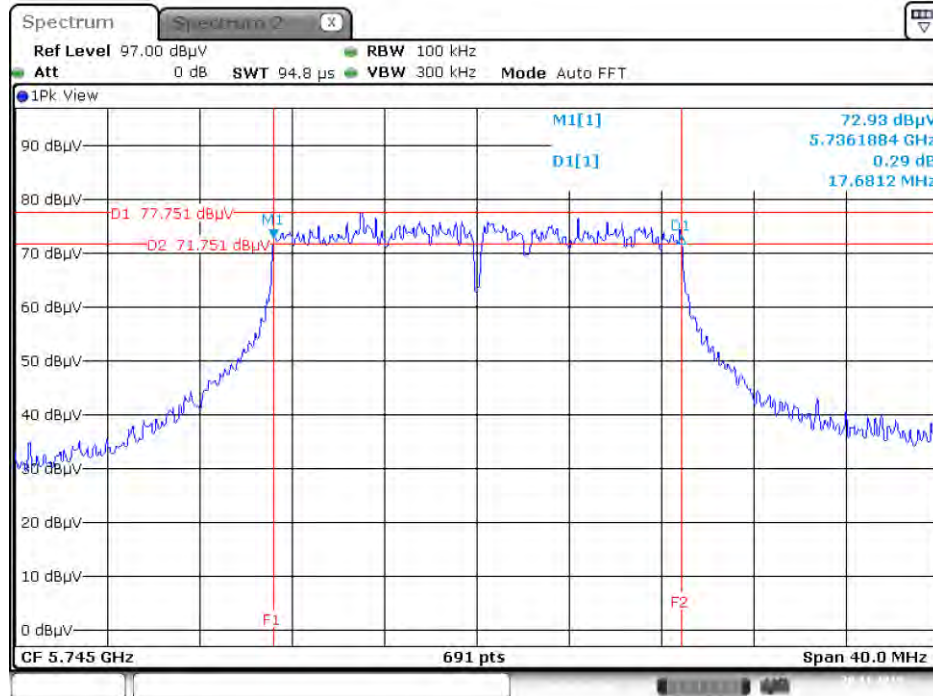

Date: 28 NOV. 2015 14:41:49

6 dB Bandwidth Plot on Configuration IEEE 802.11ac MCS0/Nss1 VHT40 / Chain 1 + Chain 2 + Chain 3 + Chain 4 / 5755 MHz

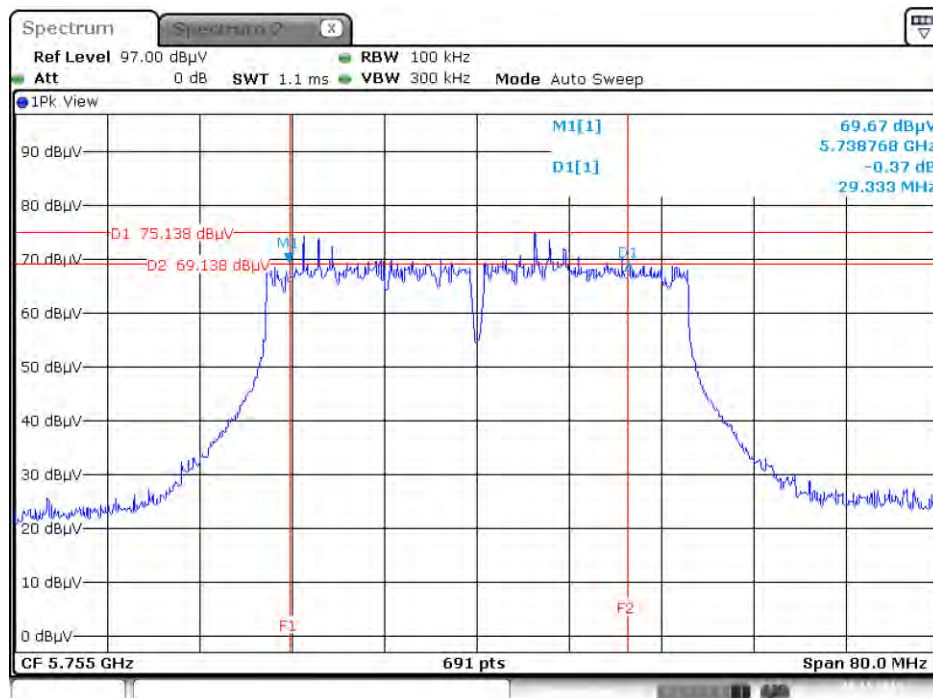

Date: 28 NOV. 2015 14:44:04

6 dB Bandwidth Plot on Configuration IEEE 802.11ac MCS0/Nss1 VHT80 / Chain 1 + Chain 2 + Chain 3 + Chain 4 / 5775 MHz

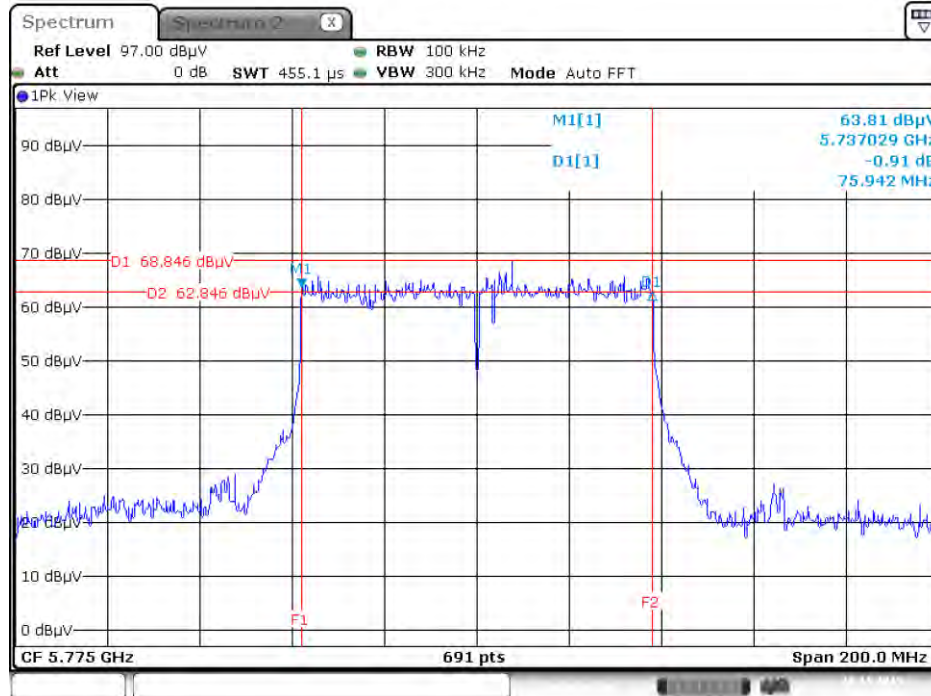

Date: 28.NOV.2015 14:26:08

Mode 7: EUT 1 + Set 9 Dipole Antenna / 4.67 dBi

6 dB Bandwidth Plot on Configuration IEEE 802.11ac MCS0/Nss1 VHT20 / Chain 1 + Chain 2 + Chain 3 + Chain 4 / 5785 MHz

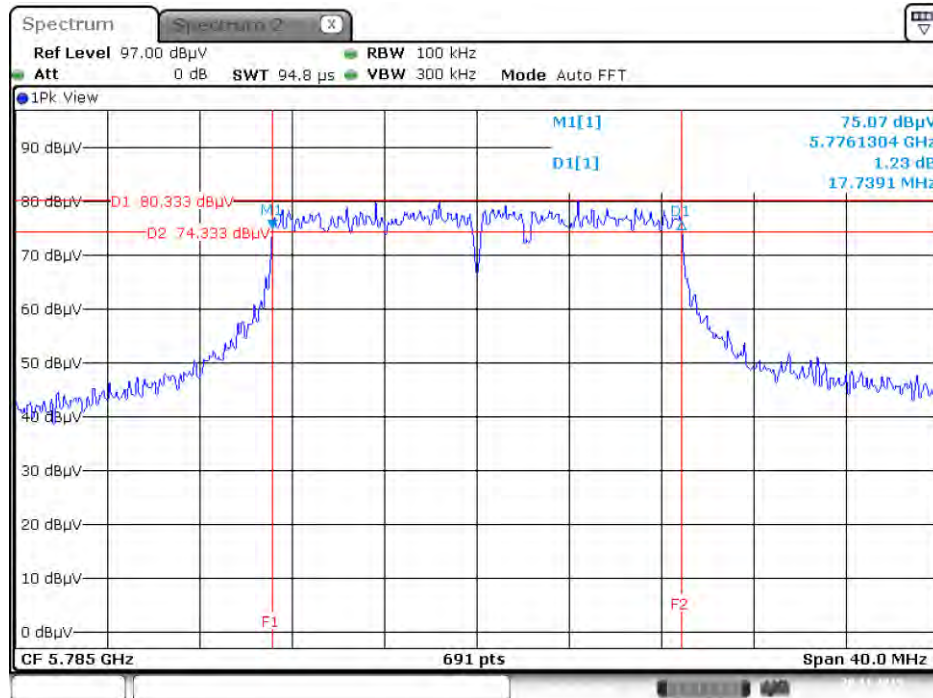

Date: 28 NOV. 2015 15:16:05

6 dB Bandwidth Plot on Configuration IEEE 802.11ac MCS0/Nss1 VHT40 / Chain 1 + Chain 2 + Chain 3 + Chain 4 / 5755 MHz

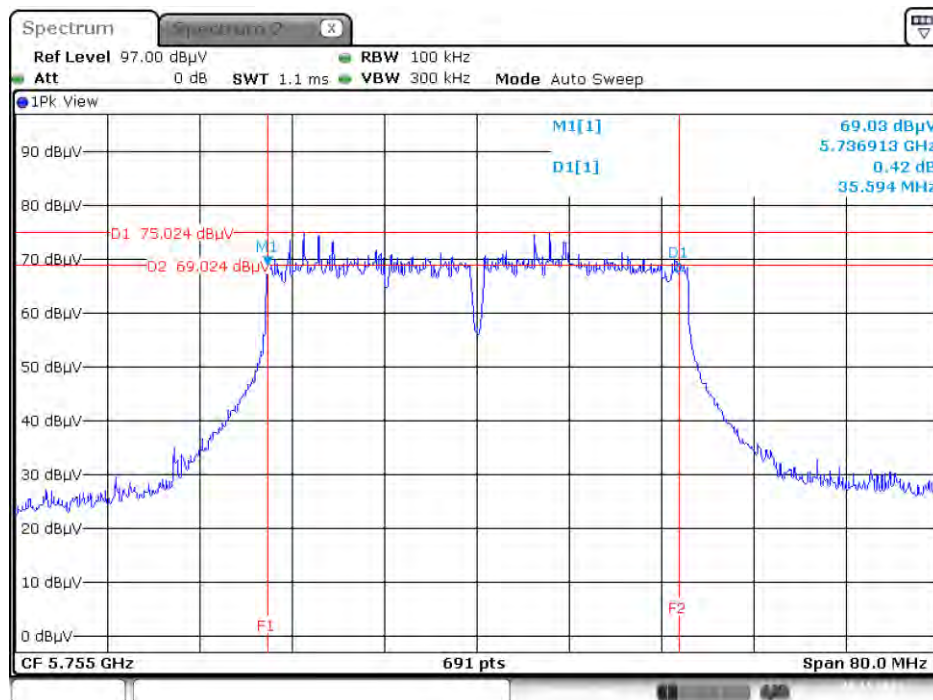

Date: 28 NOV. 2015 15:52:57

6 dB Bandwidth Plot on Configuration IEEE 802.11ac MCS0/Nss1 VHT80 / Chain 1 + Chain 2 + Chain 3 + Chain 4 / 5775 MHz

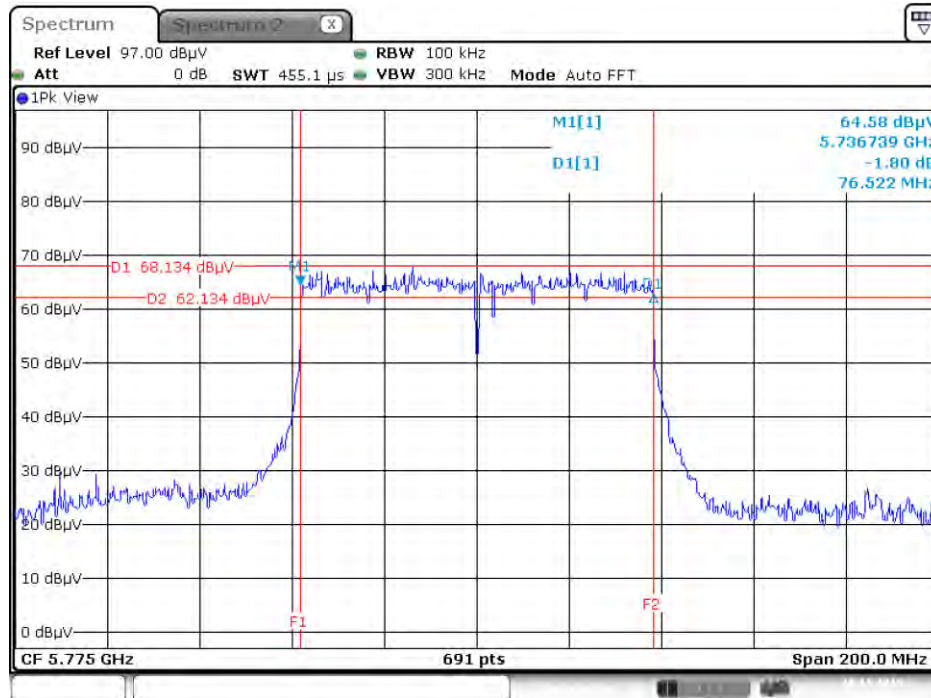

Date: 28.NOV.2015 15:53:52

Mode 8: EUT 2 + Set 10 PIFA Antenna / Chain1:5.84 dBi, Chain2:5.50 dBi, Chain3:5.84 dBi, Chain4:5.65 dBi

6 dB Bandwidth Plot on Configuration IEEE 802.11ac MCS0/Nss1 VHT20 / Chain 1 + Chain 2 + Chain 3 + Chain 4 / 5825 MHz

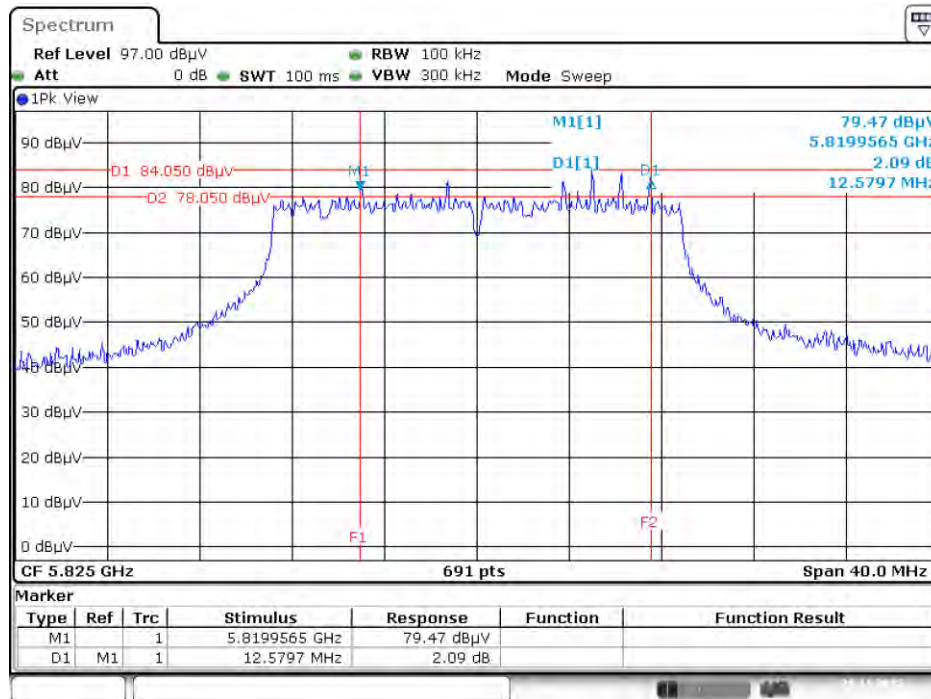

Date: 28.NOV.2015 22:57:48

6 dB Bandwidth Plot on Configuration IEEE 802.11ac MCS0/Nss1 VHT40 / Chain 1 + Chain 2 + Chain 3 + Chain 4 / 5755 MHz

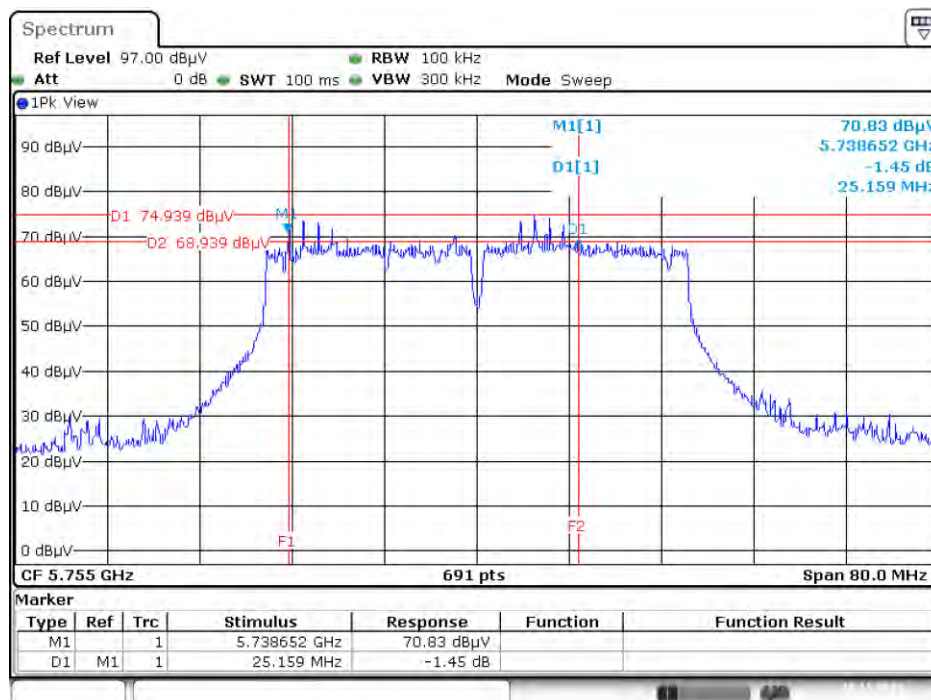

Date: 28.NOV.2015 22:52:11

6 dB Bandwidth Plot on Configuration IEEE 802.11ac MCS0/Nss1 VHT80 / Chain 1 + Chain 2 + Chain 3 + Chain 4 / 5775 MHz

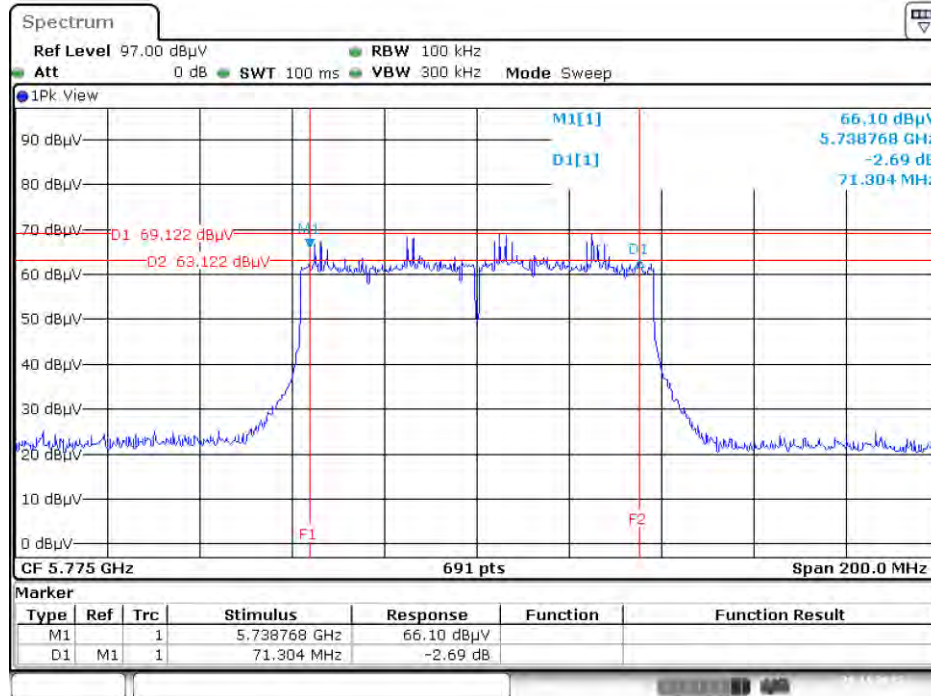

Date: 28.NOV.2015 22:50:21

4.4. Maximum Conducted Output Power Measurement

4.4.1. Limit

Frequency Band	Limit
<input checked="" type="checkbox"/> 5.15~5.25 GHz	
Operating Mode	
<input type="checkbox"/> Outdoor access point	<p>The maximum conducted output power over the frequency band of operation shall not exceed 1 W (30dBm) provided the maximum antenna gain does not exceed 6 dBi. If transmitting antennas of directional gain greater than 6 dBi are used, both the maximum conducted output power and the maximum power spectral density shall be reduced by the amount in dB that the directional gain of the antenna exceeds 6 dBi. The maximum e.i.r.p. at any elevation angle above 30 degrees as measured from the horizon must not exceed 125 mW (21 dBm).</p>
<input checked="" type="checkbox"/> Indoor access point	<p>The maximum conducted output power over the frequency band of operation shall not exceed 1 W (30dBm) provided the maximum antenna gain does not exceed 6 dBi. If transmitting antennas of directional gain greater than 6 dBi are used, both the maximum conducted output power and the maximum power spectral density shall be reduced by the amount in dB that the directional gain of the antenna exceeds 6 dBi.</p>
<input type="checkbox"/> Fixed point-to-point access points	<p>The maximum conducted output power over the frequency band of operation shall not exceed 1 W (30dBm). Fixed point-to-point U-NII devices may employ antennas with directional gain up to 23 dBi without any corresponding reduction in the maximum conducted output power or maximum power spectral density. For fixed point-to-point transmitters that employ a directional antenna gain greater than 23 dBi, a 1 dB reduction in maximum conducted output power and maximum power spectral density is required for each 1 dB of antenna gain in excess of 23 dBi.</p>
<input type="checkbox"/> Mobile and portable client devices	<p>The maximum conducted output power over the frequency band of operation shall not exceed 250 mW (24dBm) provided the maximum antenna gain does not exceed 6 dBi. If transmitting antennas of directional gain greater than 6 dBi are used, both the maximum conducted output power and the maximum power spectral density shall be reduced by the amount in dB that the directional gain of the antenna exceeds 6 dBi.</p>

☒	5.725~5.85 GHz	<p>The maximum conducted output power over the frequency band of operation shall not exceed 1 W (30dBm). If transmitting antennas of directional gain greater than 6 dBi are used, both the maximum conducted output power and the maximum power spectral density shall be reduced by the amount in dB that the directional gain of the antenna exceeds 6 dBi. However, fixed point-to-point U-NII devices operating in this band may employ transmitting antennas with directional gain greater than 6 dBi without any corresponding reduction in transmitter conducted power.</p>
---	----------------	---

4.4.2. Measuring Instruments and Setting

Please refer to section 5 of equipments list in this report. The following table is the setting of the power meter.

Power Meter Parameter	Setting
Detector	AVERAGE

4.4.3. Test Procedures

1. The transmitter output (antenna port) was connected to the power meter.
2. Test was performed in accordance with KDB789033 D02 v01 for Compliance Testing of Unlicensed National Information Infrastructure (U-NII) Devices - section (E) Maximum conducted output power =>3. Measurement using a Power Meter (PM) =>b) Method PM-G (Measurement using a gated RF average power meter).
3. Multiple antenna systems was performed in accordance with KDB662911 D01 v02r01 Emissions Testing of Transmitters with Multiple Outputs in the Same Band.
4. When measuring maximum conducted output power with multiple antenna systems, add every result of the values by mathematic formula.

4.4.4. Test Setup Layout

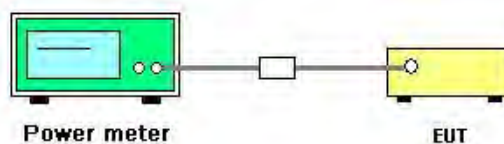

4.4.5. Test Deviation

There is no deviation with the original standard.

4.4.6. EUT Operation during Test

The EUT was programmed to be in continuously transmitting mode.

4.4.7. Test Result of Maximum Conducted Output Power

Temperature	25°C	Humidity	50%
Test Engineer	Eddie Weng & Lucas Huang	Test Date	Nov. 28, 2015
Test Mode	Mode 1: EUT 1 + Set 1 Ceiling Mount Omni Antenna / 7 dBi		

Mode	Frequency	Conducted Power (dBm)					Max. Limit (dBm)	Result
		Chain 1	Chain 2	Chain 3	Chain 4	Total		
802.11ac MCS0/Nss1 VHT20	5180 MHz	14.73	15.35	15.36	16.13	21.44	25.99	Complies
	5200 MHz	18.24	18.13	17.34	17.74	23.90	25.99	Complies
	5240 MHz	18.32	18.16	17.70	17.86	24.04	25.99	Complies
	5745 MHz	13.04	13.17	13.45	13.29	19.26	25.99	Complies
	5785 MHz	17.84	17.33	17.29	17.54	23.53	25.99	Complies
	5825 MHz	15.82	15.85	16.32	16.09	22.05	25.99	Complies
802.11ac MCS0/Nss1 VHT40	5190 MHz	9.55	9.76	10.21	10.43	16.02	25.99	Complies
	5230 MHz	18.89	18.95	18.39	18.61	24.74	25.99	Complies
	5755 MHz	9.63	9.58	9.96	9.58	15.71	25.99	Complies
	5795 MHz	15.04	14.91	15.42	15.01	21.12	25.99	Complies
802.11ac MCS0/Nss1 VHT80	5210 MHz	6.67	6.84	7.06	7.35	13.01	25.99	Complies
	5775 MHz	8.79	8.25	9.41	9.03	14.91	25.99	Complies

Note: $DirectionalGain = 10 \cdot \log \left[\frac{\sum_{j=1}^{N_{SS}} \left\{ \sum_{k=1}^{N_{ANT}} g_{j,k} \right\}^2}{N_{ANT}} \right] = 10.01 \text{ dBi} > 6 \text{ dBi}$, So Limit = 30 - (10.01 - 6) = 25.99 dBm.

Temperature	25°C	Humidity	50%
Test Engineer	Eddie Weng & Lucas Huang	Test Date	Nov. 28, 2015
Test Mode	Mode 2: EUT 1 + Set 2 Sector Antenna / 6.5 dBi		

Mode	Frequency	Conducted Power (dBm)					Max. Limit (dBm)	Result
		Chain 1	Chain 2	Chain 3	Chain 4	Total		
802.11ac MCS0/Nss1 VHT20	5180 MHz	14.64	14.70	14.75	14.27	20.61	26.49	Complies
	5200 MHz	18.24	18.13	17.34	17.74	23.90	26.49	Complies
	5240 MHz	18.32	18.16	17.70	17.86	24.04	26.49	Complies
	5745 MHz	14.66	14.46	14.44	14.36	20.50	26.49	Complies
	5785 MHz	17.84	17.33	17.29	17.54	23.53	26.49	Complies
	5825 MHz	16.93	16.63	16.39	16.55	22.65	26.49	Complies
802.11ac MCS0/Nss1 VHT40	5190 MHz	10.02	10.25	10.63	10.77	16.45	26.49	Complies
	5230 MHz	18.89	18.95	18.39	18.61	24.74	26.49	Complies
	5755 MHz	10.79	11.23	11.52	11.14	17.20	26.49	Complies
	5795 MHz	16.66	16.25	16.89	16.58	22.62	26.49	Complies
802.11ac MCS0/Nss1 VHT80	5210 MHz	6.67	6.84	7.06	7.35	13.01	26.49	Complies
	5775 MHz	9.04	8.47	9.84	10.20	15.46	26.49	Complies

Note: $DirectionalGain = 10 \cdot \log \left[\frac{\sum_{j=1}^{N_{SS}} \left\{ \sum_{k=1}^{N_{ANT}} g_{j,k} \right\}^2}{N_{ANT}} \right] = 9.51 \text{ dBi} > 6 \text{ dBi}$, So Limit = $30 - (9.51 - 6) = 26.49 \text{ dBm}$.

Temperature	25°C	Humidity	50%
Test Engineer	Eddie Weng & Lucas Huang	Test Date	Nov. 28, 2015
Test Mode	Mode 3: EUT 1 + Set 3 Sector Antenna / 5.5 dBi		

Mode	Frequency	Conducted Power (dBm)					Max. Limit (dBm)	Result
		Chain 1	Chain 2	Chain 3	Chain 4	Total		
802.11ac MCS0/Nss1 VHT20	5180 MHz	16.94	17.93	16.97	17.78	23.45	27.49	Complies
	5200 MHz	18.24	18.13	17.34	17.74	23.90	27.49	Complies
	5240 MHz	18.32	18.16	17.70	17.86	24.04	27.49	Complies
	5745 MHz	14.83	15.22	15.64	15.23	21.26	27.49	Complies
	5785 MHz	17.84	17.33	17.29	17.54	23.53	27.49	Complies
	5825 MHz	16.93	16.63	16.39	16.55	22.65	27.49	Complies
802.11ac MCS0/Nss1 VHT40	5190 MHz	11.85	11.93	11.58	11.67	17.78	27.49	Complies
	5230 MHz	18.89	18.95	18.39	18.61	24.74	27.49	Complies
	5755 MHz	10.79	11.23	11.52	11.14	17.20	27.49	Complies
	5795 MHz	17.45	17.73	18.06	18.21	23.89	27.49	Complies
802.11ac MCS0/Nss1 VHT80	5210 MHz	8.02	8.17	8.41	8.56	14.32	27.49	Complies
	5775 MHz	10.02	10.91	10.93	11.42	16.87	27.49	Complies

Note: $DirectionalGain = 10 \cdot \log \left[\frac{\sum_{j=1}^{N_{SS}} \left\{ \sum_{k=1}^{N_{ANT}} g_{j,k} \right\}^2}{N_{ANT}} \right] = 8.51 \text{ dBi} > 6 \text{ dBi}$, So Limit = $30 - (8.51 - 6) = 27.49 \text{ dBm}$.

Temperature	25°C	Humidity	50%
Test Engineer	Eddie Weng & Lucas Huang	Test Date	Nov. 28, 2015
Test Mode	Mode 4: EUT 1 + Set 4 Sector Antenna / 7.5 dBi		

Mode	Frequency	Conducted Power (dBm)					Max. Limit (dBm)	Result
		Chain 1	Chain 2	Chain 3	Chain 4	Total		
802.11ac MCS0/Nss1 VHT20	5180 MHz	16.76	16.53	16.66	16.56	22.65	25.49	Complies
	5200 MHz	18.24	18.13	17.34	17.74	23.90	25.49	Complies
	5240 MHz	18.32	18.16	17.70	17.86	24.04	25.49	Complies
	5745 MHz	13.11	12.93	12.78	12.96	18.97	25.49	Complies
	5785 MHz	17.84	17.33	17.29	17.54	23.53	25.49	Complies
	5825 MHz	16.93	16.63	16.39	16.55	22.65	25.49	Complies
802.11ac MCS0/Nss1 VHT40	5190 MHz	10.77	10.85	10.75	10.85	16.83	25.49	Complies
	5230 MHz	18.89	18.95	18.39	18.61	24.74	25.49	Complies
	5755 MHz	10.27	10.87	11.03	10.69	16.74	25.49	Complies
	5795 MHz	16.52	16.21	17.52	17.72	23.06	25.49	Complies
802.11ac MCS0/Nss1 VHT80	5210 MHz	9.11	9.18	9.84	9.52	15.44	25.49	Complies
	5775 MHz	8.42	7.72	9.21	9.32	14.74	25.49	Complies

Note: $DirectionalGain = 10 \cdot \log \left[\frac{\sum_{j=1}^{N_{SS}} \left\{ \sum_{k=1}^{N_{ANT}} g_{j,k} \right\}^2}{N_{ANT}} \right] = 10.51 \text{dBi} > 6 \text{dBi}$, So Limit = $30 - (10.51 - 6) = 25.49 \text{dBm}$.

Temperature	25°C	Humidity	50%
Test Engineer	Eddie Weng & Lucas Huang	Test Date	Nov. 28, 2015
Test Mode	Mode 5: EUT 1 + Set 5 Sector Antenna / 4.5 dBi		

Mode	Frequency	Conducted Power (dBm)					Max. Limit (dBm)	Result
		Chain 1	Chain 2	Chain 3	Chain 4	Total		
802.11ac MCS0/Nss1 VHT20	5180 MHz	16.94	17.93	16.97	17.78	23.45	28.49	Complies
	5200 MHz	18.24	18.13	17.34	17.74	23.90	28.49	Complies
	5240 MHz	18.32	18.16	17.70	17.86	24.04	28.49	Complies
	5745 MHz	14.78	14.67	14.85	14.79	20.79	28.49	Complies
	5785 MHz	17.84	17.33	17.29	17.54	23.53	28.49	Complies
	5825 MHz	16.93	16.63	16.39	16.55	22.65	28.49	Complies
802.11ac MCS0/Nss1 VHT40	5190 MHz	14.83	15.78	15.23	15.34	21.33	28.49	Complies
	5230 MHz	18.89	18.95	18.39	18.61	24.74	28.49	Complies
	5755 MHz	11.52	13.04	12.86	12.42	18.52	28.49	Complies
	5795 MHz	17.45	17.73	18.06	18.21	23.89	28.49	Complies
802.11ac MCS0/Nss1 VHT80	5210 MHz	10.41	11.49	10.84	10.73	16.91	28.49	Complies
	5775 MHz	11.43	12.25	12.65	12.28	18.20	28.49	Complies

Note: $DirectionalGain = 10 \cdot \log \left[\frac{\sum_{j=1}^{N_{SS}} \left\{ \sum_{k=1}^{N_{ANT}} g_{j,k} \right\}^2}{N_{ANT}} \right] = 7.51 \text{ dBi} > 6 \text{ dBi}$, So Limit = $30 - (7.51 - 6) = 28.49 \text{ dBm}$.

Temperature	25°C	Humidity	50%
Test Engineer	Eddie Weng & Lucas Huang	Test Date	Nov. 28, 2015
Test Mode	Mode 6: EUT 1 + Set 6 Sector Antenna / 4 dBi		

Mode	Frequency	Conducted Power (dBm)					Max. Limit (dBm)	Result
		Chain 1	Chain 2	Chain 3	Chain 4	Total		
802.11ac MCS0/Nss1 VHT20	5180 MHz	14.73	15.35	15.36	16.13	21.44	28.99	Complies
	5200 MHz	18.24	18.13	17.34	17.74	23.90	28.99	Complies
	5240 MHz	18.32	18.16	17.70	17.86	24.04	28.99	Complies
	5745 MHz	14.66	14.46	14.44	14.36	20.50	28.99	Complies
	5785 MHz	17.84	17.33	17.29	17.54	23.53	28.99	Complies
	5825 MHz	16.93	16.63	16.39	16.55	22.65	28.99	Complies
802.11ac MCS0/Nss1 VHT40	5190 MHz	11.85	11.93	11.58	11.67	17.78	28.99	Complies
	5230 MHz	18.89	18.95	18.39	18.61	24.74	28.99	Complies
	5755 MHz	10.79	11.23	11.52	11.14	17.20	28.99	Complies
	5795 MHz	17.45	17.73	18.06	18.21	23.89	28.99	Complies
802.11ac MCS0/Nss1 VHT80	5210 MHz	9.41	10.32	9.76	9.77	15.85	28.99	Complies
	5775 MHz	8.91	8.36	9.73	9.89	15.29	28.99	Complies

Note: $DirectionalGain = 10 \cdot \log \left[\frac{\sum_{j=1}^{N_{SS}} \left\{ \sum_{k=1}^{N_{ANT}} g_{j,k} \right\}^2}{N_{ANT}} \right] = 7.01 \text{ dBi} > 6 \text{ dBi}$, So Limit = $30 - (7.01 - 6) = 28.99 \text{ dBm}$.

Temperature	25°C	Humidity	50%
Test Engineer	Eddie Weng & Lucas Huang	Test Date	Nov. 28, 2015
Test Mode	Mode 7: EUT 1 + Set 9 Dipole Antenna / 4.67 dBi		

Mode	Frequency	Conducted Power (dBm)					Max. Limit (dBm)	Result
		Chain 1	Chain 2	Chain 3	Chain 4	Total		
802.11ac MCS0/Nss1 VHT20	5180 MHz	16.94	17.93	16.97	17.78	23.45	25.31	Complies
	5200 MHz	18.24	18.13	17.34	17.74	23.90	25.31	Complies
	5240 MHz	18.32	18.16	17.70	17.86	24.04	25.31	Complies
	5745 MHz	14.83	15.22	15.64	15.23	21.26	25.31	Complies
	5785 MHz	17.84	17.33	17.29	17.54	23.53	25.31	Complies
	5825 MHz	18.02	18.15	17.96	18.30	24.13	25.31	Complies
802.11ac MCS0/Nss1 VHT40	5190 MHz	12.57	12.86	11.91	11.54	18.27	25.31	Complies
	5230 MHz	18.89	18.95	18.39	18.61	24.74	25.31	Complies
	5755 MHz	11.38	12.48	12.46	12.84	18.34	25.31	Complies
	5795 MHz	17.45	17.73	18.06	18.21	23.89	25.31	Complies
802.11ac MCS0/Nss1 VHT80	5210 MHz	8.39	8.42	8.93	9.05	14.73	25.31	Complies
	5775 MHz	11.07	11.29	11.57	11.32	17.34	25.31	Complies

Note: $DirectionalGain = 10 \cdot \log \left[\frac{\sum_{j=1}^{N_{SS}} \left\{ \sum_{k=1}^{N_{ANT}} g_{j,k} \right\}^2}{N_{ANT}} \right] = 10.69\text{dBi} > 6\text{dBi}$, So Limit = $30 - (10.69 - 6) = 25.31\text{dBm}$.

Temperature	25°C	Humidity	50%
Test Engineer	Eddie Weng & Lucas Huang	Test Date	Nov. 28, 2015
Test Mode	Mode 8: EUT 2 + Set 10 PIFA Antenna / Chain1:5.84 dBi, Chain2:5.50 dBi, Chain3:5.84 dBi, Chain4:5.65 dBi		

Mode	Frequency	Conducted Power (dBm)					Max. Limit (dBm)	Result
		Chain 1	Chain 2	Chain 3	Chain 4	Total		
802.11ac MCS0/Nss1 VHT20	5180 MHz	18.05	18.37	17.92	18.01	24.11	24.27	Complies
	5200 MHz	18.05	18.19	17.99	18.22	24.13	24.27	Complies
	5240 MHz	18.05	18.17	18.22	18.43	24.24	24.27	Complies
	5745 MHz	16.90	16.67	16.97	16.89	22.88	24.27	Complies
	5785 MHz	17.89	18.02	18.12	17.95	24.02	24.27	Complies
	5825 MHz	18.55	18.39	18.02	17.75	24.21	24.27	Complies
802.11ac MCS0/Nss1 VHT40	5190 MHz	15.79	15.81	15.93	15.74	21.84	24.27	Complies
	5230 MHz	17.91	17.97	17.85	18.18	24.00	24.27	Complies
	5755 MHz	12.06	11.89	12.28	11.94	18.07	24.27	Complies
	5795 MHz	18.33	18.21	18.18	18.22	24.26	24.27	Complies
802.11ac MCS0/Nss1 VHT80	5210 MHz	9.64	9.95	9.74	9.58	15.75	24.27	Complies
	5775 MHz	9.15	9.10	9.40	9.18	15.23	24.27	Complies

Note: $DirectionalGain = 10 \cdot \log \left[\frac{\sum_{j=1}^{N_{SS}} \left\{ \sum_{k=1}^{N_{ANT}} g_{j,k} \right\}^2}{N_{ANT}} \right] = 11.73 \text{dBi} > 6 \text{dBi}$, So Limit = $30 - (11.73 - 6) = 24.27 \text{dBm}$.