



SPORTON International Inc.

No. 52, Huaya 1st Rd., Guishan Dist., Taoyuan City, Taiwan (R.O.C.)
Ph: 886-3-327-3456 / FAX: 886-3-327-0973 / www.sporton.com.tw

FCC RADIO TEST REPORT

| | |
|------------------------|--|
| Applicant's company | Allied Telesis K.K |
| Applicant Address | 2nd. TOC Bldg. 7-21-11 Nishi-Gotanda, Shinagawa-ku, Tokyo Japan, 141-0031 |
| FCC ID | RSL-MWS2533AP |
| Manufacturer's company | Senao Networks, Inc. |
| Manufacturer Address | 3F, No. 529, Chung Cheng Rd., Hsintien, Taipei, Taiwan |

| | |
|-------------------|---|
| Product Name | IEEE 802.a/b/g/n/ac Managed Wireless Access Point |
| Brand Name |  |
| Model No. | AT-MWS2533AP |
| Test Rule Part(s) | 47 CFR FCC Part 15 Subpart C § 15.247 |
| Test Freq. Range | 2400 ~ 2483.5MHz |
| Received Date | Oct. 15, 2015 |
| Final Test Date | Aug. 15, 2017 |
| Submission Type | Original Equipment |

Statement

Test result included is only for the IEEE 802.11b/g, IEEE 802.11n and IEEE 802.11ac of the product.

The test result in this report refers exclusively to the presented test model / sample.

Without written approval of SPORTON International Inc., the test report shall not be reproduced except in full.

The measurements and test results shown in this test report were made in accordance with the procedures and found in compliance with the limit given in **ANSI C63.10-2013**,

47 CFR FCC Part 15 Subpart C, KDB558074 D01 v04 and KDB 662911 D01 v02r01, KDB644545 D03 v01.

The test equipment used to perform the test is calibrated and traceable to NML/ROC.





Table of Contents

1. VERIFICATION OF COMPLIANCE 1

2. SUMMARY OF THE TEST RESULT 2

3. GENERAL INFORMATION 3

3.1. Product Details3

3.2. Accessories5

3.3. Table for Filed Antenna6

3.4. Table for Carrier Frequencies8

3.5. Table for Test Modes9

3.6. Table for Testing Locations.....11

3.7. Table for Multiple Listing11

3.8. Table for Supporting Units12

3.9. Table for Parameters of Test Software Setting13

3.10. EUT Operation during Test15

3.11. Duty Cycle.....15

3.12. Test Configurations.....16

4. TEST RESULT 19

4.1. AC Power Line Conducted Emissions Measurement19

4.2. Maximum Conducted Output Power Measurement.....23

4.3. Power Spectral Density Measurement.....31

4.4. 6dB Spectrum Bandwidth Measurement68

4.5. Radiated Emissions Measurement.....91

4.6. Emissions Measurement.....140

4.7. Antenna Requirements198

5. LIST OF MEASURING EQUIPMENTS..... 199

6. MEASUREMENT UNCERTAINTY 201

APPENDIX A. TEST PHOTOS

APPENDIX B. RADIATED EMISSION CO-LOCATION REPORT

PHOTOGRAPHS OF EUT V01



History of This Test Report

| REPORT NO. | VERSION | DESCRIPTION | ISSUED DATE |
|---------------|---------|-------------------------|---------------|
| FR720735-01AC | Rev. 01 | Initial issue of report | Sep. 12, 2017 |
| | | | |
| | | | |
| | | | |
| | | | |
| | | | |
| | | | |
| | | | |
| | | | |
| | | | |
| | | | |
| | | | |
| | | | |
| | | | |
| | | | |

1. VERIFICATION OF COMPLIANCE

Product Name : IEEE 802.a/b/g/n/ac Managed Wireless Access Point

Brand Name : 

Model No. : AT-MWS2533AP

Applicant : Allied Telesis K.K

Test Rule Part(s) : 47 CFR FCC Part 15 Subpart C § 15.247

Sporton International as requested by the applicant to evaluate the EMC performance of the product sample received on Oct. 15, 2015 would like to declare that the tested sample has been evaluated and found to be in compliance with the tested rule parts. The data recorded as well as the test configuration specified is true and accurate for showing the sample's EMC nature.



Phoenix Chen

SPORTON INTERNATIONAL INC.

2. SUMMARY OF THE TEST RESULT

| Applied Standard: 47 CFR FCC Part 15 Subpart C | | | | |
|--|--------------|-----------------------------------|----------|-------------|
| Part | Rule Section | Description of Test | Result | Under Limit |
| 4.1 | 15.207 | AC Power Line Conducted Emissions | Complies | 5.3 dB |
| 4.2 | 15.247(b)(3) | Maximum Conducted Output Power | Complies | 0.13 dB |
| 4.3 | 15.247(e) | Power Spectral Density | Complies | 3.94 dB |
| 4.4 | 15.247(a)(2) | 6dB Spectrum Bandwidth | Complies | - |
| 4.5 | 15.247(d) | Radiated Emissions | Complies | 3.12 dB |
| 4.6 | 15.247(d) | Band Edge Emissions | Complies | 1.02 dB |
| 4.7 | 15.203 | Antenna Requirements | Complies | - |

3. GENERAL INFORMATION

3.1. Product Details

| Items | Description |
|--------------------------|--|
| Product Type | WLAN (4TX, 4RX) |
| Radio Type | Intentional Transceiver |
| Power Type | From power adapter or PoE |
| Modulation | IEEE 802.11b: DSSS IEEE 802.11g: OFDM IEEE 802.11n/ac: see the below table |
| Data Modulation | IEEE 802.11b: DSSS (BPSK / QPSK / CCK) IEEE 802.11g/n: OFDM (BPSK / QPSK / 16QAM / 64QAM) IEEE 802.11ac: OFDM (BPSK / QPSK / 16QAM / 64QAM / 256QAM) |
| Data Rate (Mbps) | IEEE 802.11b: DSSS (1/ 2/ 5.5/11) IEEE 802.11g: OFDM (6/9/12/18/24/36/48/54) IEEE 802.11n/ac: see the below table |
| Frequency Range | 2400 ~ 2483.5MHz |
| Channel Number | 11 for 20MHz bandwidth ; 7 for 40MHz bandwidth |
| Channel Band Width (99%) | Mode 1: EUT 1 + Set 1 Ceiling Mount Omni Antenna / 4 dBi IEEE 802.11ac MCS0/Nss1 (VHT20): 17.97 MHz IEEE 802.11ac MCS0/Nss1 (VHT40): 37.05 MHz Mode 2: EUT 1 + Set 2 Sector Antenna / 7.5 dBi IEEE 802.11ac MCS0/Nss1 (VHT20): 17.97 MHz IEEE 802.11ac MCS0/Nss1 (VHT40): 37.05 MHz Mode 3: EUT 1 + Set 3 Sector Antenna / 5.5 dBi IEEE 802.11ac MCS0/Nss1 (VHT20): 17.97 MHz IEEE 802.11ac MCS0/Nss1 (VHT40): 37.05 MHz Mode 4: EUT 1 + Set 4 Sector Antenna / 10.5 dBi IEEE 802.11ac MCS0/Nss1 (VHT20): 17.97 MHz IEEE 802.11ac MCS0/Nss1 (VHT40): 37.05 MHz Mode 5: EUT 1 + Set 7 Sector Antenna / 5 dBi IEEE 802.11ac MCS0/Nss1 (VHT20): 17.97 MHz IEEE 802.11ac MCS0/Nss1 (VHT40): 37.05 MHz Mode 6: EUT 1 + Set 8 Dipole Antenna / 4.66 dBi IEEE 802.11ac MCS0/Nss1 (VHT20): 17.97 MHz IEEE 802.11ac MCS0/Nss1 (VHT40): 37.19 MHz |

| | |
|--------------------------------|---|
| | Mode 7: EUT 2 + Set 10 PIFA Antenna / Chain1:3.81 dBi, Chain2:3.75 dBi, Chain3:3.98 dBi, Chain4:3.47 dBi IEEE 802.11ac MCS0/Nss1 (VHT20): 18.06 MHz IEEE 802.11ac MCS0/Nss1 (VHT40): 37.05 MHz |
| Maximum Conducted Output Power | Mode 1: EUT 1 + Set 1 Ceiling Mount Omni Antenna / 4 dBi IEEE 802.11ac MCS0/Nss1 (VHT20): 23.93 dBm IEEE 802.11ac MCS0/Nss1 (VHT40): 21.20 dBm Mode 2: EUT 1 + Set 2 Sector Antenna / 7.5 dBi IEEE 802.11ac MCS0/Nss1 (VHT20): 23.93 dBm IEEE 802.11ac MCS0/Nss1 (VHT40): 19.74 dBm Mode 3: EUT 1 + Set 3 Sector Antenna / 5.5 dBi IEEE 802.11ac MCS0/Nss1 (VHT20): 23.93 dBm IEEE 802.11ac MCS0/Nss1 (VHT40): 20.71 dBm Mode 4: EUT 1 + Set 4 Sector Antenna / 10.5 dBi IEEE 802.11ac MCS0/Nss1 (VHT20): 22.36 dBm IEEE 802.11ac MCS0/Nss1 (VHT40): 18.38 dBm Mode 5: EUT 1 + Set 7 Sector Antenna / 5 dBi IEEE 802.11ac MCS0/Nss1 (VHT20): 23.93 dBm IEEE 802.11ac MCS0/Nss1 (VHT40): 21.20 dBm Mode 6: EUT 1 + Set 8 Dipole Antenna / 4.66 dBi IEEE 802.11ac MCS0/Nss1 (VHT20): 23.93 dBm IEEE 802.11ac MCS0/Nss1 (VHT40): 20.36 dBm Mode 7: EUT 2 + Set 10 PIFA Antenna / Chain1:3.81 dBi, Chain2:3.75 dBi, Chain3:3.98 dBi, Chain4:3.47 dBi IEEE 802.11ac MCS0/Nss1 (VHT20): 25.41 dBm IEEE 802.11ac MCS0/Nss1 (VHT40): 19.60 dBm |
| Carrier Frequencies | Please refer to section 3.4 |
| Antenna | Please refer to section 3.3 |

| Items | Description |
|----------------------|---|
| Beamforming Function | <input checked="" type="checkbox"/> With beamforming <input type="checkbox"/> Without beamforming |

Note1: The product has beamforming function for 802.11n/ac in 2.4G/5G.

Note2: Test results of non-beamforming are recorded in test report: FR541527-01AA. Test results of beamforming are recorded in this test report.

Antenna and Band width

| Antenna | Four (TX) | |
|-----------------|-----------|--------|
| | 20 MHz | 40 MHz |
| Band width Mode | 20 MHz | 40 MHz |
| IEEE 802.11b | √ | X |
| IEEE 802.11g | √ | X |
| IEEE 802.11n | √ | √ |
| IEEE 802.11ac | √ | √ |

IEEE 11n/ac Spec.

| Protocol | Number of Transmit Chains (NTX) | Data Rate / MCS |
|------------------|---------------------------------|-----------------|
| 802.11n (HT20) | 4 | MCS 0-31 |
| 802.11n (HT40) | 4 | MCS 0-31 |
| 802.11ac (VHT20) | 4 | MCS 0-9/Nss1-4 |
| 802.11ac (VHT40) | 4 | MCS 0-9/Nss1-4 |

Note 1: IEEE Std. 802.11n modulation consists of HT20 and HT40 (HT: High Throughput).
Then EUT supports HT20 and HT40.

Note 2: IEEE Std. 802.11ac modulation consists of VHT20, VHT40, VHT80 and VHT160 (VHT: Very High Throughput). Then EUT supports VHT20 and VHT40 in 2.4GHz.

Note 3: Modulation modes consist of below configuration:
HT20/HT40: IEEE 802.11n, VHT20/VHT40: IEEE 802.11ac

3.2. Accessories

N/A

3.3. Table for Filed Antenna

| Set. | Brand Holder | Model Number (Part No.) | Extreme Part No. (Short Description) | Antenna Type | Connector | Polarized Antenna | Gain (dBi) | |
|------|--|----------------------------|--|--------------------------|-------------|----------------------|------------|------|
| | | | | | | | 2.4GHz | 5GHz |
| 1 | PCTEL Inc. | WS-AI-DQ04360 | WS-AI-DQ04360 (WS-AI-DQ04360) | Ceiling Mount Omni | RP SMA Male | V | 4 | 7 |
| 2 | PCTEL Inc. | 908403-10 | 30705 (WS-AI-DE07025) | Sector Antenna | RP SMA Male | V | 7.5 | 6.5 |
| 3 | PCTEL Inc. | 908400-10 | 30702 (WS-AI-DQ05120) | Sector Antenna | RP SMA Male | V | 5.5 | 5.5 |
| 4 | PCTEL Inc. | 908405-10 | 30707 (WS-AI-DE10055) | Sector Antenna | RP SMA Male | V | 10.5 | 7.5 |
| 5 | PCTEL Inc. | 908404-10 | 30706 (WS-AI-5Q05025) | Sector Antenna | RP SMA Male | V | - | 4.5 |
| 6 | PCTEL Inc. | 908401-10 | 30703 (WS-AI-5Q04060) | Sector Antenna | RP SMA Male | V | - | 4 |
| 7 | PCTEL Inc. | 908402-10 | 30704 (WS-AI-2Q05060) | Sector Antenna | RP SMA Male | V | 5 | - |
| 8 | Master Wave Technology Co., Ltd. | 98152MRSX015 | 30709 (WS-ANT-2DIP-4) | Dipole Antenna | RP SMA Male | X | 4.66 | - |
| 9 | Master Wave Technology Co., Ltd. | 98152URSX009 | 30710 (WS-ANT-5DIP-4) | Dipole Antenna | RP SMA Male | X | - | 4.67 |
| 10 | Senao Networks, Inc. | AP3935i | - | PIFA Antenna | IPEX | X | Note 1 | |

Note1:

| Set. | Antenna Gain (dBi) | | | | | | | |
|------|--------------------|---------|---------|---------|---------|---------|---------|---------|
| | 2.4GHz | | | | 5GHz | | | |
| | Chain 1 | Chain 2 | Chain 3 | Chain 4 | Chain 1 | Chain 2 | Chain 3 | Chain 4 |
| 10 | 3.81 | 3.75 | 3.98 | 3.47 | 5.84 | 5.50 | 5.84 | 5.65 |

Note2:

The EUT has ten sets of antennas.

<For 2.4GHz Function>

For IEEE 802.11b/g/n/ac mode (4TX, 4RX):

Chain 1, Chain 2, Chain 3 and Chain 4 could transmit/receive simultaneously.

<For 5GHz Function>

For IEEE 802.11a/n/ac mode (4TX, 4RX):

Chain 1, Chain 2, Chain 3 and Chain 4 could transmit/receive simultaneously.

For EUT 1:

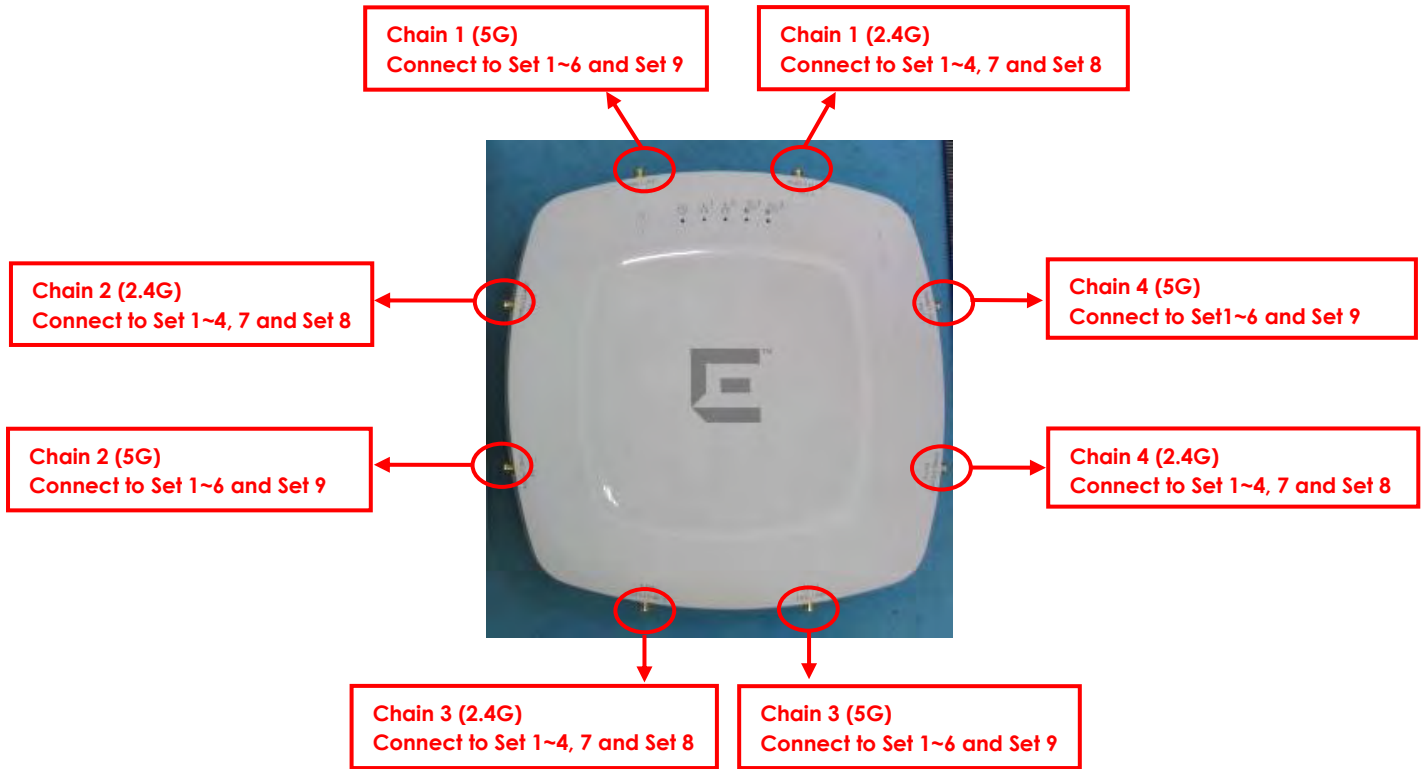

For EUT 2:

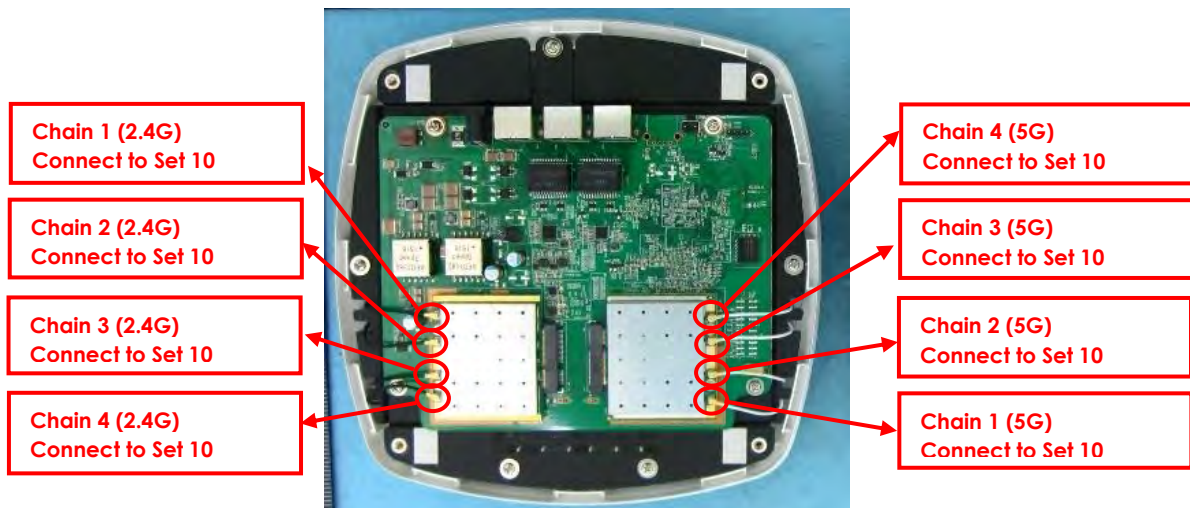

3.4. Table for Carrier Frequencies

There are two bandwidth systems.

For 20MHz bandwidth systems, use Channel 1~Channel 11.

For 40MHz bandwidth systems, use Channel 3~Channel 9.

| Frequency Band | Channel No. | Frequency | Channel No. | Frequency |
|----------------|-------------|-----------|-------------|-----------|
| 2400~2483.5MHz | 1 | 2412 MHz | 7 | 2442 MHz |
| | 2 | 2417 MHz | 8 | 2447 MHz |
| | 3 | 2422 MHz | 9 | 2452 MHz |
| | 4 | 2427 MHz | 10 | 2457 MHz |
| | 5 | 2432 MHz | 11 | 2462 MHz |
| | 6 | 2437 MHz | - | - |

3.5. Table for Test Modes

Preliminary tests were performed in different data rate to find the worst radiated emission. The data rate shown in the table below is the worst-case rate with respect to the specific test item. Investigation has been done on all the possible configurations for searching the worst cases. The following table is a list of the test modes shown in this test report.

| Test Items | Mode | Data Rate | Channel | Chain |
|---|-------------|-----------|---------|---------|
| AC Power Line Conducted Emissions | Normal Link | - | - | - |
| Maximum Conducted Output Power | 11ac VHT20 | MCS0/Nss1 | 1/6/11 | 1+2+3+4 |
| | 11ac VHT40 | MCS0/Nss1 | 3/6/9 | 1+2+3+4 |
| Power Spectral Density | 11ac VHT20 | MCS0/Nss1 | 1/6/11 | 1+2+3+4 |
| | 11ac VHT40 | MCS0/Nss1 | 3/6/9 | 1+2+3+4 |
| 6dB Spectrum Bandwidth | 11ac VHT20 | MCS0/Nss1 | 1/6/11 | 1+2+3+4 |
| | 11ac VHT40 | MCS0/Nss1 | 3/6/9 | 1+2+3+4 |
| Radiated Emissions 9kHz~1GHz | Normal Link | - | - | - |
| Radiated Emissions 1GHz~10 th Harmonic | 11ac VHT20 | MCS0/Nss1 | 1/6/11 | 1+2+3+4 |
| | 11ac VHT40 | MCS0/Nss1 | 3/6/9 | 1+2+3+4 |
| Band Edge Emissions | 11ac VHT20 | MCS0/Nss1 | 1/6/11 | 1+2+3+4 |
| | 11ac VHT40 | MCS0/Nss1 | 3/6/9 | 1+2+3+4 |

Note1: VHT20/VHT40 covers HT20/HT40, due to same modulation. The power setting for 802.11n HT20 and HT40 are the same or lower than 802.11ac VHT20 and VHT40.

Note2:

The adapter and PoE are for measurement only, would not be marketed.

The adapter and PoE information as below:

| Power | Brand | Model |
|---------|-----------|-----------|
| Adapter | APD | WA-24Q12R |
| PoE | Microsemi | PD-9001GR |

Note3: All the specification of test configurations and test modes were based on customer's request.

Note4: The console port can not be used by end user. It is generally used for updating FW by professional installer.

The following test modes were performed for all tests:

For Conducted Emission test:

Mode 1. Normal Link - EUT 1+ Adapter

Mode 2. Normal Link - EUT 2+ Adapter

Mode 1 is the worst case, so it was selected to record in this test report.

For Radiated Emission Below 1GHz test:

Mode 1. Place EUT 1 in Y axis + Set 4 + Adapter

Mode 2. Place EUT 1 in Z axis + Set 4 + Adapter

Mode 2 has been evaluated to be the worst case among Mode 1~2, thus measurement for Mode 3~5 will follow this same test mode.

Mode 3. Place EUT 1 in Z axis + Set 4 + PoE

Mode 4. Place EUT 2 in Z axis + Set 10 + Adapter

Mode 5. Place EUT 2 in Z axis + Set 10 + PoE

Mode 2 is the worst case, so it was selected to record in this test report.

For Radiated Emission Above 1GHz test:

The EUT 1 was performed at Y axis and Z axis position. Z axis has been evaluated to be the worst case, thus measurement will follow this same test mode.

The EUT 2 was performed at Y axis and Z axis position. Y axis has been evaluated to be the worst case, thus measurement will follow this same test mode.

Mode 1. Place EUT 1 in Z axis + Set 1

Mode 2. Place EUT 1 in Z axis + Set 2

Mode 3. Place EUT 1 in Z axis + Set 3

Mode 4. Place EUT 1 in Z axis + Set 4

Mode 5. Place EUT 1 in Z axis + Set 7

Mode 6. Place EUT 1 in Z axis + Set 8

Mode 7. Place EUT 2 in Y axis + Set 10

For Co-location MPE and Radiated Emission Co-location Test:

The EUT could be applied with 2.4GHz WLAN function and 5GHz WLAN function; therefore Co-location Maximum Permissible Exposure (Please refer to FA541527-01AB) and Radiated Emission Co-location (please refer to Appendix B) tests are added for simultaneously transmit between 2.4GHz WLAN function and 5GHz WLAN function.

3.6. Table for Testing Locations

| Test Site Location | | | | |
|--------------------|--|----------|--------------|-------------|
| Address: | No.8, Lane 724, Bo-ai St., Jhubei City, Hsinchu County 302, Taiwan, R.O.C. | | | |
| TEL: | 886-3-656-9065 | | | |
| FAX: | 886-3-656-9085 | | | |
| Test Site No. | Site Category | Location | FCC Reg. No. | IC File No. |
| 03CH01-CB | SAC | Hsin Chu | 262045 | IC 4086D |
| TH01-CB | OVEN Room | Hsin Chu | - | - |

Open Area Test Site (OATS); Semi Anechoic Chamber (SAC).

| Testing Location | | |
|--|--------|---|
| <input checked="" type="checkbox"/> | HWA YA | ADD : No. 52, Huaya 1st Rd., Guishan Dist., Taoyuan City, Taiwan (R.O.C.) |
| | | TEL : 886-3-327-3456 FAX : 886-3-327-0973 |
| Test site Designation No. TW1190 with FCC. | | |
| Test site registered number IC 4086B-1 with Industry Canada. | | |

| Test Condition | Test Site No. | Test Engineer | Test Environment | Test Date |
|----------------|---------------|---------------|------------------|-------------|
| Radiated | 03CH02-HY | Thor Wei | 23°C / 66% | 12/Aug/2017 |
| AC Conduction | CO04-HY | Teddy Chang | 22°C / 55% | 15/Aug/2017 |

3.7. Table for Multiple Listing

The model names are identical to each other in all aspects except for the following table:

| Equipment | EUT | Product Name | Model Name | Internal Antenna | External Antenna | Equipped Antenna |
|--|-----|----------------|------------|------------------|------------------|------------------|
| Wireless 802.11a/AC+ b/g/n Access Point | 1 | WS-AP3935e-FCC | 31014 | X | V | Set 1~9 |
| | 2 | WS-AP3935i-FCC | 31012 | V | X | Set 10 |

3.8. Table for Supporting Units

For Test Site No: 03CH02-HY (For Below 1GHz)

| Support Unit | Brand | Model | FCC ID |
|------------------------------|-------|-----------|--------|
| Load | - | - | N/A |
| Notebook | DELL | E6400 | N/A |
| Adapter (Client Provided) | APD | WA-24Q12R | N/A |

For Test Site No: 03CH01-CB (For Above 1GHz)

| Support Unit | Brand | Model | FCC ID |
|------------------------------|------------------|-----------|------------|
| Notebook*2 | DELL | E4300 | DoC |
| Device | Extreme Networks | 31012 | QXO-4411AC |
| Adapter (Client Provided) | APD | WA-24Q12R | N/A |

For Test Site No: CO04-HY

| Support Unit | Brand | Model | FCC ID |
|------------------------------|-------|-----------|--------|
| Adapter (Client Provided) | APD | WA-24Q12R | N/A |
| Dummy Load | - | - | N/A |
| Notebook | DELL | E5430 | DoC |
| Notebook(2.4G) | DELL | P55G | DoC |
| Notebook(5G) | DELL | P55G | DoC |

For Test Site No: TH01-CB

| Support Unit | Brand | Model | FCC ID |
|------------------------------|-------|-----------|--------|
| Notebook | DELL | E4300 | DoC |
| Adapter (Client Provided) | APD | WA-24Q12R | N/A |

3.9. Table for Parameters of Test Software Setting

During testing, Channel and Power Controlling Software provided by the customer was used to control the operating channel as well as the output power level. The RF output power selection is for the setting of RF output power expected by the customer and is going to be fixed on the firmware of the final end product.

Mode 1: EUT 1 + Set 1 Ceiling Mount Omni Antenna / 4 dBi

| Test Software Version | | QCA VER3.0.144.0 | | | | | |
|-----------------------|-----------|----------------------|----------|----------|------------|----------|----------|
| Mode | | Test Frequency (MHz) | | | | | |
| | | NCB: 20MHz | | | NCB: 40MHz | | |
| | | 2412 MHz | 2437 MHz | 2462 MHz | 2422 MHz | 2437 MHz | 2452 MHz |
| 802.11ac VHT20 | MCS0/Nss1 | 14.5 | 18 | 15.5 | - | - | - |
| 802.11ac VHT40 | MCS0/Nss1 | - | - | - | 10.5 | 15 | 11.5 |

Mode 2: EUT 1 + Set 2 Sector Antenna / 7.5 dBi

| Test Software Version | | QCA VER3.0.144.0 | | | | | |
|-----------------------|-----------|----------------------|----------|----------|------------|----------|----------|
| Mode | | Test Frequency (MHz) | | | | | |
| | | NCB: 20MHz | | | NCB: 40MHz | | |
| | | 2412 MHz | 2437 MHz | 2462 MHz | 2422 MHz | 2437 MHz | 2452 MHz |
| 802.11ac VHT20 | MCS0/Nss1 | 13.5 | 18 | 12.5 | - | - | - |
| 802.11ac VHT40 | MCS0/Nss1 | - | - | - | 10 | 13.5 | 10.5 |

Mode 3: EUT 1 + Set 3 Sector Antenna / 5.5 dBi

| Test Software Version | | QCA VER3.0.144.0 | | | | | |
|-----------------------|-----------|----------------------|----------|----------|------------|----------|----------|
| Mode | | Test Frequency (MHz) | | | | | |
| | | NCB: 20MHz | | | NCB: 40MHz | | |
| | | 2412 MHz | 2437 MHz | 2462 MHz | 2422 MHz | 2437 MHz | 2452 MHz |
| 802.11ac VHT20 | MCS0/Nss1 | 14 | 18 | 14.5 | - | - | - |
| 802.11ac VHT40 | MCS0/Nss1 | - | - | - | 10.5 | 14.5 | 12 |

Mode 4: EUT 1 + Set 4 Sector Antenna / 10.5 dBi

| Test Software Version | | QCA VER3.0.144.0 | | | | | |
|-----------------------|-----------|----------------------|----------|----------|------------|----------|----------|
| Mode | | Test Frequency (MHz) | | | | | |
| | | NCB: 20MHz | | | NCB: 40MHz | | |
| | | 2412 MHz | 2437 MHz | 2462 MHz | 2422 MHz | 2437 MHz | 2452 MHz |
| 802.11ac VHT20 | MCS0/Nss1 | 12.5 | 17 | 12 | - | - | - |
| 802.11ac VHT40 | MCS0/Nss1 | - | - | - | 8 | 12 | 9.5 |

Mode 5: EUT 1 + Set 7 Sector Antenna / 5 dBi

| Test Software Version | | QCA VER3.0.144.0 | | | | | |
|-----------------------|-----------|----------------------|----------|----------|------------|----------|----------|
| Mode | | Test Frequency (MHz) | | | | | |
| | | NCB: 20MHz | | | NCB: 40MHz | | |
| | | 2412 MHz | 2437 MHz | 2462 MHz | 2422 MHz | 2437 MHz | 2452 MHz |
| 802.11ac VHT20 | MCS0/Nss1 | 14.5 | 18 | 14.5 | - | - | - |
| 802.11ac VHT40 | MCS0/Nss1 | - | - | - | 11 | 15 | 11 |

Mode 6: EUT 1 + Set 8 Dipole Antenna / 4.66 dBi

| Test Software Version | | QCA VER3.0.144.0 | | | | | |
|-----------------------|-----------|----------------------|----------|----------|------------|----------|----------|
| Mode | | Test Frequency (MHz) | | | | | |
| | | NCB: 20MHz | | | NCB: 40MHz | | |
| | | 2412 MHz | 2437 MHz | 2462 MHz | 2422 MHz | 2437 MHz | 2452 MHz |
| 802.11ac VHT20 | MCS0/Nss1 | 14 | 18 | 14 | - | - | - |
| 802.11ac VHT40 | MCS0/Nss1 | - | - | - | 9 | 14 | 10.5 |

Mode 7: EUT 2 + Set 10 PIFA Antenna / Chain1:3.81 dBi, Chain2:3.75 dBi, Chain3:3.98 dBi, Chain4:3.47 dBi

| Test Software Version | | QCA VER3.0.144.0 | | | | | |
|-----------------------|-----------|----------------------|----------|----------|------------|----------|----------|
| Mode | | Test Frequency (MHz) | | | | | |
| | | NCB: 20MHz | | | NCB: 40MHz | | |
| | | 2412 MHz | 2437 MHz | 2462 MHz | 2422 MHz | 2437 MHz | 2452 MHz |
| 802.11ac VHT20 | MCS0/Nss1 | 15 | 18 | 14 | - | - | - |
| 802.11ac VHT40 | MCS0/Nss1 | - | - | - | 12.5 | 12 | 11.5 |

3.10. EUT Operation during Test

The EUT was programmed to be in continuously transmitting mode.

3.11. Duty Cycle

| Mode | On Time (ms) | On+Off Time (ms) | Duty Cycle (%) | Duty Factor (dB) | 1/T Minimum VBW (kHz) |
|--------------------------|--------------|------------------|----------------|------------------|-----------------------|
| 802.11ac MCS0/Nss1 VHT20 | 1.728 | 1.914 | 90.28 | 0.44 | 0.58 |
| 802.11ac MCS0/Nss1 VHT40 | 1.632 | 1.824 | 89.47 | 0.48 | 0.61 |

3.12. Test Configurations

3.12.1. AC Power Line Conduction Emissions Test Configuration

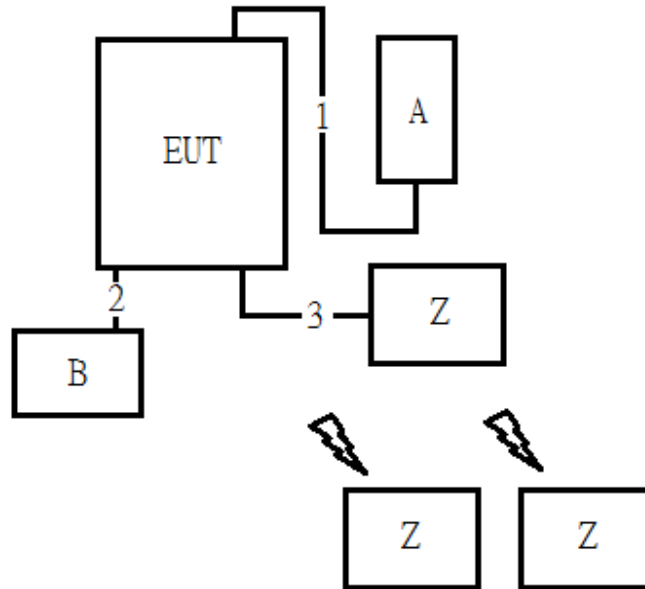

| Item | Connection | Shielded | Length(m) |
|------|----------------|----------|-----------|
| 1 | DC Power Cable | No | 1.5 |
| 2 | RJ45 Cable | No | 1 |
| 3 | RJ45 Cable | No | 10 |

| No. | Equipment | Brand | Model | FCC ID |
|-----|----------------|-------|-----------|--------|
| A | Adapter | APD | WA-24Q12R | N/A |
| B | Dummy Load | - | - | N/A |
| Z | NoteBook | DELL | E5430 | DoC |
| Z | NoteBook(2.4G) | DELL | P55G | DoC |
| Z | NoteBook(5G) | DELL | P55G | DoC |

3.12.2. Radiation Emissions Test Configuration

Test Configuration: 30MHz~1GHz

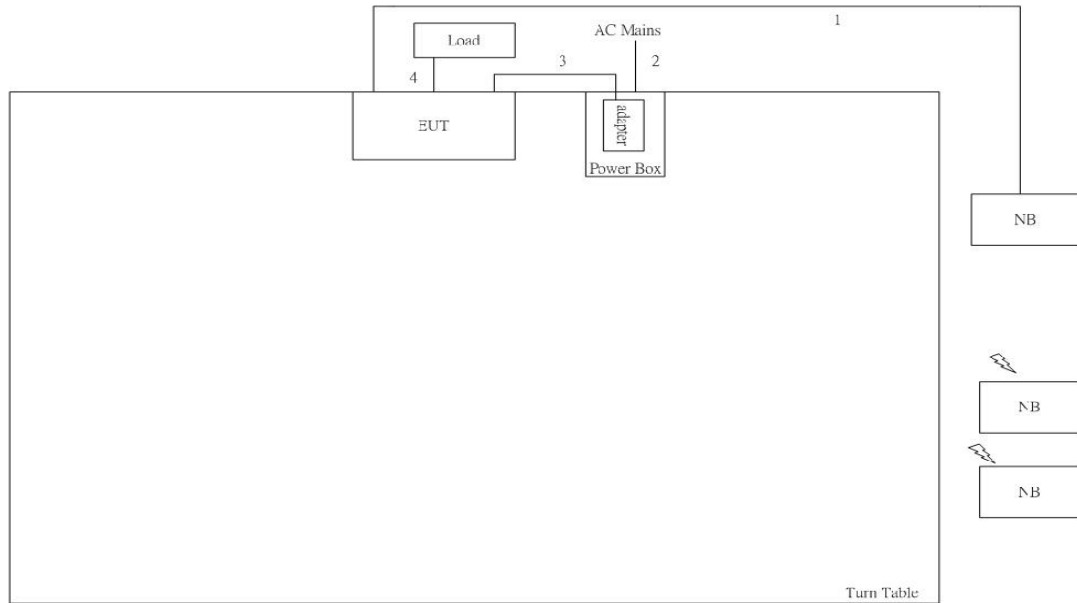

| Item | Connection | Shielded | Length(m) |
|------|---------------|----------|-----------|
| 1 | LAN Cable | No | 10 |
| 2 | AC Power line | No | 1.8 |
| 3 | DC Power line | No | 1.5 |
| 4 | LAN line | No | 3 |

Test Configuration: above 1GHz

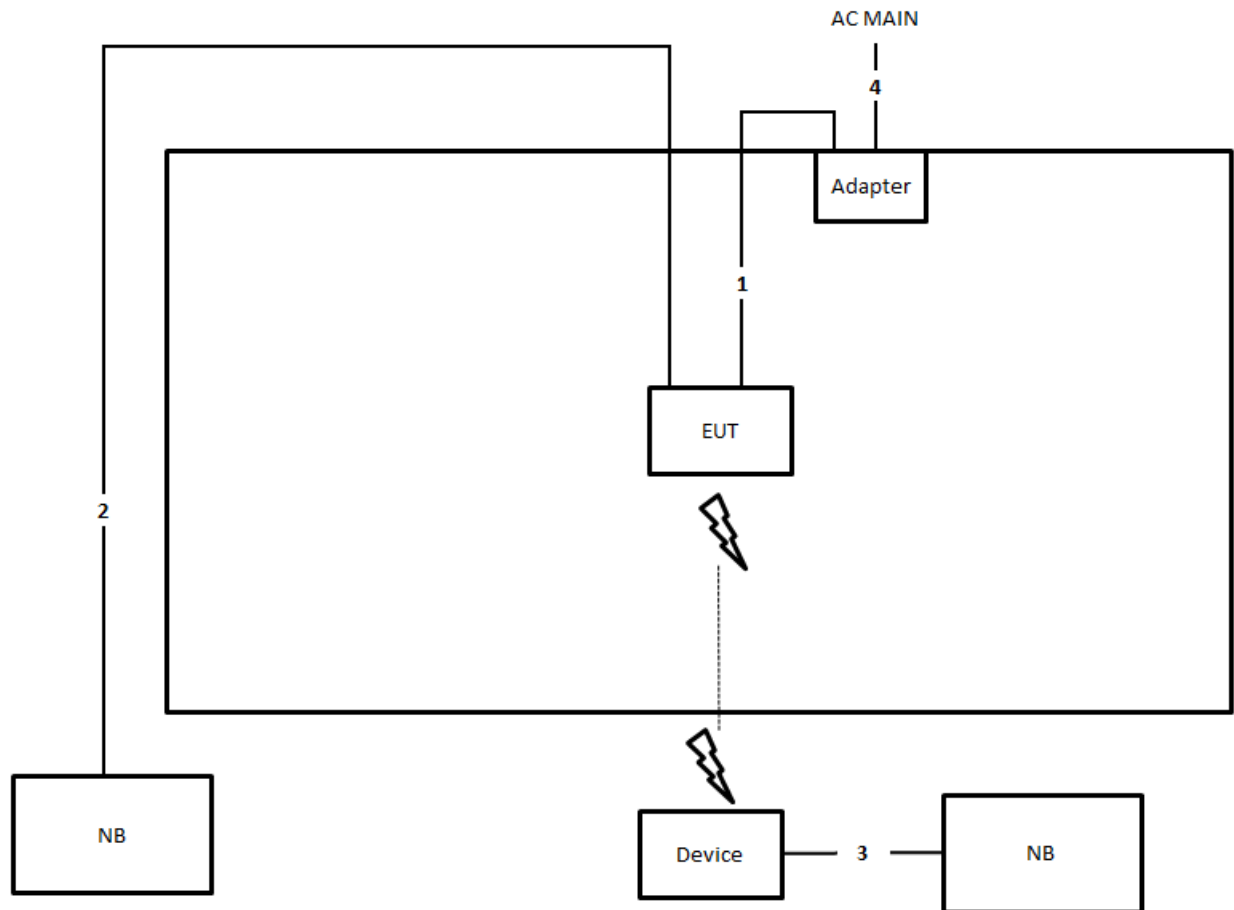

| Item | Connection | Shielded | Length(m) |
|------|----------------|----------|-----------|
| 1 | DC Power cable | No | 1.2 |
| 2 | RJ-45 cable | No | 10 |
| 3 | RJ-45 cable | No | 1.5 |
| 4 | AC Power cable | No | 1.8 |

4. TEST RESULT

4.1. AC Power Line Conducted Emissions Measurement

4.1.1. Limit

For this product which is designed to be connected to the AC power line, the radio frequency voltage that is conducted back onto the AC power line on any frequency or frequencies within the band 150 kHz to 30 MHz shall not exceed below limits table.

| Frequency (MHz) | QP Limit (dBuV) | AV Limit (dBuV) |
|-----------------|-----------------|-----------------|
| 0.15~0.5 | 66~56 | 56~46 |
| 0.5~5 | 56 | 46 |
| 5~30 | 60 | 50 |

4.1.2. Measuring Instruments and Setting

Please refer to section 5 of equipments list in this report. The following table is the setting of the receiver.

| Receiver Parameters | Setting |
|---------------------|----------|
| Attenuation | 10 dB |
| Start Frequency | 0.15 MHz |
| Stop Frequency | 30 MHz |
| IF Bandwidth | 9 kHz |

4.1.3. Test Procedures

1. Configure the EUT according to ANSI C63.10. The EUT or host of EUT has to be placed 0.4 meter far from the conducting wall of the shielding room and at least 80 centimeters from any other grounded conducting surface.
2. Connect EUT or host of EUT to the power mains through a line impedance stabilization network (LISN).
3. All the support units are connected to the other LISNs. The LISN should provide 50uH/50ohms coupling impedance.
4. The frequency range from 150 kHz to 30 MHz was searched.
5. Set the test-receiver system to Peak Detect Function and Specified Bandwidth with Maximum Hold Mode.
6. The measurement has to be done between each power line and ground at the power terminal.

4.1.4. Test Setup Layout

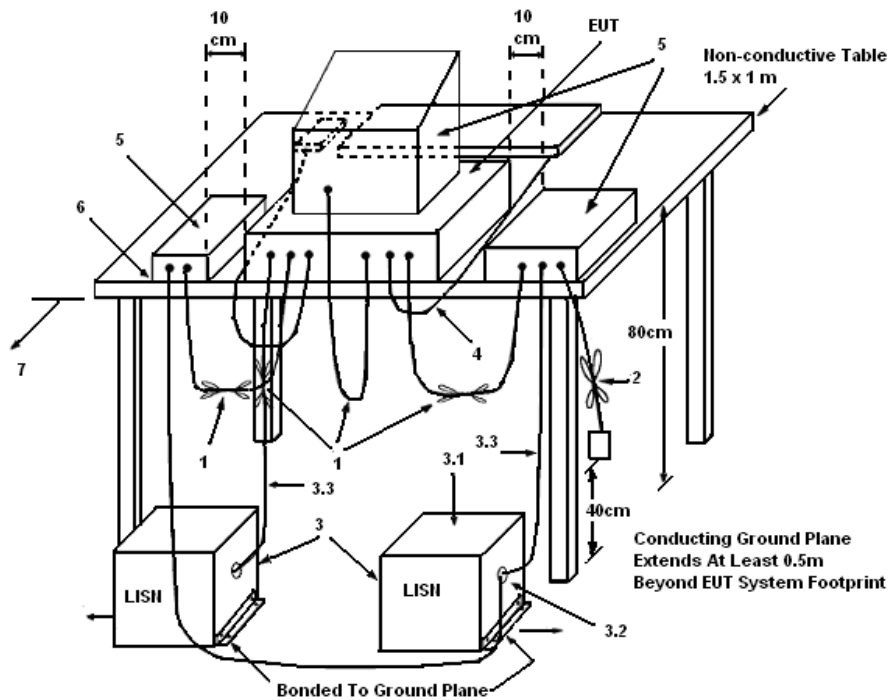

LEGEND:

- (1) Interconnecting cables that hang closer than 40 cm to the ground plane shall be folded back and forth in the center forming a bundle 30 to 40 cm long.
- (2) I/O cables that are not connected to a peripheral shall be bundled in the center. The end of the cable may be terminated, if required, using the correct terminating impedance. The overall length shall not exceed 1 m.
- (3) EUT connected to one LISN. Unused LISN measuring port connectors shall be terminated in 50 Ω . LISN can be placed on top of, or immediately beneath, reference ground plane.
 - (3.1) All other equipment powered from additional LISN(s).
 - (3.2) Multiple outlet strip can be used for multiple power cords of non-EUT equipment.
 - (3.3) LISN at least 80 cm from nearest part of EUT chassis.
- (4) Cables of hand-operated devices, such as keyboards, mice, etc., shall be placed as for normal use.
- (5) Non-EUT components of EUT system being tested.
- (6) Rear of EUT, including peripherals, shall all be aligned and flush with rear of tabletop.
- (7) Rear of tabletop shall be 40 cm removed from a vertical conducting plane that is bonded to the ground plane.

4.1.5. Test Deviation

There is no deviation with the original standard.

4.1.6. EUT Operation during Test

The EUT was placed on the test table and programmed in normal function.

4.1.7. Results of AC Power Line Conducted Emissions Measurement

| | | | |
|---------------|-------------|-----------|--------|
| Temperature | 22°C | Humidity | 55% |
| Test Engineer | Teddy Chang | Phase | Line |
| Configuration | Normal Link | Test Mode | Mode 1 |

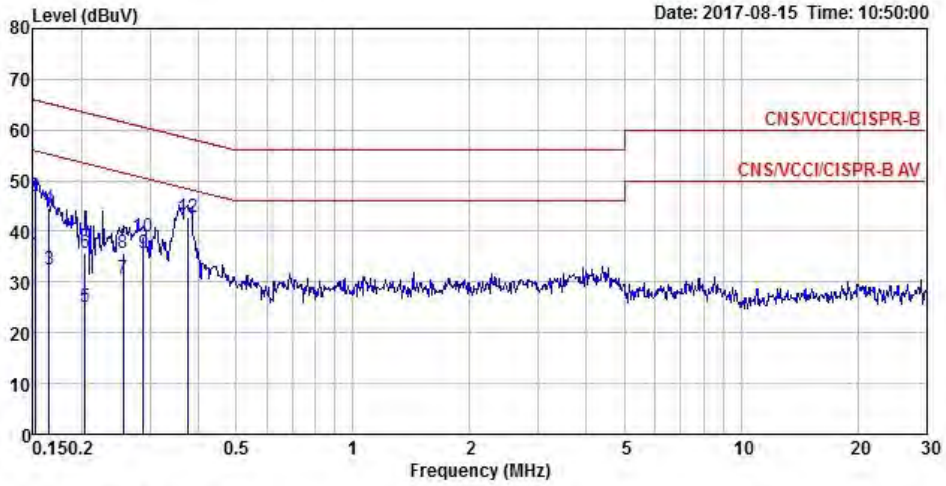

| | Freq | Level | Over Limit | Limit Line | Read Level | LISN Factor | Cable Loss | Remark |
|----|------|-------|------------|------------|------------|-------------|------------|---------|
| | MHz | dBuV | dB | dBuV | dBuV | dB | dB | |
| 1 | 0.15 | 35.31 | -20.60 | 55.91 | 25.43 | 9.66 | 0.22 | Average |
| 2 | 0.15 | 46.88 | -19.03 | 65.91 | 37.00 | 9.66 | 0.22 | QP |
| 3 | 0.17 | 32.33 | -22.88 | 55.21 | 22.42 | 9.66 | 0.25 | Average |
| 4 | 0.17 | 44.48 | -20.73 | 65.21 | 34.57 | 9.66 | 0.25 | QP |
| 5 | 0.20 | 25.00 | -28.45 | 53.45 | 15.06 | 9.65 | 0.29 | Average |
| 6 | 0.20 | 35.68 | -27.77 | 63.45 | 25.74 | 9.65 | 0.29 | QP |
| 7 | 0.26 | 30.65 | -20.91 | 51.56 | 20.76 | 9.66 | 0.23 | Average |
| 8 | 0.26 | 35.75 | -25.81 | 61.56 | 25.86 | 9.66 | 0.23 | QP |
| 9 | 0.29 | 35.66 | -14.93 | 50.59 | 25.79 | 9.67 | 0.20 | Average |
| 10 | 0.29 | 38.83 | -21.76 | 60.59 | 28.96 | 9.67 | 0.20 | QP |
| 11 | 0.38 | 41.35 | -7.04 | 48.39 | 31.55 | 9.68 | 0.12 | Average |
| 12 | 0.38 | 42.86 | -15.53 | 58.39 | 33.06 | 9.68 | 0.12 | QP |

| | | | |
|----------------------|-------------|------------------|---------|
| Temperature | 22°C | Humidity | 55% |
| Test Engineer | Teddy Chang | Phase | Neutral |
| Configuration | Normal Link | Test Mode | Mode 1 |

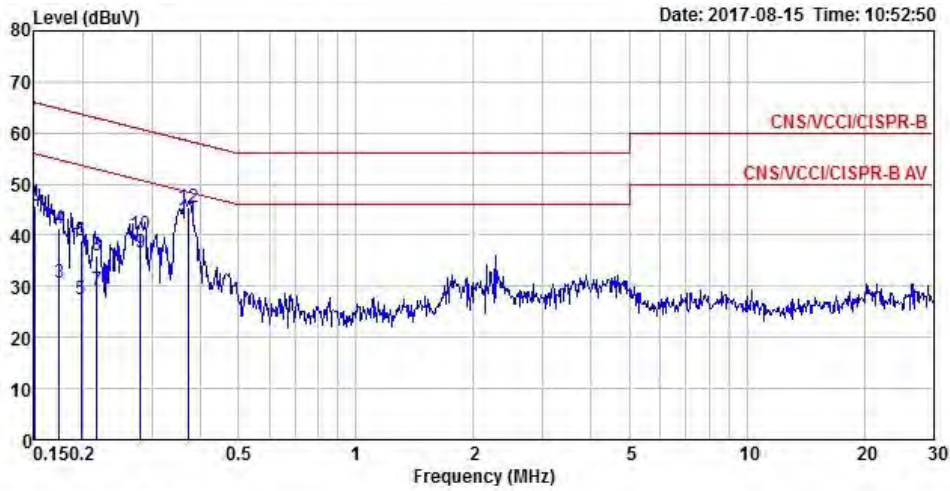

| | Freq | Level | Over | Limit | Read | LISN | Cable | Remark |
|----|------|-------|--------|-------|-------|--------|-------|---------|
| | MHz | dBuV | Limit | Line | Level | Factor | Loss | |
| | | | dB | dBuV | dBuV | dB | dB | |
| 1 | 0.15 | 34.62 | -21.38 | 56.00 | 24.80 | 9.60 | 0.22 | Average |
| 2 | 0.15 | 45.82 | -20.18 | 66.00 | 36.00 | 9.60 | 0.22 | QP |
| 3 | 0.17 | 30.67 | -24.10 | 54.77 | 20.77 | 9.64 | 0.26 | Average |
| 4 | 0.17 | 41.35 | -23.42 | 64.77 | 31.45 | 9.64 | 0.26 | QP |
| 5 | 0.20 | 27.43 | -26.28 | 53.71 | 17.46 | 9.67 | 0.30 | Average |
| 6 | 0.20 | 39.01 | -24.70 | 63.71 | 29.04 | 9.67 | 0.30 | QP |
| 7 | 0.22 | 29.30 | -23.62 | 52.92 | 19.37 | 9.66 | 0.27 | Average |
| 8 | 0.22 | 36.02 | -26.90 | 62.92 | 26.09 | 9.66 | 0.27 | QP |
| 9 | 0.28 | 36.73 | -14.08 | 50.81 | 26.88 | 9.65 | 0.20 | Average |
| 10 | 0.28 | 40.02 | -20.79 | 60.81 | 30.17 | 9.65 | 0.20 | QP |
| 11 | 0.37 | 43.17 | -5.30 | 48.47 | 33.42 | 9.63 | 0.12 | Average |
| 12 | 0.37 | 45.52 | -12.95 | 58.47 | 35.77 | 9.63 | 0.12 | QP |

Note:

Level = Read Level + LISN Factor + Cable Loss.

4.2. Maximum Conducted Output Power Measurement

4.2.1. Limit

The limit for output power is 30dBm.

4.2.2. Measuring Instruments and Setting

Please refer to section 5 of equipments list in this report. The following table is the setting of the power meter.

| Power Meter Parameter | Setting |
|-----------------------|--|
| Bandwidth | 50MHz bandwidth is greater than the EUT emission bandwidth |
| Detector | Average |

4.2.3. Test Procedures

1. Test procedures refer KDB558074 D01 v04 section 9.2.3.2 Measurement using a power meter (PM).
2. Multiple antenna systems was performed in accordance with KDB 662911 D01 v02r01 Emissions Testing of Transmitters with Multiple Outputs in the Same Band.
3. This procedure provides an alternative for determining the RMS output power using a broadband RF average power meter with a thermocouple detector.

4.2.4. Test Setup Layout

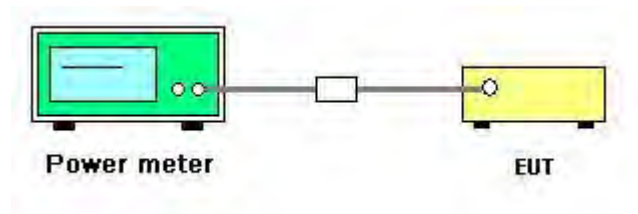

4.2.5. Test Deviation

There is no deviation with the original standard.

4.2.6. EUT Operation during Test

The EUT was programmed to be in continuously transmitting mode.

4.2.7. Test Result of Maximum Conducted Output Power

| | | | |
|----------------------|--|------------------|---------------|
| Temperature | 25°C | Humidity | 50% |
| Test Engineer | Eddie Weng & Lucas Huang | Test Date | Nov. 27, 2015 |
| Test Mode | Mode 1: EUT 1 + Set 1 Ceiling Mount Omni Antenna / 4 dBi | | |

| Mode | Frequency | Conducted Power (dBm) | | | | | Max. Limit (dBm) | Result |
|-----------|-----------|-----------------------|---------|---------|---------|-------|------------------|-----------------|
| | | Chain 1 | Chain 2 | Chain 3 | Chain 4 | Total | | |
| 802.11ac | 2412 MHz | 14.45 | 14.21 | 14.51 | 14.24 | 20.38 | 28.99 | Complies |
| MCS0/Nss1 | 2437 MHz | 18.02 | 17.82 | 17.95 | 17.83 | 23.93 | 28.99 | Complies |
| VHT20 | 2462 MHz | 15.69 | 15.41 | 15.44 | 15.18 | 21.45 | 28.99 | Complies |
| 802.11ac | 2422 MHz | 11.04 | 10.37 | 11.19 | 10.81 | 16.88 | 28.99 | Complies |
| MCS0/Nss1 | 2437 MHz | 15.14 | 15.07 | 15.24 | 15.27 | 21.20 | 28.99 | Complies |
| VHT40 | 2452 MHz | 11.63 | 11.51 | 12.08 | 12.11 | 17.86 | 28.99 | Complies |

Note: $DirectionalGain = 10 \cdot \log \left[\frac{\sum_{j=1}^{N_{SS}} \left\{ \sum_{k=1}^{N_{ANT}} g_{j,k} \right\}^2}{N_{ANT}} \right] = 7.01 \text{ dBi} > 6 \text{ dBi}$, So Limit = 30 - (7.01 - 6) = 28.99 dBm.

| | | | |
|----------------------|--|------------------|---------------|
| Temperature | 25°C | Humidity | 50% |
| Test Engineer | Eddie Weng & Lucas Huang | Test Date | Nov. 27, 2015 |
| Test Mode | Mode 2: EUT 1 + Set 2 Sector Antenna / 7.5 dBi | | |

| Mode | Frequency | Conducted Power (dBm) | | | | | Max. Limit (dBm) | Result |
|-----------|-----------|-----------------------|---------|---------|---------|-------|------------------|-----------------|
| | | Chain 1 | Chain 2 | Chain 3 | Chain 4 | Total | | |
| 802.11ac | 2412 MHz | 13.37 | 13.17 | 13.11 | 13.17 | 19.23 | 25.49 | Complies |
| MCS0/Nss1 | 2437 MHz | 18.02 | 17.82 | 17.95 | 17.83 | 23.93 | 25.49 | Complies |
| VHT20 | 2462 MHz | 12.71 | 12.35 | 12.79 | 12.91 | 18.72 | 25.49 | Complies |
| 802.11ac | 2422 MHz | 10.32 | 10.43 | 10.78 | 10.59 | 16.55 | 25.49 | Complies |
| MCS0/Nss1 | 2437 MHz | 13.76 | 13.44 | 13.88 | 13.78 | 19.74 | 25.49 | Complies |
| VHT40 | 2452 MHz | 10.73 | 10.57 | 11.11 | 11.09 | 16.90 | 25.49 | Complies |

Note: $DirectionalGain = 10 \cdot \log \left[\frac{\sum_{j=1}^{N_{SS}} \left\{ \sum_{k=1}^{N_{ANT}} g_{j,k} \right\}^2}{N_{ANT}} \right] = 10.51 \text{dBi} > 6 \text{dBi}$, So Limit = $30 - (10.51 - 6) = 25.49 \text{dBm}$.

| | | | |
|----------------------|--|------------------|---------------|
| Temperature | 25°C | Humidity | 50% |
| Test Engineer | Eddie Weng & Lucas Huang | Test Date | Nov. 27, 2015 |
| Test Mode | Mode 3: EUT 1 + Set 3 Sector Antenna / 5.5 dBi | | |

| Mode | Frequency | Conducted Power (dBm) | | | | | Max. Limit (dBm) | Result |
|-----------|-----------|-----------------------|---------|---------|---------|-------|------------------|-----------------|
| | | Chain 1 | Chain 2 | Chain 3 | Chain 4 | Total | | |
| 802.11ac | 2412 MHz | 14.21 | 13.71 | 14.02 | 13.66 | 19.93 | 27.49 | Complies |
| MCS0/Nss1 | 2437 MHz | 18.02 | 17.82 | 17.95 | 17.83 | 23.93 | 27.49 | Complies |
| VHT20 | 2462 MHz | 14.31 | 14.03 | 14.21 | 14.27 | 20.23 | 27.49 | Complies |
| 802.11ac | 2422 MHz | 11.04 | 10.37 | 11.19 | 10.81 | 16.88 | 27.49 | Complies |
| MCS0/Nss1 | 2437 MHz | 14.27 | 14.28 | 15.08 | 15.07 | 20.71 | 27.49 | Complies |
| VHT40 | 2452 MHz | 12.01 | 11.85 | 12.17 | 12.18 | 18.08 | 27.49 | Complies |

Note: $DirectionalGain = 10 \cdot \log \left[\frac{\sum_{j=1}^{N_{SS}} \left\{ \sum_{k=1}^{N_{ANT}} g_{j,k} \right\}^2}{N_{ANT}} \right] = 8.51 \text{ dBi} > 6 \text{ dBi}$, So Limit = 30 - (8.51 - 6) = 27.49 dBm.

| | | | |
|----------------------|---|------------------|---------------|
| Temperature | 25°C | Humidity | 50% |
| Test Engineer | Eddie Weng & Lucas Huang | Test Date | Nov. 27, 2015 |
| Test Mode | Mode 4: EUT 1 + Set 4 Sector Antenna / 10.5 dBi | | |

| Mode | Frequency | Conducted Power (dBm) | | | | | Max. Limit (dBm) | Result |
|-----------|-----------|-----------------------|---------|---------|---------|-------|------------------|-----------------|
| | | Chain 1 | Chain 2 | Chain 3 | Chain 4 | Total | | |
| 802.11ac | 2412 MHz | 12.67 | 12.18 | 12.6 | 12.24 | 18.45 | 22.49 | Complies |
| MCS0/Nss1 | 2437 MHz | 16.68 | 16.25 | 16.37 | 16.02 | 22.36 | 22.49 | Complies |
| VHT20 | 2462 MHz | 12.21 | 12.04 | 11.78 | 11.91 | 18.01 | 22.49 | Complies |
| 802.11ac | 2422 MHz | 8.77 | 8.39 | 8.42 | 8.55 | 14.56 | 22.49 | Complies |
| MCS0/Nss1 | 2437 MHz | 12.37 | 12.05 | 12.43 | 12.58 | 18.38 | 22.49 | Complies |
| VHT40 | 2452 MHz | 9.81 | 9.52 | 10.08 | 10.16 | 15.92 | 22.49 | Complies |

Note: $DirectionalGain = 10 \cdot \log \left[\frac{\sum_{j=1}^{N_{SS}} \left\{ \sum_{k=1}^{N_{ANT}} g_{j,k} \right\}^2}{N_{ANT}} \right] = 13.51 \text{ dBi} > 6 \text{ dBi}$, So Limit = $30 - (13.51 - 6) = 22.49 \text{ dBm}$.

| | | | |
|----------------------|--|------------------|---------------|
| Temperature | 25°C | Humidity | 50% |
| Test Engineer | Eddie Weng & Lucas Huang | Test Date | Nov. 27, 2015 |
| Test Mode | Mode 5: EUT 1 + Set 7 Sector Antenna / 5 dBi | | |

| Mode | Frequency | Conducted Power (dBm) | | | | | Max. Limit (dBm) | Result |
|-----------|-----------|-----------------------|---------|---------|---------|-------|------------------|-----------------|
| | | Chain 1 | Chain 2 | Chain 3 | Chain 4 | Total | | |
| 802.11ac | 2412 MHz | 14.45 | 14.21 | 14.51 | 14.24 | 20.38 | 27.99 | Complies |
| MCS0/Nss1 | 2437 MHz | 18.02 | 17.82 | 17.95 | 17.83 | 23.93 | 27.99 | Complies |
| VHT20 | 2462 MHz | 14.31 | 14.03 | 14.21 | 14.27 | 20.23 | 27.99 | Complies |
| 802.11ac | 2422 MHz | 11.76 | 11.34 | 11.83 | 11.63 | 17.66 | 27.99 | Complies |
| MCS0/Nss1 | 2437 MHz | 15.14 | 15.07 | 15.24 | 15.27 | 21.20 | 27.99 | Complies |
| VHT40 | 2452 MHz | 11.12 | 11.05 | 11.15 | 11.27 | 17.17 | 27.99 | Complies |

Note: $DirectionalGain = 10 \cdot \log \left[\frac{\sum_{j=1}^{N_{SS}} \left\{ \sum_{k=1}^{N_{ANT}} g_{j,k} \right\}^2}{N_{ANT}} \right] = 8.01 \text{ dBi} > 6 \text{ dBi}$, So Limit = 30 - (8.01 - 6) = 27.99 dBm.

| | | | |
|----------------------|---|------------------|---------------|
| Temperature | 25°C | Humidity | 50% |
| Test Engineer | Eddie Weng & Lucas Huang | Test Date | Nov. 27, 2015 |
| Test Mode | Mode 6: EUT 1 + Set 8 Dipole Antenna / 4.66 dBi | | |

| Mode | Frequency | Conducted Power (dBm) | | | | | Max. Limit (dBm) | Result |
|-----------|-----------|-----------------------|---------|---------|---------|-------|------------------|-----------------|
| | | Chain 1 | Chain 2 | Chain 3 | Chain 4 | Total | | |
| 802.11ac | 2412 MHz | 14.21 | 13.71 | 14.02 | 13.66 | 19.93 | 25.32 | Complies |
| MCS0/Nss1 | 2437 MHz | 18.02 | 17.82 | 17.95 | 17.83 | 23.93 | 25.32 | Complies |
| VHT20 | 2462 MHz | 13.71 | 13.63 | 13.81 | 14.01 | 19.81 | 25.32 | Complies |
| 802.11ac | 2422 MHz | 9.76 | 9.34 | 9.83 | 9.63 | 15.66 | 25.32 | Complies |
| MCS0/Nss1 | 2437 MHz | 14.36 | 14.02 | 14.39 | 14.58 | 20.36 | 25.32 | Complies |
| VHT40 | 2452 MHz | 10.73 | 10.57 | 11.11 | 11.09 | 16.90 | 25.32 | Complies |

Note: $DirectionalGain = 10 \cdot \log \left[\frac{\sum_{j=1}^{N_{SS}} \left\{ \sum_{k=1}^{N_{ANT}} g_{j,k} \right\}^2}{N_{ANT}} \right] = 10.68\text{dBi} > 6\text{dBi}$, So Limit = $30 - (10.68 - 6) = 25.32\text{dBm}$.

| | | | |
|----------------------|--|------------------|---------------|
| Temperature | 25°C | Humidity | 50% |
| Test Engineer | Eddie Weng & Lucas Huang | Test Date | Nov. 27, 2015 |
| Test Mode | Mode 7: EUT 2 + Set 10 PIFA Antenna / Chain1:3.81 dBi, Chain2:3.75 dBi, Chain3:3.98 dBi, Chain4:3.47 dBi | | |

| Mode | Frequency | Conducted Power (dBm) | | | | | Max. Limit (dBm) | Result |
|-----------|-----------|-----------------------|---------|---------|---------|-------|------------------|-----------------|
| | | Chain 1 | Chain 2 | Chain 3 | Chain 4 | Total | | |
| 802.11ac | 2412 MHz | 17.12 | 15.25 | 15.87 | 15.47 | 22.01 | 26.22 | Complies |
| MCS0/Nss1 | 2437 MHz | 18.54 | 21.32 | 18.36 | 18.56 | 25.41 | 26.22 | Complies |
| VHT20 | 2462 MHz | 14.22 | 15.08 | 14.36 | 17.1 | 21.37 | 26.22 | Complies |
| 802.11ac | 2422 MHz | 13.58 | 13.37 | 13.72 | 13.64 | 19.60 | 26.22 | Complies |
| MCS0/Nss1 | 2437 MHz | 12.91 | 13.33 | 13.68 | 13.02 | 19.27 | 26.22 | Complies |
| VHT40 | 2452 MHz | 12.45 | 12.75 | 13.89 | 12.33 | 18.92 | 26.22 | Complies |

Note: $DirectionalGain = 10 \cdot \log \left[\frac{\sum_{j=1}^{N_{SS}} \left\{ \sum_{k=1}^{N_{ANT}} g_{j,k} \right\}^2}{N_{ANT}} \right] = 9.78\text{dBi} > 6\text{dBi}$, So Limit = $30 - (9.78 - 6) = 26.22\text{dBm}$.

4.3. Power Spectral Density Measurement

4.3.1. Limit

For digitally modulated systems, the power spectral density conducted from the intentional radiator to the antenna shall not be greater than 8 dBm in any 3 kHz band during any time interval of continuous transmission.

4.3.2. Measuring Instruments and Setting

Please refer to section 5 of equipments list in this report. The following table is the setting of the spectrum analyzer.

| Spectrum Parameter | Setting |
|--------------------|--|
| Attenuation | Auto |
| Span Frequency | Set the span to 1.5 times the DTS channel bandwidth. |
| RBW | $3 \text{ kHz} \leq \text{RBW} \leq 100\text{kHz}$ |
| VBW | $\geq 3 \times \text{RBW}$ |
| Detector | Peak |
| Trace | Max Hold |
| Sweep Time | Auto couple |

4.3.3. Test Procedures

1. Test was performed in accordance with KDB558074 D01 v04 for Performing Compliance Measurements on Digital Transmission Systems (DTS) - section 10.2 Method PKPSD (peak PSD) and KDB 662911 D01 v02r01 section In-Band Power Spectral Density (PSD) Measurements option (b) Measure and sum spectral maximal across the outputs.
2. Use this procedure when the maximum conducted output power in the fundamental emission is used to demonstrate compliance. The EUT must be configured to transmit continuously at full power over the measurement duration.
3. Ensure that the number of measurement points in the sweep $\geq 2 \times \text{span}/\text{RBW}$ (use of a greater number of measurement points than this minimum requirement is recommended).
4. Use the peak marker function to determine the maximum level in any 3 kHz band segment within the fundamental EBW.
5. The resulting PSD level must be $\leq 8 \text{ dBm}$.

4.3.4. Test Setup Layout

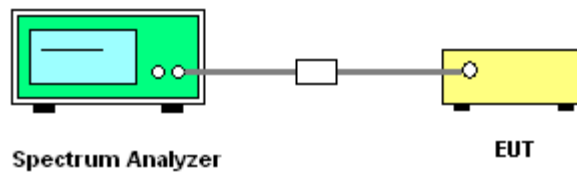

4.3.5. Test Deviation

There is no deviation with the original standard.

4.3.6. EUT Operation during Test

The EUT was programmed to be in continuously transmitting mode.

4.3.7. Test Result of Power Spectral Density

| | | | |
|----------------------|--|-----------------|-----|
| Temperature | 25°C | Humidity | 50% |
| Test Engineer | Eddie Weng & Lucas Huang | | |
| Test Mode | Mode 1: EUT 1 + Set 1 Ceiling Mount Omni Antenna / 4 dBi | | |

| Mode | Frequency | Power Density (dBm/3kHz) | | | | | Power Density Limit (dBm/3kHz) | Result |
|-----------|-----------|--------------------------|---------|---------|---------|--------|--------------------------------|-----------------|
| | | Chain 1 | Chain 2 | Chain 3 | Chain 4 | Total | | |
| 802.11ac | 2412 MHz | -11.25 | -11.61 | -10.52 | -12.63 | -5.42 | 6.99 | Complies |
| MCS0/Nss1 | 2437 MHz | -9.20 | -9.97 | -10.23 | -9.91 | -3.79 | 6.99 | Complies |
| VHT20 | 2462 MHz | -10.03 | -9.48 | -11.79 | -11.75 | -4.62 | 6.99 | Complies |
| 802.11ac | 2422 MHz | -17.23 | -17.33 | -16.66 | -17.84 | -11.22 | 6.99 | Complies |
| MCS0/Nss1 | 2437 MHz | -13.08 | -12.63 | -12.74 | -13.56 | -6.97 | 6.99 | Complies |
| VHT40 | 2452 MHz | -16.57 | -16.77 | -17.29 | -17.32 | -10.95 | 6.99 | Complies |

Note: $DirectionalGain = 10 \cdot \log \left[\frac{\sum_{j=1}^{N_{SS}} \left\{ \sum_{k=1}^{N_{ANT}} g_{j,k} \right\}^2}{N_{ANT}} \right] = 7.01 \text{ dBi} > 6 \text{ dBi}$, So Limit = $8 - (7.01 - 6) = 6.99 \text{ dBm/3kHz}$.

| | | | |
|----------------------|--|-----------------|-----|
| Temperature | 25°C | Humidity | 50% |
| Test Engineer | Eddie Weng & Lucas Huang | | |
| Test Mode | Mode 2: EUT 1 + Set 2 Sector Antenna / 7.5 dBi | | |

| Mode | Frequency | Power Density (dBm/3kHz) | | | | | Power Density Limit (dBm/3kHz) | Result |
|-----------|-----------|--------------------------|---------|---------|---------|--------|--------------------------------|-----------------|
| | | Chain 1 | Chain 2 | Chain 3 | Chain 4 | Total | | |
| 802.11ac | 2412 MHz | -12.04 | -12.04 | -11.78 | -13.22 | -6.22 | 3.49 | Complies |
| MCS0/Nss1 | 2437 MHz | -9.20 | -9.97 | -10.23 | -9.91 | -3.79 | 3.49 | Complies |
| VHT20 | 2462 MHz | -13.57 | -12.89 | -13.97 | -13.69 | -7.49 | 3.49 | Complies |
| 802.11ac | 2422 MHz | -17.24 | -17.79 | -17.37 | -18.49 | -11.68 | 3.49 | Complies |
| MCS0/Nss1 | 2437 MHz | -14.65 | -14.29 | -14.83 | -15.11 | -8.69 | 3.49 | Complies |
| VHT40 | 2452 MHz | -17.71 | -17.15 | -17.58 | -18.18 | -11.62 | 3.49 | Complies |

Note: $DirectionalGain = 10 \cdot \log \left[\frac{\sum_{j=1}^{N_{SS}} \left\{ \sum_{k=1}^{N_{ANT}} g_{j,k} \right\}^2}{N_{ANT}} \right] = 10.51 \text{ dBi} > 6 \text{ dBi}$, So Limit = $8 - (10.51 - 6) = 3.49 \text{ dBm/3kHz}$.

| | | | |
|----------------------|--|-----------------|-----|
| Temperature | 25°C | Humidity | 50% |
| Test Engineer | Eddie Weng & Lucas Huang | | |
| Test Mode | Mode 3: EUT 1 + Set 3 Sector Antenna / 5.5 dBi | | |

| Mode | Frequency | Power Density (dBm/3kHz) | | | | | Power Density Limit (dBm/3kHz) | Result |
|-----------|-----------|--------------------------|---------|---------|---------|--------|--------------------------------|----------|
| | | Chain 1 | Chain 2 | Chain 3 | Chain 4 | Total | | |
| 802.11ac | 2412 MHz | -11.56 | -12.48 | -12.45 | -13.78 | -6.48 | 5.49 | Complies |
| MCS0/Nss1 | 2437 MHz | -9.20 | -9.97 | -10.23 | -9.91 | -3.79 | 5.49 | Complies |
| VHT20 | 2462 MHz | -14.11 | -13.14 | -12.85 | -12.97 | -7.22 | 5.49 | Complies |
| 802.11ac | 2422 MHz | -17.23 | -17.33 | -16.66 | -17.84 | -11.22 | 5.49 | Complies |
| MCS0/Nss1 | 2437 MHz | -13.43 | -12.81 | -13.69 | -14.25 | -7.49 | 5.49 | Complies |
| VHT40 | 2452 MHz | -16.31 | -16.23 | -16.56 | -16.90 | -10.47 | 5.49 | Complies |

Note: $DirectionalGain = 10 \cdot \log \left[\frac{\sum_{j=1}^{N_{SS}} \left\{ \sum_{k=1}^{N_{ANT}} g_{j,k} \right\}^2}{N_{ANT}} \right] = 8.51 \text{ dBi} > 6 \text{ dBi}$, So Limit = $8 - (8.51 - 6) = 5.49 \text{ dBm/3kHz}$.

| | | | |
|----------------------|---|-----------------|-----|
| Temperature | 25°C | Humidity | 50% |
| Test Engineer | Eddie Weng & Lucas Huang | | |
| Test Mode | Mode 4: EUT 1 + Set 4 Sector Antenna / 10.5 dBi | | |

| Mode | Frequency | Power Density (dBm/3kHz) | | | | | Power Density Limit (dBm/3kHz) | Result |
|-----------|-----------|--------------------------|---------|---------|---------|--------|--------------------------------|-----------------|
| | | Chain 1 | Chain 2 | Chain 3 | Chain 4 | Total | | |
| 802.11ac | 2412 MHz | -12.73 | -12.54 | -14.04 | -14.57 | -7.37 | 0.49 | Complies |
| MCS0/Nss1 | 2437 MHz | -8.25 | -8.95 | -10.49 | -10.70 | -3.45 | 0.49 | Complies |
| VHT20 | 2462 MHz | -13.46 | -13.38 | -15.42 | -15.49 | -8.30 | 0.49 | Complies |
| 802.11ac | 2422 MHz | -19.52 | -20.02 | -19.32 | -20.10 | -13.71 | 0.49 | Complies |
| MCS0/Nss1 | 2437 MHz | -16.01 | -15.79 | -16.34 | -16.60 | -10.15 | 0.49 | Complies |
| VHT40 | 2452 MHz | -18.62 | -18.39 | -17.95 | -19.11 | -12.48 | 0.49 | Complies |

Note: $DirectionalGain = 10 \cdot \log \left[\frac{\sum_{j=1}^{N_{SS}} \left\{ \sum_{k=1}^{N_{ANT}} g_{j,k} \right\}^2}{N_{ANT}} \right] = 13.51 \text{ dBi} > 6 \text{ dBi}$, So Limit = $8 - (13.51 - 6) = 0.49 \text{ dBm/3kHz}$.

| | | | |
|----------------------|--|-----------------|-----|
| Temperature | 25°C | Humidity | 50% |
| Test Engineer | Eddie Weng & Lucas Huang | | |
| Test Mode | Mode 5: EUT 1 + Set 7 Sector Antenna / 5 dBi | | |

| Mode | Frequency | Power Density (dBm/3kHz) | | | | | Power Density Limit (dBm/3kHz) | Result |
|-----------|-----------|--------------------------|---------|---------|---------|--------|--------------------------------|----------|
| | | Chain 1 | Chain 2 | Chain 3 | Chain 4 | Total | | |
| 802.11ac | 2412 MHz | -11.25 | -11.61 | -10.52 | -12.63 | -5.42 | 5.99 | Complies |
| MCS0/Nss1 | 2437 MHz | -9.20 | -9.97 | -10.23 | -9.91 | -3.79 | 5.99 | Complies |
| VHT20 | 2462 MHz | -14.11 | -13.14 | -12.85 | -12.97 | -7.22 | 5.99 | Complies |
| 802.11ac | 2422 MHz | -16.59 | -16.76 | -16.76 | -17.60 | -10.89 | 5.99 | Complies |
| MCS0/Nss1 | 2437 MHz | -13.08 | -12.63 | -12.74 | -13.56 | -6.97 | 5.99 | Complies |
| VHT40 | 2452 MHz | -16.97 | -16.77 | -17.19 | -18.24 | -11.24 | 5.99 | Complies |

Note: $DirectionalGain = 10 \cdot \log \left[\frac{\sum_{j=1}^{N_{SS}} \left\{ \sum_{k=1}^{N_{ANT}} g_{j,k} \right\}^2}{N_{ANT}} \right] = 8.01 \text{ dBi} > 6 \text{ dBi}$, So Limit = $8 - (8.01 - 6) = 5.99 \text{ dBm/3kHz}$.

| | | | |
|----------------------|---|-----------------|-----|
| Temperature | 25°C | Humidity | 50% |
| Test Engineer | Eddie Weng & Lucas Huang | | |
| Test Mode | Mode 6: EUT 1 + Set 8 Dipole Antenna / 4.66 dBi | | |

| Mode | Frequency | Power Density (dBm/3kHz) | | | | | Power Density Limit (dBm/3kHz) | Result |
|-----------|-----------|--------------------------|---------|---------|---------|--------|--------------------------------|-----------------|
| | | Chain 1 | Chain 2 | Chain 3 | Chain 4 | Total | | |
| 802.11ac | 2412 MHz | -11.56 | -12.48 | -12.45 | -13.78 | -6.48 | 3.32 | Complies |
| MCS0/Nss1 | 2437 MHz | -9.20 | -9.97 | -10.23 | -9.91 | -3.79 | 3.32 | Complies |
| VHT20 | 2462 MHz | -12.93 | -11.64 | -13.15 | -14.87 | -6.98 | 3.32 | Complies |
| 802.11ac | 2422 MHz | -20.85 | -20.26 | -20.05 | -19.99 | -14.25 | 3.32 | Complies |
| MCS0/Nss1 | 2437 MHz | -16.08 | -15.32 | -14.05 | -16.40 | -9.34 | 3.32 | Complies |
| VHT40 | 2452 MHz | -17.71 | -17.15 | -17.58 | -18.18 | -11.62 | 3.32 | Complies |

Note: $DirectionalGain = 10 \cdot \log \left[\frac{\sum_{j=1}^{N_{SS}} \left\{ \sum_{k=1}^{N_{ANT}} g_{j,k} \right\}^2}{N_{ANT}} \right] = 10.68\text{dBi} > 6\text{dBi}$, So Limit = $8 - (10.68 - 6) = 3.32\text{dBm}/3\text{kHz}$.

| | | | |
|----------------------|--|-----------------|-----|
| Temperature | 25°C | Humidity | 50% |
| Test Engineer | Eddie Weng & Lucas Huang | | |
| Test Mode | Mode 7: EUT 2 + Set 10 PIFA Antenna / Chain1:3.81 dBi, Chain2:3.75 dBi, Chain3:3.98 dBi, Chain4:3.47 dBi | | |

| Mode | Frequency | Power Density (dBm/3kHz) | | | | | Power Density Limit (dBm/3kHz) | Result |
|-----------|-----------|--------------------------|---------|---------|---------|--------|--------------------------------|-----------------|
| | | Chain 1 | Chain 2 | Chain 3 | Chain 4 | Total | | |
| 802.11ac | 2412 MHz | -12.33 | -12.96 | -11.30 | -12.51 | -6.21 | 4.22 | Complies |
| MCS0/Nss1 | 2437 MHz | -8.11 | -9.00 | -8.76 | -9.87 | -2.87 | 4.22 | Complies |
| VHT20 | 2462 MHz | -12.93 | -11.64 | -13.15 | -14.87 | -6.98 | 4.22 | Complies |
| 802.11ac | 2422 MHz | -16.55 | -15.58 | -15.77 | -15.83 | -9.90 | 4.22 | Complies |
| MCS0/Nss1 | 2437 MHz | -16.78 | -17.20 | -17.21 | -17.96 | -11.25 | 4.22 | Complies |
| VHT40 | 2452 MHz | -18.08 | -16.14 | -16.83 | -18.71 | -11.30 | 4.22 | Complies |

Note: $DirectionalGain = 10 \cdot \log \left[\frac{\sum_{j=1}^{N_{SS}} \left\{ \sum_{k=1}^{N_{ANT}} g_{j,k} \right\}^2}{N_{ANT}} \right] = 9.78\text{dBi} > 6\text{dBi}$, So Limit = $8 - (9.78 - 6) = 4.22\text{dBm}/3\text{kHz}$.

Note: All the test values were listed in the report.

For plots, only the channel with worse result was shown.

Mode 1: EUT 1 + Set 1 Ceiling Mount Omni Antenna / 4 dBi

Power Density Plot on Configuration IEEE 802.11ac MCS0/Nss1 VHT20 / 2437 MHz / Chain 1

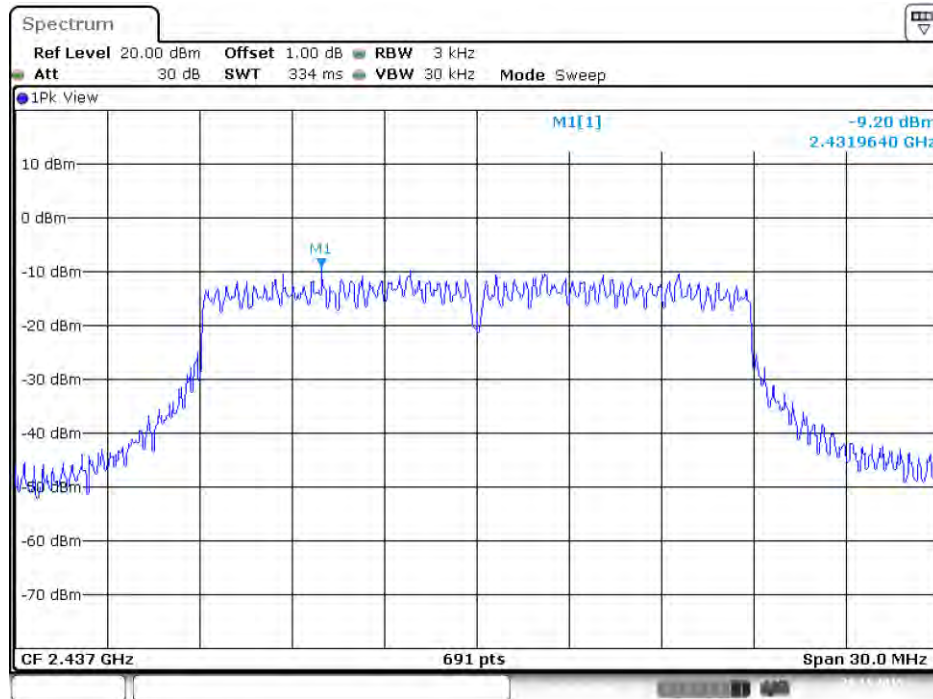

Date: 26.NOV.2015 12:42:07

Power Density Plot on Configuration IEEE 802.11ac MCS0/Nss1 VHT20 / 2437 MHz / Chain 2

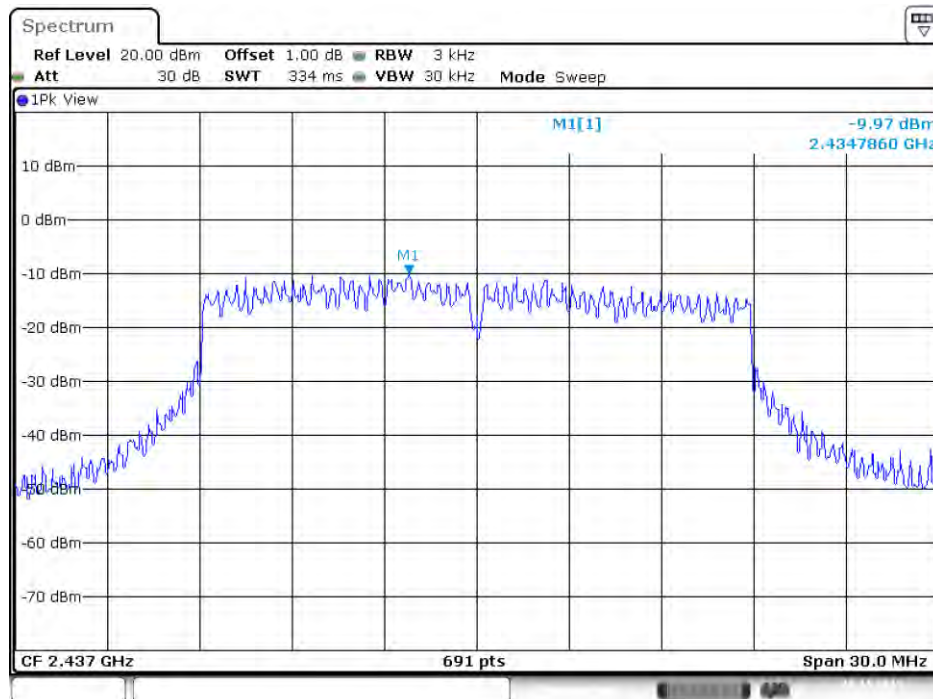

Date: 26.NOV.2015 12:41:34

Power Density Plot on Configuration IEEE 802.11ac MCS0/Nss1 VHT20 / 2437 MHz / Chain 3

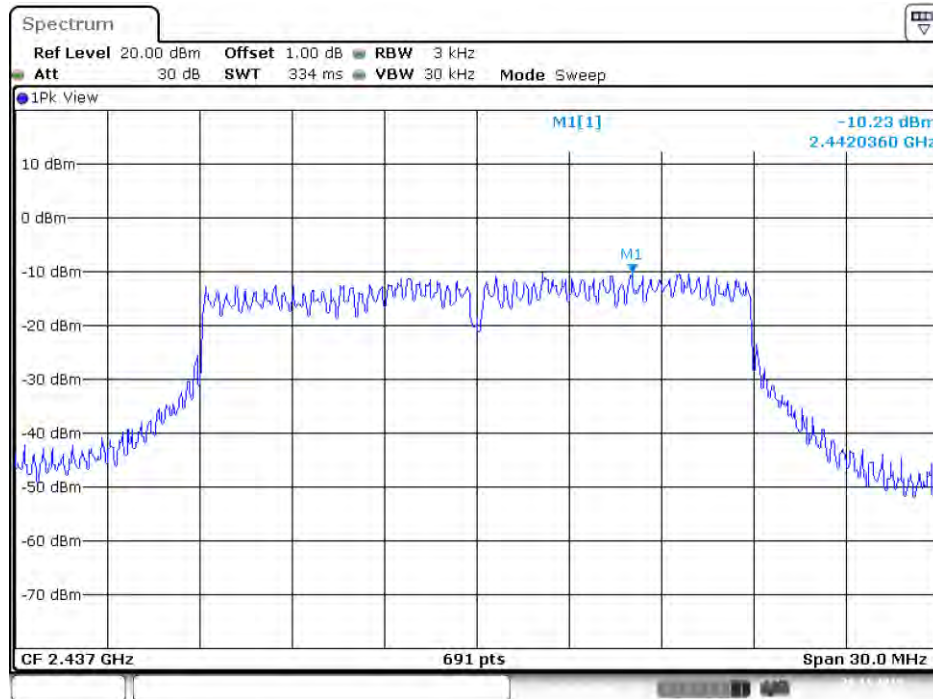

Date: 26.NOV.2015 12:41:04

Power Density Plot on Configuration IEEE 802.11ac MCS0/Nss1 VHT20 / 2437 MHz / Chain 4

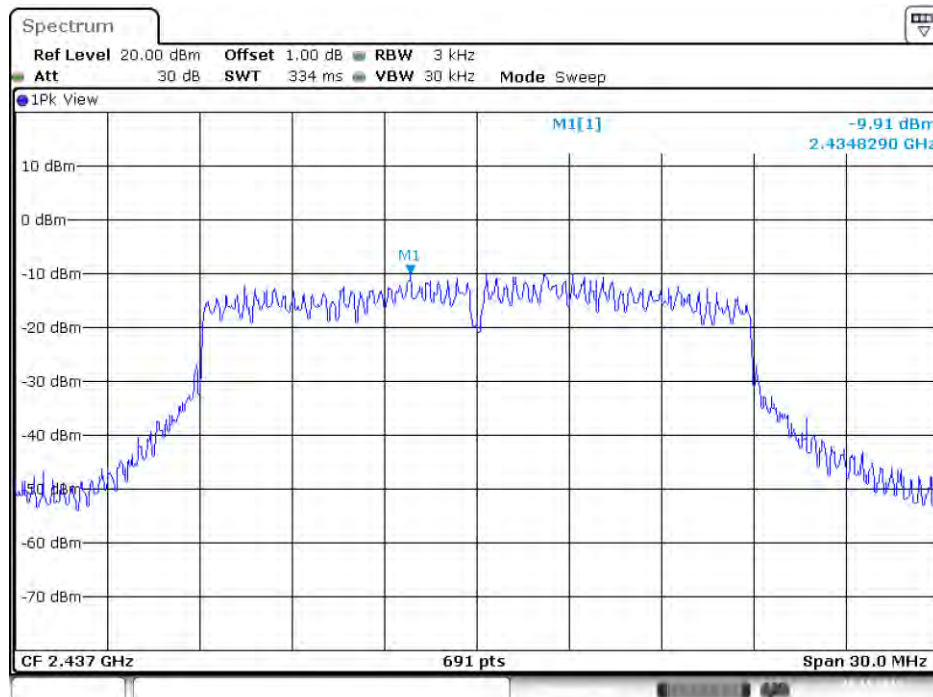

Date: 26.NOV.2015 12:40:25

Power Density Plot on Configuration IEEE 802.11ac MCS0/Nss1 VHT40 / 2437 MHz / Chain 1

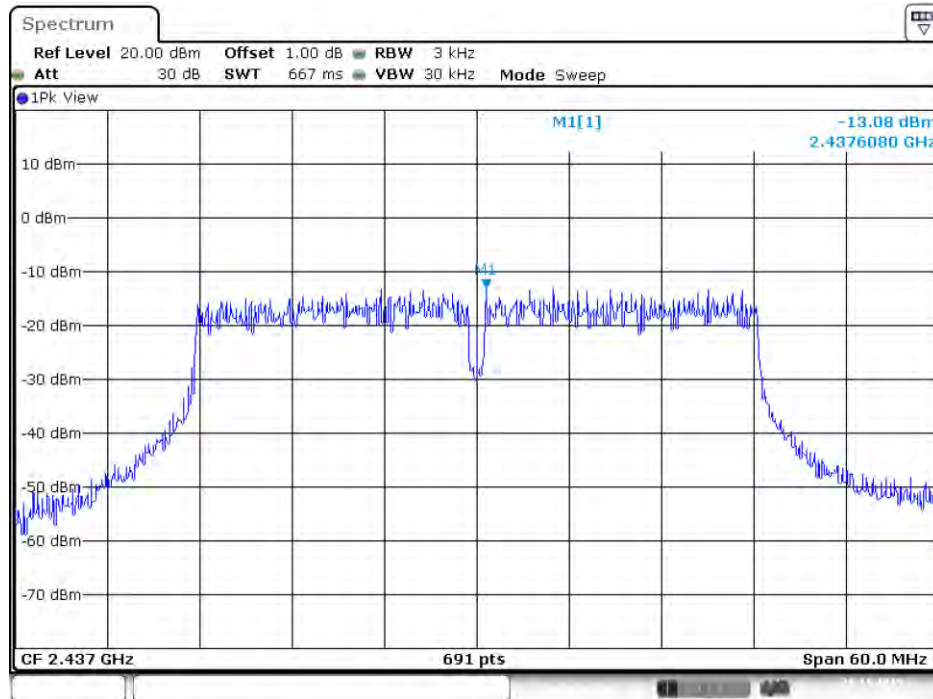

Date: 26.NOV.2015 13:13:29

Power Density Plot on Configuration IEEE 802.11ac MCS0/Nss1 VHT40 / 2437 MHz / Chain 2

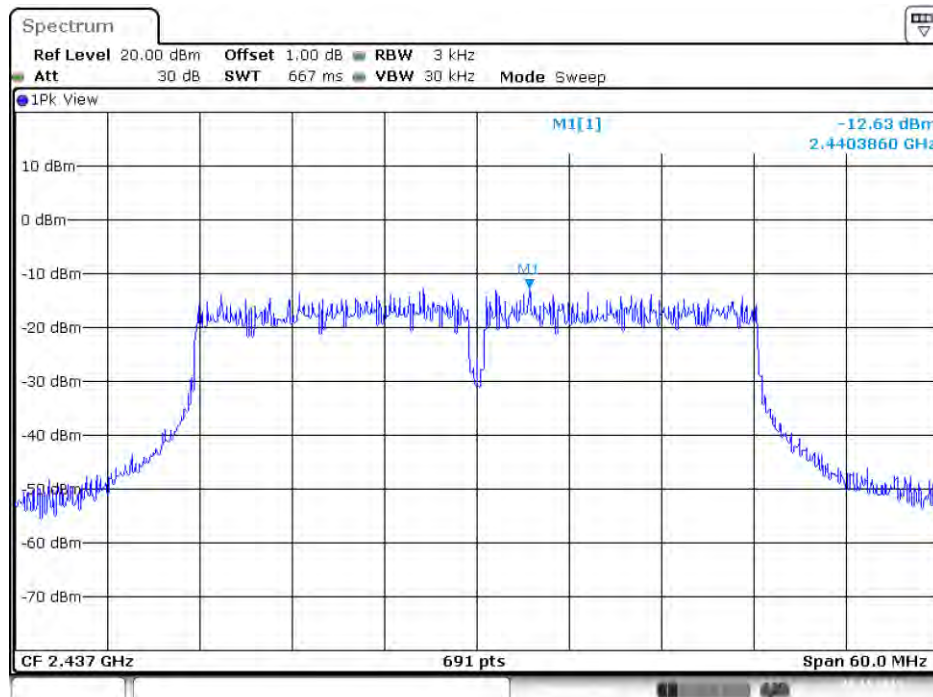

Date: 26.NOV.2015 13:13:01

Power Density Plot on Configuration IEEE 802.11ac MCS0/Nss1 VHT40 / 2437 MHz / Chain 3

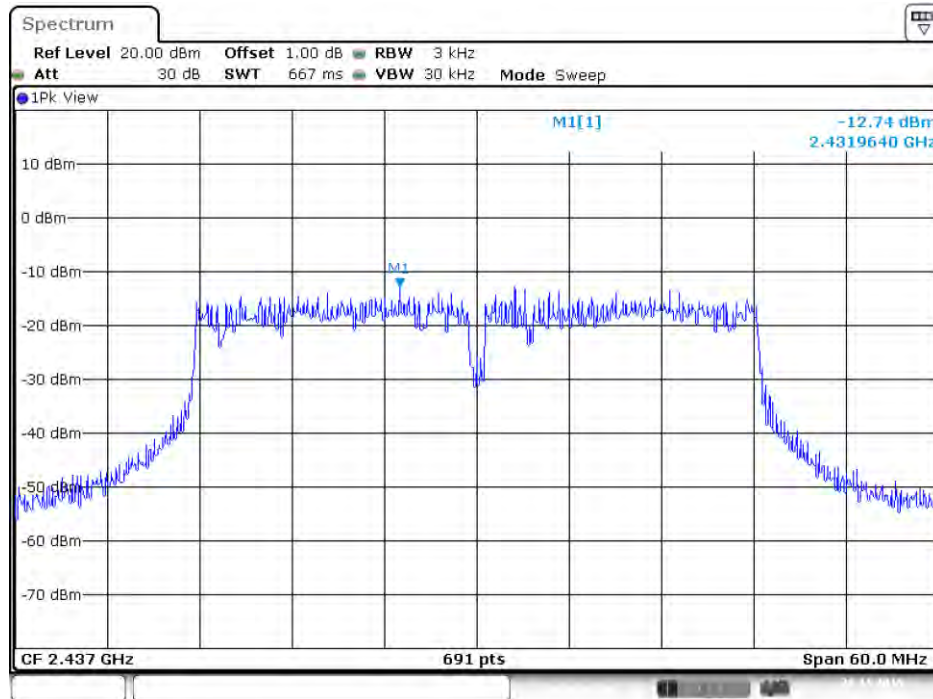

Date: 28.NOV.2015 13:12:31

Power Density Plot on Configuration IEEE 802.11ac MCS0/Nss1 VHT40 / 2437 MHz / Chain 4

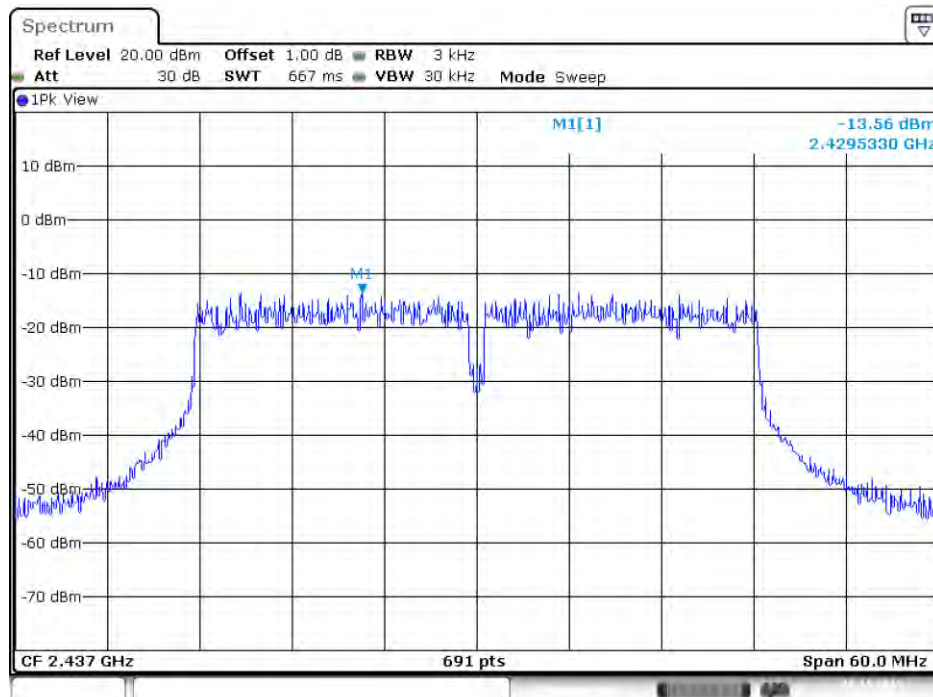

Date: 28.NOV.2015 13:11:40

Mode 2: EUT 1 + Set 2 Sector Antenna / 7.5 dBi

Power Density Plot on Configuration IEEE 802.11ac MCS0/Nss1 VHT20 / 2437 MHz / Chain 1

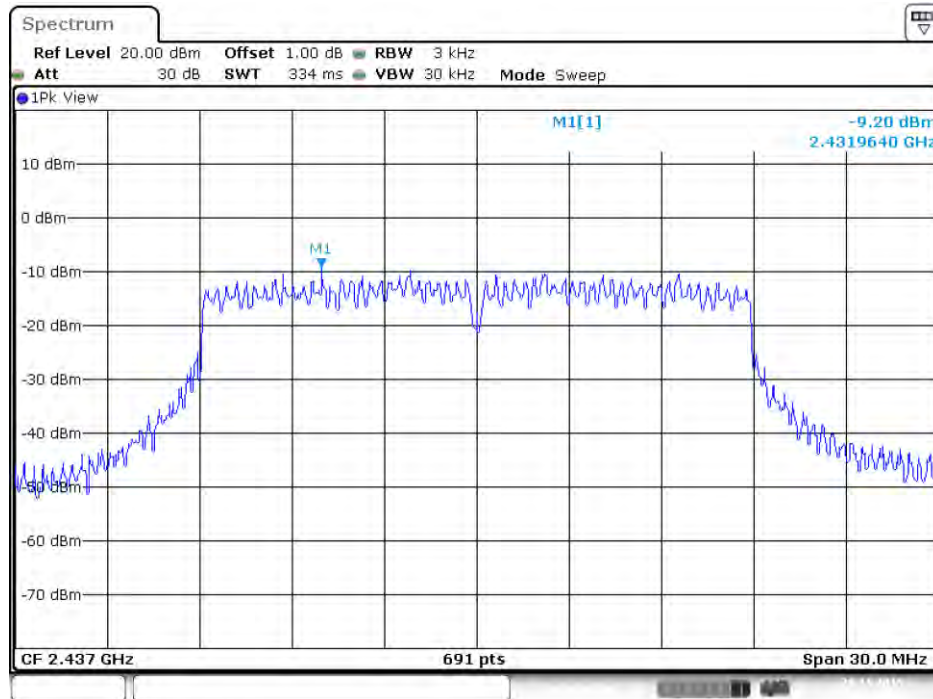

Date: 26.NOV.2015 12:42:07

Power Density Plot on Configuration IEEE 802.11ac MCS0/Nss1 VHT20 / 2437 MHz / Chain 2

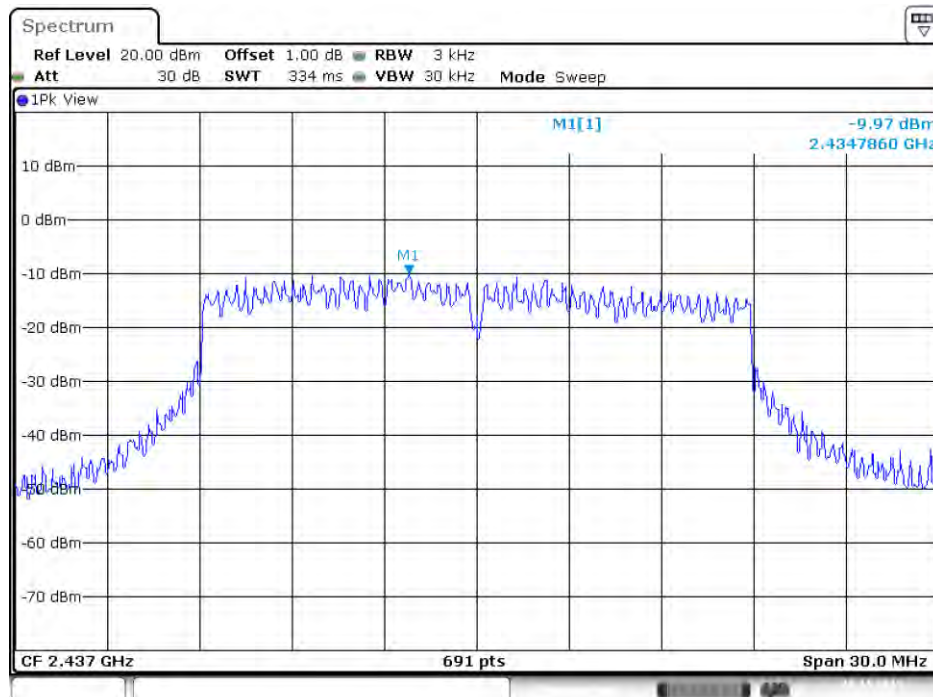

Date: 26.NOV.2015 12:41:34

Power Density Plot on Configuration IEEE 802.11ac MCS0/Nss1 VHT20 / 2437 MHz / Chain 3

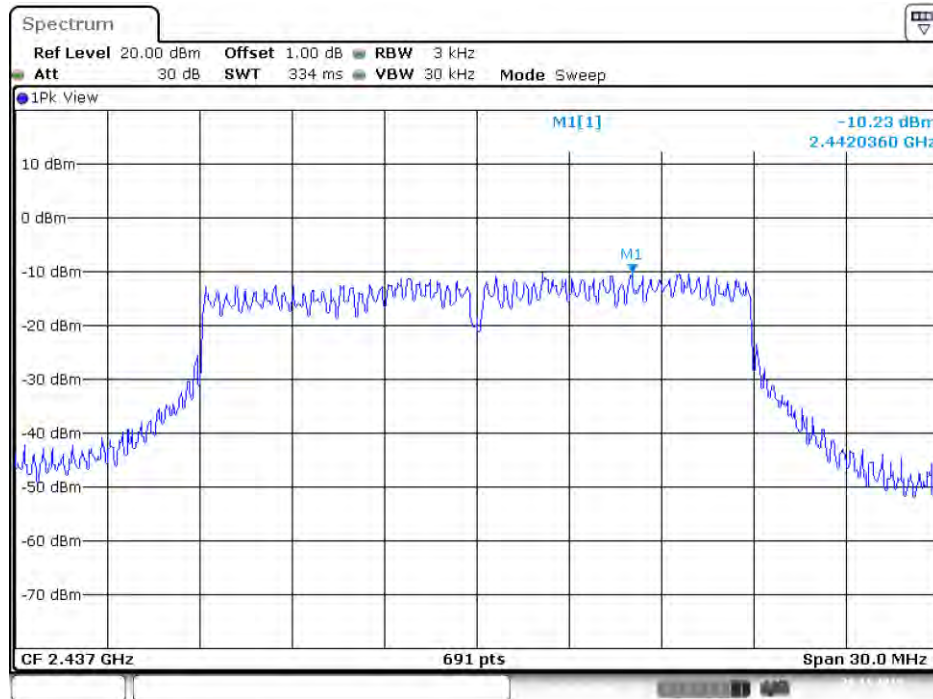

Date: 26.NOV.2015 12:41:04

Power Density Plot on Configuration IEEE 802.11ac MCS0/Nss1 VHT20 / 2437 MHz / Chain 4

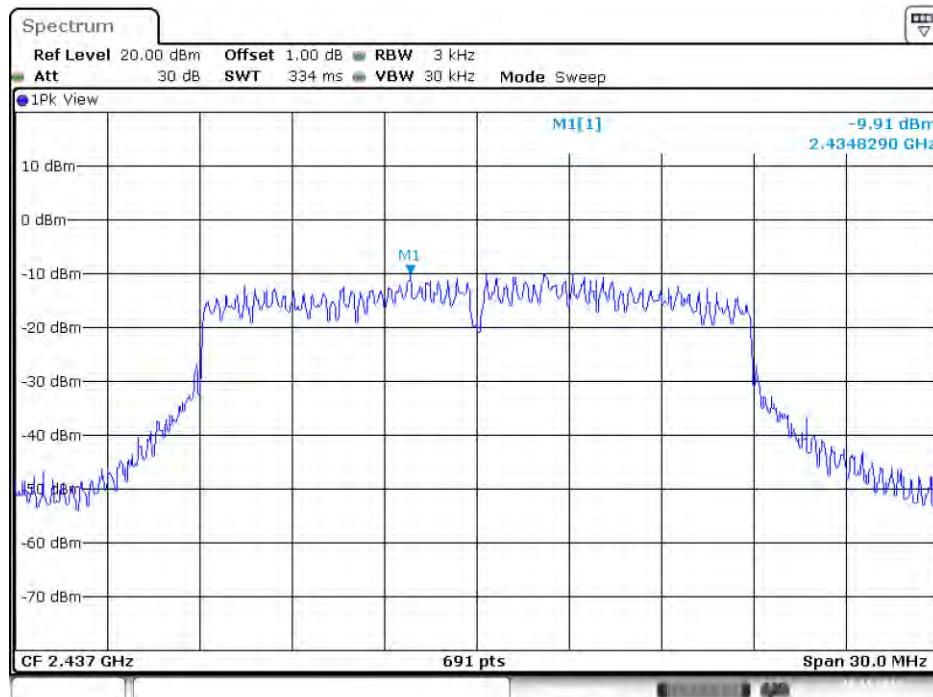

Date: 26.NOV.2015 12:40:25

Power Density Plot on Configuration IEEE 802.11ac MCS0/Nss1 VHT40 / 2437 MHz / Chain 1

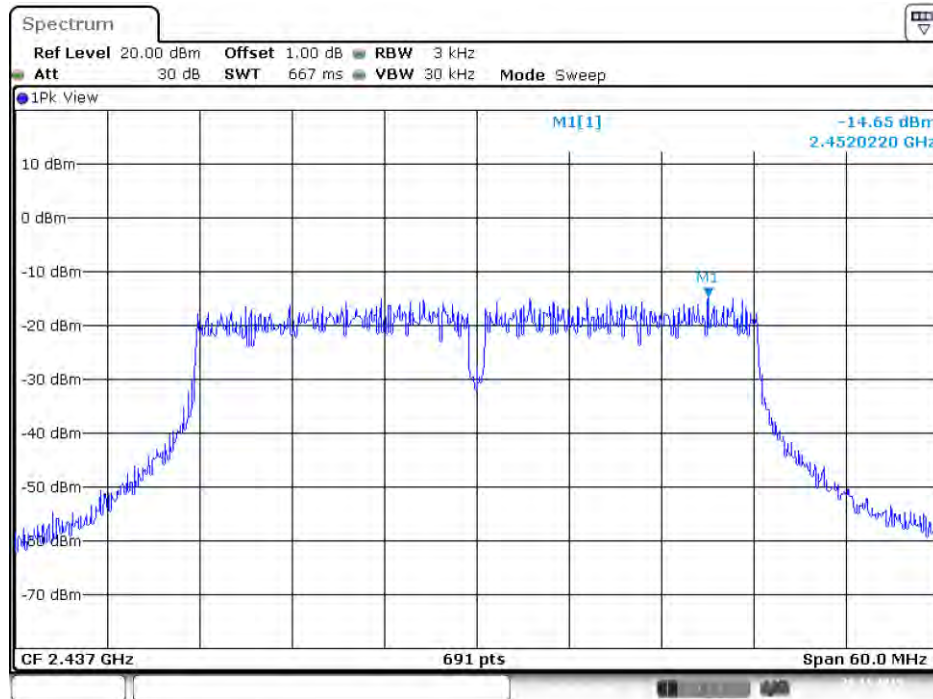

Date: 26.NOV.2015 13:42:13

Power Density Plot on Configuration IEEE 802.11ac MCS0/Nss1 VHT40 / 2437 MHz / Chain 2

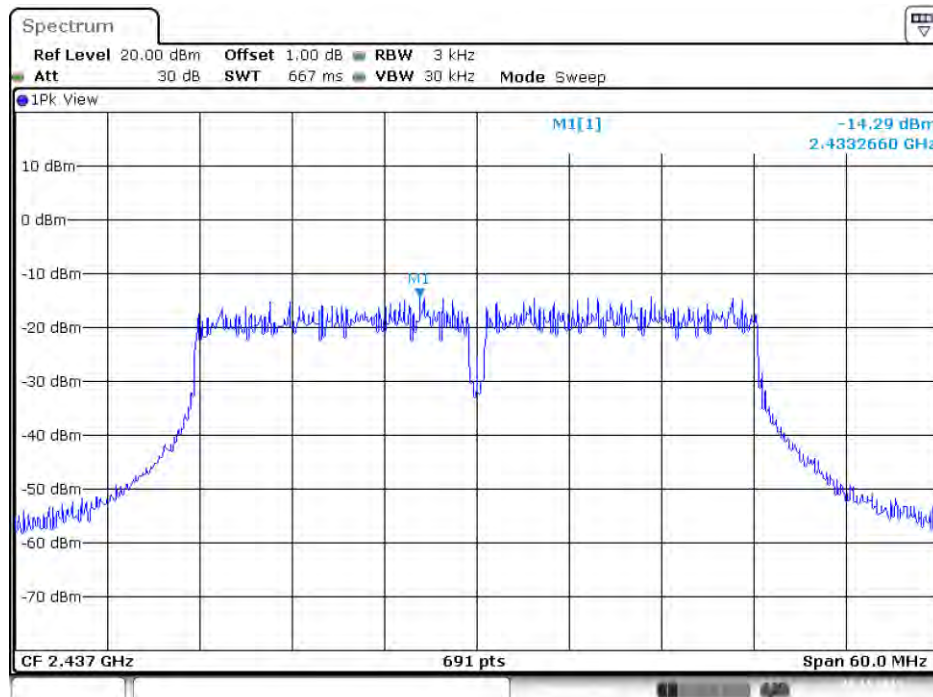

Date: 26.NOV.2015 13:41:40

Power Density Plot on Configuration IEEE 802.11ac MCS0/Nss1 VHT40 / 2437 MHz / Chain 3

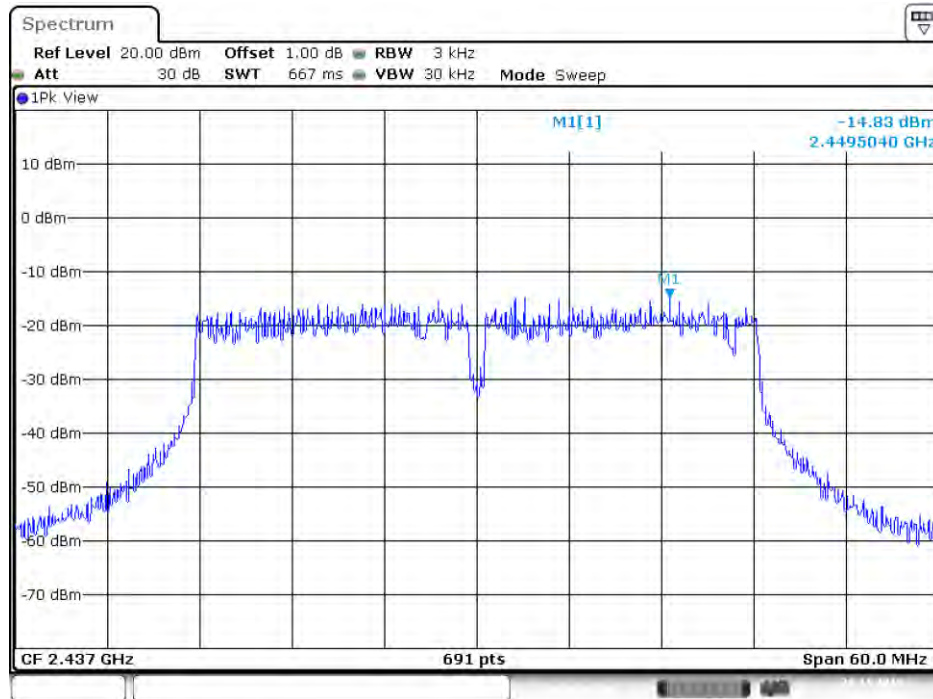

Date: 26.NOV.2015 13:40:28

Power Density Plot on Configuration IEEE 802.11ac MCS0/Nss1 VHT40 / 2437 MHz / Chain 4

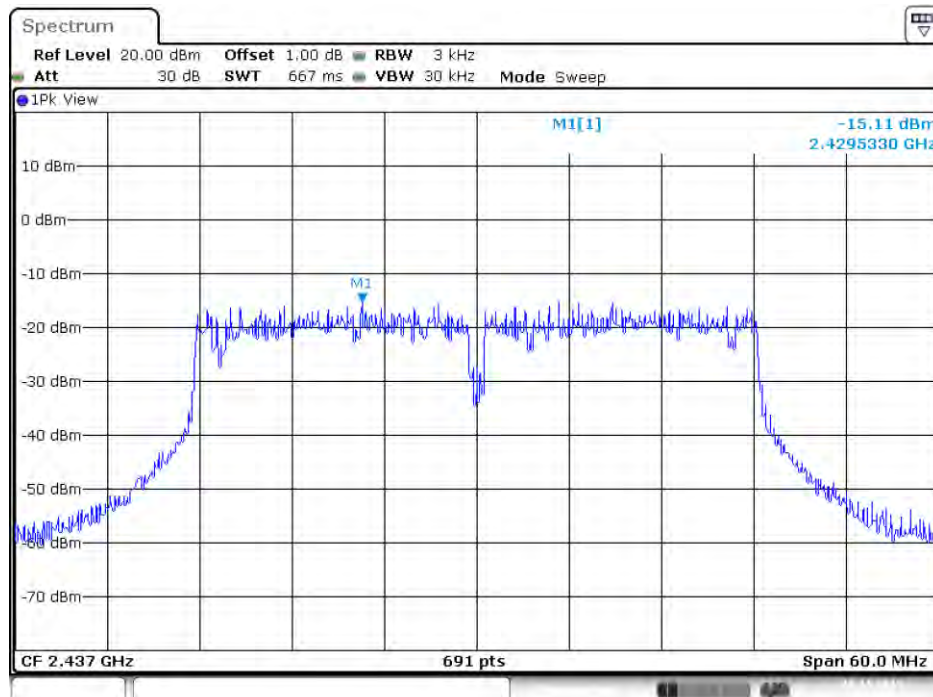

Date: 26.NOV.2015 13:40:01

Mode 3: EUT 1 + Set 3 Sector Antenna / 5.5 dBi

Power Density Plot on Configuration IEEE 802.11ac MCS0/Nss1 VHT20 / 2437 MHz / Chain 1

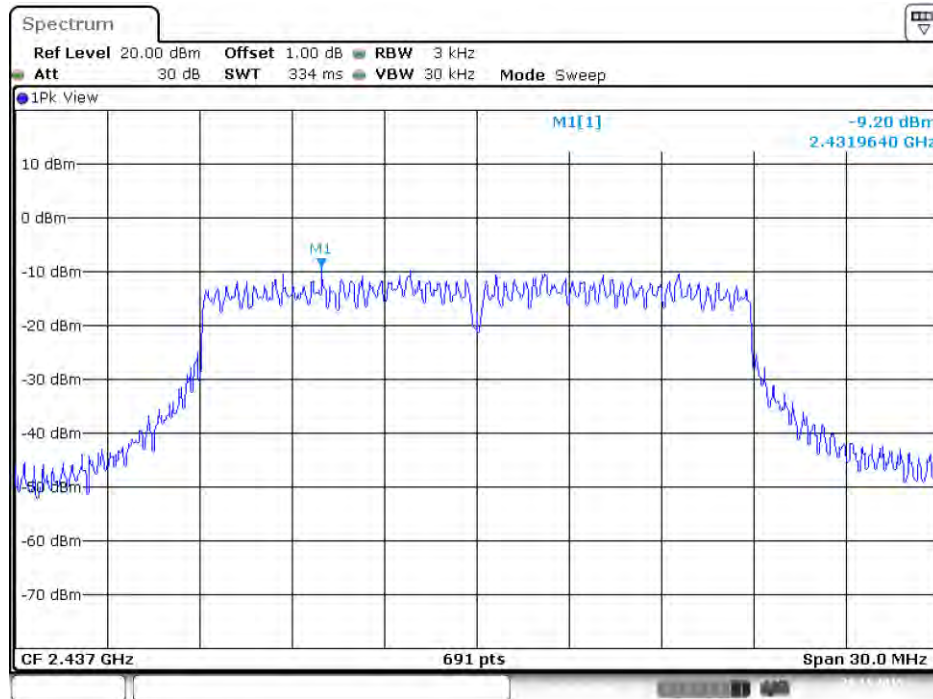

Date: 26.NOV.2015 12:42:07

Power Density Plot on Configuration IEEE 802.11ac MCS0/Nss1 VHT20 / 2437 MHz / Chain 2

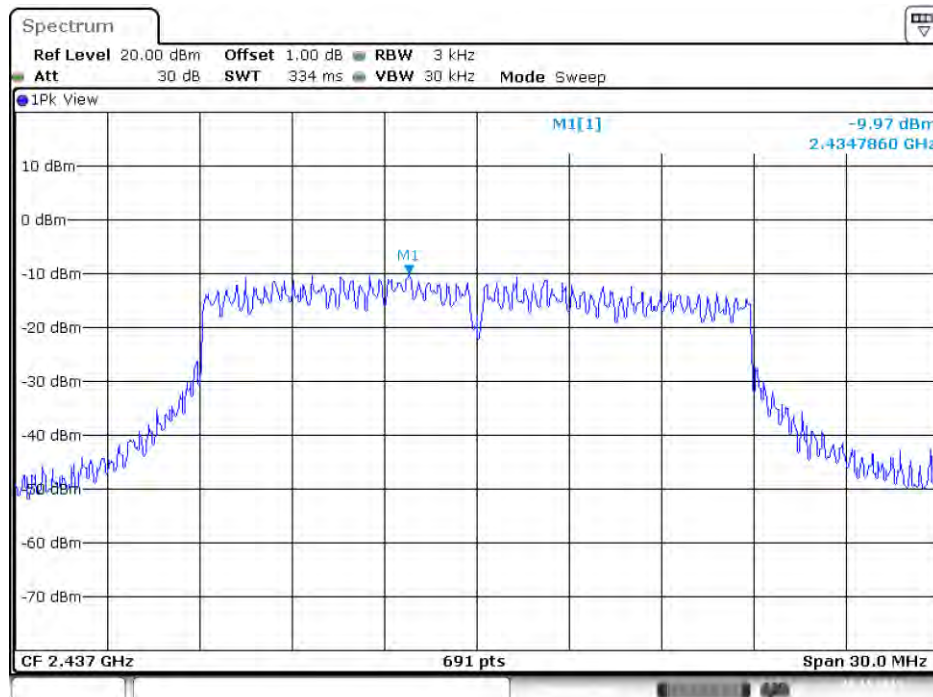

Date: 26.NOV.2015 12:41:34

Power Density Plot on Configuration IEEE 802.11ac MCS0/Nss1 VHT20 / 2437 MHz / Chain 3

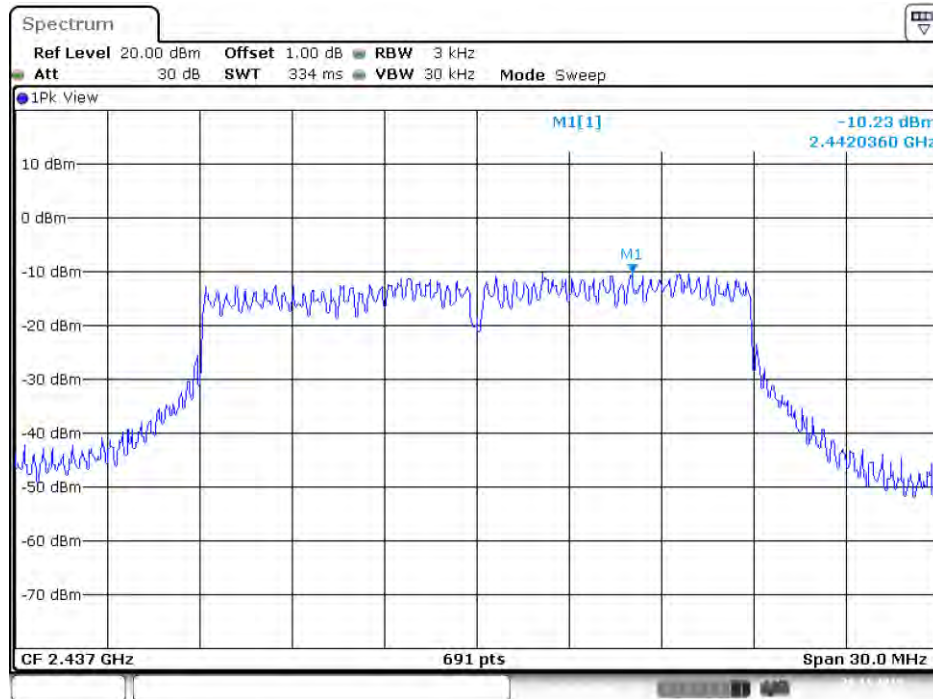

Date: 26.NOV.2015 12:41:04

Power Density Plot on Configuration IEEE 802.11ac MCS0/Nss1 VHT20 / 2437 MHz / Chain 4

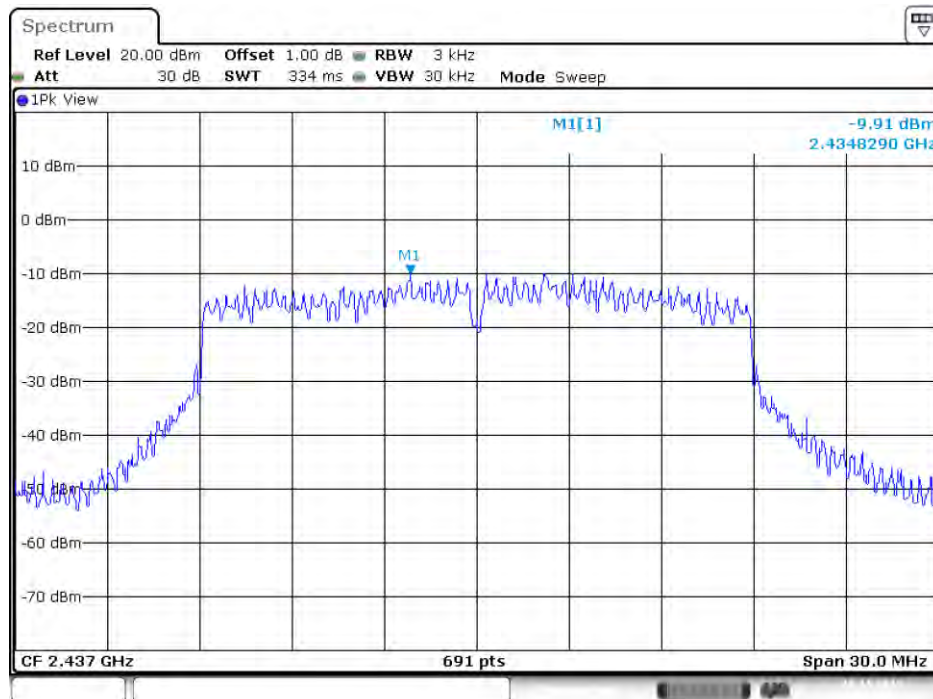

Date: 26.NOV.2015 12:40:25

Power Density Plot on Configuration IEEE 802.11ac MCS0/Nss1 VHT40 / 2437 MHz / Chain 1

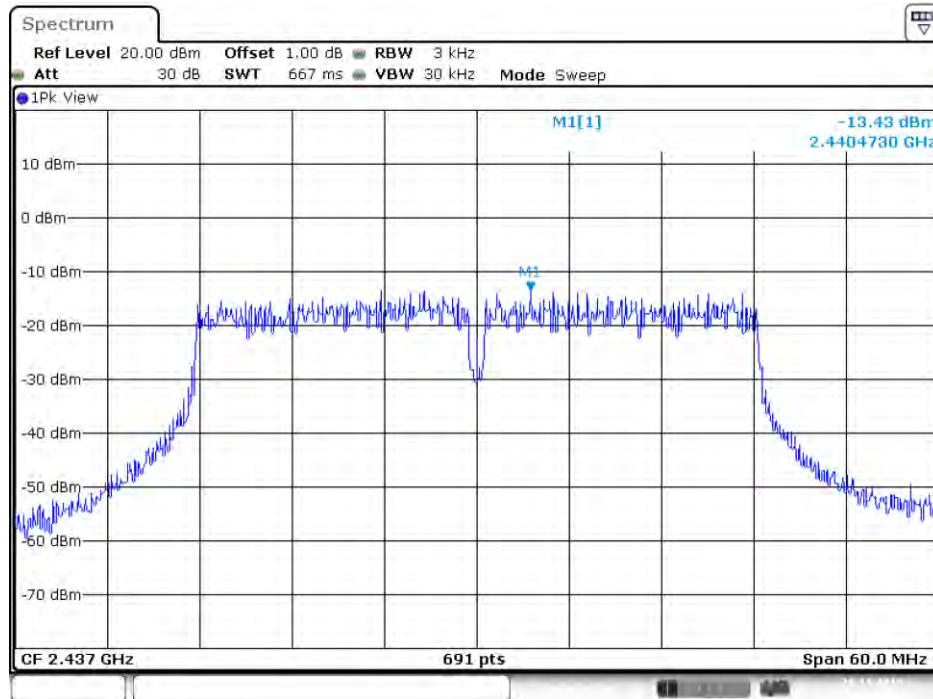

Power Density Plot on Configuration IEEE 802.11ac MCS0/Nss1 VHT40 / 2437 MHz / Chain 2

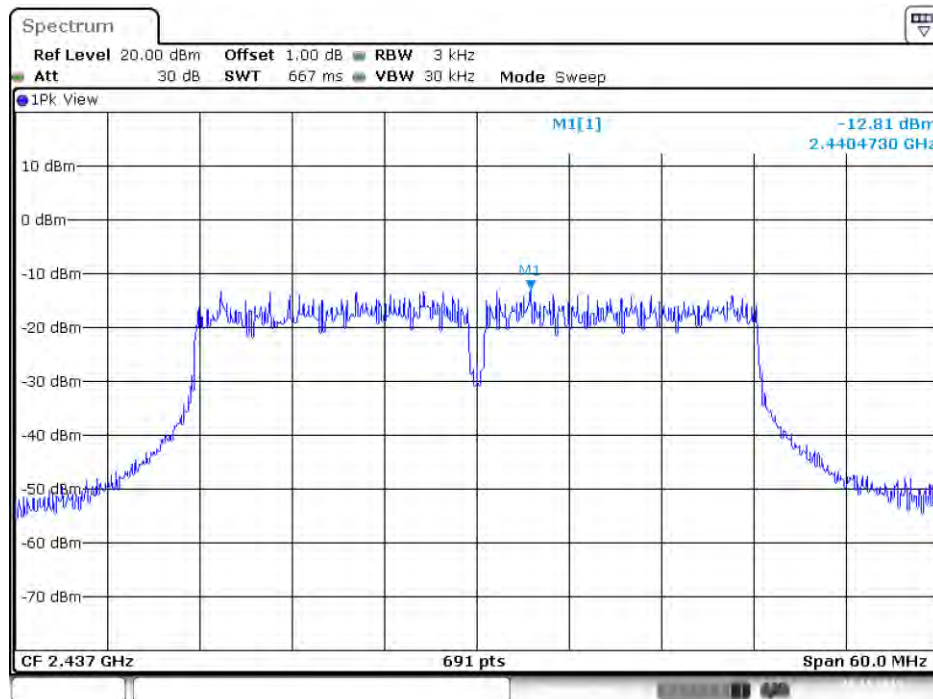

Power Density Plot on Configuration IEEE 802.11ac MCS0/Nss1 VHT40 / 2437 MHz / Chain 3

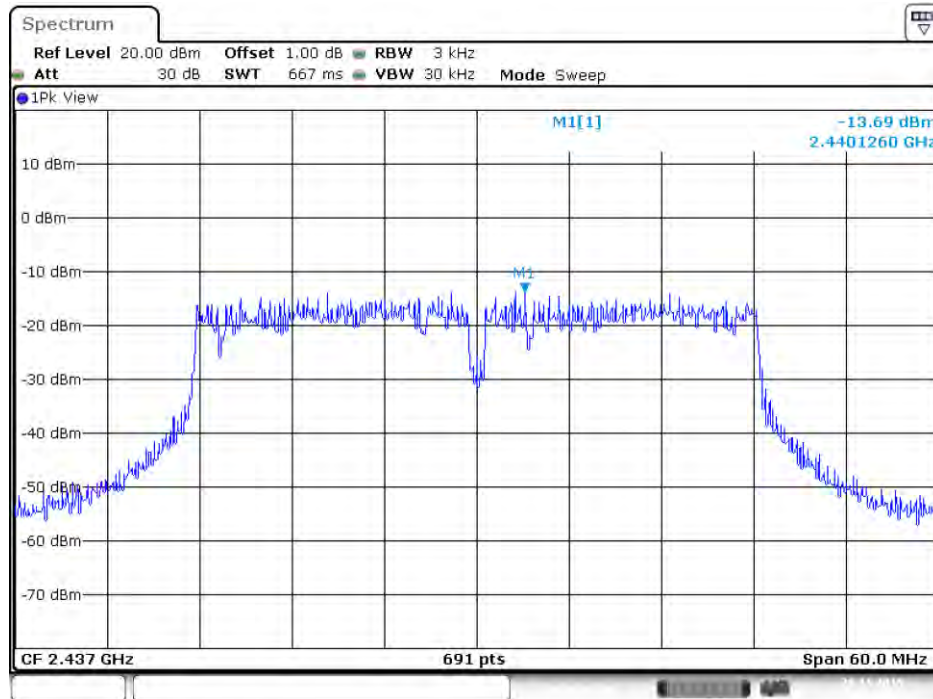

Date: 28.NOV.2015 13:00:43

Power Density Plot on Configuration IEEE 802.11ac MCS0/Nss1 VHT40 / 2437 MHz / Chain 4

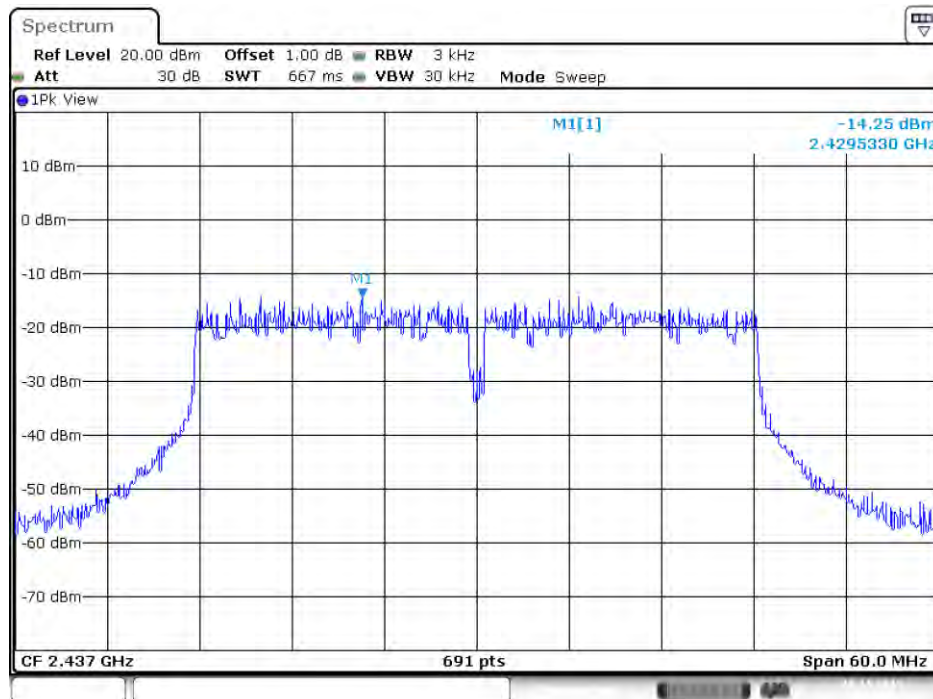

Date: 28.NOV.2015 13:01:10

Mode 4: EUT 1 + Set 4 Sector Antenna / 10.5 dBi

Power Density Plot on Configuration IEEE 802.11ac MCS0/Nss1 VHT20 / 2437 MHz / Chain 1

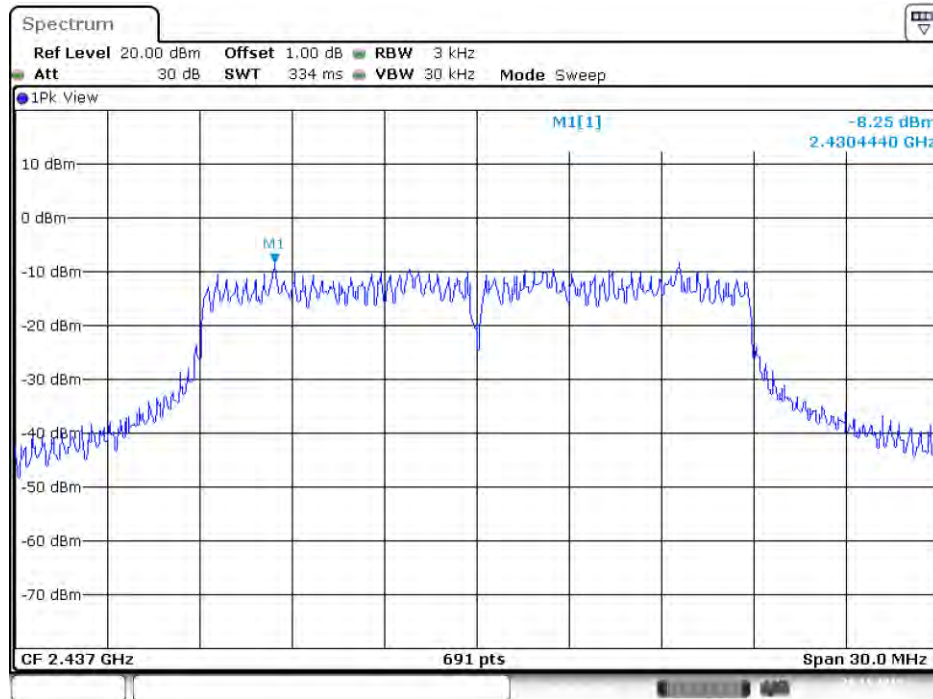

Date: 26.NOV.2015 14:23:05

Power Density Plot on Configuration IEEE 802.11ac MCS0/Nss1 VHT20 / 2437 MHz / Chain 2

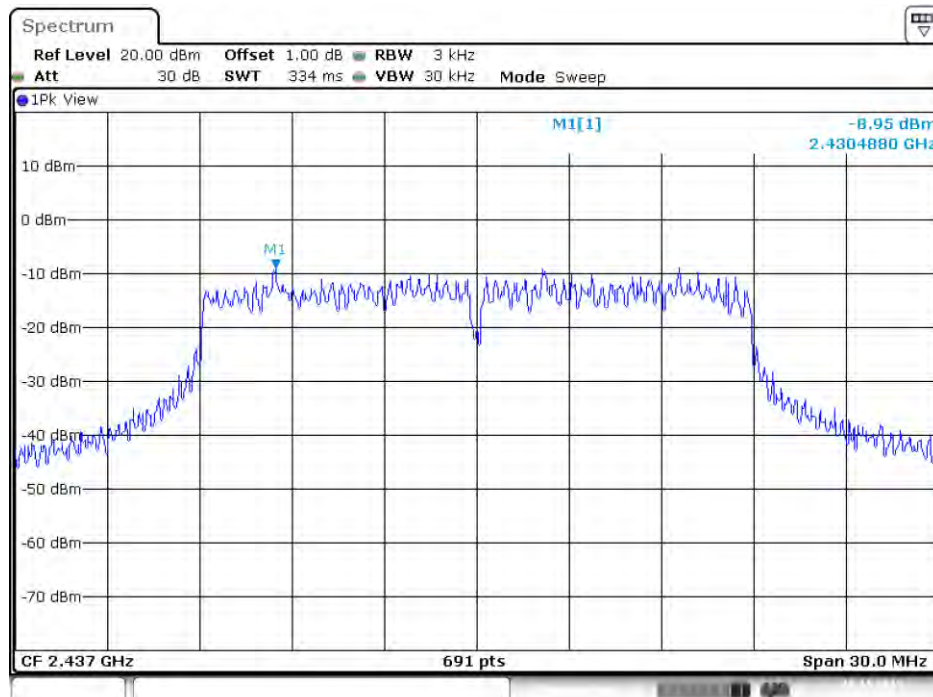

Date: 26.NOV.2015 14:23:34

Power Density Plot on Configuration IEEE 802.11ac MCS0/Nss1 VHT20 / 2437 MHz / Chain 3

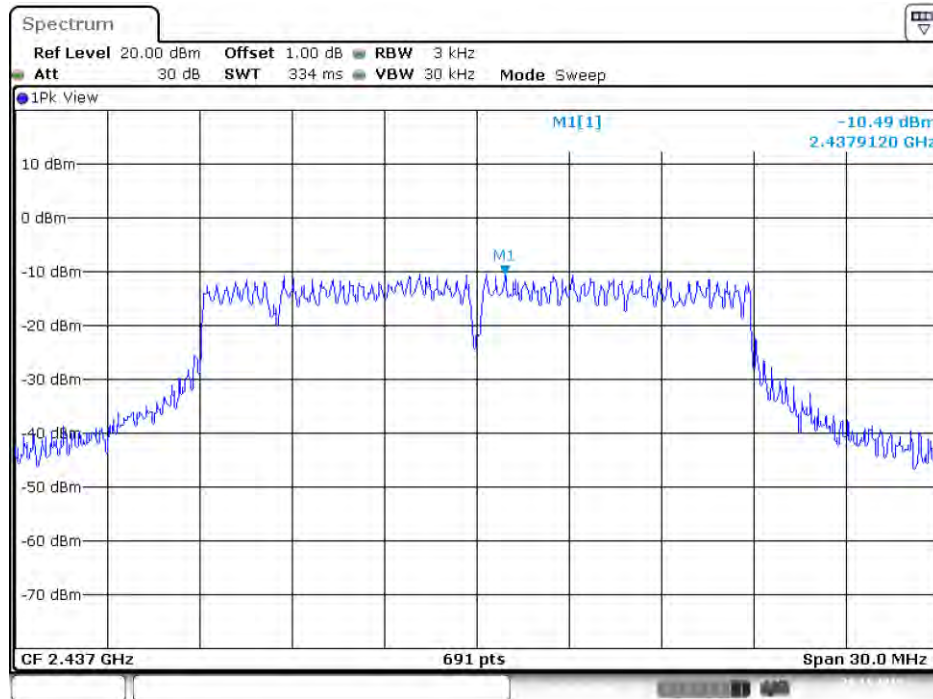

Date: 28.NOV.2015 14:24:21

Power Density Plot on Configuration IEEE 802.11ac MCS0/Nss1 VHT20 / 2437 MHz / Chain 4

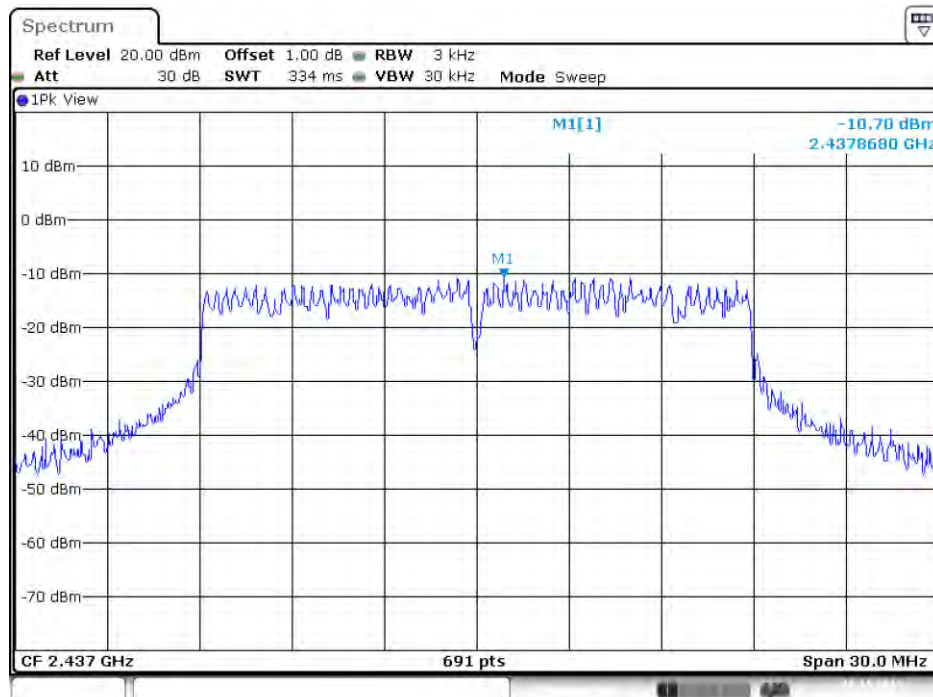

Date: 28.NOV.2015 14:25:02

Power Density Plot on Configuration IEEE 802.11ac MCS0/Nss1 VHT40 / 2437 MHz / Chain 1

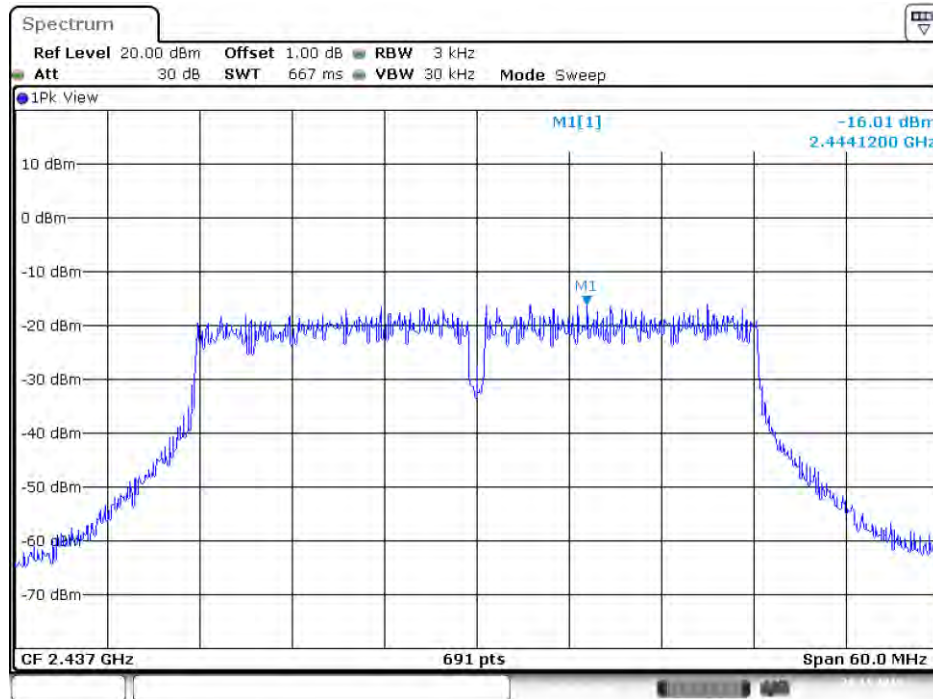

Date: 28.NOV.2015 13:51:09

Power Density Plot on Configuration IEEE 802.11ac MCS0/Nss1 VHT40 / 2437 MHz / Chain 2

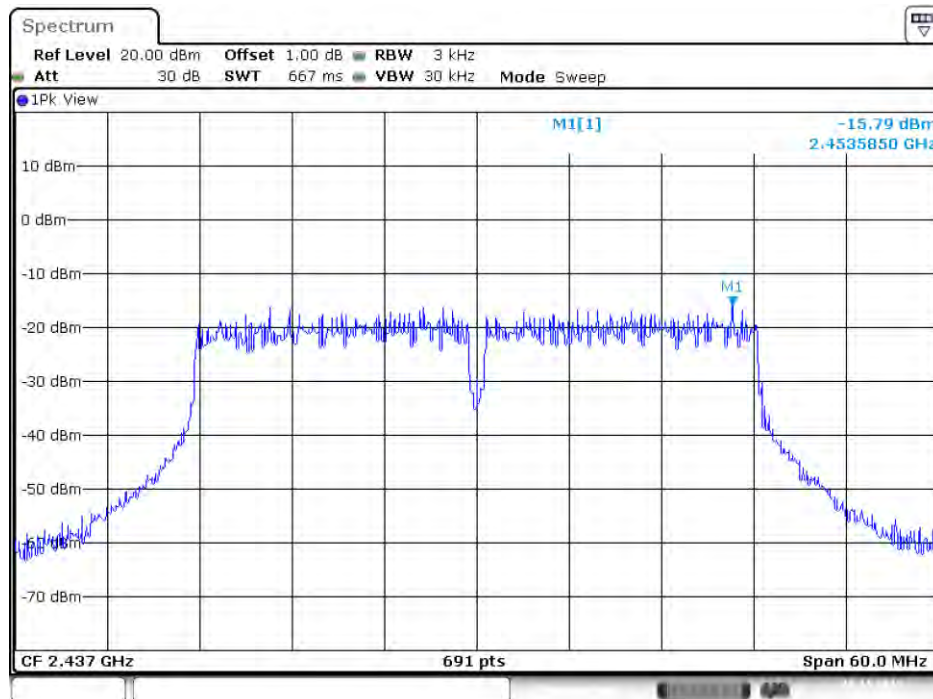

Date: 28.NOV.2015 13:51:36

Power Density Plot on Configuration IEEE 802.11ac MCS0/Nss1 VHT40 / 2437 MHz / Chain 3

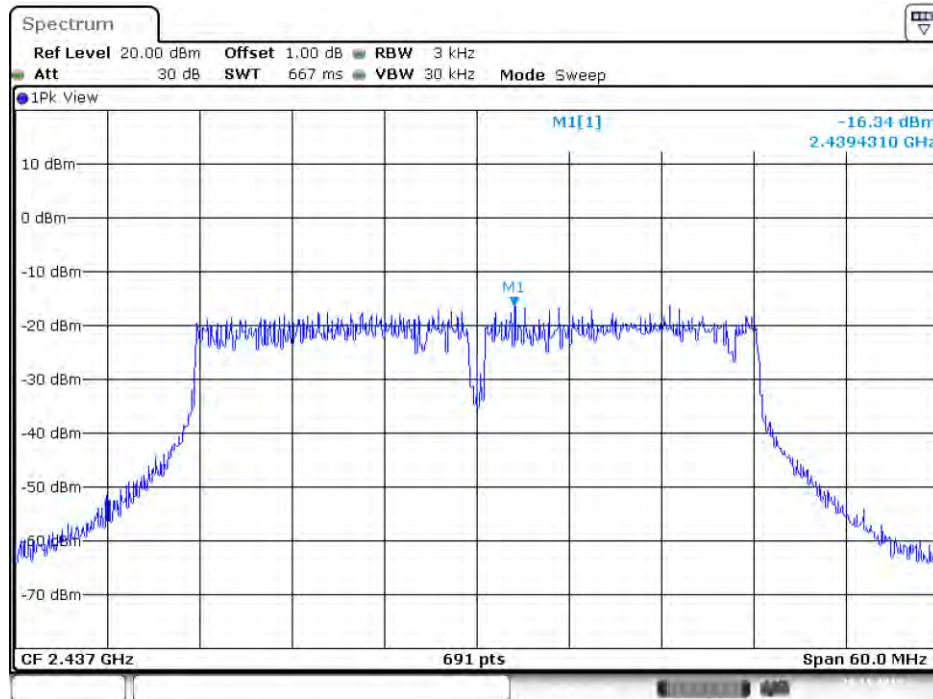

Date: 28.NOV.2015 13:52:16

Power Density Plot on Configuration IEEE 802.11ac MCS0/Nss1 VHT40 / 2437 MHz / Chain 4

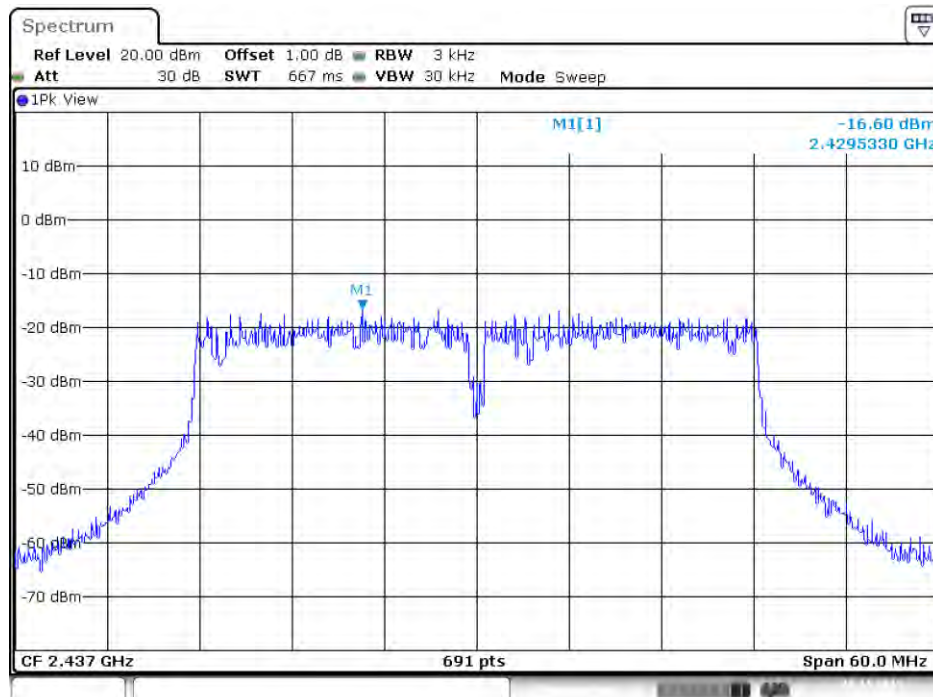

Date: 28.NOV.2015 13:52:50

Mode 5: EUT 1 + Set 7 Sector Antenna / 5 dBi

Power Density Plot on Configuration IEEE 802.11ac MCS0/Nss1 VHT20 / 2437 MHz / Chain 1

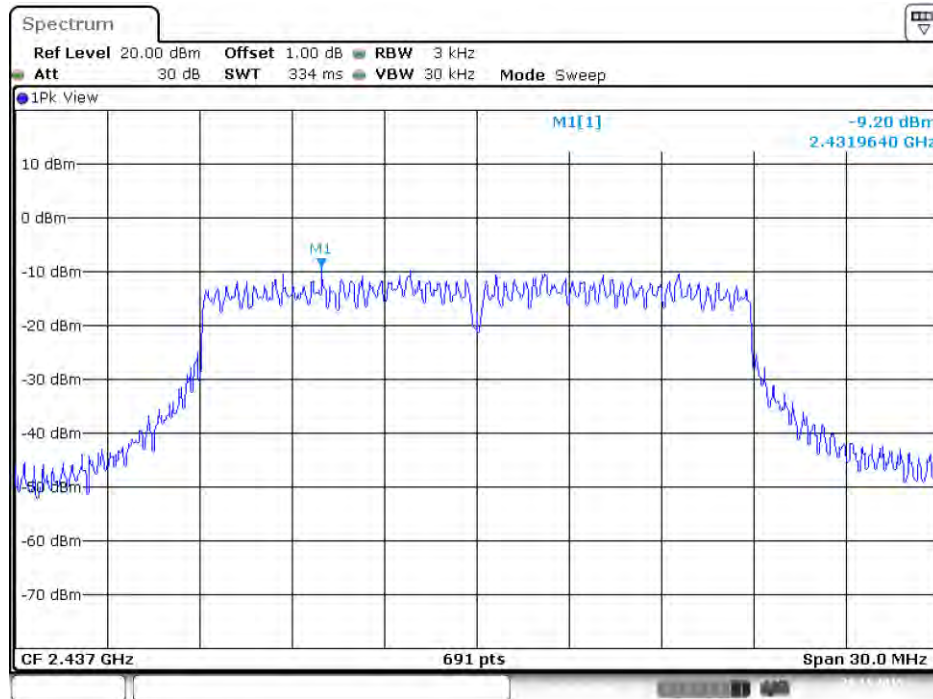

Date: 26.NOV.2015 12:42:07

Power Density Plot on Configuration IEEE 802.11ac MCS0/Nss1 VHT20 / 2437 MHz / Chain 2

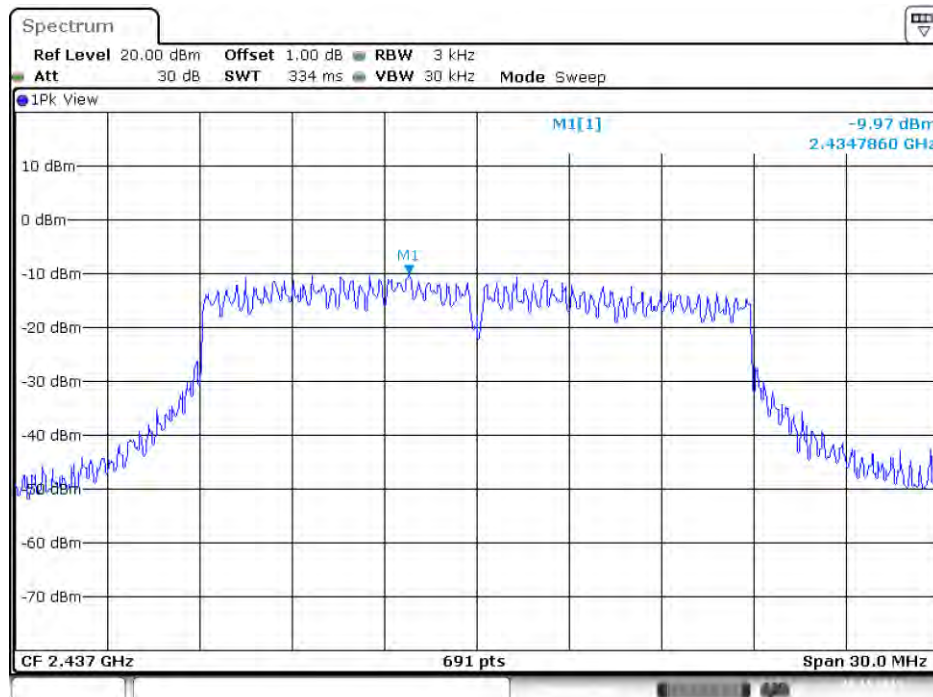

Date: 26.NOV.2015 12:41:34

Power Density Plot on Configuration IEEE 802.11ac MCS0/Nss1 VHT20 / 2437 MHz / Chain 3

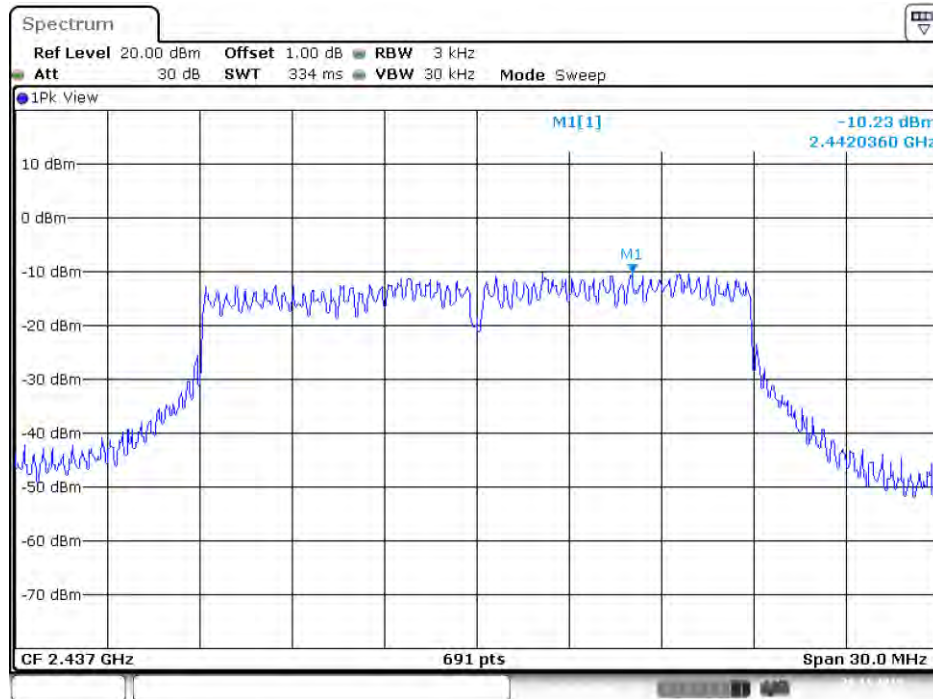

Date: 26.NOV.2015 12:41:04

Power Density Plot on Configuration IEEE 802.11ac MCS0/Nss1 VHT20 / 2437 MHz / Chain 4

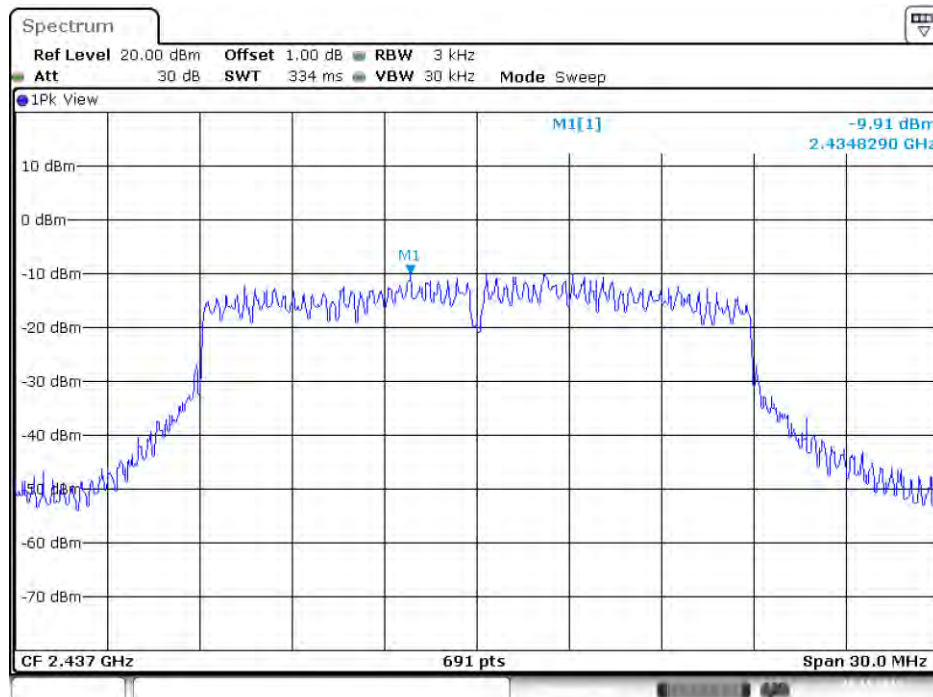

Date: 26.NOV.2015 12:40:25

Power Density Plot on Configuration IEEE 802.11ac MCS0/Nss1 VHT40 / 2437 MHz / Chain 1

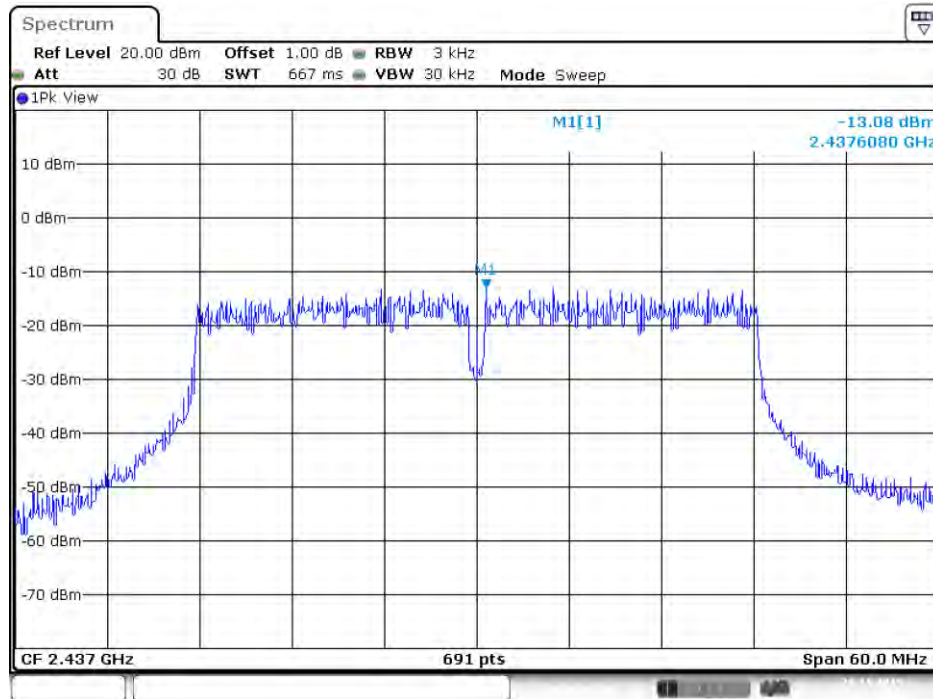

Date: 26.NOV.2015 13:13:29

Power Density Plot on Configuration IEEE 802.11ac MCS0/Nss1 VHT40 / 2437 MHz / Chain 2

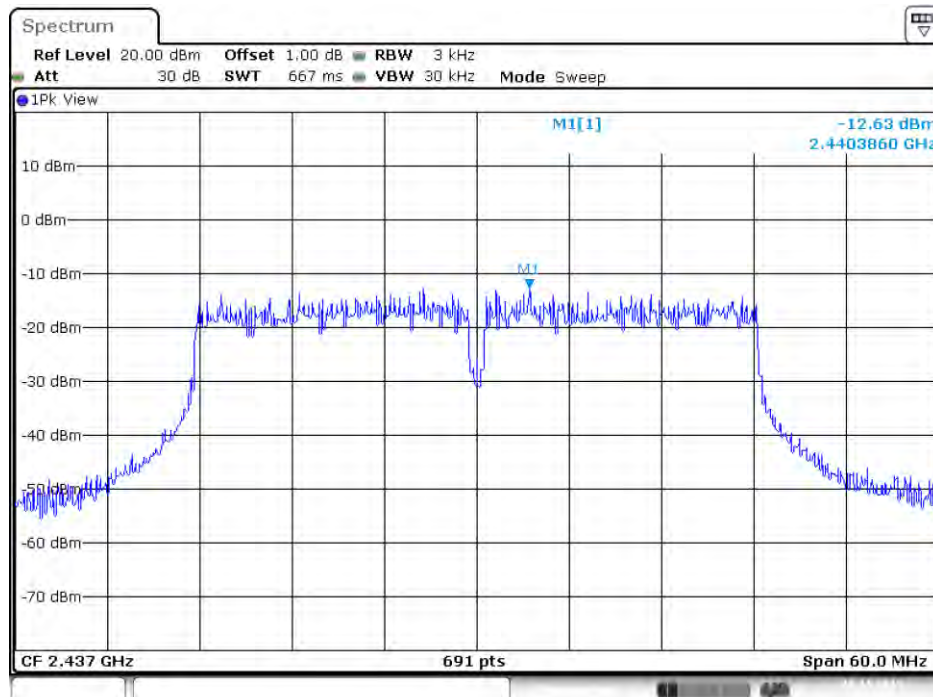

Date: 26.NOV.2015 13:13:01

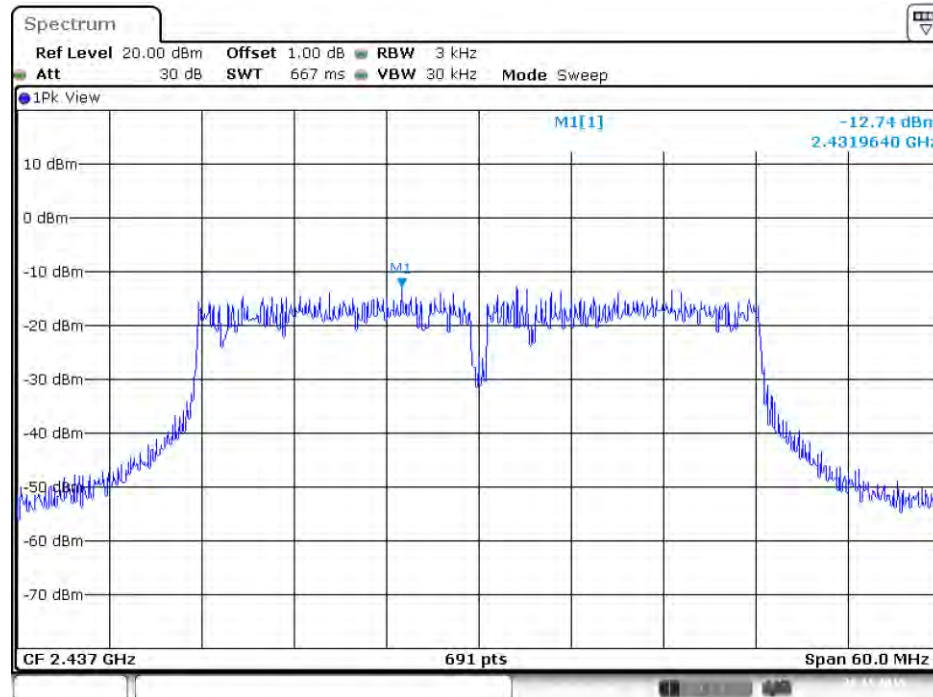
Power Density Plot on Configuration IEEE 802.11ac MCS0/Nss1 VHT40 / 2437 MHz / Chain 3

Date: 28.NOV.2015 13:12:31

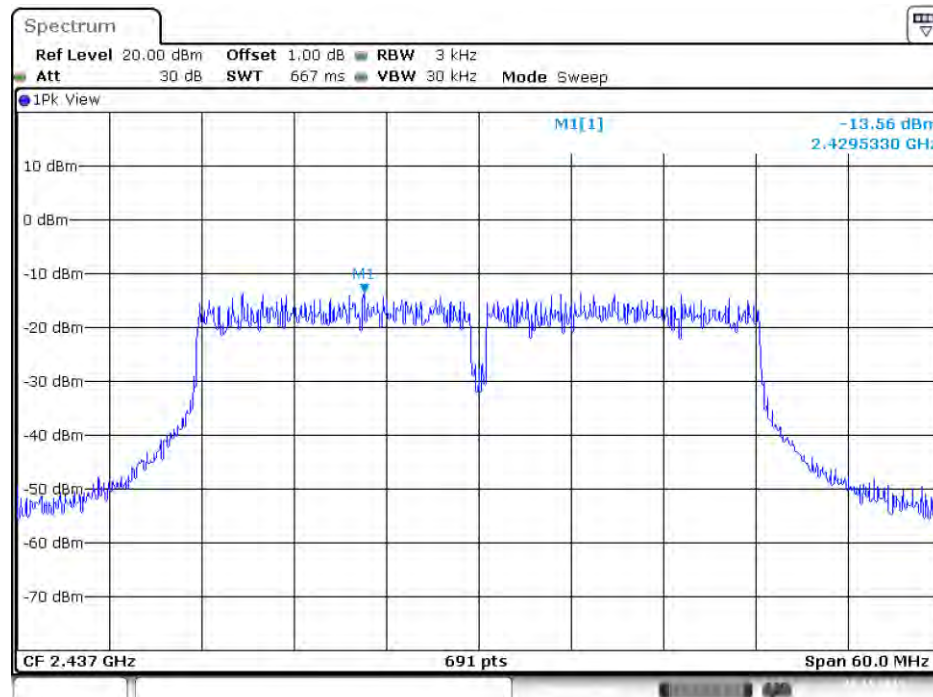
Power Density Plot on Configuration IEEE 802.11ac MCS0/Nss1 VHT40 / 2437 MHz / Chain 4

Date: 28.NOV.2015 13:11:40

Mode 6: EUT 1 + Set 8 Dipole Antenna / 4.66 dBi

Power Density Plot on Configuration IEEE 802.11ac MCS0/Nss1 VHT20 / 2437 MHz / Chain 1

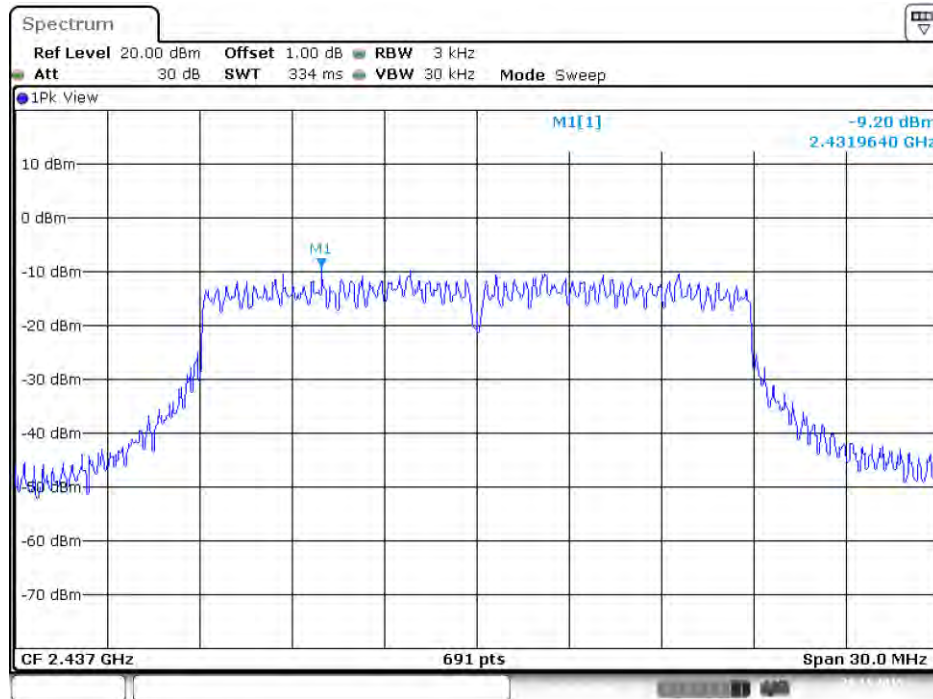

Date: 26.NOV.2015 12:42:07

Power Density Plot on Configuration IEEE 802.11ac MCS0/Nss1 VHT20 / 2437 MHz / Chain 2

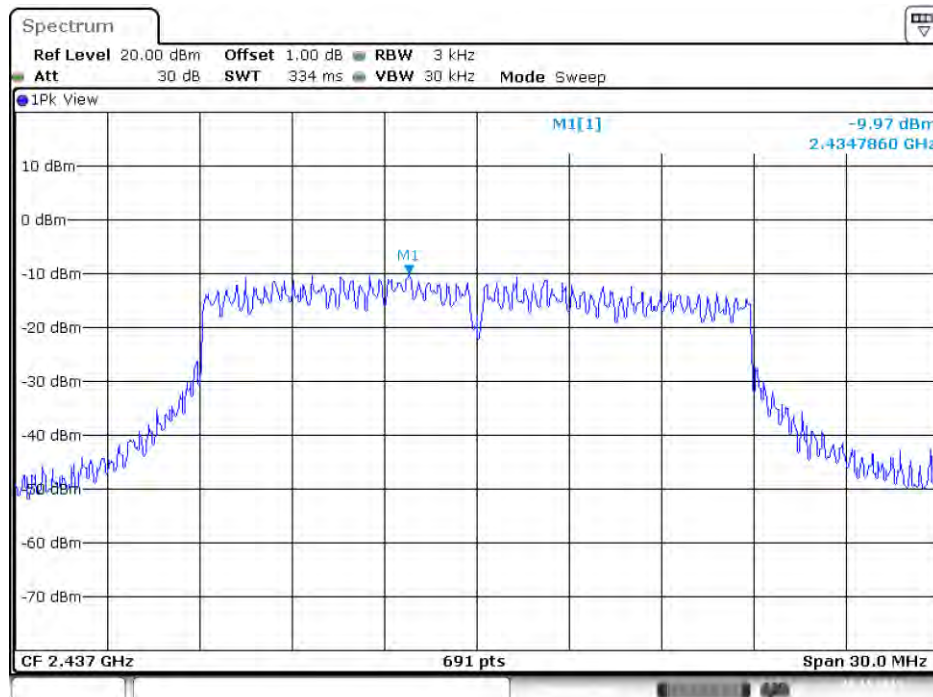

Date: 26.NOV.2015 12:41:34

Power Density Plot on Configuration IEEE 802.11ac MCS0/Nss1 VHT20 / 2437 MHz / Chain 3

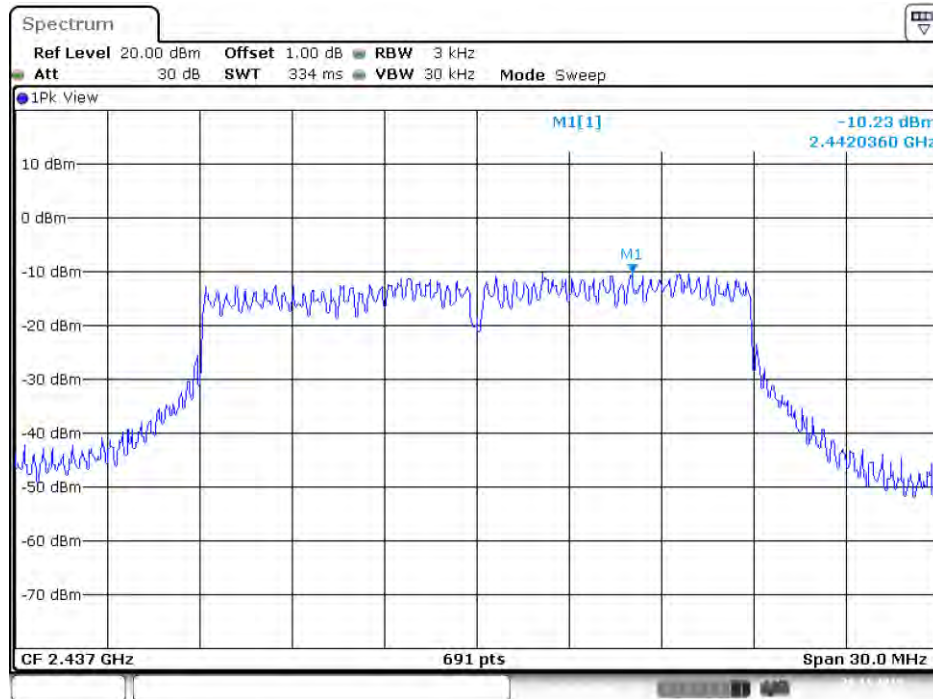

Date: 26.NOV.2015 12:41:04

Power Density Plot on Configuration IEEE 802.11ac MCS0/Nss1 VHT20 / 2437 MHz / Chain 4

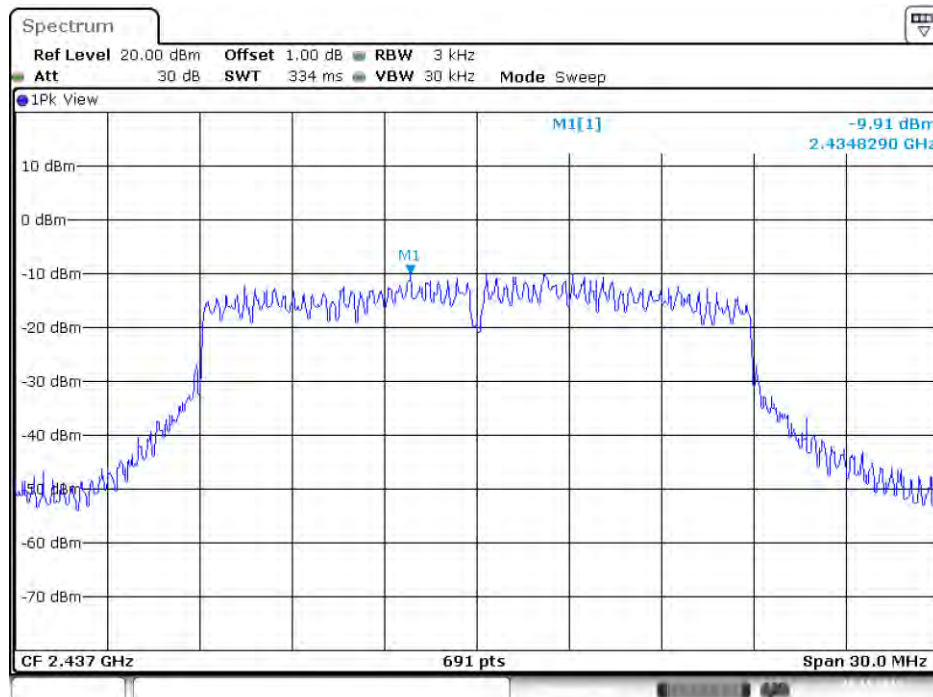

Date: 26.NOV.2015 12:40:25

Power Density Plot on Configuration IEEE 802.11ac MCS0/Nss1 VHT40 / 2437 MHz / Chain 1

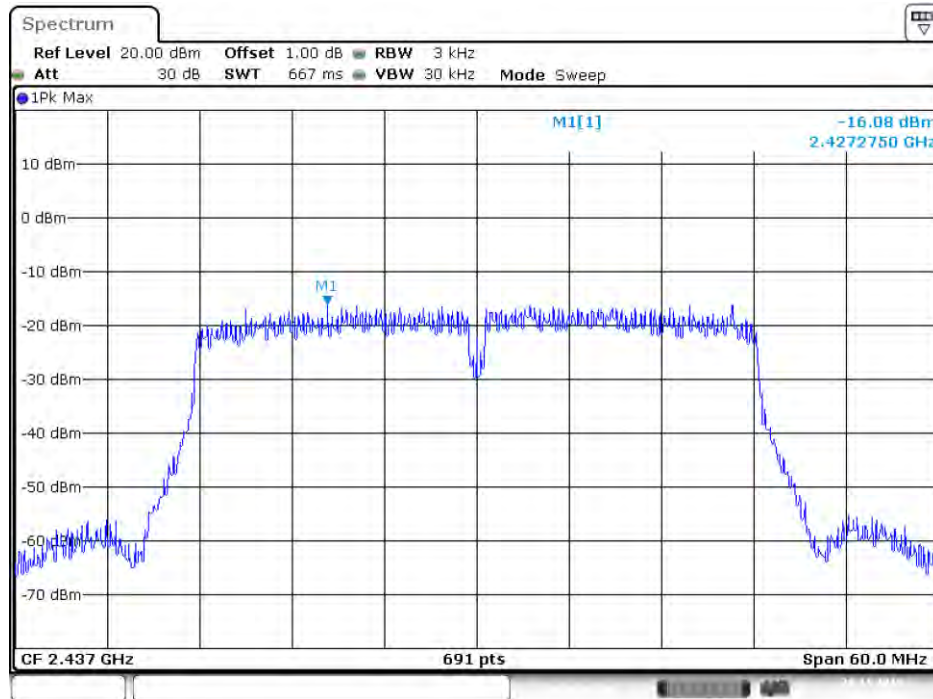

Date: 28.NOV.2015 16:52:57

Power Density Plot on Configuration IEEE 802.11ac MCS0/Nss1 VHT40 / 2437 MHz / Chain 2

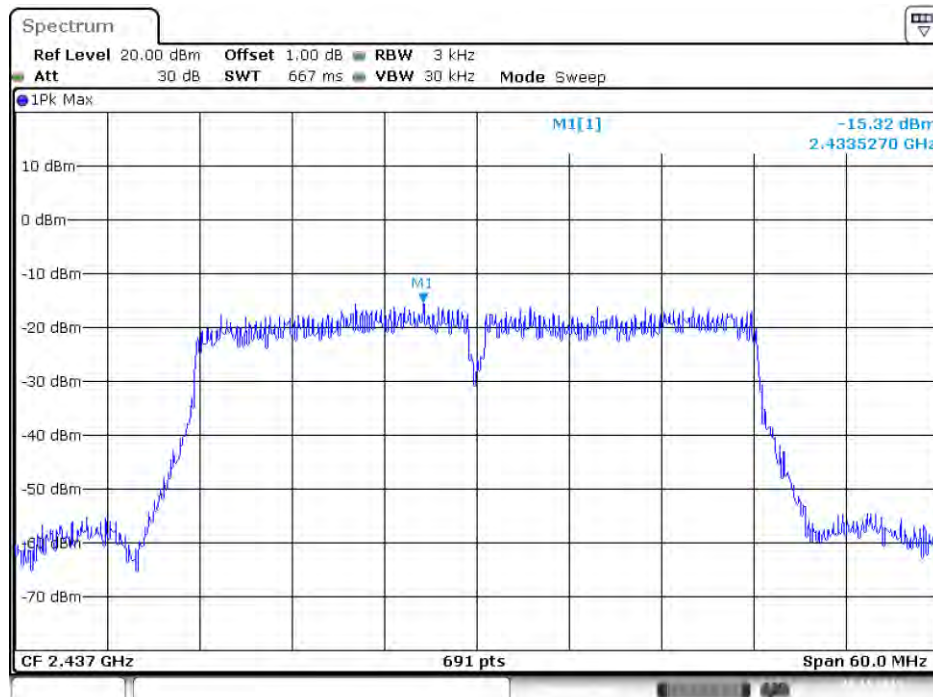

Date: 28.NOV.2015 16:53:32

Power Density Plot on Configuration IEEE 802.11ac MCS0/Nss1 VHT40 / 2437 MHz / Chain 3

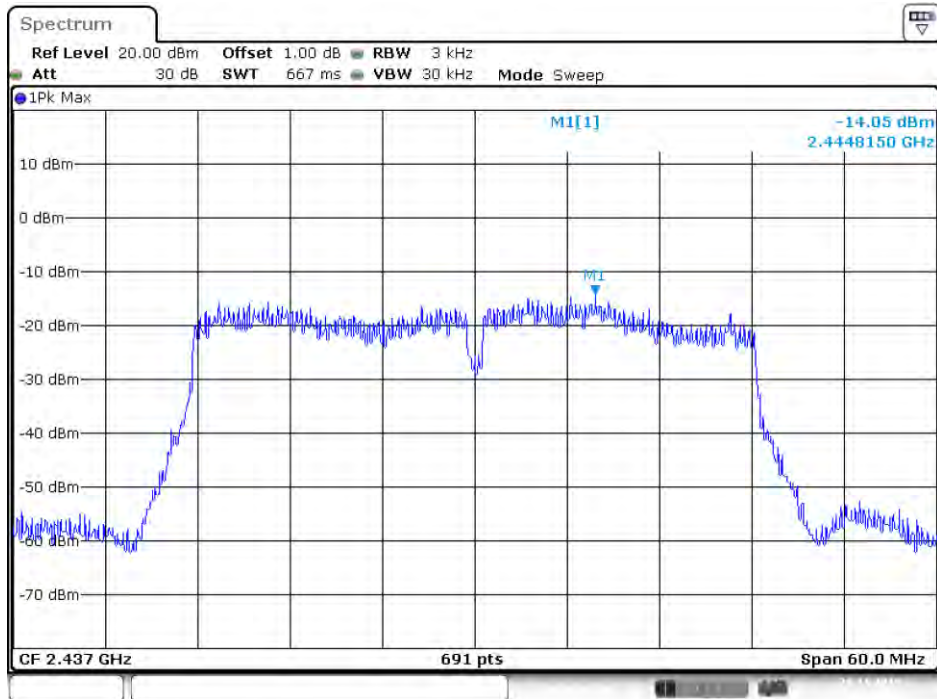

Date: 28.NOV.2015 16:54:53

Power Density Plot on Configuration IEEE 802.11ac MCS0/Nss1 VHT40 / 2437 MHz / Chain 4

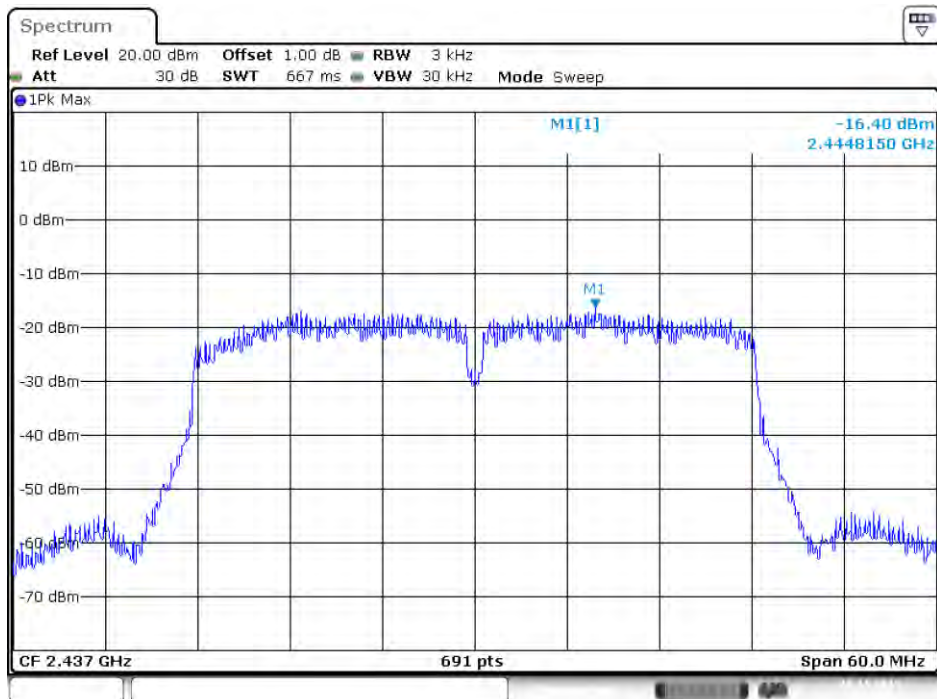

Date: 28.NOV.2015 16:55:27

Mode 7: EUT 2 + Set 10 PIFA Antenna / Chain1:3.81 dBi, Chain2:3.75 dBi, Chain3:3.98 dBi, Chain4:3.47 dBi

Power Density Plot on Configuration IEEE 802.11ac MCS0/Nss1 VHT20 / 2437 MHz / Chain 1

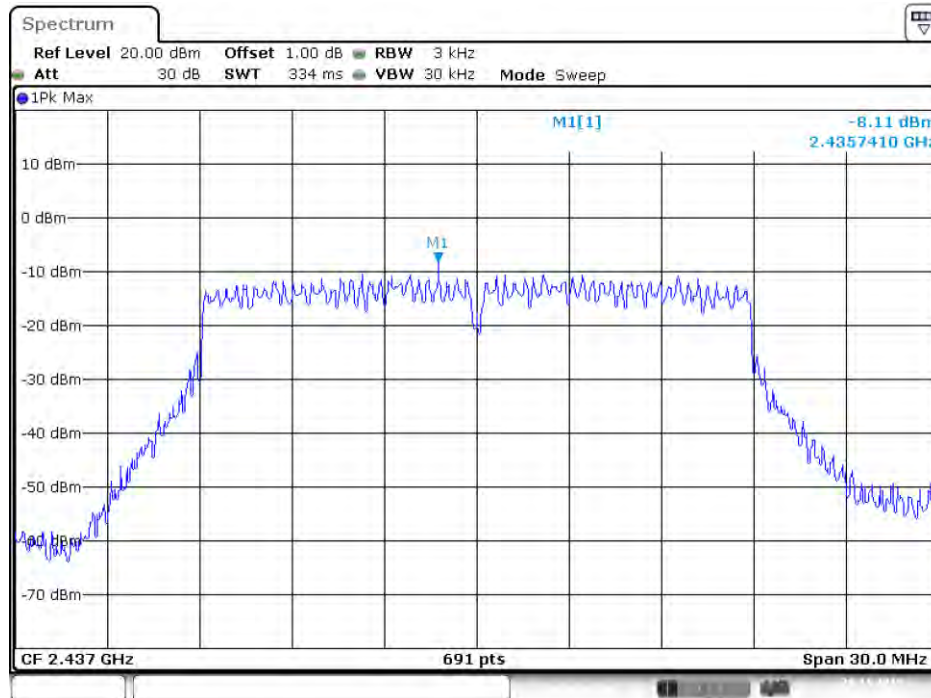

Date: 28.NOV.2015 19:51:38

Power Density Plot on Configuration IEEE 802.11ac MCS0/Nss1 VHT20 / 2437 MHz / Chain 2

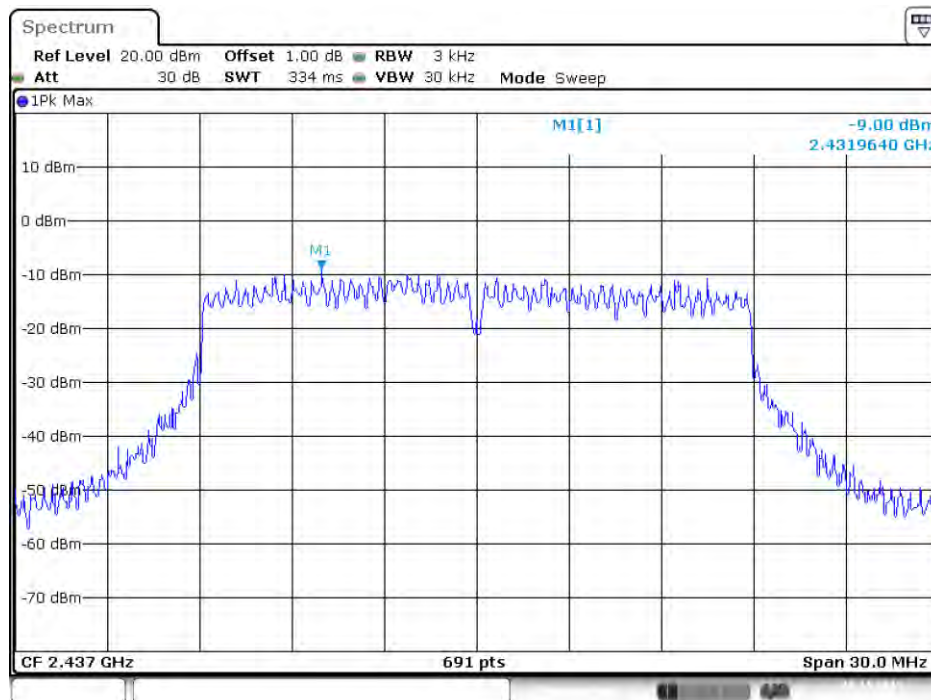

Date: 28.NOV.2015 19:52:09

Power Density Plot on Configuration IEEE 802.11ac MCS0/Nss1 VHT20 / 2437 MHz / Chain 3

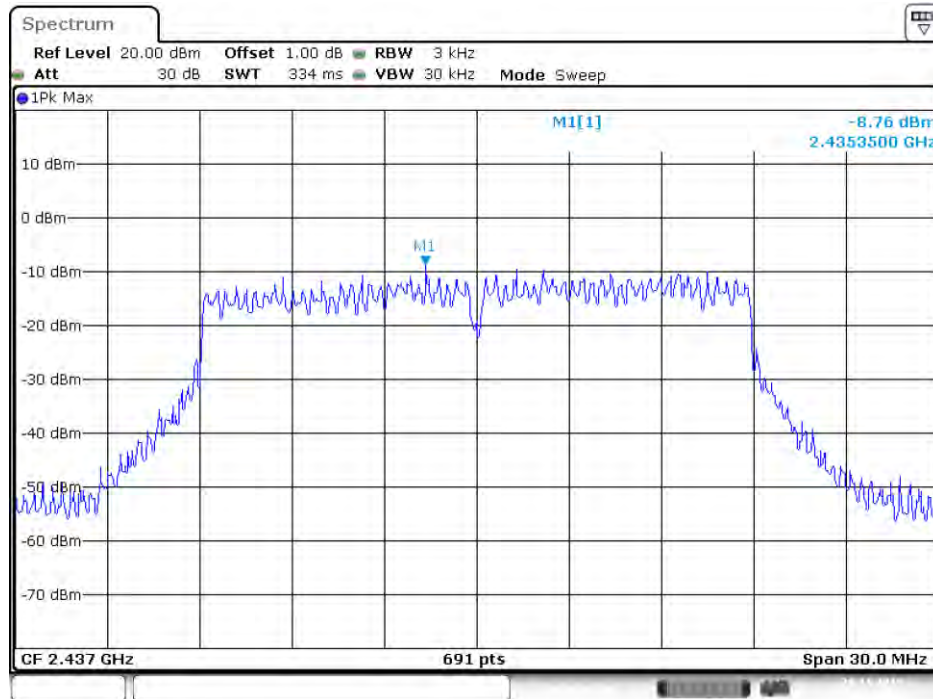

Date: 28.NOV.2015 19:52:55

Power Density Plot on Configuration IEEE 802.11ac MCS0/Nss1 VHT20 / 2437 MHz / Chain 4

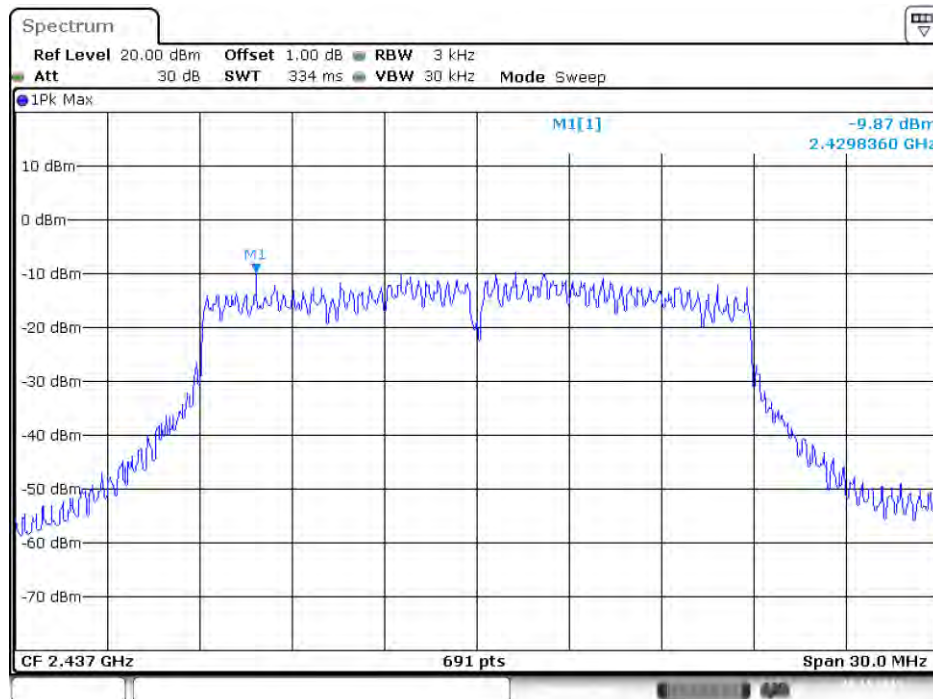

Date: 28.NOV.2015 19:53:27

Power Density Plot on Configuration IEEE 802.11ac MCS0/Nss1 VHT40 / 2422 MHz / Chain 1

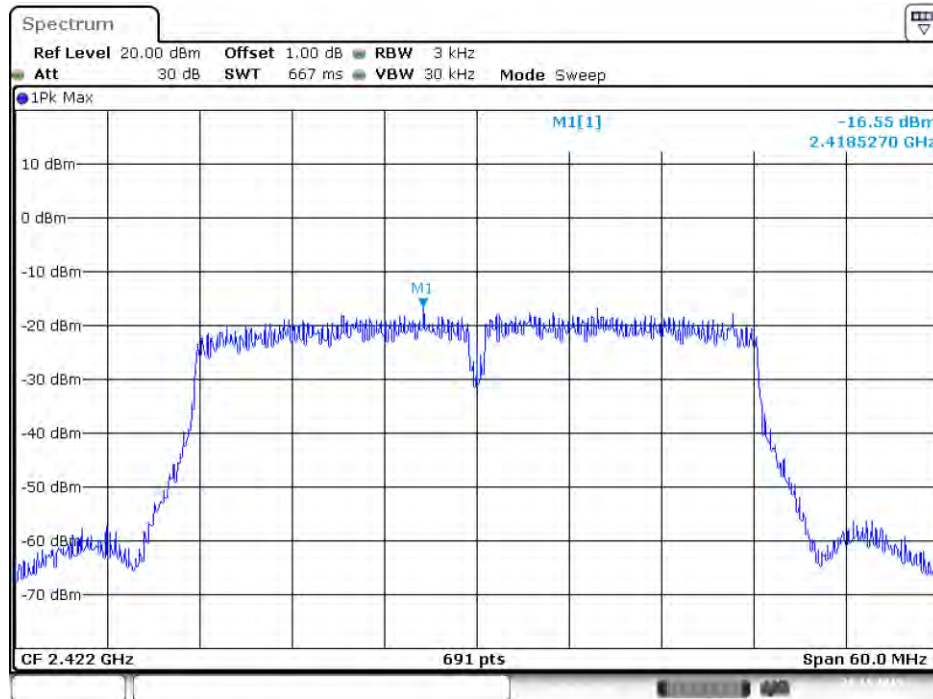

Power Density Plot on Configuration IEEE 802.11ac MCS0/Nss1 VHT40 / 2422 MHz / Chain 2

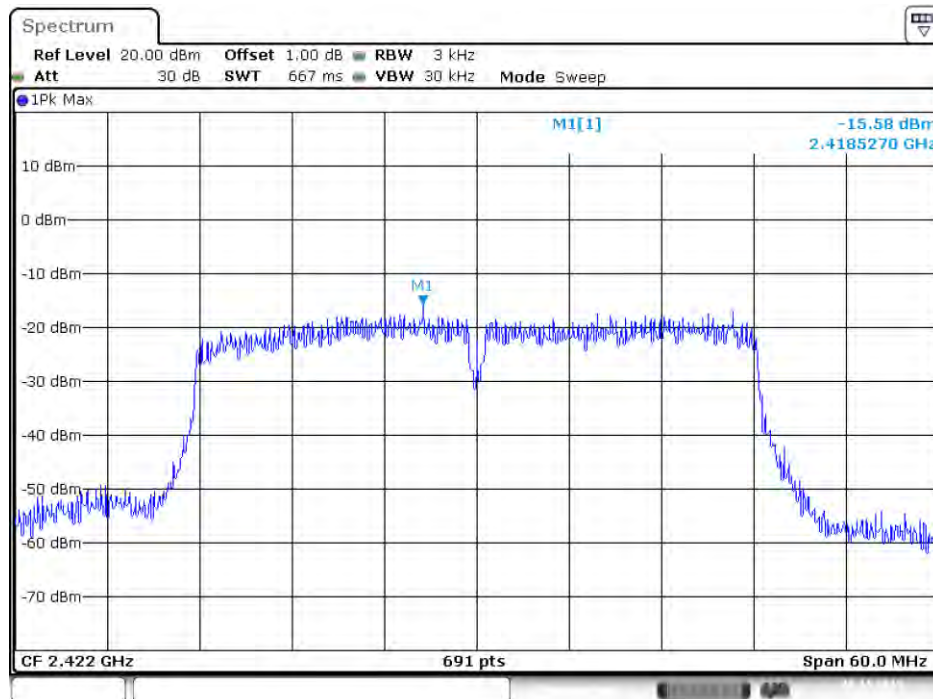

Power Density Plot on Configuration IEEE 802.11ac MCS0/Nss1 VHT40 / 2422 MHz / Chain 3

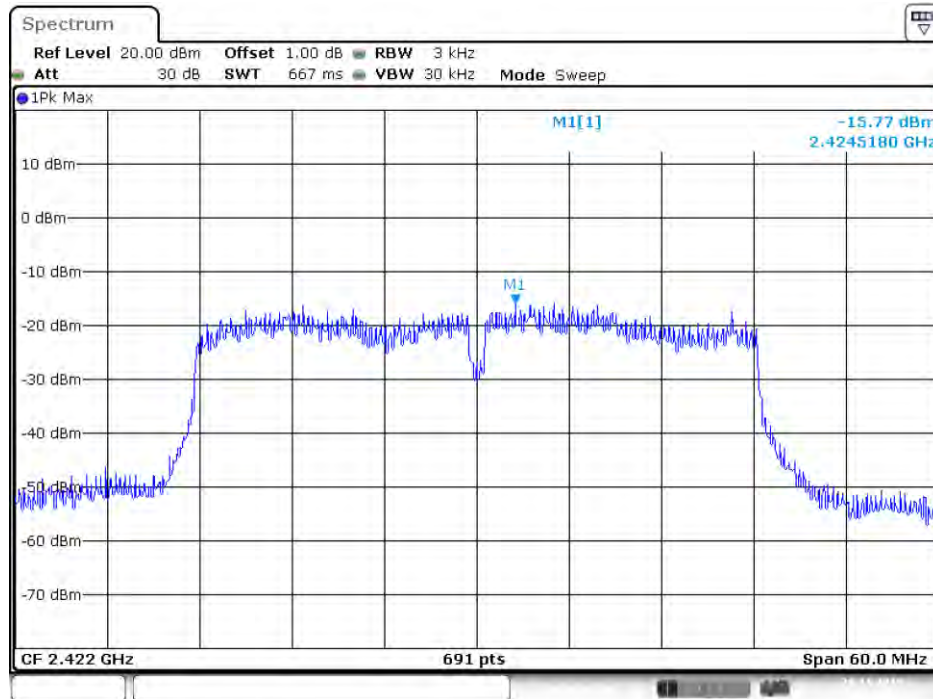

Date: 28.NOV.2015 16:34:34

Power Density Plot on Configuration IEEE 802.11ac MCS0/Nss1 VHT40 / 2422 MHz / Chain 4

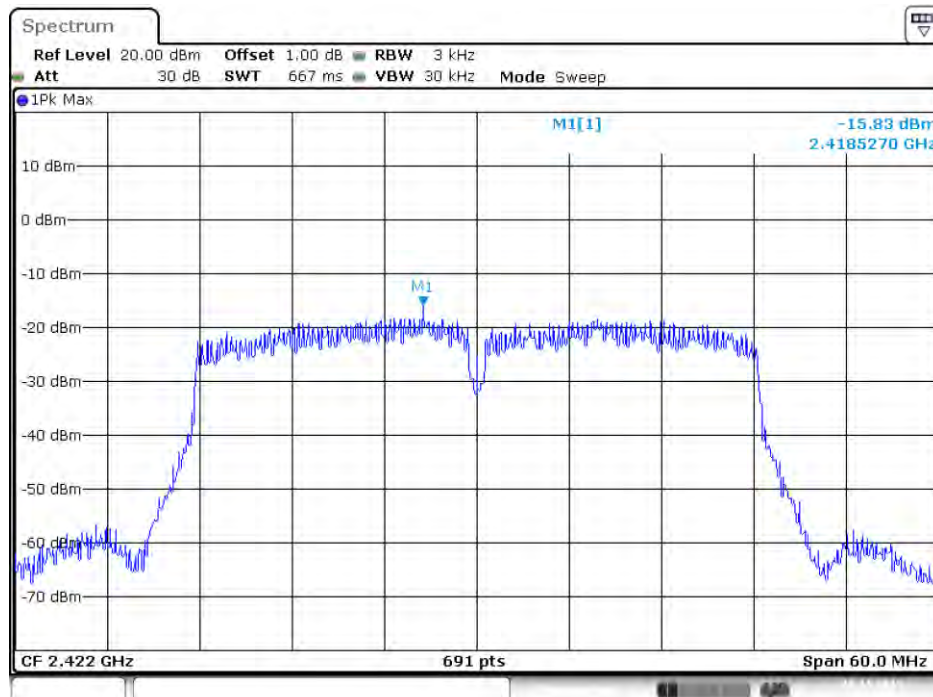

Date: 28.NOV.2015 16:35:14

4.4. 6dB Spectrum Bandwidth Measurement

4.4.1. Limit

For digital modulation systems, the minimum 6 dB bandwidth shall be at least 500 kHz.

4.4.2. Measuring Instruments and Setting

Please refer to section 5 of equipments list in this report. The following table is the setting of the Spectrum Analyzer.

| 6dB Spectrum Bandwidth | |
|------------------------|--------------------------------|
| Spectrum Parameters | Setting |
| Attenuation | Auto |
| Span Frequency | > 6dB Bandwidth |
| RBW | 100kHz |
| VBW | $\geq 3 \times \text{RBW}$ |
| Detector | Peak |
| Trace | Max Hold |
| Sweep Time | Auto |
| 99% Occupied Bandwidth | |
| Spectrum Parameters | Setting |
| Span | 1.5 times to 5.0 times the OBW |
| RBW | 1 % to 5 % of the OBW |
| VBW | $\geq 3 \times \text{RBW}$ |
| Detector | Peak |
| Trace | Max Hold |

4.4.3. Test Procedures

For Radiated 6dB Bandwidth Measurement:

1. The transmitter was radiated to the spectrum analyzer in peak hold mode.
2. Test was performed in accordance with KDB558074 D01 v04 for Performing Compliance Measurements on Digital Transmission Systems (DTS) - section 8.0 DTS bandwidth=> 8.1 Option 1.
3. Multiple antenna system was performed in accordance with KDB 662911 D01 v02r01 Emissions Testing of Transmitters with Multiple Outputs in the Same Band.
4. Measured the spectrum width with power higher than 6dB below carrier.

4.4.4. Test Setup Layout

For Radiated 6dB Bandwidth Measurement:

This test setup layout is the same as that shown in section 4.5.4.

4.4.5. Test Deviation

There is no deviation with the original standard.

4.4.6. EUT Operation during Test

The EUT was programmed to be in continuously transmitting mode.

4.4.7. Test Result of 6dB Spectrum Bandwidth

| | | | |
|----------------------|--|-----------------|-----|
| Temperature | 25°C | Humidity | 50% |
| Test Engineer | Eddie Weng & Lucas Huang | | |
| Test Mode | Mode 1: EUT 1 + Set 1 Ceiling Mount Omni Antenna / 4 dBi | | |

| Mode | Frequency | 6dB Bandwidth (MHz) | 99% Occupied Bandwidth (MHz) | Min. Limit (kHz) | Test Result |
|--------------------------------|-----------|---------------------|------------------------------|------------------|-----------------|
| 802.11ac MCS0/Nss1 VHT20 | 2412 MHz | 17.39 | 17.89 | 500 | Complies |
| | 2437 MHz | 16.58 | 17.97 | 500 | Complies |
| | 2462 MHz | 11.30 | 17.89 | 500 | Complies |
| 802.11ac MCS0/Nss1 VHT40 | 2422 MHz | 34.20 | 36.90 | 500 | Complies |
| | 2437 MHz | 28.75 | 36.90 | 500 | Complies |
| | 2452 MHz | 30.03 | 37.05 | 500 | Complies |

| | | | |
|----------------------|--|-----------------|-----|
| Temperature | 25°C | Humidity | 50% |
| Test Engineer | Eddie Weng & Lucas Huang | | |
| Test Mode | Mode 2: EUT 1 + Set 2 Sector Antenna / 7.5 dBi | | |

| Mode | Frequency | 6dB Bandwidth (MHz) | 99% Occupied Bandwidth (MHz) | Min. Limit (kHz) | Test Result |
|--------------------------------|------------------|----------------------------|-------------------------------------|-------------------------|--------------------|
| 802.11ac MCS0/Nss1 VHT20 | 2412 MHz | 17.62 | 17.97 | 500 | Complies |
| | 2437 MHz | 16.58 | 17.97 | 500 | Complies |
| | 2462 MHz | 13.16 | 17.89 | 500 | Complies |
| 802.11ac MCS0/Nss1 VHT40 | 2422 MHz | 36.41 | 37.05 | 500 | Complies |
| | 2437 MHz | 25.39 | 36.90 | 500 | Complies |
| | 2452 MHz | 34.78 | 37.05 | 500 | Complies |

| | | | |
|----------------------|--|-----------------|-----|
| Temperature | 25°C | Humidity | 50% |
| Test Engineer | Eddie Weng & Lucas Huang | | |
| Test Mode | Mode 3: EUT 1 + Set 3 Sector Antenna / 5.5 dBi | | |

| Mode | Frequency | 6dB Bandwidth (MHz) | 99% Occupied Bandwidth (MHz) | Min. Limit (kHz) | Test Result |
|--------------------------------|------------------|----------------------------|-------------------------------------|-------------------------|--------------------|
| 802.11ac MCS0/Nss1 VHT20 | 2412 MHz | 14.14 | 17.97 | 500 | Complies |
| | 2437 MHz | 16.58 | 17.97 | 500 | Complies |
| | 2462 MHz | 11.30 | 17.89 | 500 | Complies |
| 802.11ac MCS0/Nss1 VHT40 | 2422 MHz | 35.13 | 36.90 | 500 | Complies |
| | 2437 MHz | 34.44 | 36.90 | 500 | Complies |
| | 2452 MHz | 31.88 | 37.05 | 500 | Complies |

| | | | |
|----------------------|---|-----------------|-----|
| Temperature | 25°C | Humidity | 50% |
| Test Engineer | Eddie Weng & Lucas Huang | | |
| Test Mode | Mode 4: EUT 1 + Set 4 Sector Antenna / 10.5 dBi | | |

| Mode | Frequency | 6dB Bandwidth (MHz) | 99% Occupied Bandwidth (MHz) | Min. Limit (kHz) | Test Result |
|--------------------------------|------------------|----------------------------|-------------------------------------|-------------------------|--------------------|
| 802.11ac MCS0/Nss1 VHT20 | 2412 MHz | 16.93 | 17.89 | 500 | Complies |
| | 2437 MHz | 16.00 | 17.97 | 500 | Complies |
| | 2462 MHz | 11.30 | 17.97 | 500 | Complies |
| 802.11ac MCS0/Nss1 VHT40 | 2422 MHz | 35.48 | 37.05 | 500 | Complies |
| | 2437 MHz | 32.58 | 36.90 | 500 | Complies |
| | 2452 MHz | 35.13 | 36.90 | 500 | Complies |

| | | | |
|----------------------|--|-----------------|-----|
| Temperature | 25°C | Humidity | 50% |
| Test Engineer | Eddie Weng & Lucas Huang | | |
| Test Mode | Mode 5: EUT 1 + Set 7 Sector Antenna / 5 dBi | | |

| Mode | Frequency | 6dB Bandwidth (MHz) | 99% Occupied Bandwidth (MHz) | Min. Limit (kHz) | Test Result |
|--------------------------------|-----------|---------------------|------------------------------|------------------|-----------------|
| 802.11ac MCS0/Nss1 VHT20 | 2412 MHz | 17.39 | 17.89 | 500 | Complies |
| | 2437 MHz | 16.58 | 17.97 | 500 | Complies |
| | 2462 MHz | 11.30 | 17.89 | 500 | Complies |
| 802.11ac MCS0/Nss1 VHT40 | 2422 MHz | 34.20 | 36.90 | 500 | Complies |
| | 2437 MHz | 28.75 | 36.90 | 500 | Complies |
| | 2452 MHz | 29.33 | 37.05 | 500 | Complies |

| | | | |
|----------------------|---|-----------------|-----|
| Temperature | 25°C | Humidity | 50% |
| Test Engineer | Eddie Weng & Lucas Huang | | |
| Test Mode | Mode 6: EUT 1 + Set 8 Dipole Antenna / 4.66 dBi | | |

| Mode | Frequency | 6dB Bandwidth (MHz) | 99% Occupied Bandwidth (MHz) | Min. Limit (kHz) | Test Result |
|--------------------------------|------------------|----------------------------|-------------------------------------|-------------------------|--------------------|
| 802.11ac MCS0/Nss1 VHT20 | 2412 MHz | 14.14 | 17.97 | 500 | Complies |
| | 2437 MHz | 16.58 | 17.97 | 500 | Complies |
| | 2462 MHz | 17.22 | 17.97 | 500 | Complies |
| 802.11ac MCS0/Nss1 VHT40 | 2422 MHz | 28.99 | 37.19 | 500 | Complies |
| | 2437 MHz | 35.58 | 37.19 | 500 | Complies |
| | 2452 MHz | 34.78 | 37.05 | 500 | Complies |

| | | | |
|----------------------|--|-----------------|-----|
| Temperature | 25°C | Humidity | 50% |
| Test Engineer | Eddie Weng & Lucas Huang | | |
| Test Mode | Mode 7: EUT 2 + Set 10 PIFA Antenna / Chain1:3.81 dBi, Chain2:3.75 dBi, Chain3:3.98 dBi, Chain4:3.47 dBi | | |

| Mode | Frequency | 6dB Bandwidth (MHz) | 99% Occupied Bandwidth (MHz) | Min. Limit (kHz) | Test Result |
|--------------------------------|------------------|----------------------------|-------------------------------------|-------------------------|--------------------|
| 802.11ac MCS0/Nss1 VHT20 | 2412 MHz | 13.57 | 18.06 | 500 | Complies |
| | 2437 MHz | 14.14 | 17.97 | 500 | Complies |
| | 2462 MHz | 16.64 | 17.97 | 500 | Complies |
| 802.11ac MCS0/Nss1 VHT40 | 2422 MHz | 30.26 | 37.05 | 500 | Complies |
| | 2437 MHz | 28.87 | 37.05 | 500 | Complies |
| | 2452 MHz | 28.99 | 36.76 | 500 | Complies |

Note: All the test values were listed in the report.

For plots, only the channel with worse result was shown.

Mode 1: EUT 1 + Set 1 Ceiling Mount Omni Antenna / 4 dBi

6 dB Bandwidth Plot on Configuration IEEE 802.11ac MCS0/Nss1 VHT20 / 2462 MHz / Chain 1 + Chain 2 + Chain 3 + Chain 4

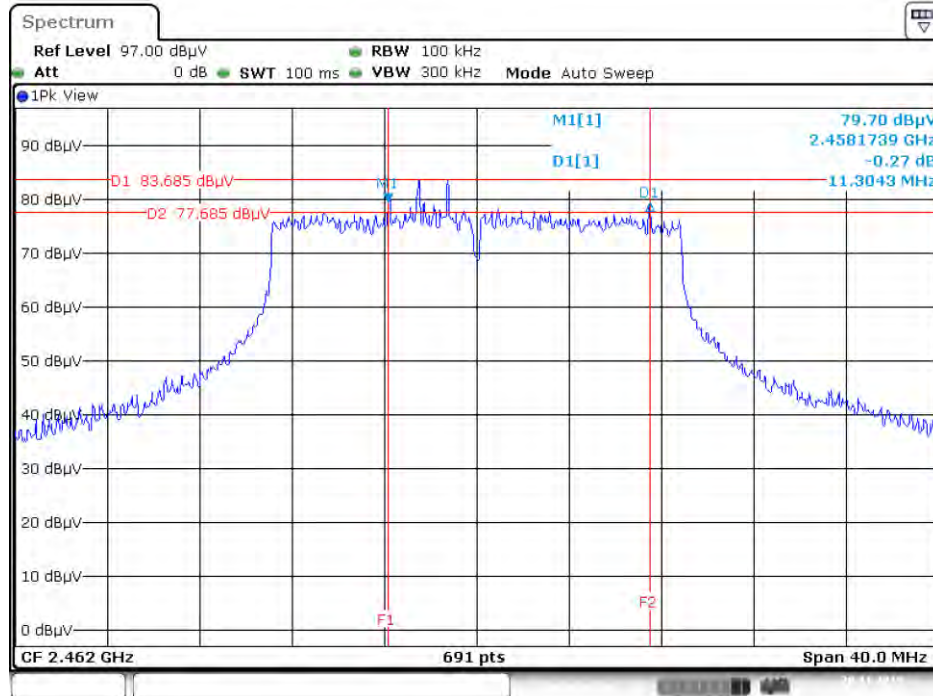

Date: 28.NOV.2015 18:13:41

99% Occupied Bandwidth Plot on Configuration IEEE 802.11ac MCS0/Nss1 VHT20 / 2437 MHz / Chain 1 + Chain 2 + Chain 3 + Chain 4



Date: 28.NOV.2015 19:03:48

6 dB Bandwidth Plot on Configuration IEEE 802.11ac MCS0/Nss1 VHT40 / 2437 MHz / Chain 1 + Chain 2 + Chain 3 + Chain 4

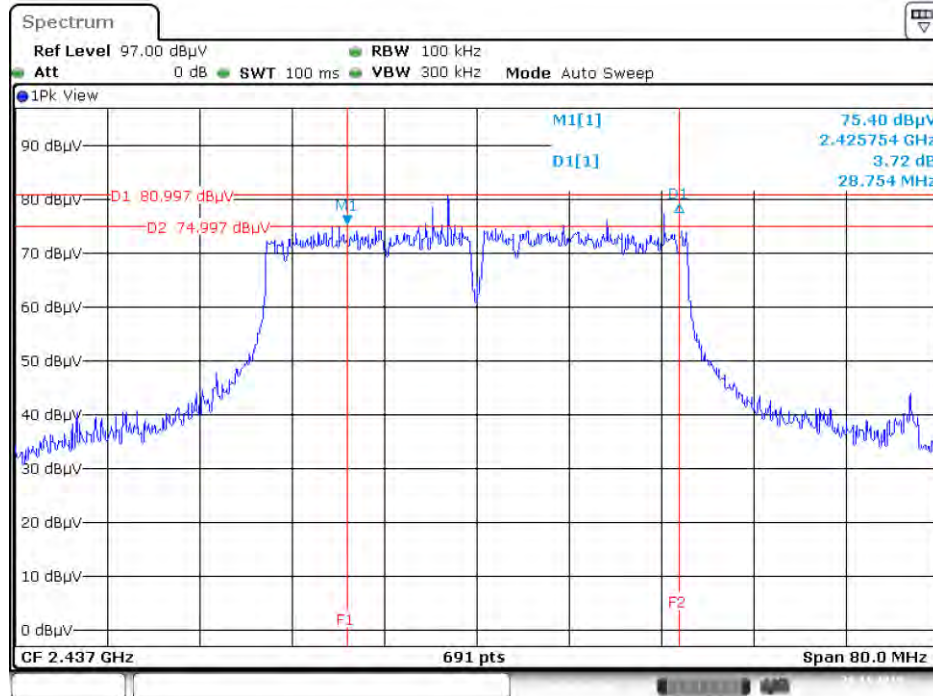

Date: 28.NOV.2015 17:33:25

99% Occupied Bandwidth Plot on Configuration IEEE 802.11ac MCS0/Nss1 VHT40 / 2452 MHz / Chain 1 + Chain 2 + Chain 3 + Chain 4

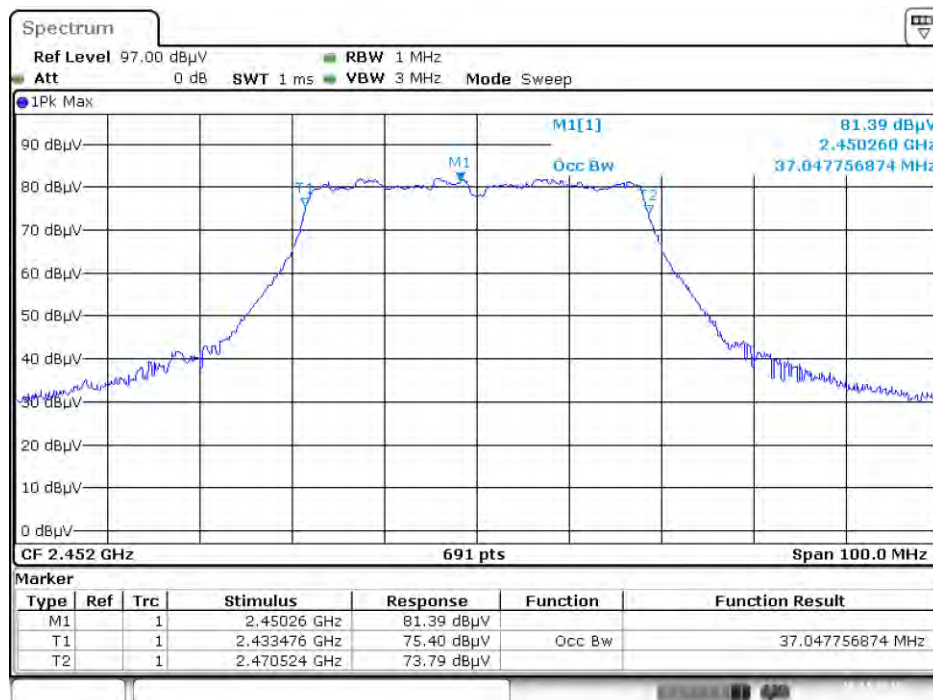

Date: 28.NOV.2015 19:46:27

Mode 2: EUT 1 + Set 2 Sector Antenna / 7.5 dBi

6 dB Bandwidth Plot on Configuration IEEE 802.11ac MCS0/Nss1 VHT20 / 2462 MHz / Chain 1 + Chain 2 + Chain 3 + Chain 4

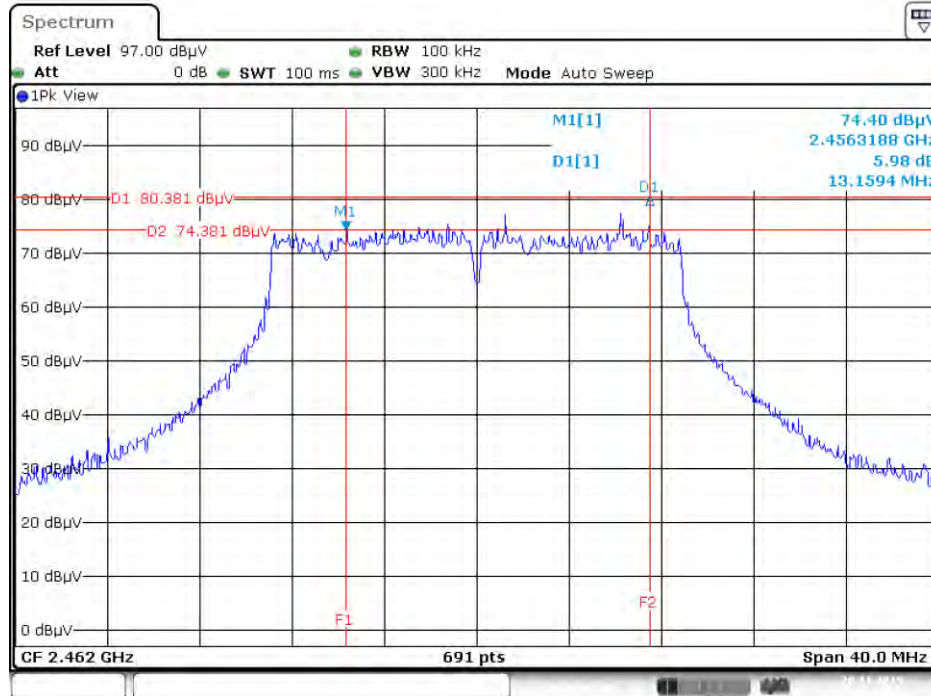

Date: 28.NOV.2015 17:37:36

99% Occupied Bandwidth Plot on Configuration IEEE 802.11ac MCS0/Nss1 VHT20 / 2412 MHz / Chain 1 + Chain 2 + Chain 3 + Chain 4



Date: 28.NOV.2015 19:17:13

6 dB Bandwidth Plot on Configuration IEEE 802.11ac MCS0/Nss1 VHT40 / 2437 MHz / Chain 1 + Chain 2 + Chain 3 + Chain 4

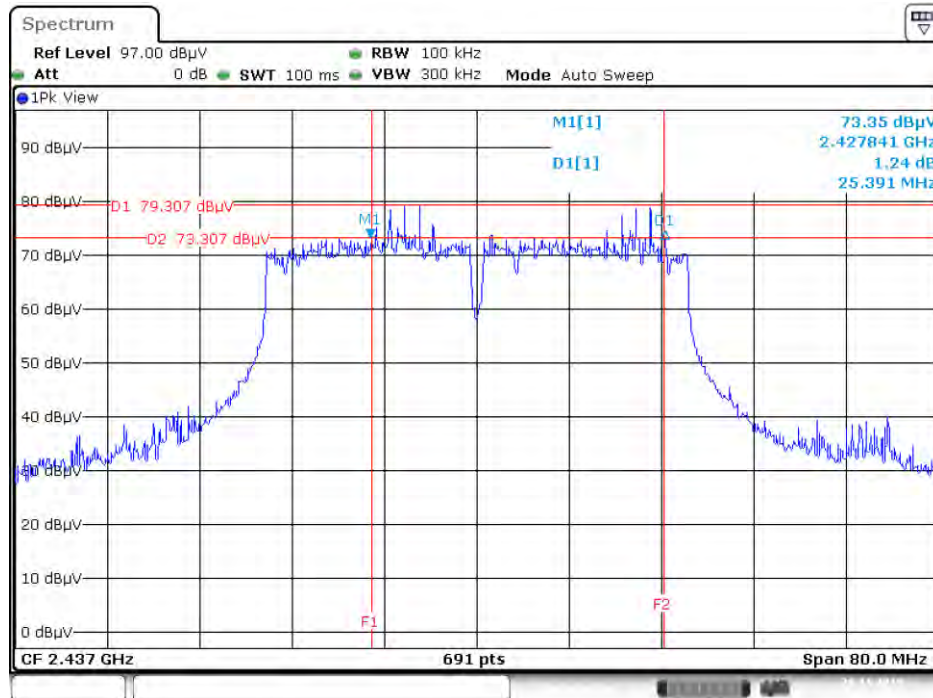

Date: 28.NOV.2015 17:40:23

99% Occupied Bandwidth Plot on Configuration IEEE 802.11ac MCS0/Nss1 VHT40 / 2422 MHz / Chain 1 + Chain 2 + Chain 3 + Chain 4

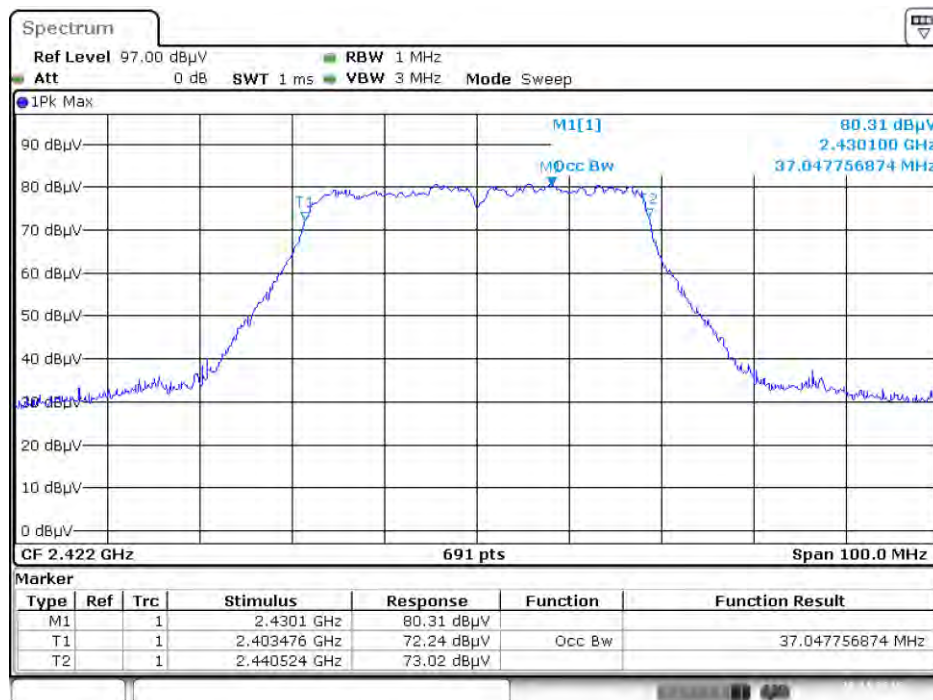

Date: 28.NOV.2015 19:19:46

Mode 3: EUT 1 + Set 3 Sector Antenna / 5.5 dBi

6 dB Bandwidth Plot on Configuration IEEE 802.11ac MCS0/Nss1 VHT20 / 2462 MHz / Chain 1 + Chain 2 + Chain 3 + Chain 4

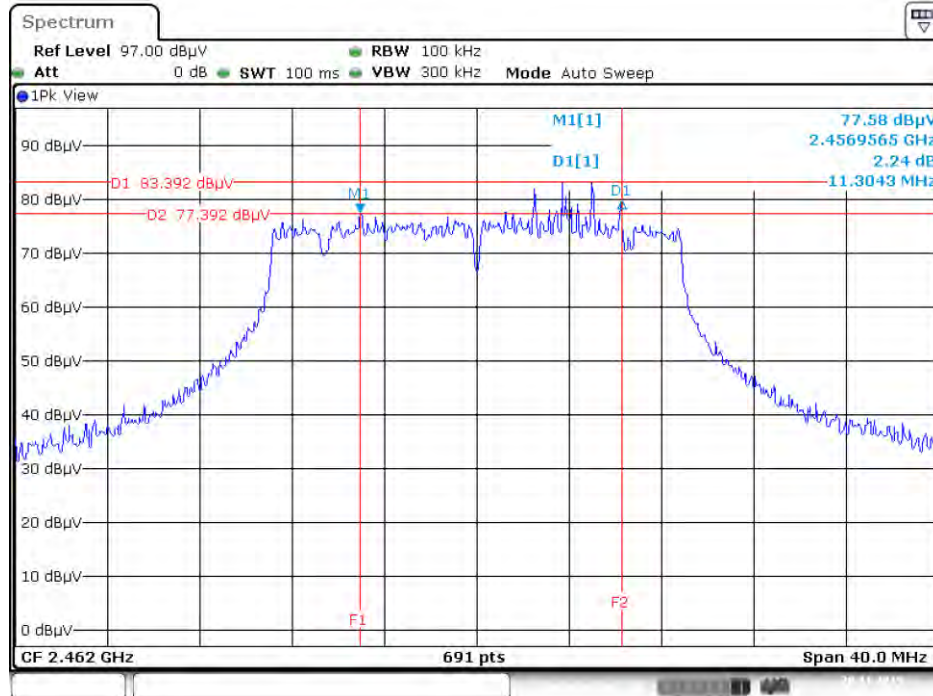

Date: 28.NOV.2015 17:19:11

99% Occupied Bandwidth Plot on Configuration IEEE 802.11ac MCS0/Nss1 VHT20 / 2412 MHz / Chain 1 + Chain 2 + Chain 3 + Chain 4



Date: 28.NOV.2015 18:52:40

6 dB Bandwidth Plot on Configuration IEEE 802.11ac MCS0/Nss1 VHT40 / 2452 MHz / Chain 1 + Chain 2 + Chain 3 + Chain 4

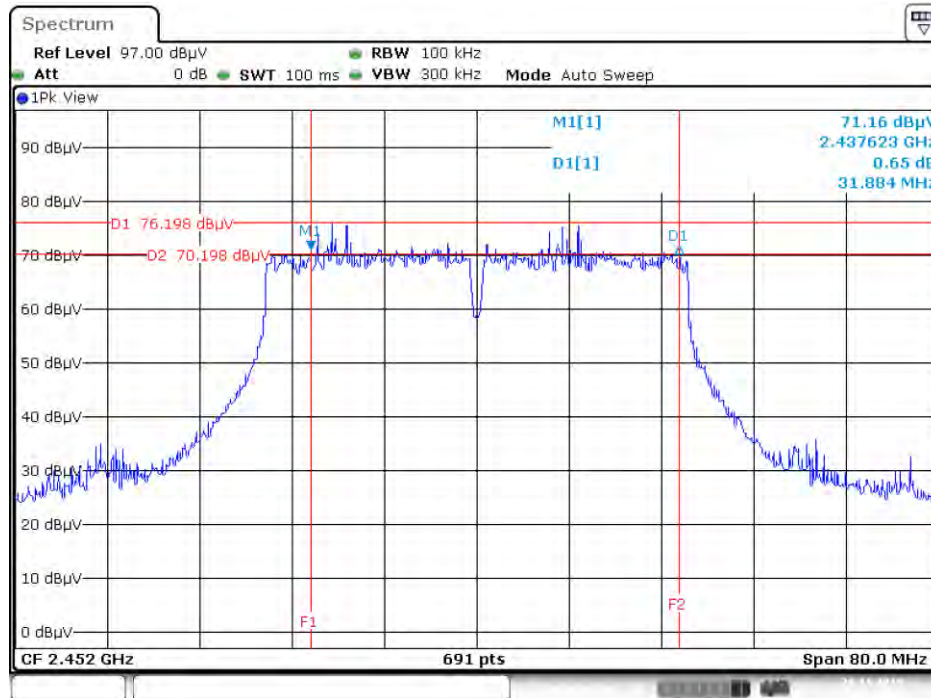

Date: 28.NOV.2015 17:27:31

99% Occupied Bandwidth Plot on Configuration IEEE 802.11ac MCS0/Nss1 VHT40 / 2452 MHz / Chain 1 + Chain 2 + Chain 3 + Chain 4

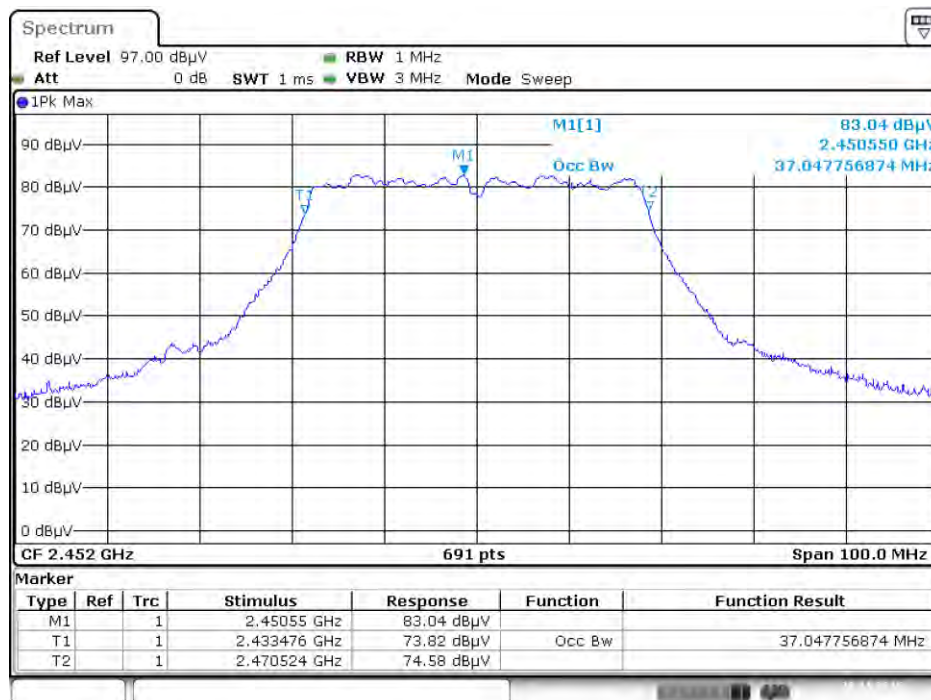

Date: 28.NOV.2015 19:07:26

Mode 4: EUT 1 + Set 4 Sector Antenna / 10.5 dBi

6 dB Bandwidth Plot on Configuration IEEE 802.11ac MCS0/Nss1 VHT20 / 2462 MHz / Chain 1 + Chain 2 + Chain 3 + Chain 4

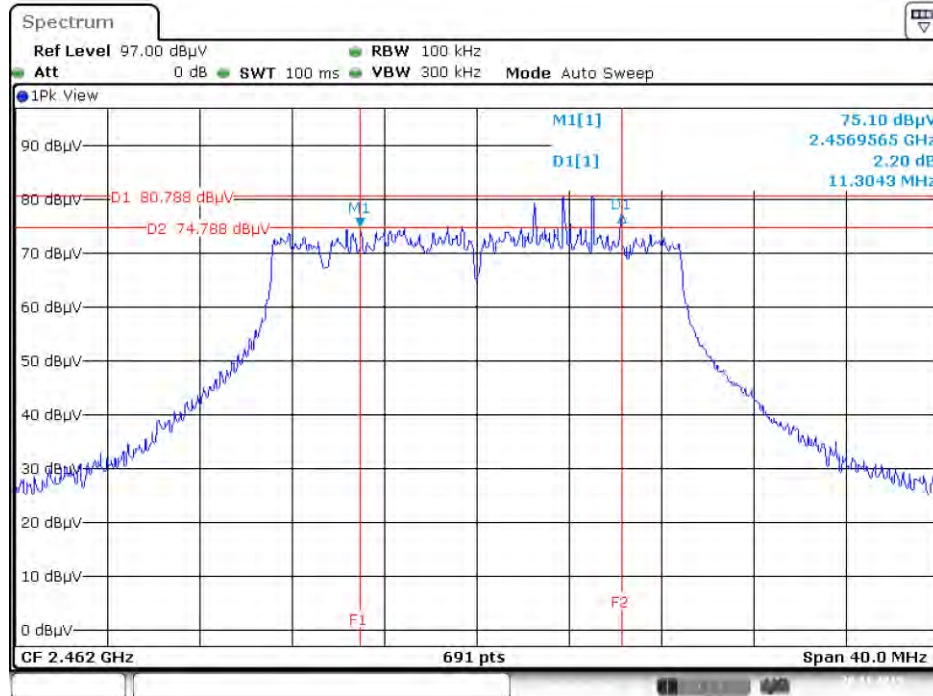

Date: 28.NOV.2015 18:06:05

99% Occupied Bandwidth Plot on Configuration IEEE 802.11ac MCS0/Nss1 VHT20 / 2437 MHz / Chain 1 + Chain 2 + Chain 3 + Chain 4



Date: 28.NOV.2015 19:30:41

6 dB Bandwidth Plot on Configuration IEEE 802.11ac MCS0/Nss1 VHT40 / 2437 MHz / Chain 1 + Chain 2 + Chain 3 + Chain 4

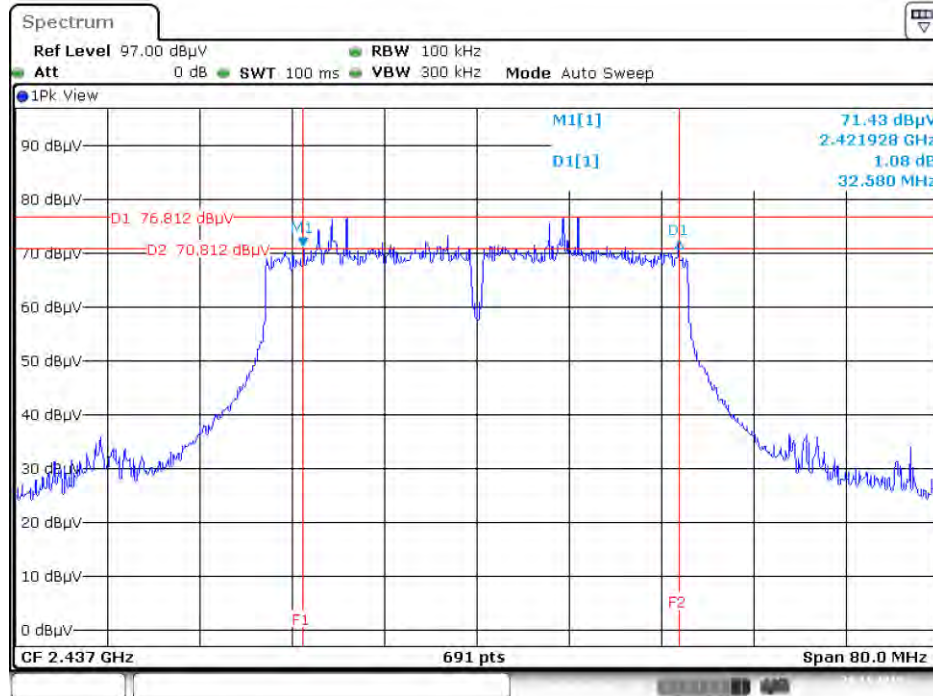

Date: 28.NOV.2015 18:08:18

99% Occupied Bandwidth Plot on Configuration IEEE 802.11ac MCS0/Nss1 VHT40 / 2422 MHz / Chain 1 + Chain 2 + Chain 3 + Chain 4

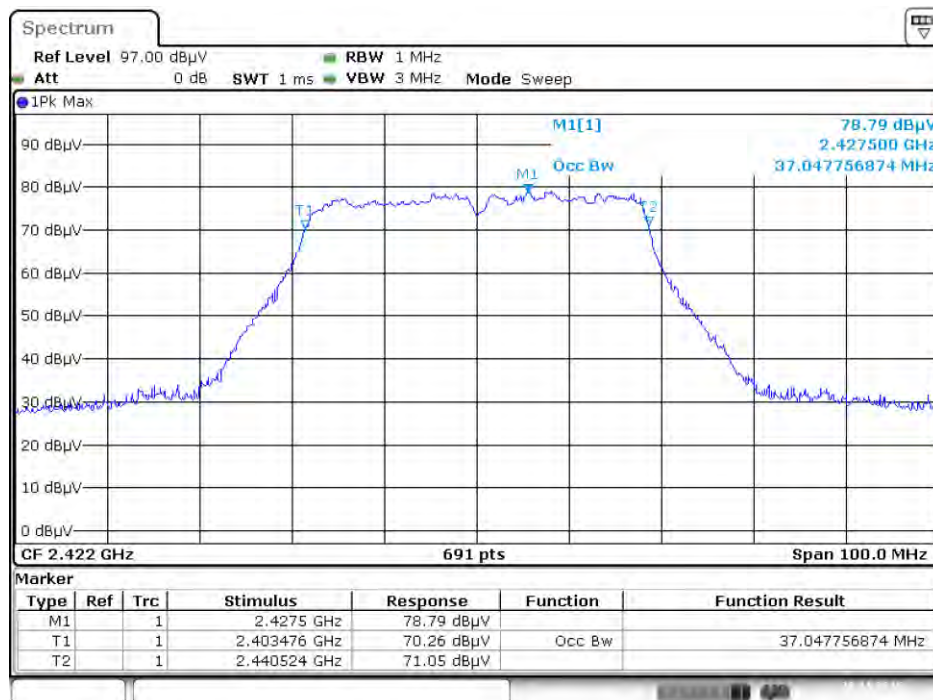

Date: 28.NOV.2015 19:23:32

Mode 5: EUT 1 + Set 7 Sector Antenna / 5 dBi

6 dB Bandwidth Plot on Configuration IEEE 802.11ac MCS0/Nss1 VHT20 / 2462 MHz / Chain 1 + Chain 2 + Chain 3 + Chain 4

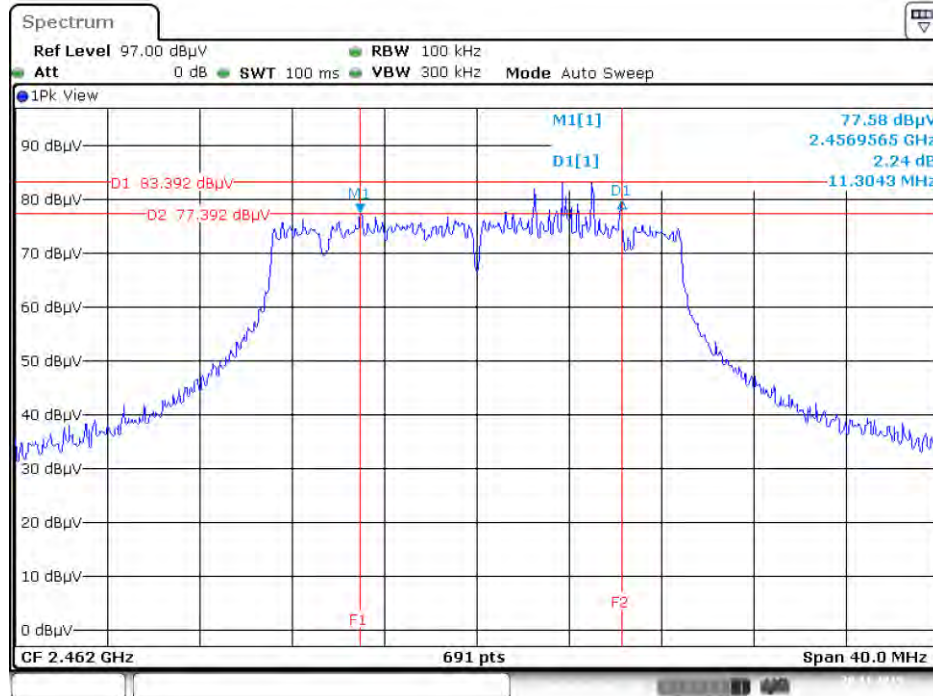

Date: 28.NOV.2015 17:19:11

99% Occupied Bandwidth Plot on Configuration IEEE 802.11ac MCS0/Nss1 VHT20 / 2437 MHz / Chain 1 + Chain 2 + Chain 3 + Chain 4



Date: 28.NOV.2015 19:03:48

6 dB Bandwidth Plot on Configuration IEEE 802.11ac MCS0/Nss1 VHT40 / 2437 MHz / Chain 1 + Chain 2 + Chain 3 + Chain 4

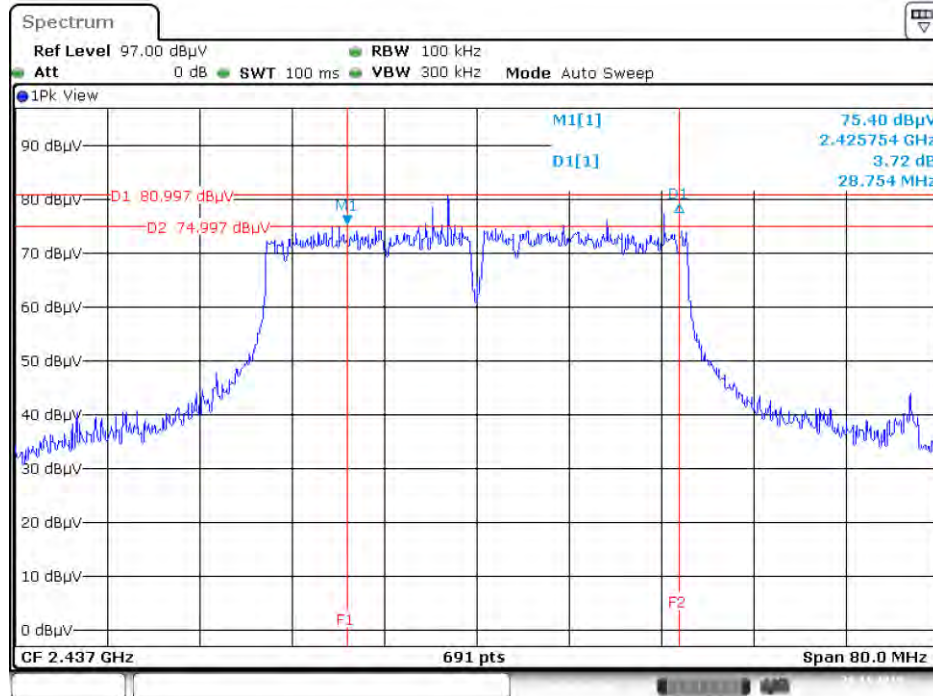

Date: 28.NOV.2015 17:33:25

99% Occupied Bandwidth Plot on Configuration IEEE 802.11ac MCS0/Nss1 VHT40 / 2452 MHz / Chain 1 + Chain 2 + Chain 3 + Chain 4

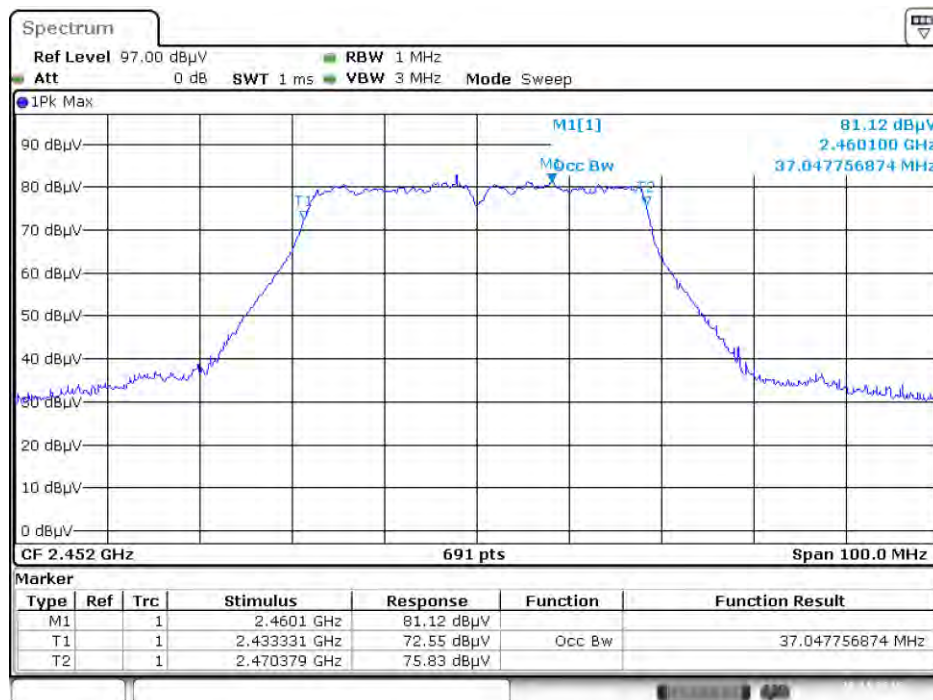

Date: 28.NOV.2015 19:14:19

Mode 6: EUT 1 + Set 8 Dipole Antenna / 4.66 dBi

6 dB Bandwidth Plot on Configuration IEEE 802.11ac MCS0/Nss1 VHT20 / 2412 MHz / Chain 1 + Chain 2 + Chain 3 + Chain 4

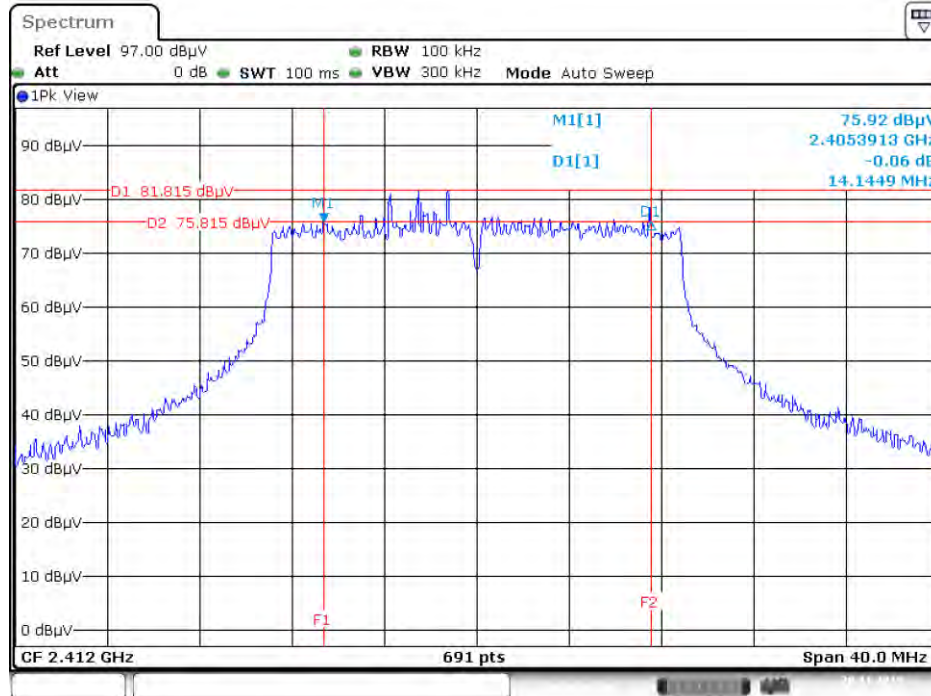

Date: 28.NOV.2015 17:15:18

99% Occupied Bandwidth Plot on Configuration IEEE 802.11ac MCS0/Nss1 VHT20 / 2412 MHz / Chain 1 + Chain 2 + Chain 3 + Chain 4



Date: 28.NOV.2015 18:52:40

6 dB Bandwidth Plot on Configuration IEEE 802.11ac MCS0/Nss1 VHT40 / 2422 MHz / Chain 1 + Chain 2 + Chain 3 + Chain 4

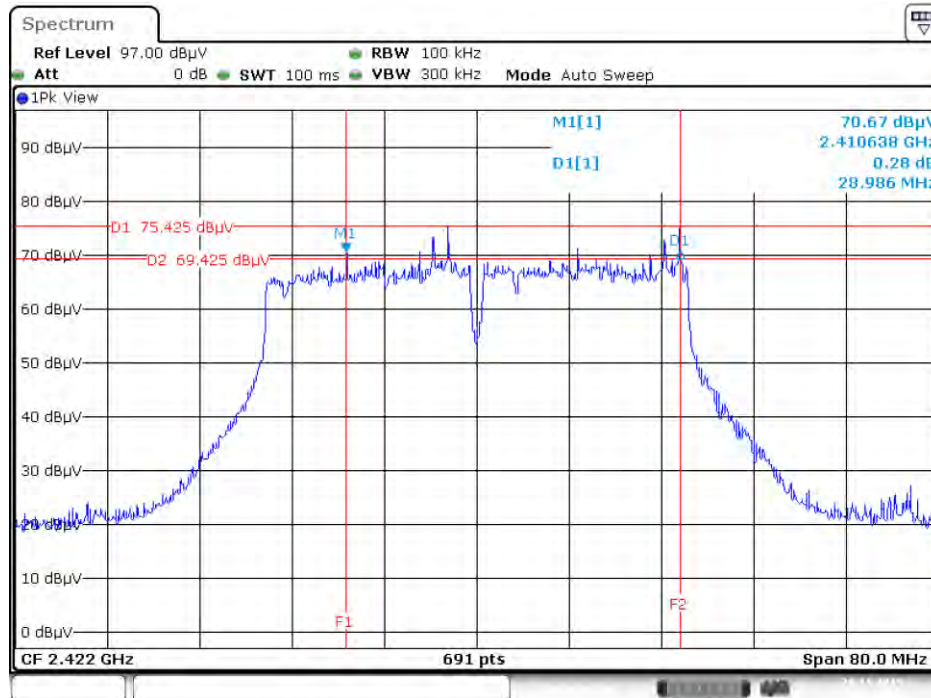

Date: 28.NOV.2015 18:38:58

99% Occupied Bandwidth Plot on Configuration IEEE 802.11ac MCS0/Nss1 VHT40 / 2422 MHz / Chain 1 + Chain 2 + Chain 3 + Chain 4



Date: 28.NOV.2015 19:44:11

Mode 7: EUT 2 + Set 10 PIFA Antenna / Chain1:3.81 dBi, Chain2:3.75 dBi, Chain3:3.98 dBi, Chain4:3.47 dBi

6 dB Bandwidth Plot on Configuration IEEE 802.11ac MCS0/Nss1 VHT20 / 2412 MHz / Chain 1 + Chain 2 + Chain 3 + Chain 4

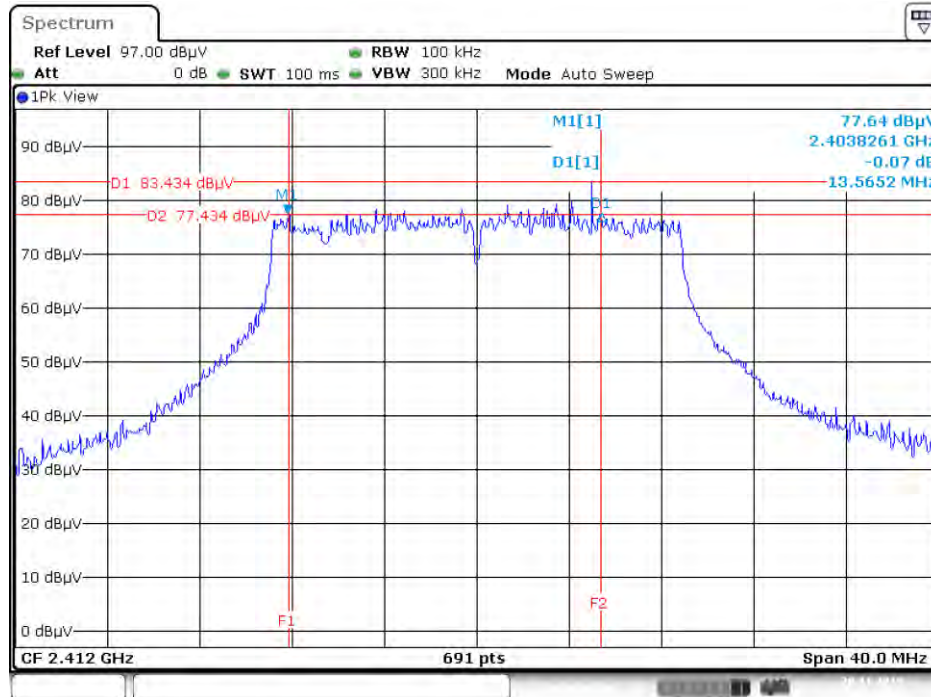

Date: 28.NOV.2015 18:21:40

99% Occupied Bandwidth Plot on Configuration IEEE 802.11ac MCS0/Nss1 VHT20 / 2412 MHz / Chain 1 + Chain 2 + Chain 3 + Chain 4

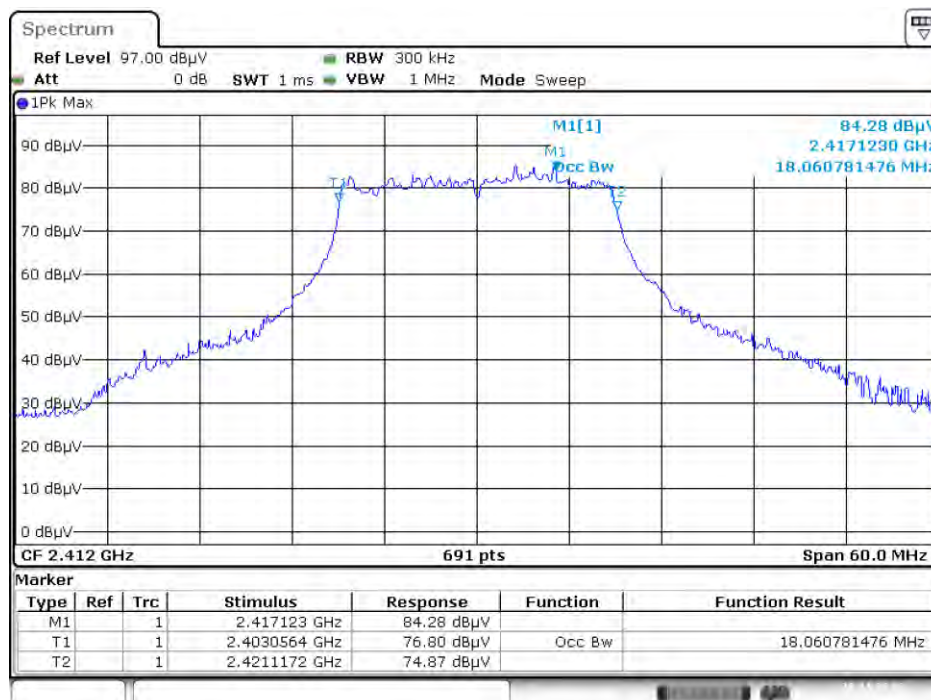

Date: 28.NOV.2015 19:37:31

6 dB Bandwidth Plot on Configuration IEEE 802.11ac MCS0/Nss1 VHT40 / 2437 MHz / Chain 1 + Chain 2 + Chain 3 + Chain 4

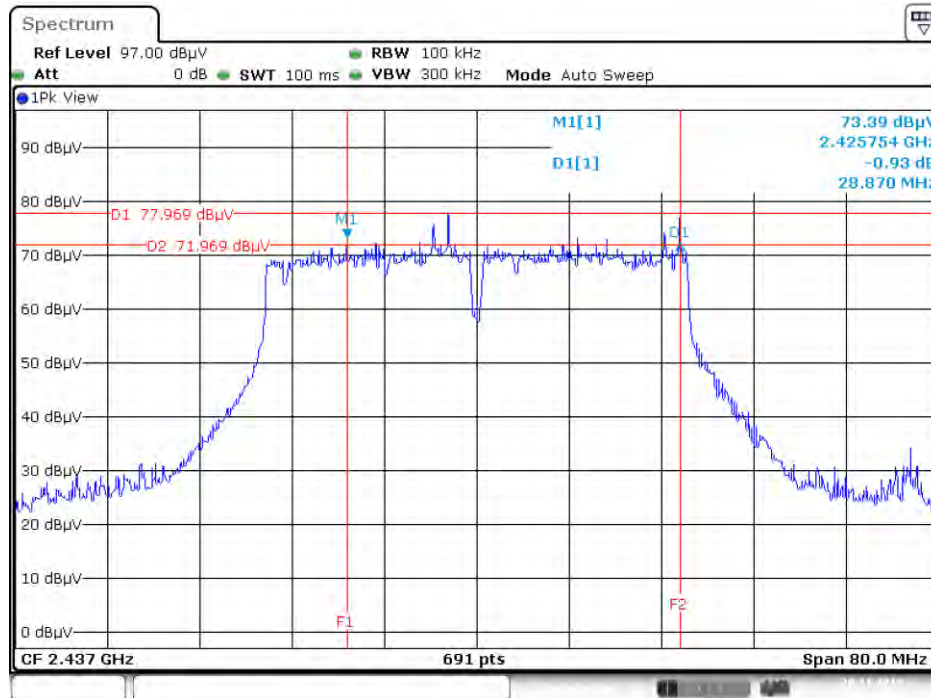

Date: 28.NOV.2015 18:30:24

99% Occupied Bandwidth Plot on Configuration IEEE 802.11ac MCS0/Nss1 VHT40 / 2422 MHz / Chain 1 + Chain 2 + Chain 3 + Chain 4

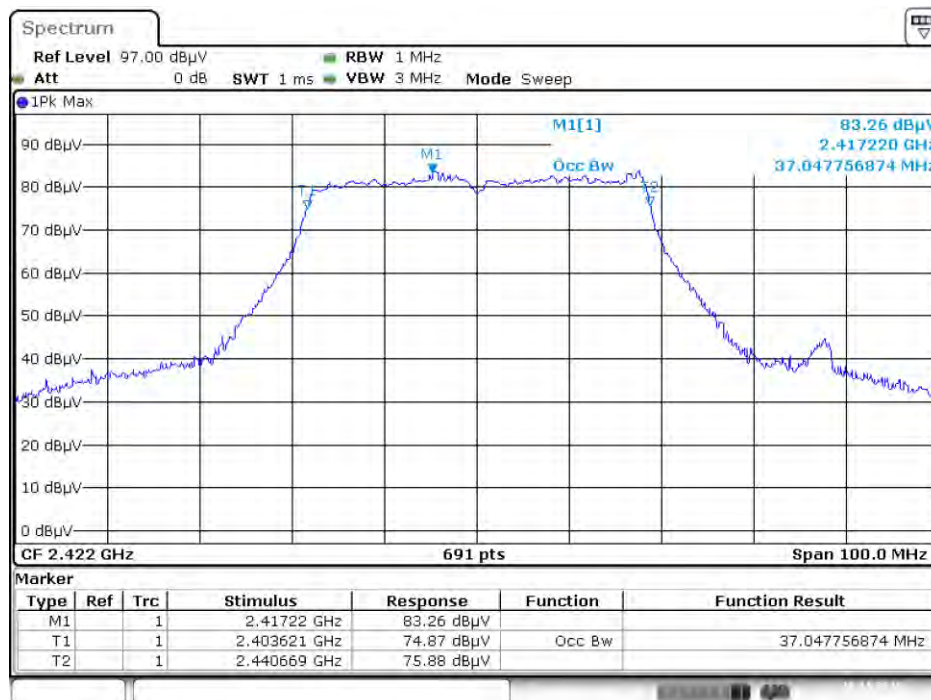

Date: 28.NOV.2015 19:39:14

4.5. Radiated Emissions Measurement

4.5.1. Limit

30dBc in any 100 kHz bandwidth outside the operating frequency band. In case the emission fall within the restricted band specified on 15.205(a), then the 15.209(a) limit in the table below has to be followed.

| Frequencies (MHz) | Field Strength (micровolts/meter) | Measurement Distance (meters) |
|-------------------|-----------------------------------|-------------------------------|
| 0.009~0.490 | 2400/F(kHz) | 300 |
| 0.490~1.705 | 24000/F(kHz) | 30 |
| 1.705~30.0 | 30 | 30 |
| 30~88 | 100 | 3 |
| 88~216 | 150 | 3 |
| 216~960 | 200 | 3 |
| Above 960 | 500 | 3 |

4.5.2. Measuring Instruments and Setting

Please refer to section 5 of equipments list in this report. The following table is the setting of spectrum analyzer and receiver.

| Spectrum Parameter | Setting |
|---|---|
| Attenuation | Auto |
| Start Frequency | 1000 MHz |
| Stop Frequency | 10th carrier harmonic |
| RBW / VBW (Emission in restricted band) | 1MHz / 3MHz for Peak, 1MHz / 1/T for Average |
| RBW / VBW (Emission in non-restricted band) | 100kHz / 300kHz for peak |

| Receiver Parameter | Setting |
|------------------------|-----------------------------------|
| Attenuation | Auto |
| Start ~ Stop Frequency | 9kHz~150kHz / RBW 200Hz for QP |
| Start ~ Stop Frequency | 150kHz~30MHz / RBW 9kHz for QP |
| Start ~ Stop Frequency | 30MHz~1000MHz / RBW 120kHz for QP |

4.5.3. Test Procedures

1. Configure the EUT according to ANSI C63.10. The EUT was placed on the top of the turntable 1.5 meter above ground. The phase center of the receiving antenna mounted on the top of a height-variable antenna tower was placed 1m & 3m far away from the turntable.
2. Power on the EUT and all the supporting units. The turntable was rotated by 360 degrees to determine the position of the highest radiation.
3. The height of the broadband receiving antenna was varied between one meter and four meters above ground to find the maximum emissions field strength of both horizontal and vertical polarization.
4. For each suspected emissions, the antenna tower was scan (from 1 m to 4 m) and then the turntable was rotated (from 0 degree to 360 degrees) to find the maximum reading.
5. Set the test-receiver system to Peak or CISPR quasi-peak Detect Function with specified bandwidth under Maximum Hold Mode.
6. For emissions above 1GHz, use 1MHz VBW and 3MHz RBW for peak reading. Then 1MHz RBW and 1/T VBW for average reading in spectrum analyzer.
7. If the emissions level of the EUT in peak mode was 3 dB lower than the average limit specified, then testing will be stopped and peak values of EUT will be reported, otherwise, the emissions which do not have 3 dB margin will be repeated one by one using the quasi-peak method for below 1GHz.
8. For testing above 1GHz, the emissions level of the EUT in peak mode was lower than average limit (that means the emissions level in peak mode also complies with the limit in average mode), then testing will be stopped and peak values of EUT will be reported, otherwise, the emissions will be measured in average mode again and reported.
9. In case the emission is lower than 30MHz, loop antenna has to be used for measurement and the recorded data should be QP measured by receiver. High – Low scan is not required in this case.

4.5.4. Test Setup Layout

For Radiated Emissions: 9kHz ~30MHz

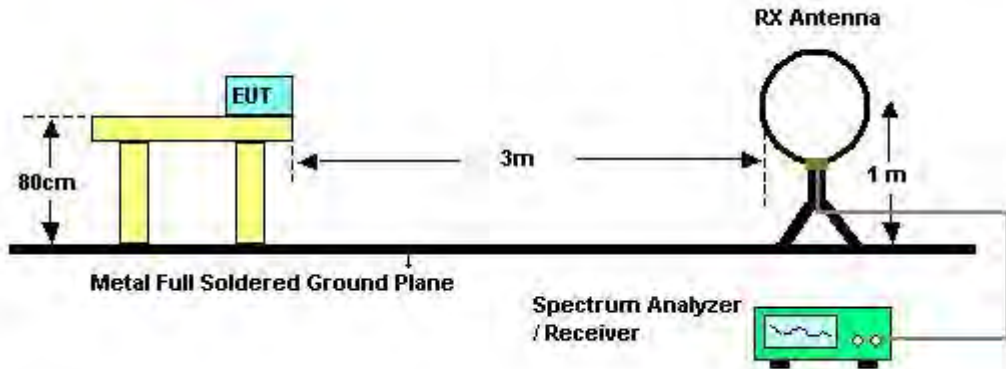

For Radiated Emissions: 30MHz~1GHz

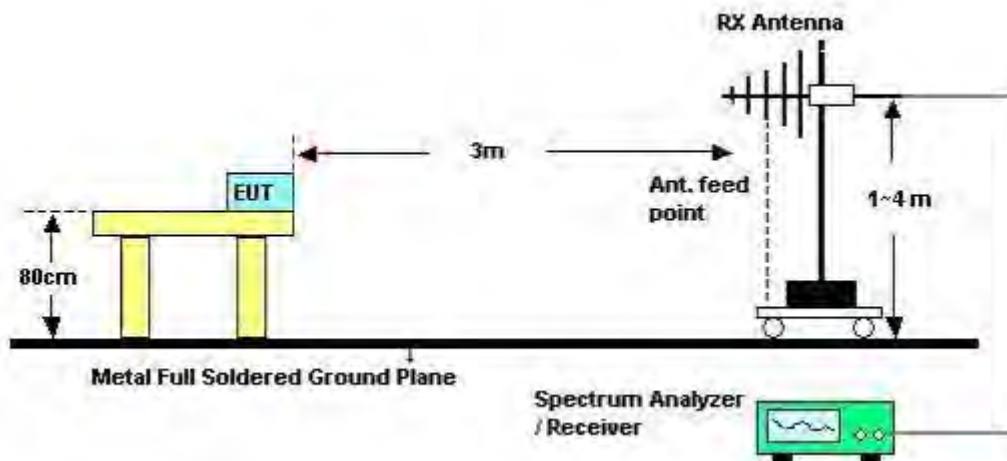

For Radiated Emissions: Above 1GHz

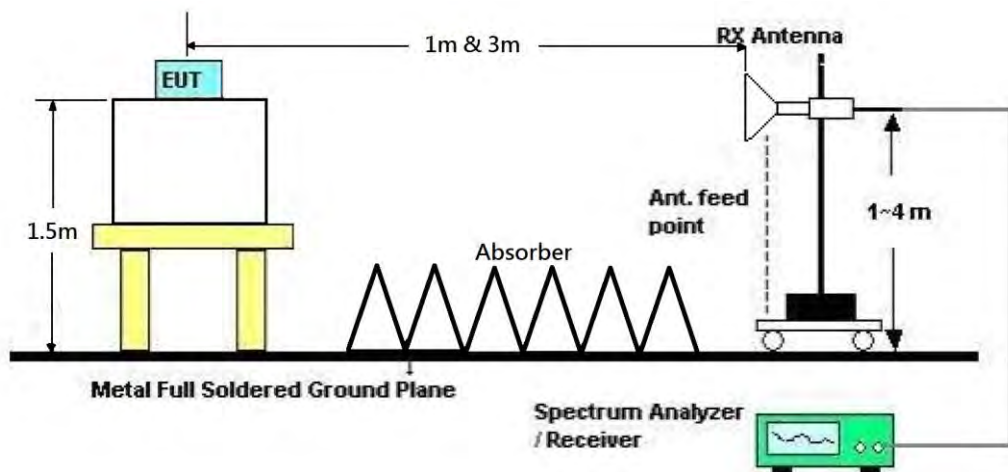

4.5.5. Test Deviation

There is no deviation with the original standard.

4.5.6. EUT Operation during Test

The EUT was programmed to be in continuously transmitting mode.

4.5.7. Results of Radiated Emissions (9kHz~30MHz)

| | | | |
|----------------------|---------------|-----------------------|-------------|
| Temperature | 23°C | Humidity | 66% |
| Test Engineer | Thor Wei | Configurations | Normal Link |
| Test Date | Aug. 12, 2017 | Test Mode | Mode 2 |

| Freq. (MHz) | Level (dBuV) | Over Limit (dB) | Limit Line (dBuV) | Remark |
|--------------------|---------------------|------------------------|--------------------------|---------------|
| - | - | - | - | See Note |

Note:

The amplitude of spurious emissions which are attenuated by more than 20 dB below the permissible value has no need to be reported.

Distance extrapolation factor = $40 \log (\text{specific distance} / \text{test distance})$ (dB);

Limit line = specific limits (dBuV) + distance extrapolation factor.

4.5.8. Results of Radiated Emissions (30MHz~1GHz)

| | | | |
|----------------------|----------|-----------------------|-------------|
| Temperature | 23°C | Humidity | 66% |
| Test Engineer | Thor Wei | Configurations | Normal Link |
| Test Mode | Mode 2 | | |

Horizontal

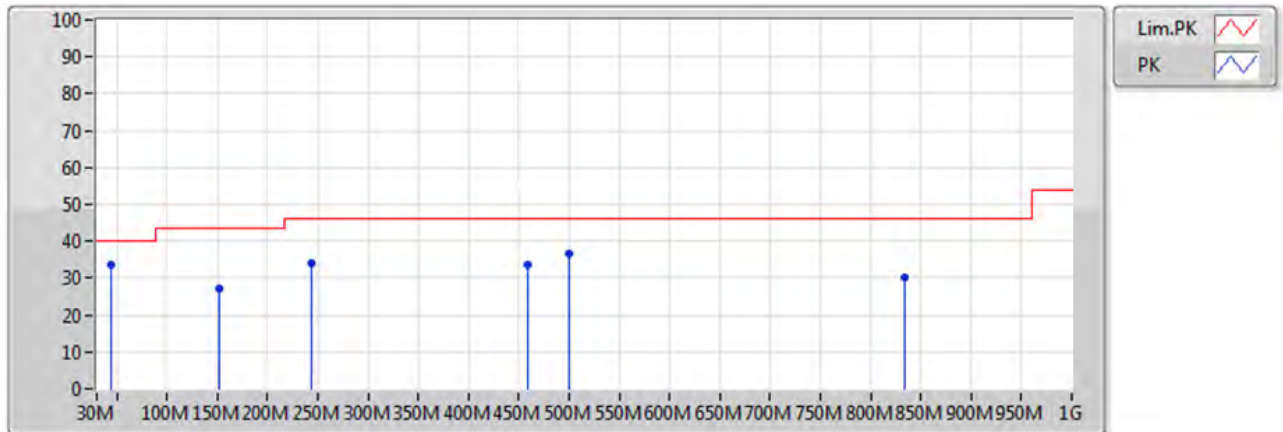

EUT=Z

| Type | Freq (Hz) | Level (dBuV/m) | Limit (dBuV/m) | Margin (dB) | Factor (dB) | Dist (m) | Condition | Azimuth (°) | Height (m) | Comments | Raw (dBuV) | AF (dB) | CL (dB) | PA (dB) |
|------|-----------|----------------|----------------|-------------|-------------|----------|------------|-------------|------------|----------|------------|---------|---------|---------|
| PK | 43.58M | 33.60 | 40.00 | -6.40 | -10.94 | 3 | Horizontal | 0 | 1.00 | - | 44.54 | 15.73 | 0.98 | 27.65 |
| PK | 152.22M | 27.12 | 43.50 | -16.38 | -10.49 | 3 | Horizontal | 0 | 1.00 | - | 37.61 | 15.38 | 1.76 | 27.62 |
| PK | 243.4M | 33.90 | 46.00 | -12.10 | -8.38 | 3 | Horizontal | 0 | 1.00 | - | 42.28 | 16.75 | 2.21 | 27.33 |
| PK | 458.74M | 33.80 | 46.00 | -12.20 | -3.04 | 3 | Horizontal | 0 | 1.00 | - | 36.84 | 21.95 | 3.28 | 28.27 |
| PK | 499.48M | 36.45 | 46.00 | -9.55 | -2.57 | 3 | Horizontal | 0 | 1.00 | - | 39.02 | 22.53 | 3.39 | 28.49 |
| PK | 833.16M | 30.05 | 46.00 | -15.95 | 1.77 | 3 | Horizontal | 0 | 1.00 | - | 28.28 | 25.11 | 4.60 | 27.94 |

Vertical

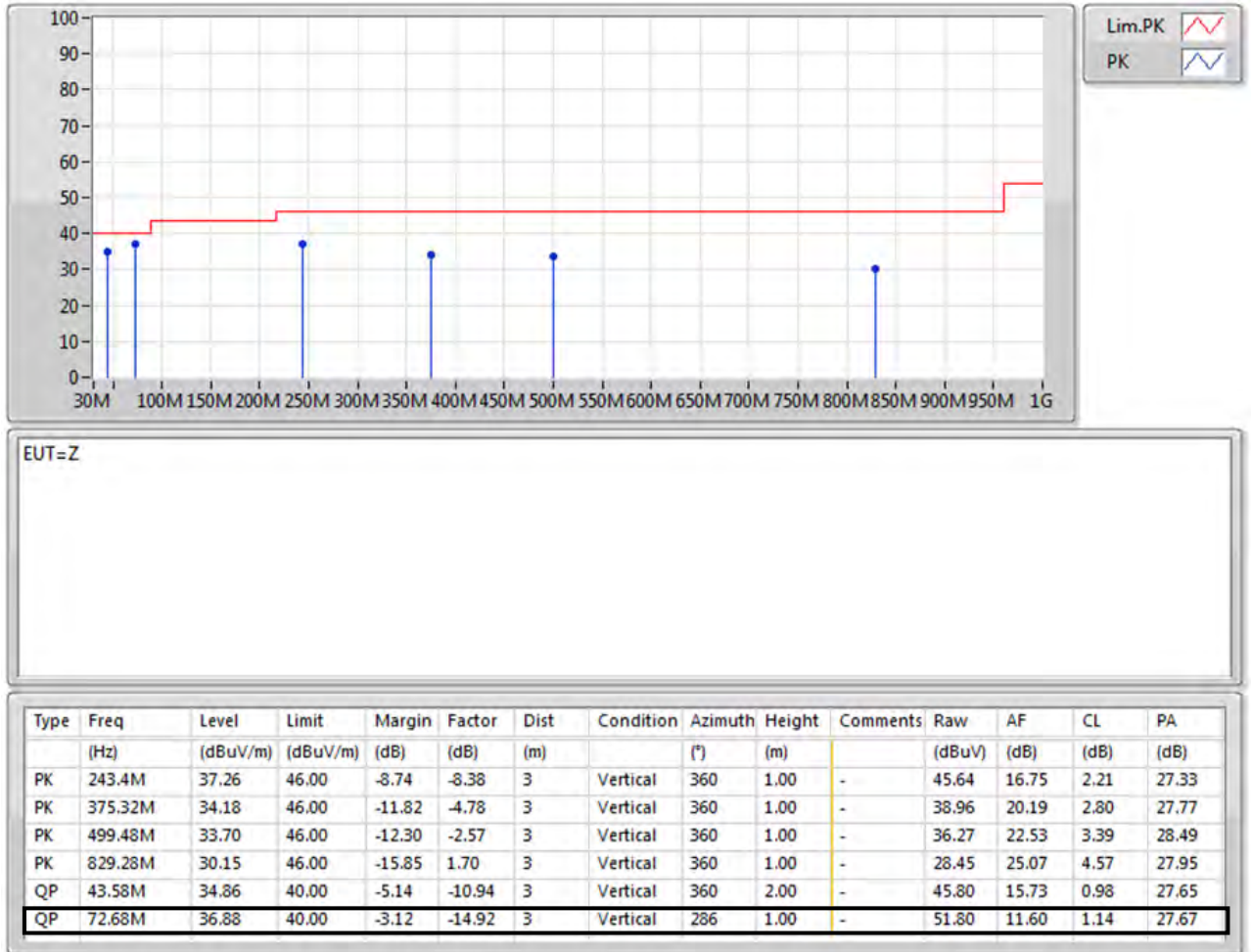

Note:

The amplitude of spurious emissions which are attenuated by more than 20 dB below the permissible value has no need to be reported.

Emission level (dBuV/m) = 20 log Emission level (uV/m).

Corrected Reading: Antenna Factor + Cable Loss + Read Level - Preamp Factor = Level.

4.5.9. Results for Radiated Emissions (1GHz~10th Harmonic)

| | | | |
|----------------------|--|-----------------------|--|
| Temperature | 25°C | Humidity | 55% |
| Test Engineer | Stim Sung | Configurations | IEEE 802.11ac MCS0/Nss1 VHT20 CH 1 / Chain 1 + Chain 2 + Chain 3 + Chain 4 |
| Test Date | Nov. 21, 2015 | | |
| Test Mode | Mode 1: EUT 1 + Set 1 Ceiling Mount Omni Antenna / 4 dBi | | |

Horizontal

| | Freq | Level | Limit | Over | Read | CableAntenna | Preamp | A/Pos | T/Pos | Remark | Pol/Phase |
|---|---------|--------|--------|--------|-------|--------------|--------|-------|-------|---------|------------|
| | MHz | dBuV/m | dBuV/m | dB | dBuV | Loss | Factor | cm | deg | | |
| 1 | 4823.78 | 48.73 | 74.00 | -25.27 | 40.59 | 8.11 | 33.11 | 132 | 157 | Peak | HORIZONTAL |
| 2 | 4824.38 | 35.47 | 54.00 | -18.53 | 27.33 | 8.11 | 33.11 | 132 | 157 | Average | HORIZONTAL |

Vertical

| | Freq | Level | Limit | Over | Read | CableAntenna | Preamp | A/Pos | T/Pos | Remark | Pol/Phase |
|---|---------|--------|--------|--------|-------|--------------|--------|-------|-------|---------|-----------|
| | MHz | dBuV/m | dBuV/m | dB | dBuV | Loss | Factor | cm | deg | | |
| 1 | 4823.75 | 35.76 | 54.00 | -18.24 | 27.62 | 8.11 | 33.11 | 129 | 147 | Average | VERTICAL |
| 2 | 4824.09 | 48.89 | 74.00 | -25.11 | 40.75 | 8.11 | 33.11 | 129 | 147 | Peak | VERTICAL |

| | | | |
|----------------------|--|-----------------------|--|
| Temperature | 25°C | Humidity | 55% |
| Test Engineer | Stim Sung | Configurations | IEEE 802.11ac MCS0/Nss1 VHT20 CH 6 / Chain 1 + Chain 2 + Chain 3 + Chain 4 |
| Test Date | Nov. 21, 2015 | | |
| Test Mode | Mode 1: EUT 1 + Set 1 Ceiling Mount Omni Antenna / 4 dBi | | |

Horizontal

| | Freq | Level | Limit | Over | Read | CableAntenna | Preamp | A/Pos | T/Pos | Remark | Pol/Phase | |
|---|---------|--------|--------|--------|-------|--------------|--------|-------|-------|--------|-----------|------------|
| | MHz | dBuV/m | dBuV/m | dB | dBuV | dB | dB/m | dB | cm | deg | | |
| 1 | 4873.70 | 34.89 | 54.00 | -19.11 | 26.80 | 7.94 | 33.23 | 33.08 | 136 | 137 | Average | HORIZONTAL |
| 2 | 4873.96 | 48.09 | 74.00 | -25.91 | 40.00 | 7.94 | 33.23 | 33.08 | 136 | 137 | Peak | HORIZONTAL |

Vertical

| | Freq | Level | Limit | Over | Read | CableAntenna | Preamp | A/Pos | T/Pos | Remark | Pol/Phase | |
|---|---------|--------|--------|--------|-------|--------------|--------|-------|-------|--------|-----------|----------|
| | MHz | dBuV/m | dBuV/m | dB | dBuV | dB | dB/m | dB | cm | deg | | |
| 1 | 4873.36 | 35.03 | 54.00 | -18.97 | 26.94 | 7.94 | 33.23 | 33.08 | 140 | 128 | Average | VERTICAL |
| 2 | 4873.84 | 48.36 | 74.00 | -25.64 | 40.27 | 7.94 | 33.23 | 33.08 | 140 | 128 | Peak | VERTICAL |

| | | | |
|----------------------|--|-----------------------|---|
| Temperature | 25°C | Humidity | 55% |
| Test Engineer | Stim Sung | Configurations | IEEE 802.11ac MCS0/Nss1 VHT20 CH 11 / Chain 1 + Chain 2 + Chain 3 + Chain 4 |
| Test Date | Nov. 21, 2015 | | |
| Test Mode | Mode 1: EUT 1 + Set 1 Ceiling Mount Omni Antenna / 4 dBi | | |

Horizontal

| | Freq | Level | Limit | Over | Read | CableAntenna | Preamp | A/Pos | T/Pos | Remark | Pol/Phase | |
|---|---------|--------|--------|--------|-------|--------------|--------|-------|-------|--------|-----------|------------|
| | MHz | dBuV/m | dBuV/m | dB | dBuV | Loss | Factor | dB | cm | deg | | |
| 1 | 4923.03 | 48.57 | 74.00 | -25.43 | 40.50 | 7.82 | 33.32 | 33.07 | 138 | 121 | Peak | HORIZONTAL |
| 2 | 4923.93 | 34.91 | 54.00 | -19.09 | 26.85 | 7.78 | 33.35 | 33.07 | 138 | 121 | Average | HORIZONTAL |

Vertical

| | Freq | Level | Limit | Over | Read | CableAntenna | Preamp | A/Pos | T/Pos | Remark | Pol/Phase | |
|---|---------|--------|--------|--------|-------|--------------|--------|-------|-------|--------|-----------|----------|
| | MHz | dBuV/m | dBuV/m | dB | dBuV | Loss | Factor | dB | cm | deg | | |
| 1 | 4924.25 | 48.14 | 74.00 | -25.86 | 40.08 | 7.78 | 33.35 | 33.07 | 140 | 114 | Peak | VERTICAL |
| 2 | 4924.29 | 34.93 | 54.00 | -19.07 | 26.87 | 7.78 | 33.35 | 33.07 | 140 | 114 | Average | VERTICAL |

| | | | |
|----------------------|--|-----------------------|--|
| Temperature | 25°C | Humidity | 55% |
| Test Engineer | Stim Sung | Configurations | IEEE 802.11ac MCS0/Nss1 VHT40 CH 3 / Chain 1 + Chain 2 + Chain 3 + Chain 4 |
| Test Date | Nov. 21, 2015 | | |
| Test Mode | Mode 1: EUT 1 + Set 1 Ceiling Mount Omni Antenna / 4 dBi | | |

Horizontal

| | Freq | Level | Limit | Over | Read | Cable | Antenna | Preamp | A/Pos | T/Pos | Remark | Pol/Phase |
|---|---------|--------|--------|--------|-------|-------|---------|--------|-------|-------|---------|------------|
| | MHz | dBuV/m | dBuV/m | dB | dBuV | Loss | Factor | Factor | cm | deg | | |
| 1 | 4844.79 | 48.66 | 74.00 | -25.34 | 40.54 | 8.03 | 33.17 | 33.08 | 129 | 141 | Peak | HORIZONTAL |
| 2 | 4844.92 | 35.27 | 54.00 | -18.73 | 27.15 | 8.03 | 33.17 | 33.08 | 129 | 141 | Average | HORIZONTAL |

Vertical

| | Freq | Level | Limit | Over | Read | Cable | Antenna | Preamp | A/Pos | T/Pos | Remark | Pol/Phase |
|---|---------|--------|--------|--------|-------|-------|---------|--------|-------|-------|---------|-----------|
| | MHz | dBuV/m | dBuV/m | dB | dBuV | Loss | Factor | Factor | cm | deg | | |
| 1 | 4844.15 | 35.46 | 54.00 | -18.54 | 27.34 | 8.03 | 33.17 | 33.08 | 127 | 138 | Average | VERTICAL |
| 2 | 4844.78 | 48.63 | 74.00 | -25.37 | 40.51 | 8.03 | 33.17 | 33.08 | 127 | 138 | Peak | VERTICAL |

| | | | |
|----------------------|--|-----------------------|--|
| Temperature | 25°C | Humidity | 55% |
| Test Engineer | Stim Sung | Configurations | IEEE 802.11ac MCS0/Nss1 VHT40 CH 6 / Chain 1 + Chain 2 + Chain 3 + Chain 4 |
| Test Date | Nov. 21, 2015 | | |
| Test Mode | Mode 1: EUT 1 + Set 1 Ceiling Mount Omni Antenna / 4 dBi | | |

Horizontal

| | Freq | Level | Limit | Over | Read | Cable | Antenna | Preamp | A/Pos | T/Pos | Remark | Pol/Phase |
|---|---------|--------|--------|--------|-------|-------|---------|--------|-------|-------|---------|------------|
| | MHz | dBuV/m | dBuV/m | dB | dBuV | Loss | Factor | Factor | cm | deg | | |
| 1 | 4874.01 | 48.40 | 74.00 | -25.60 | 40.31 | 7.94 | 33.23 | 33.08 | 124 | 133 | Peak | HORIZONTAL |
| 2 | 4874.41 | 34.87 | 54.00 | -19.13 | 26.78 | 7.94 | 33.23 | 33.08 | 124 | 133 | Average | HORIZONTAL |

Vertical

| | Freq | Level | Limit | Over | Read | Cable | Antenna | Preamp | A/Pos | T/Pos | Remark | Pol/Phase |
|---|---------|--------|--------|--------|-------|-------|---------|--------|-------|-------|---------|-----------|
| | MHz | dBuV/m | dBuV/m | dB | dBuV | Loss | Factor | Factor | cm | deg | | |
| 1 | 4874.25 | 35.11 | 54.00 | -18.89 | 27.02 | 7.94 | 33.23 | 33.08 | 121 | 125 | Average | VERTICAL |
| 2 | 4874.88 | 48.34 | 74.00 | -25.66 | 40.25 | 7.94 | 33.23 | 33.08 | 121 | 125 | Peak | VERTICAL |

| | | | |
|----------------------|--|-----------------------|--|
| Temperature | 25°C | Humidity | 55% |
| Test Engineer | Stim Sung | Configurations | IEEE 802.11ac MCS0/Nss1 VHT40 CH 9 / Chain 1 + Chain 2 + Chain 3 + Chain 4 |
| Test Date | Nov. 21, 2015 | | |
| Test Mode | Mode 1: EUT 1 + Set 1 Ceiling Mount Omni Antenna / 4 dBi | | |

Horizontal

| | Freq | Level | Limit | Over | Read | Cable | Antenna | Preamp | A/Pos | T/Pos | Remark | Pol/Phase |
|---|---------|--------|--------|--------|-------|-------|---------|--------|-------|-------|---------|------------|
| | MHz | dBuV/m | dBuV/m | dB | dBuV | Loss | Factor | Factor | cm | deg | | |
| 1 | 4903.28 | 47.73 | 74.00 | -26.27 | 39.65 | 7.86 | 33.29 | 33.07 | 118 | 118 | Peak | HORIZONTAL |
| 2 | 4905.00 | 34.72 | 54.00 | -19.28 | 26.64 | 7.86 | 33.29 | 33.07 | 118 | 118 | Average | HORIZONTAL |

Vertical

| | Freq | Level | Limit | Over | Read | Cable | Antenna | Preamp | A/Pos | T/Pos | Remark | Pol/Phase |
|---|---------|--------|--------|--------|-------|-------|---------|--------|-------|-------|---------|-----------|
| | MHz | dBuV/m | dBuV/m | dB | dBuV | Loss | Factor | Factor | cm | deg | | |
| 1 | 4903.91 | 35.02 | 54.00 | -18.98 | 26.94 | 7.86 | 33.29 | 33.07 | 121 | 111 | Average | VERTICAL |
| 2 | 4904.72 | 48.39 | 74.00 | -25.61 | 40.31 | 7.86 | 33.29 | 33.07 | 121 | 111 | Peak | VERTICAL |

Note:

The amplitude of spurious emissions that are attenuated by more than 20dB below the permissible value has no need to be reported.

Emission level (dBuV/m) = 20 log Emission level (uV/m).

Corrected Reading: Antenna Factor + Cable Loss + Read Level - Preamp Factor = Level.

| | | | |
|----------------------|--|-----------------------|--|
| Temperature | 25°C | Humidity | 55% |
| Test Engineer | Stim Sung | Configurations | IEEE 802.11ac MCS0/Nss1 VHT20 CH 1 / Chain 1 + Chain 2 + Chain 3 + Chain 4 |
| Test Date | Nov. 21, 2015 | | |
| Test Mode | Mode 2: EUT 1 + Set 2 Sector Antenna / 7.5 dBi | | |

Horizontal

| | Freq | Level | Limit Line | Over Limit | Read Level | Cable Loss | Antenna Factor | Preamp Factor | A/Pos | T/Pos | Remark | Pol/Phase |
|---|---------|--------|------------|------------|------------|------------|----------------|---------------|-------|-------|---------|------------|
| | MHz | dBuV/m | dBuV/m | dB | dBuV | dB | dB/m | dB | cm | deg | | |
| 1 | 4824.73 | 49.01 | 74.00 | -24.99 | 40.87 | 8.11 | 33.11 | 33.08 | 117 | 318 | Peak | HORIZONTAL |
| 2 | 4824.88 | 36.13 | 54.00 | -17.87 | 27.99 | 8.11 | 33.11 | 33.08 | 117 | 318 | Average | HORIZONTAL |

Vertical

| | Freq | Level | Limit Line | Over Limit | Read Level | Cable Loss | Antenna Factor | Preamp Factor | A/Pos | T/Pos | Remark | Pol/Phase |
|---|---------|--------|------------|------------|------------|------------|----------------|---------------|-------|-------|---------|-----------|
| | MHz | dBuV/m | dBuV/m | dB | dBuV | dB | dB/m | dB | cm | deg | | |
| 1 | 4823.84 | 48.97 | 74.00 | -25.03 | 40.83 | 8.11 | 33.11 | 33.08 | 119 | 324 | Peak | VERTICAL |
| 2 | 4824.84 | 35.81 | 54.00 | -18.19 | 27.67 | 8.11 | 33.11 | 33.08 | 119 | 324 | Average | VERTICAL |

| | | | |
|----------------------|--|-----------------------|--|
| Temperature | 25°C | Humidity | 55% |
| Test Engineer | Stim Sung | Configurations | IEEE 802.11ac MCS0/Nss1 VHT20 CH 6 / Chain 1 + Chain 2 + Chain 3 + Chain 4 |
| Test Date | Nov. 21, 2015 | | |
| Test Mode | Mode 2: EUT 1 + Set 2 Sector Antenna / 7.5 dBi | | |

Horizontal

| | Freq | Level | Limit | Over | Read | Cable | Antenna | Preamp | A/Pos | T/Pos | Remark | Pol/Phase |
|---|---------|--------|--------|--------|-------|-------|---------|--------|-------|-------|---------|------------|
| | MHz | dBuV/m | dBuV/m | dB | dBuV | Loss | Factor | Factor | cm | deg | | |
| 1 | 4873.66 | 35.89 | 54.00 | -18.11 | 27.80 | 7.94 | 33.23 | 33.08 | 115 | 291 | Average | HORIZONTAL |
| 2 | 4874.29 | 48.85 | 74.00 | -25.15 | 40.76 | 7.94 | 33.23 | 33.08 | 115 | 291 | Peak | HORIZONTAL |

Vertical

| | Freq | Level | Limit | Over | Read | Cable | Antenna | Preamp | A/Pos | T/Pos | Remark | Pol/Phase |
|---|---------|--------|--------|--------|-------|-------|---------|--------|-------|-------|---------|-----------|
| | MHz | dBuV/m | dBuV/m | dB | dBuV | Loss | Factor | Factor | cm | deg | | |
| 1 | 4873.53 | 36.10 | 54.00 | -17.90 | 28.01 | 7.94 | 33.23 | 33.08 | 117 | 289 | Average | VERTICAL |
| 2 | 4874.12 | 48.96 | 74.00 | -25.04 | 40.87 | 7.94 | 33.23 | 33.08 | 117 | 289 | Peak | VERTICAL |

| | | | |
|----------------------|--|-----------------------|---|
| Temperature | 25°C | Humidity | 55% |
| Test Engineer | Stim Sung | Configurations | IEEE 802.11ac MCS0/Nss1 VHT20 CH 11 / Chain 1 + Chain 2 + Chain 3 + Chain 4 |
| Test Date | Nov. 21, 2015 | | |
| Test Mode | Mode 2: EUT 1 + Set 2 Sector Antenna / 7.5 dBi | | |

Horizontal

| | Freq | Level | Limit | Over | Read | Cable | Antenna | Preamp | A/Pos | T/Pos | Remark | Pol/Phase |
|---|---------|--------|--------|--------|-------|-------|---------|--------|-------|-------|---------|------------|
| | MHz | dBuV/m | dBuV/m | dB | dBuV | Loss | Factor | Factor | cm | deg | | |
| 1 | 4924.66 | 48.73 | 74.00 | -25.27 | 40.67 | 7.78 | 33.35 | 33.07 | 115 | 318 | Peak | HORIZONTAL |
| 2 | 4924.74 | 35.84 | 54.00 | -18.16 | 27.78 | 7.78 | 33.35 | 33.07 | 115 | 318 | Average | HORIZONTAL |

Vertical

| | Freq | Level | Limit | Over | Read | Cable | Antenna | Preamp | A/Pos | T/Pos | Remark | Pol/Phase |
|---|---------|--------|--------|--------|-------|-------|---------|--------|-------|-------|---------|-----------|
| | MHz | dBuV/m | dBuV/m | dB | dBuV | Loss | Factor | Factor | cm | deg | | |
| 1 | 4923.62 | 49.16 | 74.00 | -24.84 | 41.10 | 7.78 | 33.35 | 33.07 | 117 | 312 | Peak | VERTICAL |
| 2 | 4924.16 | 36.08 | 54.00 | -17.92 | 28.02 | 7.78 | 33.35 | 33.07 | 117 | 312 | Average | VERTICAL |

| | | | |
|----------------------|--|-----------------------|--|
| Temperature | 25°C | Humidity | 55% |
| Test Engineer | Stim Sung | Configurations | IEEE 802.11ac MCS0/Nss1 VHT40 CH 3 / Chain 1 + Chain 2 + Chain 3 + Chain 4 |
| Test Date | Nov. 21, 2015 | | |
| Test Mode | Mode 2: EUT 1 + Set 2 Sector Antenna / 7.5 dBi | | |

Horizontal

| | Freq | Level | Limit Line | Over Limit | Read Level | Cable Loss | Antenna Factor | Preamp Factor | A/Pos | T/Pos | Remark | Pol/Phase |
|---|---------|--------|------------|------------|------------|------------|----------------|---------------|-------|-------|---------|------------|
| | MHz | dBuV/m | dBuV/m | dB | dBuV | dB | dB/m | dB | cm | deg | | |
| 1 | 4843.83 | 49.49 | 74.00 | -24.51 | 41.37 | 8.03 | 33.17 | 33.08 | 123 | 318 | Peak | HORIZONTAL |
| 2 | 4844.27 | 35.82 | 54.00 | -18.18 | 27.70 | 8.03 | 33.17 | 33.08 | 123 | 318 | Average | HORIZONTAL |

Vertical

| | Freq | Level | Limit Line | Over Limit | Read Level | Cable Loss | Antenna Factor | Preamp Factor | A/Pos | T/Pos | Remark | Pol/Phase |
|---|---------|--------|------------|------------|------------|------------|----------------|---------------|-------|-------|---------|-----------|
| | MHz | dBuV/m | dBuV/m | dB | dBuV | dB | dB/m | dB | cm | deg | | |
| 1 | 4843.63 | 36.19 | 54.00 | -17.81 | 28.07 | 8.03 | 33.17 | 33.08 | 126 | 325 | Average | VERTICAL |
| 2 | 4844.70 | 49.25 | 74.00 | -24.75 | 41.13 | 8.03 | 33.17 | 33.08 | 126 | 325 | Peak | VERTICAL |

| | | | |
|----------------------|--|-----------------------|--|
| Temperature | 25°C | Humidity | 55% |
| Test Engineer | Stim Sung | Configurations | IEEE 802.11ac MCS0/Nss1 VHT40 CH 6 / Chain 1 + Chain 2 + Chain 3 + Chain 4 |
| Test Date | Nov. 21, 2015 | | |
| Test Mode | Mode 2: EUT 1 + Set 2 Sector Antenna / 7.5 dBi | | |

Horizontal

| | Freq | Level | Limit Line | Over Limit | Read Level | CableAntenna Loss | Antenna Factor | Preamp Factor | A/Pos | T/Pos | Remark | Pol/Phase |
|---|---------|--------|------------|------------|------------|-------------------|----------------|---------------|-------|-------|---------|------------|
| | MHz | dBuV/m | dBuV/m | dB | dBuV | dB | dB/m | dB | cm | deg | | |
| 1 | 4873.22 | 49.03 | 74.00 | -24.97 | 40.94 | 7.94 | 33.23 | 33.08 | 123 | 318 | Peak | HORIZONTAL |
| 2 | 4874.09 | 35.87 | 54.00 | -18.13 | 27.78 | 7.94 | 33.23 | 33.08 | 123 | 318 | Average | HORIZONTAL |

Vertical

| | Freq | Level | Limit Line | Over Limit | Read Level | CableAntenna Loss | Antenna Factor | Preamp Factor | A/Pos | T/Pos | Remark | Pol/Phase |
|---|---------|--------|------------|------------|------------|-------------------|----------------|---------------|-------|-------|---------|-----------|
| | MHz | dBuV/m | dBuV/m | dB | dBuV | dB | dB/m | dB | cm | deg | | |
| 1 | 4873.23 | 36.04 | 54.00 | -17.96 | 27.95 | 7.94 | 33.23 | 33.08 | 116 | 315 | Average | VERTICAL |
| 2 | 4873.50 | 48.71 | 74.00 | -25.29 | 40.62 | 7.94 | 33.23 | 33.08 | 116 | 315 | Peak | VERTICAL |

| | | | |
|----------------------|--|-----------------------|--|
| Temperature | 25°C | Humidity | 55% |
| Test Engineer | Stim Sung | Configurations | IEEE 802.11ac MCS0/Nss1 VHT40 CH 9 / Chain 1 + Chain 2 + Chain 3 + Chain 4 |
| Test Date | Nov. 21, 2015 | | |
| Test Mode | Mode 2: EUT 1 + Set 2 Sector Antenna / 7.5 dBi | | |

Horizontal

| | Freq | Level | Limit | Over | Read | Cable | Antenna | Preamp | A/Pos | T/Pos | Remark | Pol/Phase |
|---|---------|--------|--------|--------|-------|-------|---------|--------|-------|-------|---------|------------|
| | MHz | dBuV/m | dBuV/m | dB | dBuV | dB | dB/m | dB | cm | deg | | |
| 1 | 4903.28 | 36.10 | 54.00 | -17.90 | 28.02 | 7.86 | 33.29 | 33.07 | 118 | 311 | Average | HORIZONTAL |
| 2 | 4903.68 | 48.73 | 74.00 | -25.27 | 40.65 | 7.86 | 33.29 | 33.07 | 118 | 311 | Peak | HORIZONTAL |

Vertical

| | Freq | Level | Limit | Over | Read | Cable | Antenna | Preamp | A/Pos | T/Pos | Remark | Pol/Phase |
|---|---------|--------|--------|--------|-------|-------|---------|--------|-------|-------|---------|-----------|
| | MHz | dBuV/m | dBuV/m | dB | dBuV | dB | dB/m | dB | cm | deg | | |
| 1 | 4903.31 | 49.25 | 74.00 | -24.75 | 41.17 | 7.86 | 33.29 | 33.07 | 120 | 311 | Peak | VERTICAL |
| 2 | 4903.81 | 36.23 | 54.00 | -17.77 | 28.15 | 7.86 | 33.29 | 33.07 | 120 | 311 | Average | VERTICAL |

Note:

The amplitude of spurious emissions that are attenuated by more than 20dB below the permissible value has no need to be reported.

Emission level (dBuV/m) = 20 log Emission level (uV/m).

Corrected Reading: Antenna Factor + Cable Loss + Read Level - Preamp Factor = Level.

| | | | |
|----------------------|--|-----------------------|--|
| Temperature | 25°C | Humidity | 55% |
| Test Engineer | Stim Sung | Configurations | IEEE 802.11ac MCS0/Nss1 VHT20 CH 1 / Chain 1 + Chain 2 + Chain 3 + Chain 4 |
| Test Date | Nov. 21, 2015 | | |
| Test Mode | Mode 3: EUT 1 + Set 3 Sector Antenna / 5.5 dBi | | |

Horizontal

| | Freq | Level | Limit | Over | Read | CableAntenna | Preamp | A/Pos | T/Pos | Remark | Pol/Phase | |
|---|---------|--------|--------|--------|-------|--------------|--------|-------|-------|--------|-----------|------------|
| | MHz | dBuV/m | dBuV/m | dB | dBuV | dB | dB/m | dB | cm | deg | | |
| 1 | 4825.60 | 48.72 | 74.00 | -25.28 | 40.59 | 8.07 | 33.14 | 33.08 | 188 | 101 | Peak | HORIZONTAL |
| 2 | 4828.60 | 36.27 | 54.00 | -17.73 | 28.14 | 8.07 | 33.14 | 33.08 | 188 | 101 | Average | HORIZONTAL |

Vertical

| | Freq | Level | Limit | Over | Read | CableAntenna | Preamp | A/Pos | T/Pos | Remark | Pol/Phase | |
|---|---------|--------|--------|--------|-------|--------------|--------|-------|-------|--------|-----------|----------|
| | MHz | dBuV/m | dBuV/m | dB | dBuV | dB | dB/m | dB | cm | deg | | |
| 1 | 4815.04 | 36.24 | 54.00 | -17.76 | 28.10 | 8.11 | 33.11 | 33.08 | 168 | 95 | Average | VERTICAL |
| 2 | 4830.16 | 48.89 | 74.00 | -25.11 | 40.76 | 8.07 | 33.14 | 33.08 | 168 | 95 | Peak | VERTICAL |

| | | | |
|----------------------|--|-----------------------|--|
| Temperature | 25°C | Humidity | 55% |
| Test Engineer | Stim Sung | Configurations | IEEE 802.11ac MCS0/Nss1 VHT20 CH 6 / Chain 1 + Chain 2 + Chain 3 + Chain 4 |
| Test Date | Nov. 21, 2015 | | |
| Test Mode | Mode 3: EUT 1 + Set 3 Sector Antenna / 5.5 dBi | | |

Horizontal

| | Freq | Level | Limit | Over | Read | Cable | Antenna | Preamp | A/Pos | T/Pos | Remark | Pol/Phase |
|---|---------|--------|--------|--------|-------|-------|---------|--------|-------|-------|---------|------------|
| | MHz | dBuV/m | dBuV/m | dB | dBuV | Loss | Factor | Factor | cm | deg | | |
| 1 | 4882.12 | 48.78 | 74.00 | -25.22 | 40.69 | 7.90 | 33.26 | 33.07 | 179 | 108 | Peak | HORIZONTAL |
| 2 | 4883.88 | 35.87 | 54.00 | -18.13 | 27.78 | 7.90 | 33.26 | 33.07 | 179 | 108 | Average | HORIZONTAL |

Vertical

| | Freq | Level | Limit | Over | Read | Cable | Antenna | Preamp | A/Pos | T/Pos | Remark | Pol/Phase |
|---|---------|--------|--------|--------|-------|-------|---------|--------|-------|-------|---------|-----------|
| | MHz | dBuV/m | dBuV/m | dB | dBuV | Loss | Factor | Factor | cm | deg | | |
| 1 | 4875.28 | 49.24 | 74.00 | -24.76 | 41.15 | 7.94 | 33.23 | 33.08 | 180 | 122 | Peak | VERTICAL |
| 2 | 4884.00 | 36.88 | 54.00 | -17.12 | 28.79 | 7.90 | 33.26 | 33.07 | 180 | 122 | Average | VERTICAL |

| | | | |
|----------------------|--|-----------------------|---|
| Temperature | 25°C | Humidity | 55% |
| Test Engineer | Stim Sung | Configurations | IEEE 802.11ac MCS0/Nss1 VHT20 CH 11 / Chain 1 + Chain 2 + Chain 3 + Chain 4 |
| Test Date | Nov. 21, 2015 | | |
| Test Mode | Mode 3: EUT 1 + Set 3 Sector Antenna / 5.5 dBi | | |

Horizontal

| | Freq | Level | Limit | Over | Read | CableAntenna | Preamp | A/Pos | T/Pos | Remark | Pol/Phase | |
|---|---------|--------|--------|--------|-------|--------------|--------|-------|-------|--------|-----------|------------|
| | MHz | dBuV/m | dBuV/m | dB | dBuV | Loss | Factor | dB | cm | deg | | |
| 1 | 4917.88 | 35.93 | 54.00 | -18.07 | 27.86 | 7.82 | 33.32 | 33.07 | 193 | 131 | Average | HORIZONTAL |
| 2 | 4920.24 | 48.94 | 74.00 | -25.06 | 40.87 | 7.82 | 33.32 | 33.07 | 193 | 131 | Peak | HORIZONTAL |

Vertical

| | Freq | Level | Limit | Over | Read | CableAntenna | Preamp | A/Pos | T/Pos | Remark | Pol/Phase | |
|---|---------|--------|--------|--------|-------|--------------|--------|-------|-------|--------|-----------|----------|
| | MHz | dBuV/m | dBuV/m | dB | dBuV | Loss | Factor | dB | cm | deg | | |
| 1 | 4915.72 | 35.80 | 54.00 | -18.20 | 27.73 | 7.82 | 33.32 | 33.07 | 185 | 128 | Average | VERTICAL |
| 2 | 4925.24 | 48.57 | 74.00 | -25.43 | 40.50 | 7.78 | 33.35 | 33.06 | 185 | 128 | Peak | VERTICAL |

| | | | |
|----------------------|--|-----------------------|--|
| Temperature | 25°C | Humidity | 55% |
| Test Engineer | Stim Sung | Configurations | IEEE 802.11ac MCS0/Nss1 VHT40 CH 3 / Chain 1 + Chain 2 + Chain 3 + Chain 4 |
| Test Date | Nov. 21, 2015 | | |
| Test Mode | Mode 3: EUT 1 + Set 3 Sector Antenna / 5.5 dBi | | |

Horizontal

| | Freq | Level | Limit | Over | Read | Cable | Antenna | Preamp | A/Pos | T/Pos | Remark | Pol/Phase |
|---|---------|--------|--------|--------|-------|-------|---------|--------|-------|-------|---------|------------|
| | MHz | dBuV/m | dBuV/m | dB | dBuV | Loss | Factor | Factor | cm | deg | | |
| 1 | 4837.48 | 36.31 | 54.00 | -17.69 | 28.18 | 8.07 | 33.14 | 33.08 | 200 | 140 | Average | HORIZONTAL |
| 2 | 4843.52 | 49.23 | 74.00 | -24.77 | 41.11 | 8.03 | 33.17 | 33.08 | 200 | 140 | Peak | HORIZONTAL |

Vertical

| | Freq | Level | Limit | Over | Read | Cable | Antenna | Preamp | A/Pos | T/Pos | Remark | Pol/Phase |
|---|---------|--------|--------|--------|-------|-------|---------|--------|-------|-------|---------|-----------|
| | MHz | dBuV/m | dBuV/m | dB | dBuV | Loss | Factor | Factor | cm | deg | | |
| 1 | 4835.96 | 49.27 | 74.00 | -24.73 | 41.14 | 8.07 | 33.14 | 33.08 | 174 | 151 | Peak | VERTICAL |
| 2 | 4838.08 | 36.15 | 54.00 | -17.85 | 28.02 | 8.07 | 33.14 | 33.08 | 174 | 151 | Average | VERTICAL |



| | | | |
|----------------------|--|-----------------------|--|
| Temperature | 25°C | Humidity | 55% |
| Test Engineer | Stim Sung | Configurations | IEEE 802.11ac MCS0/Nss1 VHT40 CH 6 / Chain 1 + Chain 2 + Chain 3 + Chain 4 |
| Test Date | Nov. 21, 2015 | | |
| Test Mode | Mode 3: EUT 1 + Set 3 Sector Antenna / 5.5 dBi | | |

Horizontal

| | Freq | Level | Limit | Over | Read | Cable | Antenna | Preamp | A/Pos | T/Pos | Remark | Pol/Phase |
|---|---------|--------|--------|--------|-------|-------|---------|--------|-------|-------|---------|------------|
| | MHz | dBuV/m | dBuV/m | dB | dBuV | Loss | Factor | Factor | cm | deg | | |
| 1 | 4867.24 | 49.18 | 74.00 | -24.82 | 41.09 | 7.94 | 33.23 | 33.08 | 160 | 255 | Peak | HORIZONTAL |
| 2 | 4874.36 | 35.85 | 54.00 | -18.15 | 27.76 | 7.94 | 33.23 | 33.08 | 160 | 255 | Average | HORIZONTAL |

Vertical

| | Freq | Level | Limit | Over | Read | Cable | Antenna | Preamp | A/Pos | T/Pos | Remark | Pol/Phase |
|---|---------|--------|--------|--------|-------|-------|---------|--------|-------|-------|---------|-----------|
| | MHz | dBuV/m | dBuV/m | dB | dBuV | Loss | Factor | Factor | cm | deg | | |
| 1 | 4876.00 | 49.17 | 74.00 | -24.83 | 41.08 | 7.94 | 33.23 | 33.08 | 169 | 248 | Peak | VERTICAL |
| 2 | 4876.76 | 35.89 | 54.00 | -18.11 | 27.80 | 7.94 | 33.23 | 33.08 | 169 | 248 | Average | VERTICAL |

| | | | |
|----------------------|--|-----------------------|--|
| Temperature | 25°C | Humidity | 55% |
| Test Engineer | Stim Sung | Configurations | IEEE 802.11ac MCS0/Nss1 VHT40 CH 9 / Chain 1 + Chain 2 + Chain 3 + Chain 4 |
| Test Date | Nov. 21, 2015 | | |
| Test Mode | Mode 3: EUT 1 + Set 3 Sector Antenna / 5.5 dBi | | |

Horizontal

| | Freq | Level | Limit | Over | Read | Cable | Antenna | Preamp | A/Pos | T/Pos | Remark | Pol/Phase |
|---|---------|--------|--------|--------|-------|-------|---------|--------|-------|-------|---------|------------|
| | MHz | dBuV/m | dBuV/m | dB | dBuV | dB | dB/m | dB | cm | deg | | |
| 1 | 4904.20 | 35.97 | 54.00 | -18.03 | 27.89 | 7.86 | 33.29 | 33.07 | 164 | 261 | Average | HORIZONTAL |
| 2 | 4904.24 | 49.58 | 74.00 | -24.42 | 41.50 | 7.86 | 33.29 | 33.07 | 164 | 261 | Peak | HORIZONTAL |

Vertical

| | Freq | Level | Limit | Over | Read | Cable | Antenna | Preamp | A/Pos | T/Pos | Remark | Pol/Phase |
|---|---------|--------|--------|--------|-------|-------|---------|--------|-------|-------|---------|-----------|
| | MHz | dBuV/m | dBuV/m | dB | dBuV | dB | dB/m | dB | cm | deg | | |
| 1 | 4901.44 | 36.04 | 54.00 | -17.96 | 27.96 | 7.86 | 33.29 | 33.07 | 170 | 313 | Average | VERTICAL |
| 2 | 4903.28 | 48.33 | 74.00 | -25.67 | 40.25 | 7.86 | 33.29 | 33.07 | 170 | 313 | Peak | VERTICAL |

Note:

The amplitude of spurious emissions that are attenuated by more than 20dB below the permissible value has no need to be reported.

Emission level (dBuV/m) = 20 log Emission level (uV/m).

Corrected Reading: Antenna Factor + Cable Loss + Read Level - Preamp Factor = Level.

| | | | |
|----------------------|---|-----------------------|--|
| Temperature | 25°C | Humidity | 55% |
| Test Engineer | Stim Sung | Configurations | IEEE 802.11ac MCS0/Nss1 VHT20 CH 1 / Chain 1 + Chain 2 + Chain 3 + Chain 4 |
| Test Date | Nov. 21, 2015 | | |
| Test Mode | Mode 4: EUT 1 + Set 4 Sector Antenna / 10.5 dBi | | |

Horizontal

| | Freq | Level | Limit | Over | Read | Cable | Antenna | Preamp | A/Pos | T/Pos | Remark | Pol/Phase |
|---|---------|--------|--------|--------|-------|-------|---------|--------|-------|-------|---------|------------|
| | MHz | dBuV/m | dBuV/m | dB | dBuV | dB | dB/m | dB | cm | deg | | |
| 1 | 4824.02 | 38.33 | 54.00 | -15.67 | 30.19 | 8.11 | 33.11 | 33.08 | 131 | 178 | Average | HORIZONTAL |
| 2 | 4824.47 | 49.08 | 74.00 | -24.92 | 40.94 | 8.11 | 33.11 | 33.08 | 131 | 178 | Peak | HORIZONTAL |

Vertical

| | Freq | Level | Limit | Over | Read | Cable | Antenna | Preamp | A/Pos | T/Pos | Remark | Pol/Phase |
|---|---------|--------|--------|--------|-------|-------|---------|--------|-------|-------|---------|-----------|
| | MHz | dBuV/m | dBuV/m | dB | dBuV | dB | dB/m | dB | cm | deg | | |
| 1 | 4824.17 | 49.79 | 74.00 | -24.21 | 41.65 | 8.11 | 33.11 | 33.08 | 128 | 173 | Peak | VERTICAL |
| 2 | 4824.32 | 38.44 | 54.00 | -15.56 | 30.30 | 8.11 | 33.11 | 33.08 | 128 | 173 | Average | VERTICAL |

| | | | |
|----------------------|---|-----------------------|--|
| Temperature | 25°C | Humidity | 55% |
| Test Engineer | Stim Sung | Configurations | IEEE 802.11ac MCS0/Nss1 VHT20 CH 6 / Chain 1 + Chain 2 + Chain 3 + Chain 4 |
| Test Date | Nov. 21, 2015 | | |
| Test Mode | Mode 4: EUT 1 + Set 4 Sector Antenna / 10.5 dBi | | |

Horizontal

| | Freq | Level | Limit | Over | Read | Cable | Antenna | Preamp | A/Pos | T/Pos | Remark | Pol/Phase |
|---|---------|--------|--------|--------|-------|-------|---------|--------|-------|-------|---------|------------|
| | MHz | dBuV/m | dBuV/m | dB | dBuV | dB | dB/m | dB | cm | deg | | |
| 1 | 4873.85 | 37.74 | 54.00 | -16.26 | 29.65 | 7.94 | 33.23 | 33.08 | 131 | 334 | Average | HORIZONTAL |
| 2 | 4873.94 | 49.92 | 74.00 | -24.08 | 41.83 | 7.94 | 33.23 | 33.08 | 131 | 334 | Peak | HORIZONTAL |

Vertical

| | Freq | Level | Limit | Over | Read | Cable | Antenna | Preamp | A/Pos | T/Pos | Remark | Pol/Phase |
|---|---------|--------|--------|--------|-------|-------|---------|--------|-------|-------|---------|-----------|
| | MHz | dBuV/m | dBuV/m | dB | dBuV | dB | dB/m | dB | cm | deg | | |
| 1 | 4873.53 | 49.00 | 74.00 | -25.00 | 40.91 | 7.94 | 33.23 | 33.08 | 128 | 321 | Peak | VERTICAL |
| 2 | 4874.03 | 36.35 | 54.00 | -17.65 | 28.26 | 7.94 | 33.23 | 33.08 | 128 | 321 | Average | VERTICAL |

| | | | |
|----------------------|---|-----------------------|---|
| Temperature | 25°C | Humidity | 55% |
| Test Engineer | Stim Sung | Configurations | IEEE 802.11ac MCS0/Nss1 VHT20 CH 11 / Chain 1 + Chain 2 + Chain 3 + Chain 4 |
| Test Date | Nov. 21, 2015 | | |
| Test Mode | Mode 4: EUT 1 + Set 4 Sector Antenna / 10.5 dBi | | |

Horizontal

| | Freq | Level | Limit Line | Over Limit | Read Level | CableAntenna Loss | Antenna Factor | Preamp Factor | A/Pos | T/Pos | Remark | Pol/Phase |
|---|---------|--------|------------|------------|------------|-------------------|----------------|---------------|-------|-------|---------|------------|
| | MHz | dBuV/m | dBuV/m | dB | dBuV | dB | dB/m | dB | cm | deg | | |
| 1 | 4924.10 | 48.67 | 74.00 | -25.33 | 40.61 | 7.78 | 33.35 | 33.07 | 129 | 336 | Peak | HORIZONTAL |
| 2 | 4924.80 | 36.08 | 54.00 | -17.92 | 28.02 | 7.78 | 33.35 | 33.07 | 129 | 336 | Average | HORIZONTAL |

Vertical

| | Freq | Level | Limit Line | Over Limit | Read Level | CableAntenna Loss | Antenna Factor | Preamp Factor | A/Pos | T/Pos | Remark | Pol/Phase |
|---|---------|--------|------------|------------|------------|-------------------|----------------|---------------|-------|-------|---------|-----------|
| | MHz | dBuV/m | dBuV/m | dB | dBuV | dB | dB/m | dB | cm | deg | | |
| 1 | 4923.05 | 48.79 | 74.00 | -25.21 | 40.72 | 7.82 | 33.32 | 33.07 | 139 | 306 | Peak | VERTICAL |
| 2 | 4924.25 | 36.13 | 54.00 | -17.87 | 28.07 | 7.78 | 33.35 | 33.07 | 139 | 306 | Average | VERTICAL |

| | | | |
|----------------------|---|-----------------------|--|
| Temperature | 25°C | Humidity | 55% |
| Test Engineer | Stim Sung | Configurations | IEEE 802.11ac MCS0/Nss1 VHT40 CH 3 / Chain 1 + Chain 2 + Chain 3 + Chain 4 |
| Test Date | Nov. 21, 2015 | | |
| Test Mode | Mode 4: EUT 1 + Set 4 Sector Antenna / 10.5 dBi | | |

Horizontal

| | Freq | Level | Limit Line | Over Limit | Read Level | Cable Loss | Antenna Factor | Preamp Factor | A/Pos | T/Pos | Remark | Pol/Phase |
|---|---------|--------|------------|------------|------------|------------|----------------|---------------|-------|-------|---------|------------|
| | MHz | dBuV/m | dBuV/m | dB | dBuV | dB | dB/m | dB | cm | deg | | |
| 1 | 4843.57 | 48.76 | 74.00 | -25.24 | 40.64 | 8.03 | 33.17 | 33.08 | 133 | 175 | Peak | HORIZONTAL |
| 2 | 4843.91 | 35.85 | 54.00 | -18.15 | 27.73 | 8.03 | 33.17 | 33.08 | 133 | 175 | Average | HORIZONTAL |

Vertical

| | Freq | Level | Limit Line | Over Limit | Read Level | Cable Loss | Antenna Factor | Preamp Factor | A/Pos | T/Pos | Remark | Pol/Phase |
|---|---------|--------|------------|------------|------------|------------|----------------|---------------|-------|-------|---------|-----------|
| | MHz | dBuV/m | dBuV/m | dB | dBuV | dB | dB/m | dB | cm | deg | | |
| 1 | 4843.31 | 49.35 | 74.00 | -24.65 | 41.23 | 8.03 | 33.17 | 33.08 | 131 | 178 | Peak | VERTICAL |
| 2 | 4844.41 | 35.83 | 54.00 | -18.17 | 27.71 | 8.03 | 33.17 | 33.08 | 131 | 178 | Average | VERTICAL |

| | | | |
|----------------------|---|-----------------------|--|
| Temperature | 25°C | Humidity | 55% |
| Test Engineer | Stim Sung | Configurations | IEEE 802.11ac MCS0/Nss1 VHT40 CH 6 / Chain 1 + Chain 2 + Chain 3 + Chain 4 |
| Test Date | Nov. 21, 2015 | | |
| Test Mode | Mode 4: EUT 1 + Set 4 Sector Antenna / 10.5 dBi | | |

Horizontal

| | Freq | Level | Limit | Over | Read | CableAntenna | Preamp | A/Pos | T/Pos | Remark | Pol/Phase | |
|---|---------|--------|--------|--------|-------|--------------|--------|-------|-------|--------|-----------|------------|
| | MHz | dBuV/m | dBuV/m | dB | dBuV | dB | dB/m | dB | cm | deg | | |
| 1 | 4873.17 | 49.32 | 74.00 | -24.68 | 41.23 | 7.94 | 33.23 | 33.08 | 119 | 171 | Peak | HORIZONTAL |
| 2 | 4873.71 | 35.96 | 54.00 | -18.04 | 27.87 | 7.94 | 33.23 | 33.08 | 119 | 171 | Average | HORIZONTAL |

Vertical

| | Freq | Level | Limit | Over | Read | CableAntenna | Preamp | A/Pos | T/Pos | Remark | Pol/Phase | |
|---|---------|--------|--------|--------|-------|--------------|--------|-------|-------|--------|-----------|----------|
| | MHz | dBuV/m | dBuV/m | dB | dBuV | dB | dB/m | dB | cm | deg | | |
| 1 | 4873.90 | 49.07 | 74.00 | -24.93 | 40.98 | 7.94 | 33.23 | 33.08 | 132 | 172 | Peak | VERTICAL |
| 2 | 4874.11 | 35.63 | 54.00 | -18.37 | 27.54 | 7.94 | 33.23 | 33.08 | 132 | 172 | Average | VERTICAL |

| | | | |
|----------------------|---|-----------------------|--|
| Temperature | 25°C | Humidity | 55% |
| Test Engineer | Stim Sung | Configurations | IEEE 802.11ac MCS0/Nss1 VHT40 CH 9 / Chain 1 + Chain 2 + Chain 3 + Chain 4 |
| Test Date | Nov. 21, 2015 | | |
| Test Mode | Mode 4: EUT 1 + Set 4 Sector Antenna / 10.5 dBi | | |

Horizontal

| | Freq | Level | Limit | Over | Read | Cable | Antenna | Preamp | A/Pos | T/Pos | Remark | Pol/Phase |
|---|---------|--------|--------|--------|-------|-------|---------|--------|-------|-------|---------|------------|
| | MHz | dBuV/m | dBuV/m | dB | dBuV | Loss | Factor | Factor | cm | deg | | |
| 1 | 4903.32 | 35.95 | 54.00 | -18.05 | 27.87 | 7.86 | 33.29 | 33.07 | 138 | 173 | Average | HORIZONTAL |
| 2 | 4903.71 | 48.58 | 74.00 | -25.42 | 40.50 | 7.86 | 33.29 | 33.07 | 138 | 173 | Peak | HORIZONTAL |

Vertical

| | Freq | Level | Limit | Over | Read | Cable | Antenna | Preamp | A/Pos | T/Pos | Remark | Pol/Phase |
|---|---------|--------|--------|--------|-------|-------|---------|--------|-------|-------|---------|-----------|
| | MHz | dBuV/m | dBuV/m | dB | dBuV | Loss | Factor | Factor | cm | deg | | |
| 1 | 4903.44 | 35.98 | 54.00 | -18.02 | 27.90 | 7.86 | 33.29 | 33.07 | 121 | 181 | Average | VERTICAL |
| 2 | 4903.74 | 49.47 | 74.00 | -24.53 | 41.39 | 7.86 | 33.29 | 33.07 | 121 | 181 | Peak | VERTICAL |

Note:

The amplitude of spurious emissions that are attenuated by more than 20dB below the permissible value has no need to be reported.

Emission level (dBuV/m) = 20 log Emission level (uV/m).

Corrected Reading: Antenna Factor + Cable Loss + Read Level - Preamp Factor = Level.

| | | | |
|----------------------|--|-----------------------|--|
| Temperature | 25°C | Humidity | 55% |
| Test Engineer | Stim Sung | Configurations | IEEE 802.11ac MCS0/Nss1 VHT20 CH 1 / Chain 1 + Chain 2 + Chain 3 + Chain 4 |
| Test Date | Nov. 21, 2015 | | |
| Test Mode | Mode 5: EUT 1 + Set 7 Sector Antenna / 5 dBi | | |

Horizontal

| | Freq | Level | Limit Line | Over Limit | Read Level | Cable Loss | Antenna Factor | Preamp Factor | A/Pos | T/Pos | Remark | Pol/Phase |
|---|---------|--------|------------|------------|------------|------------|----------------|---------------|-------|-------|---------|------------|
| | MHz | dBuV/m | dBuV/m | dB | dBuV | dB | dB/m | dB | cm | deg | | |
| 1 | 4820.58 | 48.45 | 74.00 | -25.55 | 40.31 | 8.11 | 33.11 | 33.08 | 169 | 163 | Peak | HORIZONTAL |
| 2 | 4825.30 | 36.07 | 54.00 | -17.93 | 27.94 | 8.07 | 33.14 | 33.08 | 169 | 163 | Average | HORIZONTAL |

Vertical

| | Freq | Level | Limit Line | Over Limit | Read Level | Cable Loss | Antenna Factor | Preamp Factor | A/Pos | T/Pos | Remark | Pol/Phase |
|---|---------|--------|------------|------------|------------|------------|----------------|---------------|-------|-------|---------|-----------|
| | MHz | dBuV/m | dBuV/m | dB | dBuV | dB | dB/m | dB | cm | deg | | |
| 1 | 4819.46 | 49.09 | 74.00 | -24.91 | 40.95 | 8.11 | 33.11 | 33.08 | 197 | 167 | Peak | VERTICAL |
| 2 | 4827.04 | 36.00 | 54.00 | -18.00 | 27.87 | 8.07 | 33.14 | 33.08 | 197 | 167 | Average | VERTICAL |

| | | | |
|----------------------|--|-----------------------|--|
| Temperature | 25°C | Humidity | 55% |
| Test Engineer | Stim Sung | Configurations | IEEE 802.11ac MCS0/Nss1 VHT20 CH 6 / Chain 1 + Chain 2 + Chain 3 + Chain 4 |
| Test Date | Nov. 21, 2015 | | |
| Test Mode | Mode 5: EUT 1 + Set 7 Sector Antenna / 5 dBi | | |

Horizontal

| | Freq | Level | Limit | Over | Read | Cable | Antenna | Preamp | A/Pos | T/Pos | Remark | Pol/Phase |
|---|---------|--------|--------|--------|-------|-------|---------|--------|-------|-------|---------|------------|
| | MHz | dBuV/m | dBuV/m | dB | dBuV | Loss | Factor | Factor | cm | deg | | |
| 1 | 4874.08 | 48.85 | 74.00 | -25.15 | 40.76 | 7.94 | 33.23 | 33.08 | 181 | 132 | Peak | HORIZONTAL |
| 2 | 4876.78 | 35.80 | 54.00 | -18.20 | 27.71 | 7.94 | 33.23 | 33.08 | 181 | 132 | Average | HORIZONTAL |

Vertical

| | Freq | Level | Limit | Over | Read | Cable | Antenna | Preamp | A/Pos | T/Pos | Remark | Pol/Phase |
|---|---------|--------|--------|--------|-------|-------|---------|--------|-------|-------|---------|-----------|
| | MHz | dBuV/m | dBuV/m | dB | dBuV | Loss | Factor | Factor | cm | deg | | |
| 1 | 4873.18 | 49.32 | 74.00 | -24.68 | 41.23 | 7.94 | 33.23 | 33.08 | 144 | 86 | Peak | VERTICAL |
| 2 | 4876.38 | 35.78 | 54.00 | -18.22 | 27.69 | 7.94 | 33.23 | 33.08 | 144 | 86 | Average | VERTICAL |

| | | | |
|----------------------|--|-----------------------|---|
| Temperature | 25°C | Humidity | 55% |
| Test Engineer | Stim Sung | Configurations | IEEE 802.11ac MCS0/Nss1 VHT20 CH 11 / Chain 1 + Chain 2 + Chain 3 + Chain 4 |
| Test Date | Nov. 21, 2015 | | |
| Test Mode | Mode 5: EUT 1 + Set 7 Sector Antenna / 5 dBi | | |

Horizontal

| | Freq | Level | Limit | Over | Read | CableAntenna | Preamp | A/Pos | T/Pos | Remark | Pol/Phase | |
|---|---------|--------|--------|--------|-------|--------------|--------|-------|-------|--------|-----------|------------|
| | MHz | dBuV/m | dBuV/m | dB | dBuV | Loss | Factor | dB | cm | deg | | |
| 1 | 4919.54 | 36.02 | 54.00 | -17.98 | 27.95 | 7.82 | 33.32 | 33.07 | 163 | 110 | Average | HORIZONTAL |
| 2 | 4920.96 | 49.12 | 74.00 | -24.88 | 41.05 | 7.82 | 33.32 | 33.07 | 163 | 110 | Peak | HORIZONTAL |

Vertical

| | Freq | Level | Limit | Over | Read | CableAntenna | Preamp | A/Pos | T/Pos | Remark | Pol/Phase | |
|---|---------|--------|--------|--------|-------|--------------|--------|-------|-------|--------|-----------|----------|
| | MHz | dBuV/m | dBuV/m | dB | dBuV | Loss | Factor | dB | cm | deg | | |
| 1 | 4922.94 | 35.04 | 54.00 | -18.96 | 26.97 | 7.82 | 33.32 | 33.07 | 139 | 97 | Average | VERTICAL |
| 2 | 4927.90 | 49.93 | 74.00 | -24.07 | 41.86 | 7.78 | 33.35 | 33.06 | 139 | 97 | Peak | VERTICAL |

| | | | |
|----------------------|--|-----------------------|--|
| Temperature | 25°C | Humidity | 55% |
| Test Engineer | Stim Sung | Configurations | IEEE 802.11ac MCS0/Nss1 VHT40 CH 3 / Chain 1 + Chain 2 + Chain 3 + Chain 4 |
| Test Date | Nov. 21, 2015 | | |
| Test Mode | Mode 5: EUT 1 + Set 7 Sector Antenna / 5 dBi | | |

Horizontal

| | Freq | Level | Limit | Over | Read | CableAntenna | Preamp | A/Pos | T/Pos | Remark | Pol/Phase | |
|---|---------|--------|--------|--------|-------|--------------|--------|-------|-------|--------|-----------|------------|
| | MHz | dBuV/m | dBuV/m | dB | dBuV | dB | dB/m | dB | cm | deg | | |
| 1 | 4839.08 | 36.21 | 54.00 | -17.79 | 28.09 | 8.03 | 33.17 | 33.08 | 158 | 113 | Average | HORIZONTAL |
| 2 | 4839.84 | 49.26 | 74.00 | -24.74 | 41.14 | 8.03 | 33.17 | 33.08 | 158 | 113 | Peak | HORIZONTAL |

Vertical

| | Freq | Level | Limit | Over | Read | CableAntenna | Preamp | A/Pos | T/Pos | Remark | Pol/Phase | |
|---|---------|--------|--------|--------|-------|--------------|--------|-------|-------|--------|-----------|----------|
| | MHz | dBuV/m | dBuV/m | dB | dBuV | dB | dB/m | dB | cm | deg | | |
| 1 | 4839.28 | 36.02 | 54.00 | -17.98 | 27.90 | 8.03 | 33.17 | 33.08 | 150 | 100 | Average | VERTICAL |
| 2 | 4841.54 | 48.48 | 74.00 | -25.52 | 40.36 | 8.03 | 33.17 | 33.08 | 150 | 100 | Peak | VERTICAL |

| | | | |
|----------------------|--|-----------------------|--|
| Temperature | 25°C | Humidity | 55% |
| Test Engineer | Stim Sung | Configurations | IEEE 802.11ac MCS0/Nss1 VHT40 CH 6 / Chain 1 + Chain 2 + Chain 3 + Chain 4 |
| Test Date | Nov. 21, 2015 | | |
| Test Mode | Mode 5: EUT 1 + Set 7 Sector Antenna / 5 dBi | | |

Horizontal

| | Freq | Level | Limit | Over | Read | Cable | Antenna | Preamp | A/Pos | T/Pos | Remark | Pol/Phase |
|---|---------|--------|--------|--------|-------|-------|---------|--------|-------|-------|---------|------------|
| | MHz | dBuV/m | dBuV/m | dB | dBuV | Loss | Factor | Factor | cm | deg | | |
| 1 | 4871.80 | 49.25 | 74.00 | -24.75 | 41.16 | 7.94 | 33.23 | 33.08 | 178 | 52 | Peak | HORIZONTAL |
| 2 | 4874.26 | 35.89 | 54.00 | -18.11 | 27.80 | 7.94 | 33.23 | 33.08 | 178 | 52 | Average | HORIZONTAL |

Vertical

| | Freq | Level | Limit | Over | Read | Cable | Antenna | Preamp | A/Pos | T/Pos | Remark | Pol/Phase |
|---|---------|--------|--------|--------|-------|-------|---------|--------|-------|-------|---------|-----------|
| | MHz | dBuV/m | dBuV/m | dB | dBuV | Loss | Factor | Factor | cm | deg | | |
| 1 | 4870.84 | 35.78 | 54.00 | -18.22 | 27.69 | 7.94 | 33.23 | 33.08 | 144 | 75 | Average | VERTICAL |
| 2 | 4876.16 | 48.74 | 74.00 | -25.26 | 40.65 | 7.94 | 33.23 | 33.08 | 144 | 75 | Peak | VERTICAL |

| | | | |
|----------------------|--|-----------------------|--|
| Temperature | 25°C | Humidity | 55% |
| Test Engineer | Stim Sung | Configurations | IEEE 802.11ac MCS0/Nss1 VHT40 CH 9 / Chain 1 + Chain 2 + Chain 3 + Chain 4 |
| Test Date | Nov. 21, 2015 | | |
| Test Mode | Mode 5: EUT 1 + Set 7 Sector Antenna / 5 dBi | | |

Horizontal

| | Freq | Level | Limit | Over | Read | Cable | Antenna | Preamp | A/Pos | T/Pos | Remark | Pol/Phase |
|---|---------|--------|--------|--------|-------|-------|---------|--------|-------|-------|---------|------------|
| | MHz | dBuV/m | dBuV/m | dB | dBuV | dB | dB/m | dB | cm | deg | | |
| 1 | 4905.36 | 49.53 | 74.00 | -24.47 | 41.45 | 7.86 | 33.29 | 33.07 | 184 | 42 | Peak | HORIZONTAL |
| 2 | 4906.68 | 36.03 | 54.00 | -17.97 | 27.95 | 7.86 | 33.29 | 33.07 | 184 | 42 | Average | HORIZONTAL |

Vertical

| | Freq | Level | Limit | Over | Read | Cable | Antenna | Preamp | A/Pos | T/Pos | Remark | Pol/Phase |
|---|---------|--------|--------|--------|-------|-------|---------|--------|-------|-------|---------|-----------|
| | MHz | dBuV/m | dBuV/m | dB | dBuV | dB | dB/m | dB | cm | deg | | |
| 1 | 4899.94 | 49.39 | 74.00 | -24.61 | 41.31 | 7.86 | 33.29 | 33.07 | 161 | 32 | Peak | VERTICAL |
| 2 | 4904.82 | 36.09 | 54.00 | -17.91 | 28.01 | 7.86 | 33.29 | 33.07 | 161 | 32 | Average | VERTICAL |

Note:

The amplitude of spurious emissions that are attenuated by more than 20dB below the permissible value has no need to be reported.

Emission level (dBuV/m) = 20 log Emission level (uV/m).

Corrected Reading: Antenna Factor + Cable Loss + Read Level - Preamp Factor = Level.

| | | | |
|----------------------|---|-----------------------|--|
| Temperature | 25°C | Humidity | 55% |
| Test Engineer | Stim Sung | Configurations | IEEE 802.11ac MCS0/Nss1 VHT20 CH 1 / Chain 1 + Chain 2 + Chain 3 + Chain 4 |
| Test Date | Nov. 21, 2015 | | |
| Test Mode | Mode 6: EUT 1 + Set 8 Dipole Antenna / 4.66 dBi | | |

Horizontal

| | Freq | Level | Limit | Over | Read | CableAntenna | Preamp | A/Pos | T/Pos | Remark | Pol/Phase | |
|---|---------|--------|--------|--------|-------|--------------|--------|-------|-------|--------|-----------|------------|
| | MHz | dBuV/m | dBuV/m | dB | dBuV | dB | dB/m | dB | cm | deg | | |
| 1 | 4819.50 | 35.79 | 54.00 | -18.21 | 27.65 | 8.11 | 33.11 | 33.08 | 161 | 167 | Average | HORIZONTAL |
| 2 | 4820.06 | 48.59 | 74.00 | -25.41 | 40.45 | 8.11 | 33.11 | 33.08 | 161 | 167 | Peak | HORIZONTAL |

Vertical

| | Freq | Level | Limit | Over | Read | CableAntenna | Preamp | A/Pos | T/Pos | Remark | Pol/Phase | |
|---|---------|--------|--------|--------|-------|--------------|--------|-------|-------|--------|-----------|----------|
| | MHz | dBuV/m | dBuV/m | dB | dBuV | dB | dB/m | dB | cm | deg | | |
| 1 | 4823.06 | 49.53 | 74.00 | -24.47 | 41.39 | 8.11 | 33.11 | 33.08 | 167 | 162 | Peak | VERTICAL |
| 2 | 4825.46 | 35.88 | 54.00 | -18.12 | 27.75 | 8.07 | 33.14 | 33.08 | 167 | 162 | Average | VERTICAL |

| | | | |
|----------------------|---|-----------------------|--|
| Temperature | 25°C | Humidity | 55% |
| Test Engineer | Stim Sung | Configurations | IEEE 802.11ac MCS0/Nss1 VHT20 CH 6 / Chain 1 + Chain 2 + Chain 3 + Chain 4 |
| Test Date | Nov. 21, 2015 | | |
| Test Mode | Mode 6: EUT 1 + Set 8 Dipole Antenna / 4.66 dBi | | |

Horizontal

| | Freq | Level | Limit | Over | Read | Cable | Antenna | Preamp | A/Pos | T/Pos | Remark | Pol/Phase |
|---|---------|--------|--------|--------|-------|-------|---------|--------|-------|-------|---------|------------|
| | MHz | dBuV/m | dBuV/m | dB | dBuV | Loss | Factor | Factor | cm | deg | | |
| 1 | 4871.10 | 35.57 | 54.00 | -18.43 | 27.48 | 7.94 | 33.23 | 33.08 | 154 | 159 | Average | HORIZONTAL |
| 2 | 4877.58 | 48.20 | 74.00 | -25.80 | 40.10 | 7.94 | 33.23 | 33.07 | 154 | 159 | Peak | HORIZONTAL |

Vertical

| | Freq | Level | Limit | Over | Read | Cable | Antenna | Preamp | A/Pos | T/Pos | Remark | Pol/Phase |
|---|---------|--------|--------|--------|-------|-------|---------|--------|-------|-------|---------|-----------|
| | MHz | dBuV/m | dBuV/m | dB | dBuV | Loss | Factor | Factor | cm | deg | | |
| 1 | 4871.40 | 48.65 | 74.00 | -25.35 | 40.56 | 7.94 | 33.23 | 33.08 | 162 | 182 | Peak | VERTICAL |
| 2 | 4871.50 | 35.69 | 54.00 | -18.31 | 27.60 | 7.94 | 33.23 | 33.08 | 162 | 182 | Average | VERTICAL |

| | | | |
|----------------------|---|-----------------------|---|
| Temperature | 25°C | Humidity | 55% |
| Test Engineer | Stim Sung | Configurations | IEEE 802.11ac MCS0/Nss1 VHT20 CH 11 / Chain 1 + Chain 2 + Chain 3 + Chain 4 |
| Test Date | Nov. 21, 2015 | | |
| Test Mode | Mode 6: EUT 1 + Set 8 Dipole Antenna / 4.66 dBi | | |

Horizontal

| | Freq | Level | Limit | Over | Read | Cable | Antenna | Preamp | A/Pos | T/Pos | Remark | Pol/Phase |
|---|---------|--------|--------|--------|-------|-------|---------|--------|-------|-------|---------|------------|
| | MHz | dBuV/m | dBuV/m | dB | dBuV | dB | dB/m | dB | cm | deg | | |
| 1 | 4919.14 | 49.27 | 74.00 | -24.73 | 41.20 | 7.82 | 33.32 | 33.07 | 176 | 151 | Peak | HORIZONTAL |
| 2 | 4924.02 | 35.90 | 54.00 | -18.10 | 27.84 | 7.78 | 33.35 | 33.07 | 176 | 151 | Average | HORIZONTAL |

Vertical

| | Freq | Level | Limit | Over | Read | Cable | Antenna | Preamp | A/Pos | T/Pos | Remark | Pol/Phase |
|---|---------|--------|--------|--------|-------|-------|---------|--------|-------|-------|---------|-----------|
| | MHz | dBuV/m | dBuV/m | dB | dBuV | dB | dB/m | dB | cm | deg | | |
| 1 | 4921.90 | 48.47 | 74.00 | -25.53 | 40.40 | 7.82 | 33.32 | 33.07 | 171 | 176 | Peak | VERTICAL |
| 2 | 4922.84 | 35.73 | 54.00 | -18.27 | 27.66 | 7.82 | 33.32 | 33.07 | 171 | 176 | Average | VERTICAL |

| | | | |
|----------------------|---|-----------------------|--|
| Temperature | 25°C | Humidity | 55% |
| Test Engineer | Stim Sung | Configurations | IEEE 802.11ac MCS0/Nss1 VHT40 CH 3 / Chain 1 + Chain 2 + Chain 3 + Chain 4 |
| Test Date | Nov. 21, 2015 | | |
| Test Mode | Mode 6: EUT 1 + Set 8 Dipole Antenna / 4.66 dBi | | |

Horizontal

| | Freq | Level | Limit | Over | Read | Cable | Antenna | Preamp | A/Pos | T/Pos | Remark | Pol/Phase |
|---|---------|--------|--------|--------|-------|-------|---------|--------|-------|-------|---------|------------|
| | MHz | dBuV/m | dBuV/m | dB | dBuV | Loss | Factor | Factor | cm | deg | | |
| 1 | 4839.60 | 35.95 | 54.00 | -18.05 | 27.83 | 8.03 | 33.17 | 33.08 | 168 | 160 | Average | HORIZONTAL |
| 2 | 4840.18 | 48.76 | 74.00 | -25.24 | 40.64 | 8.03 | 33.17 | 33.08 | 168 | 160 | Peak | HORIZONTAL |

Vertical

| | Freq | Level | Limit | Over | Read | Cable | Antenna | Preamp | A/Pos | T/Pos | Remark | Pol/Phase |
|---|---------|--------|--------|--------|-------|-------|---------|--------|-------|-------|---------|-----------|
| | MHz | dBuV/m | dBuV/m | dB | dBuV | Loss | Factor | Factor | cm | deg | | |
| 1 | 4839.26 | 35.87 | 54.00 | -18.13 | 27.75 | 8.03 | 33.17 | 33.08 | 180 | 141 | Average | VERTICAL |
| 2 | 4844.56 | 49.00 | 74.00 | -25.00 | 40.88 | 8.03 | 33.17 | 33.08 | 180 | 141 | Peak | VERTICAL |

| | | | |
|----------------------|---|-----------------------|--|
| Temperature | 25°C | Humidity | 55% |
| Test Engineer | Stim Sung | Configurations | IEEE 802.11ac MCS0/Nss1 VHT40 CH 6 / Chain 1 + Chain 2 + Chain 3 + Chain 4 |
| Test Date | Nov. 21, 2015 | | |
| Test Mode | Mode 6: EUT 1 + Set 8 Dipole Antenna / 4.66 dBi | | |

Horizontal

| | Freq | Level | Limit | Over | Read | Cable | Antenna | Preamp | A/Pos | T/Pos | Remark | Pol/Phase |
|---|---------|--------|--------|--------|-------|-------|---------|--------|-------|-------|---------|------------|
| | MHz | dBuV/m | dBuV/m | dB | dBuV | dB | dB/m | dB | cm | deg | | |
| 1 | 4870.84 | 48.47 | 74.00 | -25.53 | 40.38 | 7.94 | 33.23 | 33.08 | 167 | 132 | Peak | HORIZONTAL |
| 2 | 4873.78 | 35.77 | 54.00 | -18.23 | 27.68 | 7.94 | 33.23 | 33.08 | 167 | 132 | Average | HORIZONTAL |

Vertical

| | Freq | Level | Limit | Over | Read | Cable | Antenna | Preamp | A/Pos | T/Pos | Remark | Pol/Phase |
|---|---------|--------|--------|--------|-------|-------|---------|--------|-------|-------|---------|-----------|
| | MHz | dBuV/m | dBuV/m | dB | dBuV | dB | dB/m | dB | cm | deg | | |
| 1 | 4874.84 | 48.89 | 74.00 | -25.11 | 40.80 | 7.94 | 33.23 | 33.08 | 174 | 130 | Peak | VERTICAL |
| 2 | 4876.66 | 35.58 | 54.00 | -18.42 | 27.49 | 7.94 | 33.23 | 33.08 | 174 | 130 | Average | VERTICAL |

| | | | |
|----------------------|---|-----------------------|--|
| Temperature | 25°C | Humidity | 55% |
| Test Engineer | Stim Sung | Configurations | IEEE 802.11ac MCS0/Nss1 VHT40 CH 9 / Chain 1 + Chain 2 + Chain 3 + Chain 4 |
| Test Date | Nov. 21, 2015 | | |
| Test Mode | Mode 6: EUT 1 + Set 8 Dipole Antenna / 4.66 dBi | | |

Horizontal

| | Freq | Level | Limit | Over | Read | Cable | Antenna | Preamp | A/Pos | T/Pos | Remark | Pol/Phase |
|---|---------|--------|--------|--------|-------|-------|---------|--------|-------|-------|---------|------------|
| | MHz | dBuV/m | dBuV/m | dB | dBuV | dB | dB/m | dB | cm | deg | | |
| 1 | 4900.56 | 35.76 | 54.00 | -18.24 | 27.68 | 7.86 | 33.29 | 33.07 | 173 | 124 | Average | HORIZONTAL |
| 2 | 4907.24 | 48.87 | 74.00 | -25.13 | 40.79 | 7.86 | 33.29 | 33.07 | 173 | 124 | Peak | HORIZONTAL |

Vertical

| | Freq | Level | Limit | Over | Read | Cable | Antenna | Preamp | A/Pos | T/Pos | Remark | Pol/Phase |
|---|---------|--------|--------|--------|-------|-------|---------|--------|-------|-------|---------|-----------|
| | MHz | dBuV/m | dBuV/m | dB | dBuV | dB | dB/m | dB | cm | deg | | |
| 1 | 4906.00 | 48.64 | 74.00 | -25.36 | 40.56 | 7.86 | 33.29 | 33.07 | 135 | 88 | Peak | VERTICAL |
| 2 | 4908.28 | 35.83 | 54.00 | -18.17 | 27.75 | 7.86 | 33.29 | 33.07 | 135 | 88 | Average | VERTICAL |

Note:

The amplitude of spurious emissions that are attenuated by more than 20dB below the permissible value has no need to be reported.

Emission level (dBuV/m) = 20 log Emission level (uV/m).

Corrected Reading: Antenna Factor + Cable Loss + Read Level - Preamp Factor = Level.

| | | | |
|----------------------|--|-----------------------|--|
| Temperature | 25°C | Humidity | 55% |
| Test Engineer | Stim Sung | Configurations | IEEE 802.11ac MCS0/Nss1 VHT20 CH 1 / Chain 1 + Chain 2 + Chain 3 + Chain 4 |
| Test Date | Nov. 19, 2015 | | |
| Test Mode | Mode 7: EUT 2 + Set 10 PIFA Antenna / Chain1:3.81 dBi, Chain2:3.75 dBi, Chain3:3.98 dBi, Chain4:3.47 dBi | | |

Horizontal

| | Freq | Level | Limit | Over | Read | CableAntenna | Preamp | A/Pos | T/Pos | Remark | Pol/Phase | |
|---|---------|--------|--------|--------|-------|--------------|--------|-------|-------|--------|-----------|------------|
| | MHz | dBuV/m | dBuV/m | dB | dBuV | dB | dB/m | dB | cm | deg | | |
| 1 | 4823.99 | 36.00 | 54.00 | -18.00 | 27.86 | 8.11 | 33.11 | 33.08 | 156 | 278 | Average | HORIZONTAL |
| 2 | 4824.79 | 48.53 | 74.00 | -25.47 | 40.39 | 8.11 | 33.11 | 33.08 | 156 | 278 | Peak | HORIZONTAL |

Vertical

| | Freq | Level | Limit | Over | Read | CableAntenna | Preamp | A/Pos | T/Pos | Remark | Pol/Phase | |
|---|---------|--------|--------|--------|-------|--------------|--------|-------|-------|--------|-----------|----------|
| | MHz | dBuV/m | dBuV/m | dB | dBuV | dB | dB/m | dB | cm | deg | | |
| 1 | 4823.22 | 35.32 | 54.00 | -18.68 | 27.18 | 8.11 | 33.11 | 33.08 | 153 | 270 | Average | VERTICAL |
| 2 | 4824.91 | 48.18 | 74.00 | -25.82 | 40.04 | 8.11 | 33.11 | 33.08 | 153 | 270 | Peak | VERTICAL |

| | | | |
|----------------------|---|-----------------------|--|
| Temperature | 25°C | Humidity | 55% |
| Test Engineer | Stim Sung | Configurations | IEEE 802.11ac MCS0/Nss1 VHT20 CH 6 / Chain 1 + Chain 2 + Chain 3 + Chain 4 |
| Test Date | Nov. 19, 2015 | | |
| Test Mode | Mode 7: EUT 2 + Set 10 PIFA Antenna / Chain1:3.81 dBi, Chain2:3.75 dBi, Chain3:3.98 dBi, Chain4:3.47 dBi | | |

Horizontal

| | Freq | Level | Limit | Over | Read | CableAntenna | Preamp | A/Pos | T/Pos | Remark | Pol/Phase | |
|---|---------|--------|--------|--------|-------|--------------|--------|-------|-------|--------|-----------|------------|
| | MHz | dBuV/m | dBuV/m | dB | dBuV | dB | dB/m | dB | cm | deg | | |
| 1 | 4874.17 | 35.38 | 54.00 | -18.62 | 27.29 | 7.94 | 33.23 | 33.08 | 151 | 265 | Average | HORIZONTAL |
| 2 | 4874.59 | 48.06 | 74.00 | -25.94 | 39.97 | 7.94 | 33.23 | 33.08 | 151 | 265 | Peak | HORIZONTAL |

Vertical

| | Freq | Level | Limit | Over | Read | CableAntenna | Preamp | A/Pos | T/Pos | Remark | Pol/Phase | |
|---|---------|--------|--------|--------|-------|--------------|--------|-------|-------|--------|-----------|----------|
| | MHz | dBuV/m | dBuV/m | dB | dBuV | dB | dB/m | dB | cm | deg | | |
| 1 | 4873.20 | 47.97 | 74.00 | -26.03 | 39.88 | 7.94 | 33.23 | 33.08 | 148 | 255 | Peak | VERTICAL |
| 2 | 4874.69 | 35.29 | 54.00 | -18.71 | 27.20 | 7.94 | 33.23 | 33.08 | 148 | 255 | Average | VERTICAL |

| | | | |
|----------------------|---|-----------------------|---|
| Temperature | 25°C | Humidity | 55% |
| Test Engineer | Stim Sung | Configurations | IEEE 802.11ac MCS0/Nss1 VHT20 CH 11 / Chain 1 + Chain 2 + Chain 3 + Chain 4 |
| Test Date | Nov. 19, 2015 | | |
| Test Mode | Mode 7: EUT 2 + Set 10 PIFA Antenna / Chain1:3.81 dBi, Chain2:3.75 dBi, Chain3:3.98 dBi, Chain4:3.47 dBi | | |

Horizontal

| | Freq | Level | Limit | Over | Read | CableAntenna | Preamp | A/Pos | T/Pos | Remark | Pol/Phase | |
|---|---------|--------|--------|--------|-------|--------------|--------|-------|-------|--------|-----------|------------|
| | MHz | dBuV/m | dBuV/m | dB | dBuV | dB | dB/m | dB | cm | deg | | |
| 1 | 4924.39 | 35.72 | 54.00 | -18.28 | 27.66 | 7.78 | 33.35 | 33.07 | 144 | 242 | Average | HORIZONTAL |
| 2 | 4924.99 | 48.54 | 74.00 | -25.46 | 40.48 | 7.78 | 33.35 | 33.07 | 144 | 242 | Peak | HORIZONTAL |

Vertical

| | Freq | Level | Limit | Over | Read | CableAntenna | Preamp | A/Pos | T/Pos | Remark | Pol/Phase | |
|---|---------|--------|--------|--------|-------|--------------|--------|-------|-------|--------|-----------|----------|
| | MHz | dBuV/m | dBuV/m | dB | dBuV | dB | dB/m | dB | cm | deg | | |
| 1 | 4924.66 | 48.82 | 74.00 | -25.18 | 40.76 | 7.78 | 33.35 | 33.07 | 142 | 237 | Peak | VERTICAL |
| 2 | 4924.78 | 35.50 | 54.00 | -18.50 | 27.44 | 7.78 | 33.35 | 33.07 | 142 | 237 | Average | VERTICAL |

| | | | |
|----------------------|--|-----------------------|--|
| Temperature | 25°C | Humidity | 55% |
| Test Engineer | Stim Sung | Configurations | IEEE 802.11ac MCS0/Nss1 VHT40 CH 3 / Chain 1 + Chain 2 + Chain 3 + Chain 4 |
| Test Date | Nov. 19, 2015 | | |
| Test Mode | Mode 7: EUT 2 + Set 10 PIFA Antenna / Chain1:3.81 dBi, Chain2:3.75 dBi, Chain3:3.98 dBi, Chain4:3.47 dBi | | |

Horizontal

| | Freq | Level | Limit | Over | Read | CableAntenna | Preamp | A/Pos | T/Pos | Remark | Pol/Phase | |
|---|---------|--------|--------|--------|-------|--------------|--------|-------|-------|--------|-----------|------------|
| | MHz | dBuV/m | dBuV/m | dB | dBuV | dB | dB/m | dB | cm | deg | | |
| 1 | 4843.80 | 35.19 | 54.00 | -18.81 | 27.07 | 8.03 | 33.17 | 33.08 | 139 | 228 | Average | HORIZONTAL |
| 2 | 4844.32 | 48.16 | 74.00 | -25.84 | 40.04 | 8.03 | 33.17 | 33.08 | 139 | 228 | Peak | HORIZONTAL |

Vertical

| | Freq | Level | Limit | Over | Read | CableAntenna | Preamp | A/Pos | T/Pos | Remark | Pol/Phase | |
|---|---------|--------|--------|--------|-------|--------------|--------|-------|-------|--------|-----------|----------|
| | MHz | dBuV/m | dBuV/m | dB | dBuV | dB | dB/m | dB | cm | deg | | |
| 1 | 4843.53 | 48.35 | 74.00 | -25.65 | 40.23 | 8.03 | 33.17 | 33.08 | 144 | 221 | Peak | VERTICAL |
| 2 | 4844.55 | 35.07 | 54.00 | -18.93 | 26.95 | 8.03 | 33.17 | 33.08 | 144 | 221 | Average | VERTICAL |

| | | | |
|----------------------|---|-----------------------|--|
| Temperature | 25°C | Humidity | 55% |
| Test Engineer | Stim Sung | Configurations | IEEE 802.11ac MCS0/Nss1 VHT40 CH 6 / Chain 1 + Chain 2 + Chain 3 + Chain 4 |
| Test Date | Nov. 19, 2015 | | |
| Test Mode | Mode 7: EUT 2 + Set 10 PIFA Antenna / Chain1:3.81 dBi, Chain2:3.75 dBi, Chain3:3.98 dBi, Chain4:3.47 dBi | | |

Horizontal

| | Freq | Level | Limit Line | Over Limit | Read Level | Cable Loss | Antenna Factor | Preamp Factor | A/Pos | T/Pos | Remark | Pol/Phase |
|---|---------|--------|------------|------------|------------|------------|----------------|---------------|-------|-------|---------|------------|
| | MHz | dBuV/m | dBuV/m | dB | dBuV | dB | dB/m | dB | cm | deg | | |
| 1 | 4873.53 | 48.31 | 74.00 | -25.69 | 40.22 | 7.94 | 33.23 | 33.08 | 146 | 228 | Peak | HORIZONTAL |
| 2 | 4874.36 | 35.50 | 54.00 | -18.50 | 27.41 | 7.94 | 33.23 | 33.08 | 146 | 228 | Average | HORIZONTAL |

Vertical

| | Freq | Level | Limit Line | Over Limit | Read Level | Cable Loss | Antenna Factor | Preamp Factor | A/Pos | T/Pos | Remark | Pol/Phase |
|---|---------|--------|------------|------------|------------|------------|----------------|---------------|-------|-------|---------|-----------|
| | MHz | dBuV/m | dBuV/m | dB | dBuV | dB | dB/m | dB | cm | deg | | |
| 1 | 4873.67 | 35.23 | 54.00 | -18.77 | 27.14 | 7.94 | 33.23 | 33.08 | 141 | 210 | Average | VERTICAL |
| 2 | 4874.66 | 48.33 | 74.00 | -25.67 | 40.24 | 7.94 | 33.23 | 33.08 | 141 | 210 | Peak | VERTICAL |

| | | | |
|----------------------|---|-----------------------|--|
| Temperature | 25°C | Humidity | 55% |
| Test Engineer | Stim Sung | Configurations | IEEE 802.11ac MCS0/Nss1 VHT40 CH 9 / Chain 1 + Chain 2 + Chain 3 + Chain 4 |
| Test Date | Nov. 19, 2015 | | |
| Test Mode | Mode 7: EUT 2 + Set 10 PIFA Antenna / Chain1:3.81 dBi, Chain2:3.75 dBi, Chain3:3.98 dBi, Chain4:3.47 dBi | | |

Horizontal

| | Freq | Level | Limit Line | Over Limit | Read Level | CableAntenna Loss | Antenna Factor | Preamp Factor | A/Pos | T/Pos | Remark | Pol/Phase |
|---|---------|--------|------------|------------|------------|-------------------|----------------|---------------|-------|-------|---------|------------|
| | MHz | dBuV/m | dBuV/m | dB | dBuV | dB | dB/m | dB | cm | deg | | |
| 1 | 4903.72 | 48.64 | 74.00 | -25.36 | 40.56 | 7.86 | 33.29 | 33.07 | 139 | 202 | Peak | HORIZONTAL |
| 2 | 4904.02 | 35.48 | 54.00 | -18.52 | 27.40 | 7.86 | 33.29 | 33.07 | 139 | 202 | Average | HORIZONTAL |

Vertical

| | Freq | Level | Limit Line | Over Limit | Read Level | CableAntenna Loss | Antenna Factor | Preamp Factor | A/Pos | T/Pos | Remark | Pol/Phase |
|---|---------|--------|------------|------------|------------|-------------------|----------------|---------------|-------|-------|---------|-----------|
| | MHz | dBuV/m | dBuV/m | dB | dBuV | dB | dB/m | dB | cm | deg | | |
| 1 | 4903.56 | 48.51 | 74.00 | -25.49 | 40.43 | 7.86 | 33.29 | 33.07 | 137 | 199 | Peak | VERTICAL |
| 2 | 4904.78 | 35.41 | 54.00 | -18.59 | 27.33 | 7.86 | 33.29 | 33.07 | 137 | 199 | Average | VERTICAL |

Note:

The amplitude of spurious emissions that are attenuated by more than 20dB below the permissible value has no need to be reported.

Emission level (dBuV/m) = 20 log Emission level (uV/m).

Corrected Reading: Antenna Factor + Cable Loss + Read Level - Preamp Factor = Level.