



FCC TEST REPORT

REPORT NO.: RF110920E08

MODEL NO.: TG790 (DSL MBA790AA)

FCC ID: RSE-TG790

RECEIVED: Sep. 06, 2011

TESTED: Sep. 06 to 28, 2011

ISSUED: Oct. 12, 2011

APPLICANT: Thomson Telecom Belgium

ADDRESS: Prins Boudewijnlaan 47 B-2650 Edegem Belgium

ISSUED BY: Bureau Veritas Consumer Products Services (H.K.)
Ltd., Taoyuan Branch Hsin Chu Laboratory

LAB ADDRESS : No. 81-1, Lu Liao Keng, 9th Ling, Wu Lung Tsuen,
Chiung Lin Hsiang, Hsin Chu Hsien 307, Taiwan

TEST LOCATION (1): No. 81-1, Lu Liao Keng, 9th Ling, Wu Lung Tsuen,
Chiung Lin Hsiang, Hsin Chu Hsien 307, Taiwan

TEST LOCATION (2): No. 49, Ln. 206, Wende Rd., Shangshan Tsuen, Chiung
Lin Hsiang, Hsin Chu Hsien 307, Taiwan

This test report consists of 147 pages in total. It may be duplicated completely for legal use with the approval of the applicant. It should not be reproduced except in full, without the written approval of our laboratory. The client should not use it to claim product certification, approval, or endorsement by TAF or any government agencies. The test results in the report only apply to the tested sample.





A D T

Table of Contents

RELEASE CONTROL RECORD	4
1. CERTIFICATION	5
2. SUMMARY OF TEST RESULTS	6
2.1 MEASUREMENT UNCERTAINTY	7
3. GENERAL INFORMATION	8
3.1 GENERAL DESCRIPTION OF EUT	8
3.2 DESCRIPTION OF TEST MODES	10
3.2.1 TEST MODE APPLICABILITY AND TESTED CHANNEL DETAIL	11
3.3 GENERAL DESCRIPTION OF APPLIED STANDARDS	15
3.4 DESCRIPTION OF SUPPORT UNITS.....	16
3.5 CONFIGURATION OF SYSTEM UNDER TEST	17
4. TEST TYPES AND RESULTS	18
4.1 CONDUCTED EMISSION MEASUREMENT	18
4.1.1 LIMITS OF CONDUCTED EMISSION MEASUREMENT	18
4.1.2 TEST INSTRUMENTS.....	18
4.1.3 TEST PROCEDURES	19
4.1.4 DEVIATION FROM TEST STANDARD	19
4.1.5 TEST SETUP	20
4.1.6 EUT OPERATING CONDITIONS	20
4.1.7 TEST RESULTS	21
4.2 RADIATED EMISSION MEASUREMENT	23
4.2.1 LIMITS OF RADIATED EMISSION MEASUREMENT	23
4.2.2 TEST INSTRUMENTS.....	24
4.2.3 TEST PROCEDURES	25
4.2.4 DEVIATION FROM TEST STANDARD	25
4.2.5 TEST SETUP	26
4.2.6 EUT OPERATING CONDITIONS	26
4.2.7 TEST RESULTS	27
4.3 6dB BANDWIDTH MEASUREMENT	98
4.3.1 LIMITS OF 6dB BANDWIDTH MEASUREMENT	98
4.3.2 TEST INSTRUMENTS.....	98
4.3.3 TEST PROCEDURE.....	98
4.3.4 DEVIATION FROM TEST STANDARD	98
4.3.5 TEST SETUP	98
4.3.6 EUT OPERATING CONDITIONS	98
4.3.7 TEST RESULTS	99
4.4 MAXIMUM PEAK OUTPUT POWER.....	109
4.4.1 LIMITS OF MAXIMUM PEAK OUTPUT POWER MEASUREMENT	109
4.4.2 INSTRUMENTS.....	109
4.4.3 TEST PROCEDURES	109



A D T

4.4.4	DEVIATION FROM TEST STANDARD	109
4.4.5	TEST SETUP	109
4.4.6	EUT OPERATING CONDITIONS	109
4.4.7	TEST RESULTS	110
4.5	POWER SPECTRAL DENSITY MEASUREMENT	113
4.5.1	LIMITS OF POWER SPECTRAL DENSITY MEASUREMENT	113
4.5.2	TEST INSTRUMENTS.....	113
4.5.3	TEST PROCEDURE.....	113
4.5.4	DEVIATION FROM TEST STANDARD	113
4.5.5	TEST SETUP	113
4.5.6	EUT OPERATING CONDITION.....	114
4.5.7	TEST RESULTS	115
4.6	CONDUCTED OUT-BAND EMISSION MEASUREMENT	125
4.6.1	LIMITS OF CONDUCTED OUT-BAND EMISSION MEASUREMENT.....	125
4.6.2	TEST INSTRUMENTS.....	125
4.6.3	TEST PROCEDURE.....	125
4.6.4	DEVIATION FROM TEST STANDARD	125
4.6.5	EUT OPERATING CONDITION	125
4.6.6	TEST RESULTS	125
5.	INFORMATION ON THE TESTING LABORATORIES	146
6.	APPENDIX A - MODIFICATIONS RECORDERS FOR ENGINEERING CHANGES TO THE EUT BY THE LAB.....	147



A D T

RELEASE CONTROL RECORD

ISSUE NO.	REASON FOR CHANGE	DATE ISSUED
RF110920E08	Original release	Oct. 12, 2011



1. CERTIFICATION

PRODUCT: Home Service Gateway
BRAND NAME: THOMSON or Technicolor
MODEL NO.: TG790 (DSL MBA790AA)
TEST SAMPLE: PEM2
TESTED: Sep. 06 to 28, 2011
APPLICANT: Thomson Telecom Belgium
STANDARDS: FCC Part 15, Subpart C (Section 15.247)
ANSI C63.4-2003
ANSI C63.10-2009

The above equipment (Model: TG790 (DSL MBA790AA)) has been tested by **Bureau Veritas Consumer Products Services (H.K.) Ltd., Taoyuan Branch**, and found compliance with the requirement of the above standards. The test record, data evaluation & Equipment Under Test (EUT) configurations represented herein are true and accurate accounts of the measurements of the sample's EMC characteristics under the conditions specified in this report.

PREPARED BY :  , **DATE:** Oct. 12, 2011
(Lori Chung, Specialist)

APPROVED BY :  , **DATE:** Oct. 12, 2011
(May Chen, Deputy Manager)

2. SUMMARY OF TEST RESULTS

The EUT has been tested according to the following specifications:

APPLIED STANDARD: FCC Part 15, Subpart C			
Standard Section	Test Type and Limit	Result	Remark
15.207	AC Power Conducted Emission	PASS	Meet the requirement of limit. Minimum passing margin is -7.05dB at 0.416MHz
15.247(a)(2)	Spectrum Bandwidth of a Direct Sequence Spread Spectrum System Limit: min. 500kHz	PASS	Meet the requirement of limit.
15.247(b)	Maximum Peak Output Power Limit: max. 30dBm	PASS	Meet the requirement of limit.
15.247(d)	Radiated Emissions Limit: Table 15.209	PASS	Meet the requirement of limit. Minimum passing margin is -0.7dB at 2390.00MHz & 2483.50MHz.
15.247(e)	Power Spectral Density Limit: max. 8dBm	PASS	Meet the requirement of limit.
15.247(d)	Conducted Out-Band Emission Measurement Limit: 20dB less than the peak value of fundamental frequency	PASS	Meet the requirement of limit.
15.203	Antenna Requirement	PASS	No antenna connector is used.



A D T

2.1 MEASUREMENT UNCERTAINTY

Where relevant, the following measurement uncertainty levels have been estimated for tests performed on the EUT as specified in CISPR 16-4-2:

This uncertainty represents an expanded uncertainty expressed at approximately the 95% confidence level using a coverage factor of $k=2$.

Measurement	Value
Conducted emissions	2.45 dB
Radiated emissions (30MHz-1GHz)	2.19 dB
Radiated emissions (1GHz -18GHz)	2.56 dB



A D T

3. GENERAL INFORMATION

3.1 GENERAL DESCRIPTION OF EUT

PRODUCT	Home Service Gateway
MODEL NO.	TG790 (DSL MBA790AA)
FCC ID	RSE-TG790
POWER SUPPLY	DC 12V from power adapter
MODULATION TYPE	CCK, DQPSK, DBPSK for DSSS 64QAM, 16QAM, QPSK, BPSK for OFDM
MODULATION TECHNOLOGY	DSSS, OFDM
TRANSFER RATE	802.11b: up to 11Mbps 802.11g: up to 54Mbps 802.11n (20MHz, 800ns GI): up to 130Mbps 802.11n (40MHz, 800ns GI): up to 270Mbps
FREQUENCY OPERATING	2412MHz ~ 2462MHz
NUMBER OF CHANNEL	11 for 802.11b, 802.11g, 802.11n (20MHz) 7 for 802.11n (40MHz)
MAXIMUM OUTPUT POWER	802.11b: 660.7mW 802.11g: 794.3mW 802.11n (20MHz): 916.4mW 802.11n (40MHz): 968.4mW
ANTENNA TYPE	Please see NOTE
DATA CABLE	NA
I/O PORTS	LAN Port x 4 USB Host Port x 2 Phone Port x 1 WAN Port x 1 (MOCA, Coaxial type)
ASSOCIATED DEVICES	Adapter x 1

NOTE:

1. The EUT must be supplied with a power adapter as following table:

BRAND	Technicolor
PHIHONG MODEL	PSM24A-120(NY)
Technicolor P/N	DSL36900440
INPUT POWER	100-130Vac, 60Hz, 0.6A Max.
OUTPUT POWER	12Vdc, 2A.

2. There are two antennas provided to this EUT, please refer to the following table:

Transmitter Circuit	Gain (dBi)	Antenna Type	Connector Type	Diversity
Chain (0)	2.72	Ceramic	NA	Yes
Chain (1)	2.49	Ceramic	NA	Yes

3. The EUT is 2 * 2 spatial MIMO (2Tx & 2Rx) without beam forming function. The 11b/g legacy mode is limited to single transmitter only.
4. When the EUT operating in 802.11n, the software operation, which is defined by manufacturer, MCS (Modulation and Coding Schemes) from 0 to 15.
5. The above EUT information was declared by the manufacturer and for more detailed features description, please refer to the manufacturer's specifications or User's Manual.



A D T

3.2 DESCRIPTION OF TEST MODES

Eleven channels are provided for 802.11b, 802.11g, 802.11n (20MHz):

CHANNEL	FREQUENCY	CHANNEL	FREQUENCY
1	2412MHz	7	2442MHz
2	2417MHz	8	2447MHz
3	2422MHz	9	2452MHz
4	2427MHz	10	2457MHz
5	2432MHz	11	2462MHz
6	2437MHz		

Seven channels are provided for 802.11n (40MHz):

CHANNEL	FREQUENCY	CHANNEL	FREQUENCY
3	2422MHz	7	2442MHz
4	2427MHz	8	2447MHz
5	2432MHz	9	2452MHz
6	2437MHz		



A D T

3.2.1 TEST MODE APPLICABILITY AND TESTED CHANNEL DETAIL

EUT CONFIGURE MODE	APPLICABLE TO					DESCRIPTION
	PLC	RE < 1G	RE ≥ 1G	APCM	OB	
-	√	√	√	√	√	-

Where **PLC**: Power Line Conducted Emission **RE < 1G**: Radiated Emission below 1GHz
RE ≥ 1G: Radiated Emission above 1GHz **APCM**: Antenna Port Conducted Measurement
OB: Conducted Out-Band Emission Measurement

ANTENNA COMBINATION MODE:

COMBINATION MODE	OPERATION MODE	TX CHAIN(0)	TX CHAIN(1)
A	802.11 b	√	-
B	802.11 b	-	√
C	802.11 g	√	-
D	802.11 g	-	√
E	802.11n (20MHz)	√	-
F	802.11n (20MHz)	-	√
G	802.11n (20MHz)	√	√
H	802.11n (40MHz)	√	-
I	802.11n (40MHz)	-	√
J	802.11n (40MHz)	√	√

Note:

- The above information was declared by manufacturer and for more detailed features description, please refer to the manufacturer's specifications or user's manual.

POWER LINE CONDUCTED EMISSION TEST:

- Pre-Scan has been conducted to determine the worst-case mode from all possible combinations between available modulations, data rates and antenna ports (if EUT with antenna diversity architecture).
- Following channel(s) was (were) selected for the final test as listed below.

MODE	AVAILABLE CHANNEL	TESTED CHANNEL	MODULATION TECHNOLOGY	MODULATION TYPE	DATA RATE (Mbps)	COMBINATION MODE
802.11n (20MHz)	1 to 11	6	OFDM	BPSK	13	G



A D T

RADIATED EMISSION TEST (BELOW 1 GHz):

- Pre-Scan has been conducted to determine the worst-case mode from all possible combinations between available modulations, data rates and antenna ports (if EUT with antenna diversity architecture).
- Following channel(s) was (were) selected for the final test as listed below.

MODE	AVAILABLE CHANNEL	TESTED CHANNEL	MODULATION TECHNOLOGY	MODULATION TYPE	DATA RATE (Mbps)	COMBINATION MODE
802.11n (20MHz)	1 to 11	6	OFDM	BPSK	13	G

RADIATED EMISSION TEST (ABOVE 1 GHz):

- Pre-Scan has been conducted to determine the worst-case mode from all possible combinations between available modulations, data rates and antenna ports (if EUT with antenna diversity architecture).
- Following channel(s) was (were) selected for the final test as listed below.

MODE	AVAILABLE CHANNEL	TESTED CHANNEL	MODULATION TECHNOLOGY	MODULATION TYPE	DATA RATE (Mbps)	COMBINATION MODE
802.11b	1 to 11	1, 6, 11	DSSS	DBPSK	1	A
802.11b	1 to 11	1, 6, 11	DSSS	DBPSK	1	B
802.11g	1 to 11	1, 6, 11	OFDM	BPSK	6	C
802.11g	1 to 11	1, 6, 11	OFDM	BPSK	6	D
802.11n (20MHz)	1 to 11	1, 6, 11	OFDM	BPSK	6.5	E
802.11n (20MHz)	1 to 11	1, 6, 11	OFDM	BPSK	6.5	F
802.11n (20MHz)	1 to 11	1, 6, 11	OFDM	BPSK	13	G
802.11n (40MHz)	3 to 9	3, 6, 9	OFDM	BPSK	13.5	H
802.11n (40MHz)	3 to 9	3, 6, 9	OFDM	BPSK	13.5	I
802.11n (40MHz)	3 to 9	3, 6, 9	OFDM	BPSK	27	J



A D T

ANTENNA PORT CONDUCTED MEASUREMENT:

- This item includes all test value of each mode, but only includes spectrum plot of worst value of each mode.
- Pre-Scan has been conducted to determine the worst-case mode from all possible combinations between available modulations, data rates and antenna ports (if EUT with antenna diversity architecture).
- Following channel(s) was (were) selected for the final test as listed below.

MODE	AVAILABLE CHANNEL	TESTED CHANNEL	MODULATION TECHNOLOGY	MODULATION TYPE	DATA RATE (Mbps)	COMBINATION MODE
802.11b	1 to 11	1, 6, 11	DSSS	DBPSK	1	A
802.11b	1 to 11	1, 6, 11	DSSS	DBPSK	1	B
802.11g	1 to 11	1, 6, 11	OFDM	BPSK	6	C
802.11g	1 to 11	1, 6, 11	OFDM	BPSK	6	D
802.11n (20MHz)	1 to 11	1, 6, 11	OFDM	BPSK	6.5	E
802.11n (20MHz)	1 to 11	1, 6, 11	OFDM	BPSK	6.5	F
802.11n (20MHz)	1 to 11	1, 6, 11	OFDM	BPSK	13	G
802.11n (40MHz)	3 to 9	3, 6, 9	OFDM	BPSK	13.5	H
802.11n (40MHz)	3 to 9	3, 6, 9	OFDM	BPSK	13.5	I
802.11n (40MHz)	3 to 9	3, 6, 9	OFDM	BPSK	27	J



A D T

CONDUCTED OUT-BAND EMISSION MEASUREMENT:

- Pre-Scan has been conducted to determine the worst-case mode from all possible combinations between available modulations, data rates and antenna ports (if EUT with antenna diversity architecture).
- Following channel(s) was (were) selected for the final test as listed below.

MODE	AVAILABLE CHANNEL	TESTED CHANNEL	MODULATION TECHNOLOGY	MODULATION TYPE	DATA RATE (Mbps)	COMBINATION MODE
802.11b	1 to 11	1, 6, 11	DSSS	DBPSK	1	A
802.11b	1 to 11	1, 6, 11	DSSS	DBPSK	1	B
802.11g	1 to 11	1, 6, 11	OFDM	BPSK	6	C
802.11g	1 to 11	1, 6, 11	OFDM	BPSK	6	D
802.11n (20MHz)	1 to 11	1, 6, 11	OFDM	BPSK	6.5	E
802.11n (20MHz)	1 to 11	1, 6, 11	OFDM	BPSK	6.5	F
802.11n (20MHz)	1 to 11	1, 6, 11	OFDM	BPSK	13	G
802.11n (40MHz)	3 to 9	3, 6, 9	OFDM	BPSK	13.5	H
802.11n (40MHz)	3 to 9	3, 6, 9	OFDM	BPSK	13.5	I
802.11n (40MHz)	3 to 9	3, 6, 9	OFDM	BPSK	27	J

※ TEST CONDITION:

APPLICABLE TO	ENVIRONMENTAL CONDITIONS	INPUT POWER	TESTED BY
PLC	25deg. C, 67%RH,	120Vac, 60Hz	Timmy Hu
RE ³ 1G	24deg. C, 66%RH	120Vac, 60Hz	Evan Huang
RE<1G	19deg. C, 64%RH	120Vac, 60Hz	Rex Huang
APCM	35deg. C, 60%RH	120Vac, 60Hz	Rex Huang
OB	25deg. C, 60%RH	120Vac, 60Hz	Rex Huang

3.3 GENERAL DESCRIPTION OF APPLIED STANDARDS

The EUT is a RF product. According to the specifications of the manufacturer, it must comply with the requirements of the following standards:

FCC Part 15, Subpart C. (15.247)

ANSI C63.4-2003

ANSI C63.10-2009

All test items have been performed and recorded as per the above standards.

NOTE: The EUT is also considered as a kind of computer peripheral, because the connection to computer is necessary for typical use. It has been verified to comply with the requirements of FCC Part 15, Subpart B, Class B (DoC). The test report has been issued separately.



A D T

3.4 DESCRIPTION OF SUPPORT UNITS

The EUT has been tested as an independent unit together with other necessary accessories or support units. The following support units or accessories were used to form a representative test configuration during the tests.

No.	Product	Brand	Model No.	Serial No.	FCC ID
1	NOTEBOOK COMPUTER	DELL	PP32LA	GSLB32S	FCC DoC
2	HUB	ZyXEL	ES-116P	S060H02000215	FCC DoC
3	IPOD shuffle	Apple	MC749TA/A	CC4DMFJUDFDM	NA
4	IPOD shuffle	Apple	MC749TA/A	CC4DN25WDFDM	NA
5	TELEPHONE	WONDER	WD-303	6C17FA00515	NA
6	TELEPHONE	WONDER	WD-303	6C17FA00774	NA
7	1 to 2 RJ-11 Connector	Foxconn	NA	NA	NA
8	Home Service Gateway	THOMSON or Technicolor	TG790	NA	NA

No.	Signal cable description
1	10m UTP cable.
2	10m UTP cable × 3.
3	0.1m USB cable.
4	0.1m USB cable.
5	1.6m RJ-11 cable.
6	1.6m RJ-11 cable.
7	1m RJ-11 cable.
8	10m Coaxial cable.

NOTE: All power cords of the above support units are non shielded (1.8m).

3.5 CONFIGURATION OF SYSTEM UNDER TEST

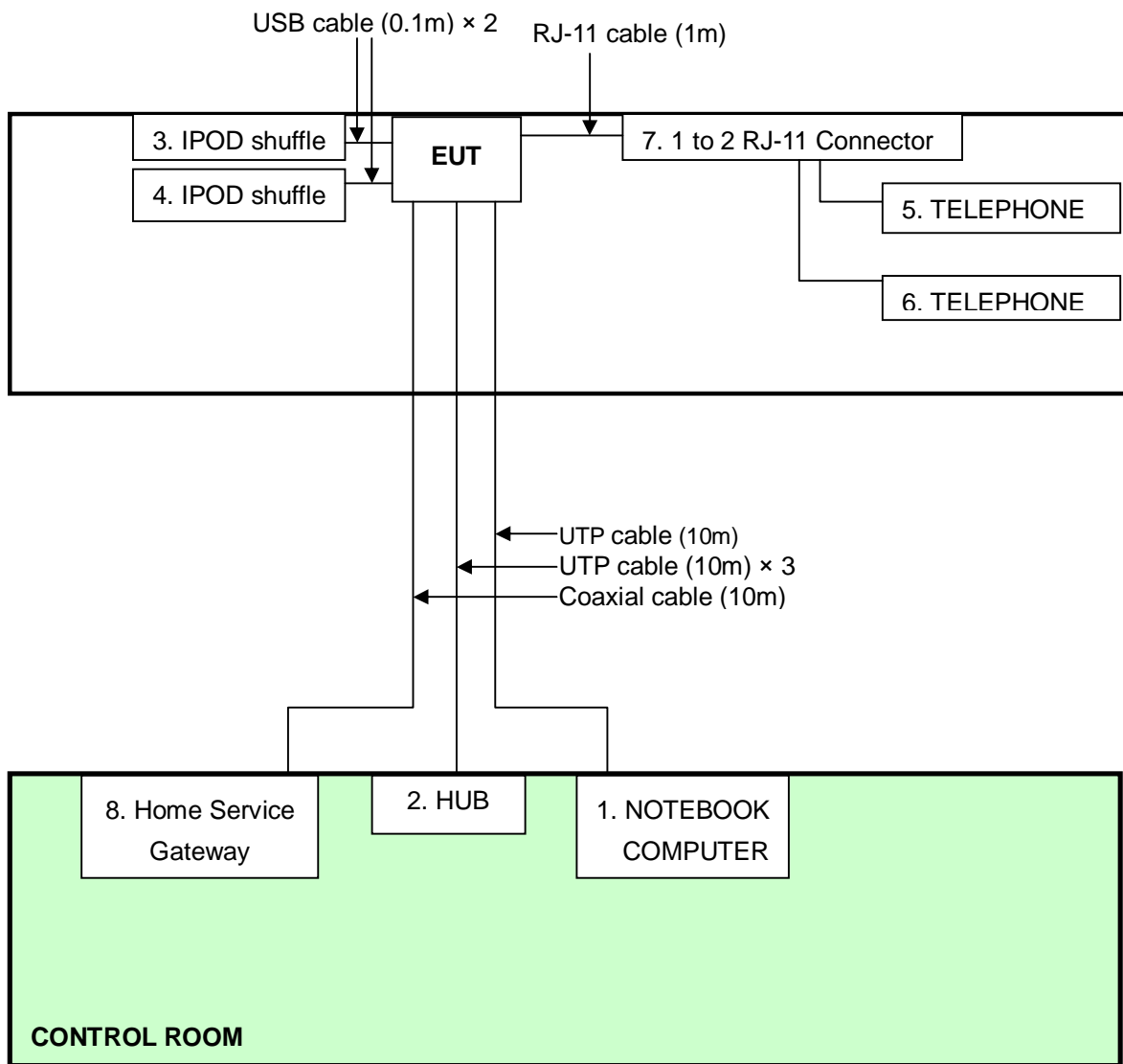



A D T

4. TEST TYPES AND RESULTS

4.1 CONDUCTED EMISSION MEASUREMENT

4.1.1 LIMITS OF CONDUCTED EMISSION MEASUREMENT

FREQUENCY OF EMISSION (MHz)	CONDUCTED LIMIT (dB μ V)	
	Quasi-peak	Average
0.15-0.5	66 to 56	56 to 46
0.5-5	56	46
5-30	60	50

- NOTE:**
1. The lower limit shall apply at the transition frequencies.
 2. The limit decreases in line with the logarithm of the frequency in the range of 0.15 to 0.50 MHz.
 3. All emanations from a class A/B digital device or system, including any network of conductors and apparatus connected thereto, shall not exceed the level of field strengths specified above.

4.1.2 TEST INSTRUMENTS

Test date: Sep. 06, 2011

DESCRIPTION & MANUFACTURER	MODEL NO.	SERIAL NO.	CALIBRATED DATE	CALIBRATED UNTIL
Test Receiver	ESCS 30	100375	Mar. 09, 2011	Mar. 08, 2012
Line-Impedance Stabilization Network (for EUT)	ENV216	100072	June 10, 2011	June 09, 2012
Line-Impedance Stabilization Network (for Peripheral)	ESH3-Z5	848773/004	Nov. 03, 2010	Nov. 02, 2011
RF Cable (JYEBAO)	5DFB	COCCAB-002	Aug. 29, 2011	Aug. 28, 2012
50 ohms Terminator	50	3	Oct. 07, 2010	Nov. 02, 2011
Software	BV ADT_Cond_V7.3.7	NA	NA	NA

Note:

1. The calibration interval of the above test instruments is 12 months and the calibrations are traceable to NML/ROC and NIST/USA.
2. The test was performed in Shielded Room No. C.
3. The VCCI Con C Registration No. is C-3611.

4.1.3 TEST PROCEDURES

- a. The EUT was placed 0.4 meters from the conducting wall of the shielded room with EUT being connected to the power mains through a line impedance stabilization network (LISN). Other support units were connected to the power mains through another LISN. The two LISNs provide 50 ohm/ 50uH of coupling impedance for the measuring instrument.
- b. Both lines of the power mains connected to the EUT were checked for maximum conducted interference.
- c. The frequency range from 150kHz to 30MHz was searched. Emission levels under (Limit - 20dB) were not recorded.

4.1.4 DEVIATION FROM TEST STANDARD

No deviation

4.1.5 TEST SETUP

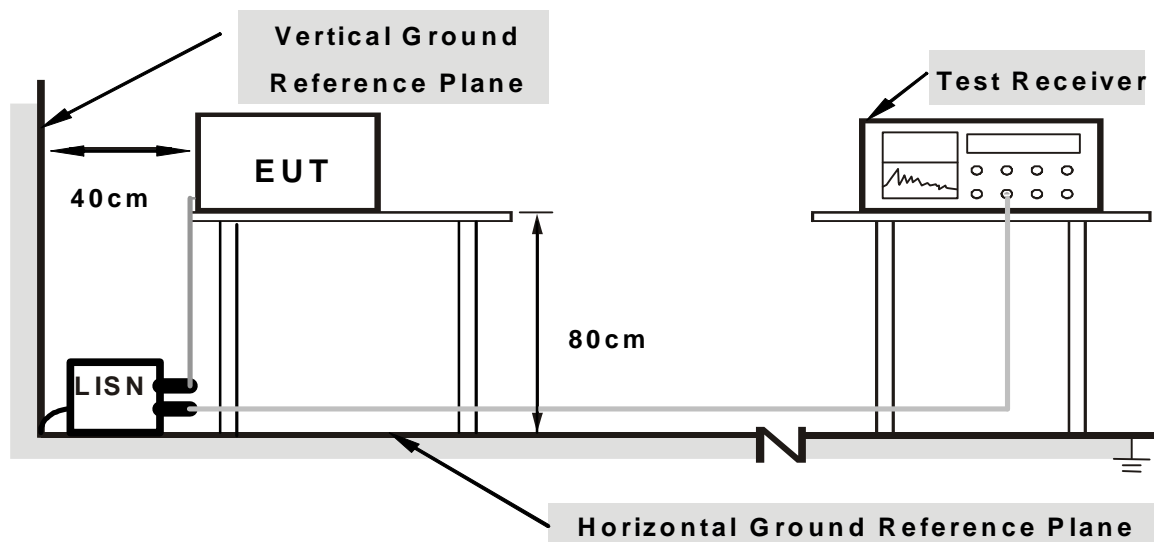

Note: 1. Support units were connected to second LISN.

2. Both of LISNs (AMN) are 80 cm from EUT and at least 80 from other units and other metal planes

For the actual test configuration, please refer to the related item – Photographs of the Test Configuration.

4.1.6 EUT OPERATING CONDITIONS

1. Placed the EUT on testing table.
2. Prepared other computer systems (support unit 1) to run test program “2 × 2_WL Command-package eng.txt” to enable EUT under transmission/receiving condition continuously via one UTP cables.

4.1.7 TEST RESULTS

PHASE	Line (L)	6dB BANDWIDTH	9 kHz
--------------	----------	----------------------	-------

No	Freq.	Corr.	Reading Value		Emission Level		Limit		Margin	
	[MHz]	Factor (dB)	[dB (uV)]		[dB (uV)]		[dB (uV)]		(dB)	
			Q.P.	AV.	Q.P.	AV.	Q.P.	AV.	Q.P.	AV.
1	0.150	9.67	41.26	35.13	50.93	44.80	66.00	56.00	-15.07	-11.20
2	0.189	9.68	33.22	28.42	42.90	38.10	64.08	54.08	-21.17	-15.97
3	0.420	9.70	30.10	26.41	39.80	36.11	57.46	47.46	-17.66	-11.35
4	1.535	9.71	23.24	17.55	32.95	27.26	56.00	46.00	-23.05	-18.74
5	4.090	9.75	27.13	21.14	36.88	30.89	56.00	46.00	-19.12	-15.11
6	10.617	9.88	30.27	24.94	40.15	34.82	60.00	50.00	-19.85	-15.18

- REMARKS:**
1. Q.P. and AV. are abbreviations of quasi-peak and average individually.
 2. The emission levels of other frequencies were very low against the limit.
 3. Margin value = Emission level - Limit value
 4. Correction factor = Insertion loss + Cable loss
 5. Emission Level = Correction Factor + Reading Value.

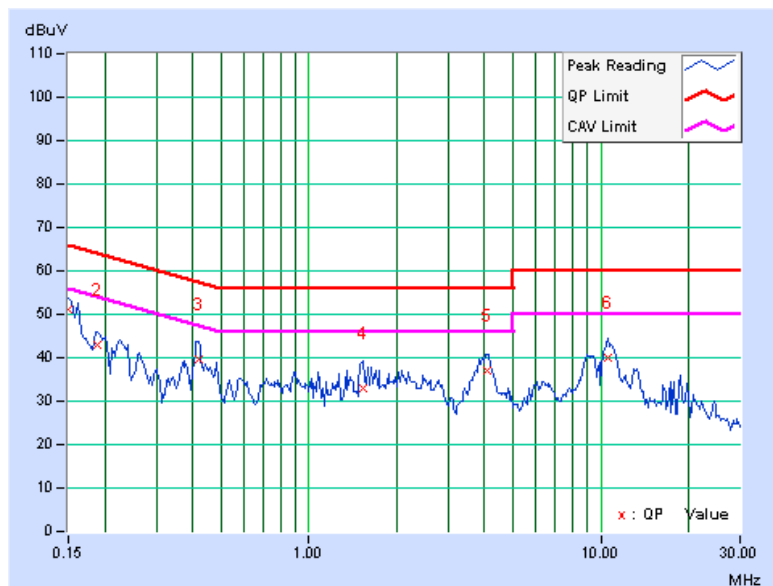

PHASE	Neutral (N)	6dB BANDWIDTH	9 kHz
--------------	-------------	----------------------	-------

No	Freq.	Corr.	Reading Value		Emission Level		Limit		Margin	
	[MHz]	Factor (dB)	[dB (uV)]		[dB (uV)]		[dB (uV)]		(dB)	
			Q.P.	AV.	Q.P.	AV.	Q.P.	AV.	Q.P.	AV.
1	0.150	9.71	42.46	34.99	52.17	44.70	66.00	56.00	-13.83	-11.30
2	0.416	9.74	35.73	30.74	45.47	40.48	57.54	47.54	-12.06	-7.05
3	1.754	9.77	29.44	24.16	39.21	33.93	56.00	46.00	-16.79	-12.07
4	4.066	9.80	34.56	28.31	44.36	38.11	56.00	46.00	-11.64	-7.89
5	9.121	9.96	33.29	28.21	43.25	38.17	60.00	50.00	-16.75	-11.83
6	10.707	10.00	35.13	29.89	45.13	39.89	60.00	50.00	-14.87	-10.11

- REMARKS:**
1. Q.P. and AV. are abbreviations of quasi-peak and average individually.
 2. The emission levels of other frequencies were very low against the limit.
 3. Margin value = Emission level - Limit value
 4. Correction factor = Insertion loss + Cable loss
 5. Emission Level = Correction Factor + Reading Value.

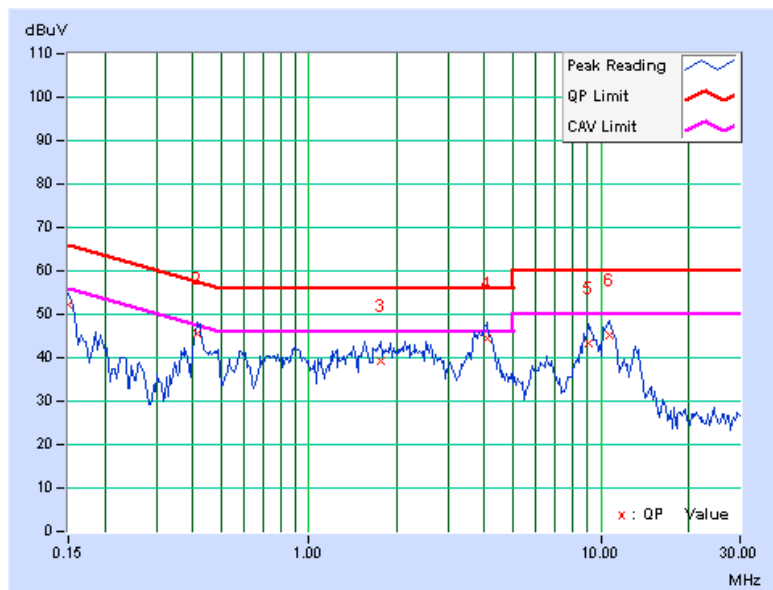



A D T

4.2 RADIATED EMISSION MEASUREMENT

4.2.1 LIMITS OF RADIATED EMISSION MEASUREMENT

Emissions radiated outside of the specified bands, shall be according to the general radiated limits in 15.209 as following:

Frequencies (MHz)	Field strength (microvolts/meter)	Measurement distance (meters)
0.009-0.490	2400/F(kHz)	300
0.490-1.705	24000/F(kHz)	30
1.705-30.0	30	30
30-88	100	3
88-216	150	3
216-960	200	3
Above 960	500	3

NOTE:

1. The lower limit shall apply at the transition frequencies.
2. Emission level (dBuV/m) = 20 log Emission level (uV/m).
3. As shown in 15.35(b), for frequencies above 1000MHz, the field strength limits are based on average detector, however, the peak field strength of any emission shall not exceed the maximum permitted average limits, specified above by more than 20dB under any condition of modulation.
4. Section 15.205 restricted bands of operation shall compliance with the limits in Section 15.209.



A D T

4.2.2 TEST INSTRUMENTS

Test date: Sep. 20, 2011

DESCRIPTION & MANUFACTURER	MODEL NO.	SERIAL NO.	CALIBRATED DATE	CALIBRATED UNTIL
Agilent Spectrum Analyzer	E4446A	MY48250253	Aug. 29, 2011	Aug. 28, 2012
Agilent Pre-Selector	N9039A	MY46520310	Aug. 29, 2011	Aug. 28, 2012
Agilent Signal Generator	N5181A	MY49060347	July 25, 2011	July 24, 2012
LIG NEX1 Test Receiver	ER-265	L09068005	Oct. 25, 2010	Oct. 24, 2011
Mini-Circuits Pre-Amplifier	ZFL-1000VH2B	AMP-ZFL-04	Nov. 16, 2010	Nov. 15, 2011
Agilent Pre-Amplifier	8449B	3008A02465	Feb. 28, 2011	Feb. 27, 2012
Miteq Pre-Amplifier	AFS33-1800265 0-30-8P-44	881786	Nov. 16, 2010	Nov. 15, 2011
SCHWARZBECK Trilog Broadband Antenna	VULB 9168	9168-361	Apr. 14, 2011	Apr. 13, 2012
AISI Horn_Antenna	AIH.8018	0000220091110	Nov. 22, 2010	Nov. 21, 2011
SCHWARZBECK Horn_Antenna	BBHA 9170	9170-424	Oct. 08, 2010	Oct. 07, 2011
RF CABLE	NA	RF104-205 RF104-207 RF104-202	Dec. 28, 2010	Dec. 27, 2011
RF Cable	NA	CHHCAB_001	Oct. 17, 2010	Oct. 16, 2011
Software	ADT_Radiated_V8.7.05	NA	NA	NA
CT Antenna Tower & Turn Table	NA	NA	NA	NA

Note: 1. The calibration interval of the above test instruments is 12 months and the calibrations are traceable to NML/ROC and NIST/USA.

2. The horn antenna, preamplifier (model: 8449B) are used only for the measurement of emission frequency above 1GHz if tested.

3. The test was performed in 966 Chamber No. H.

4. The FCC Site Registration No. is 797305.

5. The CANADA Site Registration No. is IC 7450H-3.

4.2.3 TEST PROCEDURES

- a. The EUT was placed on the top of a rotating table 0.8 meters above the ground at a 3 meters chamber room. The table was rotated 360 degrees to determine the position of the highest radiation.
- b. The EUT was set 3 meters away from the interference-receiving antenna, which was mounted on the top of a variable-height antenna tower.
- c. The height of antenna is varied from one meter to four meters above the ground to determine the maximum value of the field strength. Both horizontal and vertical polarizations of the antenna are set to make the measurement.
- d. For each suspected emission, the EUT was arranged to its worst case and then the antenna was tuned to heights from 1 meter to 4 meters and the rotatable table was turned from 0 degrees to 360 degrees to find the maximum reading.
- e. The test-receiver system was set to quasi-peak detect function and specified bandwidth with maximum hold mode when the test frequency is below 1 GHz.
- f. The test-receiver system was set to peak and average detect function and specified bandwidth with maximum hold mode when the test frequency is above 1 GHz. If the peak reading value also meets average limit, measurement with the average detector is unnecessary.

NOTE:

1. The resolution bandwidth and video bandwidth of test receiver/spectrum analyzer is 120kHz for Quasi-peak detection (QP) at frequency below 1GHz.
2. The resolution bandwidth of test receiver/spectrum analyzer is 1 MHz and video bandwidth is 3MHz for Peak detection at frequency above 1GHz.
3. The resolution bandwidth of test receiver/spectrum analyzer is 1MHz and the video bandwidth is 10Hz for Average detection (AV) at frequency above 1GHz.

4.2.4 DEVIATION FROM TEST STANDARD

No deviation

4.2.5 TEST SETUP

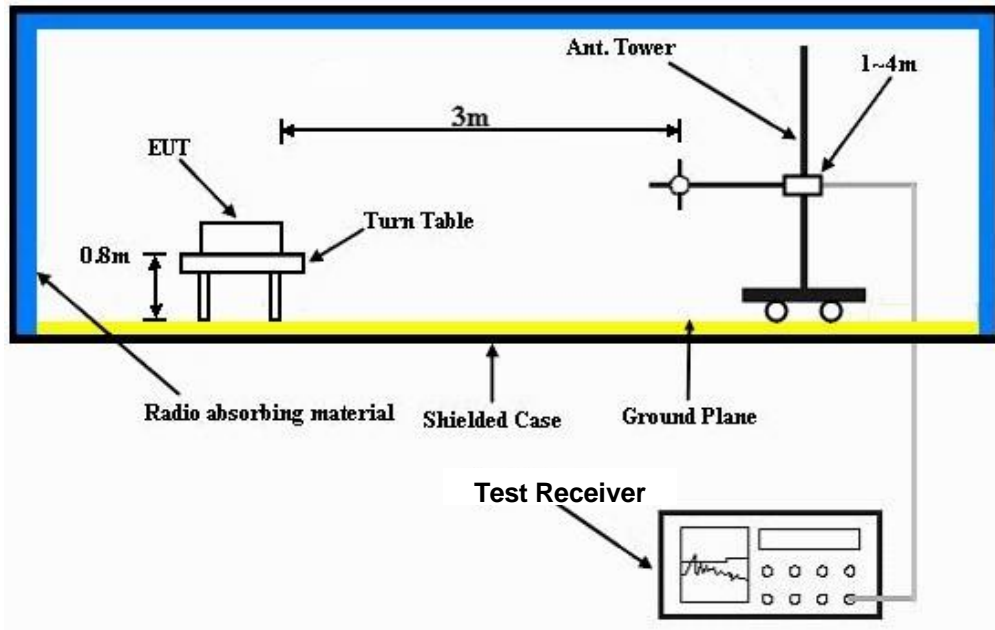

For the actual test configuration, please refer to the related item – Photographs of the Test Configuration.

4.2.6 EUT OPERATING CONDITIONS

Same as 4.1.6



A D T

4.2.7 TEST RESULTS

BELOW 1GHz WORST-CASE DATA : 802.11n (20MHz) OFDM MODULATION <Multiple chain>

EUT TEST CONDITION		MEASUREMENT DETAIL	
CHANNEL	Channel 6	FREQUENCY RANGE	Below 1000MHz
INPUT POWER	120Vac, 60 Hz	DETECTOR FUNCTION	Quasi-Peak
ENVIRONMENTAL CONDITIONS	19deg. C, 64%RH	TESTED BY	Rex Huang

ANTENNA POLARITY & TEST DISTANCE: HORIZONTAL AT 3 M								
NO.	FREQ. (MHz)	EMISSION LEVEL (dBuV/m)	LIMIT (dBuV/m)	MARGIN (dB)	ANTENNA HEIGHT (m)	TABLE ANGLE (Degree)	RAW VALUE (dBuV)	CORRECTION FACTOR (dB/m)
1	250.03	40.4 QP	46.0	-5.6	1.25 H	1	27.40	13.04
2	374.88	38.2 QP	46.0	-7.8	1.00 H	286	21.44	16.79
3	500.10	32.2 QP	46.0	-13.8	1.75 H	359	12.66	19.53
4	569.41	34.7 QP	46.0	-11.3	1.50 H	341	13.68	20.99
5	587.49	37.2 QP	46.0	-8.8	1.25 H	354	15.84	21.35
6	874.90	31.9 QP	46.0	-14.1	1.25 H	360	6.44	25.47

ANTENNA POLARITY & TEST DISTANCE: VERTICAL AT 3 M								
NO.	FREQ. (MHz)	EMISSION LEVEL (dBuV/m)	LIMIT (dBuV/m)	MARGIN (dB)	ANTENNA HEIGHT (m)	TABLE ANGLE (Degree)	RAW VALUE (dBuV)	CORRECTION FACTOR (dB/m)
1	38.41	32.5 QP	40.0	-7.5	1.50 V	231	18.74	13.80
2	250.00	35.3 QP	46.0	-10.7	2.00 V	251	22.25	13.04
3	374.12	39.3 QP	46.0	-6.7	1.25 V	80	22.54	16.77
4	500.16	31.9 QP	46.0	-14.1	1.00 V	61	12.36	19.53
5	565.23	32.2 QP	46.0	-13.8	1.00 V	62	11.32	20.91
6	624.86	29.2 QP	46.0	-16.8	1.50 V	360	7.48	21.73

- REMARKS:**
1. Emission level (dBuV/m) = Raw Value (dBuV) + Correction Factor (dB/m).
 2. Correction Factor (dB/m) = Antenna Factor (dB/m) + Cable Factor (dB).
 3. The other emission levels were very low against the limit.
 4. Margin value = Emission level – Limit value.



A D T

ABOVE 1GHz WORST-CASE DATA

802.11b DSSS MODULATION <Single Chain (0)>

EUT TEST CONDITION		MEASUREMENT DETAIL	
CHANNEL	Channel 1	FREQUENCY RANGE	1 ~ 25GHz
INPUT POWER	120Vac, 60 Hz	DETECTOR FUNCTION	Peak (PK) Average (AV)
ENVIRONMENTAL CONDITIONS	24deg. C, 66%RH	TESTED BY	Evan Huang

ANTENNA POLARITY & TEST DISTANCE: HORIZONTAL AT 3 M								
NO.	FREQ. (MHz)	EMISSION LEVEL (dBuV/m)	LIMIT (dBuV/m)	MARGIN (dB)	ANTENNA HEIGHT (m)	TABLE ANGLE (Degree)	RAW VALUE (dBuV)	CORRECTION FACTOR (dB/m)
1	2390.00	59.5 PK	74.0	-14.5	1.45 H	60	27.62	31.88
2	2390.00	49.0 AV	54.0	-5.0	1.45 H	60	17.12	31.88
3	*2412.00	104.9 PK			1.10 H	25	72.95	31.95
4	*2412.00	102.4 AV			1.10 H	25	70.45	31.95
5	2493.00	57.2 PK	74.0	-16.8	1.42 H	157	24.97	32.23
6	2493.00	45.9 AV	54.0	-8.1	1.42 H	157	13.67	32.23
7	4824.00	55.5 PK	74.0	-18.5	1.21 H	306	14.28	41.22
8	4824.00	52.8 AV	54.0	-1.2	1.21 H	306	11.58	41.22
ANTENNA POLARITY & TEST DISTANCE: VERTICAL AT 3 M								
NO.	FREQ. (MHz)	EMISSION LEVEL (dBuV/m)	LIMIT (dBuV/m)	MARGIN (dB)	ANTENNA HEIGHT (m)	TABLE ANGLE (Degree)	RAW VALUE (dBuV)	CORRECTION FACTOR (dB/m)
1	2390.00	60.3 PK	74.0	-13.7	1.17 V	330	28.42	31.88
2	2390.00	52.8 AV	54.0	-1.2	1.17 V	330	20.92	31.88
3	*2412.00	107.4 PK			1.25 V	31	75.45	31.95
4	*2412.00	104.9 AV			1.25 V	31	72.95	31.95
5	2493.70	63.0 PK	74.0	-11.0	1.09 V	327	30.77	32.23
6	2493.70	52.0 AV	54.0	-2.0	1.09 V	327	19.77	32.23
7	4824.00	55.8 PK	74.0	-18.2	1.15 V	307	14.58	41.22
8	4824.00	52.5 AV	54.0	-1.5	1.15 V	307	11.28	41.22

- REMARKS:**
1. Emission level (dBuV/m) = Raw Value (dBuV) + Correction Factor (dB/m).
 2. Correction Factor (dB/m) = Antenna Factor (dB/m) + Cable Factor (dB).
 3. The other emission levels were very low against the limit.
 4. Margin value = Emission level – Limit value.
 5. “ * “: Fundamental frequency.



A D T

EUT TEST CONDITION		MEASUREMENT DETAIL	
CHANNEL	Channel 6	FREQUENCY RANGE	1 ~ 25GHz
INPUT POWER	120Vac, 60 Hz	DETECTOR FUNCTION	Peak (PK) Average (AV)
ENVIRONMENTAL CONDITIONS	24deg. C, 66%RH	TESTED BY	Evan Huang

ANTENNA POLARITY & TEST DISTANCE: HORIZONTAL AT 3 M								
NO.	FREQ. (MHz)	EMISSION LEVEL (dBuV/m)	LIMIT (dBuV/m)	MARGIN (dB)	ANTENNA HEIGHT (m)	TABLE ANGLE (Degree)	RAW VALUE (dBuV)	CORRECTION FACTOR (dB/m)
1	*2437.00	106.1 PK			1.17 H	23	74.06	32.04
2	*2437.00	103.7 AV			1.17 H	23	71.66	32.04
3	4874.00	52.3 PK	74.0	-21.7	1.25 H	307	10.94	41.36
4	4874.00	51.5 AV	54.0	-2.5	1.25 H	307	10.14	41.36
5	7311.00	53.2 PK	74.0	-20.8	1.22 H	56	7.53	45.67
6	7311.00	43.2 AV	54.0	-10.8	1.22 H	56	-2.47	45.67
ANTENNA POLARITY & TEST DISTANCE: VERTICAL AT 3 M								
NO.	FREQ. (MHz)	EMISSION LEVEL (dBuV/m)	LIMIT (dBuV/m)	MARGIN (dB)	ANTENNA HEIGHT (m)	TABLE ANGLE (Degree)	RAW VALUE (dBuV)	CORRECTION FACTOR (dB/m)
1	*2437.00	112.5 PK			1.14 V	215	80.46	32.04
2	*2437.00	110.2 AV			1.14 V	215	78.16	32.04
3	4874.00	49.7 PK	74.0	-24.3	1.36 V	327	8.34	41.36
4	4874.00	42.9 AV	54.0	-11.1	1.36 V	327	1.54	41.36
5	7311.00	54.1 PK	74.0	-19.9	1.57 V	29	8.43	45.67
6	7311.00	46.6 AV	54.0	-7.4	1.57 V	29	0.93	45.67

- REMARKS:**
1. Emission level (dBuV/m) = Raw Value (dBuV) + Correction Factor (dB/m).
 2. Correction Factor (dB/m) = Antenna Factor (dB/m) + Cable Factor (dB).
 3. The other emission levels were very low against the limit.
 4. Margin value = Emission level – Limit value.
 5. “ * “: Fundamental frequency.



A D T

EUT TEST CONDITION		MEASUREMENT DETAIL	
CHANNEL	Channel 11	FREQUENCY RANGE	1 ~ 25GHz
INPUT POWER	120Vac, 60 Hz	DETECTOR FUNCTION	Peak (PK) Average (AV)
ENVIRONMENTAL CONDITIONS	24deg. C, 66%RH	TESTED BY	Evan Huang

ANTENNA POLARITY & TEST DISTANCE: HORIZONTAL AT 3 M

NO.	FREQ. (MHz)	EMISSION LEVEL (dBuV/m)	LIMIT (dBuV/m)	MARGIN (dB)	ANTENNA HEIGHT (m)	TABLE ANGLE (Degree)	RAW VALUE (dBuV)	CORRECTION FACTOR (dB/m)
1	*2462.00	103.3 PK			1.48 H	302	71.18	32.12
2	*2462.00	100.8 AV			1.48 H	302	68.68	32.12
3	2483.50	58.8 PK	74.0	-15.2	1.40 H	47	26.61	32.19
4	2483.50	50.5 AV	54.0	-3.5	1.40 H	47	18.31	32.19
5	4924.00	51.9 PK	74.0	-22.1	1.24 H	313	10.42	41.48
6	4924.00	47.5 AV	54.0	-6.5	1.24 H	313	6.02	41.48
7	7386.00	53.8 PK	74.0	-20.2	1.05 H	319	7.89	45.91
8	7386.00	45.2 AV	54.0	-8.8	1.05 H	319	-0.71	45.91

ANTENNA POLARITY & TEST DISTANCE: VERTICAL AT 3 M

NO.	FREQ. (MHz)	EMISSION LEVEL (dBuV/m)	LIMIT (dBuV/m)	MARGIN (dB)	ANTENNA HEIGHT (m)	TABLE ANGLE (Degree)	RAW VALUE (dBuV)	CORRECTION FACTOR (dB/m)
1	*2462.00	111.5 PK			1.10 V	327	79.38	32.12
2	*2462.00	109.3 AV			1.10 V	327	77.18	32.12
3	2483.50	61.4 PK	74.0	-12.6	1.64 V	263	29.21	32.19
4	2483.50	52.1 AV	54.0	-1.9	1.64 V	263	19.91	32.19
5	4924.00	52.1 PK	74.0	-21.9	1.20 V	323	10.62	41.48
6	4924.00	46.8 AV	54.0	-7.2	1.20 V	323	5.32	41.48
7	7386.00	58.0 PK	74.0	-16.0	1.00 V	5	12.10	45.91
8	7386.00	51.8 AV	54.0	-2.2	1.00 V	5	5.89	45.91

- REMARKS:**
1. Emission level (dBuV/m) = Raw Value (dBuV) + Correction Factor (dB/m).
 2. Correction Factor (dB/m) = Antenna Factor (dB/m) + Cable Factor (dB).
 3. The other emission levels were very low against the limit.
 4. Margin value = Emission level – Limit value.
 5. “ * “: Fundamental frequency.



A D T

RESTRICTED BANDEDGE (802.11b MODE, CH1, HORIZONTAL)

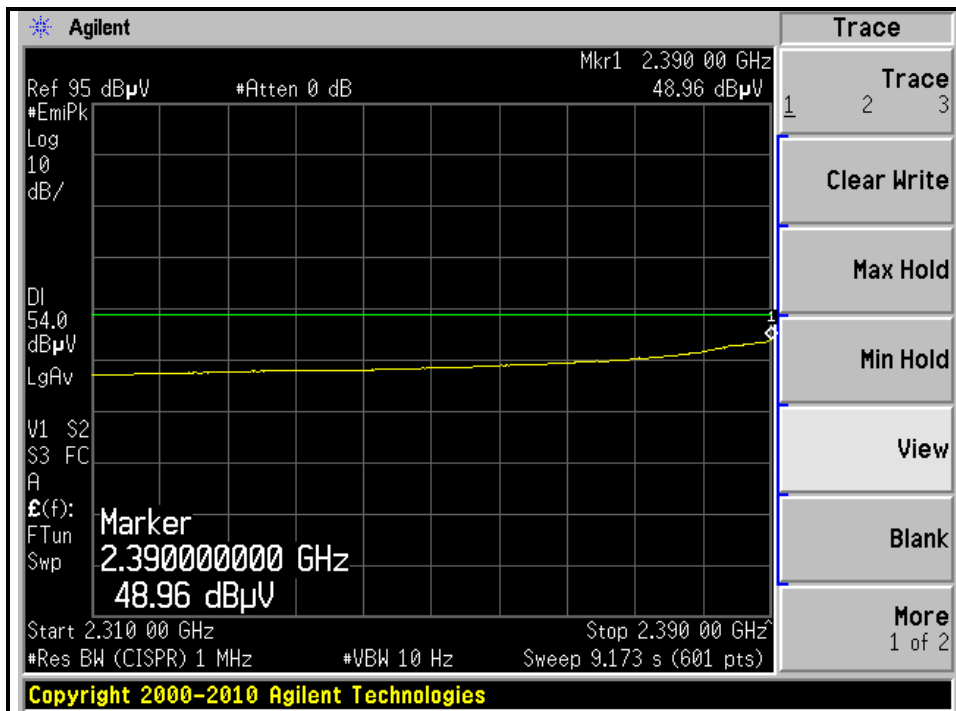
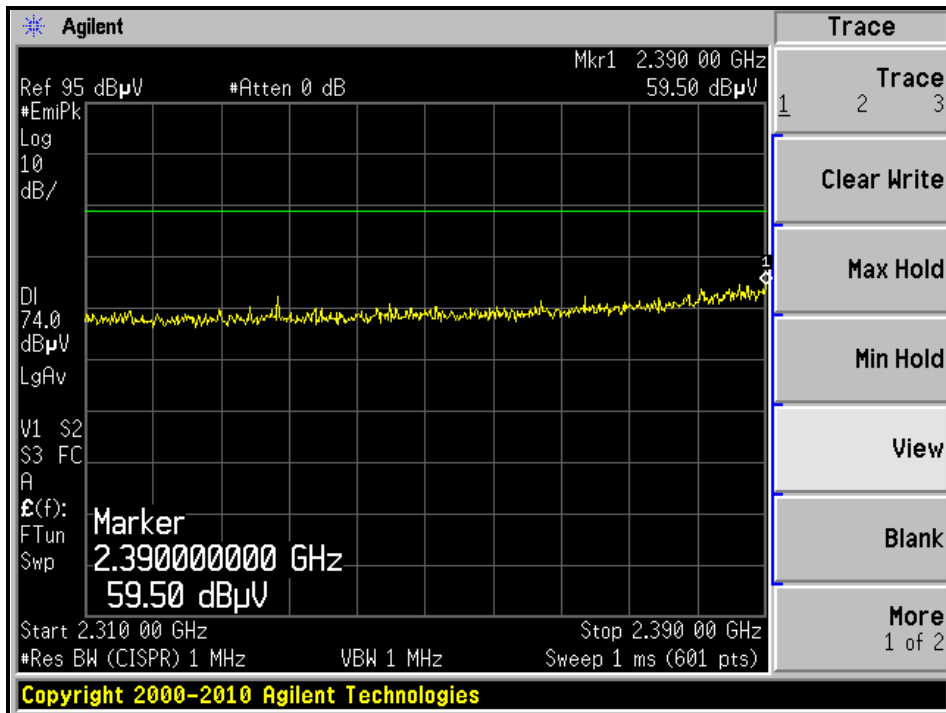



A D T

RESTRICTED BANDEDGE (802.11b MODE, CH1, VERTICAL)

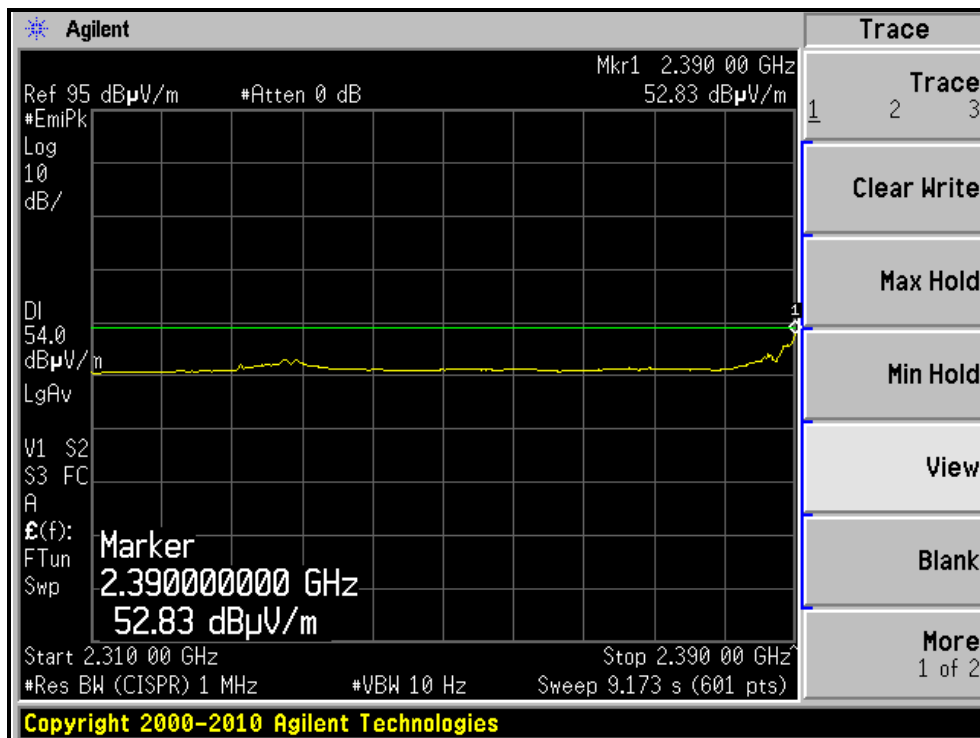
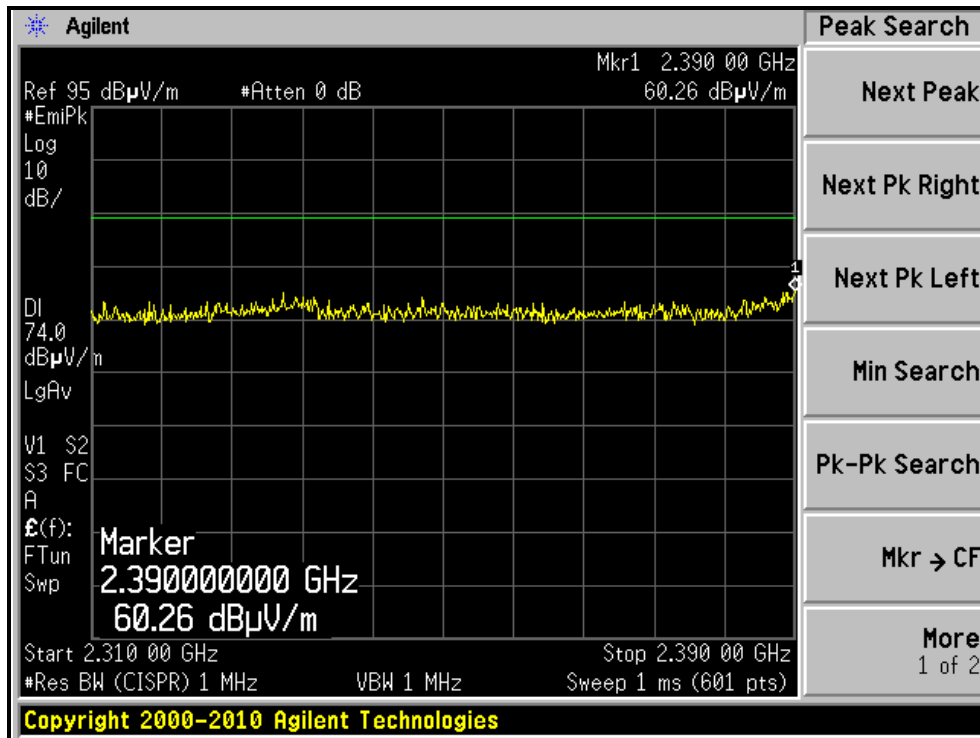



A D T

RESTRICTED BANDEDGE (802.11b MODE, CH11, HORIZONTAL)

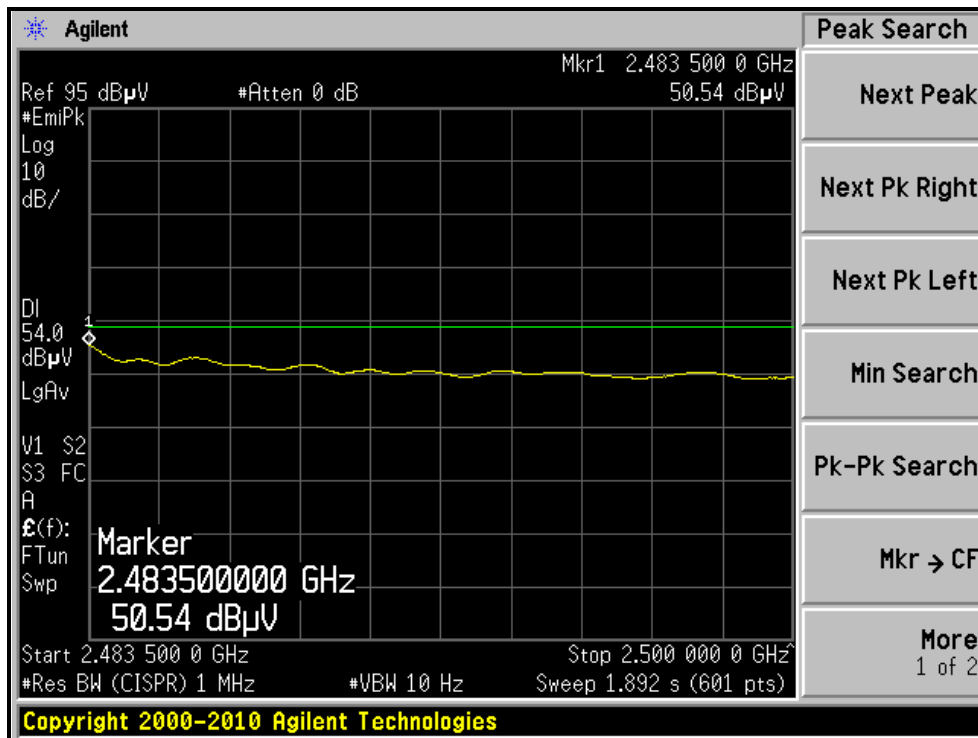
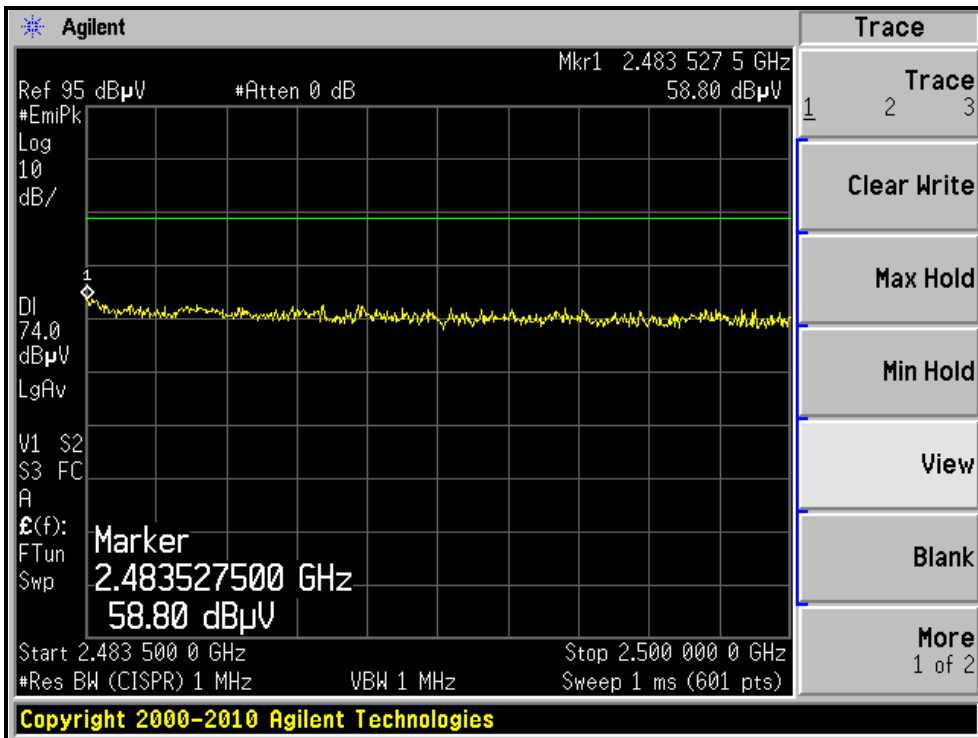



A D T

RESTRICTED BANDEDGE (802.11b MODE, CH11, VERTICAL)

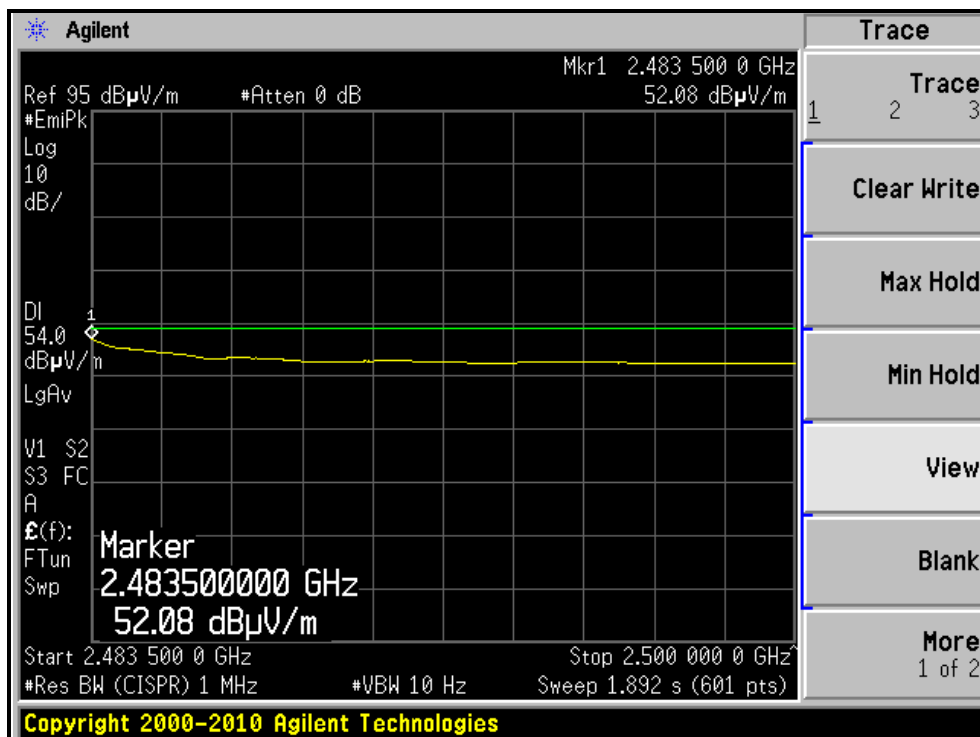
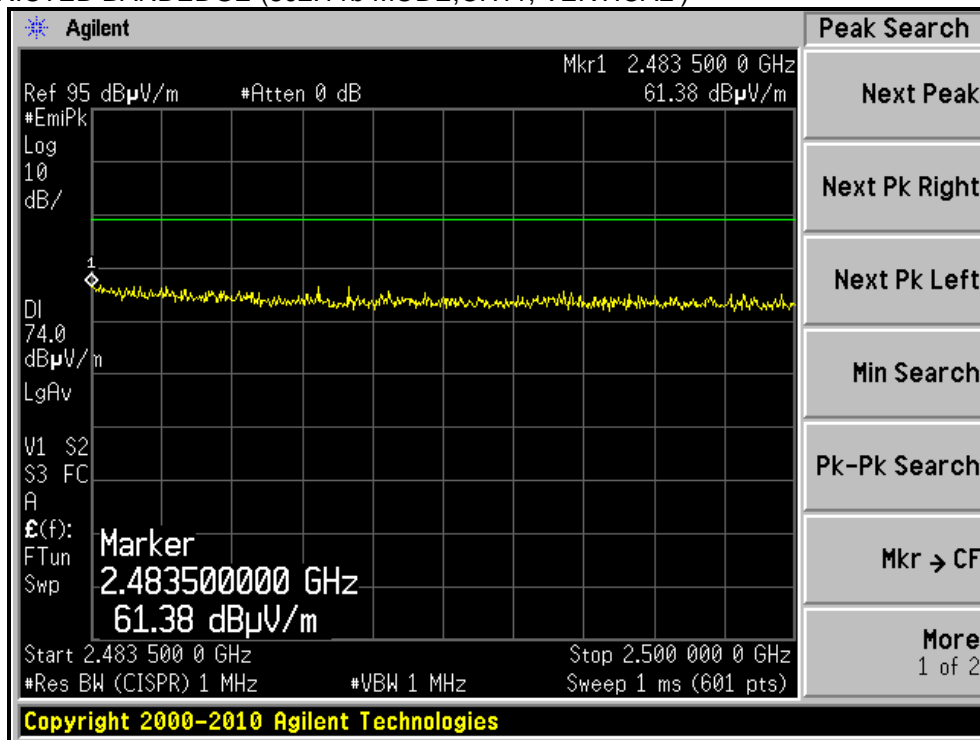



A D T

802.11b DSSS MODULATION <Single Chain (1)>

EUT TEST CONDITION		MEASUREMENT DETAIL	
CHANNEL	Channel 1	FREQUENCY RANGE	1 ~ 25GHz
INPUT POWER	120Vac, 60 Hz	DETECTOR FUNCTION	Peak (PK) Average (AV)
ENVIRONMENTAL CONDITIONS	24deg. C, 66%RH	TESTED BY	Evan Huang

ANTENNA POLARITY & TEST DISTANCE: HORIZONTAL AT 3 M								
NO.	FREQ. (MHz)	EMISSION LEVEL (dBuV/m)	LIMIT (dBuV/m)	MARGIN (dB)	ANTENNA HEIGHT (m)	TABLE ANGLE (Degree)	RAW VALUE (dBuV)	CORRECTION FACTOR (dB/m)
1	2390.00	63.3 PK	74.0	-10.7	1.45 H	329	31.42	31.88
2	2390.00	52.3 AV	54.0	-1.7	1.45 H	329	20.42	31.88
3	*2412.00	113.2 PK			1.45 H	330	81.25	31.95
4	*2412.00	110.9 AV			1.45 H	330	78.95	31.95
5	4824.00	50.2 PK	74.0	-23.8	1.15 H	76	8.98	41.22
6	4824.00	41.7 AV	54.0	-12.3	1.15 H	76	0.48	41.22
ANTENNA POLARITY & TEST DISTANCE: VERTICAL AT 3 M								
NO.	FREQ. (MHz)	EMISSION LEVEL (dBuV/m)	LIMIT (dBuV/m)	MARGIN (dB)	ANTENNA HEIGHT (m)	TABLE ANGLE (Degree)	RAW VALUE (dBuV)	CORRECTION FACTOR (dB/m)
1	2390.00	60.0 PK	74.0	-14.0	1.46 V	92	28.12	31.88
2	2390.00	49.5 AV	54.0	-4.5	1.46 V	92	17.62	31.88
3	*2412.00	108.1 PK			1.51 V	81	76.15	31.95
4	*2412.00	105.7 AV			1.51 V	81	73.75	31.95
5	4824.00	50.0 PK	74.0	-24.0	1.14 V	357	8.78	41.22
6	4824.00	39.3 AV	54.0	-14.7	1.14 V	357	-1.92	41.22

- REMARKS:**
1. Emission level (dBuV/m) = Raw Value (dBuV) + Correction Factor (dB/m).
 2. Correction Factor (dB/m) = Antenna Factor (dB/m) + Cable Factor (dB).
 3. The other emission levels were very low against the limit.
 4. Margin value = Emission level – Limit value.
 5. “ * “: Fundamental frequency.



A D T

EUT TEST CONDITION		MEASUREMENT DETAIL	
CHANNEL	Channel 6	FREQUENCY RANGE	1 ~ 25GHz
INPUT POWER	120Vac, 60 Hz	DETECTOR FUNCTION	Peak (PK) Average (AV)
ENVIRONMENTAL CONDITIONS	24deg. C, 66%RH	TESTED BY	Evan Huang

ANTENNA POLARITY & TEST DISTANCE: HORIZONTAL AT 3 M

NO.	FREQ. (MHz)	EMISSION LEVEL (dBuV/m)	LIMIT (dBuV/m)	MARGIN (dB)	ANTENNA HEIGHT (m)	TABLE ANGLE (Degree)	RAW VALUE (dBuV)	CORRECTION FACTOR (dB/m)
1	2390.00	62.1 PK	74.0	-11.9	1.46 H	327	30.22	31.88
2	2390.00	49.8 AV	54.0	-4.2	1.46 H	327	17.92	31.88
3	*2437.00	115.5 PK			1.40 H	57	83.46	32.04
4	*2437.00	113.2 AV			1.40 H	57	81.16	32.04
5	2488.00	61.6 PK	74.0	-12.4	1.34 H	58	29.39	32.21
6	2488.00	49.3 AV	54.0	-4.7	1.34 H	58	17.09	32.21
7	4874.00	55.2 PK	74.0	-18.8	1.15 H	64	13.84	41.36
8	4874.00	52.3 AV	54.0	-1.7	1.15 H	64	10.94	41.36
9	7311.00	52.2 PK	74.0	-21.8	1.16 H	302	6.53	45.67
10	7311.00	42.2 AV	54.0	-11.8	1.16 H	302	-3.47	45.67

ANTENNA POLARITY & TEST DISTANCE: VERTICAL AT 3 M

NO.	FREQ. (MHz)	EMISSION LEVEL (dBuV/m)	LIMIT (dBuV/m)	MARGIN (dB)	ANTENNA HEIGHT (m)	TABLE ANGLE (Degree)	RAW VALUE (dBuV)	CORRECTION FACTOR (dB/m)
1	*2437.00	111.2 PK			1.00 V	278	79.16	32.04
2	*2437.00	108.7 AV			1.00 V	278	76.66	32.04
3	4874.00	49.8 PK	74.0	-24.2	1.23 V	55	8.44	41.36
4	4874.00	41.4 AV	54.0	-12.6	1.23 V	55	0.04	41.36
5	7311.00	51.4 PK	74.0	-22.6	1.00 V	327	5.73	45.67
6	7311.00	40.0 AV	54.0	-14.0	1.00 V	327	-5.67	45.67

- REMARKS:**
1. Emission level (dBuV/m) = Raw Value (dBuV) + Correction Factor (dB/m).
 2. Correction Factor (dB/m) = Antenna Factor (dB/m) + Cable Factor (dB).
 3. The other emission levels were very low against the limit.
 4. Margin value = Emission level – Limit value.
 5. “ * “: Fundamental frequency.



A D T

EUT TEST CONDITION		MEASUREMENT DETAIL	
CHANNEL	Channel 11	FREQUENCY RANGE	1 ~ 25GHz
INPUT POWER	120Vac, 60 Hz	DETECTOR FUNCTION	Peak (PK) Average (AV)
ENVIRONMENTAL CONDITIONS	24deg. C, 66%RH	TESTED BY	Evan Huang

ANTENNA POLARITY & TEST DISTANCE: HORIZONTAL AT 3 M

NO.	FREQ. (MHz)	EMISSION LEVEL (dBuV/m)	LIMIT (dBuV/m)	MARGIN (dB)	ANTENNA HEIGHT (m)	TABLE ANGLE (Degree)	RAW VALUE (dBuV)	CORRECTION FACTOR (dB/m)
1	*2462.00	112.3 PK			1.39 H	52	80.18	32.12
2	*2462.00	110.4 AV			1.39 H	52	78.28	32.12
3	2483.50	64.4 PK	74.0	-9.6	1.39 H	57	32.21	32.19
4	2483.50	53.2 AV	54.0	-0.8	1.39 H	57	21.01	32.19
5	4924.00	52.1 PK	74.0	-21.9	1.40 H	35	10.62	41.48
6	4924.00	45.9 AV	54.0	-8.1	1.40 H	35	4.42	41.48
7	7386.00	58.4 PK	74.0	-15.6	1.27 H	57	12.49	45.91
8	7386.00	52.8 AV	54.0	-1.2	1.27 H	57	6.89	45.91

ANTENNA POLARITY & TEST DISTANCE: VERTICAL AT 3 M

NO.	FREQ. (MHz)	EMISSION LEVEL (dBuV/m)	LIMIT (dBuV/m)	MARGIN (dB)	ANTENNA HEIGHT (m)	TABLE ANGLE (Degree)	RAW VALUE (dBuV)	CORRECTION FACTOR (dB/m)
1	*2462.00	108.5 PK			1.48 V	83	76.38	32.12
2	*2462.00	106.5 AV			1.48 V	83	74.38	32.12
3	2486.90	60.4 PK	74.0	-13.6	1.42 V	91	28.19	32.21
4	2486.90	49.3 AV	54.0	-4.7	1.42 V	91	17.09	32.21
5	4924.00	51.3 PK	74.0	-22.7	1.38 V	28	9.82	41.48
6	4924.00	44.9 AV	54.0	-9.1	1.38 V	28	3.42	41.48
7	7386.00	53.5 PK	74.0	-20.5	1.61 V	211	7.59	45.91
8	7386.00	41.2 AV	54.0	-12.8	1.61 V	211	-4.71	45.91

- REMARKS:**
1. Emission level (dBuV/m) = Raw Value (dBuV) + Correction Factor (dB/m).
 2. Correction Factor (dB/m) = Antenna Factor (dB/m) + Cable Factor (dB).
 3. The other emission levels were very low against the limit.
 4. Margin value = Emission level – Limit value.
 5. “ * “: Fundamental frequency.

RESTRICTED BANDEDGE (802.11b MODE, CH1, HORIZONTAL)

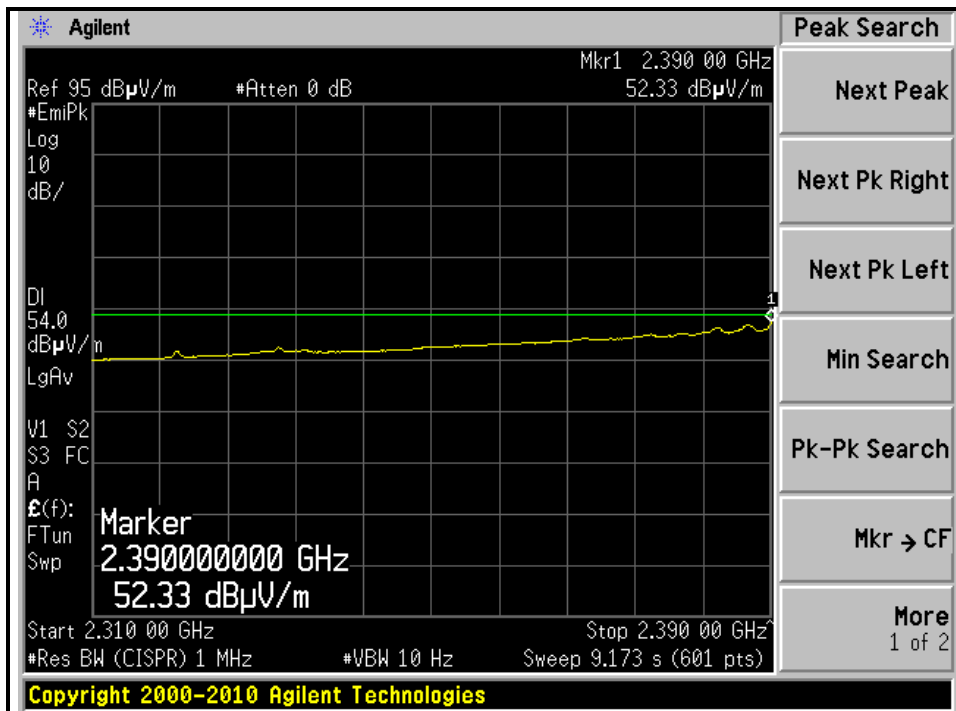
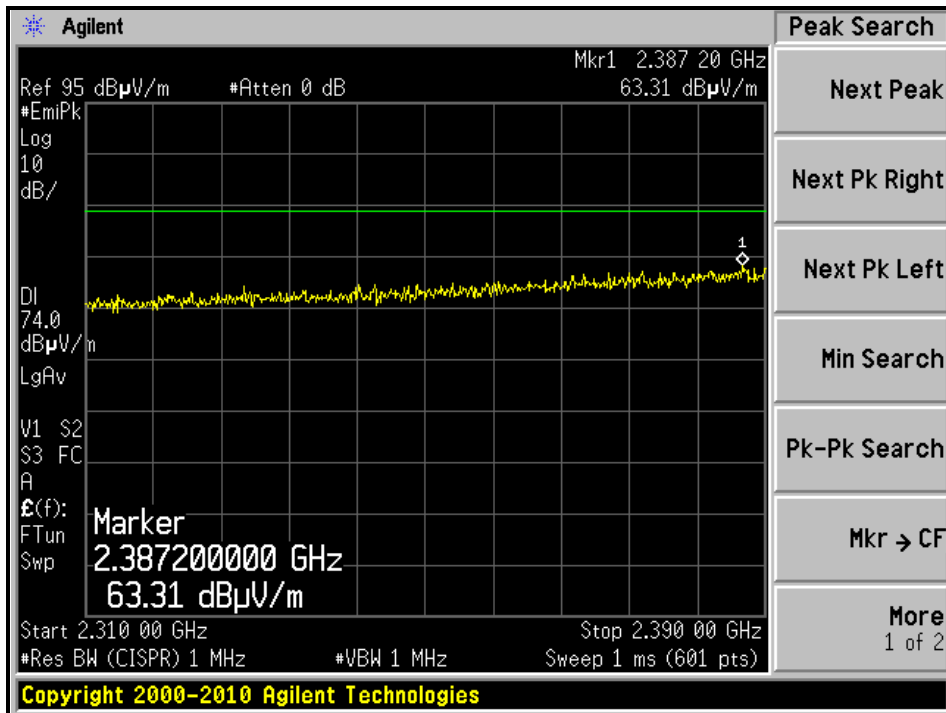



A D T

RESTRICTED BANDEDGE (802.11b MODE, CH1, VERTICAL)

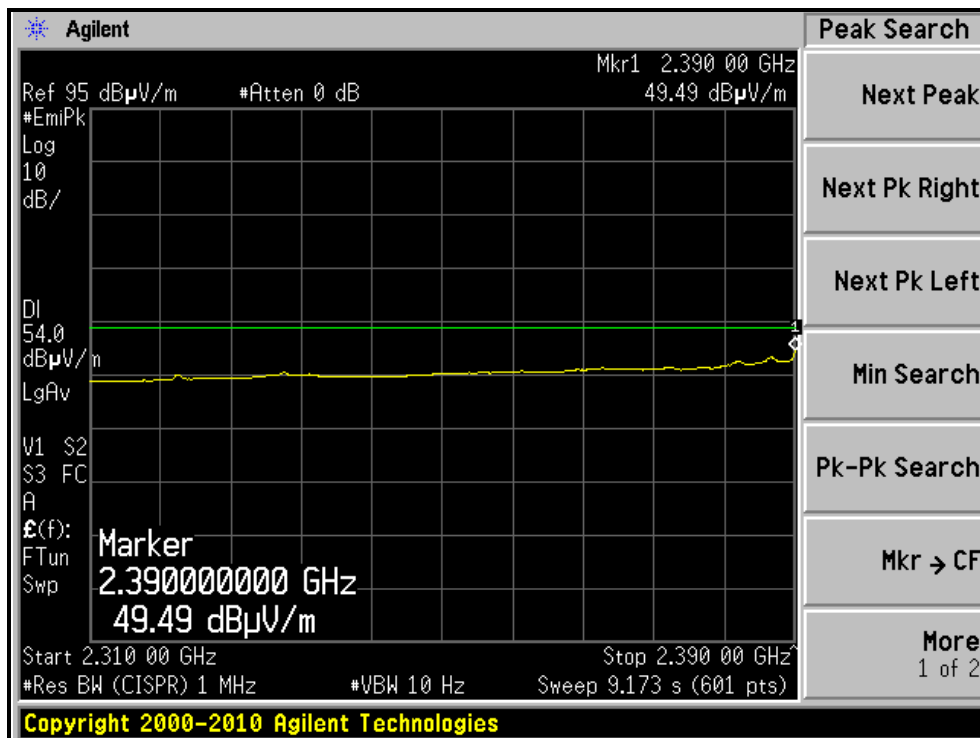
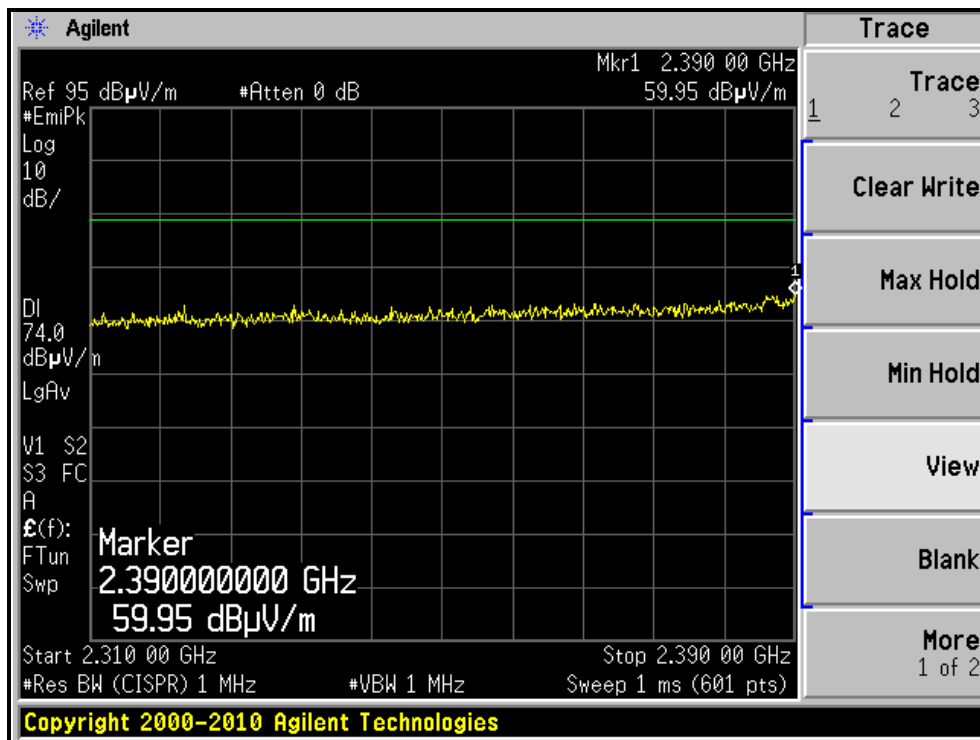

RESTRICTED BANDEDGE (802.11b MODE, CH11, HORIZONTAL)

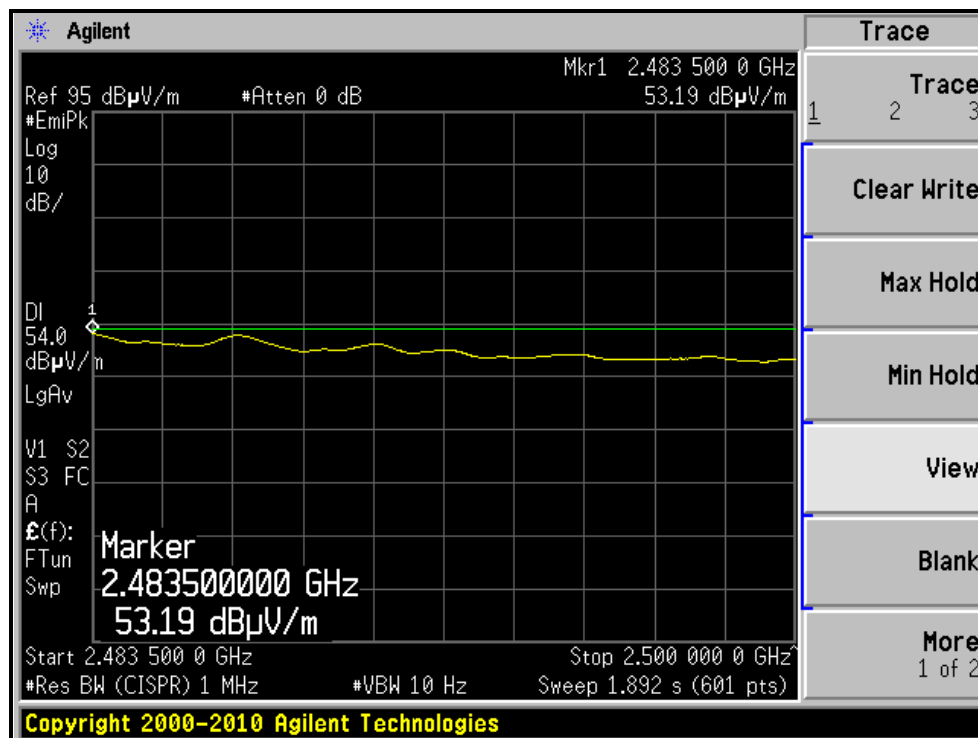
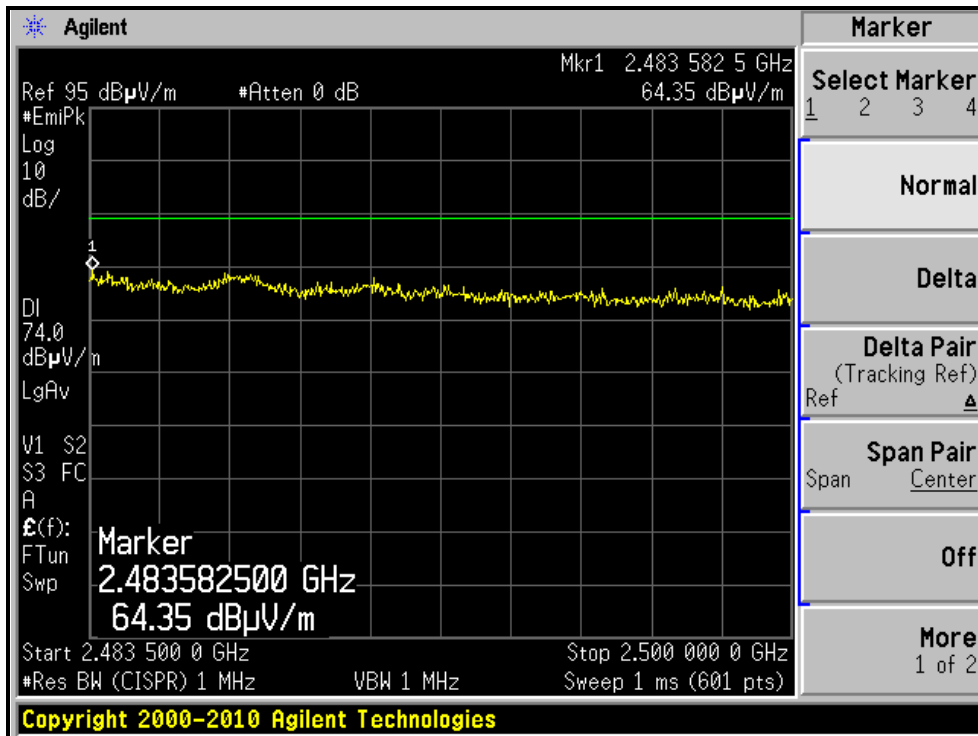



A D T

RESTRICTED BANDEDGE (802.11b MODE, CH11, VERTICAL)

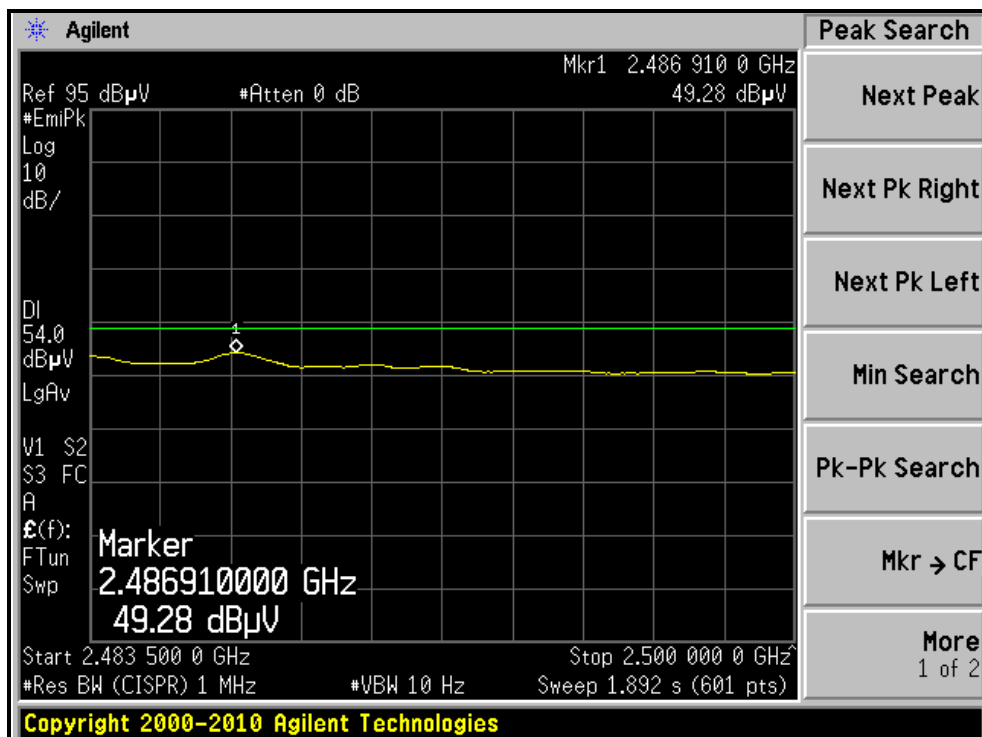
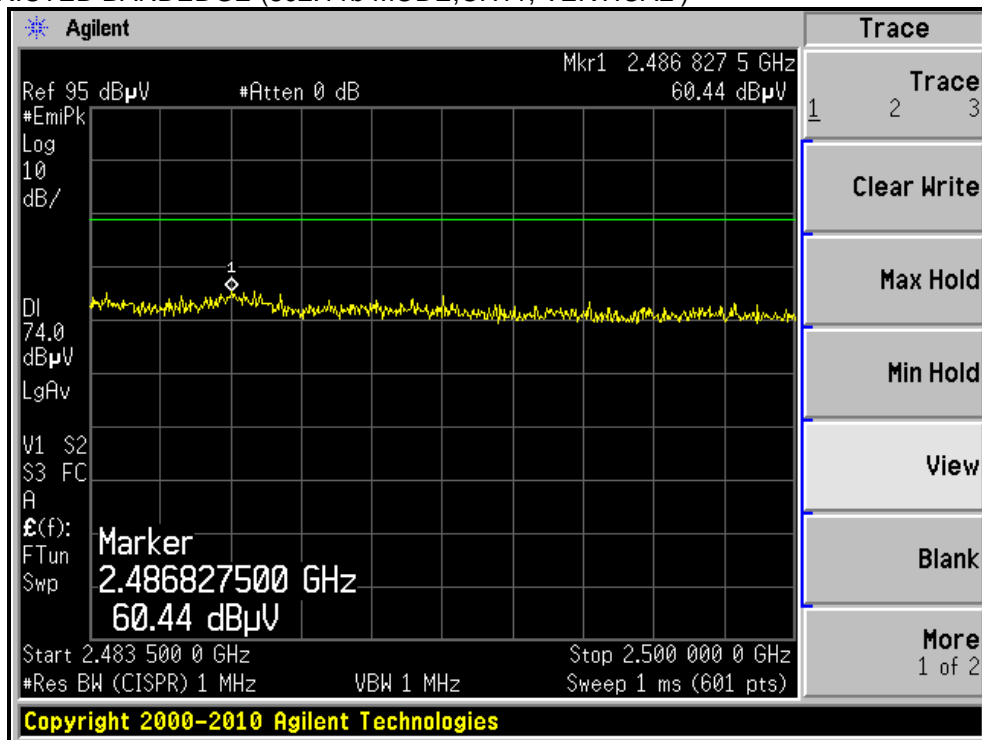



A D T

802.11g OFDM MODULATION <Single Chain (0)>

EUT TEST CONDITION		MEASUREMENT DETAIL	
CHANNEL	Channel 1	FREQUENCY RANGE	1 ~ 25GHz
INPUT POWER	120Vac, 60 Hz	DETECTOR FUNCTION	Peak (PK) Average (AV)
ENVIRONMENTAL CONDITIONS	24deg. C, 66%RH	TESTED BY	Evan Huang

ANTENNA POLARITY & TEST DISTANCE: HORIZONTAL AT 3 M								
NO.	FREQ. (MHz)	EMISSION LEVEL (dBuV/m)	LIMIT (dBuV/m)	MARGIN (dB)	ANTENNA HEIGHT (m)	TABLE ANGLE (Degree)	RAW VALUE (dBuV)	CORRECTION FACTOR (dB/m)
1	2390.00	64.3 PK	74.0	-9.7	1.16 H	23	32.42	31.88
2	2390.00	49.7 AV	54.0	-4.3	1.16 H	23	17.82	31.88
3	*2412.00	107.0 PK			1.10 H	25	75.05	31.95
4	*2412.00	94.9 AV			1.10 H	25	62.95	31.95
5	4824.00	50.7 PK	74.0	-23.3	1.18 H	309	9.48	41.22
6	4824.00	41.2 AV	54.0	-12.8	1.18 H	309	-0.02	41.22
ANTENNA POLARITY & TEST DISTANCE: VERTICAL AT 3 M								
NO.	FREQ. (MHz)	EMISSION LEVEL (dBuV/m)	LIMIT (dBuV/m)	MARGIN (dB)	ANTENNA HEIGHT (m)	TABLE ANGLE (Degree)	RAW VALUE (dBuV)	CORRECTION FACTOR (dB/m)
1	2390.00	72.8 PK	74.0	-1.2	1.15 V	344	40.92	31.88
2	2390.00	53.1 AV	54.0	-0.9	1.15 V	344	21.22	31.88
3	*2412.00	110.1 PK			1.20 V	346	78.15	31.95
4	*2412.00	98.2 AV			1.20 V	346	66.25	31.95
5	4824.00	51.3 PK	74.0	-22.7	1.18 V	308	10.08	41.22
6	4824.00	39.2 AV	54.0	-14.8	1.18 V	308	-2.02	41.22

- REMARKS:**
1. Emission level (dBuV/m) = Raw Value (dBuV) + Correction Factor (dB/m).
 2. Correction Factor (dB/m) = Antenna Factor (dB/m) + Cable Factor (dB).
 3. The other emission levels were very low against the limit.
 4. Margin value = Emission level – Limit value.
 5. “ * “: Fundamental frequency.



A D T

EUT TEST CONDITION		MEASUREMENT DETAIL	
CHANNEL	Channel 6	FREQUENCY RANGE	1 ~ 25GHz
INPUT POWER	120Vac, 60 Hz	DETECTOR FUNCTION	Peak (PK) Average (AV)
ENVIRONMENTAL CONDITIONS	24deg. C, 66%RH	TESTED BY	Evan Huang

ANTENNA POLARITY & TEST DISTANCE: HORIZONTAL AT 3 M								
NO.	FREQ. (MHz)	EMISSION LEVEL (dBuV/m)	LIMIT (dBuV/m)	MARGIN (dB)	ANTENNA HEIGHT (m)	TABLE ANGLE (Degree)	RAW VALUE (dBuV)	CORRECTION FACTOR (dB/m)
1	*2437.00	106.8 PK			1.16 H	24	74.76	32.04
2	*2437.00	96.9 AV			1.16 H	24	64.86	32.04
3	4874.00	52.7 PK	74.0	-21.3	1.05 H	320	11.34	41.36
4	4874.00	44.9 AV	54.0	-9.1	1.05 H	320	3.54	41.36
5	7311.00	58.8 PK	74.0	-15.2	1.05 H	140	13.13	45.67
6	7311.00	48.6 AV	54.0	-5.4	1.05 H	140	2.93	45.67
ANTENNA POLARITY & TEST DISTANCE: VERTICAL AT 3 M								
NO.	FREQ. (MHz)	EMISSION LEVEL (dBuV/m)	LIMIT (dBuV/m)	MARGIN (dB)	ANTENNA HEIGHT (m)	TABLE ANGLE (Degree)	RAW VALUE (dBuV)	CORRECTION FACTOR (dB/m)
1	2390.00	70.2 PK	74.0	-3.8	1.16 V	213	38.32	31.88
2	2390.00	50.2 AV	54.0	-3.8	1.16 V	213	18.32	31.88
3	*2437.00	114.6 PK			1.14 V	211	82.56	32.04
4	*2437.00	104.5 AV			1.14 V	211	72.46	32.04
5	2483.50	72.8 PK	74.0	-1.2	1.12 V	213	40.61	32.19
6	2483.50	52.6 AV	54.0	-1.4	1.12 V	213	20.41	32.19
7	4874.00	51.7 PK	74.0	-22.3	1.17 V	308	10.34	41.36
8	4874.00	40.8 AV	54.0	-13.2	1.17 V	308	-0.56	41.36
9	7311.00	51.4 PK	74.0	-22.6	1.00 V	6	5.73	45.67
10	7311.00	39.8 AV	54.0	-14.2	1.00 V	6	-5.87	45.67

- REMARKS:**
1. Emission level (dBuV/m) = Raw Value (dBuV) + Correction Factor (dB/m).
 2. Correction Factor (dB/m) = Antenna Factor (dB/m) + Cable Factor (dB).
 3. The other emission levels were very low against the limit.
 4. Margin value = Emission level – Limit value.
 5. “ * “: Fundamental frequency.



A D T

EUT TEST CONDITION		MEASUREMENT DETAIL	
CHANNEL	Channel 11	FREQUENCY RANGE	1 ~ 25GHz
INPUT POWER	120Vac, 60 Hz	DETECTOR FUNCTION	Peak (PK) Average (AV)
ENVIRONMENTAL CONDITIONS	24deg. C, 66%RH	TESTED BY	Evan Huang

ANTENNA POLARITY & TEST DISTANCE: HORIZONTAL AT 3 M

NO.	FREQ. (MHz)	EMISSION LEVEL (dBuV/m)	LIMIT (dBuV/m)	MARGIN (dB)	ANTENNA HEIGHT (m)	TABLE ANGLE (Degree)	RAW VALUE (dBuV)	CORRECTION FACTOR (dB/m)
1	*2462.00	103.0 PK			1.00 H	20	70.88	32.12
2	*2462.00	92.6 AV			1.00 H	20	60.48	32.12
3	2483.50	61.0 PK	74.0	-13.0	1.13 H	23	28.81	32.19
4	2483.50	45.4 AV	54.0	-8.6	1.13 H	23	13.21	32.19
5	4924.00	49.4 PK	74.0	-24.6	1.05 H	319	7.92	41.48
6	4924.00	38.8 AV	54.0	-15.2	1.05 H	319	-2.68	41.48
7	7386.00	51.1 PK	74.0	-22.9	1.07 H	141	5.19	45.91
8	7386.00	39.9 AV	54.0	-14.1	1.07 H	141	-6.01	45.91

ANTENNA POLARITY & TEST DISTANCE: VERTICAL AT 3 M

NO.	FREQ. (MHz)	EMISSION LEVEL (dBuV/m)	LIMIT (dBuV/m)	MARGIN (dB)	ANTENNA HEIGHT (m)	TABLE ANGLE (Degree)	RAW VALUE (dBuV)	CORRECTION FACTOR (dB/m)
1	*2462.00	107.5 PK			1.15 V	189	75.38	32.12
2	*2462.00	96.2 AV			1.15 V	189	64.08	32.12
3	2483.50	66.1 PK	74.0	-7.9	1.09 V	209	33.91	32.19
4	2483.50	48.8 AV	54.0	-5.2	1.09 V	209	16.61	32.19
5	4924.00	48.3 PK	74.0	-25.7	1.18 V	311	6.82	41.48
6	4924.00	37.7 AV	54.0	-16.3	1.18 V	311	-3.78	41.48
7	7386.00	50.4 PK	74.0	-23.6	1.00 V	7	4.49	45.91
8	7386.00	38.6 AV	54.0	-15.4	1.00 V	7	-7.31	45.91

- REMARKS:**
1. Emission level (dBuV/m) = Raw Value (dBuV) + Correction Factor (dB/m).
 2. Correction Factor (dB/m) = Antenna Factor (dB/m) + Cable Factor (dB).
 3. The other emission levels were very low against the limit.
 4. Margin value = Emission level – Limit value.
 5. “ * “: Fundamental frequency.



A D T

RESTRICTED BANDEDGE (802.11g MODE, CH1, HORIZONTAL)

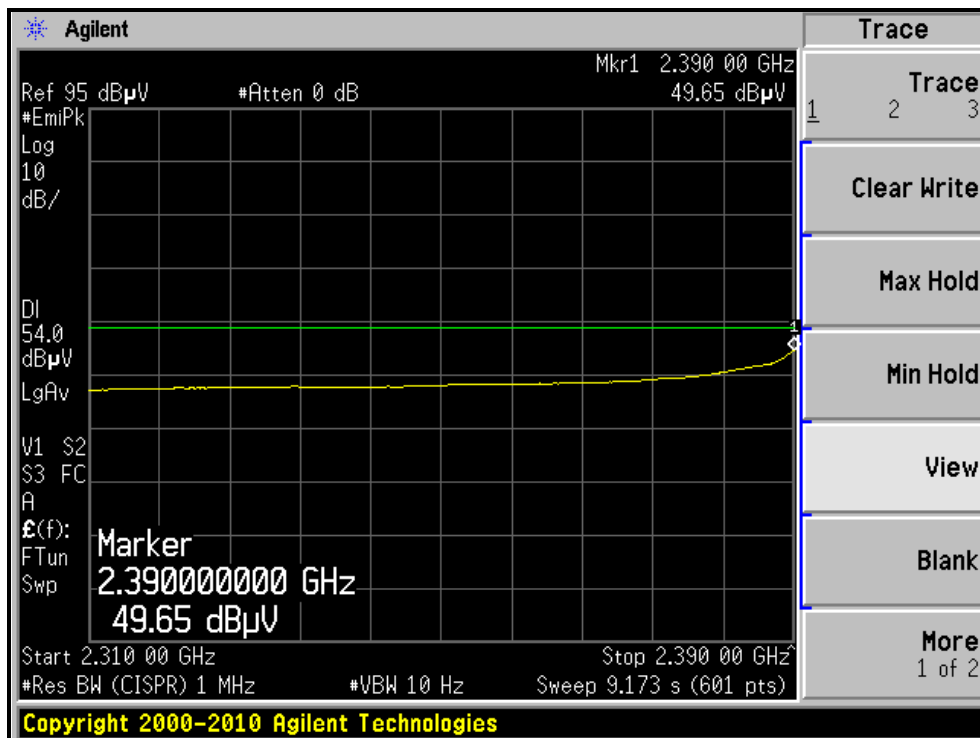
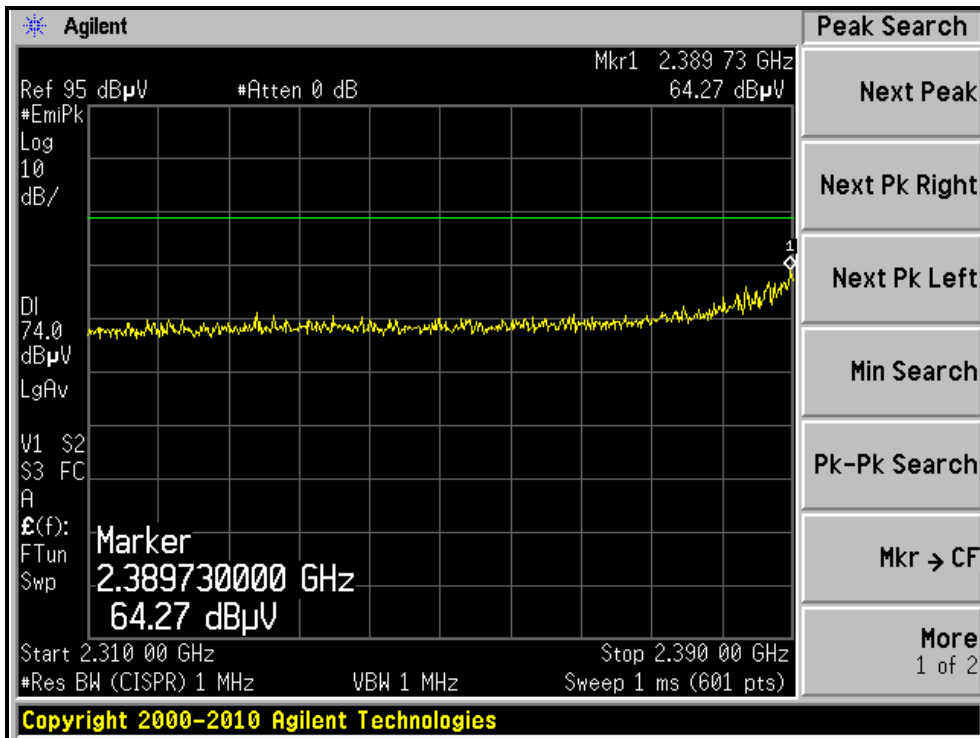



A D T

RESTRICTED BANDEDGE (802.11g MODE,CH1, VERTICAL)

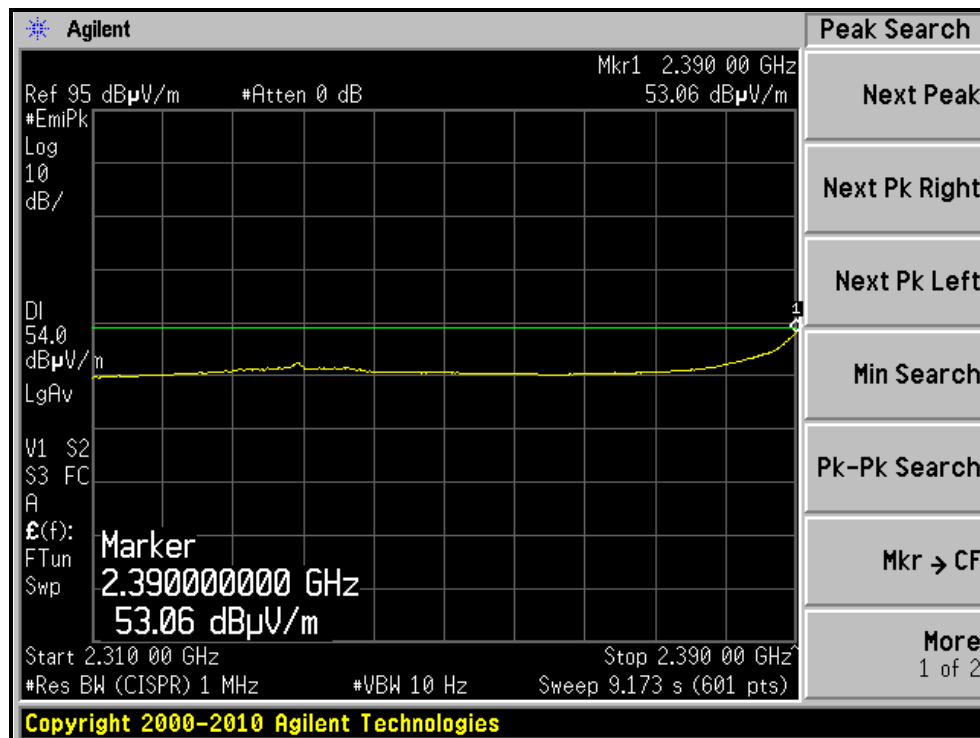
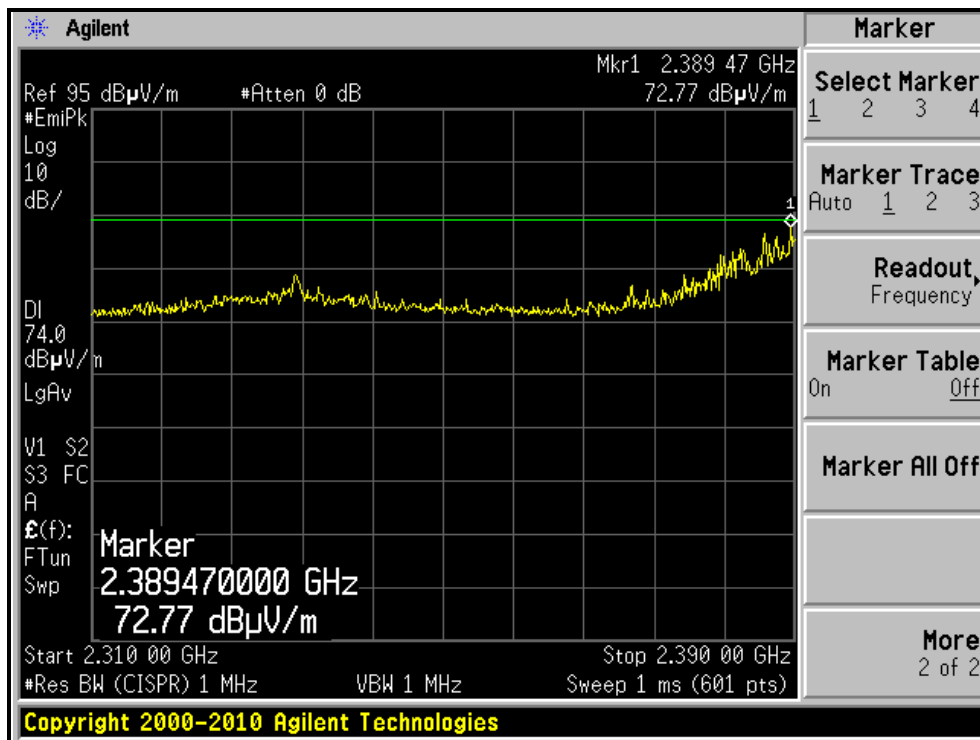



A D T

RESTRICTED BANDEDGE (802.11g MODE, CH11, HORIZONTAL)

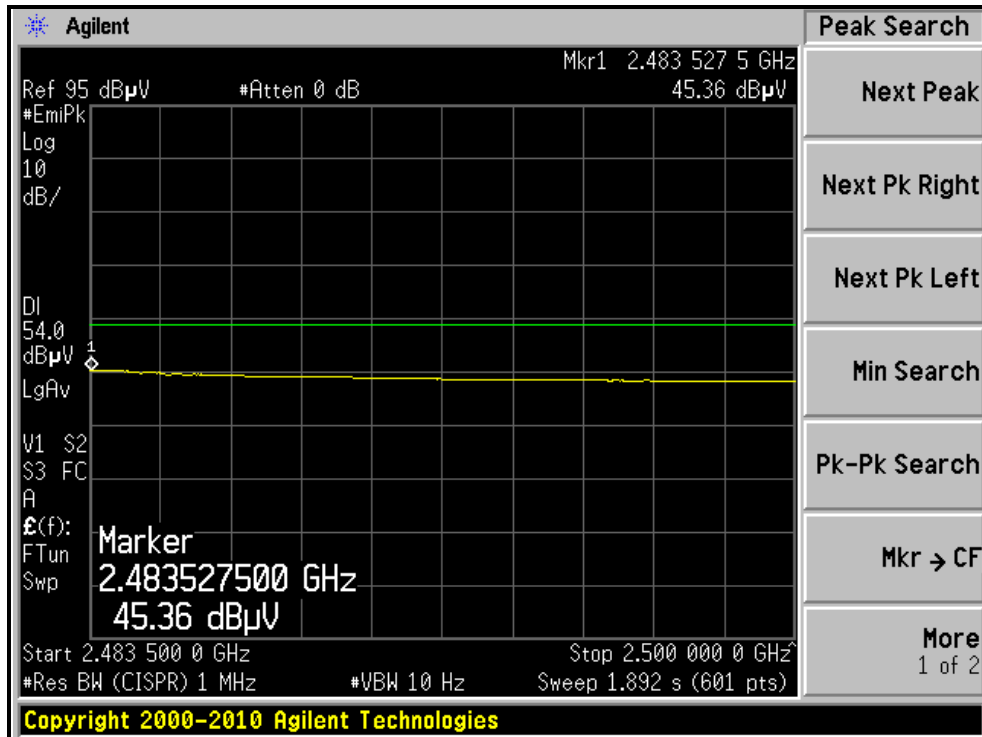
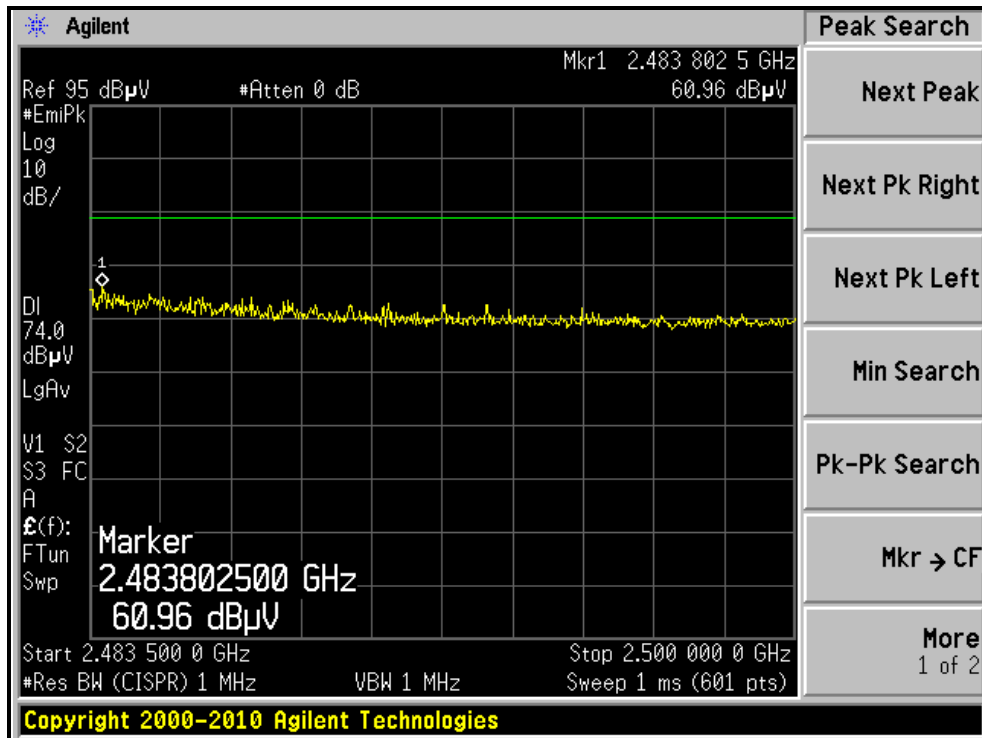



A D T

RESTRICTED BANDEDGE (802.11g MODE, CH11, VERTICAL)

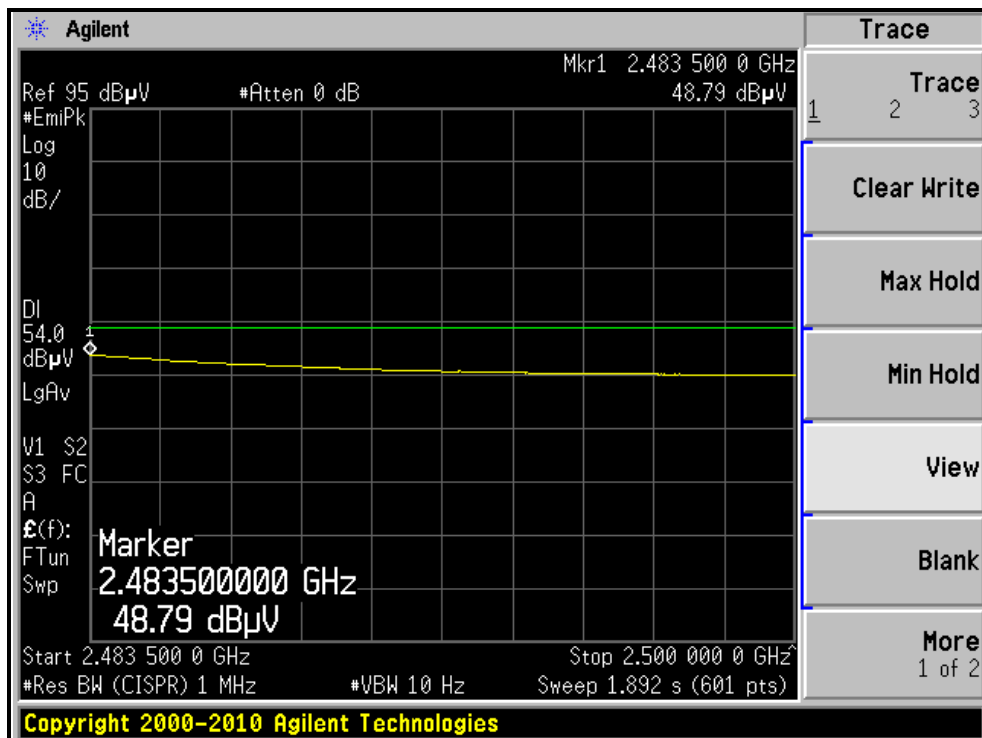
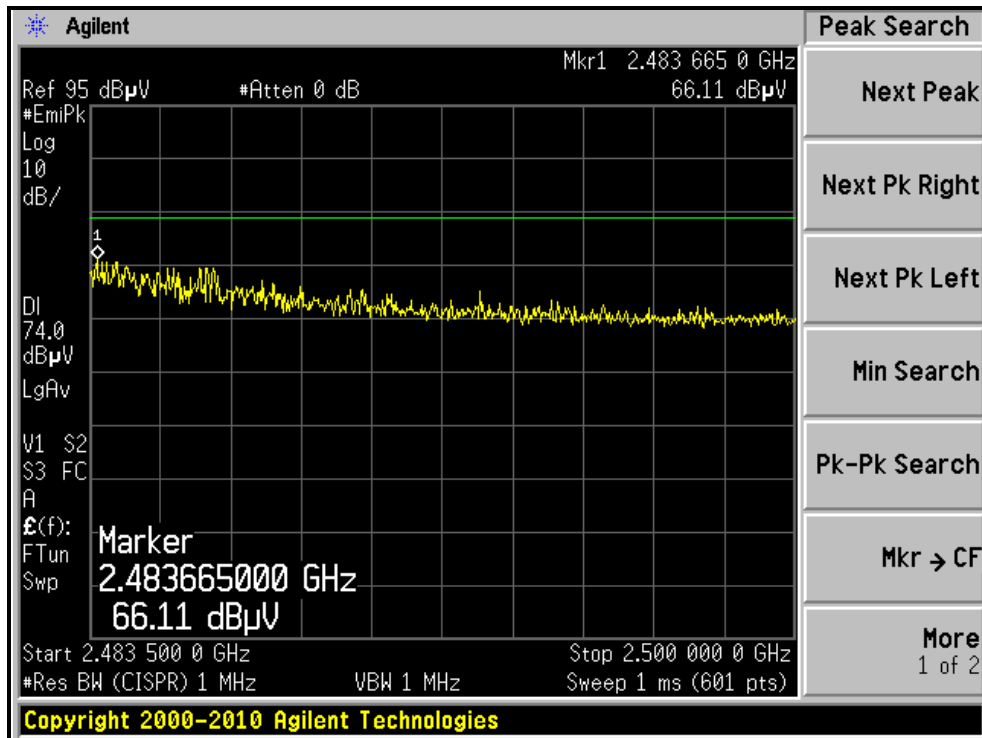



A D T

802.11g OFDM MODULATION <Single Chain (1)>

EUT TEST CONDITION		MEASUREMENT DETAIL	
CHANNEL	Channel 1	FREQUENCY RANGE	1 ~ 25GHz
INPUT POWER	120Vac, 60 Hz	DETECTOR FUNCTION	Peak (PK) Average (AV)
ENVIRONMENTAL CONDITIONS	24deg. C, 66%RH	TESTED BY	Evan Huang

ANTENNA POLARITY & TEST DISTANCE: HORIZONTAL AT 3 M								
NO.	FREQ. (MHz)	EMISSION LEVEL (dBuV/m)	LIMIT (dBuV/m)	MARGIN (dB)	ANTENNA HEIGHT (m)	TABLE ANGLE (Degree)	RAW VALUE (dBuV)	CORRECTION FACTOR (dB/m)
1	2390.00	70.0 PK	74.0	-4.0	1.45 H	322	38.12	31.88
2	2390.00	53.3 AV	54.0	-0.7	1.45 H	322	21.42	31.88
3	*2412.00	113.2 PK			1.43 H	322	81.25	31.95
4	*2412.00	101.3 AV			1.43 H	322	69.35	31.95
5	4824.00	49.8 PK	74.0	-24.2	1.15 H	60	8.58	41.22
6	4824.00	39.2 AV	54.0	-14.8	1.15 H	60	-2.02	41.22
ANTENNA POLARITY & TEST DISTANCE: VERTICAL AT 3 M								
NO.	FREQ. (MHz)	EMISSION LEVEL (dBuV/m)	LIMIT (dBuV/m)	MARGIN (dB)	ANTENNA HEIGHT (m)	TABLE ANGLE (Degree)	RAW VALUE (dBuV)	CORRECTION FACTOR (dB/m)
1	2390.00	69.3 PK	74.0	-4.7	1.45 V	88	37.42	31.88
2	2390.00	50.6 AV	54.0	-3.4	1.45 V	88	18.72	31.88
3	*2412.00	105.9 PK			1.29 V	315	73.95	31.95
4	*2412.00	94.5 AV			1.29 V	315	62.55	31.95
5	4824.00	48.6 PK	74.0	-25.4	1.25 V	265	7.38	41.22
6	4824.00	36.7 AV	54.0	-17.3	1.25 V	265	-4.52	41.22

- REMARKS:**
1. Emission level (dBuV/m) = Raw Value (dBuV) + Correction Factor (dB/m).
 2. Correction Factor (dB/m) = Antenna Factor (dB/m) + Cable Factor (dB).
 3. The other emission levels were very low against the limit.
 4. Margin value = Emission level – Limit value.
 5. “ * “: Fundamental frequency.



A D T

EUT TEST CONDITION		MEASUREMENT DETAIL	
CHANNEL	Channel 6	FREQUENCY RANGE	1 ~ 25GHz
INPUT POWER	120Vac, 60 Hz	DETECTOR FUNCTION	Peak (PK) Average (AV)
ENVIRONMENTAL CONDITIONS	24deg. C, 66%RH	TESTED BY	Evan Huang

ANTENNA POLARITY & TEST DISTANCE: HORIZONTAL AT 3 M								
NO.	FREQ. (MHz)	EMISSION LEVEL (dBuV/m)	LIMIT (dBuV/m)	MARGIN (dB)	ANTENNA HEIGHT (m)	TABLE ANGLE (Degree)	RAW VALUE (dBuV)	CORRECTION FACTOR (dB/m)
1	2390.00	69.1 PK	74.0	-4.9	1.66 H	52	37.22	31.88
2	2390.00	52.5 AV	54.0	-1.5	1.66 H	52	20.62	31.88
3	*2437.00	118.1 PK			1.38 H	52	86.06	32.04
4	*2437.00	106.1 AV			1.38 H	52	74.06	32.04
5	2483.50	69.9 PK	74.0	-4.1	1.63 H	54	37.71	32.19
6	2483.50	53.1 AV	54.0	-0.9	1.63 H	54	20.91	32.19
7	4874.00	52.8 PK	74.0	-21.2	1.13 H	61	11.44	41.36
8	4874.00	40.8 AV	54.0	-13.2	1.13 H	61	-0.56	41.36
9	7311.00	52.4 PK	74.0	-21.6	1.27 H	50	6.73	45.67
10	7311.00	40.1 AV	54.0	-13.9	1.27 H	50	-5.57	45.67
ANTENNA POLARITY & TEST DISTANCE: VERTICAL AT 3 M								
NO.	FREQ. (MHz)	EMISSION LEVEL (dBuV/m)	LIMIT (dBuV/m)	MARGIN (dB)	ANTENNA HEIGHT (m)	TABLE ANGLE (Degree)	RAW VALUE (dBuV)	CORRECTION FACTOR (dB/m)
1	*2437.00	112.5 PK			1.46 V	94	80.46	32.04
2	*2437.00	102.2 AV			1.46 V	94	70.16	32.04
3	4874.00	50.1 PK	74.0	-23.9	1.24 V	264	8.74	41.36
4	4874.00	38.1 AV	54.0	-15.9	1.24 V	264	-3.26	41.36
5	7311.00	55.1 PK	74.0	-18.9	1.04 V	358	9.43	45.67
6	7311.00	42.5 AV	54.0	-11.5	1.04 V	358	-3.17	45.67

- REMARKS:**
1. Emission level (dBuV/m) = Raw Value (dBuV) + Correction Factor (dB/m).
 2. Correction Factor (dB/m) = Antenna Factor (dB/m) + Cable Factor (dB).
 3. The other emission levels were very low against the limit.
 4. Margin value = Emission level – Limit value.
 5. “ * “: Fundamental frequency.



A D T

EUT TEST CONDITION		MEASUREMENT DETAIL	
CHANNEL	Channel 11	FREQUENCY RANGE	1 ~ 25GHz
INPUT POWER	120Vac, 60 Hz	DETECTOR FUNCTION	Peak (PK) Average (AV)
ENVIRONMENTAL CONDITIONS	24deg. C, 66%RH	TESTED BY	Evan Huang

ANTENNA POLARITY & TEST DISTANCE: HORIZONTAL AT 3 M								
NO.	FREQ. (MHz)	EMISSION LEVEL (dBuV/m)	LIMIT (dBuV/m)	MARGIN (dB)	ANTENNA HEIGHT (m)	TABLE ANGLE (Degree)	RAW VALUE (dBuV)	CORRECTION FACTOR (dB/m)
1	*2462.00	110.6 PK			1.37 H	54	78.48	32.12
2	*2462.00	99.5 AV			1.37 H	54	67.38	32.12
3	2483.50	72.4 PK	74.0	-1.6	1.61 H	54	40.21	32.19
4	2483.50	51.2 AV	54.0	-2.8	1.61 H	54	19.01	32.19
5	4924.00	49.3 PK	74.0	-24.7	1.14 H	62	7.82	41.48
6	4924.00	38.1 AV	54.0	-15.9	1.14 H	62	-3.38	41.48
7	7386.00	51.5 PK	74.0	-22.5	1.28 H	52	5.59	45.91
8	7386.00	40.2 AV	54.0	-13.8	1.28 H	52	-5.71	45.91
ANTENNA POLARITY & TEST DISTANCE: VERTICAL AT 3 M								
NO.	FREQ. (MHz)	EMISSION LEVEL (dBuV/m)	LIMIT (dBuV/m)	MARGIN (dB)	ANTENNA HEIGHT (m)	TABLE ANGLE (Degree)	RAW VALUE (dBuV)	CORRECTION FACTOR (dB/m)
1	*2462.00	106.5 PK			1.46 V	83	74.38	32.12
2	*2462.00	96.7 AV			1.46 V	83	64.58	32.12
3	2483.50	68.0 PK	74.0	-6.0	1.48 V	87	35.81	32.19
4	2483.50	48.4 AV	54.0	-5.6	1.48 V	87	16.21	32.19
5	4924.00	47.5 PK	74.0	-26.5	1.22 V	254	6.02	41.48
6	4924.00	36.1 AV	54.0	-17.9	1.22 V	254	-5.38	41.48
7	7386.00	52.2 PK	74.0	-21.8	1.04 V	2	6.29	45.91
8	7386.00	39.6 AV	54.0	-14.4	1.04 V	2	-6.31	45.91

- REMARKS:**
1. Emission level (dBuV/m) = Raw Value (dBuV) + Correction Factor (dB/m).
 2. Correction Factor (dB/m) = Antenna Factor (dB/m) + Cable Factor (dB).
 3. The other emission levels were very low against the limit.
 4. Margin value = Emission level – Limit value.
 5. “ * “: Fundamental frequency.



A D T

RESTRICTED BANDEDGE (802.11g MODE, CH1, HORIZONTAL)

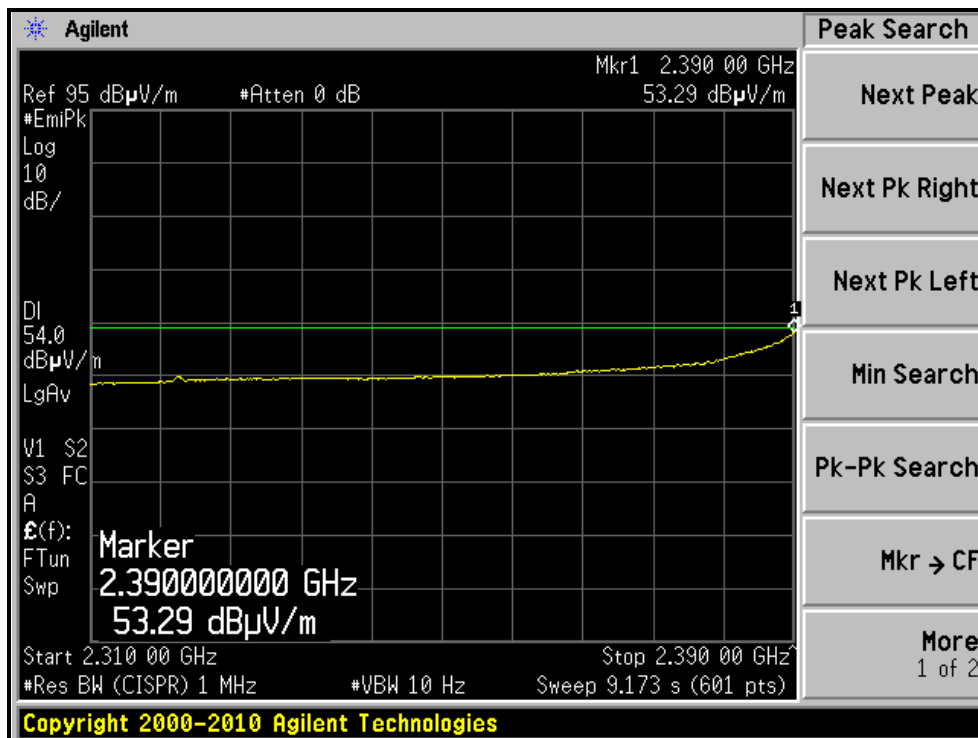
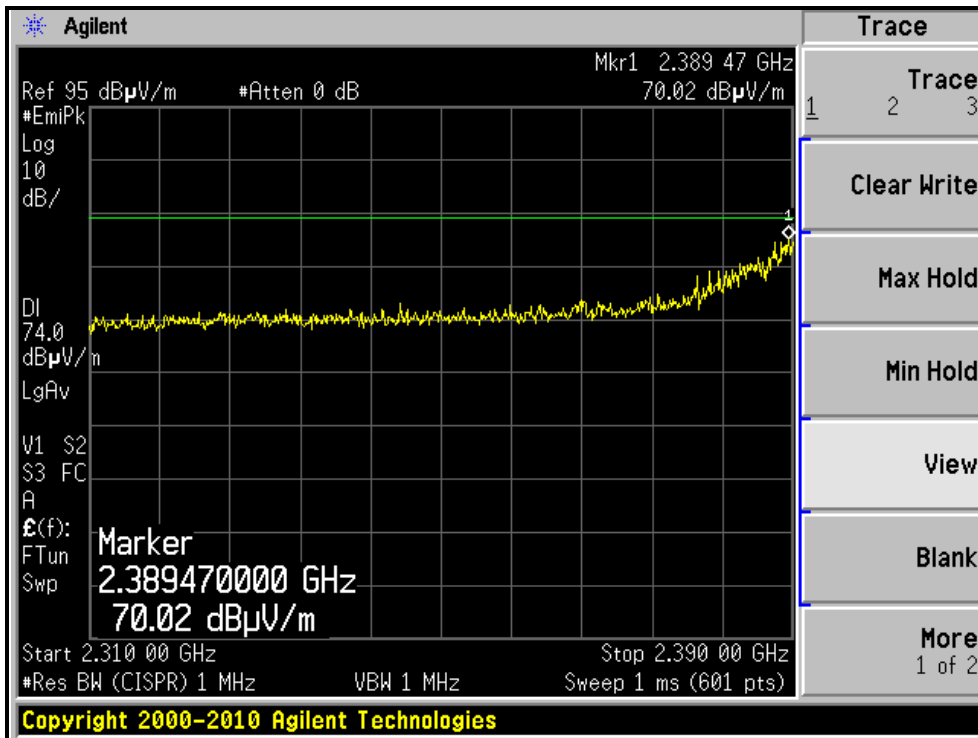

RESTRICTED BANDEDGE (802.11g MODE,CH1, VERTICAL)

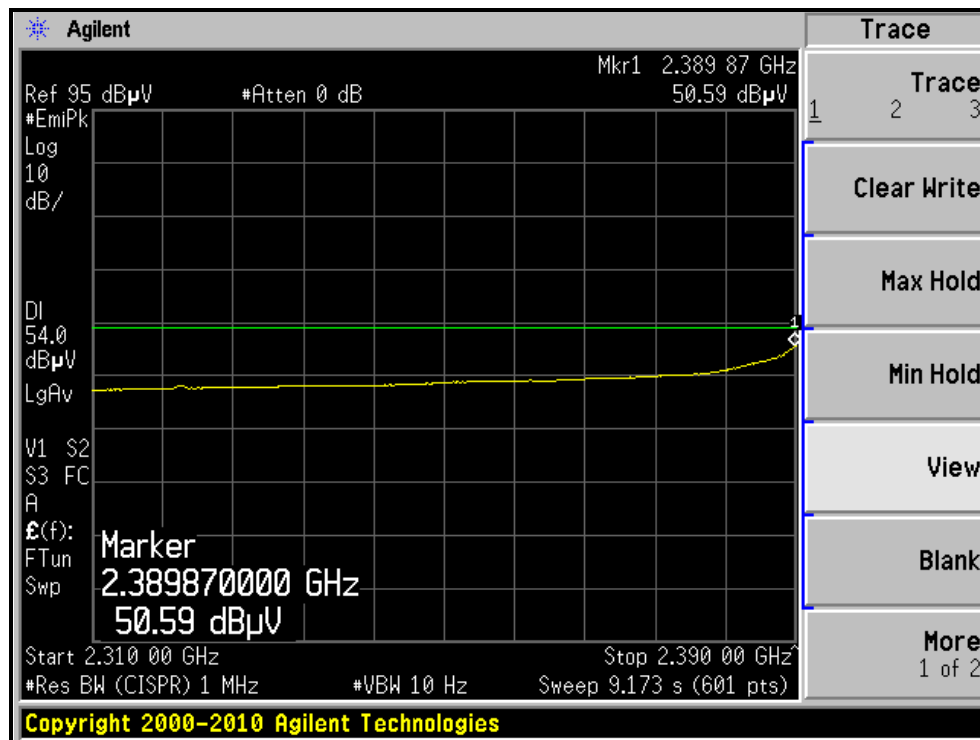
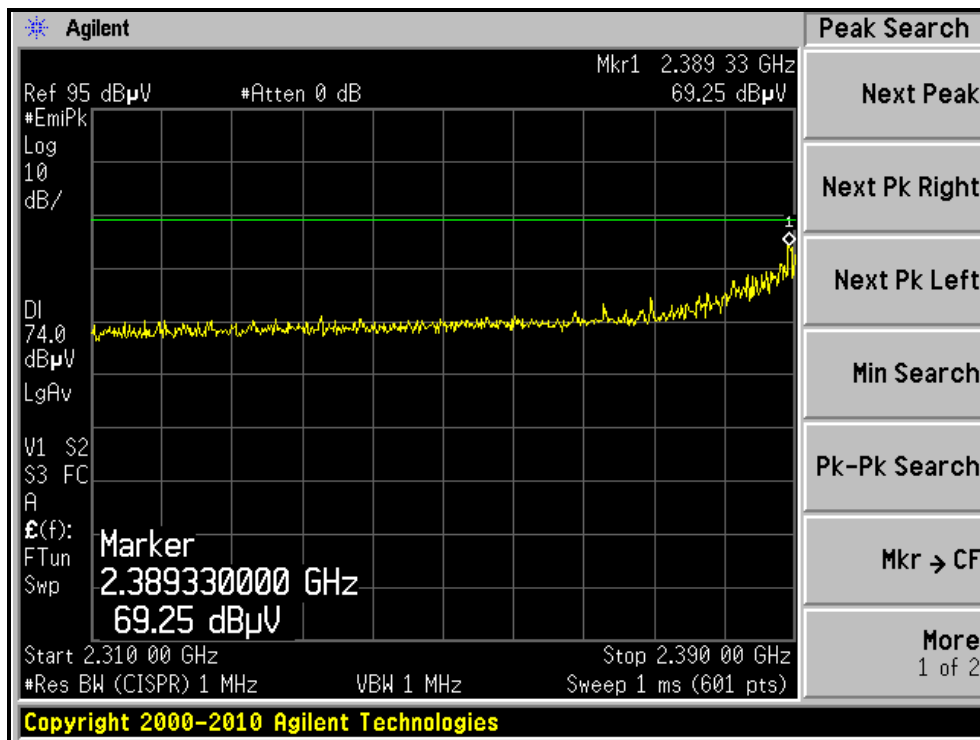



A D T

RESTRICTED BANDEDGE (802.11g MODE,CH11, HORIZONTAL)

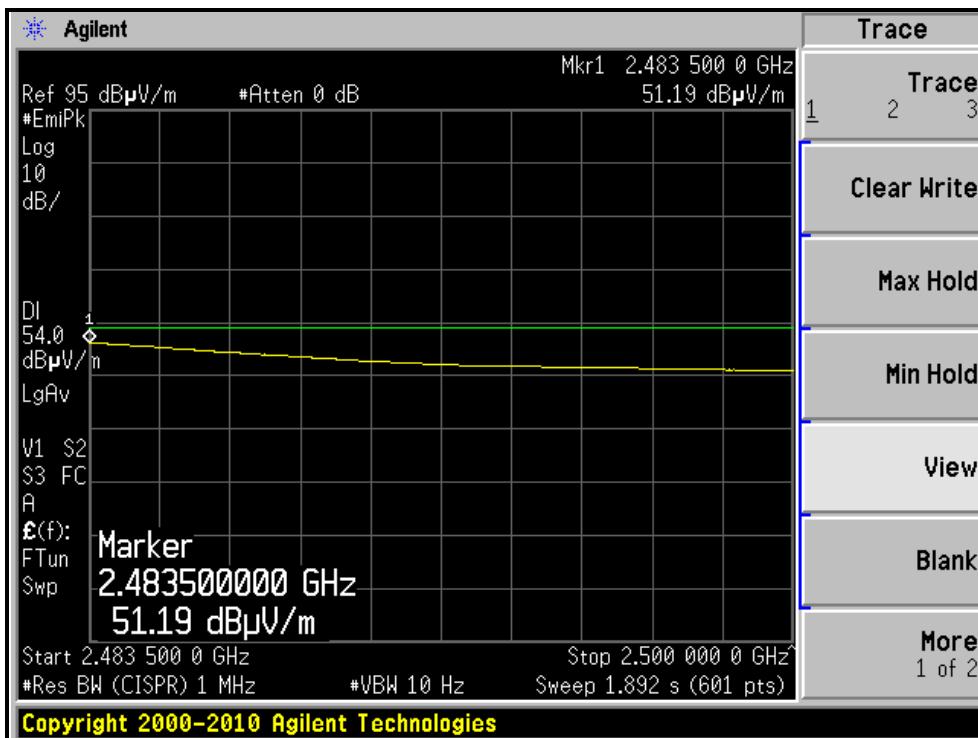
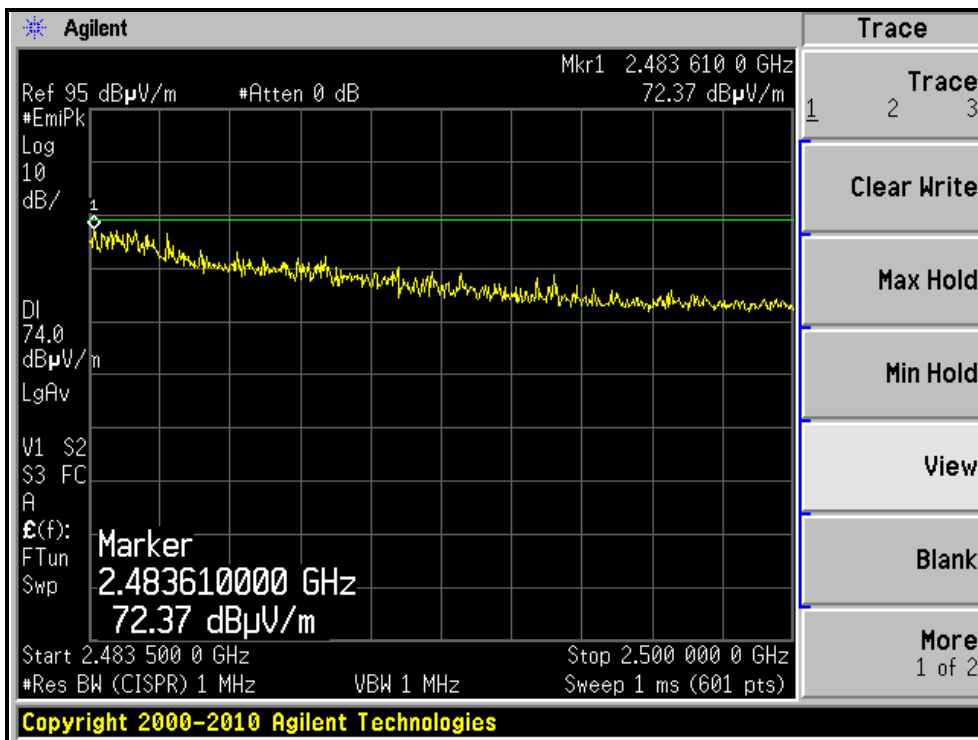

RESTRICTED BANDEDGE (802.11g MODE,CH11, VERTICAL)

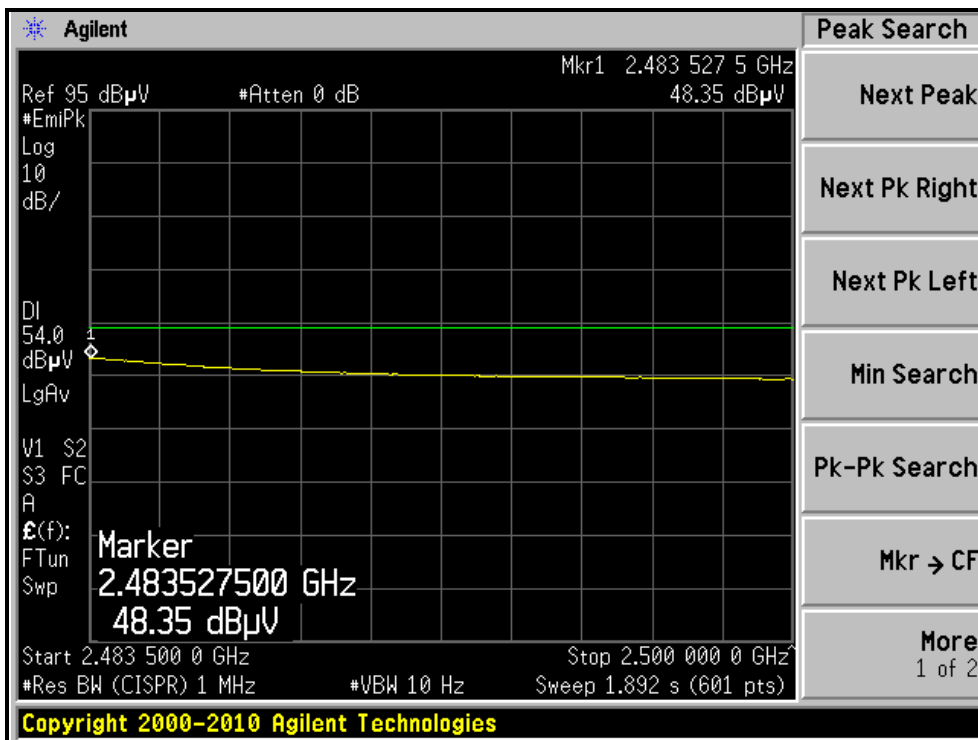
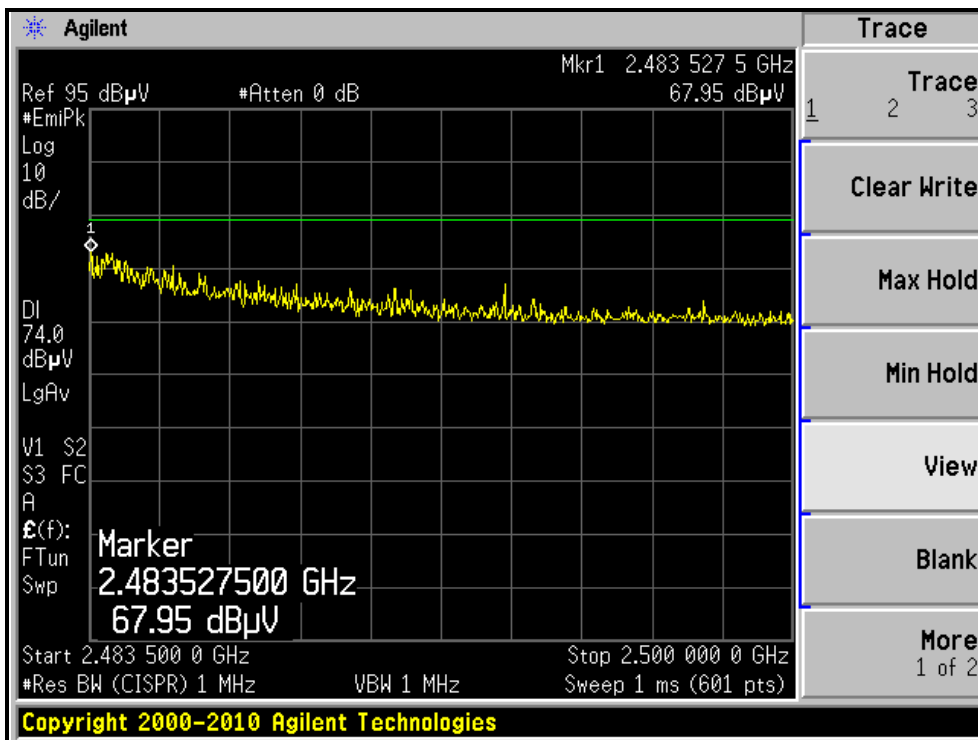



A D T

802.11n (20MHz) OFDM MODULATION <Single Chain (0)>

EUT TEST CONDITION		MEASUREMENT DETAIL	
CHANNEL	Channel 1	FREQUENCY RANGE	1 ~ 25GHz
INPUT POWER	120Vac, 60 Hz	DETECTOR FUNCTION	Peak (PK) Average (AV)
ENVIRONMENTAL CONDITIONS	24deg. C, 66%RH	TESTED BY	Evan Huang

ANTENNA POLARITY & TEST DISTANCE: HORIZONTAL AT 3 M								
NO.	FREQ. (MHz)	EMISSION LEVEL (dBuV/m)	LIMIT (dBuV/m)	MARGIN (dB)	ANTENNA HEIGHT (m)	TABLE ANGLE (Degree)	RAW VALUE (dBuV)	CORRECTION FACTOR (dB/m)
1	2390.00	64.0 PK	74.0	-10.0	1.00 H	19	32.12	31.88
2	2390.00	50.1 AV	54.0	-3.9	1.00 H	19	18.22	31.88
3	*2412.00	103.8 PK			1.00 H	20	71.85	31.95
4	*2412.00	92.7 AV			1.00 H	20	60.75	31.95
5	4824.00	49.8 PK	74.0	-24.2	1.05 H	323	8.58	41.22
6	4824.00	38.0 AV	54.0	-16.0	1.05 H	323	-3.22	41.22
ANTENNA POLARITY & TEST DISTANCE: VERTICAL AT 3 M								
NO.	FREQ. (MHz)	EMISSION LEVEL (dBuV/m)	LIMIT (dBuV/m)	MARGIN (dB)	ANTENNA HEIGHT (m)	TABLE ANGLE (Degree)	RAW VALUE (dBuV)	CORRECTION FACTOR (dB/m)
1	2390.00	69.7 PK	74.0	-4.3	1.15 V	215	37.82	31.88
2	2390.00	53.3 AV	54.0	-0.7	1.15 V	215	21.42	31.88
3	*2412.00	109.6 PK			1.16 V	180	77.65	31.95
4	*2412.00	99.0 AV			1.16 V	180	67.05	31.95
5	4824.00	49.9 PK	74.0	-24.1	1.19 V	70	8.68	41.22
6	4824.00	38.5 AV	54.0	-15.5	1.19 V	70	-2.72	41.22

- REMARKS:**
1. Emission level (dBuV/m) = Raw Value (dBuV) + Correction Factor (dB/m).
 2. Correction Factor (dB/m) = Antenna Factor (dB/m) + Cable Factor (dB).
 3. The other emission levels were very low against the limit.
 4. Margin value = Emission level – Limit value.
 5. “ * “: Fundamental frequency.



A D T

EUT TEST CONDITION		MEASUREMENT DETAIL	
CHANNEL	Channel 6	FREQUENCY RANGE	1 ~ 25GHz
INPUT POWER	120Vac, 60 Hz	DETECTOR FUNCTION	Peak (PK) Average (AV)
ENVIRONMENTAL CONDITIONS	24deg. C, 66%RH	TESTED BY	Evan Huang

ANTENNA POLARITY & TEST DISTANCE: HORIZONTAL AT 3 M

NO.	FREQ. (MHz)	EMISSION LEVEL (dBuV/m)	LIMIT (dBuV/m)	MARGIN (dB)	ANTENNA HEIGHT (m)	TABLE ANGLE (Degree)	RAW VALUE (dBuV)	CORRECTION FACTOR (dB/m)
1	*2437.00	108.0 PK			1.00 H	20	75.96	32.04
2	*2437.00	97.3 AV			1.00 H	20	65.26	32.04
3	4874.00	51.9 PK	74.0	-22.1	1.06 H	310	10.54	41.36
4	4874.00	41.3 AV	54.0	-12.7	1.06 H	310	-0.06	41.36
5	7311.00	52.1 PK	74.0	-21.9	1.08 H	143	6.43	45.67
6	7311.00	40.0 AV	54.0	-14.0	1.08 H	143	-5.67	45.67

ANTENNA POLARITY & TEST DISTANCE: VERTICAL AT 3 M

NO.	FREQ. (MHz)	EMISSION LEVEL (dBuV/m)	LIMIT (dBuV/m)	MARGIN (dB)	ANTENNA HEIGHT (m)	TABLE ANGLE (Degree)	RAW VALUE (dBuV)	CORRECTION FACTOR (dB/m)
1	2390.00	69.1 PK	74.0	-4.9	1.14 V	189	37.22	31.88
2	2390.00	49.8 AV	54.0	-4.2	1.14 V	189	17.92	31.88
3	*2437.00	114.1 PK			1.19 V	16	82.06	32.04
4	*2437.00	104.3 AV			1.19 V	16	72.26	32.04
5	2483.50	71.6 PK	74.0	-2.4	1.15 V	201	39.41	32.19
6	2483.50	50.4 AV	54.0	-3.6	1.15 V	201	18.21	32.19
7	4874.00	51.6 PK	74.0	-22.4	1.18 V	311	10.24	41.36
8	4874.00	40.5 AV	54.0	-13.5	1.18 V	311	-0.86	41.36
9	7311.00	51.6 PK	74.0	-22.4	1.00 V	6	5.93	45.67
10	7311.00	39.9 AV	54.0	-14.1	1.00 V	6	-5.77	45.67

- REMARKS:**
1. Emission level (dBuV/m) = Raw Value (dBuV) + Correction Factor (dB/m).
 2. Correction Factor (dB/m) = Antenna Factor (dB/m) + Cable Factor (dB).
 3. The other emission levels were very low against the limit.
 4. Margin value = Emission level – Limit value.
 5. “ * “: Fundamental frequency.



A D T

EUT TEST CONDITION		MEASUREMENT DETAIL	
CHANNEL	Channel 11	FREQUENCY RANGE	1 ~ 25GHz
INPUT POWER	120Vac, 60 Hz	DETECTOR FUNCTION	Peak (PK) Average (AV)
ENVIRONMENTAL CONDITIONS	24deg. C, 66%RH	TESTED BY	Evan Huang

ANTENNA POLARITY & TEST DISTANCE: HORIZONTAL AT 3 M								
NO.	FREQ. (MHz)	EMISSION LEVEL (dBuV/m)	LIMIT (dBuV/m)	MARGIN (dB)	ANTENNA HEIGHT (m)	TABLE ANGLE (Degree)	RAW VALUE (dBuV)	CORRECTION FACTOR (dB/m)
1	*2462.00	102.0 PK			1.00 H	20	69.88	32.12
2	*2462.00	91.4 AV			1.00 H	20	59.28	32.12
3	2483.50	61.0 PK	74.0	-13.0	1.00 H	19	28.81	32.19
4	2483.50	45.3 AV	54.0	-8.7	1.00 H	19	13.11	32.19
5	4924.00	48.3 PK	74.0	-25.7	1.00 H	333	6.82	41.48
6	4924.00	38.3 AV	54.0	-15.7	1.00 H	333	-3.18	41.48
7	7386.00	50.9 PK	74.0	-23.1	1.09 H	141	4.99	45.91
8	7386.00	39.8 AV	54.0	-14.2	1.09 H	141	-6.11	45.91
ANTENNA POLARITY & TEST DISTANCE: VERTICAL AT 3 M								
NO.	FREQ. (MHz)	EMISSION LEVEL (dBuV/m)	LIMIT (dBuV/m)	MARGIN (dB)	ANTENNA HEIGHT (m)	TABLE ANGLE (Degree)	RAW VALUE (dBuV)	CORRECTION FACTOR (dB/m)
1	*2462.00	108.8 PK			1.13 V	216	76.68	32.12
2	*2462.00	97.5 AV			1.13 V	216	65.38	32.12
3	2483.50	71.0 PK	74.0	-3.0	1.66 V	271	38.81	32.19
4	2483.50	50.0 AV	54.0	-4.0	1.66 V	271	17.81	32.19
5	4924.00	47.4 PK	74.0	-26.6	1.19 V	310	5.92	41.48
6	4924.00	37.3 AV	54.0	-16.7	1.19 V	310	-4.18	41.48
7	7386.00	49.1 PK	74.0	-24.9	1.00 V	9	3.19	45.91
8	7386.00	37.9 AV	54.0	-16.1	1.00 V	9	-8.01	45.91

- REMARKS:**
1. Emission level (dBuV/m) = Raw Value (dBuV) + Correction Factor (dB/m).
 2. Correction Factor (dB/m) = Antenna Factor (dB/m) + Cable Factor (dB).
 3. The other emission levels were very low against the limit.
 4. Margin value = Emission level – Limit value.
 5. “ * “: Fundamental frequency.



A D T

RESTRICTED BANDEDGE (802.11n (20MHz) MODE,CH1, HORIZONTAL)

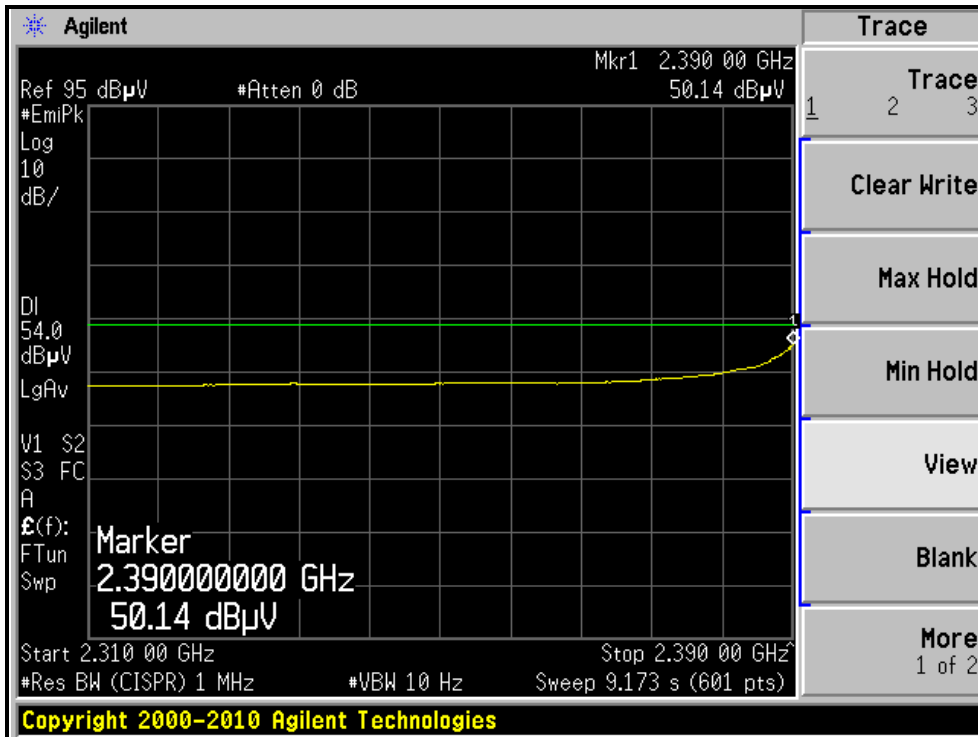
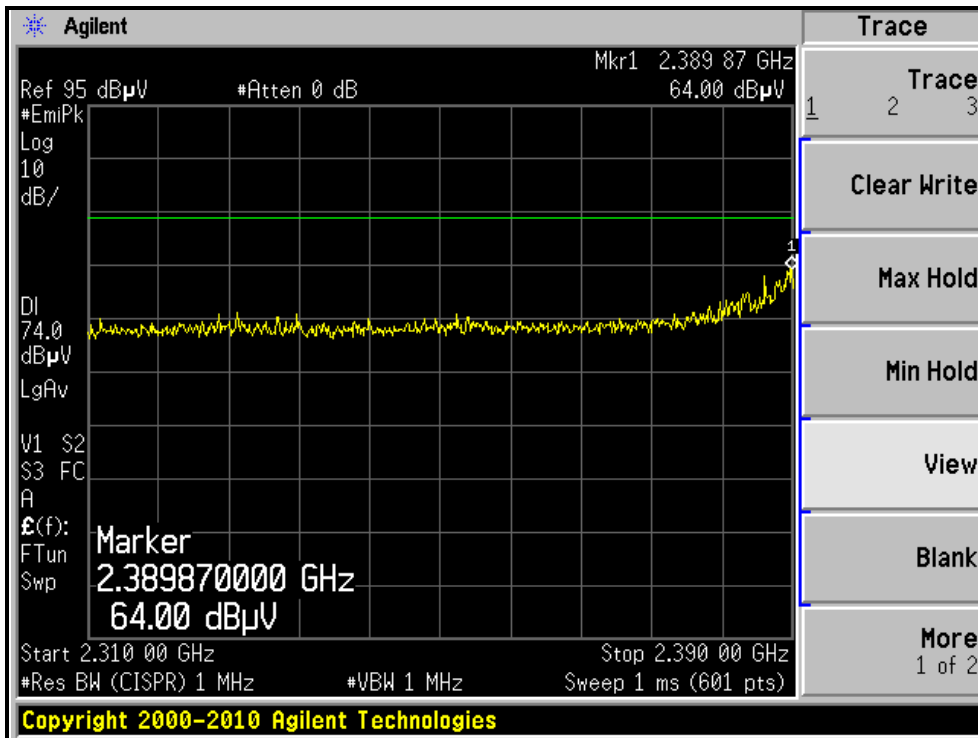



A D T

RESTRICTED BANDEDGE (802.11n (20MHz) MODE,CH1, VERTICAL)

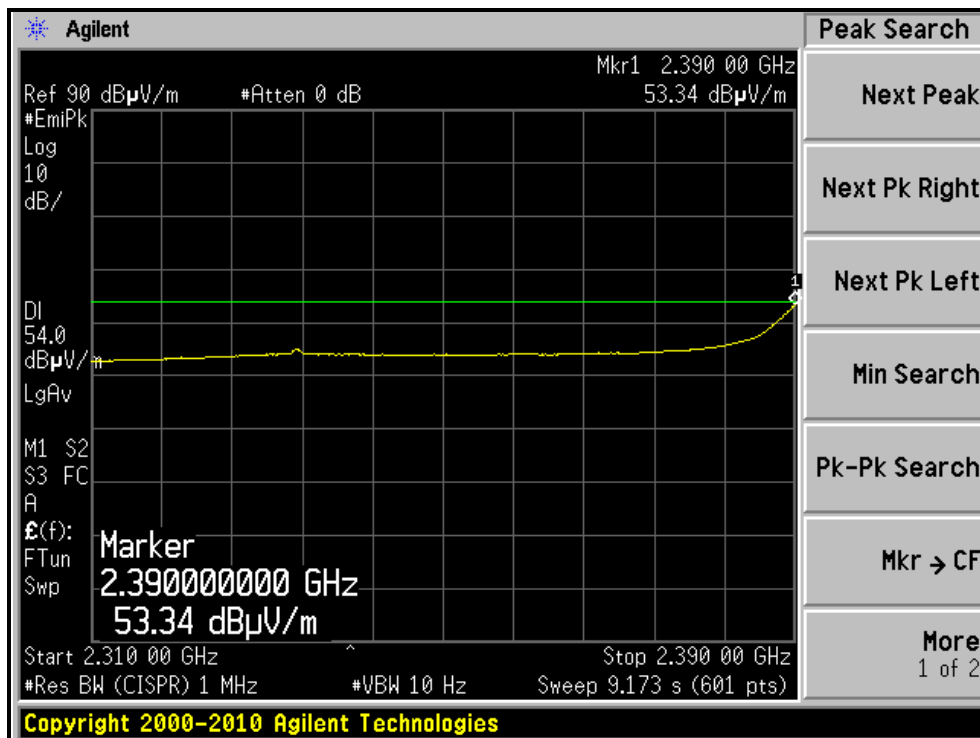
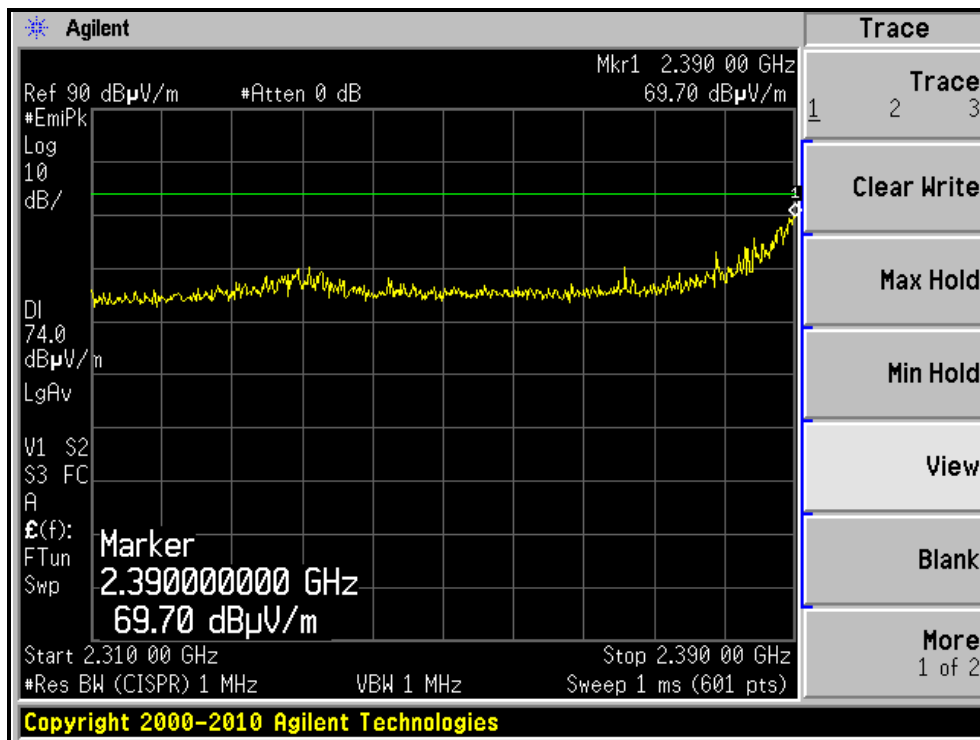



A D T

RESTRICTED BANDEDGE (802.11n (20MHz) MODE,CH11, HORIZONTAL)

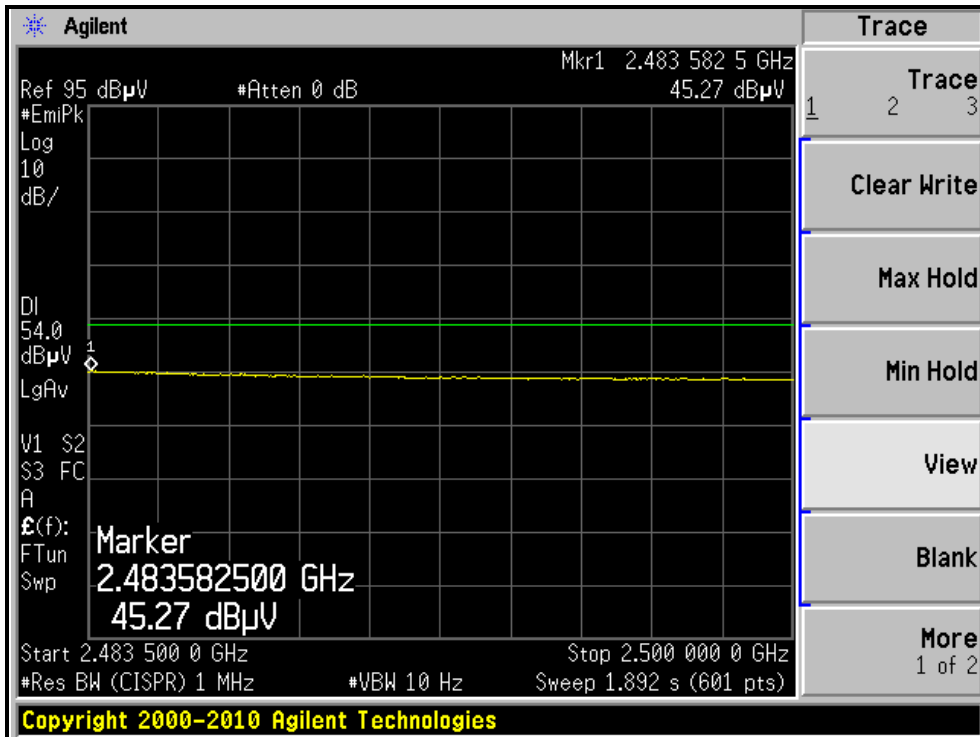
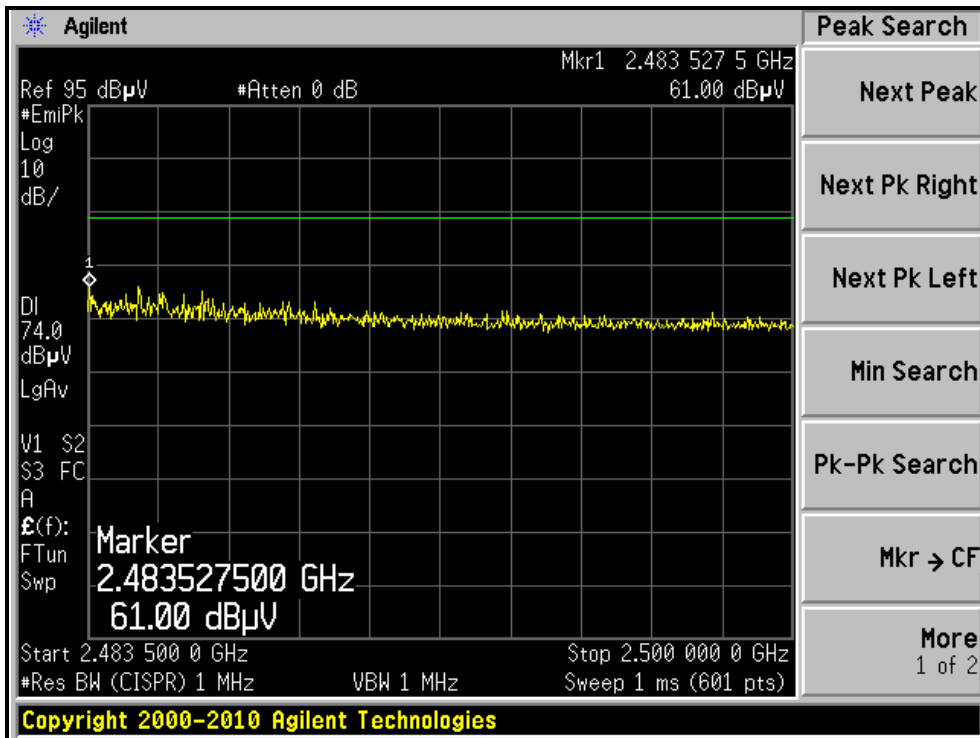



A D T

RESTRICTED BANDEDGE (802.11n (20MHz) MODE,CH11, VERTICAL)

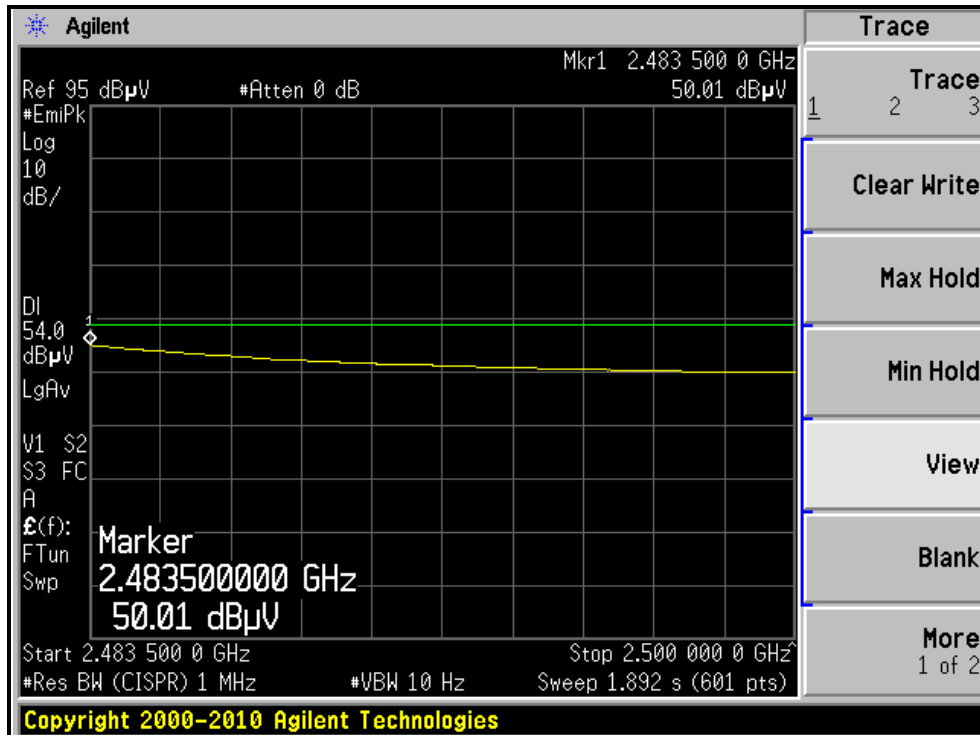
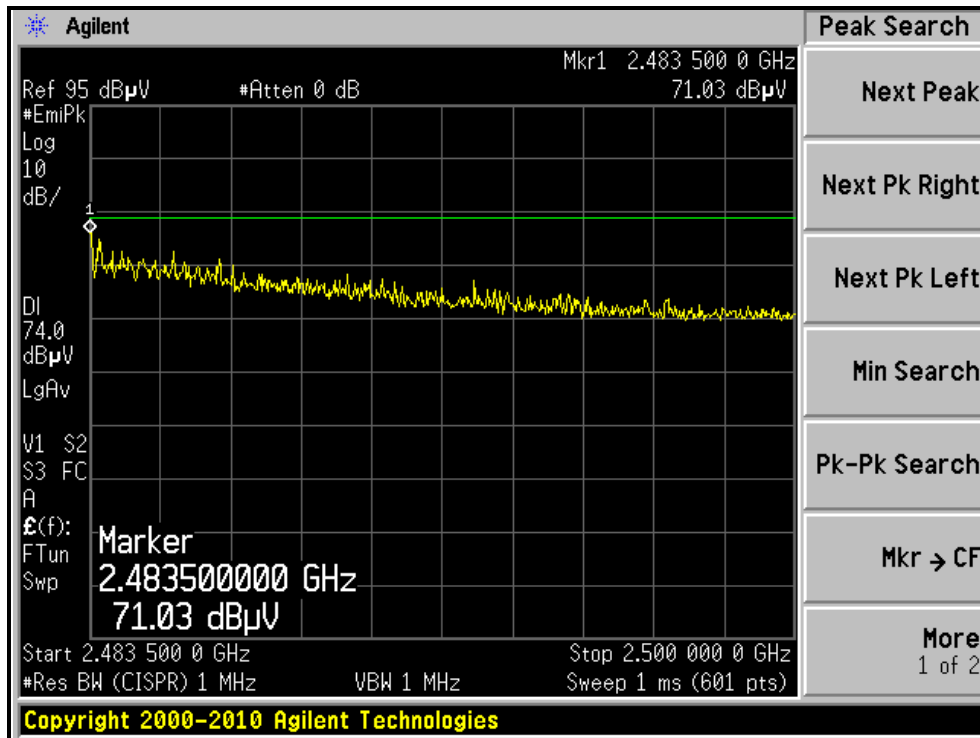



A D T

802.11n (20MHz) OFDM MODULATION <Single Chain (1)>

EUT TEST CONDITION		MEASUREMENT DETAIL	
CHANNEL	Channel 1	FREQUENCY RANGE	1 ~ 25GHz
INPUT POWER	120Vac, 60 Hz	DETECTOR FUNCTION	Peak (PK) Average (AV)
ENVIRONMENTAL CONDITIONS	24deg. C, 66%RH	TESTED BY	Evan Huang

ANTENNA POLARITY & TEST DISTANCE: HORIZONTAL AT 3 M								
NO.	FREQ. (MHz)	EMISSION LEVEL (dBuV/m)	LIMIT (dBuV/m)	MARGIN (dB)	ANTENNA HEIGHT (m)	TABLE ANGLE (Degree)	RAW VALUE (dBuV)	CORRECTION FACTOR (dB/m)
1	2390.00	72.3 PK	74.0	-1.7	1.44 H	48	40.42	31.88
2	2390.00	52.7 AV	54.0	-1.3	1.44 H	48	20.82	31.88
3	*2412.00	113.2 PK			1.39 H	45	81.25	31.95
4	*2412.00	101.7 AV			1.39 H	45	69.75	31.95
5	4824.00	47.5 PK	74.0	-26.5	1.13 H	61	6.28	41.22
6	4824.00	35.8 AV	54.0	-18.2	1.13 H	61	-5.42	41.22
ANTENNA POLARITY & TEST DISTANCE: VERTICAL AT 3 M								
NO.	FREQ. (MHz)	EMISSION LEVEL (dBuV/m)	LIMIT (dBuV/m)	MARGIN (dB)	ANTENNA HEIGHT (m)	TABLE ANGLE (Degree)	RAW VALUE (dBuV)	CORRECTION FACTOR (dB/m)
1	2390.00	66.8 PK	74.0	-7.2	1.49 V	96	34.92	31.88
2	2390.00	49.4 AV	54.0	-4.6	1.49 V	96	17.52	31.88
3	*2412.00	108.8 PK			1.48 V	90	76.85	31.95
4	*2412.00	97.0 AV			1.48 V	90	65.05	31.95
5	4824.00	47.2 PK	74.0	-26.8	1.00 V	320	5.98	41.22
6	4824.00	35.4 AV	54.0	-18.6	1.00 V	320	-5.82	41.22

- REMARKS:**
1. Emission level (dBuV/m) = Raw Value (dBuV) + Correction Factor (dB/m).
 2. Correction Factor (dB/m) = Antenna Factor (dB/m) + Cable Factor (dB).
 3. The other emission levels were very low against the limit.
 4. Margin value = Emission level – Limit value.
 5. “ * “: Fundamental frequency.



A D T

EUT TEST CONDITION		MEASUREMENT DETAIL	
CHANNEL	Channel 6	FREQUENCY RANGE	1 ~ 25GHz
INPUT POWER	120Vac, 60 Hz	DETECTOR FUNCTION	Peak (PK) Average (AV)
ENVIRONMENTAL CONDITIONS	24deg. C, 66%RH	TESTED BY	Evan Huang

ANTENNA POLARITY & TEST DISTANCE: HORIZONTAL AT 3 M								
NO.	FREQ. (MHz)	EMISSION LEVEL (dBuV/m)	LIMIT (dBuV/m)	MARGIN (dB)	ANTENNA HEIGHT (m)	TABLE ANGLE (Degree)	RAW VALUE (dBuV)	CORRECTION FACTOR (dB/m)
1	2310.00	68.4 PK	74.0	-5.6	1.39 H	46	36.73	31.67
2	2310.00	52.4 AV	54.0	-1.6	1.39 H	46	20.73	31.67
3	*2437.00	116.9 PK			1.39 H	45	84.86	32.04
4	*2437.00	106.3 AV			1.39 H	45	74.26	32.04
5	2483.50	68.1 PK	74.0	-5.9	1.39 H	45	35.91	32.19
6	2483.50	53.1 AV	54.0	-0.9	1.39 H	45	20.91	32.19
7	4874.00	47.9 PK	74.0	-26.1	1.14 H	60	6.54	41.36
8	4874.00	36.9 AV	54.0	-17.1	1.14 H	60	-4.46	41.36
9	7311.00	53.1 PK	74.0	-20.9	1.22 H	48	7.43	45.67
10	7311.00	40.2 AV	54.0	-13.8	1.22 H	48	-5.47	45.67
ANTENNA POLARITY & TEST DISTANCE: VERTICAL AT 3 M								
NO.	FREQ. (MHz)	EMISSION LEVEL (dBuV/m)	LIMIT (dBuV/m)	MARGIN (dB)	ANTENNA HEIGHT (m)	TABLE ANGLE (Degree)	RAW VALUE (dBuV)	CORRECTION FACTOR (dB/m)
1	2390.00	63.0 PK	74.0	-11.0	1.49 V	96	31.12	31.88
2	2390.00	48.7 AV	54.0	-5.3	1.49 V	96	16.82	31.88
3	*2437.00	114.2 PK			1.47 V	76	82.16	32.04
4	*2437.00	101.4 AV			1.47 V	76	69.36	32.04
5	2483.50	61.4 PK	74.0	-12.6	1.43 V	87	29.21	32.19
6	2483.50	48.2 AV	54.0	-5.8	1.43 V	87	16.01	32.19
7	4874.00	47.8 PK	74.0	-26.2	1.00 V	319	6.44	41.36
8	4874.00	36.1 AV	54.0	-17.9	1.00 V	319	-5.26	41.36
9	7311.00	62.5 PK	74.0	-11.5	1.04 V	359	16.83	45.67
10	7311.00	51.3 AV	54.0	-2.7	1.04 V	359	5.63	45.67

- REMARKS:**
1. Emission level (dBuV/m) = Raw Value (dBuV) + Correction Factor (dB/m).
 2. Correction Factor (dB/m) = Antenna Factor (dB/m) + Cable Factor (dB).
 3. The other emission levels were very low against the limit.
 4. Margin value = Emission level – Limit value.
 5. “ * “: Fundamental frequency.



A D T

EUT TEST CONDITION		MEASUREMENT DETAIL	
CHANNEL	Channel 11	FREQUENCY RANGE	1 ~ 25GHz
INPUT POWER	120Vac, 60 Hz	DETECTOR FUNCTION	Peak (PK) Average (AV)
ENVIRONMENTAL CONDITIONS	24deg. C, 66%RH	TESTED BY	Evan Huang

ANTENNA POLARITY & TEST DISTANCE: HORIZONTAL AT 3 M

NO.	FREQ. (MHz)	EMISSION LEVEL (dBuV/m)	LIMIT (dBuV/m)	MARGIN (dB)	ANTENNA HEIGHT (m)	TABLE ANGLE (Degree)	RAW VALUE (dBuV)	CORRECTION FACTOR (dB/m)
1	*2462.00	110.2 PK			1.39 H	47	78.08	32.12
2	*2462.00	99.8 AV			1.39 H	47	67.68	32.12
3	2483.50	72.9 PK	74.0	-1.1	1.63 H	45	40.71	32.19
4	2483.50	50.5 AV	54.0	-3.5	1.63 H	45	18.31	32.19
5	4924.00	47.2 PK	74.0	-26.8	1.12 H	69	5.72	41.48
6	4924.00	35.2 AV	54.0	-18.8	1.12 H	69	-6.28	41.48
7	7386.00	52.3 PK	74.0	-21.7	1.22 H	49	6.39	45.91
8	7386.00	39.8 AV	54.0	-14.2	1.22 H	49	-6.11	45.91

ANTENNA POLARITY & TEST DISTANCE: VERTICAL AT 3 M

NO.	FREQ. (MHz)	EMISSION LEVEL (dBuV/m)	LIMIT (dBuV/m)	MARGIN (dB)	ANTENNA HEIGHT (m)	TABLE ANGLE (Degree)	RAW VALUE (dBuV)	CORRECTION FACTOR (dB/m)
1	*2462.00	107.6 PK			1.45 V	80	75.48	32.12
2	*2462.00	95.4 AV			1.45 V	80	63.28	32.12
3	2483.50	65.6 PK	74.0	-8.4	1.47 V	94	33.41	32.19
4	2483.50	46.6 AV	54.0	-7.4	1.47 V	94	14.41	32.19
5	4924.00	47.0 PK	74.0	-27.0	1.00 V	316	5.52	41.48
6	4924.00	34.8 AV	54.0	-19.2	1.00 V	316	-6.68	41.48
7	7386.00	51.4 PK	74.0	-22.6	1.04 V	0	5.49	45.91
8	7386.00	39.9 AV	54.0	-14.1	1.04 V	0	-6.01	45.91

- REMARKS:**
1. Emission level (dBuV/m) = Raw Value (dBuV) + Correction Factor (dB/m).
 2. Correction Factor (dB/m) = Antenna Factor (dB/m) + Cable Factor (dB).
 3. The other emission levels were very low against the limit.
 4. Margin value = Emission level – Limit value.
 5. “ * “: Fundamental frequency.



A D T

RESTRICTED BANDEDGE (802.11n (20MHz) MODE,CH1, HORIZONTAL)

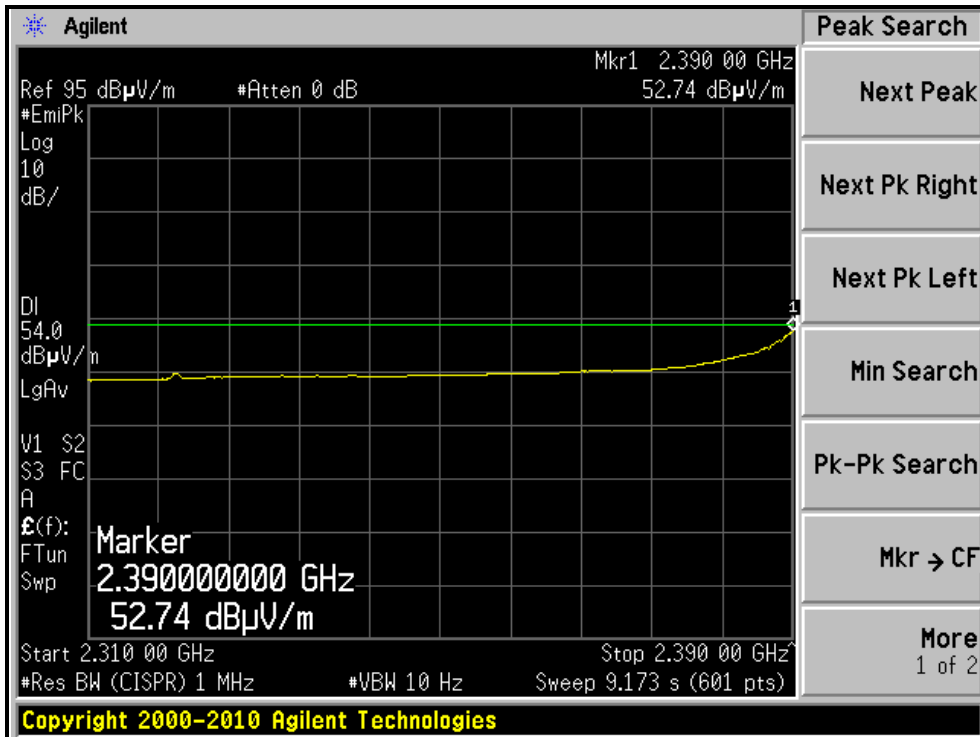
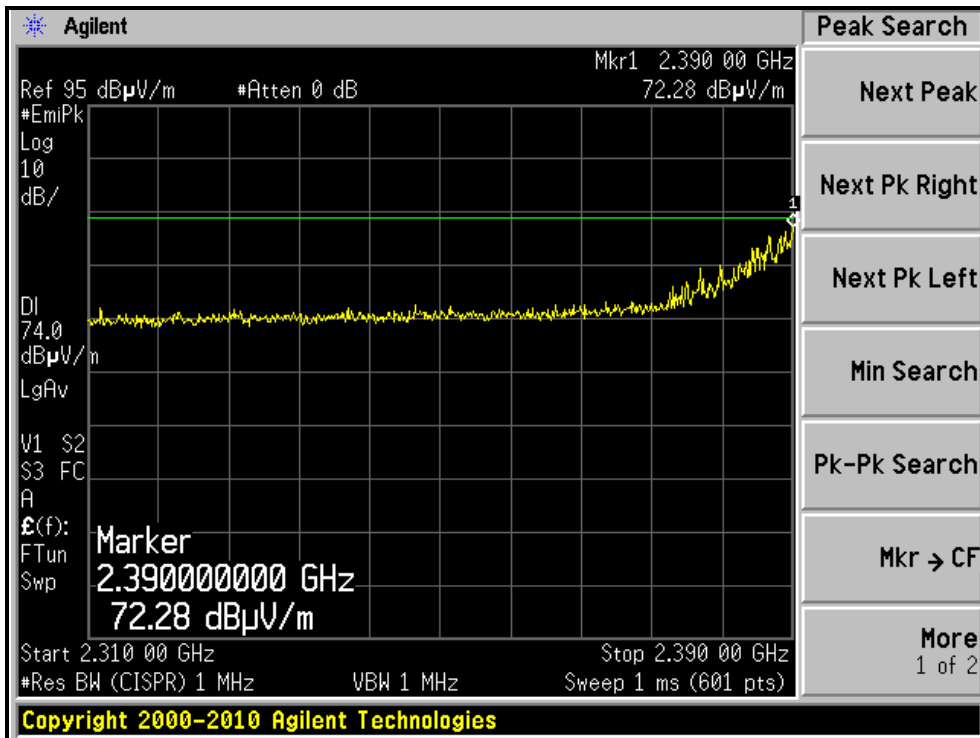



A D T

RESTRICTED BANDEDGE (802.11n (20MHz) MODE,CH1, VERTICAL)

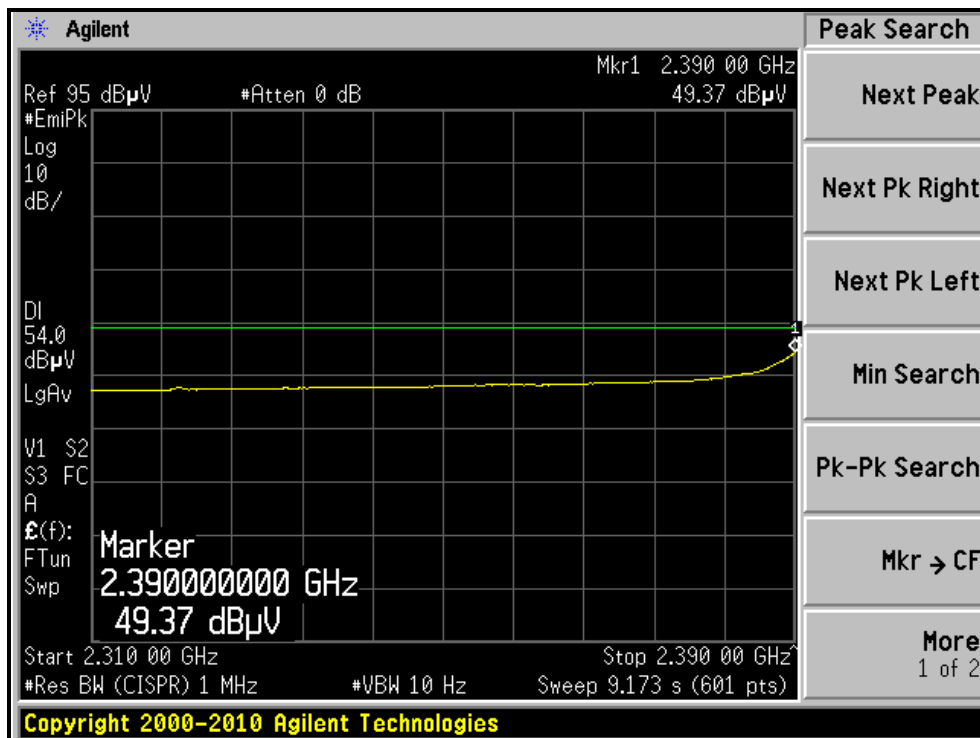
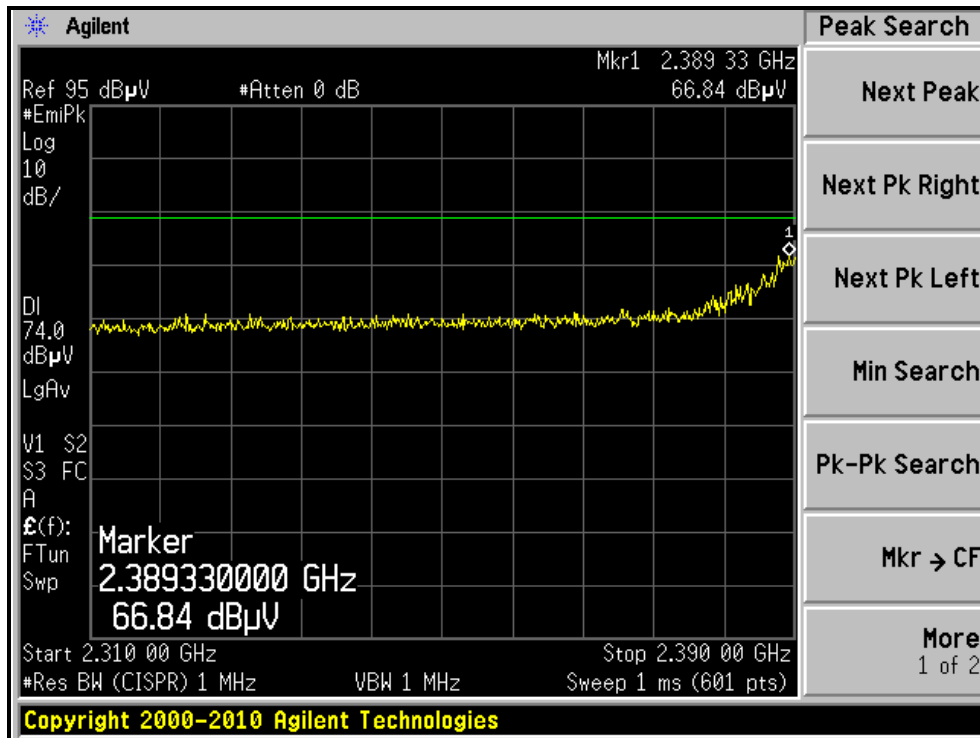



A D T

RESTRICTED BANDEDGE (802.11n (20MHz) MODE,CH11, HORIZONTAL)

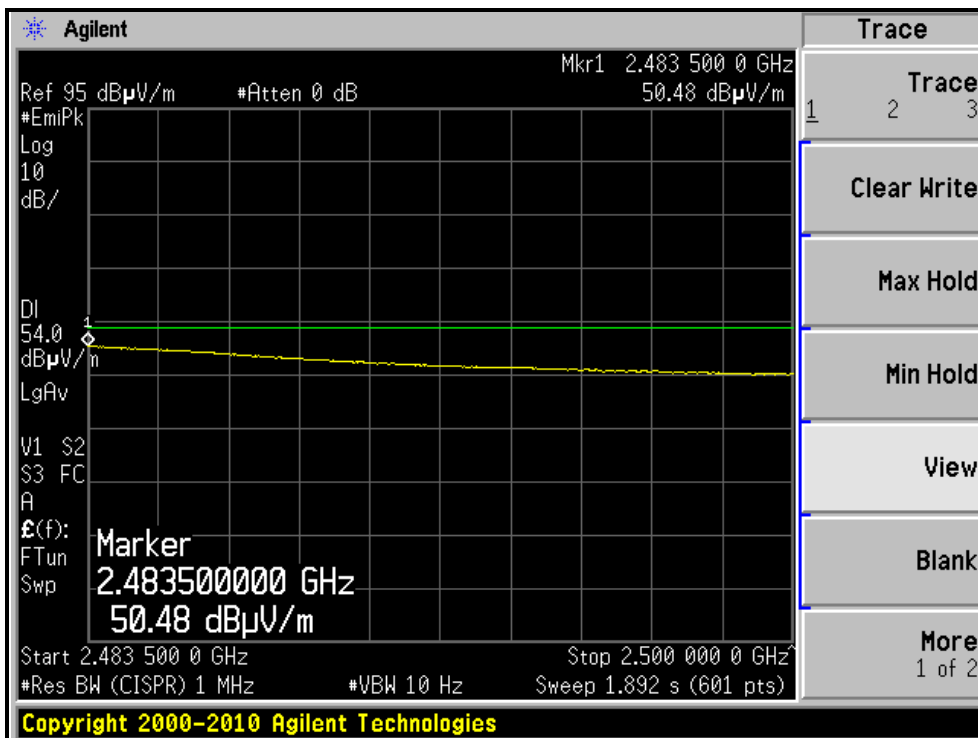
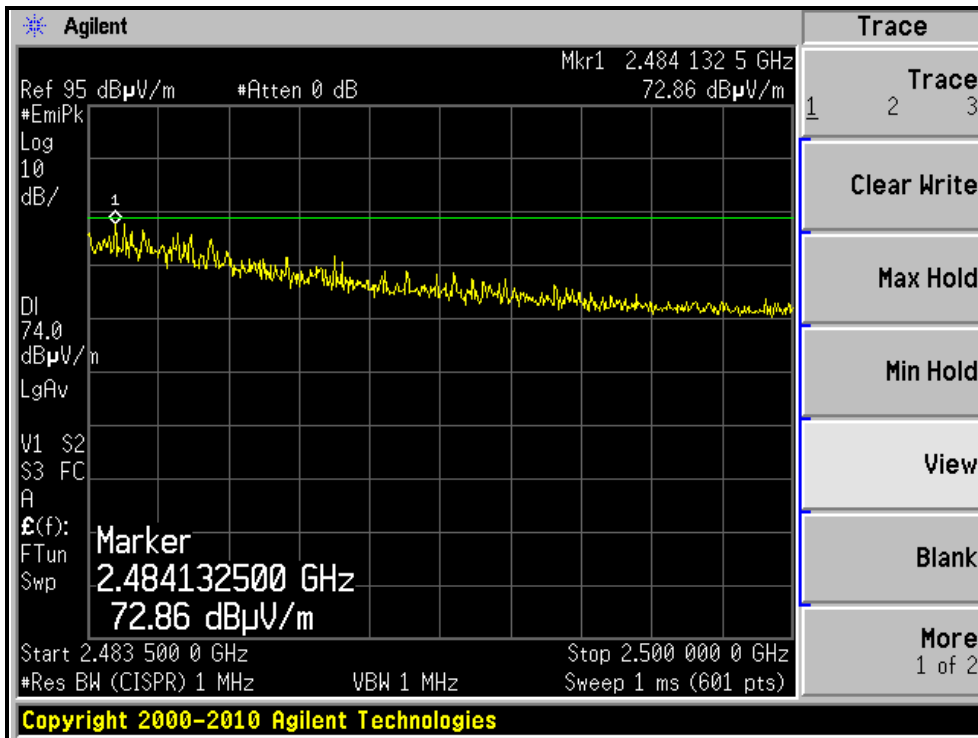

RESTRICTED BANDEDGE (802.11n (20MHz) MODE,CH11, VERTICAL)

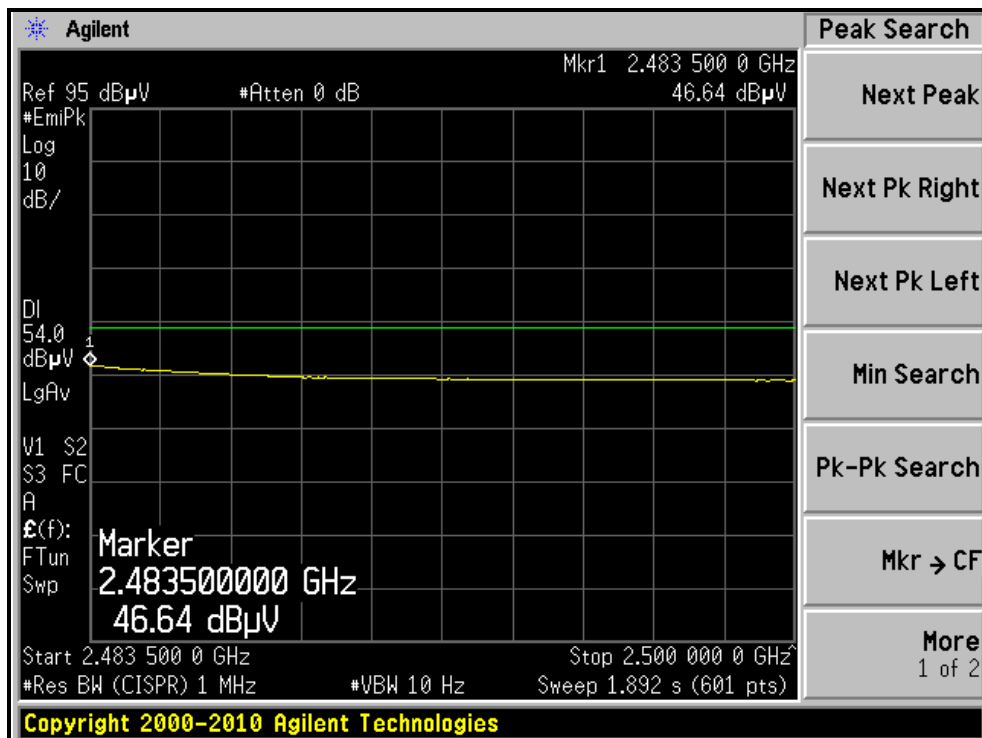
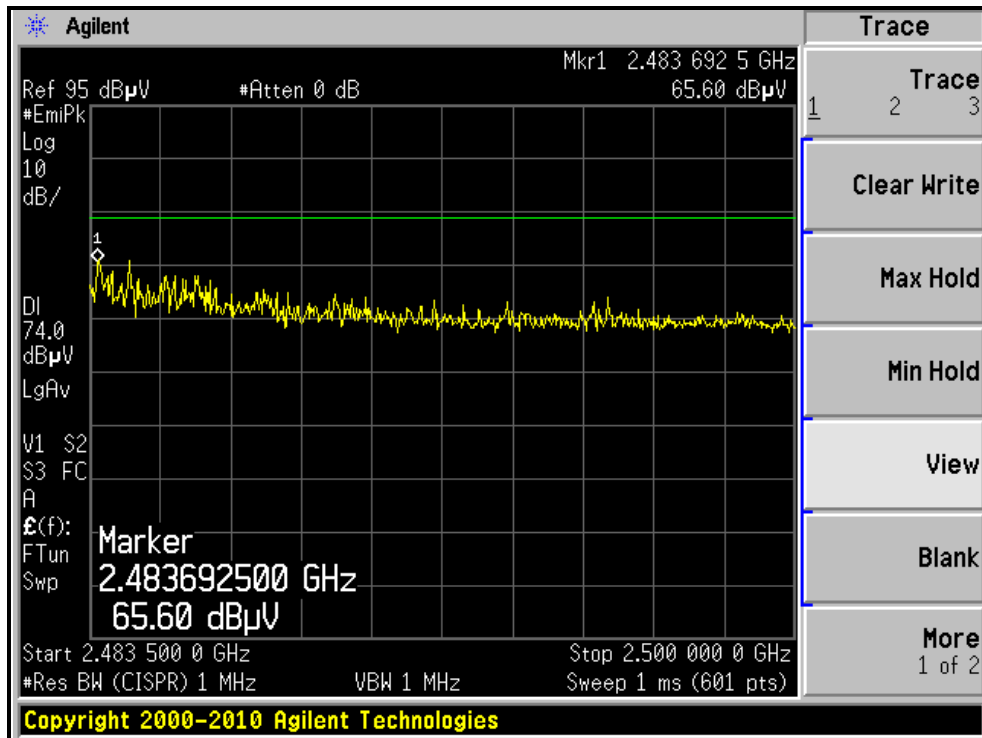



A D T

802.11n (20MHz) OFDM MODULATION <Multiple chain>

EUT TEST CONDITION		MEASUREMENT DETAIL	
CHANNEL	Channel 1	FREQUENCY RANGE	1 ~ 25GHz
INPUT POWER	120Vac, 60 Hz	DETECTOR FUNCTION	Peak (PK) Average (AV)
ENVIRONMENTAL CONDITIONS	24deg. C, 66%RH	TESTED BY	Evan Huang

ANTENNA POLARITY & TEST DISTANCE: HORIZONTAL AT 3 M								
NO.	FREQ. (MHz)	EMISSION LEVEL (dBuV/m)	LIMIT (dBuV/m)	MARGIN (dB)	ANTENNA HEIGHT (m)	TABLE ANGLE (Degree)	RAW VALUE (dBuV)	CORRECTION FACTOR (dB/m)
1	2390.00	69.9 PK	74.0	-4.1	1.43 H	330	38.02	31.88
2	2390.00	50.6 AV	54.0	-3.4	1.43 H	330	18.72	31.88
3	*2412.00	113.2 PK			1.44 H	326	81.25	31.95
4	*2412.00	100.4 AV			1.44 H	326	68.45	31.95
5	4824.00	46.6 PK	74.0	-27.4	1.18 H	90	5.38	41.22
6	4824.00	35.2 AV	54.0	-18.8	1.18 H	90	-6.02	41.22
ANTENNA POLARITY & TEST DISTANCE: VERTICAL AT 3 M								
NO.	FREQ. (MHz)	EMISSION LEVEL (dBuV/m)	LIMIT (dBuV/m)	MARGIN (dB)	ANTENNA HEIGHT (m)	TABLE ANGLE (Degree)	RAW VALUE (dBuV)	CORRECTION FACTOR (dB/m)
1	2390.00	71.3 PK	74.0	-2.7	1.00 V	0	39.42	31.88
2	2390.00	53.1 AV	54.0	-0.9	1.00 V	0	21.22	31.88
3	*2412.00	108.1 PK			1.00 V	11	76.15	31.95
4	*2412.00	97.5 AV			1.00 V	11	65.55	31.95
5	4824.00	47.7 PK	74.0	-26.3	1.00 V	84	6.48	41.22
6	4824.00	35.6 AV	54.0	-18.4	1.00 V	84	-5.62	41.22

- REMARKS:**
1. Emission level (dBuV/m) = Raw Value (dBuV) + Correction Factor (dB/m).
 2. Correction Factor (dB/m) = Antenna Factor (dB/m) + Cable Factor (dB).
 3. The other emission levels were very low against the limit.
 4. Margin value = Emission level – Limit value.
 5. “ * “: Fundamental frequency.



A D T

EUT TEST CONDITION		MEASUREMENT DETAIL	
CHANNEL	Channel 6	FREQUENCY RANGE	1 ~ 25GHz
INPUT POWER	120Vac, 60 Hz	DETECTOR FUNCTION	Peak (PK) Average (AV)
ENVIRONMENTAL CONDITIONS	24deg. C, 66%RH	TESTED BY	Evan Huang

ANTENNA POLARITY & TEST DISTANCE: HORIZONTAL AT 3 M								
NO.	FREQ. (MHz)	EMISSION LEVEL (dBuV/m)	LIMIT (dBuV/m)	MARGIN (dB)	ANTENNA HEIGHT (m)	TABLE ANGLE (Degree)	RAW VALUE (dBuV)	CORRECTION FACTOR (dB/m)
1	*2437.00	118.0 PK			1.66 H	55	85.96	32.04
2	*2437.00	105.0 AV			1.66 H	55	72.96	32.04
3	4874.00	67.3 PK	74.0	-6.7	1.18 H	70	25.94	41.36
4	4874.00	53.2 AV	54.0	-0.8	1.18 H	70	11.84	41.36
5	7311.00	58.3 PK	74.0	-15.7	1.81 H	71	12.63	45.67
6	7311.00	46.1 AV	54.0	-7.9	1.81 H	71	0.43	45.67
ANTENNA POLARITY & TEST DISTANCE: VERTICAL AT 3 M								
NO.	FREQ. (MHz)	EMISSION LEVEL (dBuV/m)	LIMIT (dBuV/m)	MARGIN (dB)	ANTENNA HEIGHT (m)	TABLE ANGLE (Degree)	RAW VALUE (dBuV)	CORRECTION FACTOR (dB/m)
1	*2437.00	113.4 PK			1.00 V	12	81.36	32.04
2	*2437.00	102.2 AV			1.00 V	12	70.16	32.04
3	4874.00	58.6 PK	74.0	-15.4	1.01 V	83	17.24	41.36
4	4874.00	45.4 AV	54.0	-8.6	1.01 V	83	4.04	41.36
5	7311.00	62.4 PK	74.0	-11.6	1.02 V	324	16.73	45.67
6	7311.00	49.0 AV	54.0	-5.0	1.02 V	324	3.33	45.67

- REMARKS:**
1. Emission level (dBuV/m) = Raw Value (dBuV) + Correction Factor (dB/m).
 2. Correction Factor (dB/m) = Antenna Factor (dB/m) + Cable Factor (dB).
 3. The other emission levels were very low against the limit.
 4. Margin value = Emission level – Limit value.
 5. “ * “: Fundamental frequency.



A D T

EUT TEST CONDITION		MEASUREMENT DETAIL	
CHANNEL	Channel 11	FREQUENCY RANGE	1 ~ 25GHz
INPUT POWER	120Vac, 60 Hz	DETECTOR FUNCTION	Peak (PK) Average (AV)
ENVIRONMENTAL CONDITIONS	24deg. C, 66%RH	TESTED BY	Evan Huang

ANTENNA POLARITY & TEST DISTANCE: HORIZONTAL AT 3 M

NO.	FREQ. (MHz)	EMISSION LEVEL (dBuV/m)	LIMIT (dBuV/m)	MARGIN (dB)	ANTENNA HEIGHT (m)	TABLE ANGLE (Degree)	RAW VALUE (dBuV)	CORRECTION FACTOR (dB/m)
1	*2462.00	111.7 PK			1.34 H	63	79.58	32.12
2	*2462.00	99.2 AV			1.34 H	63	67.08	32.12
3	2483.50	69.4 PK	74.0	-4.6	1.61 H	53	37.21	32.19
4	2483.50	49.7 AV	54.0	-4.3	1.61 H	53	17.51	32.19
5	4924.00	47.1 PK	74.0	-26.9	1.19 H	92	5.62	41.48
6	4924.00	35.5 AV	54.0	-18.5	1.19 H	92	-5.98	41.48
7	7386.00	56.4 PK	74.0	-17.6	1.81 H	70	10.49	45.91
8	7386.00	43.0 AV	54.0	-11.0	1.81 H	70	-2.91	45.91

ANTENNA POLARITY & TEST DISTANCE: VERTICAL AT 3 M

NO.	FREQ. (MHz)	EMISSION LEVEL (dBuV/m)	LIMIT (dBuV/m)	MARGIN (dB)	ANTENNA HEIGHT (m)	TABLE ANGLE (Degree)	RAW VALUE (dBuV)	CORRECTION FACTOR (dB/m)
1	*2462.00	107.3 PK			1.00 V	12	75.18	32.12
2	*2462.00	94.5 AV			1.00 V	12	62.38	32.12
3	2483.50	73.3 PK	74.0	-0.7	1.17 V	15	41.11	32.19
4	2483.50	49.7 AV	54.0	-4.3	1.17 V	15	17.51	32.19
5	4924.00	47.3 PK	74.0	-26.7	1.00 V	83	5.82	41.48
6	4924.00	35.1 AV	54.0	-18.9	1.00 V	83	-6.38	41.48
7	7386.00	55.3 PK	74.0	-18.7	1.01 V	325	9.39	45.91
8	7386.00	40.2 AV	54.0	-13.8	1.01 V	325	-5.71	45.91

- REMARKS:**
1. Emission level (dBuV/m) = Raw Value (dBuV) + Correction Factor (dB/m).
 2. Correction Factor (dB/m) = Antenna Factor (dB/m) + Cable Factor (dB).
 3. The other emission levels were very low against the limit.
 4. Margin value = Emission level – Limit value.
 5. “ * “: Fundamental frequency.

RESTRICTED BANDEDGE (802.11n (20MHz) MODE,CH1, HORIZONTAL)

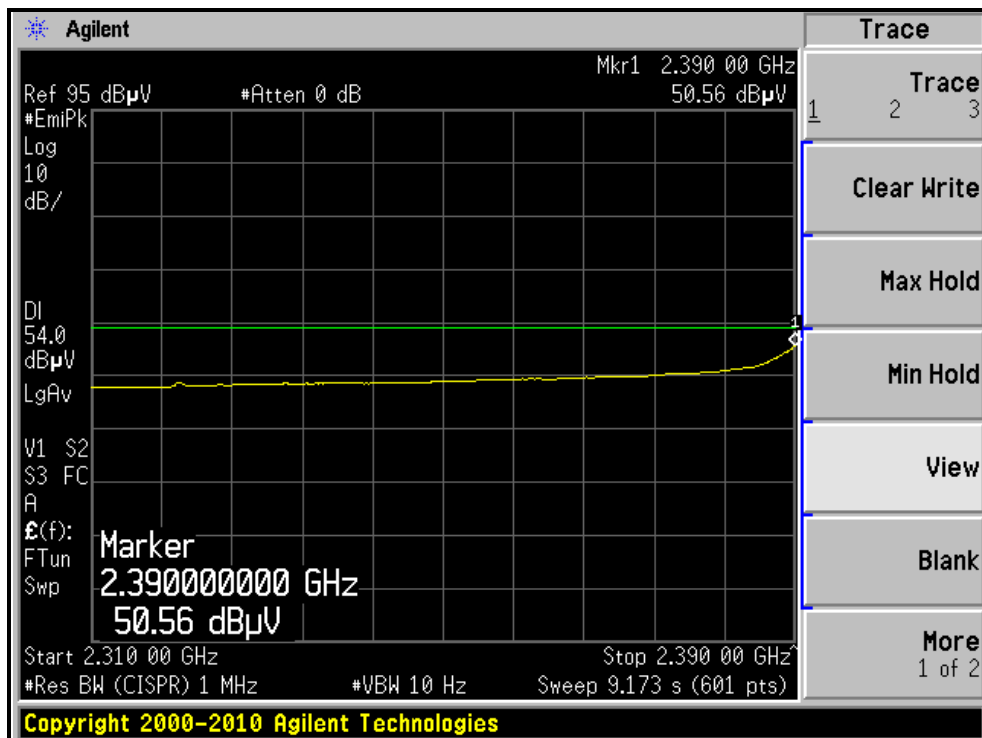
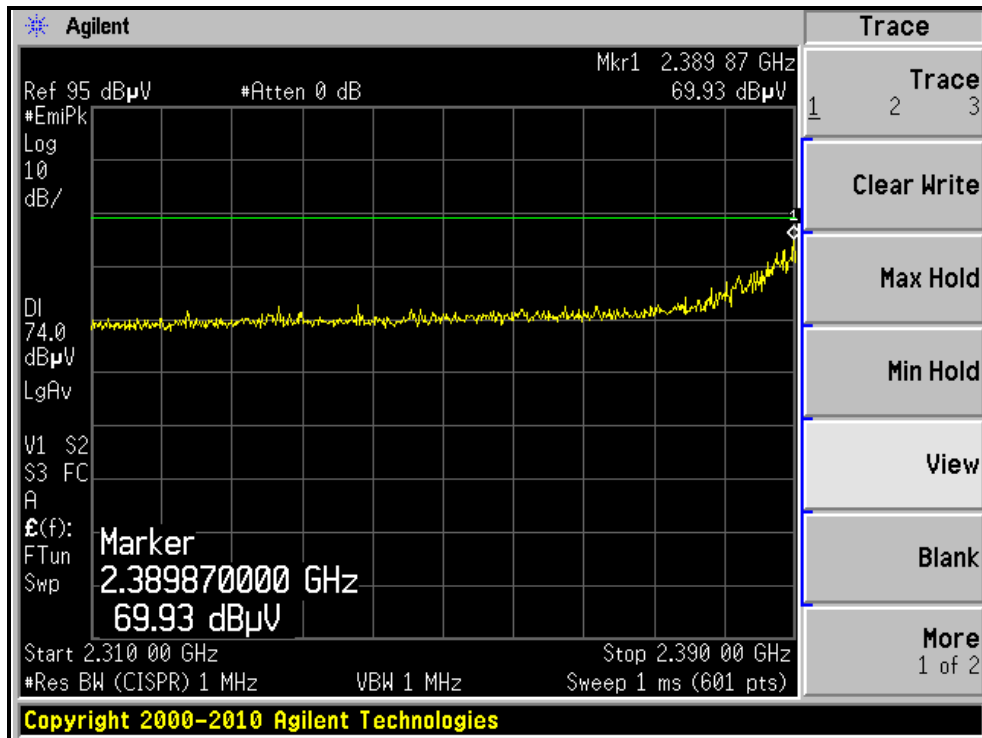

RESTRICTED BANDEDGE (802.11n (20MHz) MODE,CH1, VERTICAL)

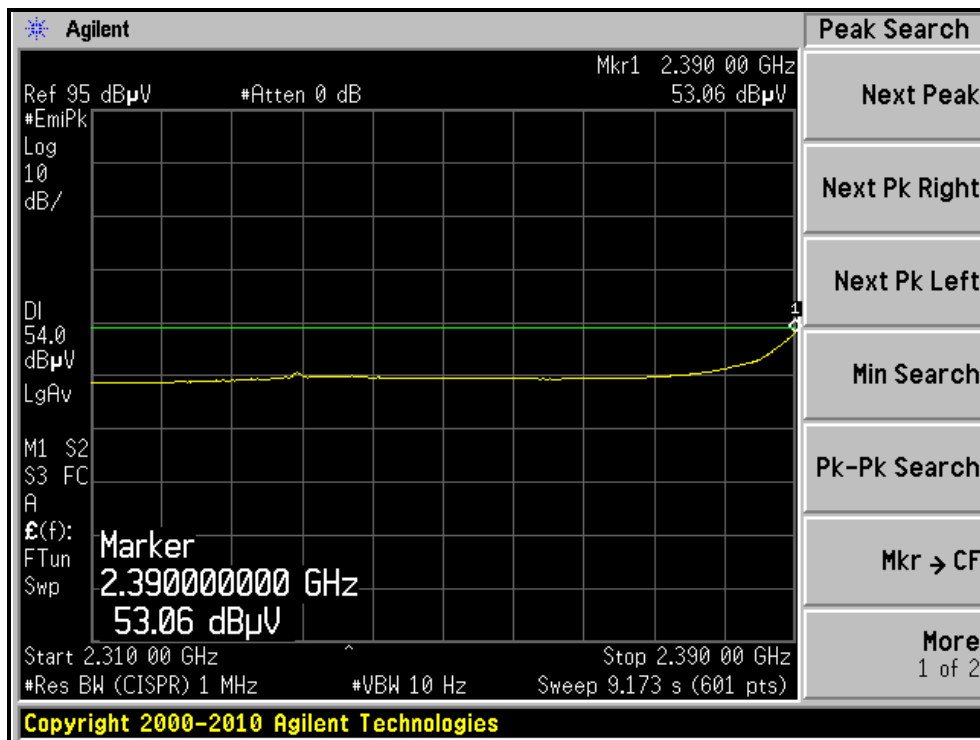
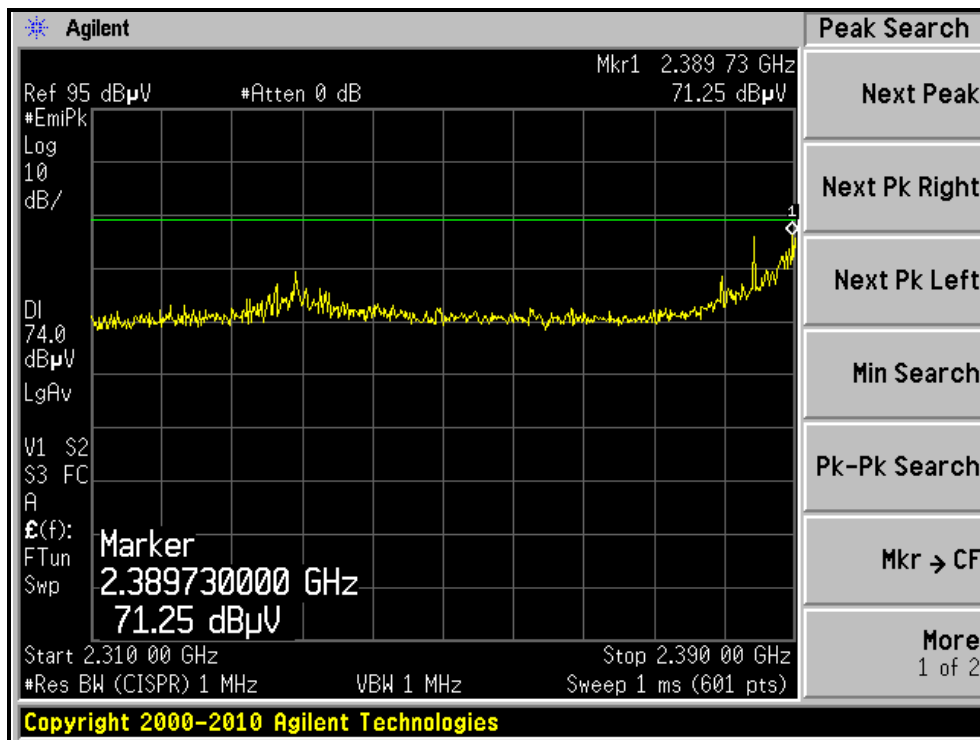



A D T

RESTRICTED BANDEDGE (802.11n (20MHz) MODE,CH11, HORIZONTAL)

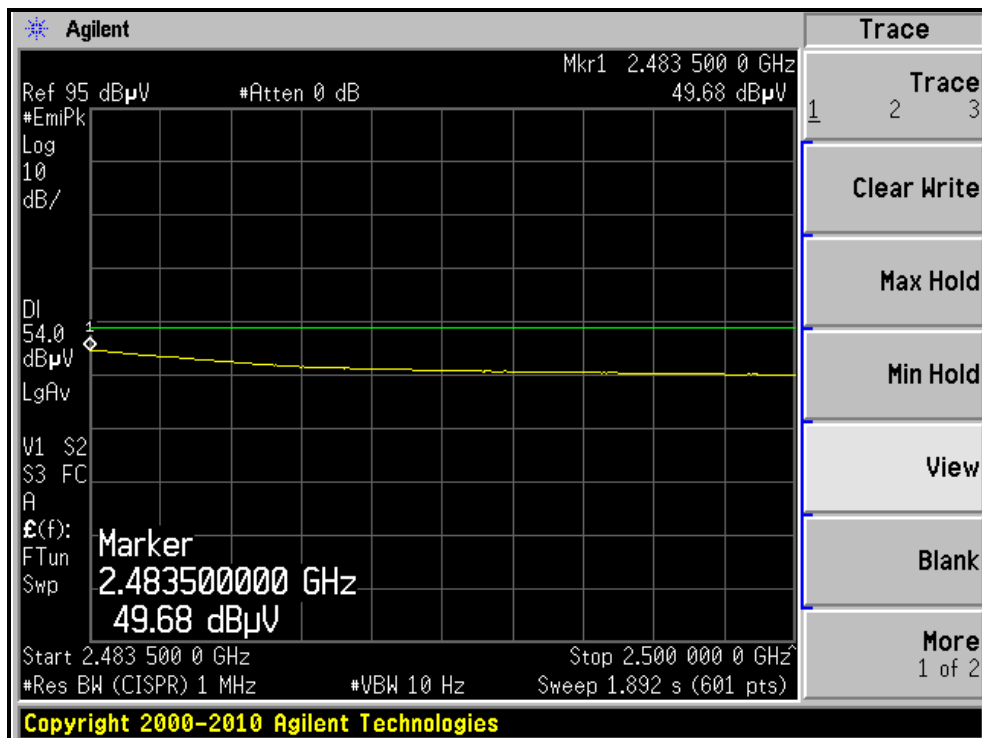
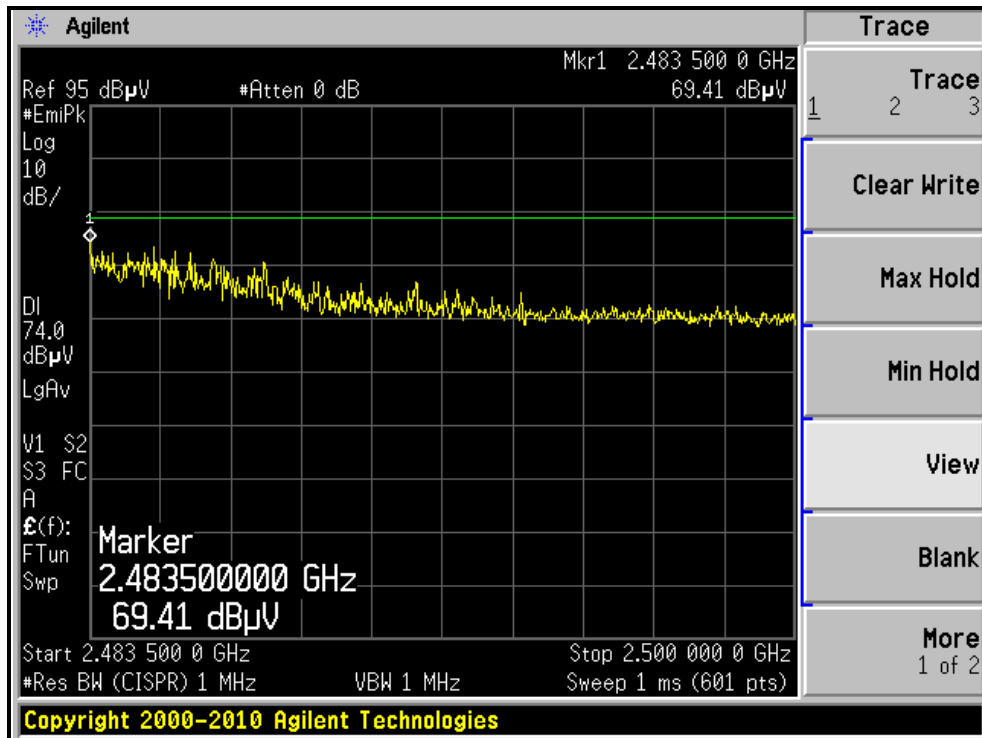

RESTRICTED BANDEDGE (802.11n (20MHz) MODE,CH11, VERTICAL)

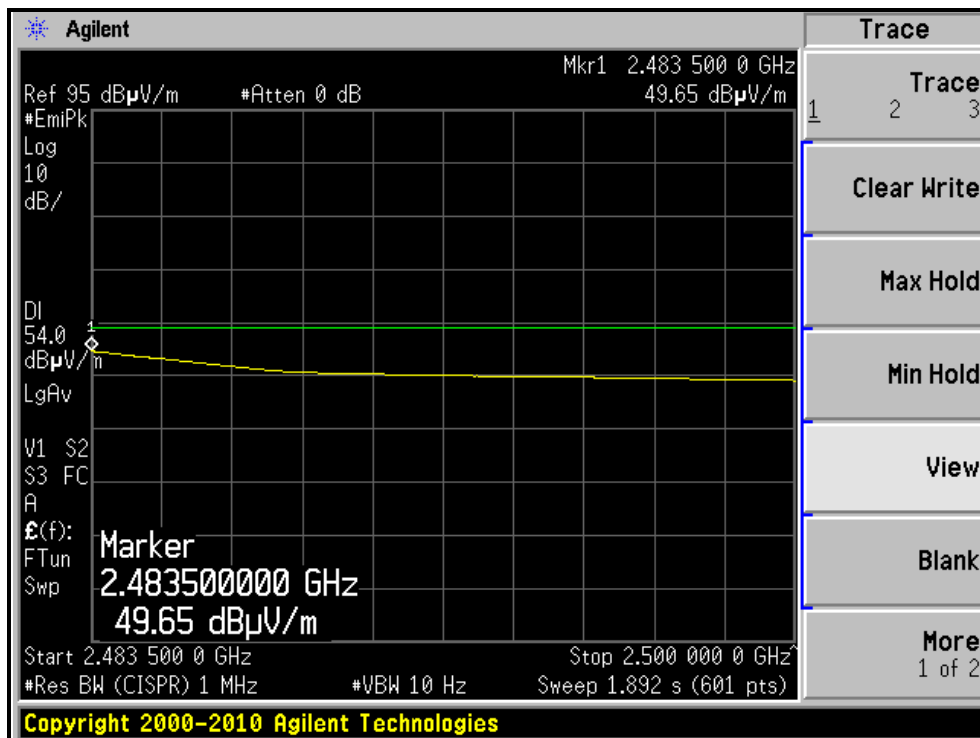
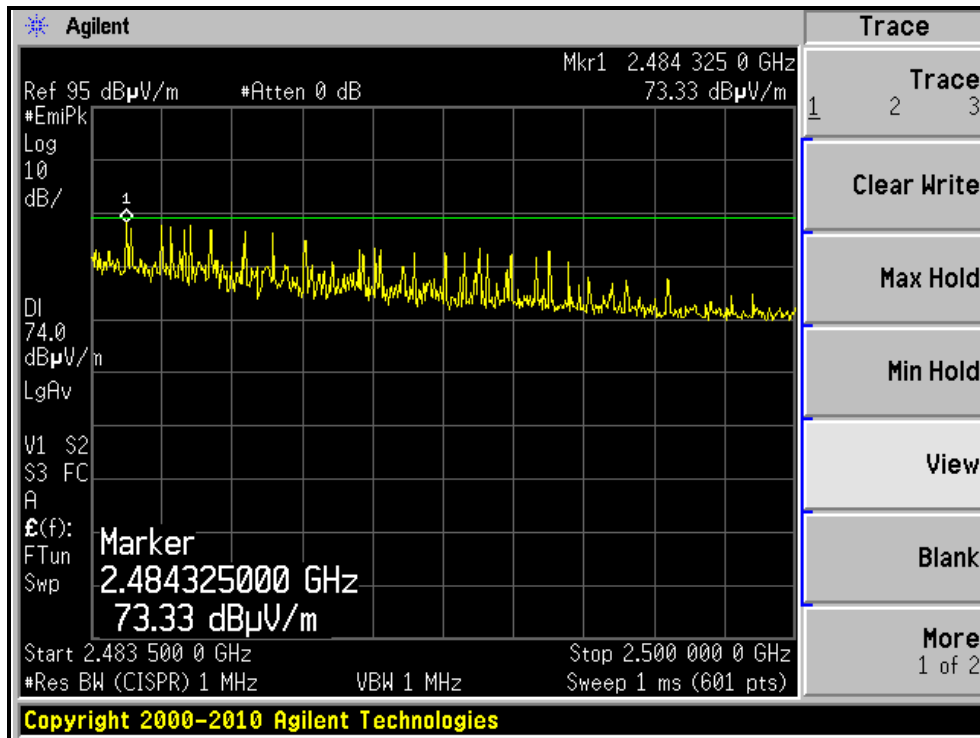



A D T

802.11n (40MHz) OFDM MODULATION <Single Chain (0)>

EUT TEST CONDITION		MEASUREMENT DETAIL	
CHANNEL	Channel 3	FREQUENCY RANGE	1 ~ 25GHz
INPUT POWER	120Vac, 60 Hz	DETECTOR FUNCTION	Peak (PK) Average (AV)
ENVIRONMENTAL CONDITIONS	24deg. C, 66%RH	TESTED BY	Evan Huang

ANTENNA POLARITY & TEST DISTANCE: HORIZONTAL AT 3 M

NO.	FREQ. (MHz)	EMISSION LEVEL (dBuV/m)	LIMIT (dBuV/m)	MARGIN (dB)	ANTENNA HEIGHT (m)	TABLE ANGLE (Degree)	RAW VALUE (dBuV)	CORRECTION FACTOR (dB/m)
1	2390.00	62.6 PK	74.0	-11.4	1.42 H	63	30.72	31.88
2	2390.00	46.5 AV	54.0	-7.5	1.42 H	63	14.62	31.88
3	*2422.00	102.2 PK			1.00 H	12	70.22	31.98
4	*2422.00	77.3 AV			1.00 H	12	45.32	31.98
5	4844.00	50.0 PK	74.0	-24.0	1.00 H	319	8.72	41.28
6	4844.00	37.6 AV	54.0	-16.4	1.00 H	319	-3.68	41.28
7	7266.00	51.9 PK	74.0	-22.1	1.08 H	159	6.35	45.55
8	7266.00	38.9 AV	54.0	-15.1	1.08 H	159	-6.65	45.55

ANTENNA POLARITY & TEST DISTANCE: VERTICAL AT 3 M

NO.	FREQ. (MHz)	EMISSION LEVEL (dBuV/m)	LIMIT (dBuV/m)	MARGIN (dB)	ANTENNA HEIGHT (m)	TABLE ANGLE (Degree)	RAW VALUE (dBuV)	CORRECTION FACTOR (dB/m)
1	2390.00	72.8 PK	74.0	-1.2	1.17 V	346	40.92	31.88
2	2390.00	52.9 AV	54.0	-1.1	1.17 V	346	21.02	31.88
3	*2422.00	106.9 PK			1.14 V	349	74.92	31.98
4	*2422.00	87.5 AV			1.14 V	349	55.52	31.98
5	4844.00	49.6 PK	74.0	-24.4	1.23 V	298	8.32	41.28
6	4844.00	37.4 AV	54.0	-16.6	1.23 V	298	-3.88	41.28
7	7266.00	51.9 PK	74.0	-22.1	1.00 V	7	6.35	45.55
8	7266.00	38.8 AV	54.0	-15.2	1.00 V	7	-6.75	45.55

- REMARKS:**
1. Emission level (dBuV/m) = Raw Value (dBuV) + Correction Factor (dB/m).
 2. Correction Factor (dB/m) = Antenna Factor (dB/m) + Cable Factor (dB).
 3. The other emission levels were very low against the limit.
 4. Margin value = Emission level – Limit value.
 5. “ * “: Fundamental frequency.



A D T

EUT TEST CONDITION		MEASUREMENT DETAIL	
CHANNEL	Channel 6	FREQUENCY RANGE	1 ~ 25GHz
INPUT POWER	120Vac, 60 Hz	DETECTOR FUNCTION	Peak (PK) Average (AV)
ENVIRONMENTAL CONDITIONS	24deg. C, 66%RH	TESTED BY	Evan Huang

ANTENNA POLARITY & TEST DISTANCE: HORIZONTAL AT 3 M

NO.	FREQ. (MHz)	EMISSION LEVEL (dBuV/m)	LIMIT (dBuV/m)	MARGIN (dB)	ANTENNA HEIGHT (m)	TABLE ANGLE (Degree)	RAW VALUE (dBuV)	CORRECTION FACTOR (dB/m)
1	*2437.00	101.4 PK			1.00 H	20	69.36	32.04
2	*2437.00	83.9 AV			1.00 H	20	51.86	32.04
3	4874.00	50.9 PK	74.0	-23.1	1.00 H	322	9.54	41.36
4	4874.00	38.8 AV	54.0	-15.2	1.00 H	322	-2.56	41.36
5	7311.00	50.9 PK	74.0	-23.1	1.08 H	155	5.23	45.67
6	7311.00	40.0 AV	54.0	-14.0	1.08 H	155	-5.67	45.67

ANTENNA POLARITY & TEST DISTANCE: VERTICAL AT 3 M

NO.	FREQ. (MHz)	EMISSION LEVEL (dBuV/m)	LIMIT (dBuV/m)	MARGIN (dB)	ANTENNA HEIGHT (m)	TABLE ANGLE (Degree)	RAW VALUE (dBuV)	CORRECTION FACTOR (dB/m)
1	2390.00	70.9 PK	74.0	-3.1	1.10 V	215	39.02	31.88
2	2390.00	49.6 AV	54.0	-4.4	1.10 V	215	17.72	31.88
3	*2437.00	108.2 PK			1.14 V	352	76.16	32.04
4	*2437.00	88.7 AV			1.14 V	352	56.66	32.04
5	2483.50	72.8 PK	74.0	-1.2	1.10 V	214	40.61	32.19
6	2483.50	51.9 AV	54.0	-2.1	1.10 V	214	19.71	32.19
7	4874.00	49.5 PK	74.0	-24.5	1.22 V	298	8.14	41.36
8	4874.00	37.5 AV	54.0	-16.5	1.22 V	298	-3.86	41.36
9	7311.00	50.4 PK	74.0	-23.6	1.00 V	8	4.73	45.67
10	7311.00	39.6 AV	54.0	-14.4	1.00 V	8	-6.07	45.67

- REMARKS:**
1. Emission level (dBuV/m) = Raw Value (dBuV) + Correction Factor (dB/m).
 2. Correction Factor (dB/m) = Antenna Factor (dB/m) + Cable Factor (dB).
 3. The other emission levels were very low against the limit.
 4. Margin value = Emission level – Limit value.
 5. “ * “: Fundamental frequency.



A D T

EUT TEST CONDITION		MEASUREMENT DETAIL	
CHANNEL	Channel 9	FREQUENCY RANGE	1 ~ 25GHz
INPUT POWER	120Vac, 60 Hz	DETECTOR FUNCTION	Peak (PK) Average (AV)
ENVIRONMENTAL CONDITIONS	24deg. C, 66%RH	TESTED BY	Evan Huang

ANTENNA POLARITY & TEST DISTANCE: HORIZONTAL AT 3 M

NO.	FREQ. (MHz)	EMISSION LEVEL (dBuV/m)	LIMIT (dBuV/m)	MARGIN (dB)	ANTENNA HEIGHT (m)	TABLE ANGLE (Degree)	RAW VALUE (dBuV)	CORRECTION FACTOR (dB/m)
1	*2452.00	98.9 PK			1.00 H	18	66.81	32.09
2	*2452.00	81.9 AV			1.00 H	18	49.81	32.09
3	2483.50	61.9 PK	74.0	-12.1	1.00 H	18	29.71	32.19
4	2483.50	44.8 AV	54.0	-9.2	1.00 H	18	12.61	32.19
5	4904.00	49.4 PK	74.0	-24.6	1.05 H	318	7.96	41.44
6	4904.00	37.3 AV	54.0	-16.7	1.05 H	318	-4.14	41.44
7	7356.00	50.1 PK	74.0	-23.9	1.09 H	160	4.29	45.81
8	7356.00	39.2 AV	54.0	-14.8	1.09 H	160	-6.61	45.81

ANTENNA POLARITY & TEST DISTANCE: VERTICAL AT 3 M

NO.	FREQ. (MHz)	EMISSION LEVEL (dBuV/m)	LIMIT (dBuV/m)	MARGIN (dB)	ANTENNA HEIGHT (m)	TABLE ANGLE (Degree)	RAW VALUE (dBuV)	CORRECTION FACTOR (dB/m)
1	*2452.00	105.3 PK			1.15 V	345	73.21	32.09
2	*2452.00	86.1 AV			1.15 V	345	54.01	32.09
3	2483.50	73.1 PK	74.0	-0.9	1.12 V	213	40.91	32.19
4	2483.50	52.7 AV	54.0	-1.3	1.12 V	213	20.51	32.19
5	4904.00	47.4 PK	74.0	-26.6	1.20 V	311	5.96	41.44
6	4904.00	36.7 AV	54.0	-17.3	1.20 V	311	-4.74	41.44
7	7356.00	49.8 PK	74.0	-24.2	1.00 V	10	3.99	45.81
8	7356.00	38.6 AV	54.0	-15.4	1.00 V	10	-7.21	45.81

- REMARKS:**
1. Emission level (dBuV/m) = Raw Value (dBuV) + Correction Factor (dB/m).
 2. Correction Factor (dB/m) = Antenna Factor (dB/m) + Cable Factor (dB).
 3. The other emission levels were very low against the limit.
 4. Margin value = Emission level – Limit value.
 5. “ * “: Fundamental frequency.



A D T

RESTRICTED BANDEDGE (802.11n (40MHz) MODE,CH3, HORIZONTAL)

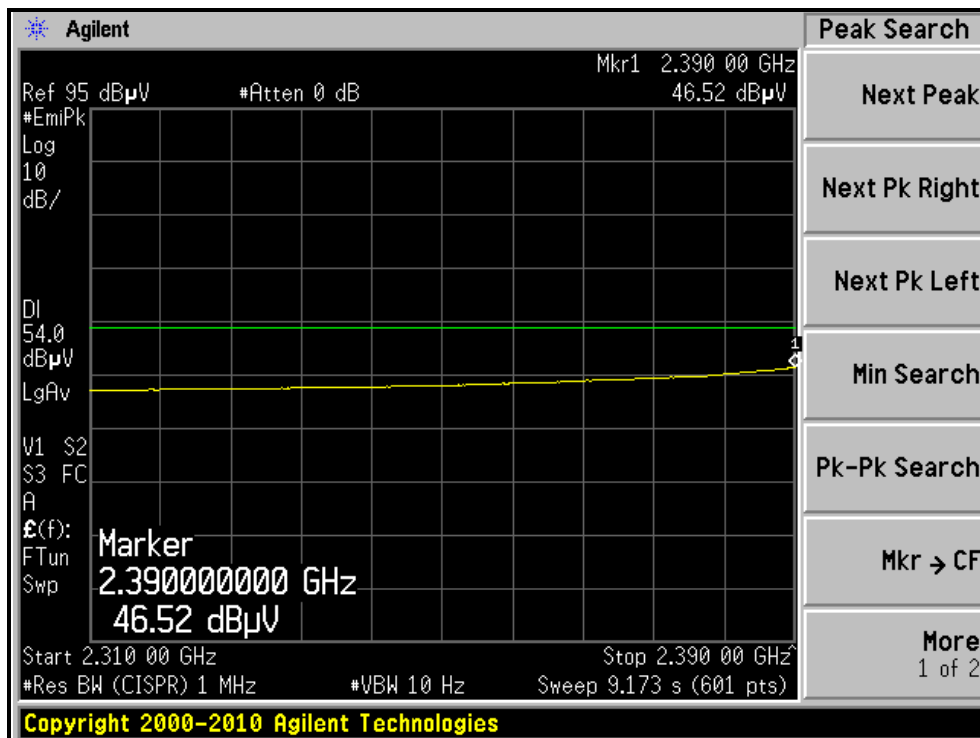
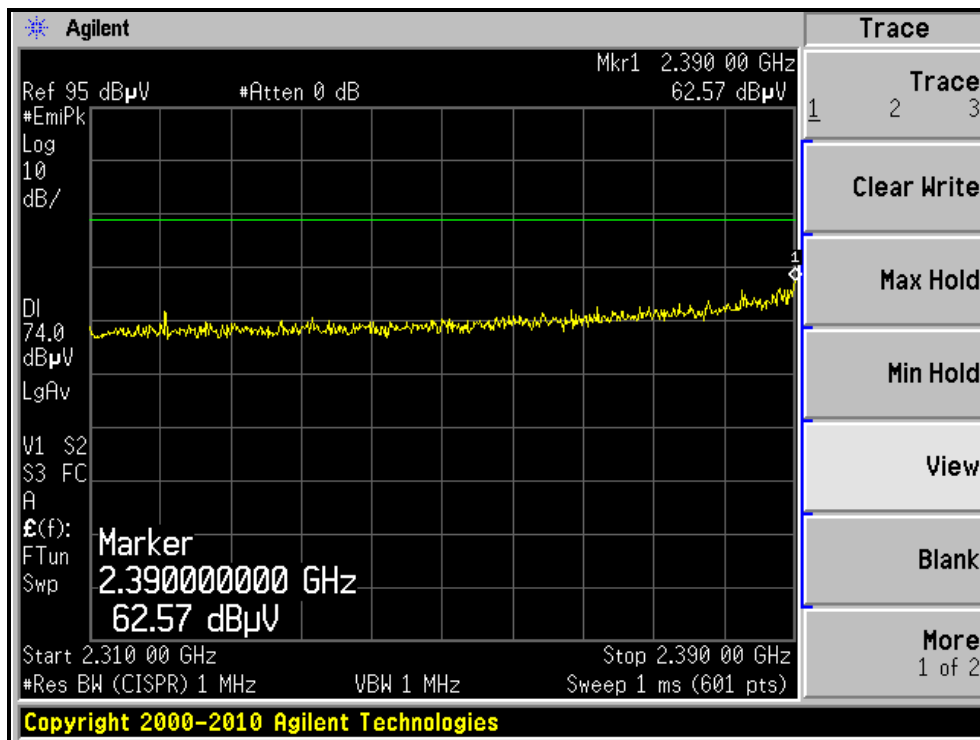



A D T

RESTRICTED BANDEDGE (802.11n (40MHz) MODE,CH3, VERTICAL)

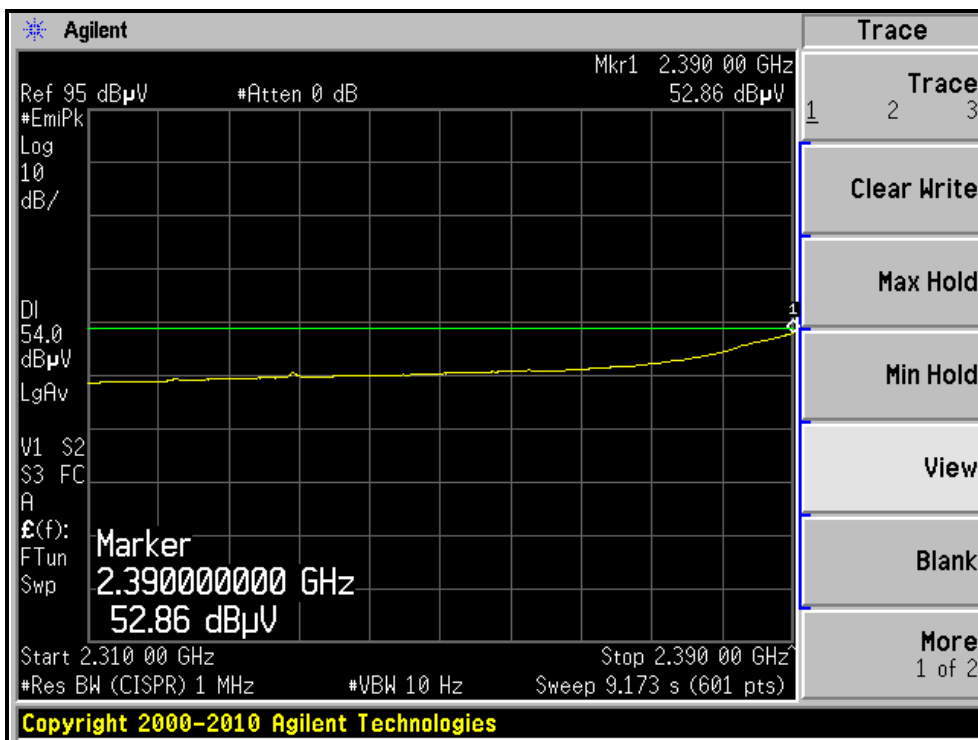
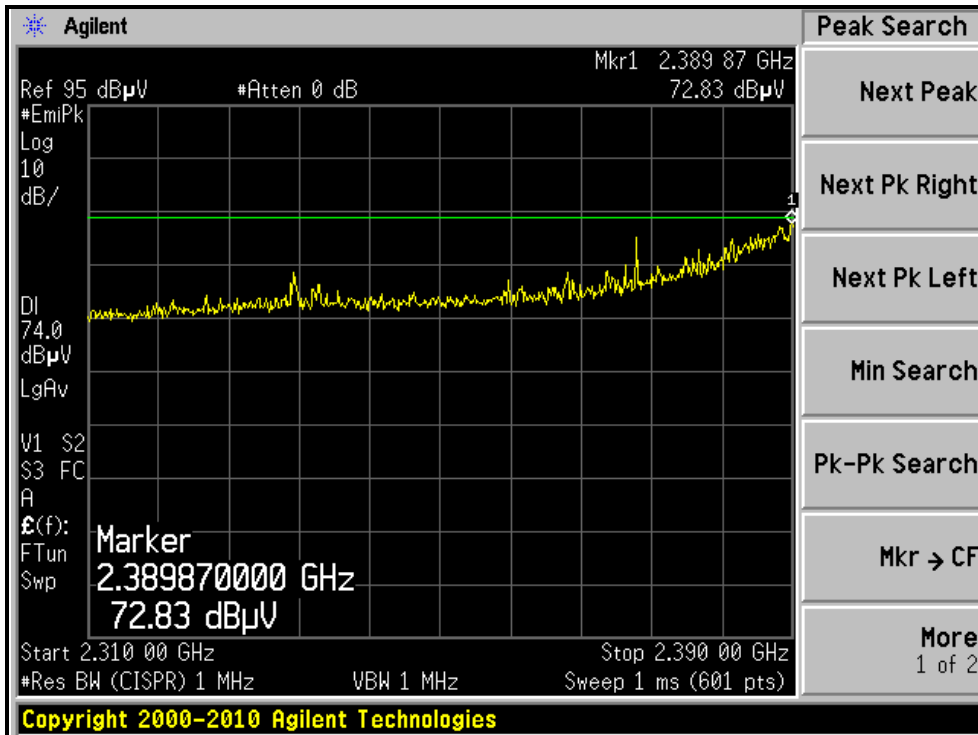



A D T

RESTRICTED BANDEDGE (802.11n (40MHz) MODE,CH9, HORIZONTAL)

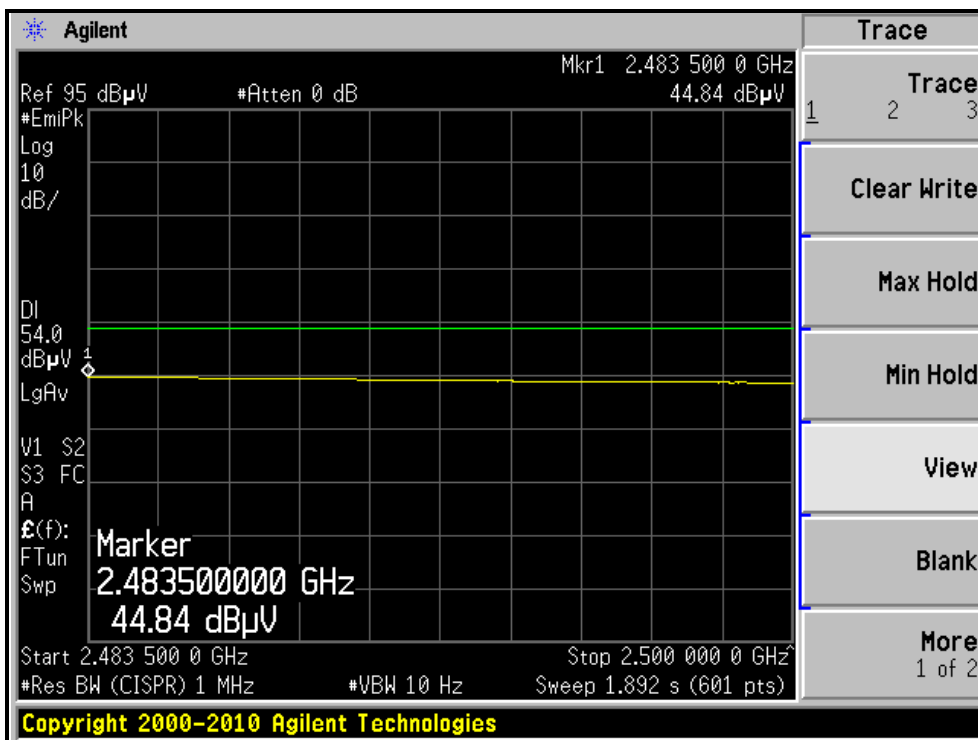
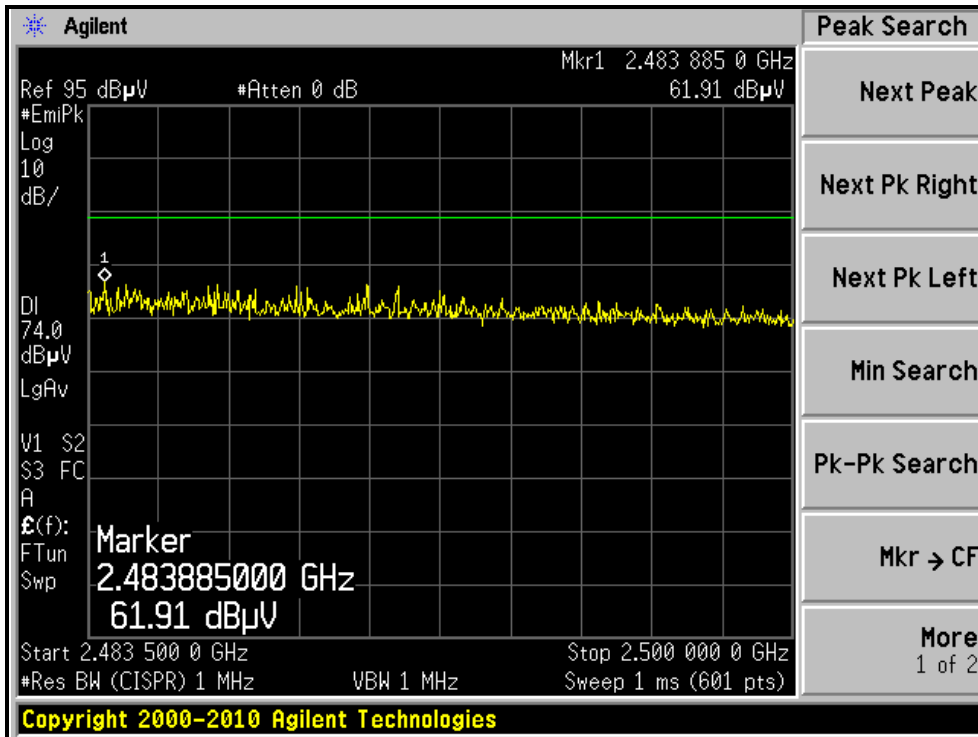

RESTRICTED BANDEDGE (802.11n (40MHz) MODE,CH9, VERTICAL)

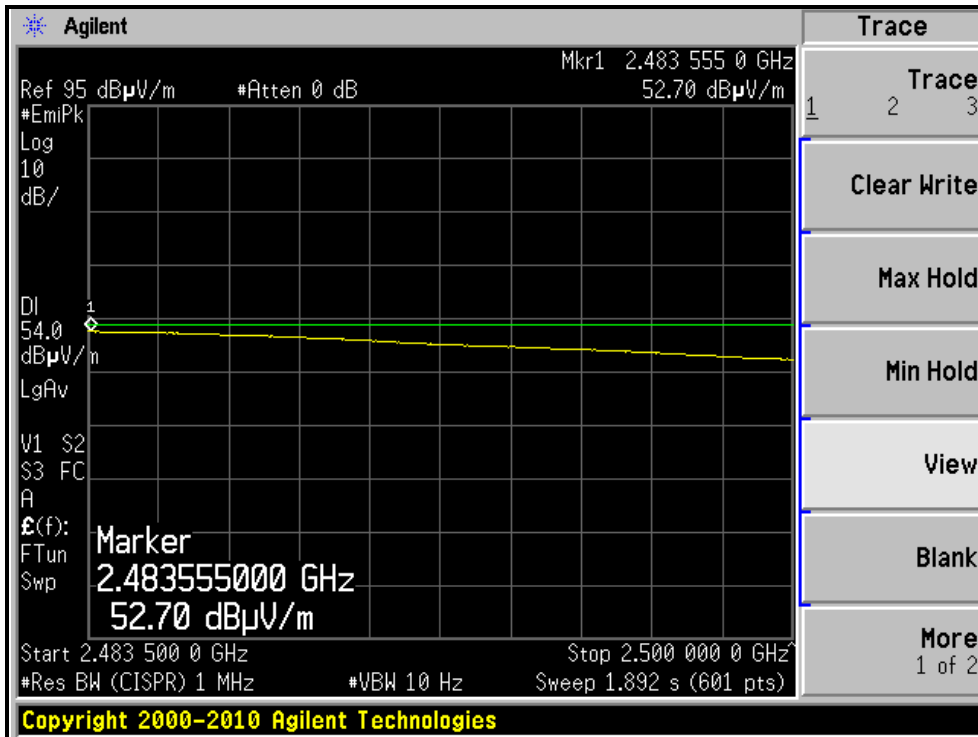
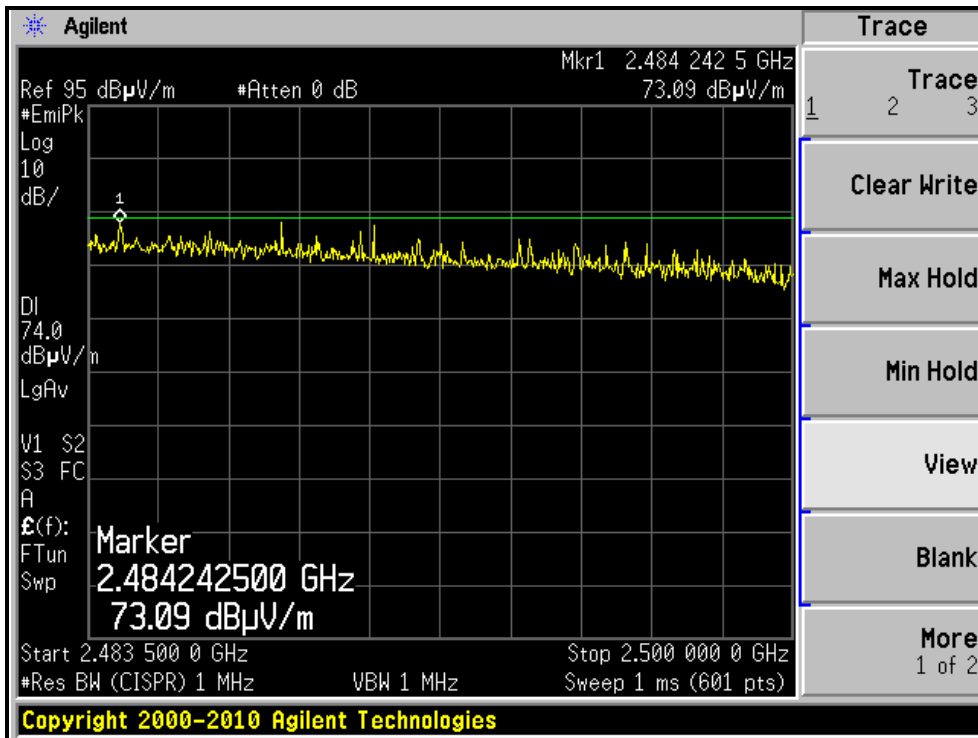



A D T

802.11n (40MHz) OFDM MODULATION <Single Chain (1)>

EUT TEST CONDITION		MEASUREMENT DETAIL	
CHANNEL	Channel 3	FREQUENCY RANGE	1 ~ 25GHz
INPUT POWER	120Vac, 60 Hz	DETECTOR FUNCTION	Peak (PK) Average (AV)
ENVIRONMENTAL CONDITIONS	24deg. C, 66%RH	TESTED BY	Evan Huang

ANTENNA POLARITY & TEST DISTANCE: HORIZONTAL AT 3 M								
NO.	FREQ. (MHz)	EMISSION LEVEL (dBuV/m)	LIMIT (dBuV/m)	MARGIN (dB)	ANTENNA HEIGHT (m)	TABLE ANGLE (Degree)	RAW VALUE (dBuV)	CORRECTION FACTOR (dB/m)
1	2390.00	72.0 PK	74.0	-2.0	1.42 H	54	40.12	31.88
2	2390.00	51.1 AV	54.0	-2.9	1.42 H	54	19.22	31.88
3	*2422.00	109.9 PK			1.41 H	45	77.92	31.98
4	*2422.00	83.1 AV			1.41 H	45	51.12	31.98
5	4844.00	47.3 PK	74.0	-26.7	1.13 H	61	6.02	41.28
6	4844.00	35.4 AV	54.0	-18.6	1.13 H	61	-5.88	41.28
7	7266.00	52.1 PK	74.0	-21.9	1.23 H	61	6.55	45.55
8	7266.00	40.2 AV	54.0	-13.8	1.23 H	61	-5.35	45.55
ANTENNA POLARITY & TEST DISTANCE: VERTICAL AT 3 M								
NO.	FREQ. (MHz)	EMISSION LEVEL (dBuV/m)	LIMIT (dBuV/m)	MARGIN (dB)	ANTENNA HEIGHT (m)	TABLE ANGLE (Degree)	RAW VALUE (dBuV)	CORRECTION FACTOR (dB/m)
1	2390.00	70.6 PK	74.0	-3.4	1.50 V	88	38.72	31.88
2	2390.00	48.6 AV	54.0	-5.4	1.50 V	88	16.72	31.88
3	*2422.00	107.5 PK			1.47 V	91	75.52	31.98
4	*2422.00	80.8 AV			1.47 V	91	48.82	31.98
5	4844.00	47.4 PK	74.0	-26.6	1.00 V	321	6.12	41.28
6	4844.00	35.5 AV	54.0	-18.5	1.00 V	321	-5.78	41.28
7	7266.00	51.9 PK	74.0	-22.1	1.05 V	354	6.35	45.55
8	7266.00	39.6 AV	54.0	-14.4	1.05 V	354	-5.95	45.55

- REMARKS:**
1. Emission level (dBuV/m) = Raw Value (dBuV) + Correction Factor (dB/m).
 2. Correction Factor (dB/m) = Antenna Factor (dB/m) + Cable Factor (dB).
 3. The other emission levels were very low against the limit.
 4. Margin value = Emission level – Limit value.
 5. “ * “: Fundamental frequency.



A D T

EUT TEST CONDITION		MEASUREMENT DETAIL	
CHANNEL	Channel 6	FREQUENCY RANGE	1 ~ 25GHz
INPUT POWER	120Vac, 60 Hz	DETECTOR FUNCTION	Peak (PK) Average (AV)
ENVIRONMENTAL CONDITIONS	24deg. C, 66%RH	TESTED BY	Evan Huang

ANTENNA POLARITY & TEST DISTANCE: HORIZONTAL AT 3 M								
NO.	FREQ. (MHz)	EMISSION LEVEL (dBuV/m)	LIMIT (dBuV/m)	MARGIN (dB)	ANTENNA HEIGHT (m)	TABLE ANGLE (Degree)	RAW VALUE (dBuV)	CORRECTION FACTOR (dB/m)
1	*2437.00	111.1 PK			1.40 H	45	79.06	32.04
2	*2437.00	83.9 AV			1.40 H	45	51.86	32.04
3	2483.50	72.4 PK	74.0	-1.6	1.62 H	51	40.21	32.19
4	2483.50	50.1 AV	54.0	-3.9	1.62 H	51	17.91	32.19
5	4874.00	48.2 PK	74.0	-25.8	1.14 H	63	6.84	41.36
6	4874.00	36.3 AV	54.0	-17.7	1.14 H	63	-5.06	41.36
7	7311.00	51.9 PK	74.0	-22.1	1.29 H	60	6.23	45.67
8	7311.00	40.2 AV	54.0	-13.8	1.29 H	60	-5.47	45.67

ANTENNA POLARITY & TEST DISTANCE: VERTICAL AT 3 M								
NO.	FREQ. (MHz)	EMISSION LEVEL (dBuV/m)	LIMIT (dBuV/m)	MARGIN (dB)	ANTENNA HEIGHT (m)	TABLE ANGLE (Degree)	RAW VALUE (dBuV)	CORRECTION FACTOR (dB/m)
1	*2437.00	107.6 PK			1.51 V	82	75.56	32.04
2	*2437.00	81.6 AV			1.51 V	82	49.56	32.04
3	4874.00	48.3 PK	74.0	-25.7	1.00 V	323	6.94	41.36
4	4874.00	36.6 AV	54.0	-17.4	1.00 V	323	-4.76	41.36
5	7311.00	52.0 PK	74.0	-22.0	1.06 V	0	6.33	45.67
6	7311.00	40.1 AV	54.0	-13.9	1.06 V	0	-5.57	45.67

- REMARKS:**
1. Emission level (dBuV/m) = Raw Value (dBuV) + Correction Factor (dB/m).
 2. Correction Factor (dB/m) = Antenna Factor (dB/m) + Cable Factor (dB).
 3. The other emission levels were very low against the limit.
 4. Margin value = Emission level – Limit value.
 5. “ * “: Fundamental frequency.



A D T

EUT TEST CONDITION		MEASUREMENT DETAIL	
CHANNEL	Channel 9	FREQUENCY RANGE	1 ~ 25GHz
INPUT POWER	120Vac, 60 Hz	DETECTOR FUNCTION	Peak (PK) Average (AV)
ENVIRONMENTAL CONDITIONS	24deg. C, 66%RH	TESTED BY	Evan Huang

ANTENNA POLARITY & TEST DISTANCE: HORIZONTAL AT 3 M								
NO.	FREQ. (MHz)	EMISSION LEVEL (dBuV/m)	LIMIT (dBuV/m)	MARGIN (dB)	ANTENNA HEIGHT (m)	TABLE ANGLE (Degree)	RAW VALUE (dBuV)	CORRECTION FACTOR (dB/m)
1	*2452.00	107.6 PK			1.40 H	53	75.51	32.09
2	*2452.00	81.5 AV			1.40 H	53	49.41	32.09
3	2483.50	72.3 PK	74.0	-1.7	1.63 H	55	40.11	32.19
4	2483.50	48.3 AV	54.0	-5.7	1.63 H	55	16.11	32.19
5	4904.00	46.9 PK	74.0	-27.1	1.12 H	67	5.46	41.44
6	4904.00	35.1 AV	54.0	-18.9	1.12 H	67	-6.34	41.44
7	7356.00	51.8 PK	74.0	-22.2	1.28 H	53	5.99	45.81
8	7356.00	40.1 AV	54.0	-13.9	1.28 H	53	-5.71	45.81
ANTENNA POLARITY & TEST DISTANCE: VERTICAL AT 3 M								
NO.	FREQ. (MHz)	EMISSION LEVEL (dBuV/m)	LIMIT (dBuV/m)	MARGIN (dB)	ANTENNA HEIGHT (m)	TABLE ANGLE (Degree)	RAW VALUE (dBuV)	CORRECTION FACTOR (dB/m)
1	*2452.00	105.0 PK			1.48 V	103	72.91	32.09
2	*2452.00	80.3 AV			1.48 V	103	48.21	32.09
3	2483.50	70.0 PK	74.0	-4.0	1.44 V	108	37.81	32.19
4	2483.50	47.5 AV	54.0	-6.5	1.44 V	108	15.31	32.19
5	4904.00	47.1 PK	74.0	-26.9	1.00 V	320	5.66	41.44
6	4904.00	35.3 AV	54.0	-18.7	1.00 V	320	-6.14	41.44
7	7356.00	51.7 PK	74.0	-22.3	1.05 V	359	5.89	45.81
8	7356.00	39.3 AV	54.0	-14.7	1.05 V	359	-6.51	45.81

- REMARKS:**
1. Emission level (dBuV/m) = Raw Value (dBuV) + Correction Factor (dB/m).
 2. Correction Factor (dB/m) = Antenna Factor (dB/m) + Cable Factor (dB).
 3. The other emission levels were very low against the limit.
 4. Margin value = Emission level – Limit value.
 5. “ * “: Fundamental frequency.



A D T

RESTRICTED BANDEDGE (802.11n (40MHz) MODE,CH3, HORIZONTAL)

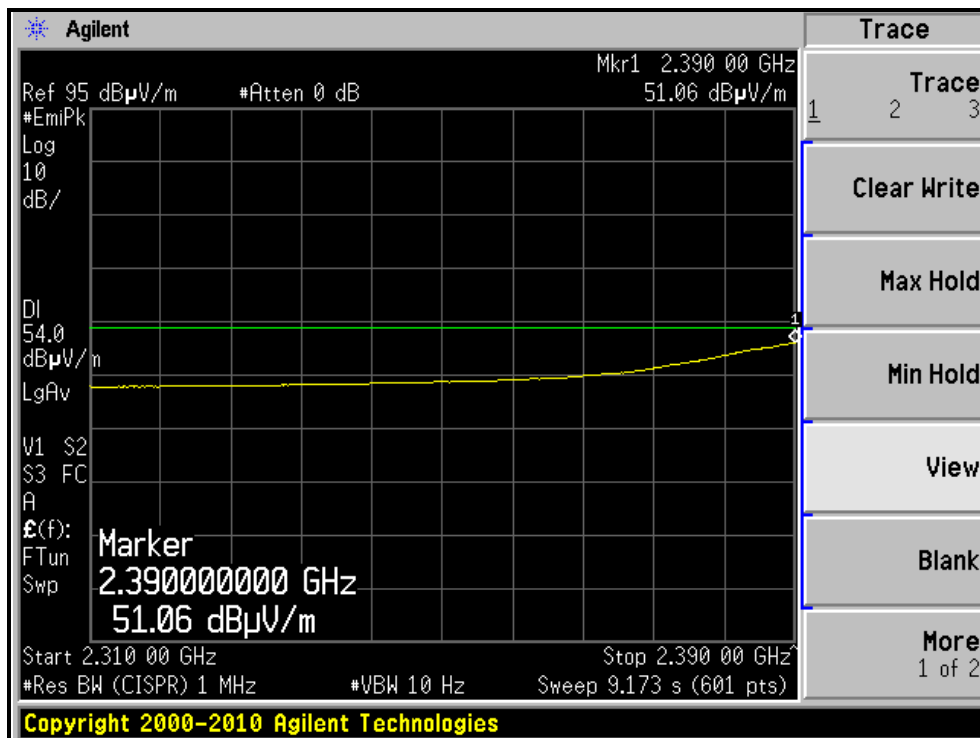
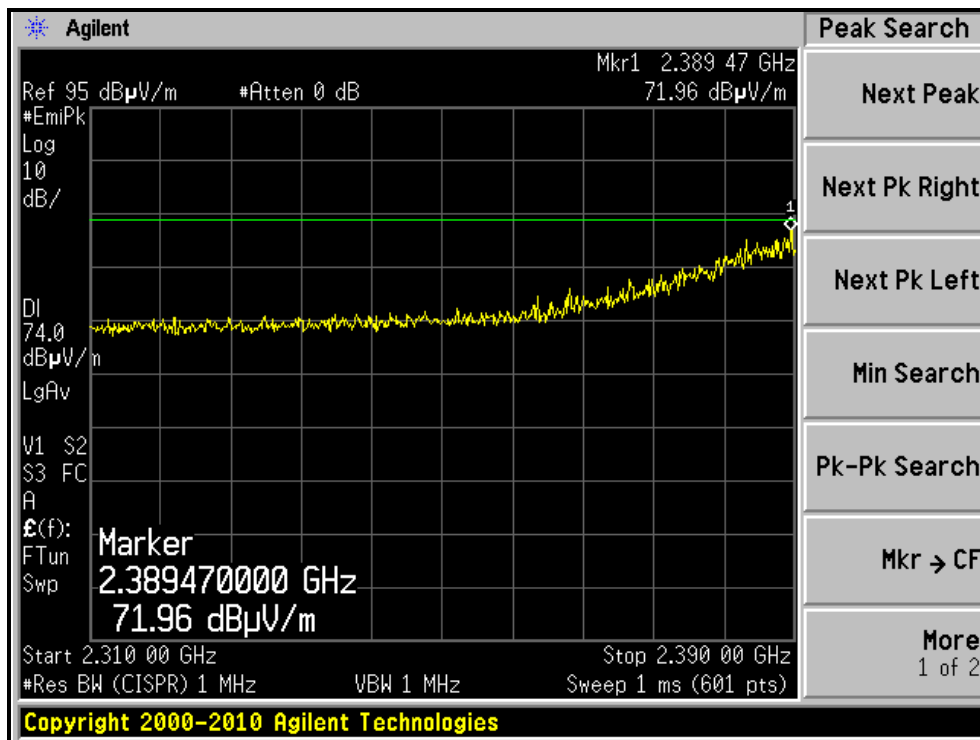



A D T

RESTRICTED BANDEDGE (802.11n (40MHz) MODE,CH3, VERTICAL)

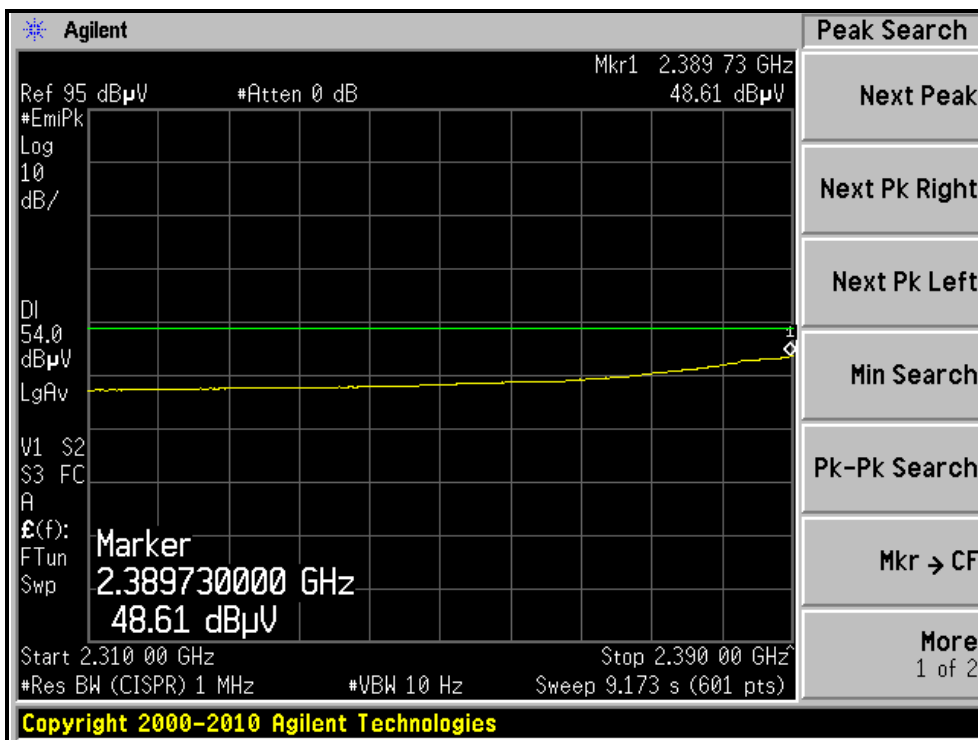
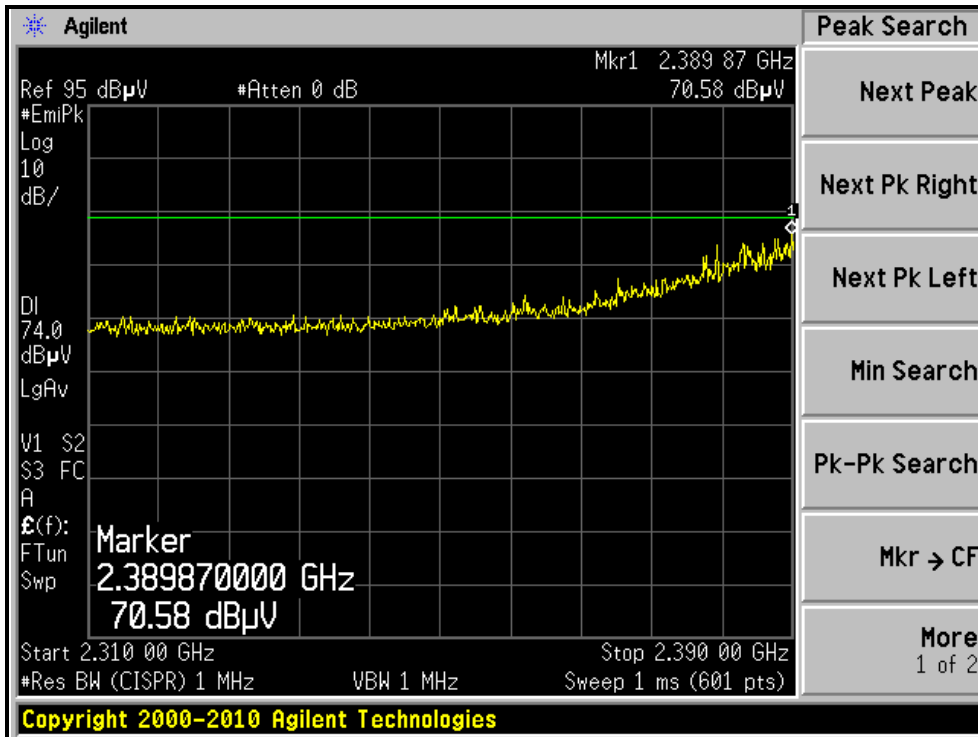



A D T

RESTRICTED BANDEDGE (802.11n (40MHz) MODE,CH9, HORIZONTAL)

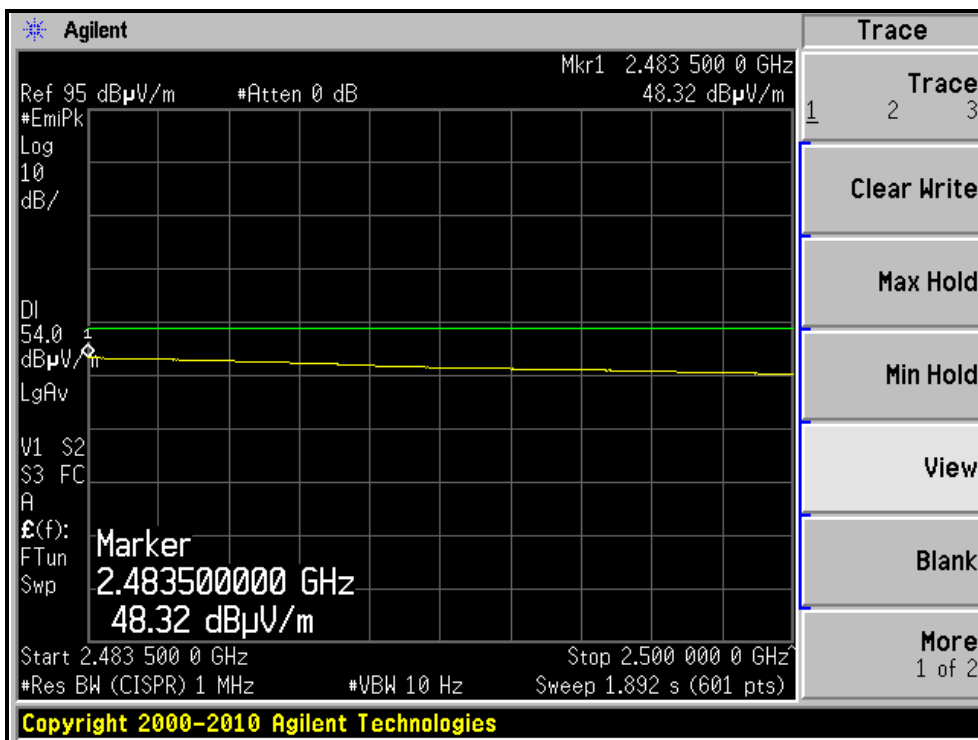
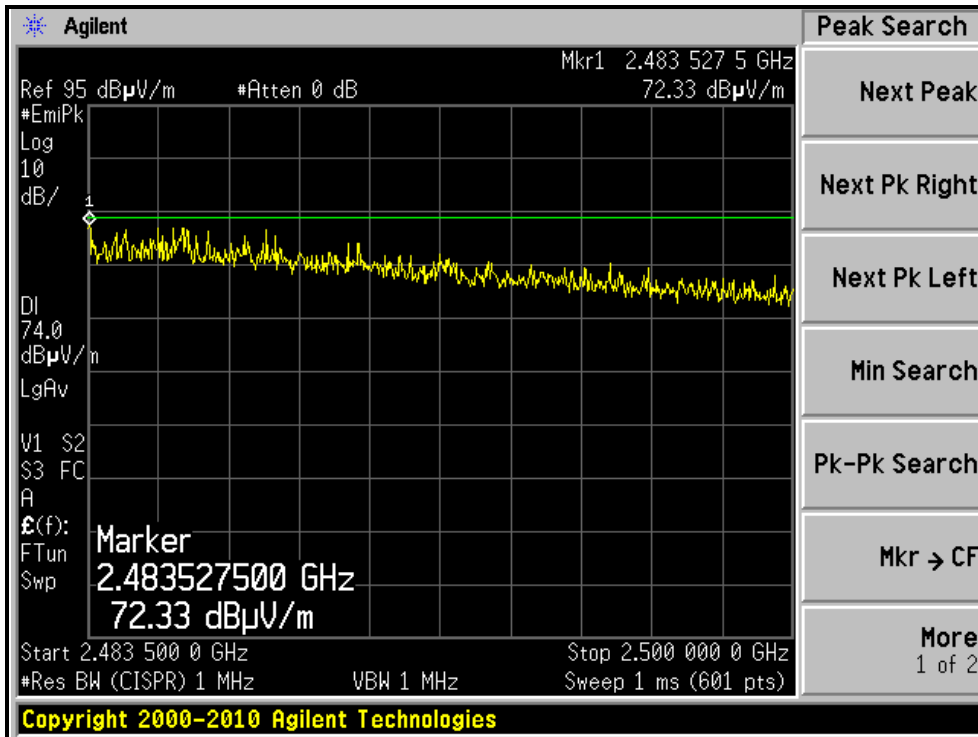



A D T

RESTRICTED BANDEDGE (802.11n (40MHz) MODE,CH9, VERTICAL)

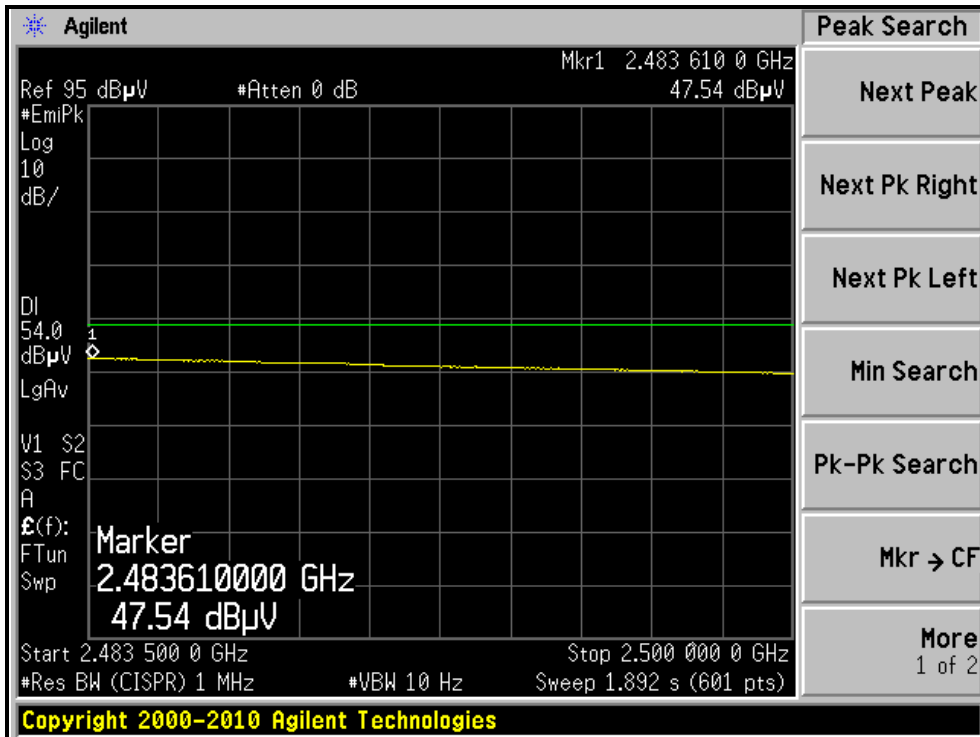
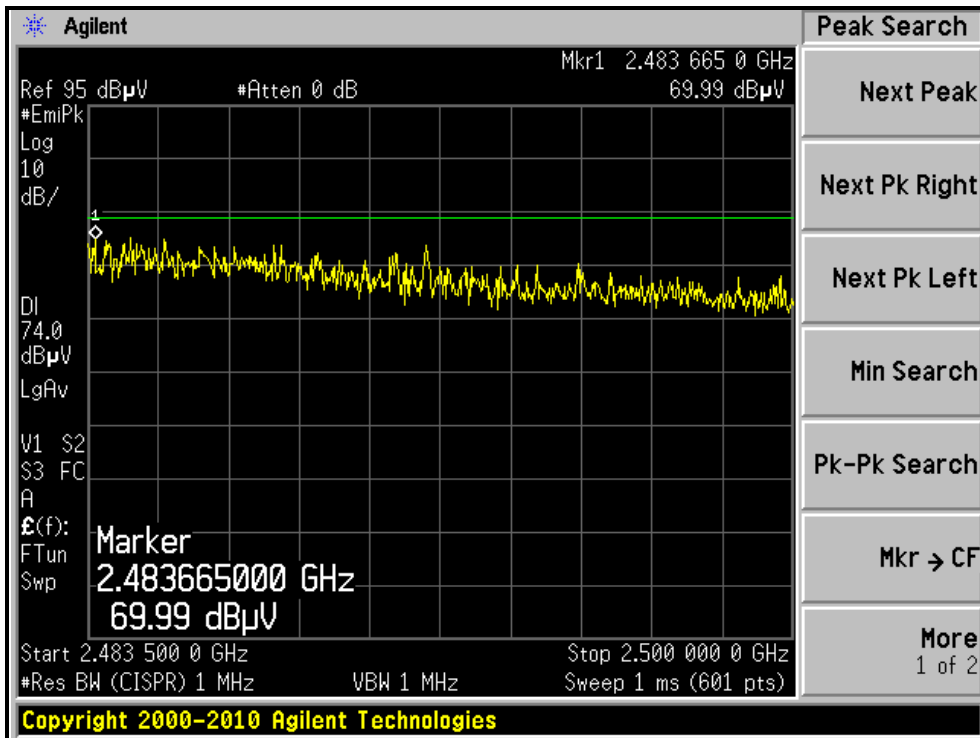



A D T

802.11n (40MHz) OFDM MODULATION <Multiple chain>

EUT TEST CONDITION		MEASUREMENT DETAIL	
CHANNEL	Channel 3	FREQUENCY RANGE	1 ~ 25GHz
INPUT POWER	120Vac, 60 Hz	DETECTOR FUNCTION	Peak (PK) Average (AV)
ENVIRONMENTAL CONDITIONS	24deg. C, 66%RH	TESTED BY	Evan Huang

ANTENNA POLARITY & TEST DISTANCE: HORIZONTAL AT 3 M

NO.	FREQ. (MHz)	EMISSION LEVEL (dBuV/m)	LIMIT (dBuV/m)	MARGIN (dB)	ANTENNA HEIGHT (m)	TABLE ANGLE (Degree)	RAW VALUE (dBuV)	CORRECTION FACTOR (dB/m)
1	2390.00	71.8 PK	74.0	-2.2	1.44 H	327	39.92	31.88
2	2390.00	51.5 AV	54.0	-2.5	1.44 H	327	19.62	31.88
3	*2422.00	112.0 PK			1.44 H	51	80.02	31.98
4	*2422.00	83.6 AV			1.44 H	51	51.62	31.98
5	4844.00	48.0 PK	74.0	-26.0	1.18 H	100	6.72	41.28
6	4844.00	35.7 AV	54.0	-18.3	1.18 H	100	-5.58	41.28
7	7266.00	51.0 PK	74.0	-23.0	1.82 H	73	5.45	45.55
8	7266.00	39.7 AV	54.0	-14.3	1.82 H	73	-5.85	45.55

ANTENNA POLARITY & TEST DISTANCE: VERTICAL AT 3 M

NO.	FREQ. (MHz)	EMISSION LEVEL (dBuV/m)	LIMIT (dBuV/m)	MARGIN (dB)	ANTENNA HEIGHT (m)	TABLE ANGLE (Degree)	RAW VALUE (dBuV)	CORRECTION FACTOR (dB/m)
1	2390.00	71.2 PK	74.0	-2.8	1.00 V	0	39.32	31.88
2	2390.00	50.8 AV	54.0	-3.2	1.00 V	0	18.92	31.88
3	*2422.00	108.4 PK			1.00 V	11	76.42	31.98
4	*2422.00	82.2 AV			1.00 V	11	50.22	31.98
5	4844.00	47.4 PK	74.0	-26.6	1.00 V	79	6.12	41.28
6	4844.00	35.1 AV	54.0	-18.9	1.00 V	79	-6.18	41.28
7	7266.00	50.9 PK	74.0	-23.1	1.00 V	321	5.35	45.55
8	7266.00	39.6 AV	54.0	-14.4	1.00 V	321	-5.95	45.55

- REMARKS:**
1. Emission level (dBuV/m) = Raw Value (dBuV) + Correction Factor (dB/m).
 2. Correction Factor (dB/m) = Antenna Factor (dB/m) + Cable Factor (dB).
 3. The other emission levels were very low against the limit.
 4. Margin value = Emission level – Limit value.
 5. “ * “: Fundamental frequency.



A D T

EUT TEST CONDITION		MEASUREMENT DETAIL	
CHANNEL	Channel 6	FREQUENCY RANGE	1 ~ 25GHz
INPUT POWER	120Vac, 60 Hz	DETECTOR FUNCTION	Peak (PK) Average (AV)
ENVIRONMENTAL CONDITIONS	24deg. C, 66%RH	TESTED BY	Evan Huang

ANTENNA POLARITY & TEST DISTANCE: HORIZONTAL AT 3 M								
NO.	FREQ. (MHz)	EMISSION LEVEL (dBuV/m)	LIMIT (dBuV/m)	MARGIN (dB)	ANTENNA HEIGHT (m)	TABLE ANGLE (Degree)	RAW VALUE (dBuV)	CORRECTION FACTOR (dB/m)
1	*2437.00	112.0 PK			1.42 H	46	79.96	32.04
2	*2437.00	84.4 AV			1.42 H	46	52.36	32.04
3	4874.00	48.2 PK	74.0	-25.8	1.18 H	99	6.84	41.36
4	4874.00	36.8 AV	54.0	-17.2	1.18 H	99	-4.56	41.36
5	7311.00	51.2 PK	74.0	-22.8	1.83 H	69	5.53	45.67
6	7311.00	40.1 AV	54.0	-13.9	1.83 H	69	-5.57	45.67
ANTENNA POLARITY & TEST DISTANCE: VERTICAL AT 3 M								
NO.	FREQ. (MHz)	EMISSION LEVEL (dBuV/m)	LIMIT (dBuV/m)	MARGIN (dB)	ANTENNA HEIGHT (m)	TABLE ANGLE (Degree)	RAW VALUE (dBuV)	CORRECTION FACTOR (dB/m)
1	*2437.00	109.8 PK			1.00 V	13	77.76	32.04
2	*2437.00	83.3 AV			1.00 V	13	51.26	32.04
3	4874.00	47.9 PK	74.0	-26.1	1.00 V	87	6.54	41.36
4	4874.00	36.7 AV	54.0	-17.3	1.00 V	87	-4.66	41.36
5	7311.00	51.4 PK	74.0	-22.6	1.00 V	323	5.73	45.67
6	7311.00	39.5 AV	54.0	-14.5	1.00 V	323	-6.17	45.67

- REMARKS:**
1. Emission level (dBuV/m) = Raw Value (dBuV) + Correction Factor (dB/m).
 2. Correction Factor (dB/m) = Antenna Factor (dB/m) + Cable Factor (dB).
 3. The other emission levels were very low against the limit.
 4. Margin value = Emission level – Limit value.
 5. “ * “: Fundamental frequency.



A D T

EUT TEST CONDITION		MEASUREMENT DETAIL	
CHANNEL	Channel 9	FREQUENCY RANGE	1 ~ 25GHz
INPUT POWER	120Vac, 60 Hz	DETECTOR FUNCTION	Peak (PK) Average (AV)
ENVIRONMENTAL CONDITIONS	24deg. C, 66%RH	TESTED BY	Evan Huang

ANTENNA POLARITY & TEST DISTANCE: HORIZONTAL AT 3 M								
NO.	FREQ. (MHz)	EMISSION LEVEL (dBuV/m)	LIMIT (dBuV/m)	MARGIN (dB)	ANTENNA HEIGHT (m)	TABLE ANGLE (Degree)	RAW VALUE (dBuV)	CORRECTION FACTOR (dB/m)
1	*2452.00	111.0 PK			1.44 H	55	78.91	32.09
2	*2452.00	83.2 AV			1.44 H	55	51.11	32.09
3	2483.50	73.0 PK	74.0	-1.0	1.44 H	47	40.81	32.19
4	2483.50	52.0 AV	54.0	-2.0	1.44 H	47	19.81	32.19
5	4904.00	47.3 PK	74.0	-26.7	1.19 H	94	5.86	41.44
6	4904.00	36.1 AV	54.0	-17.9	1.19 H	94	-5.34	41.44
7	7356.00	50.9 PK	74.0	-23.1	1.83 H	70	5.09	45.81
8	7356.00	39.6 AV	54.0	-14.4	1.83 H	70	-6.21	45.81
ANTENNA POLARITY & TEST DISTANCE: VERTICAL AT 3 M								
NO.	FREQ. (MHz)	EMISSION LEVEL (dBuV/m)	LIMIT (dBuV/m)	MARGIN (dB)	ANTENNA HEIGHT (m)	TABLE ANGLE (Degree)	RAW VALUE (dBuV)	CORRECTION FACTOR (dB/m)
1	*2452.00	107.5 PK			1.00 V	11	75.41	32.09
2	*2452.00	81.5 AV			1.00 V	11	49.41	32.09
3	2483.50	71.1 PK	74.0	-2.9	1.18 V	11	38.91	32.19
4	2483.50	50.8 AV	54.0	-3.2	1.18 V	11	18.61	32.19
5	4904.00	47.4 PK	74.0	-26.6	1.01 V	81	5.96	41.44
6	4904.00	36.0 AV	54.0	-18.0	1.01 V	81	-5.44	41.44
7	7356.00	50.8 PK	74.0	-23.2	1.00 V	333	4.99	45.81
8	7356.00	36.1 AV	54.0	-17.9	1.00 V	333	-9.71	45.81

- REMARKS:**
1. Emission level (dBuV/m) = Raw Value (dBuV) + Correction Factor (dB/m).
 2. Correction Factor (dB/m) = Antenna Factor (dB/m) + Cable Factor (dB).
 3. The other emission levels were very low against the limit.
 4. Margin value = Emission level – Limit value.
 5. “ * “: Fundamental frequency.



A D T

RESTRICTED BANDEDGE (802.11n (40MHz) MODE,CH3, HORIZONTAL)

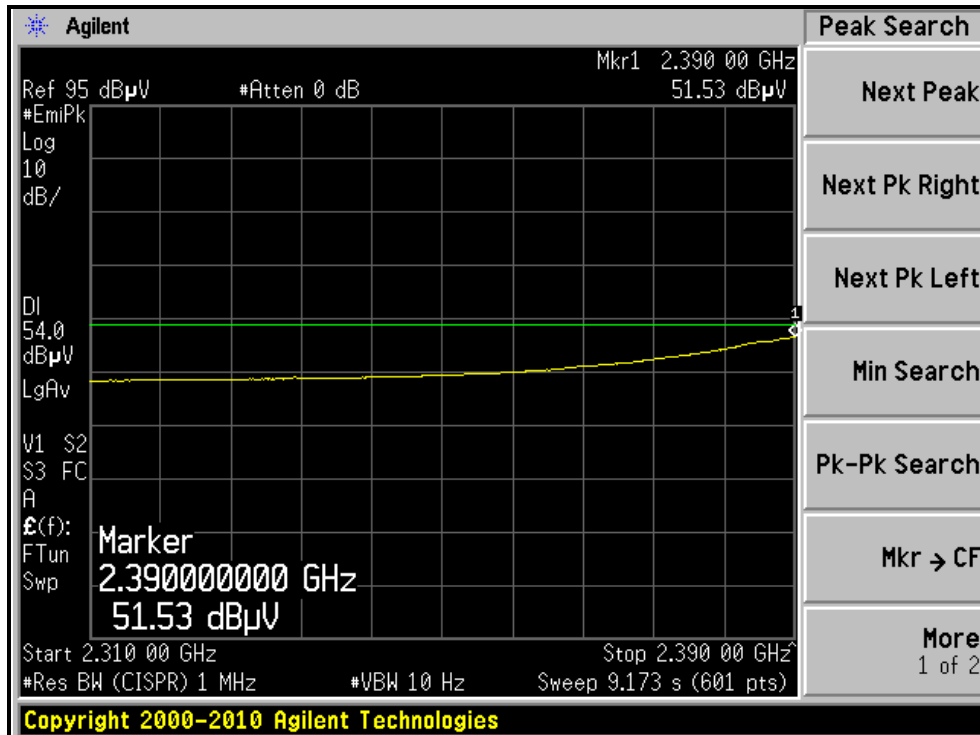
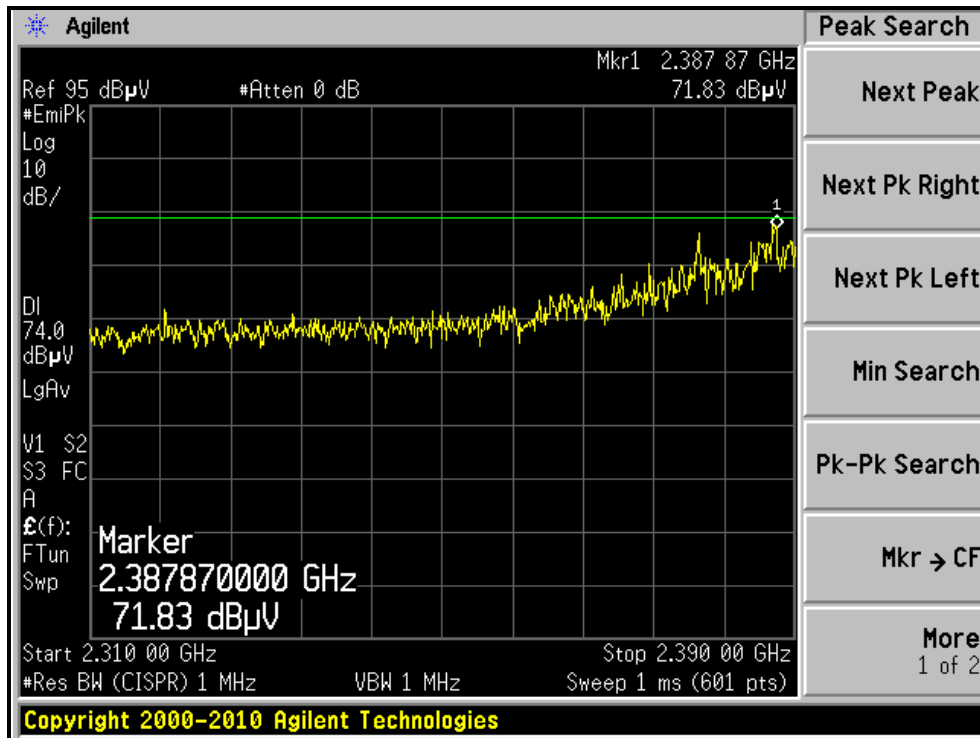



A D T

RESTRICTED BANDEDGE (802.11n (40MHz) MODE,CH3, VERTICAL)

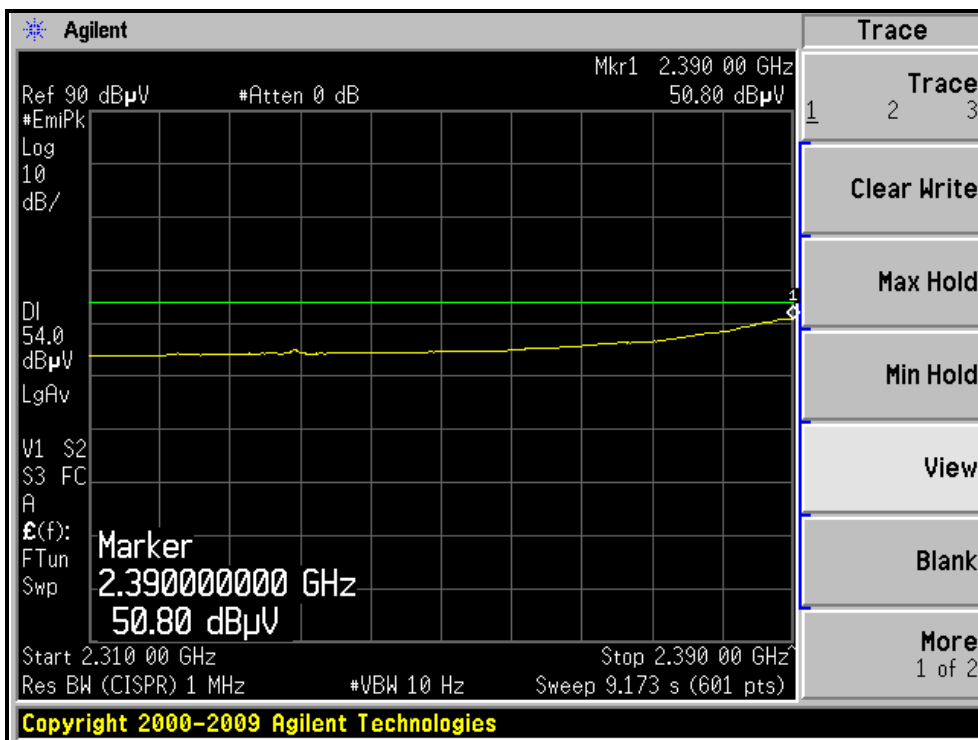
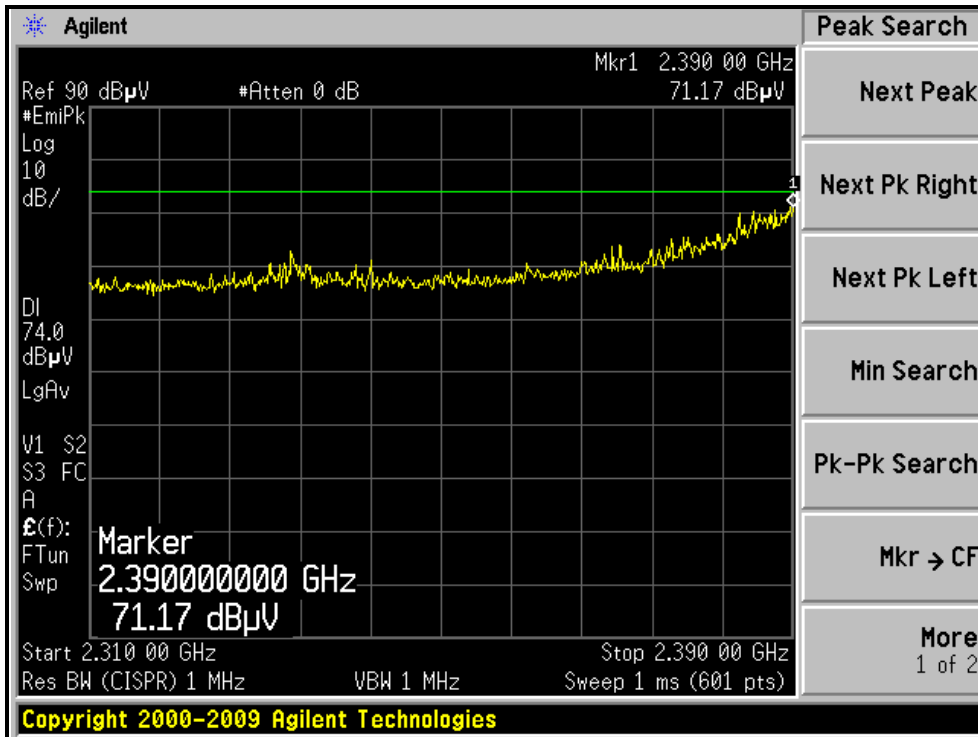

RESTRICTED BANDEDGE (802.11n (40MHz) MODE,CH9, HORIZONTAL)

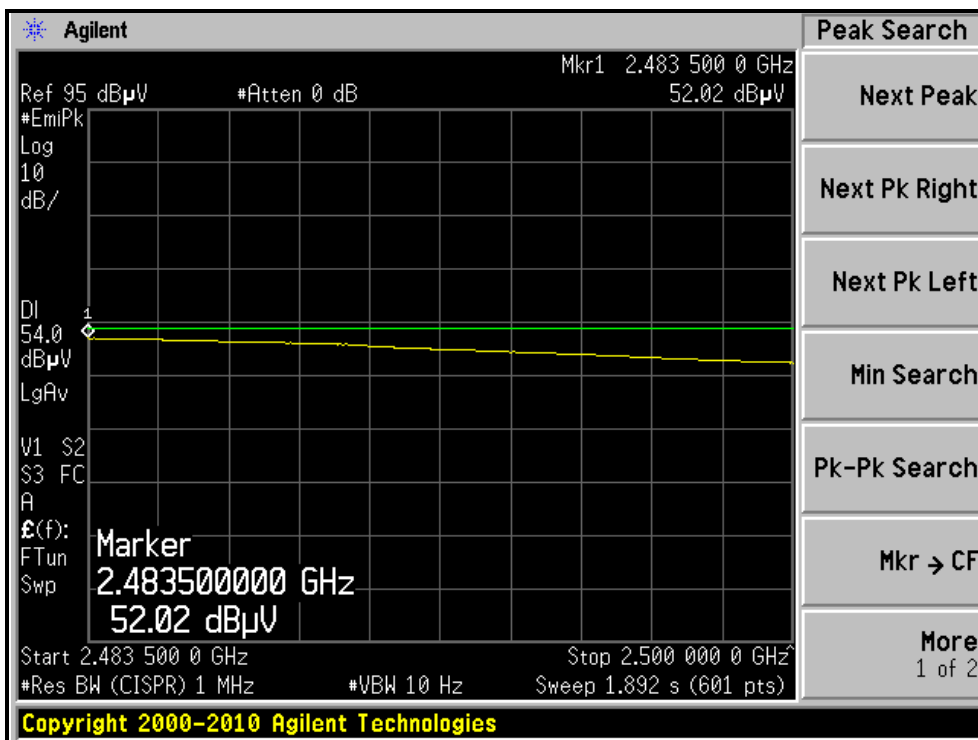
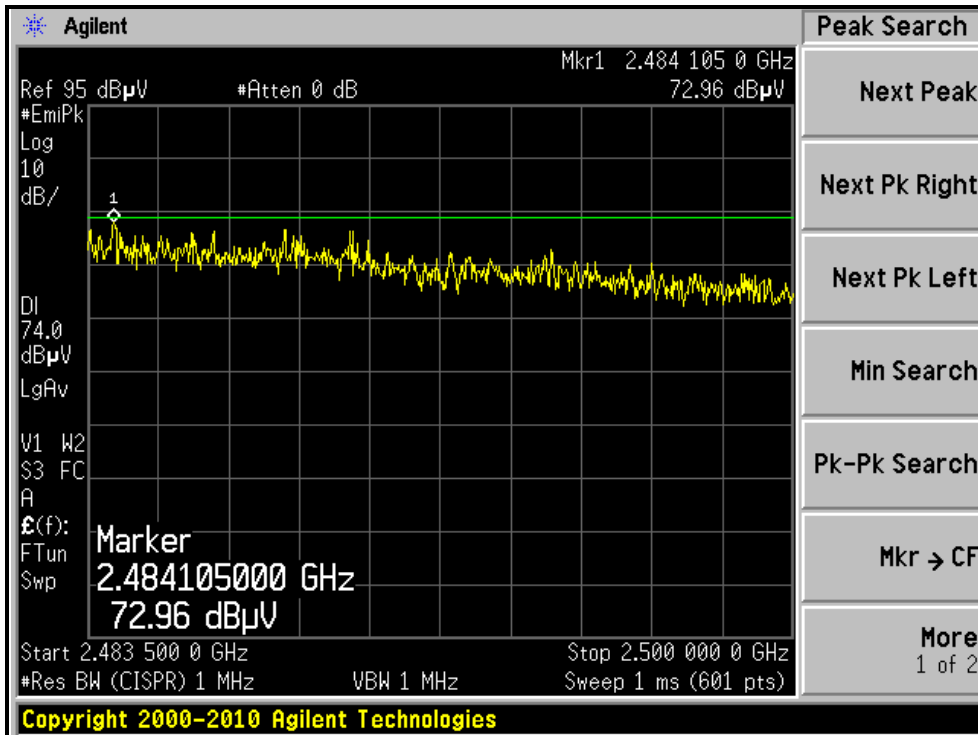

RESTRICTED BANDEDGE (802.11n (40MHz) MODE,CH9, VERTICAL)

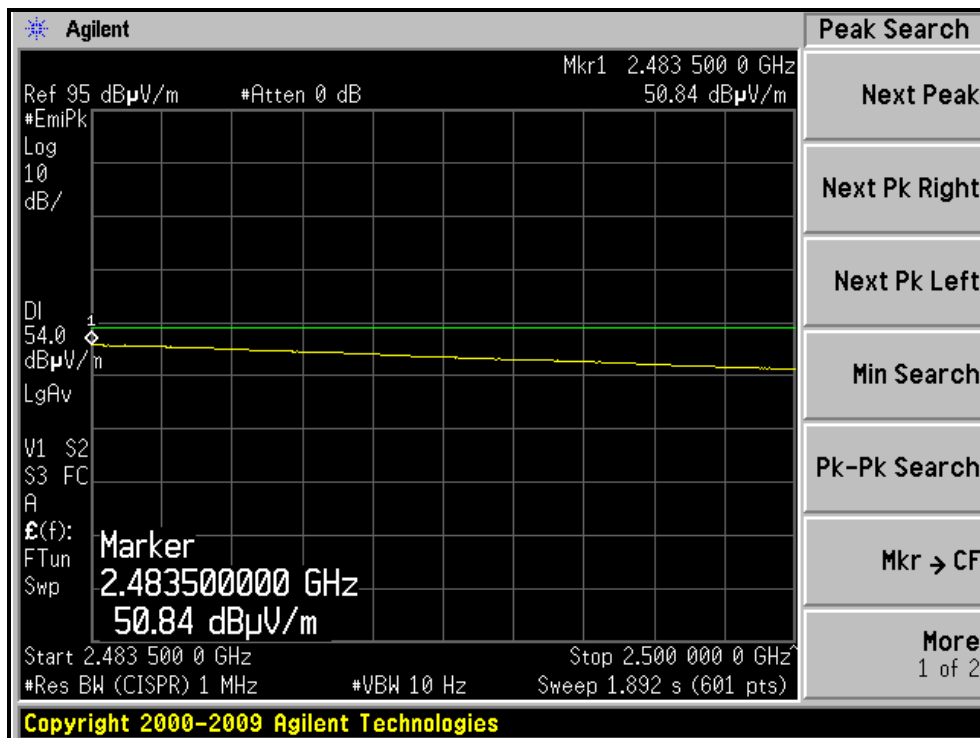
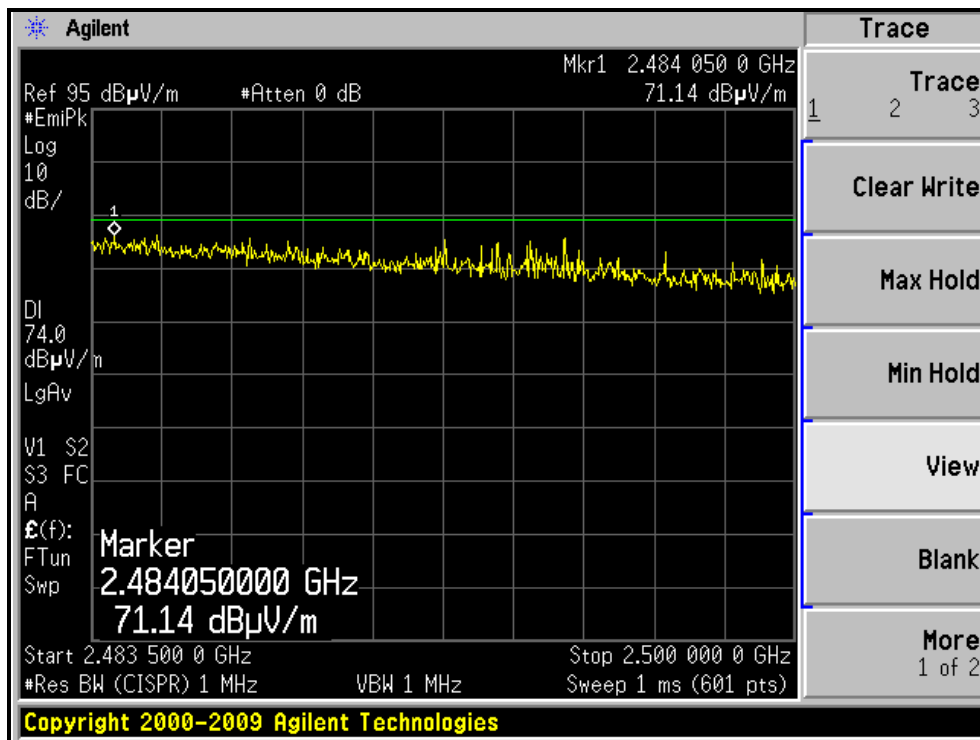

4.3 6DB BANDWIDTH MEASUREMENT

4.3.1 LIMITS OF 6dB BANDWIDTH MEASUREMENT

The minimum of 6dB Bandwidth Measurement is 0.5 MHz.

4.3.2 TEST INSTRUMENTS

Test date: Sep. 27, 2011

DESCRIPTION & MANUFACTURER	MODEL NO.	SERIAL NO.	CALIBRATED DATE	CALIBRATED UNTIL
R&S Spectrum Analyzer	FSP 40	100060	May 11, 2011	May 10, 2012

NOTE: The calibration interval of the above test instruments is 12 months and the calibrations are traceable to NML/ROC and NIST/USA.

4.3.3 TEST PROCEDURE

The transmitter output was connected to the spectrum analyzer through an attenuator. The bandwidth of the fundamental frequency was measured by spectrum analyzer with 100kHz RBW and 300kHz VBW. The 6dB bandwidth is defined as the total spectrum the power of which is higher than peak power minus 6dB.

4.3.4 DEVIATION FROM TEST STANDARD

No deviation

4.3.5 TEST SETUP



4.3.6 EUT OPERATING CONDITIONS

The software provided by client to enable the EUT under transmission condition continuously at lowest, middle and highest channel frequencies individually.

4.3.7 TEST RESULTS

802.11b DSSS MODULATION <Single chain (0)>:

CHANNEL	CHANNEL FREQUENCY (MHz)	6dB BANDWIDTH (MHz)	MINIMUM LIMIT (MHz)	PASS / FAIL
1	2412	8.73	0.5	PASS
6	2437	7.88	0.5	PASS
11	2462	8.54	0.5	PASS

CH1

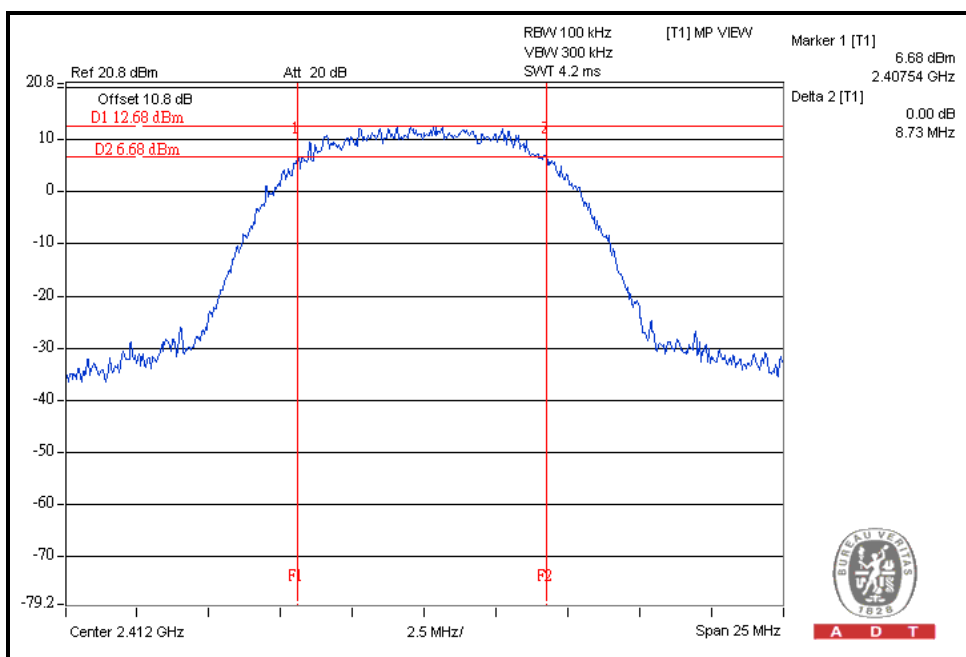



A D T

802.11b DSSS MODULATION <Single chain (1)>:

CHANNEL	CHANNEL FREQUENCY (MHz)	6dB BANDWIDTH (MHz)	MINIMUM LIMIT (MHz)	PASS / FAIL
1	2412	8.50	0.5	PASS
6	2437	8.02	0.5	PASS
11	2462	8.09	0.5	PASS

CH1

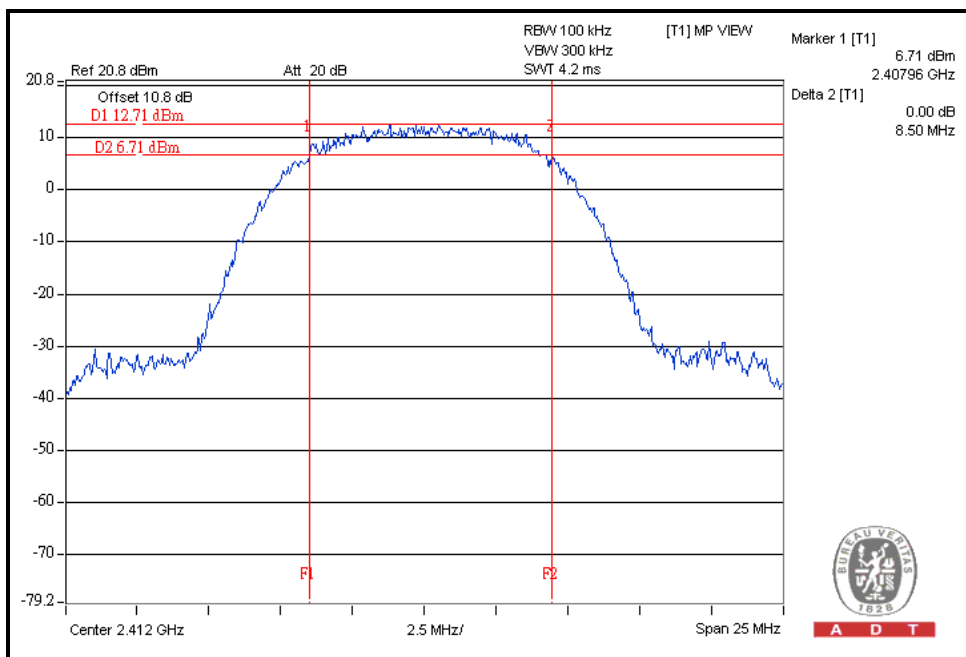

802.11g OFDM MODULATION <Single chain (0)>:

CHANNEL	CHANNEL FREQUENCY (MHz)	6dB BANDWIDTH (MHz)	MINIMUM LIMIT (MHz)	PASS / FAIL
1	2412	16.50	0.5	PASS
6	2437	16.40	0.5	PASS
11	2462	16.50	0.5	PASS

CH1

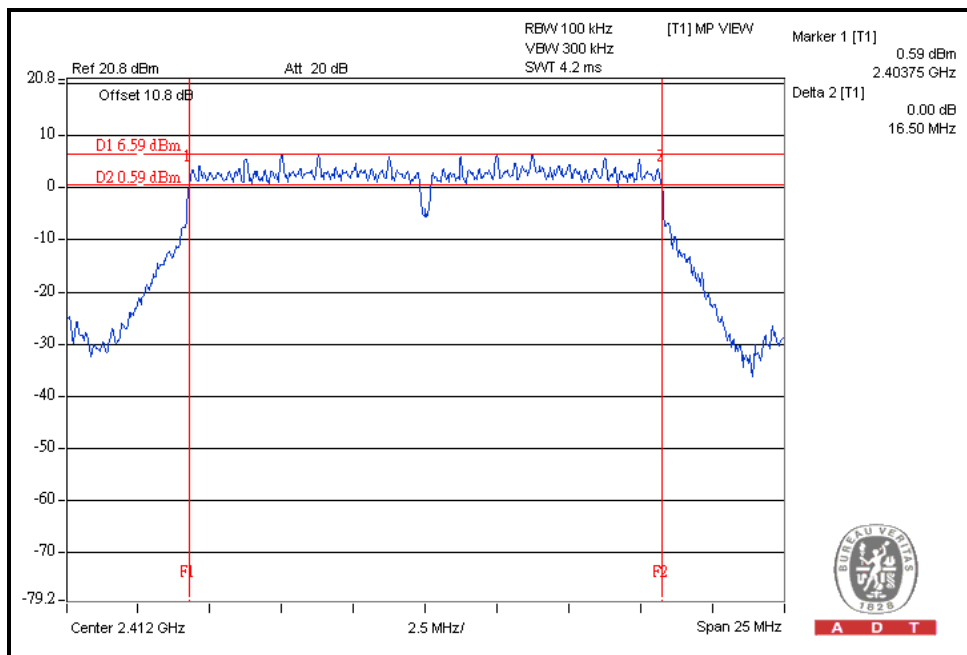

802.11g OFDM MODULATION <Single chain (1)>:

CHANNEL	CHANNEL FREQUENCY (MHz)	6dB BANDWIDTH (MHz)	MINIMUM LIMIT (MHz)	PASS / FAIL
1	2412	16.48	0.5	PASS
6	2437	16.44	0.5	PASS
11	2462	16.50	0.5	PASS

CH11

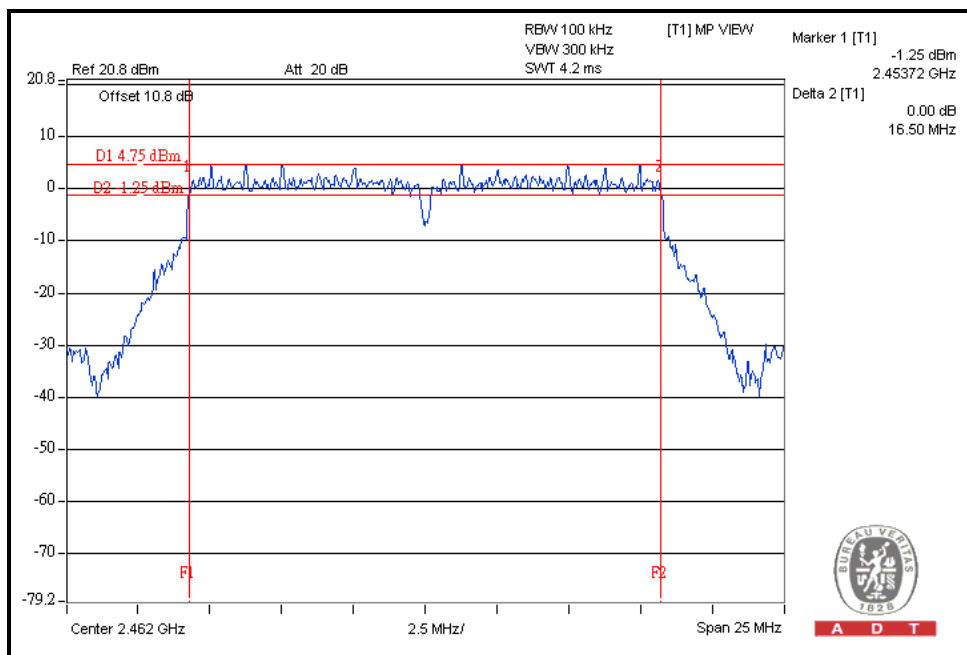



A D T

802.11n (20MHz) OFDM MODULATION <Single chain (0)>:

CHANNEL	CHANNEL FREQUENCY (MHz)	6dB BANDWIDTH (MHz)	MINIMUM LIMIT (MHz)	PASS / FAIL
1	2412	17.67	0.5	PASS
6	2437	17.65	0.5	PASS
11	2462	17.66	0.5	PASS

CH1

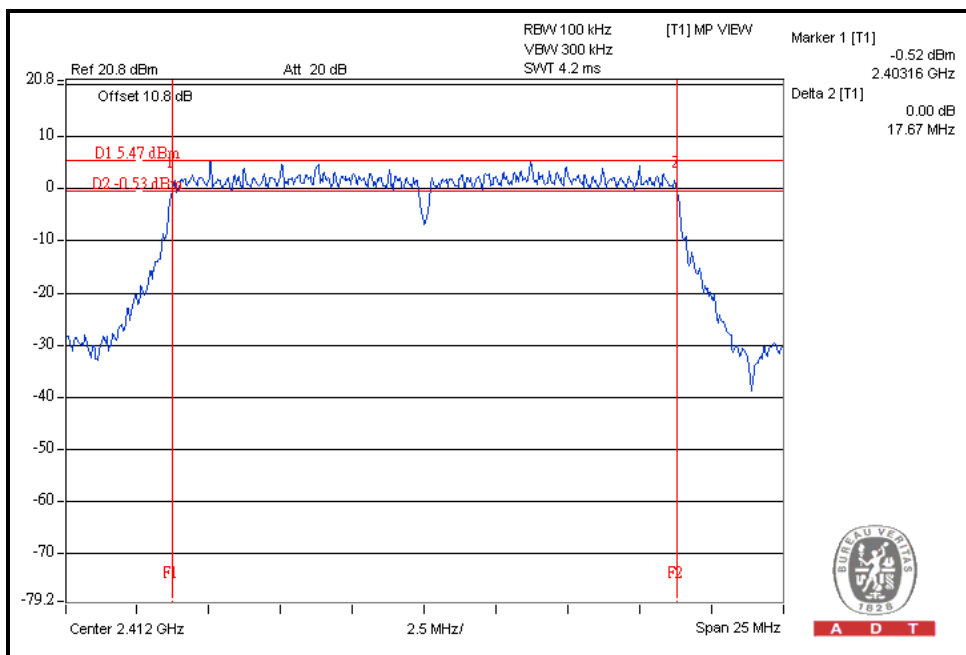

802.11n (20MHz) OFDM MODULATION <Single chain (1)>:

CHANNEL	CHANNEL FREQUENCY (MHz)	6dB BANDWIDTH (MHz)	MINIMUM LIMIT (MHz)	PASS / FAIL
1	2412	17.69	0.5	PASS
6	2437	17.60	0.5	PASS
11	2462	17.63	0.5	PASS

CH1

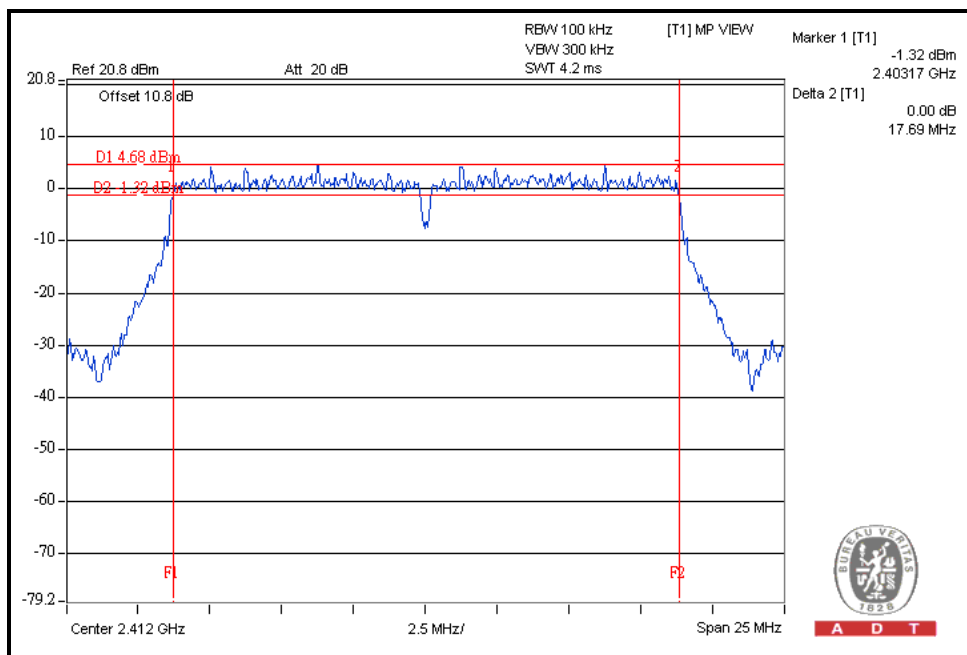

802.11n (20MHz) OFDM MODULATION <Multiple chain>:

CHANNEL	CHANNEL FREQUENCY (MHz)	6dB BANDWIDTH (MHz)		MINIMUM LIMIT (MHz)	PASS / FAIL
		CHAIN(0)	CHAIN(1)		
1	2412	17.64	17.63	0.5	PASS
6	2437	17.64	17.63	0.5	PASS
11	2462	17.64	17.65	0.5	PASS

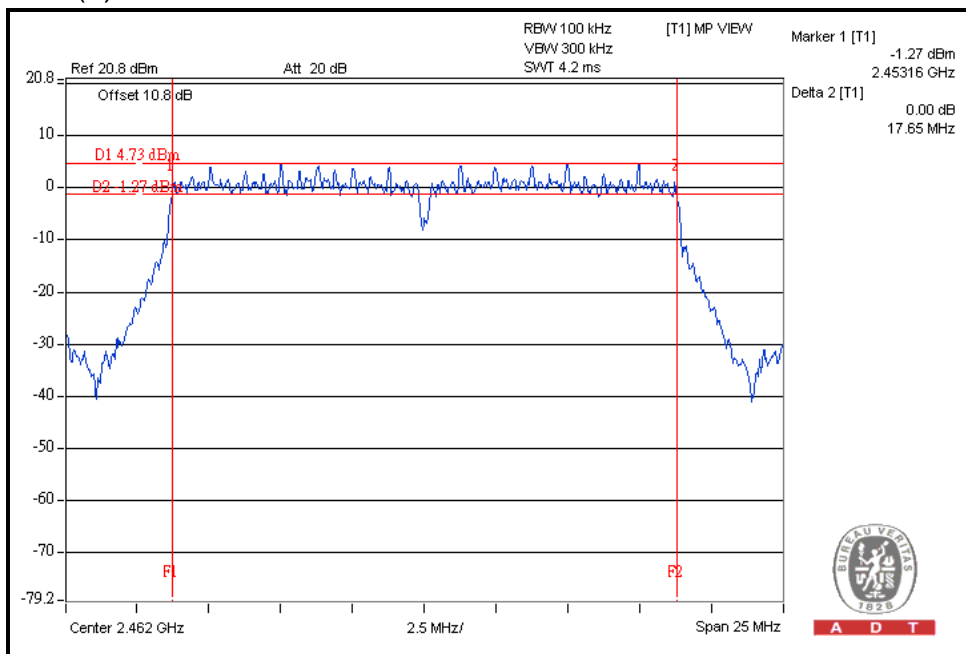
CHAIN (1):CH11



A D T

802.11n (40MHz) OFDM MODULATION <Single chain(1)>:

CHANNEL	CHANNEL FREQUENCY (MHz)	6dB BANDWIDTH (MHz)	MINIMUM LIMIT (MHz)	PASS / FAIL
3	2422	35.17	0.5	PASS
6	2437	35.35	0.5	PASS
9	2452	35.11	0.5	PASS

CH6

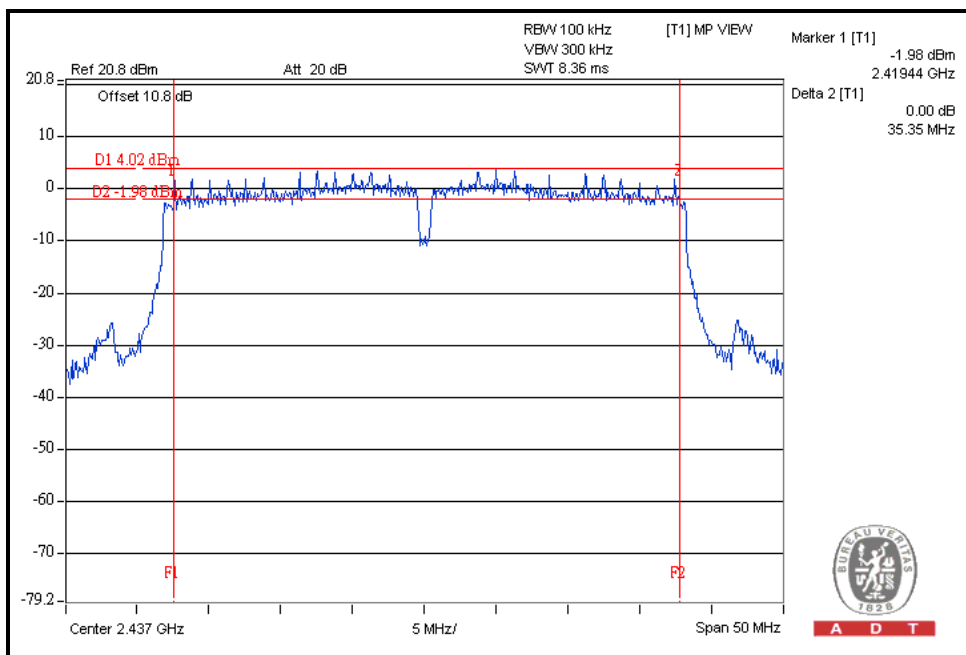

A D T

802.11n (40MHz) OFDM MODULATION <Multiple chain>:

CHANNEL	CHANNEL FREQUENCY (MHz)	6dB BANDWIDTH (MHz)		MINIMUM LIMIT (MHz)	PASS / FAIL
		CHAIN(0)	CHAIN(1)		
3	2422	35.36	35.56	0.5	PASS
6	2437	35.21	35.52	0.5	PASS
9	2452	35.46	35.74	0.5	PASS

CHAIN (1):CH9

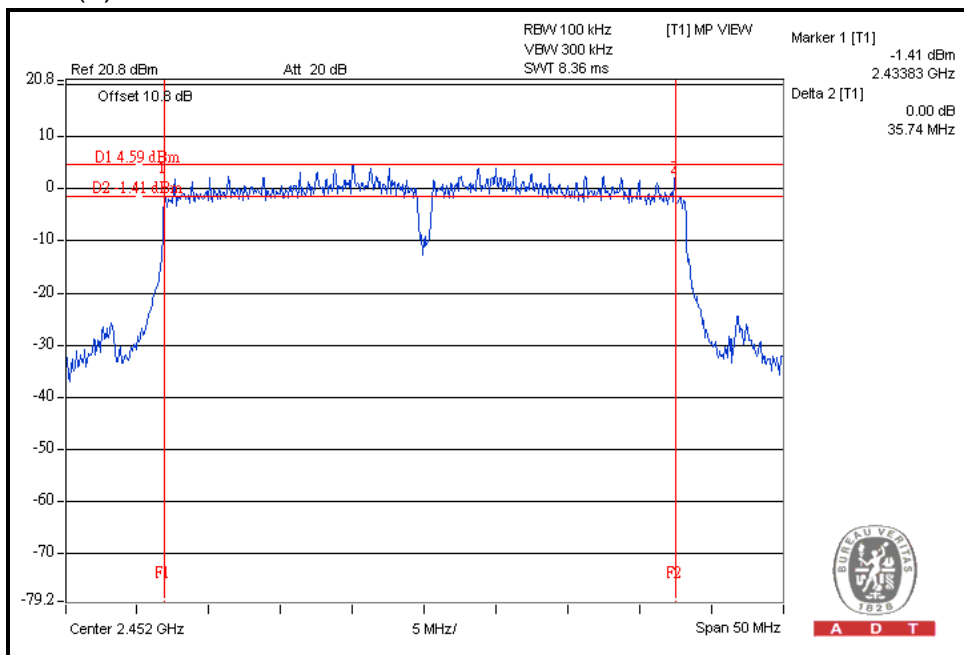

4.4 MAXIMUM PEAK OUTPUT POWER

4.4.1 LIMITS OF MAXIMUM PEAK OUTPUT POWER MEASUREMENT

The Maximum Peak Output Power Measurement is 30dBm.

4.4.2 INSTRUMENTS

Test date: Sep. 27, 2011

DESCRIPTION & MANUFACTURER	MODEL NO.	SERIAL NO.	CALIBRATED DATE	CALIBRATED UNTIL
Anritsu Power Meter	ML2495A	0824006	May 04, 2011	May 03, 2012
Pulse Power Sensor	MA2411B	0738172	May 03, 2011	May 02, 2012

NOTE: The calibration interval of the above test instruments is 12 months and the calibrations are traceable to NML/ROC and NIST/USA.

4.4.3 TEST PROCEDURES

1. The transmitter output was connected to the power meter through an attenuator; the bandwidth of the fundamental frequency was measured with the power meter.
2. Record the power level.

4.4.4 DEVIATION FROM TEST STANDARD

No deviation

4.4.5 TEST SETUP

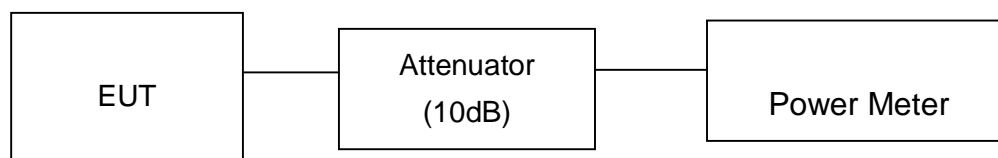

4.4.6 EUT OPERATING CONDITIONS

Same as Item 4.3.6



A D T

4.4.7 TEST RESULTS

802.11b DSSS MODULATION <Single Chain(0)>:

CHANNEL	CHANNEL FREQUENCY (MHz)	PEAK POWER OUTPUT (mW)	PEAK POWER OUTPUT (dBm)	PEAK POWER LIMIT (dBm)	PASS / FAIL
1	2412	436.5	26.4	30	PASS
6	2437	660.7	28.2	30	PASS
11	2462	467.7	26.7	30	PASS

802.11b DSSS MODULATION <Single Chain(1)>:

CHANNEL	CHANNEL FREQUENCY (MHz)	PEAK POWER OUTPUT (mW)	PEAK POWER OUTPUT (dBm)	PEAK POWER LIMIT (dBm)	PASS / FAIL
1	2412	457.1	26.6	30	PASS
6	2437	616.6	27.9	30	PASS
11	2462	416.9	26.2	30	PASS

802.11g OFDM MODULATION <Single Chain(0)>:

CHANNEL	CHANNEL FREQUENCY (MHz)	PEAK POWER OUTPUT (mW)	PEAK POWER OUTPUT (dBm)	PEAK POWER LIMIT (dBm)	PASS / FAIL
1	2412	501.2	27.0	30	PASS
6	2437	794.3	29.0	30	PASS
11	2462	407.4	26.1	30	PASS

802.11g OFDM MODULATION <Single Chain(1)>:

CHANNEL	CHANNEL FREQUENCY (MHz)	PEAK POWER OUTPUT (mW)	PEAK POWER OUTPUT (dBm)	PEAK POWER LIMIT (dBm)	PASS / FAIL
1	2412	478.6	26.8	30	PASS
6	2437	758.6	28.8	30	PASS
11	2462	389.0	25.9	30	PASS



A D T

802.11n (20MHz) OFDM MODULATION <Single Chain(0)>:

CHANNEL	CHANNEL FREQUENCY (MHz)	PEAK POWER OUTPUT (mW)	PEAK POWER OUTPUT (dBm)	PEAK POWER LIMIT (dBm)	PASS / FAIL
1	2412	407.4	26.1	30	PASS
6	2437	776.2	28.9	30	PASS
11	2462	389.0	25.9	30	PASS

802.11n (20MHz) OFDM MODULATION <Single Chain(1)>:

CHANNEL	CHANNEL FREQUENCY (MHz)	PEAK POWER OUTPUT (mW)	PEAK POWER OUTPUT (dBm)	PEAK POWER LIMIT (dBm)	PASS / FAIL
1	2412	389.0	25.9	30	PASS
6	2437	741.3	28.7	30	PASS
11	2462	363.1	25.6	30	PASS

802.11n (20MHz) OFDM MODULATION <Multiple chain >:

CHANNEL	CHANNEL FREQUENCY (MHz)	PEAK POWER OUTPUT (dBm)		TOTAL PEAK POWER (mW)	TOTAL PEAK POWER (dBm)	PEAK POWER LIMIT (dBm)	PASS / FAIL
		CHAIN(0)	CHAIN(1)				
1	2412	24.9	25.3	647.9	28.1	30	PASS
6	2437	26.3	26.9	916.4	29.6	30	PASS
11	2462	25.1	25.6	686.7	28.4	30	PASS



A D T

802.11n (40MHz) OFDM MODULATION <Single Chain(0)>:

CHANNEL	CHANNEL FREQUENCY (MHz)	PEAK POWER OUTPUT (mW)	PEAK POWER OUTPUT (dBm)	PEAK POWER LIMIT (dBm)	PASS / FAIL
3	2422	489.8	26.9	30	PASS
6	2437	588.8	27.7	30	PASS
9	2452	407.4	26.1	30	PASS

802.11n (40MHz) OFDM MODULATION <Single Chain(1)>:

CHANNEL	CHANNEL FREQUENCY (MHz)	PEAK POWER OUTPUT (mW)	PEAK POWER OUTPUT (dBm)	PEAK POWER LIMIT (dBm)	PASS / FAIL
3	2422	407.4	26.1	30	PASS
6	2437	467.7	26.7	30	PASS
9	2452	354.8	25.5	30	PASS

802.11n (40MHz) OFDM MODULATION <Multiple chain >:

CHANNEL	CHANNEL FREQUENCY (MHz)	PEAK POWER OUTPUT (dBm)		TOTAL PEAK POWER (mW)	TOTAL PEAK POWER (dBm)	PEAK POWER LIMIT (dBm)	PASS / FAIL
		CHAIN(0)	CHAIN(1)				
3	2422	26.5	26.7	914.4	29.6	30	PASS
6	2437	26.8	26.9	968.4	29.9	30	PASS
9	2452	26.5	26.6	903.8	29.6	30	PASS

4.5 POWER SPECTRAL DENSITY MEASUREMENT

4.5.1 LIMITS OF POWER SPECTRAL DENSITY MEASUREMENT

The Maximum of Power Spectral Density Measurement is 8dBm.

4.5.2 TEST INSTRUMENTS

Test date: Sep. 27, 2011

DESCRIPTION & MANUFACTURER	MODEL NO.	SERIAL NO.	CALIBRATED DATE	CALIBRATED UNTIL
R&S Spectrum Analyzer	FSP 40	100060	May 11, 2011	May 10, 2012

NOTE: The calibration interval of the above test instruments is 12 months and the calibrations are traceable to NML/ROC and NIST/USA.

4.5.3 TEST PROCEDURE

The transmitter output was connected to the spectrum analyzer through an attenuator, the bandwidth of the fundamental frequency was measured with the spectrum analyzer using 3kHz RBW and 30kHz VBW, set sweep time = span/3kHz. The power spectral density was measured and recorded. The sweep time is allowed to be longer than span/3kHz for a full response of the mixer in the spectrum analyzer.

4.5.4 DEVIATION FROM TEST STANDARD

No deviation

4.5.5 TEST SETUP

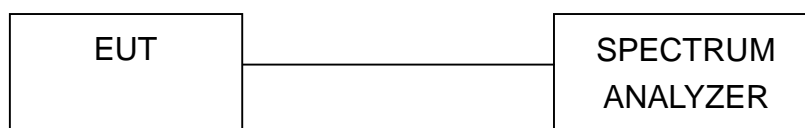

4.5.6 EUT OPERATING CONDITION

Same as Item 4.3.6



A D T

4.5.7 TEST RESULTS

802.11b DSSS MODULATION <Single chain(0)>:

CHANNEL	CHANNEL FREQUENCY (MHz)	RF POWER LEVEL IN 3kHz BW (dBm)	MAXIMUM LIMIT (dBm)	PASS / FAIL
1	2412	-0.4	8	PASS
6	2437	2.1	8	PASS
11	2462	0.5	8	PASS

CH6

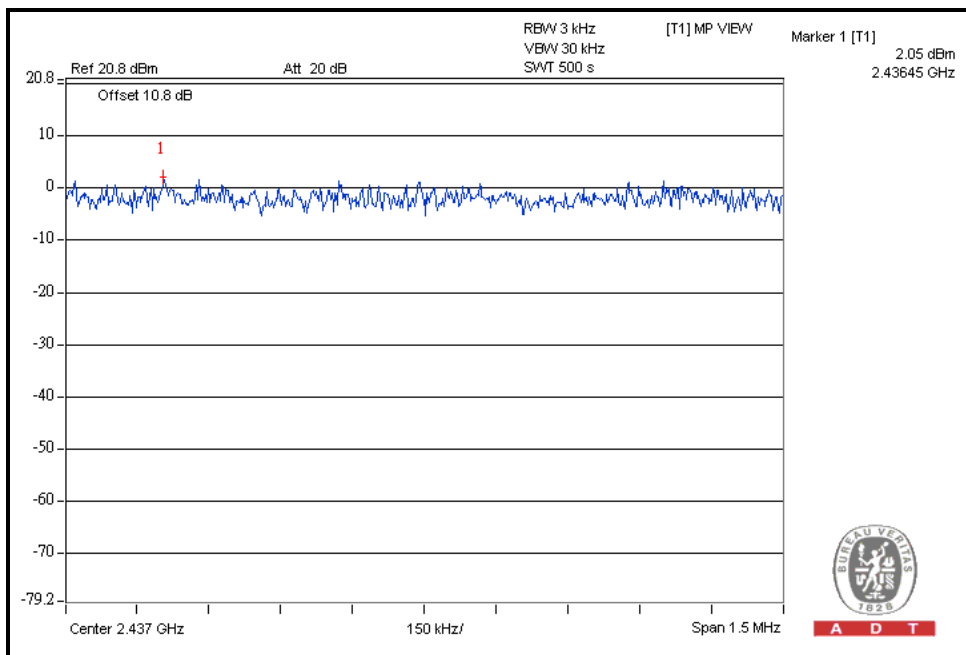



A D T

802.11b DSSS MODULATION <Single chain(1)>:

CHANNEL	CHANNEL FREQUENCY (MHz)	RF POWER LEVEL IN 3kHz BW (dBm)	MAXIMUM LIMIT (dBm)	PASS / FAIL
1	2412	0.7	8	PASS
6	2437	1.2	8	PASS
11	2462	0.2	8	PASS

CH6

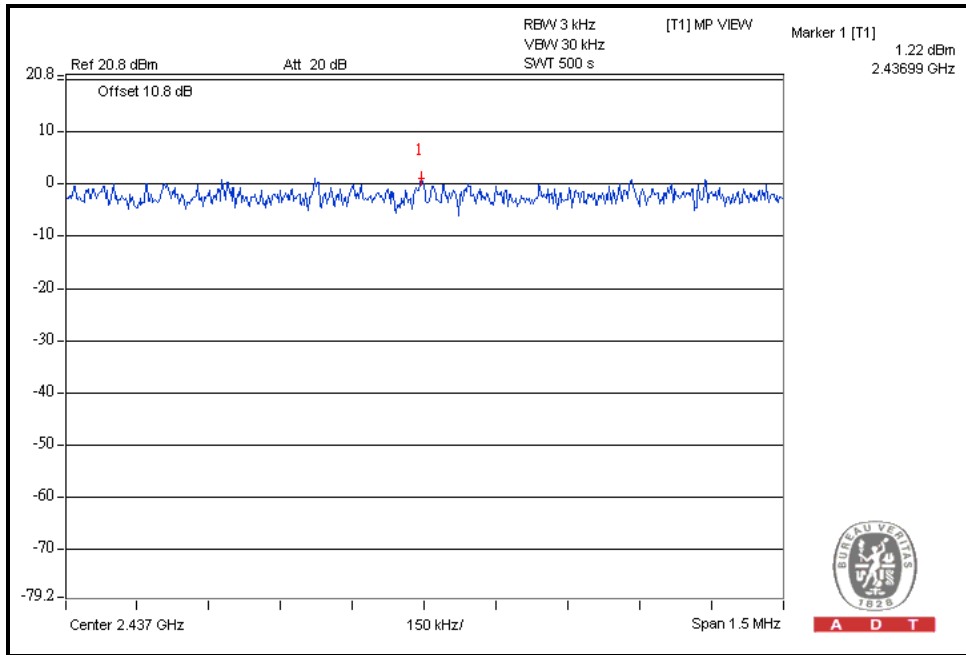



A D T

802.11g OFDM MODULATION <Single chain(0)>:

CHANNEL	CHANNEL FREQUENCY (MHz)	RF POWER LEVEL IN 3kHz BW (dBm)	MAXIMUM LIMIT (dBm)	PASS / FAIL
1	2412	-7.3	8	PASS
6	2437	-3.2	8	PASS
11	2462	-7.1	8	PASS

CH6

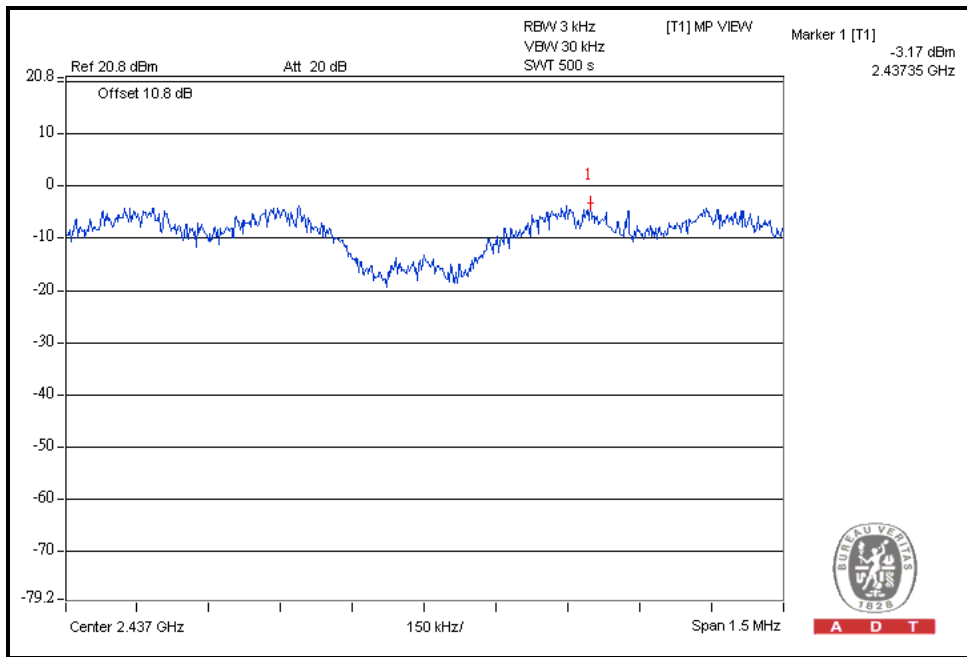



A D T

802.11g OFDM MODULATION <Single chain(1)>:

CHANNEL	CHANNEL FREQUENCY (MHz)	RF POWER LEVEL IN 3kHz BW (dBm)	MAXIMUM LIMIT (dBm)	PASS / FAIL
1	2412	-7.6	8	PASS
6	2437	-3.4	8	PASS
11	2462	-9.6	8	PASS

CH6

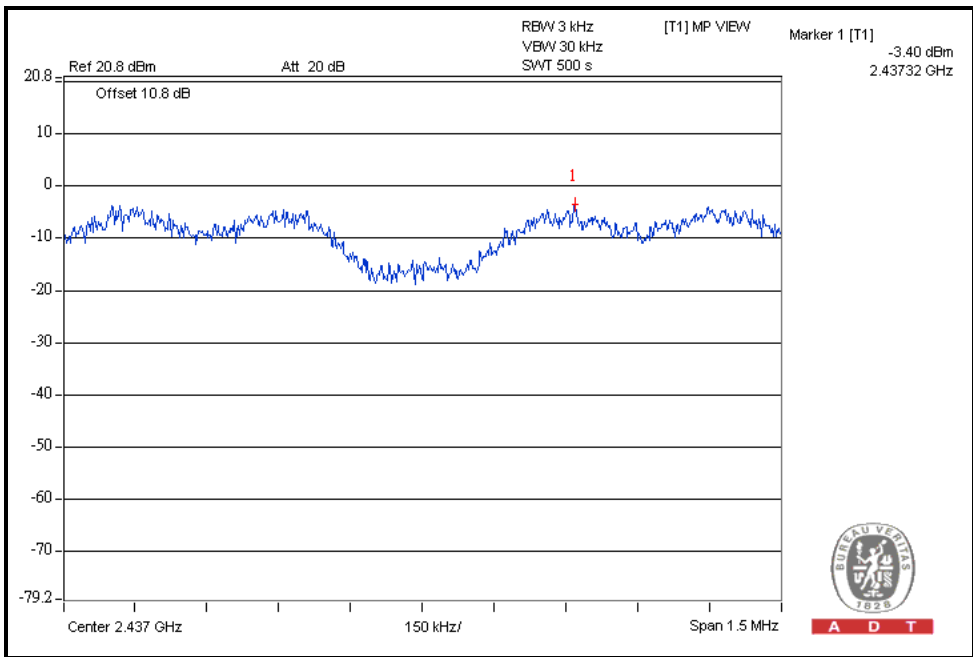



A D T

802.11n (20MHz) OFDM MODULATION <Single chain(0)>:

CHANNEL	CHANNEL FREQUENCY (MHz)	RF POWER LEVEL IN 3kHz BW (dBm)	MAXIMUM LIMIT (dBm)	PASS / FAIL
1	2412	-8.0	8	PASS
6	2437	-2.8	8	PASS
11	2462	-8.6	8	PASS

CH6

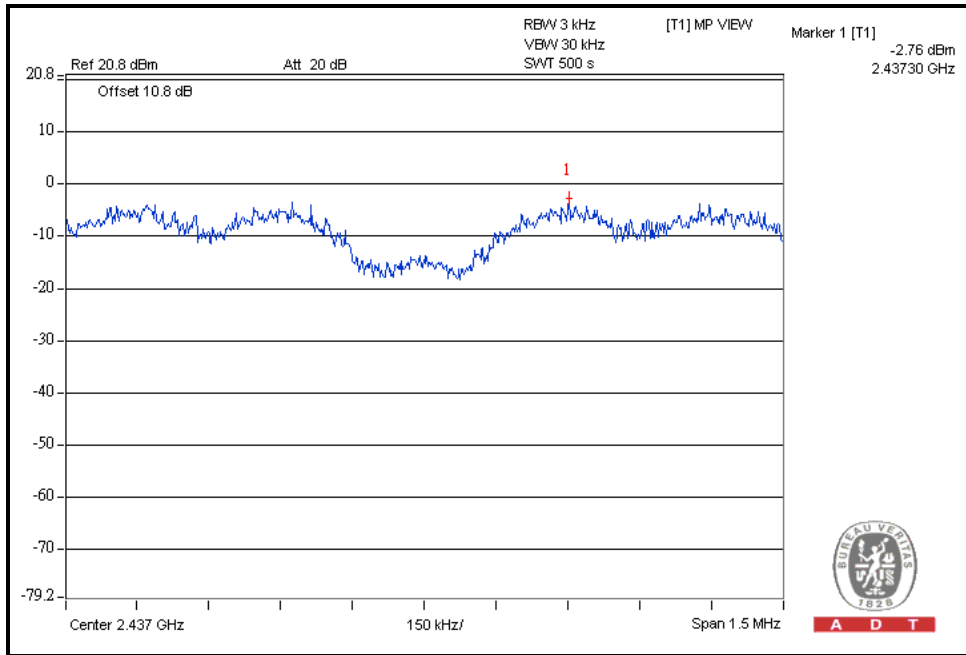



A D T

802.11n (20MHz) OFDM MODULATION <Single chain(1)>:

CHANNEL	CHANNEL FREQUENCY (MHz)	RF POWER LEVEL IN 3kHz BW (dBm)	MAXIMUM LIMIT (dBm)	PASS / FAIL
1	2412	-9.3	8	PASS
6	2437	-1.0	8	PASS
11	2462	-10.4	8	PASS

CH6

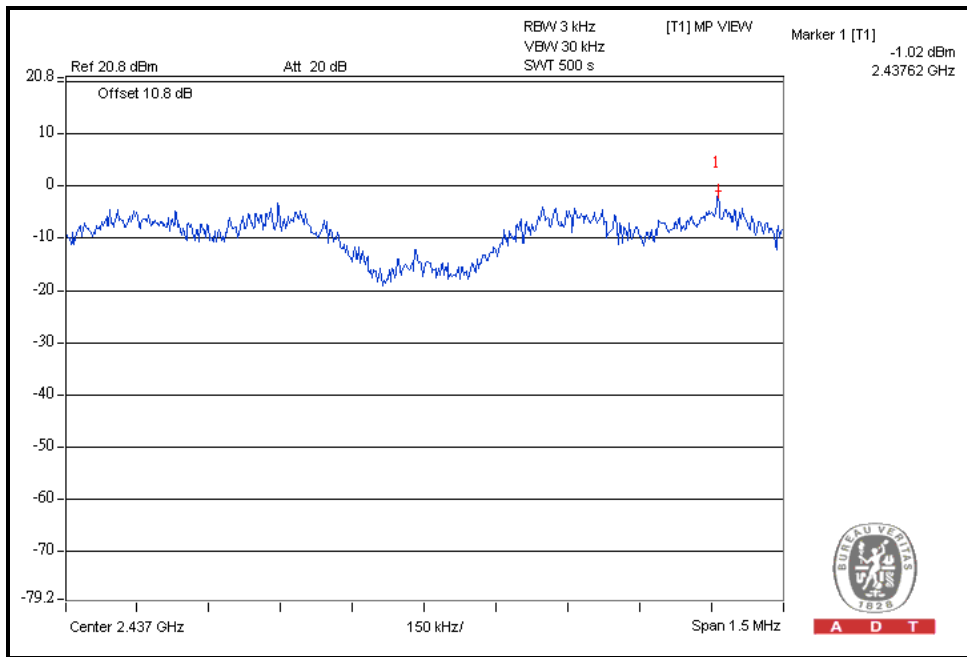



A D T

802.11n (20MHz) OFDM MODULATION <Multiple chain>:

CHANNEL	CHANNEL FREQUENCY (MHz)	RF POWER LEVEL IN 3kHz BW (dBm)		TOTAL POWER DENSITY (dBm)	MAXIMUM LIMIT (dBm)	PASS / FAIL
		CHAIN(0)	CHAIN(1)			
1	2412	-9.4	-10.0	-6.7	8	PASS
6	2437	-7.1	-7.5	-4.3	8	PASS
11	2462	-8.3	-10.0	-6.1	8	PASS

For Chain(0): CH6

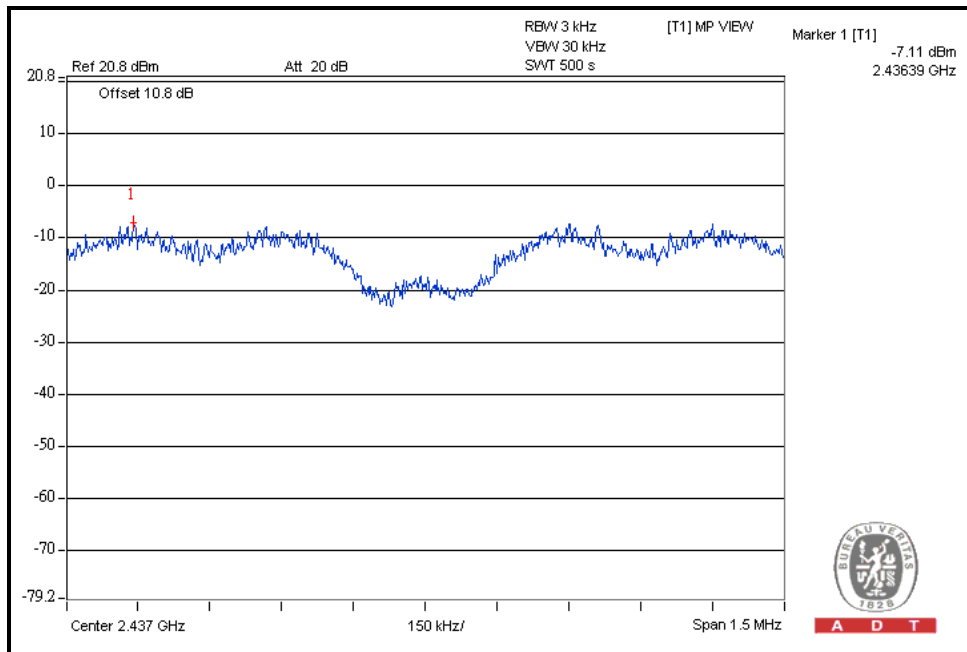



A D T

802.11n (40MHz) OFDM MODULATION <Single chain(0)>:

CHANNEL	CHANNEL FREQUENCY (MHz)	RF POWER LEVEL IN 3kHz BW (dBm)	MAXIMUM LIMIT (dBm)	PASS / FAIL
3	2422	-8.1	8	PASS
6	2437	-8.5	8	PASS
9	2452	-9.4	8	PASS

CH3

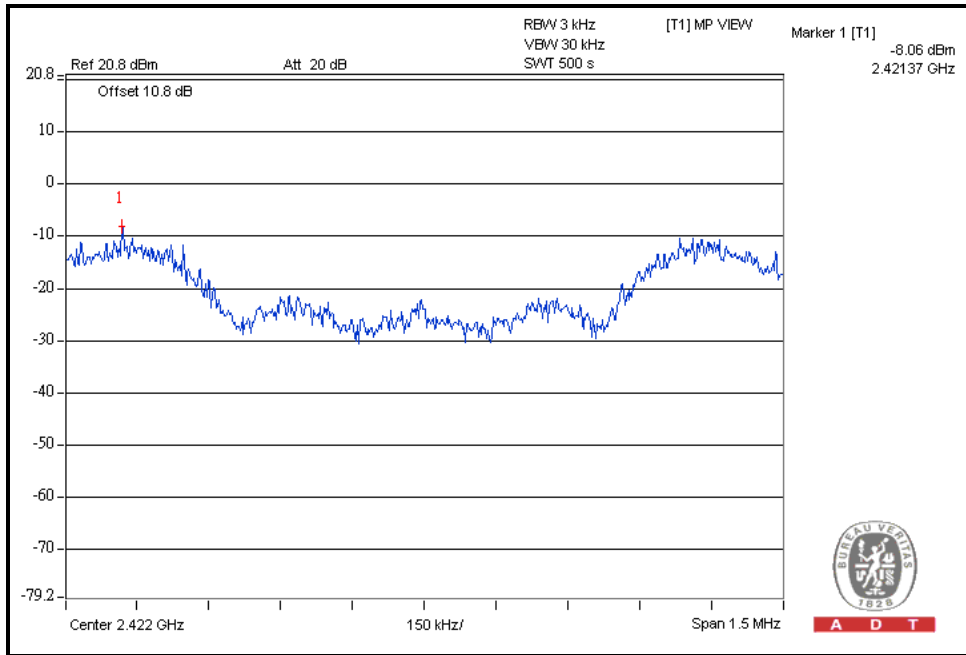



A D T

802.11n (40MHz) OFDM MODULATION <Single chain(1)>:

CHANNEL	CHANNEL FREQUENCY (MHz)	RF POWER LEVEL IN 3kHz BW (dBm)	MAXIMUM LIMIT (dBm)	PASS / FAIL
3	2422	-11.8	8	PASS
6	2437	-10.6	8	PASS
9	2452	-11.7	8	PASS

CH6

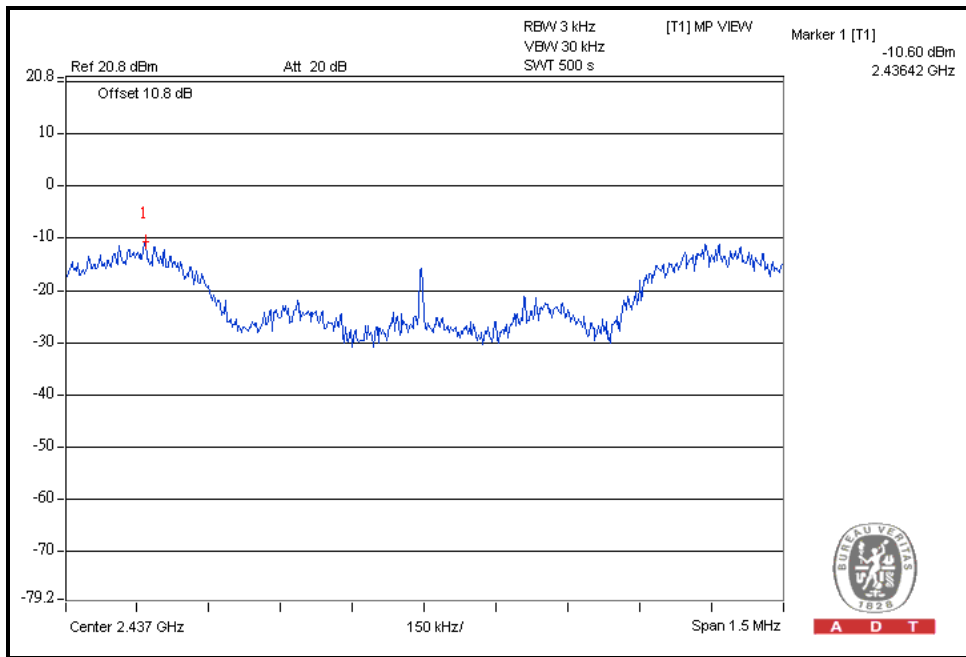



A D T

802.11n (40MHz) OFDM MODULATION <Multiple chain>:

CHANNEL	CHANNEL FREQUENCY (MHz)	RF POWER LEVEL IN 3kHz BW (dBm)		TOTAL POWER DENSITY (dBm)	MAXIMUM LIMIT (dBm)	PASS / FAIL
		CHAIN(0)	CHAIN(1)			
3	2422	-10.4	-10.1	-7.2	8	PASS
6	2437	-9.8	-10.1	-6.9	8	PASS
9	2452	-11.8	-10.9	-8.3	8	PASS

For Chain(0): CH6

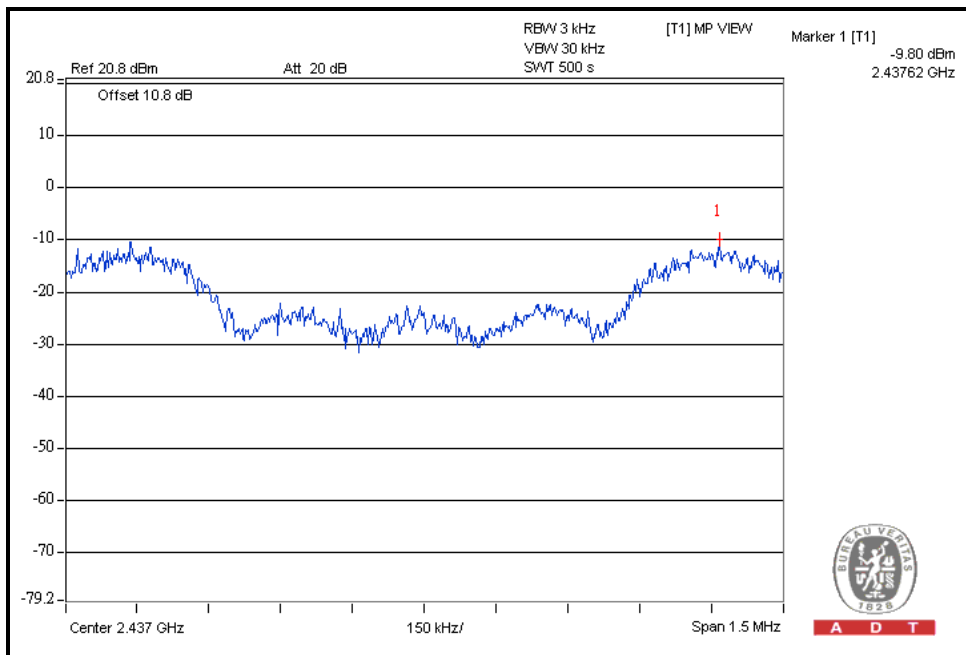

4.6 CONDUCTED OUT-BAND EMISSION MEASUREMENT

4.6.1 LIMITS OF CONDUCTED OUT-BAND EMISSION MEASUREMENT

Below -20dB of the highest emission level of operating band (in 100kHz Resolution Bandwidth).

4.6.2 TEST INSTRUMENTS

Test date: Sep. 27, 2011

DESCRIPTION & MANUFACTURER	MODEL NO.	SERIAL NO.	CALIBRATED DATE	CALIBRATED UNTIL
R&S Spectrum Analyzer	FSP 40	100060	May 11, 2011	May 10, 2012

NOTE: The calibration interval of the above test instruments is 12 months and the calibrations are traceable to NML/ROC and NIST/USA.

4.6.3 TEST PROCEDURE

The transmitter output was connected to the spectrum analyzer via a low loss cable. Set RBW of spectrum analyzer to 100kHz and VBW of spectrum analyzer to 300kHz with suitable frequency span including 100 MHz or 200 MHz bandwidth from band edge. The band edges was measured and recorded.

The spectrum plots (RBW = 100kHz, VBW = 300kHz) are attached on the following pages.

4.6.4 DEVIATION FROM TEST STANDARD

No deviation

4.6.5 EUT OPERATING CONDITION

Same as Item 4.3.6

4.6.6 TEST RESULTS

The spectrum plots are attached on the following images. D1 line indicates the highest level, and D2 line indicates the 20dB offset below D1. It shows compliance with the requirement in part 15.247(d).



A D T

Performing measurements: Measure and add 10 log(N) dB 802.11b DSSS MODULATION <Single chain(0)>:

CH1

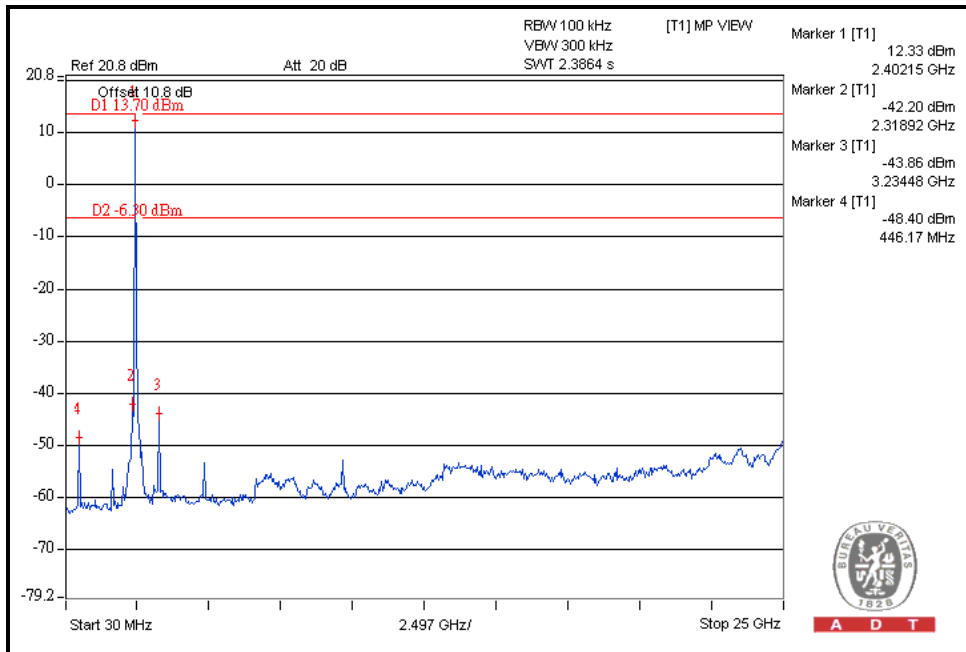
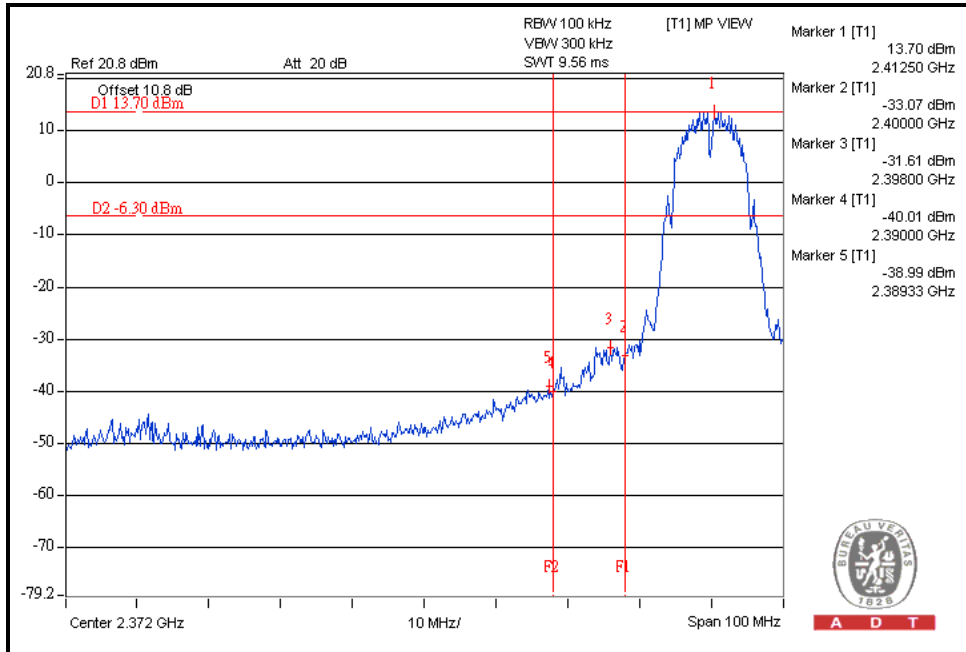



A D T

CH11

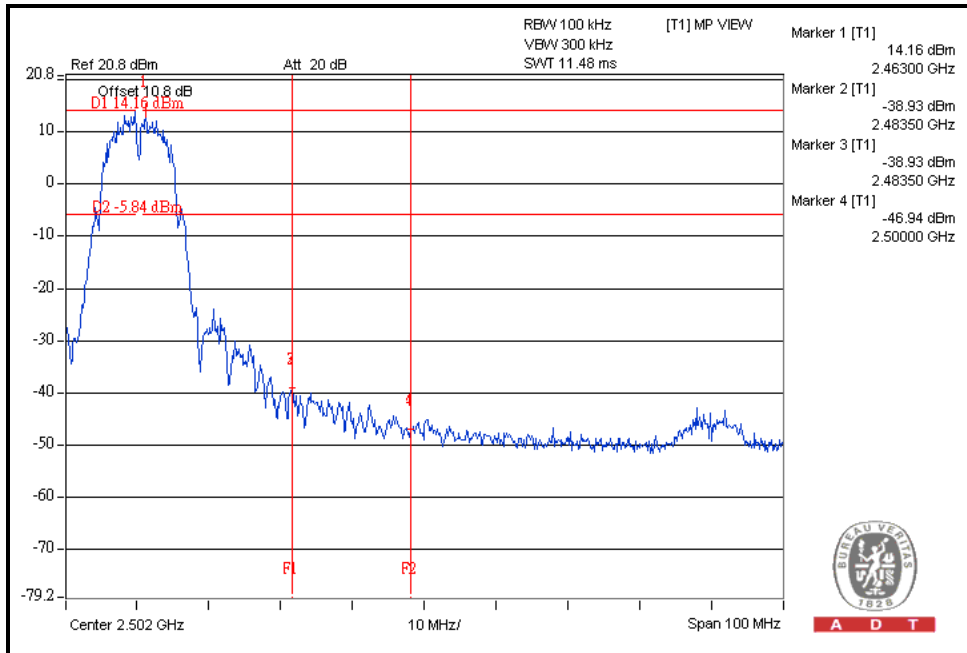

A D T

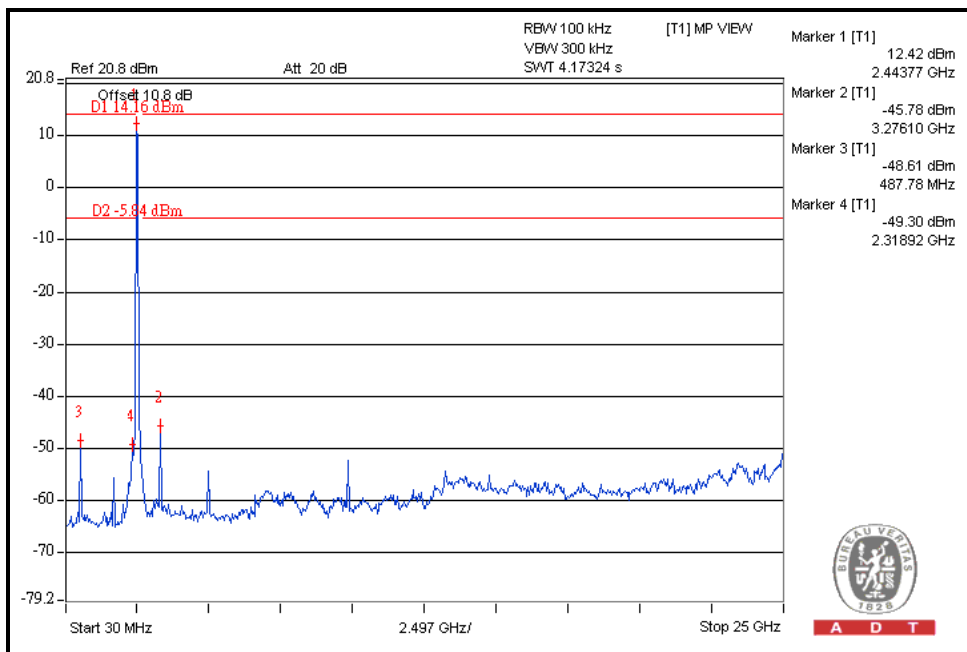

A D T

802.11b DSSS MODULATION <Single chain(1)>:

CH1

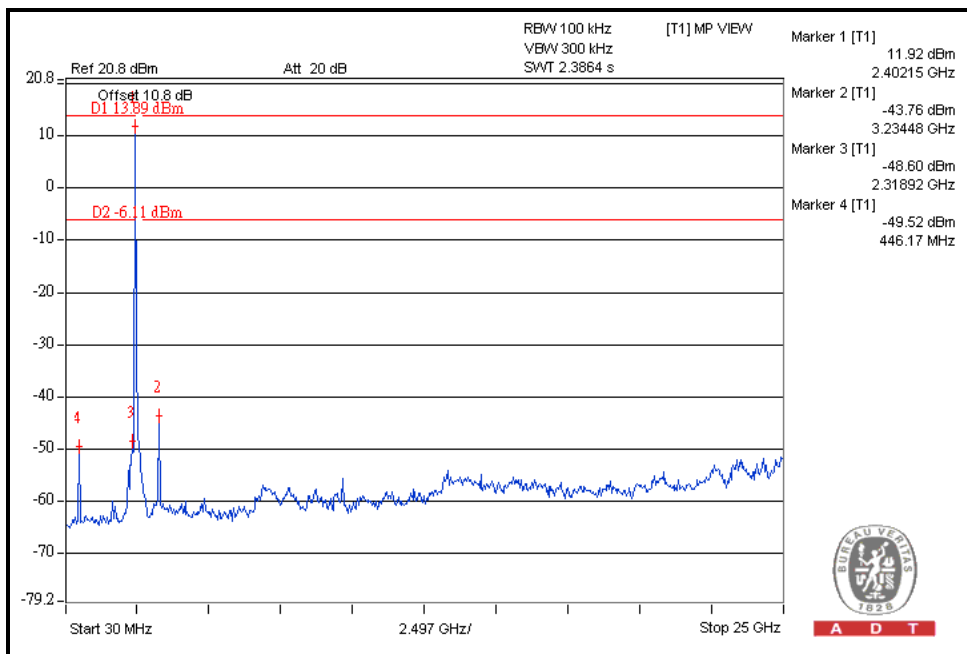
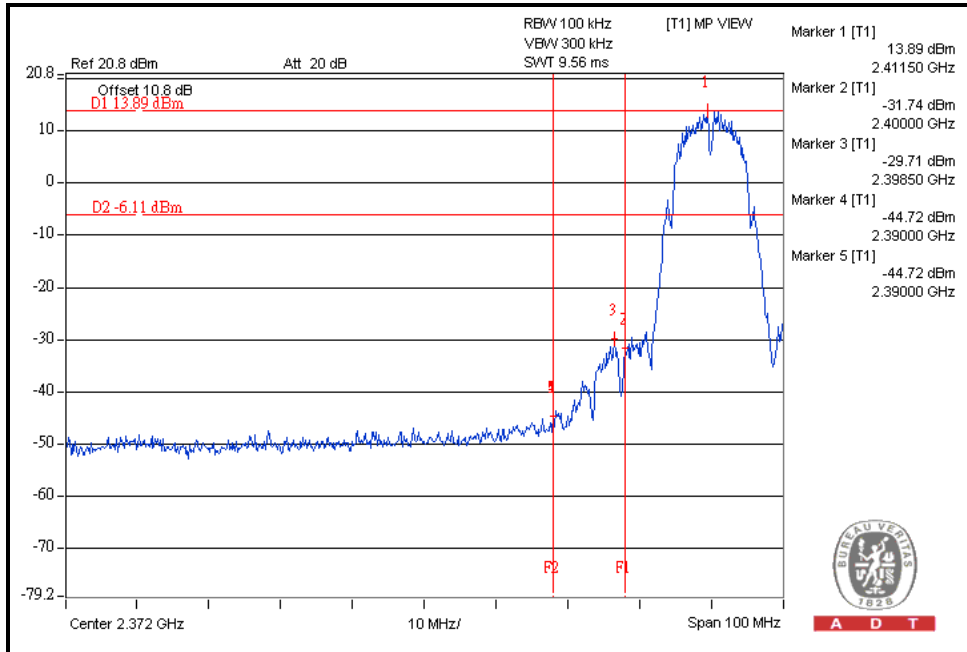



A D T

CH11

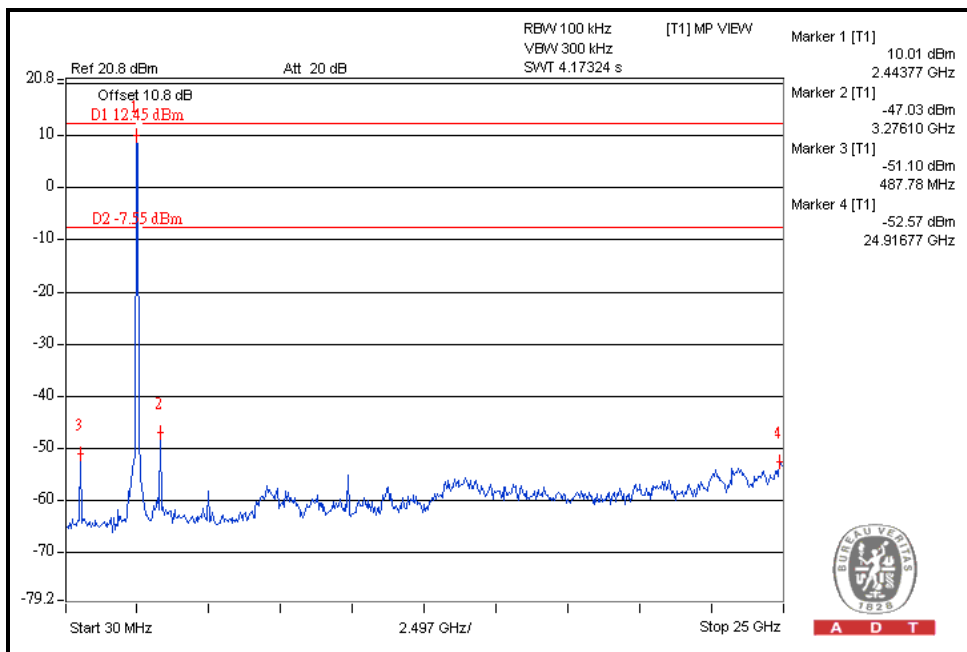
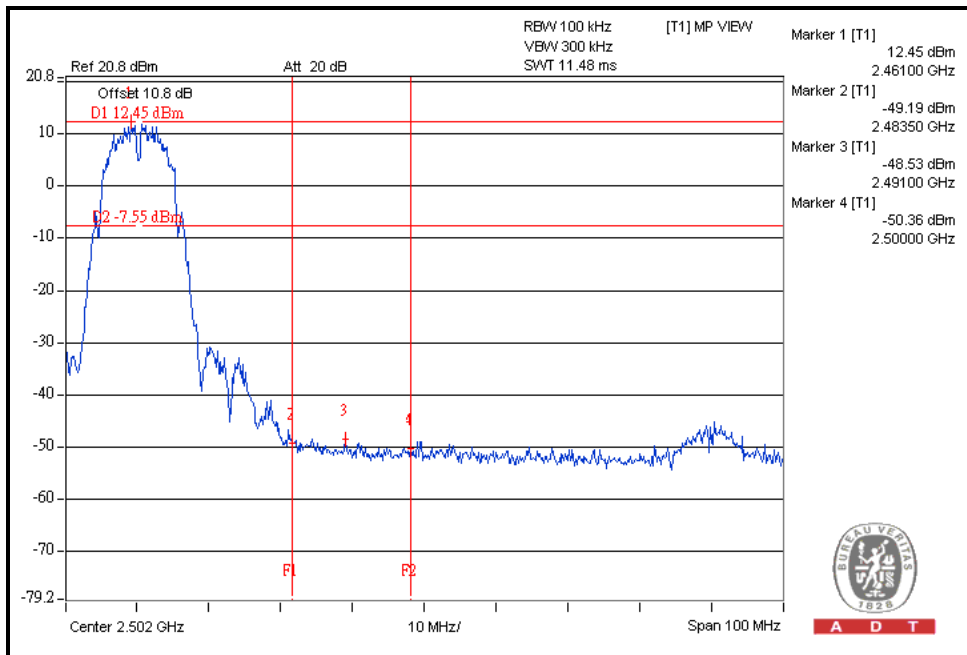



A D T

802.11g OFDM MODULATION <Single chain(0)>:

CH1

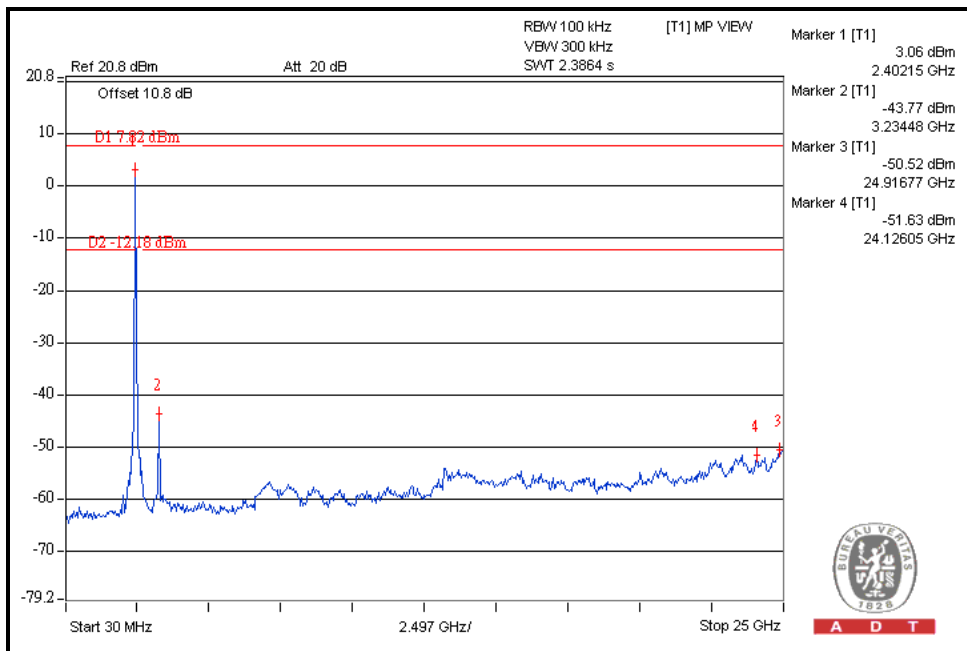
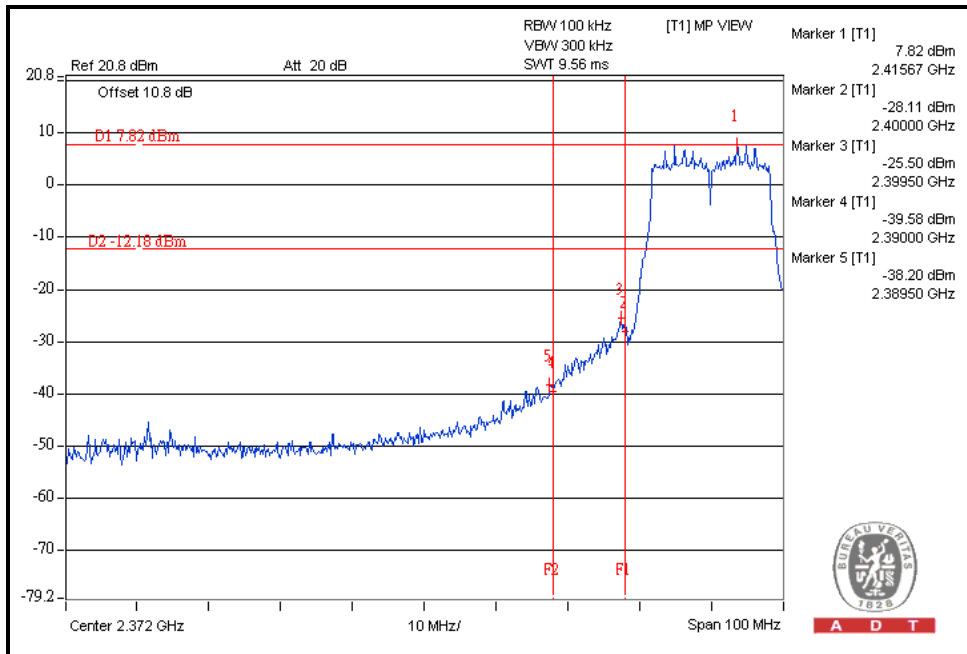



A D T

CH11

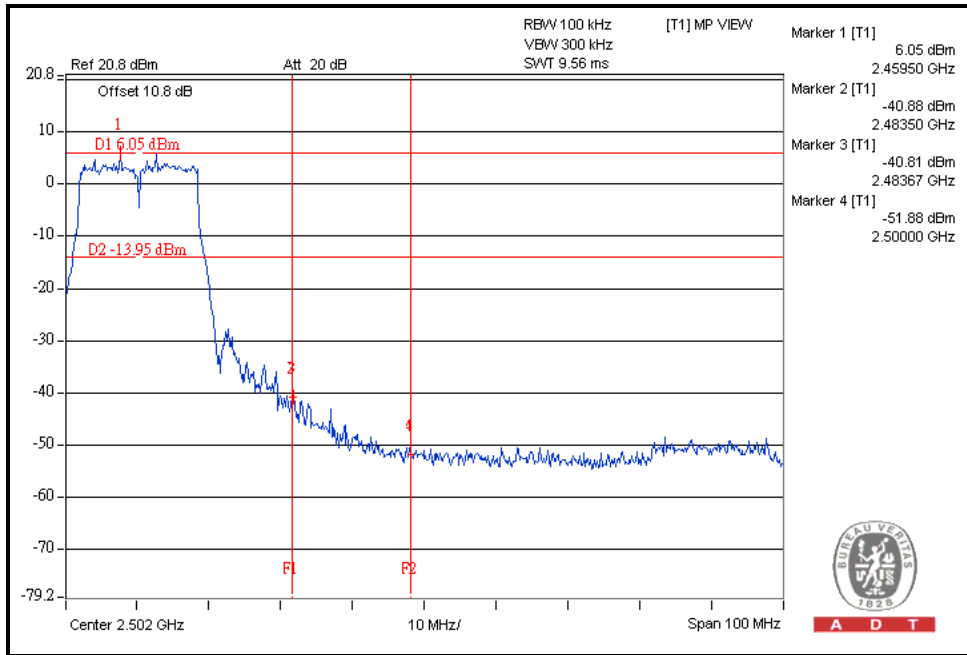

A D T

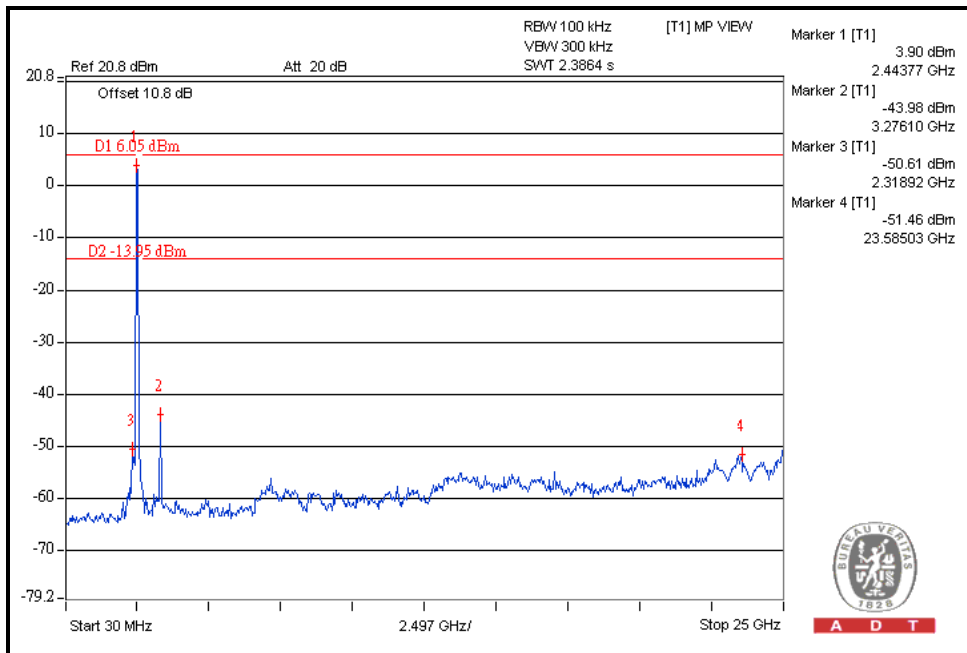

A D T



A D T

802.11g OFDM MODULATION <Single chain(1)>:

CH1

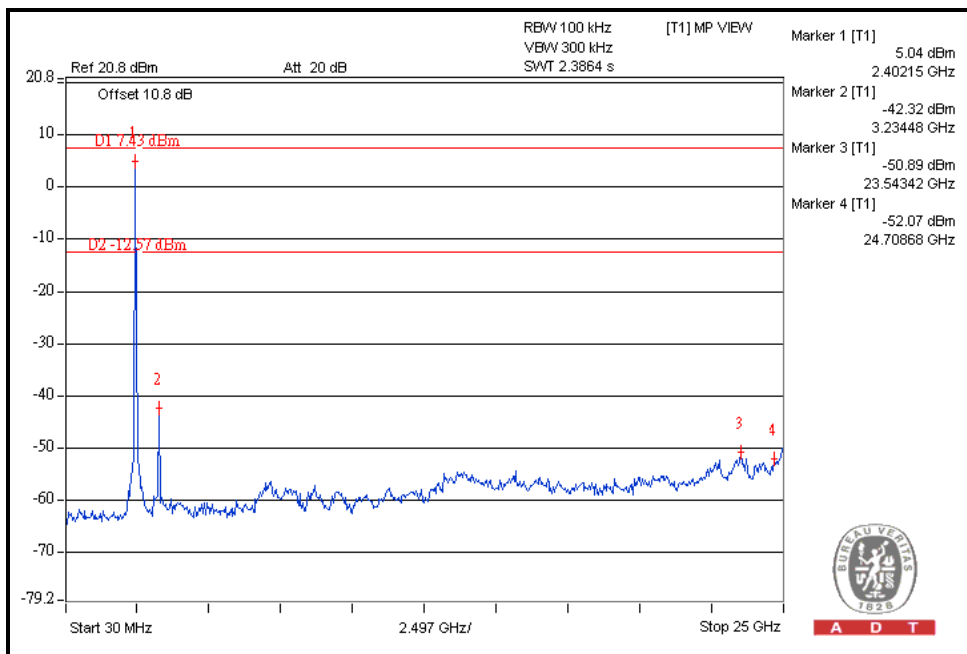
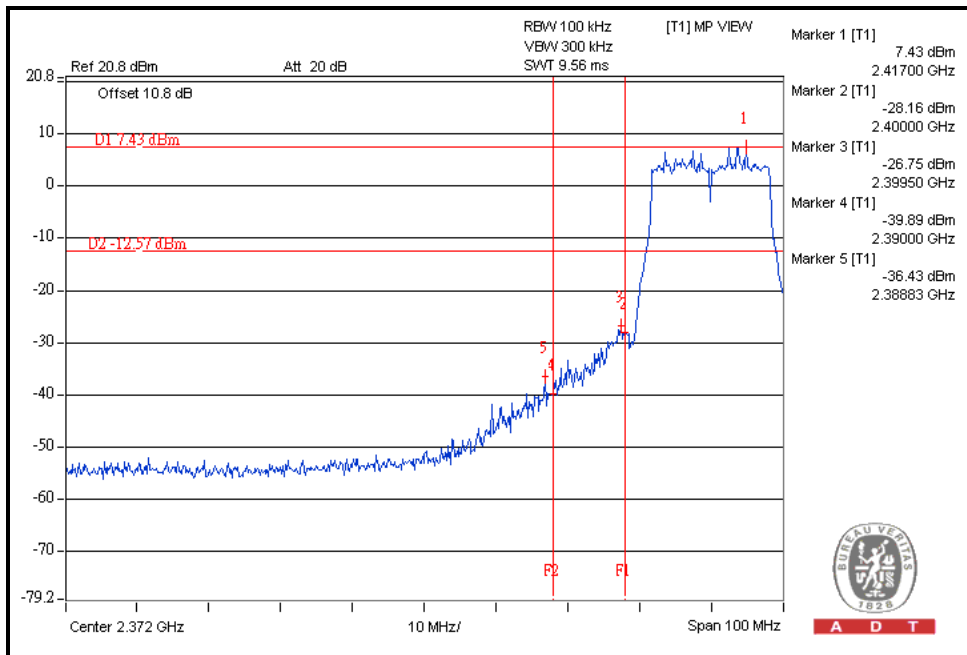



A D T

CH11

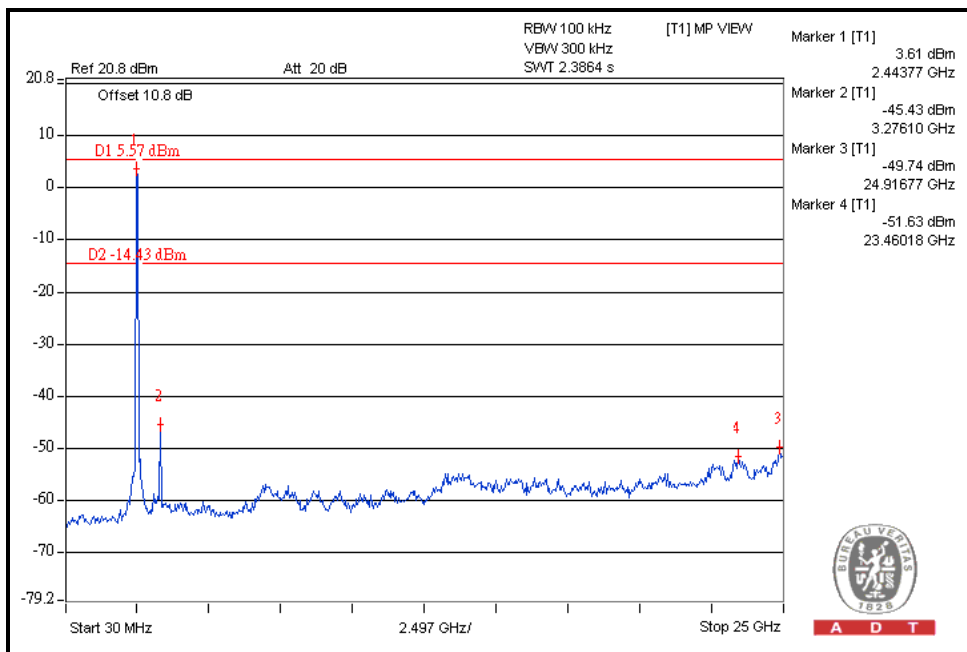
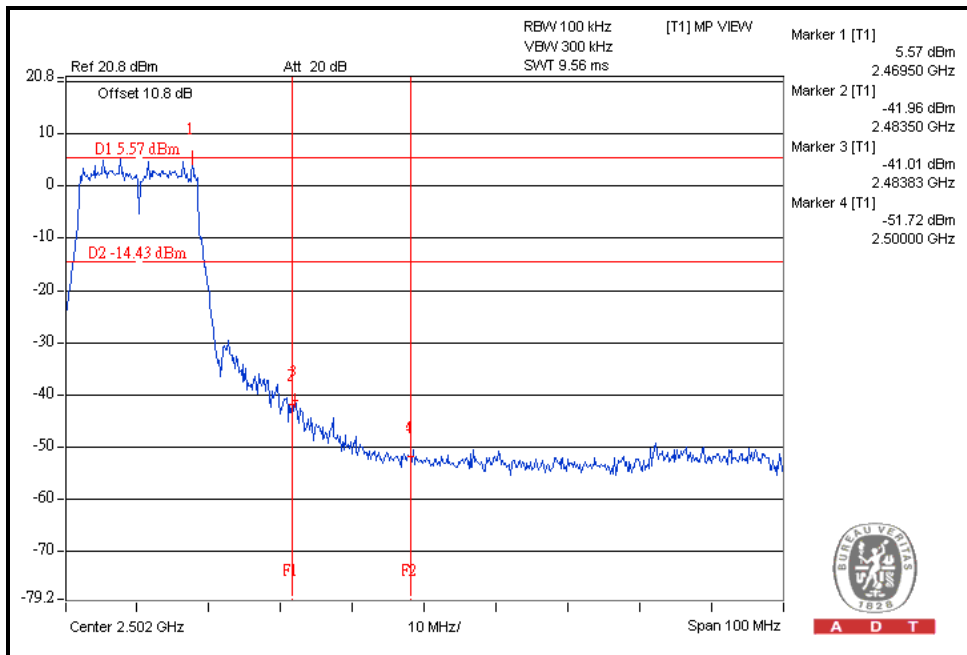



A D T

802.11n (20MHz) OFDM MODULATION <Single chain(0)>:

CH1

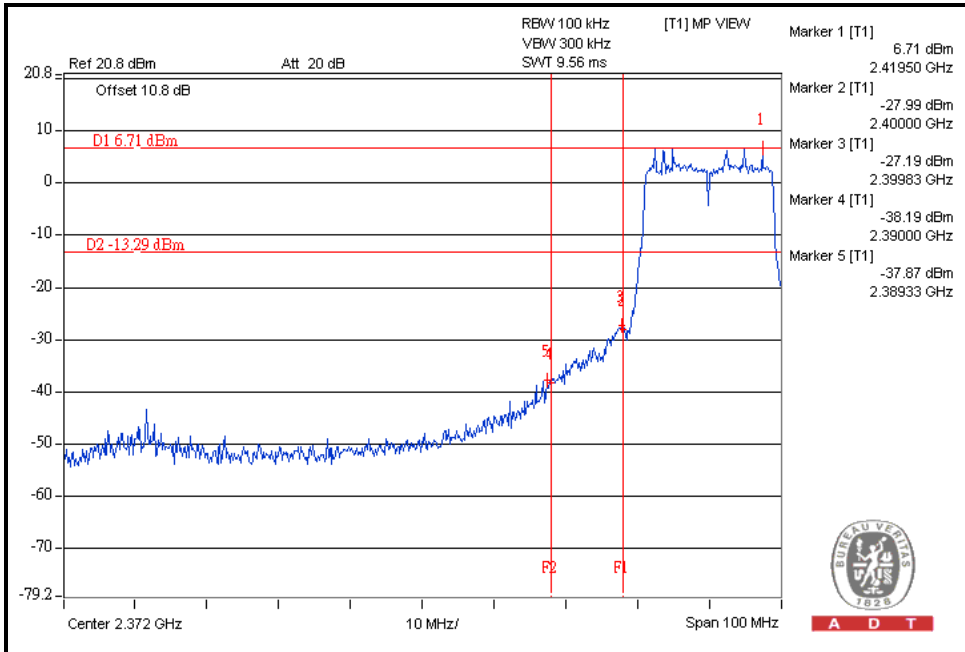

A D T

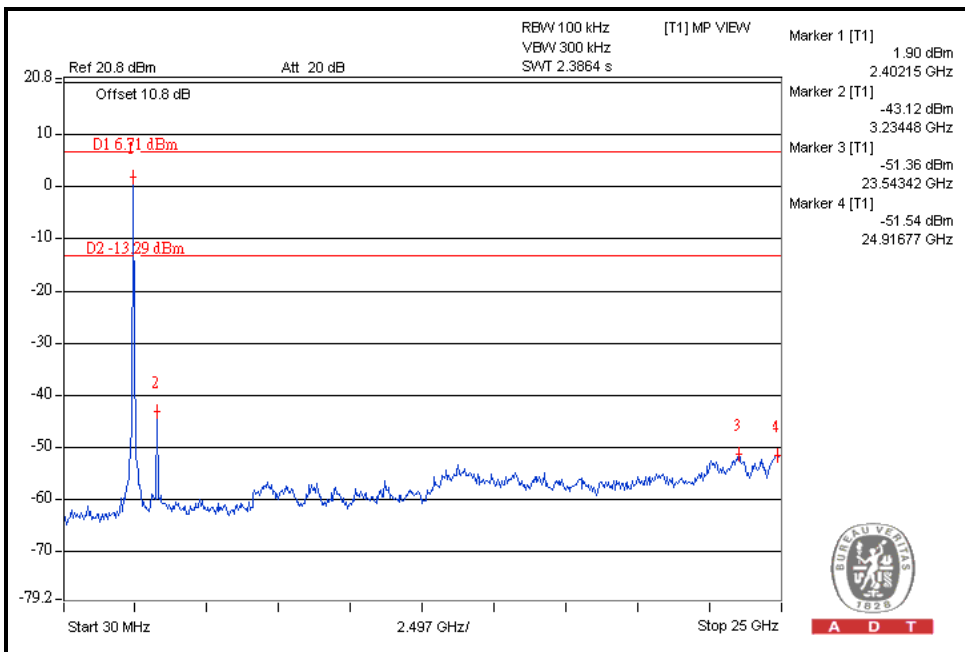

A D T



A D T

CH11

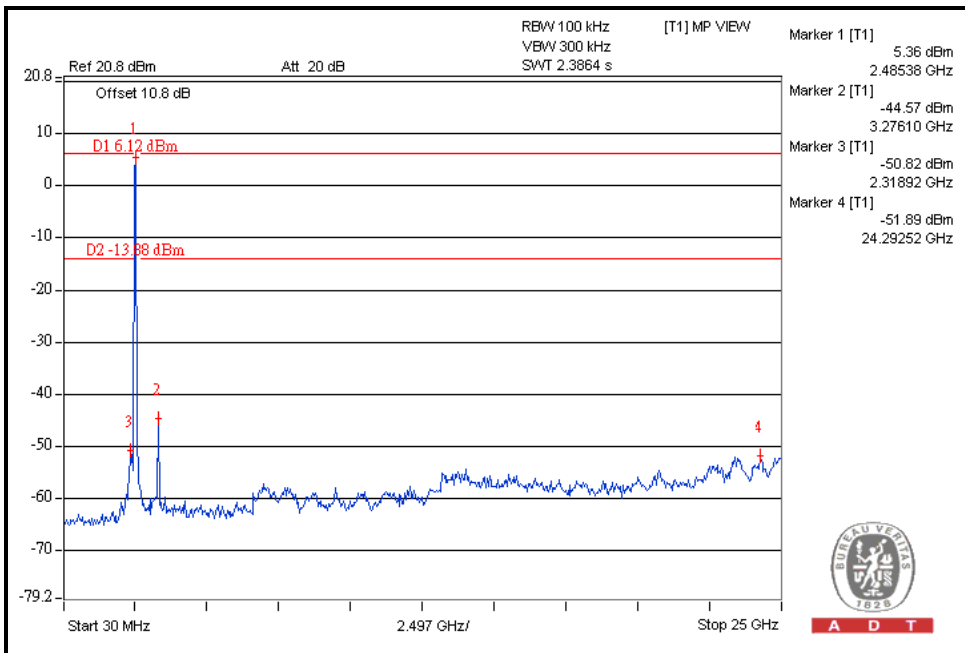
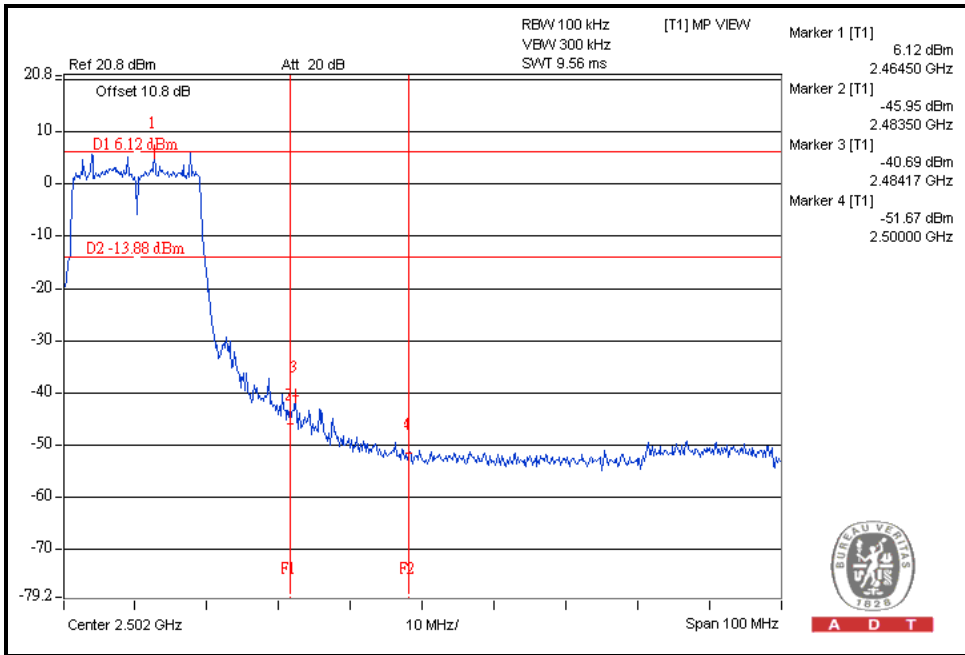

802.11n (20MHz) OFDM MODULATION <Single chain(1)>:

CH1

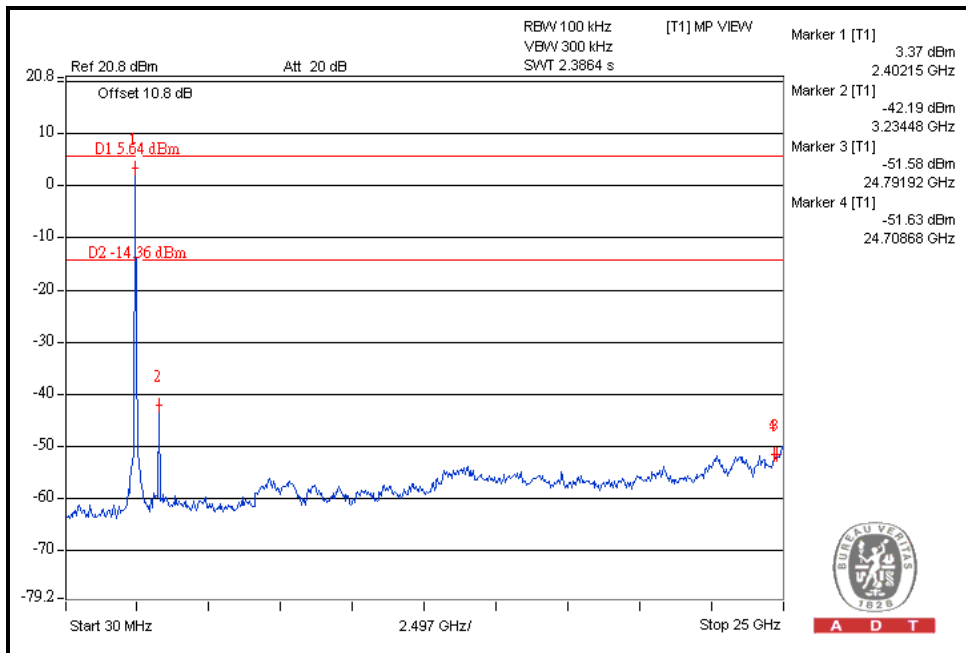
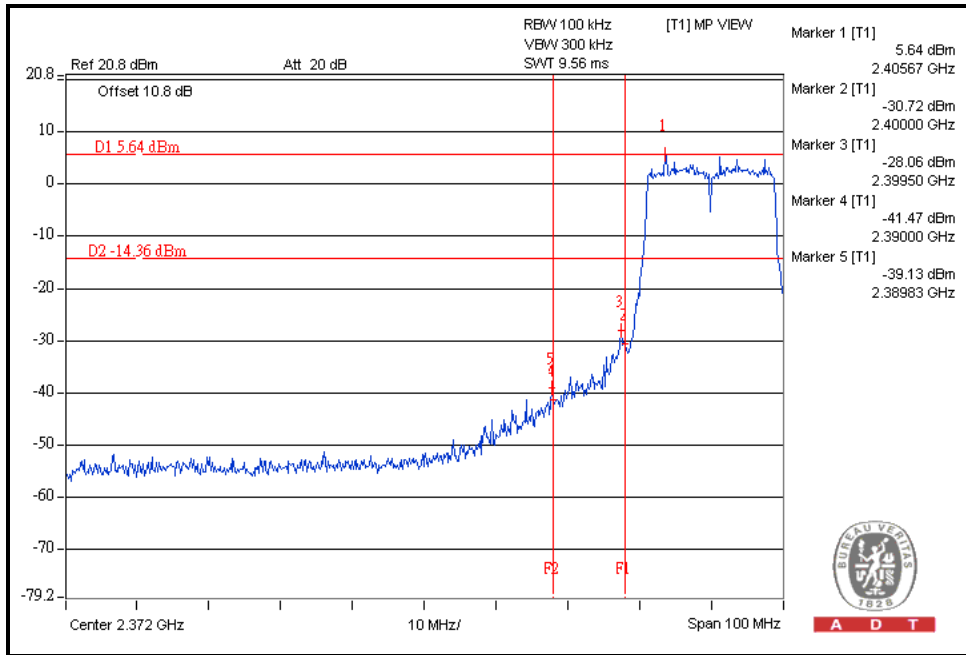



A D T

CH11

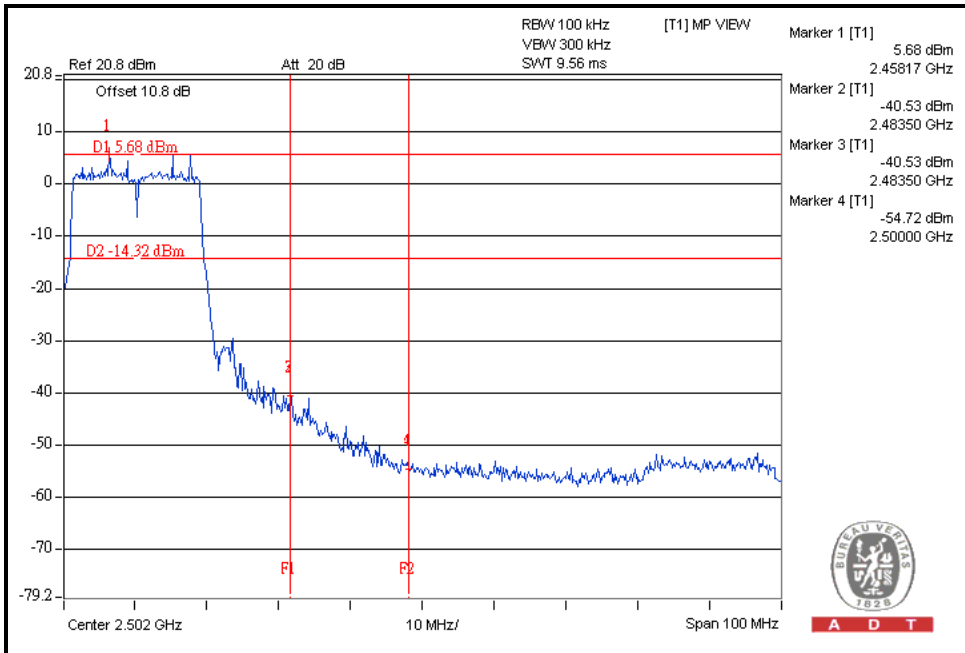

A D T

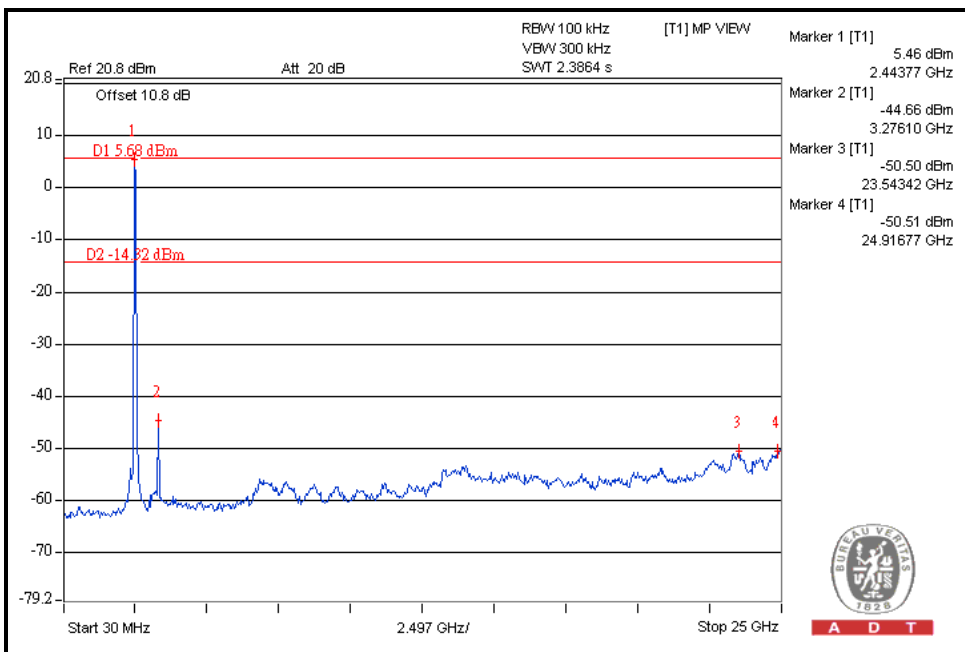

A D T



A D T

802.11n (20MHz) OFDM MODULATION <Multiple chain>:

CH1

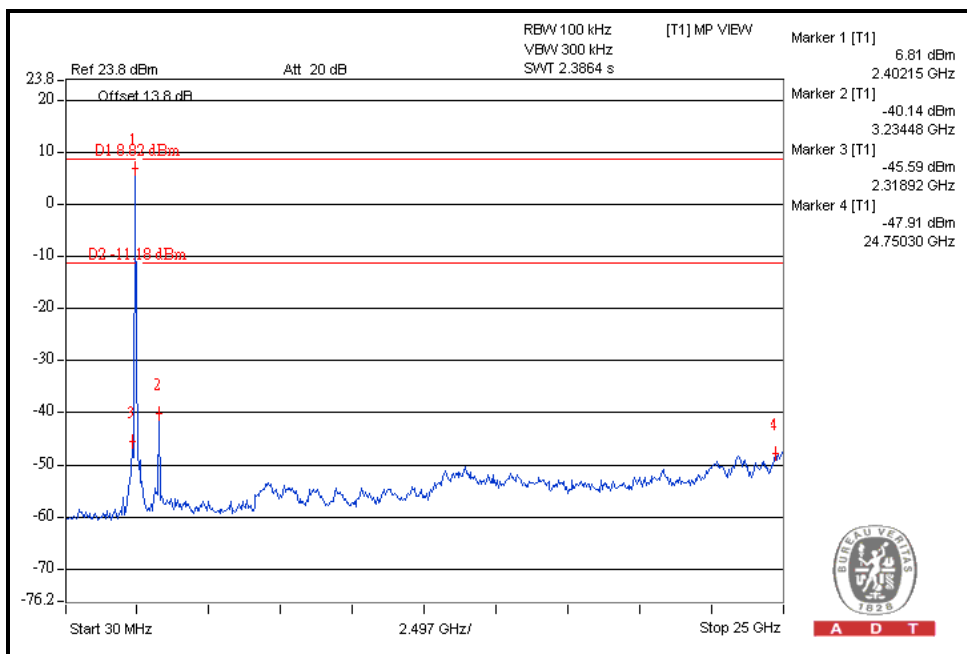
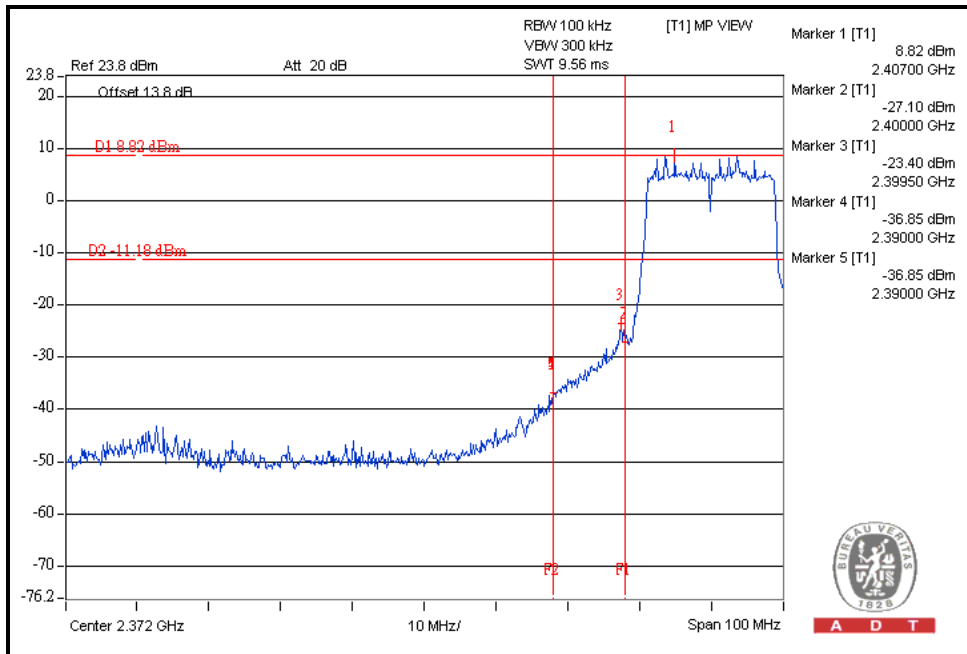



A D T

CH11

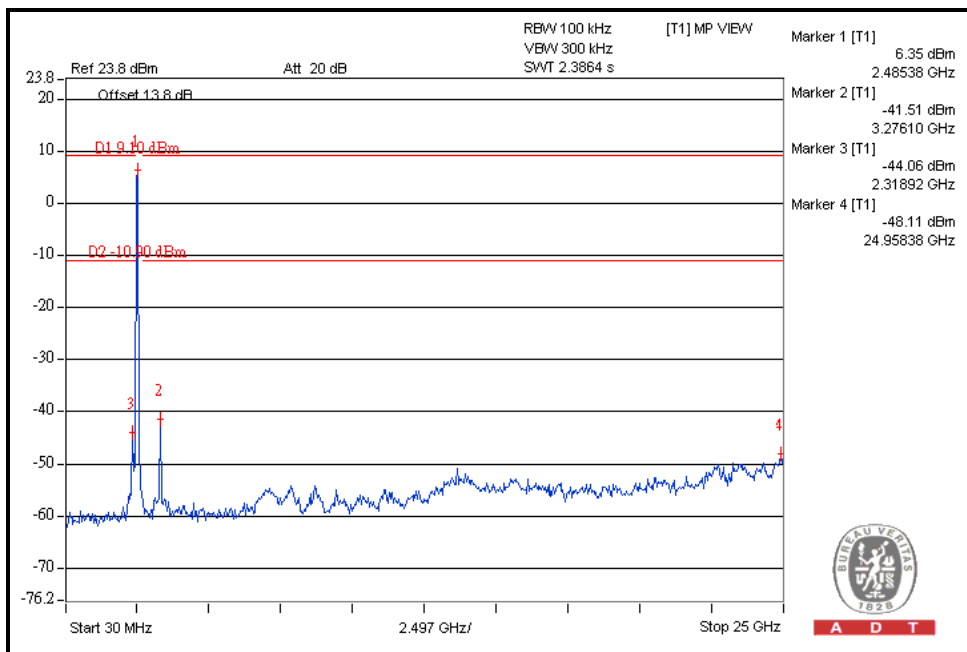
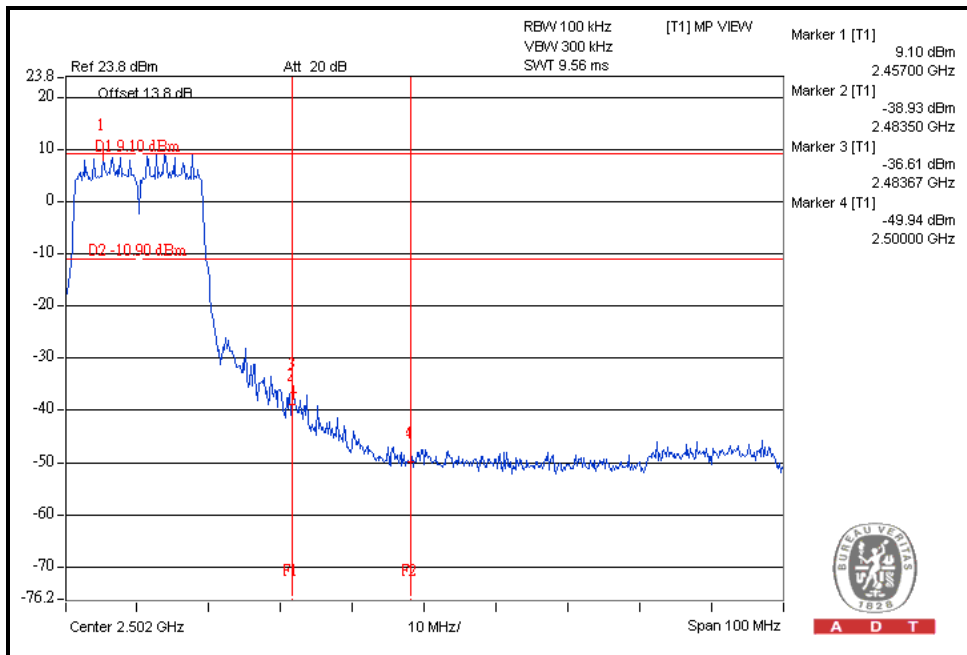



A D T

802.11n (40MHz) OFDM MODULATION <Single chain(0)>:

CH3

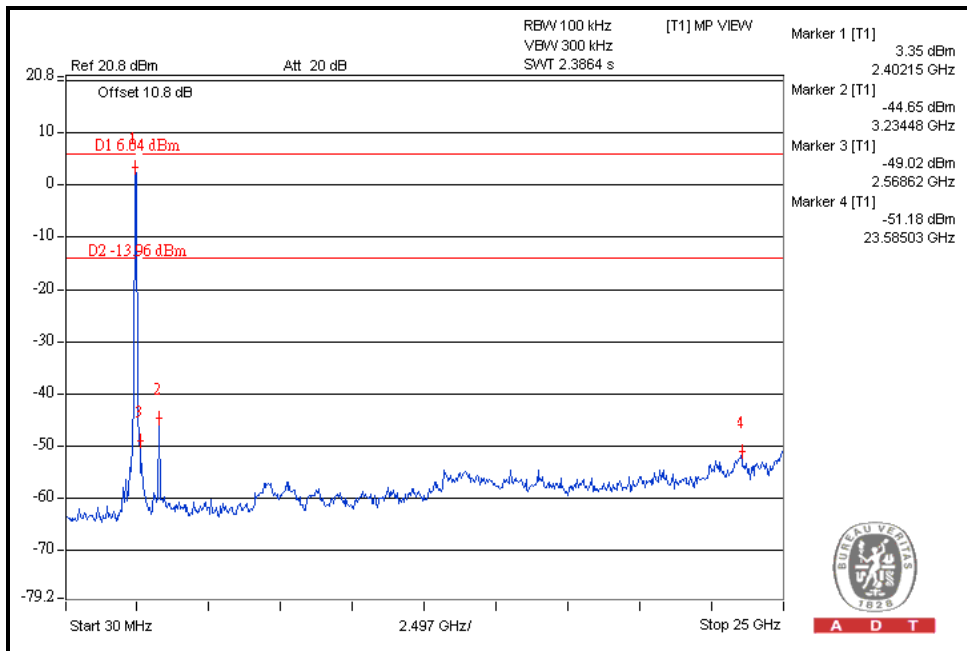
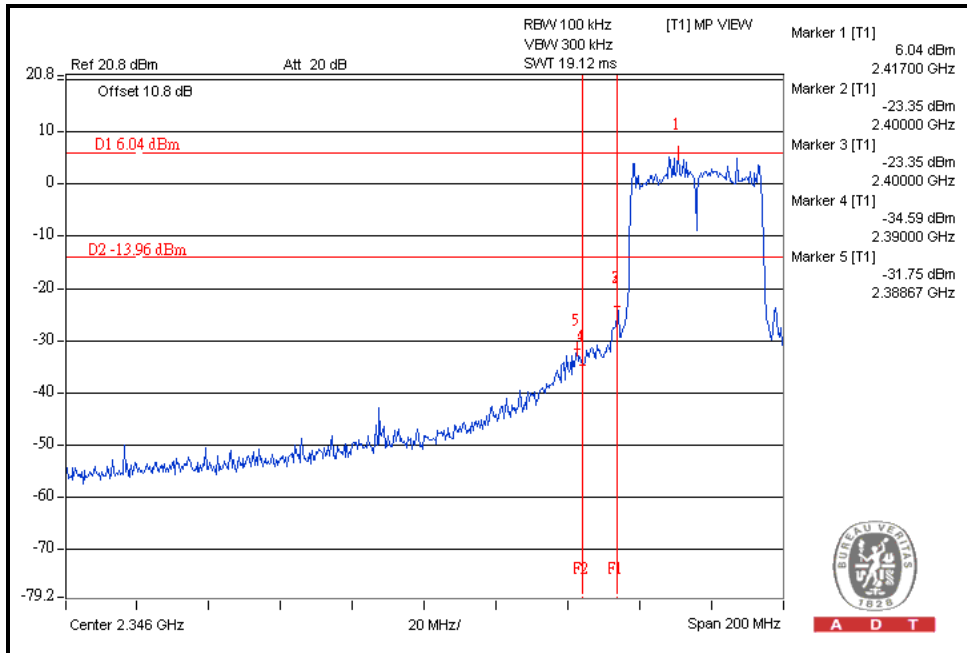



A D T

CH9

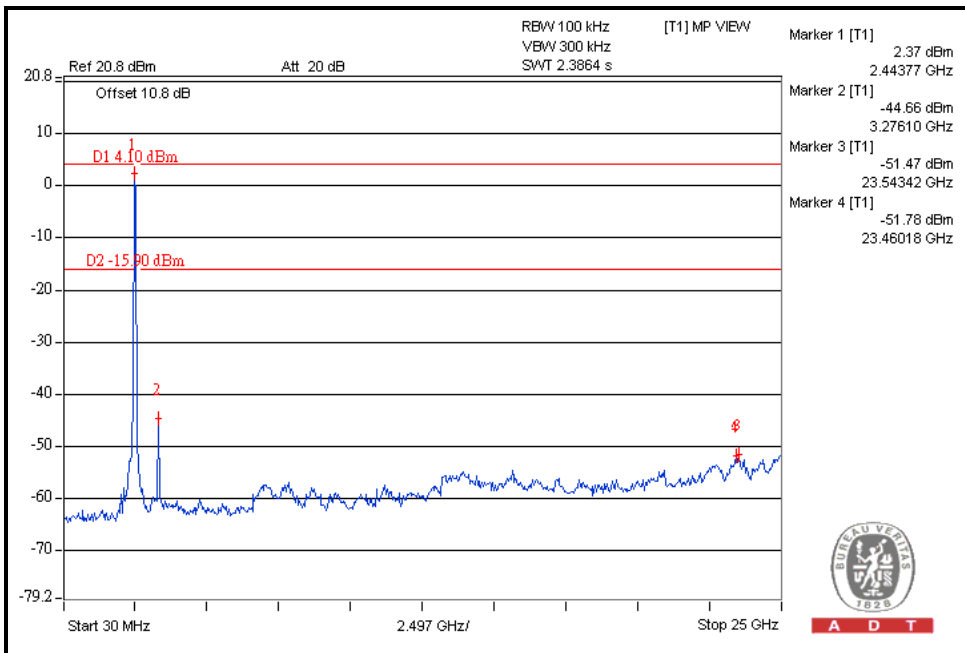
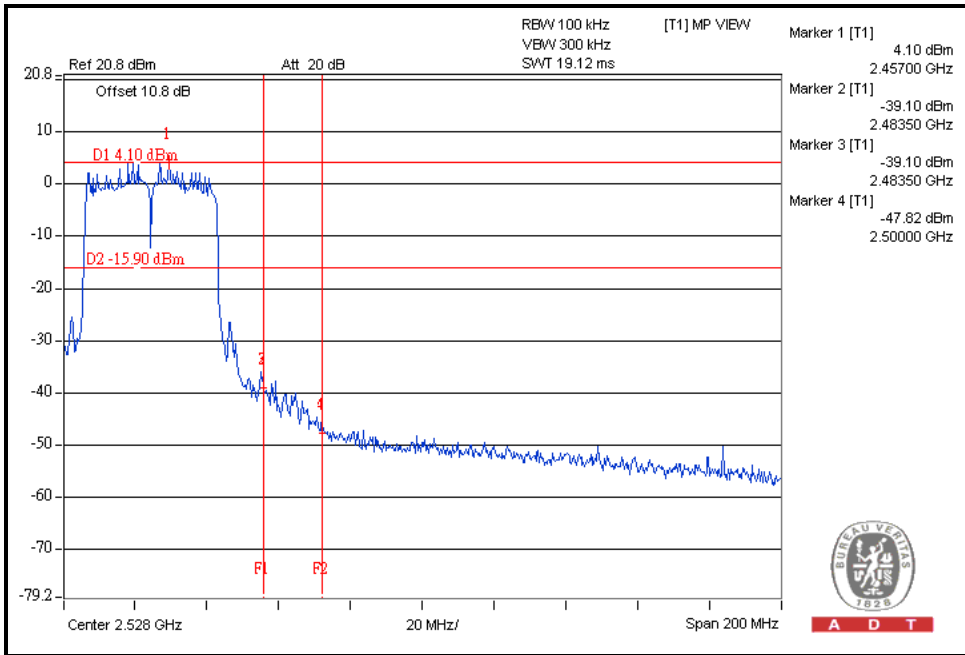



A D T

802.11n (40MHz) OFDM MODULATION <Single chain(1)>:

CH3

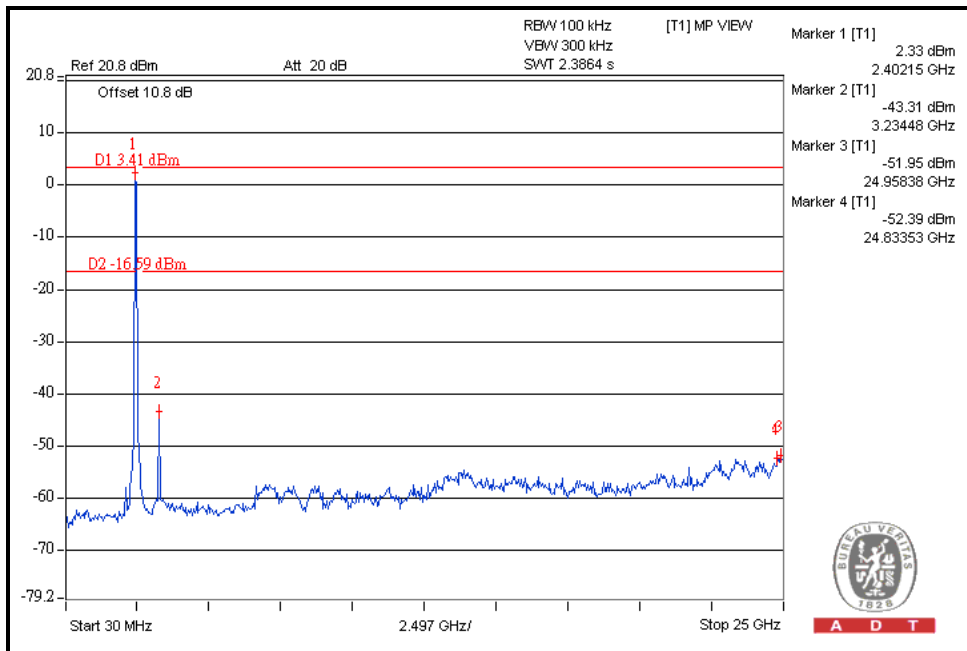
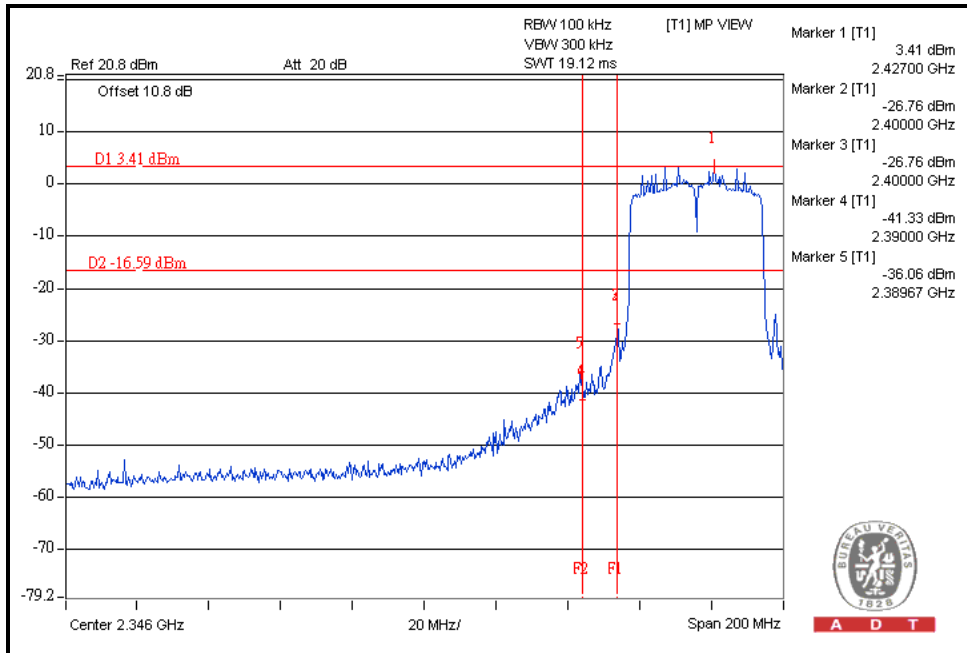



A D T

CH9

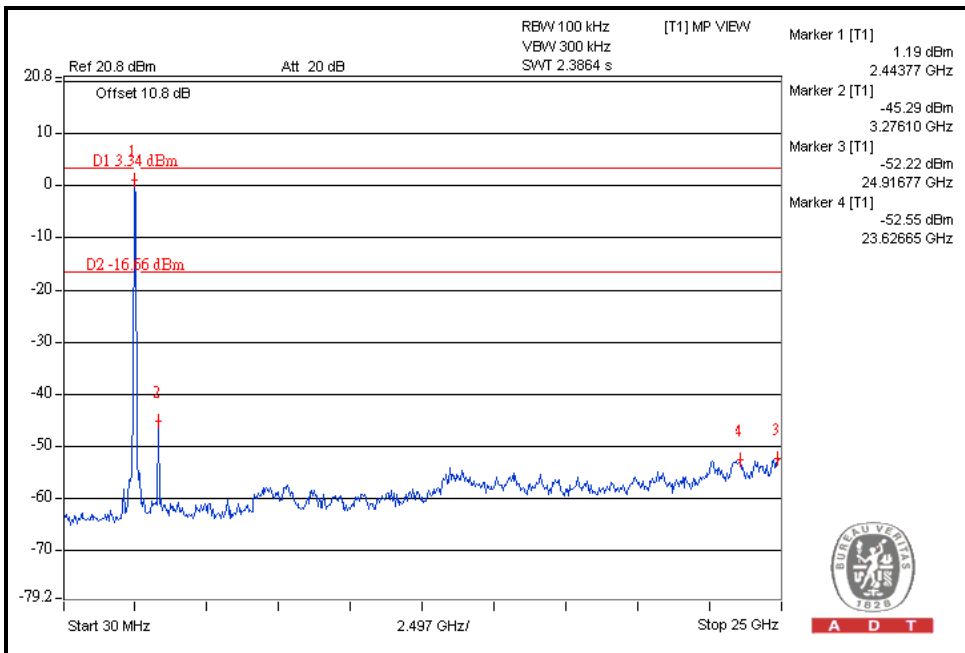
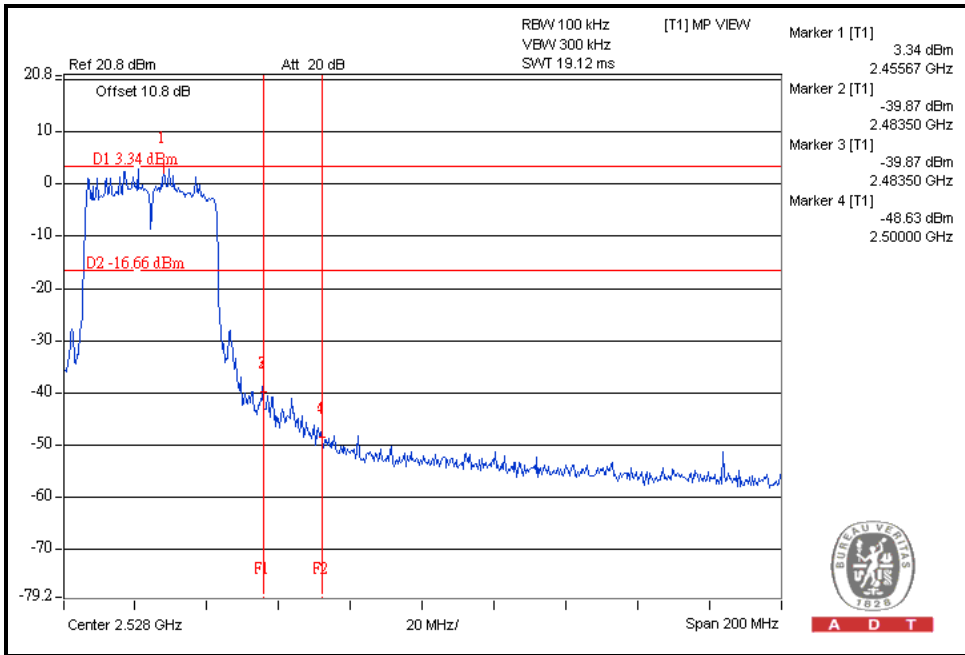



A D T

802.11n (40MHz) OFDM MODULATION <Multiple chain>

CH3

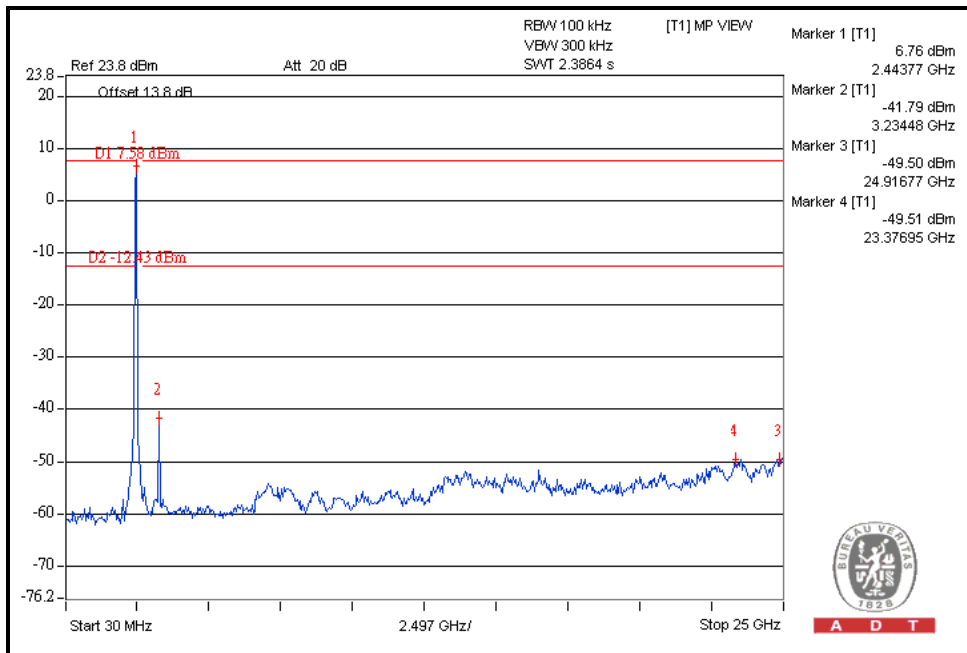
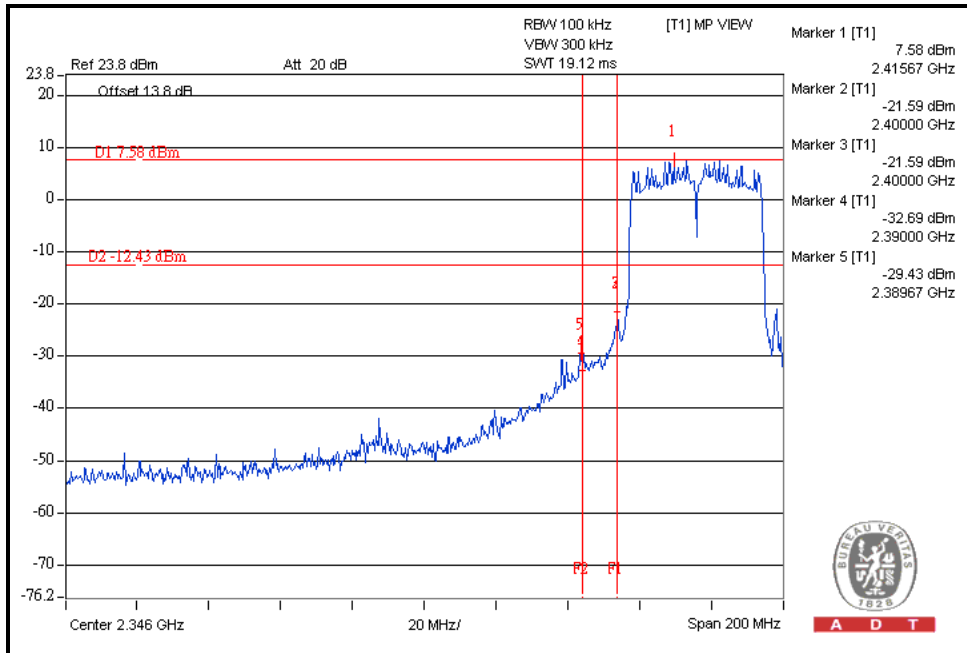



A D T

CH9

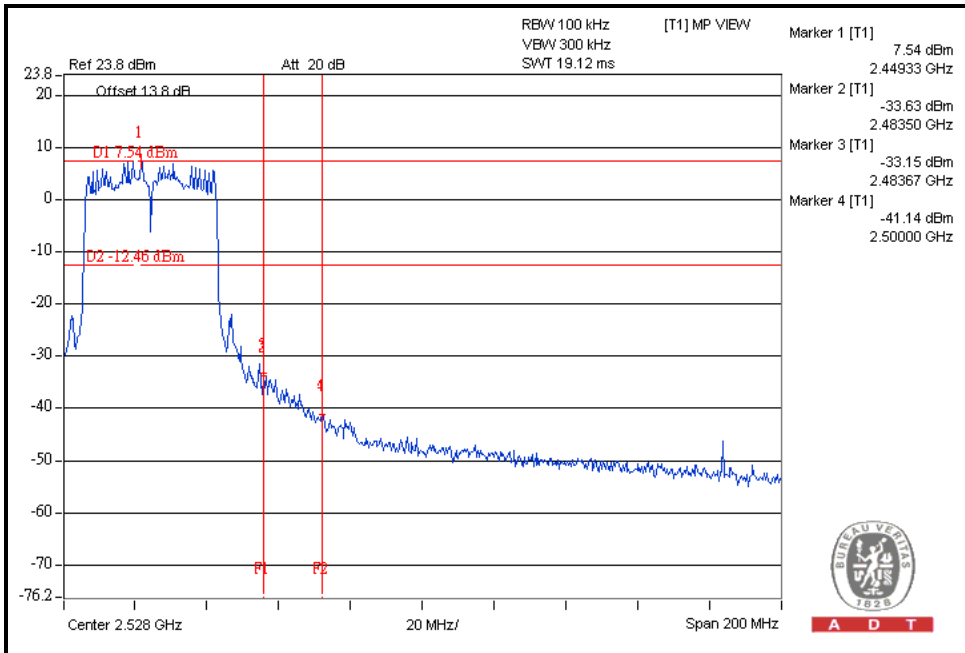

A D T

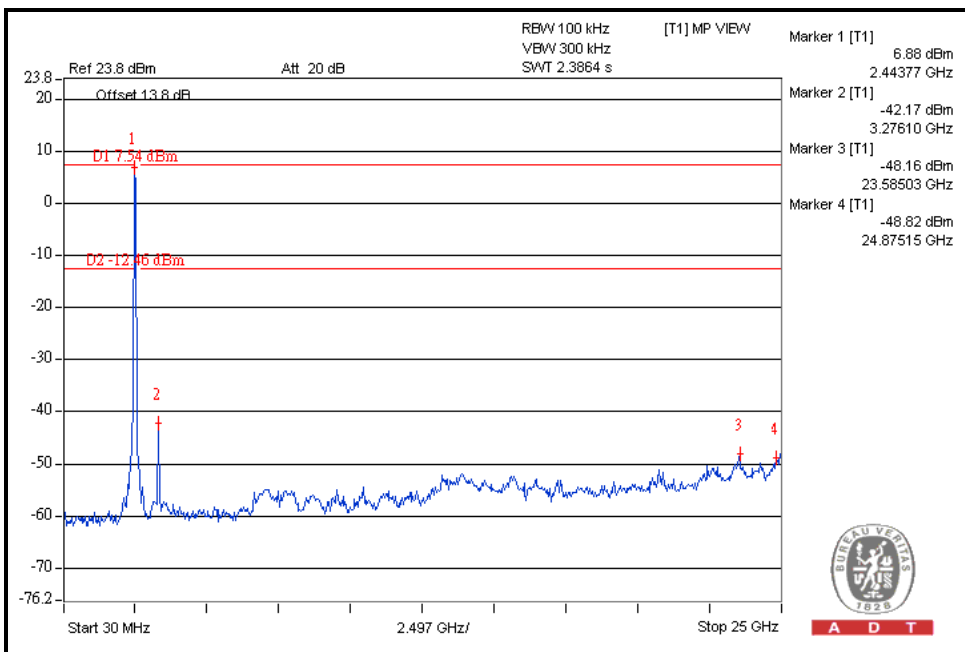

A D T



5. INFORMATION ON THE TESTING LABORATORIES

We, Bureau Veritas Consumer Products Services (H.K.) Ltd., Taoyuan Branch, were founded in 1988 to provide our best service in EMC, Radio, Telecom and Safety consultation. Our laboratories are accredited and approved according to ISO/IEC 17025.

Copies of accreditation and authorization certificates of our laboratories obtained from approval agencies can be downloaded from our web site:

www.adt.com.tw/index.5.phtml.

If you have any comments, please feel free to contact us at the following:

Linko EMC/RF Lab:

Tel: 886-2-26052180

Fax: 886-2-26052943

Hsin Chu EMC/RF Lab:

Tel: 886-3-5935343

Fax: 886-3-5935342

Hwa Ya EMC/RF/Safety/Telecom Lab:

Tel: 886-3-3183232

Fax: 886-3-3185050

Email: service.adt@tw.bureauveritas.com

Web Site: www.adt.com.tw

The address and road map of all our labs can be found in our web site also.



A D T

6.APPENDIX A - MODIFICATIONS RECORDERS FOR ENGINEERING CHANGES TO THE EUT BY THE LAB

No any modifications are made to the EUT by the lab during the test.

--- END ---