

# FCC RADIO TEST REPORT

according to

47 CFR FCC Part 15 Subpart C § 15.247

**Model Name** : TG789bvn, TG789bvn HPNA  
**Model No.** : DSLCBA863AG, DSLCBA863BH, DSLCBA663TX  
**Filing Type** : New Application  
**FCC ID** : RSE-TG789BVNHPNA  
**Trade Name** : technicolor  
**Applicant** : **Technicolor Delivery Technologies Belgium**  
Prins Boudewijnlaan 47 B-2650 Edegem Belgium

## Statement

**Test result included is only for the 802.11b/g/n part of the product.**

The test result in this report refers exclusively to the presented test model / sample.

Without written approval of SPORTON International Inc., the test report shall not be reproduced except in full.

The measurements and test results shown in this test report were made in accordance with the procedures and found in compliance with the limit given in **ANSI C63.10-2009, 47 CFR FCC Part 15 Subpart C, KDB 558074 D01 v03 and KDB 662911 D01 v02.**

The test equipment used to perform the test is calibrated and traceable to NML/ROC.



***SPORTON International Inc.***

*No.8, Lane 724, Bo-ai St., Jhubei City, HsinChu County 302, Taiwan, R.O.C.*

**Table of Contents**

**1 SUMMARY OF THE TEST RESULT ..... 2**

1.1 Information provided by the manufacturer..... 3

1.2 Cabling attached to the equipment..... 3

1.3 Panel Drawing ..... 4

**2 GENERAL INFORMATION..... 5**

2.1 Product Details ..... 5

2.2 Accessories ..... 6

2.3 Table for Filed Antenna ..... 6

2.4 Transmit Operating Modes..... 8

2.5 Table for Carrier Frequencies ..... 9

2.6 Table for Test Modes ..... 10

2.7 Table for Testing Locations ..... 12

2.8 Table for Supporting Units..... 12

2.9 Table for Parameters of Test Software Setting ..... 13

2.10 Test Configuration ..... 14

**3 TEST RESULT ..... 16**

3.1 AC Power Line Conducted Emissions Measurement..... 16

3.2 Maximum Conducted Output Power Measurement ..... 20

3.3 Power Spectral Density Measurement ..... 27

3.4 6dB Spectrum Bandwidth Measurement..... 48

3.5 Radiated Emissions Measurement..... 61

3.6 Band Edge and Fundamental Emissions Measurement ..... 128

3.7 Antenna Requirements..... 191

**4 LIST OF MEASURING EQUIPMENTS ..... 192**

**5 TEST LOCATION..... 194**

**6 MEASUREMENT UNCERTAINTY ..... 195**

**APPENDIX A. TEST PHOTO..... A1 ~ A5**

**APPENDIX B. MAXIMUM PERMISSIBLE EXPOSURE..... B1 ~ B3**

**APPENDIX C. PHOTOGRAPHS OF EUT ..... C1 ~ C15**

**APPENDIX D. SSROM VALUE AND CURPOWER VALUE ..... D1 ~ D26**

**History of This Test Report**

<b>REPORT NO.</b>	<b>VERSION</b>	<b>DESCRIPTION</b>	<b>ISSUED DATE</b>
FR362152	Rev.01	Initial issue of report	Jul. 18, 2013

# **CERTIFICATE OF COMPLIANCE**

according to

47 CFR FCC Part 15 Subpart C § 15.247

Model Name : TG789bvn, TG789bvn HPNA  
Model No. : DSLCBA863AG, DSLCBA863BH, DSLCBA663TX  
Trade Name : technicolor  
Applicant : Technicolor Delivery Technologies Belgium  
Prins Boudewijnlaan 47 B-2650 Edegem Belgium

Sporton International as requested by the applicant to evaluate the EMC performance of the product sample received on May 31, 2013 would like to declare that the tested sample has been evaluated and found to be in compliance with the tested rule parts. The data recorded as well as the test configuration specified is true and accurate for showing the sample's EMC nature.

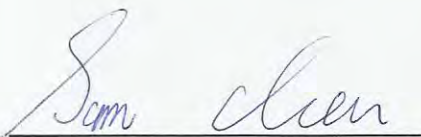

**Sam Chen**

***SPORTON International Inc.***

*No.8, Lane 724, Bo-ai St., Jhubei City, HsinChu County 302, Taiwan, R.O.C.*

**1 SUMMARY OF THE TEST RESULT**

<b>Applied Standard: 47 CFR FCC Part 15 Subpart C</b>				
<b>Part</b>	<b>Rule Section</b>	<b>Description of Test</b>	<b>Result</b>	<b>Under Limit</b>
3.1	15.207	AC Power Line Conducted Emissions	Complies	14.68 dB
3.3	15.247(b)(3)	Conducted Output Power	Complies	4.21 dB
3.4	15.247(e)	Power Spectral Density	Complies	16.79 dB
3.5	15.247(a)(2)	6dB Spectrum Bandwidth	Complies	-
3.6	15.247(d)	Radiated Emissions	Complies	0.81 dB
3.8	15.247(d)	Band Edge Emissions	Complies	0.67 dB
3.9	15.203	Antenna Requirements	Complies	-

**1.1 Information provided by the manufacturer**

Model Name: TG789bvn, TG789bvn HPNA

Model No.: DSLCBA863AG, DSLCBA863BH, DSLCBA663TX

Trade Name: technicolor

Power Supply: Switching-Type, 12Vdc, 2.25A, Manufacturer: AcBel, Model: WAB014, P/N: DSL37070510

AC Power Cord: Wall-mount, 2pin

Hardware Version: PEM1

Interface Availability

Interface / Model Name	Model No.	DC 12Vdc 2.25A	ADSL: (ADSL/2/2+ Annex A, ADSL 2 L1) VDSL2 17a + VDSL2 bonding up to 12a on 2nd AFE: (B7-6, B7-8 B7-13, B8-6 B8-13)	Ethernet 10/100/1000 Mbps	USB 2.0	Voice	WLAN IEEE 802.11 b/g/n 2.4GHz	HPNA
TG789bvn	DSLCBA863AG	●	●	●(5 port)	●(1 port)	●(2 port)	●	○
TG789bvn HPNA	DSLCBA863BH	●	●	●(5 port)	●(1 port)	●(2 port)	●	●
TG789bvn HPNA	DSLCBA663TX	●	●	●(5 port)	●(1 port)	●(2 port)	●	●

- : Equipped
- : Not Equipped

**1.2 Cabling attached to the equipment**

US Standard: 47 CFR FCC Part 15 Subpart C § 15.247  
 ANSI C63.10-2009  
 KDB662911 D01 Multiple Transmitter Output v02,05/28/2013  
 KDB558074 D01 DTS Meas Guidance v03 , 04/08/2013

Cabling Attached to the Equipment

Table 1- Cable and Interconnection

Interface	Cable type	Cable length delivered with the modem	“Real life” Cable length that can be attached to this type of interface	Cable length to be used for testing	Internal / external connection
DSL	UTP Cat 3	2 meter flat cable	> 10 meter	10 meter	External
Eth1, WAN	UTP Cat 5	2 meter	> 10 meter	Two 10 meter cables;	Internal
Line1/2	UTP Cat 3	2 meter	> 10 meter	1 meter flat cable	Internal
PSTN	UTP Cat 3	2 meter flat cable	> 10 meter	10 meter	External
USB1	STP	N/A	< 3 meter	N/A	Internal
HPNA	coaxial	2 meter	> 10 meter	10 meter	Internal
AC power	-	-	-	-	External

**1.3 Panel Drawing**

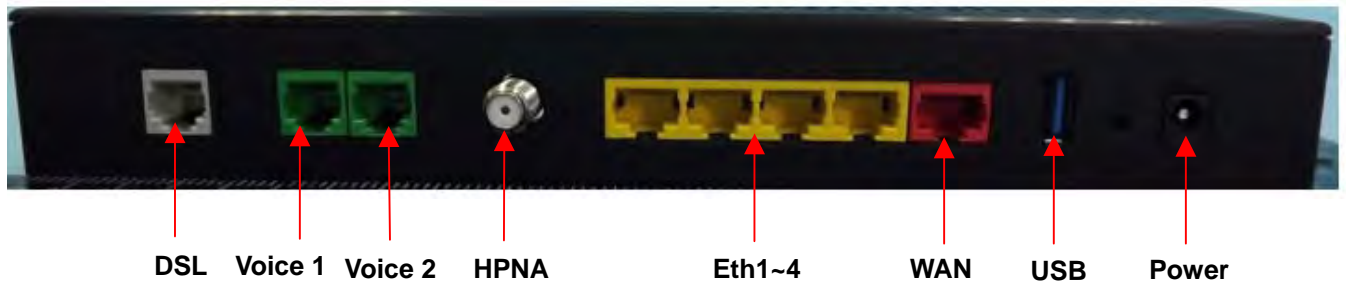

## 2 GENERAL INFORMATION

### 2.1 Product Details

The radio detail of IEEE 802.11b/g/n is shown in the table below. For more detailed features description, please refer to the manufacturer's specifications or user's manual.

Items	Description	
Product	Stand alone	
Model No.	DSLCA863AG, DSLCA863BH, DSLCA663TX	
FCC ID	RSE-TG789BVNHPNA	
Product Type	IEEE 802.11b/g: WLAN (1TX, 2RX) IEEE 802.11n (MCS0): WLAN (1TX, 2RX) IEEE 802.11n (MCS8): WLAN (2TX, 2RX)	
Power Type	From Power Adapter	
Modulation	DSSS for IEEE 802.11b ; OFDM for IEEE 802.11g and IEEE 802.11n	
Data Modulation	DSSS (DBPSK / DQPSK / CCK) ; OFDM (BPSK / QPSK / 16QAM / 64QAM) See the below table for 802.11n	
Data Rate (Mbps)	11b mode :DSSS (1/2/5.5/11) 11g mode :OFDM (6/9/12/18/24/36/48/54) 11n(20MHz) mode(MCS0~MCS15); 11n(40MHz) mode(MCS0~MCS15)	
Nominal Channel Bandwidth	20MHz / 40MHz	
Number of Channel	11 channels for 20MHz / 7 channels for 40MHz	
Channel Spacing	5MHz	
Operating Band	2400~2483.5MHz	<input checked="" type="checkbox"/> IEEE 802.11b
		<input checked="" type="checkbox"/> IEEE 802.11g
		<input checked="" type="checkbox"/> IEEE 802.11n (20MHz)
		<input checked="" type="checkbox"/> IEEE 802.11n (40MHz)
EUT Stage	<input checked="" type="checkbox"/> Product Unit	<input type="checkbox"/> Pre-Sample
Antenna Type	Please see Section 2.3	
I/O Ports	LAN Port x 4 / WAN Port x 1 / USB Host Port x 1 / Voice Port x 2 DSL Port x 1 / HPNA Port x 1(Coaxial type)	
Software version	VDNT-7 (TCH SW #13)	
Channel Band Width (99%)	11b: 10.24 MHz ; 11g: 16.64 MHz 11n (20MHz): 17.76 MHz ; 11n (40MHz): 36.16 MHz	
Conducted Output Power	11b: 22.31 dBm ; 11g: 21.94 dBm MCS0 (20MHz): 22.27 dBm ; MCS0 (40MHz): 18.79 dBm MCS8 (20MHz): 25.79 dBm ; MCS8 (40MHz): 20.97 dBm	



**2.2 Accessories**

Power	Brand	Model	Rating
Switching-Type Power Adapter	AcBel	WAB014	Input:100-240V~0.7A 50/60Hz Output: 12V, 2.25A

**2.3 Table for Filed Antenna**

Ant.	Brand	Model Name	Antenna Type	Connector
1	WHA YU	AGS-104	PCB Antenna	I-PEX
2	WHA YU	AGS-104	PCB Antenna	I-PEX

**Antenna & Bandwidth**

Antenna	Single (TX)		Two (TX)	
Bandwidth Mode	20 MHz	40 MHz	20 MHz	40 MHz
802.11b	V	X	X	X
802.11g	V	X	X	X
802.11n	V	V	V	V

Frequency	Antenna Gain (dBi)			
	Ant. 1 (WJ1)		Ant. 2 (WJ2)	
	20MHz	40MHz	20MHz	40MHz
2412MHz	2.90	-	1.84	-
2422MHz	-	2.41	-	1.81
2437MHz	2.07	2.07	2.33	2.33
2452MHz	-	1.51	-	1.23
2462MHz	1.58	-	2.44	-



IEEE 802.11n Data Rate spec

Standard	INDEX	Data Rate (Mbps)		Standard	INDEX	Data Rate (Mbps)	
		LGI (800ns)	SIGI (400ns)			LGI (800ns)	SIGI (400ns)
11n 20MHz 1 stream	MCS0	6.5	7.2	11n 40MHz 1 stream	MCS0	13.5	15
	MCS1	13	14.4		MCS1	27	30
	MCS2	19.5	21.7		MCS2	40.5	45
	MCS3	26	28.9		MCS3	54	60
	MCS4	39	43.3		MCS4	81	90
	MCS5	52	57.8		MCS5	108	120
	MCS6	58.5	65		MCS6	121.5	135
11n 20MHz 2 stream	MCS7	65	72.2	11n 40MHz 2 stream	MCS7	135	150
	MCS8	13	14.4		MCS8	27	30
	MCS9	26	28.9		MCS9	54	60
	MCS10	39	43.3		MCS10	81	90
	MCS11	52	57.8		MCS11	108	120
	MCS12	78	86.7		MCS12	162	180
	MCS13	104	115.6		MCS13	216	240
	MCS14	117	130		MCS14	243	270
	MCS15	130	144.4	MCS15	270	300	

2.4 Transmit Operating Modes

Transmit Operating Mode					Transmit Multiple Antennas				
<input type="checkbox"/>	Operating mode 1 (single antenna)				<input checked="" type="checkbox"/>	1TX			
<input type="checkbox"/>	Operating mode 2 (multiple antenna, no beam forming)				<input checked="" type="checkbox"/>	<input type="checkbox"/>	<input type="checkbox"/>	<input type="checkbox"/>	<input type="checkbox"/>
<input type="checkbox"/>	Operating mode 3 (multiple antenna, with beam forming)				<input type="checkbox"/>	<input type="checkbox"/>	<input type="checkbox"/>	<input type="checkbox"/>	<input type="checkbox"/>
<input type="checkbox"/>	802.11b	Operating mode	<input checked="" type="checkbox"/>	1TX	<input type="checkbox"/>	<input type="checkbox"/>	<input type="checkbox"/>	<input type="checkbox"/>	Cyclic shift
<input type="checkbox"/>	802.11g	Operating mode	<input checked="" type="checkbox"/>	1TX	<input type="checkbox"/>	<input type="checkbox"/>	<input type="checkbox"/>	<input type="checkbox"/>	Cyclic shift
<input type="checkbox"/>	802.11n(HT20)	Operating mode	<input checked="" type="checkbox"/>	1TX	<input checked="" type="checkbox"/>	<input type="checkbox"/>	<input type="checkbox"/>	<input type="checkbox"/>	Cyclic shift
<input type="checkbox"/>	802.11n(HT40)	Operating mode	<input checked="" type="checkbox"/>	1TX	<input checked="" type="checkbox"/>	<input type="checkbox"/>	<input type="checkbox"/>	<input type="checkbox"/>	Cyclic shift

Note1: For IEEE802.11n, MCS0~MCS7: 1TX SISO ; MCS8~MCS15: 2TX SDM mode

**2.5 Table for Carrier Frequencies**

Eleven channels are provided for 802.11b, 802.11g, 802.11n (20MHz):

Frequency Band	Channel No.	Frequency	Channel No.	Frequency
2400MHz ~ 2483.5 MHz	1	2412 MHz	7	2442MHz
	2	2417MHz	8	2447MHz
	3	2422MHz	9	2452MHz
	4	2427MHz	10	2457MHz
	5	2432MHz	11	2462 MHz
	6	2437 MHz	-	-

Seven channels are provided for 802.11n (40MHz):

Frequency Band	Channel No.	Frequency	Channel No.	Frequency
2400MHz ~ 2483.5 MHz	3	2422 MHz	7	2442MHz
	4	2427MHz	8	2447MHz
	5	2432MHz	9	2452MHz
	6	2437MHz	-	-

**2.6 Table for Test Modes**

Investigation has been done on all the possible configurations for searching the worst cases.

The following table is a list of the test modes shown in this test report.

Test Items	Mode	Note	Channel	Data Rate	Antenna	
AC Power Line Conducted Emissions	11n	OFDM/BPSK	6	-	1+2	
Maximum Average Output Power	11b	DSSS/DBPSK	1/6/11	1Mbps	1	
				1Mbps	2	
	11g	OFDM/BPSK	1/6/11	6Mbps	1	
				6Mbps	2	
	11n(20MHz)	OFDM/BPSK	1/6/11	MCS0	1	
				MCS0	2	
				MCS8	1+2	
	11n(40MHz)	OFDM/BPSK	3/6/9	MCS0	1	
				MCS0	2	
				MCS8	1+2	
	Power Spectral Density	11b	DSSS/DBPSK	1/6/11	1Mbps	2
		11g	OFDM/BPSK	1/11	6Mbps	1
6				6Mbps	2	
11n(20MHz)		OFDM/BPSK	1/11	MCS0	1	
			6	MCS0	2	
			1/6/11	MCS8	1+2	
11n(40MHz)		OFDM/BPSK	6/9	MCS0	1	
			3	MCS0	2	
			3/6/9	MCS8	1+2	
			3/6/9	MCS8	1+2	
6dB Spectrum Bandwidth	11b	DSSS/DBPSK	1/6/11	1Mbps	1	
				1Mbps	2	
	11g	OFDM/BPSK	1/11	6Mbps	1	
				6	6Mbps	2
	11n(20MHz)	OFDM/BPSK	1/11	MCS0	1	
				6	MCS0	2
				1/6/11	MCS8	1+2
	11n(40MHz)	OFDM/BPSK	6/9	MCS0	1	
				3	MCS0	2
				3/6/9	MCS8	1+2
				3/6/9	MCS8	1+2

Band Edge Emissions (Radiated)	11b	DSSS/DBPSK	1/6/11	1Mbps	1	
				1Mbps	2	
	11g		1/6/11	6Mbps	1	
				6Mbps	2	
	11n(20MHz)	OFDM/BPSK	1/6/11	MCS0	1	
				MCS0	2	
				MCS8	1+2	
	11n(40MHz)		3/6/9	MCS0	1	
				MCS0	2	
				MCS8	1+2	
	Radiated Emissions Above 1GHz (Radiated)	11b	DSSS/DBPSK	1/6/11	1Mbps	1
					1Mbps	2
11g			1/6/11	6Mbps	1	
				6Mbps	2	
11n(20MHz)		OFDM/BPSK	1/6/11	MCS0	1	
				MCS0	2	
				MCS8	1+2	
11n(40MHz)			3/6/9	MCS0	1	
				MCS0	2	
				MCS8	1+2	
Radiated Emissions Below 1GHz(Radiated)		11n	OFDM/BPSK	6	-	1+2

**2.7 Table for Testing Locations**

Test Site No.	Site Category	Location	FCC Reg. No.	IC File No.	VCCI Reg. No
03CH01-CB	SAC	Hsin Chu	262045	IC 4086D	-
CO01-CB	Conduction	Hsin Chu	262045	IC 4086D	-
TH01-CB	OVEN Room	Hsin Chu	-	-	-

Open Area Test Site (OATS); Semi Anechoic Chamber (SAC).

**2.8 Table for Supporting Units**

For Test Site No: CO01-CB

Support Unit	Brand	Model	FCC ID
Notebook	DELL	E6430	QDS-BRCM1049LE

For Test Site No: 03CH01-CB

Support Unit	Brand	Model	FCC ID
Notebook	DELL	E6220	D2A62L1989V5

For Test Site No: TH01-CB

Support Unit	Brand	Model	FCC ID
Notebook	DELL	M1330	E2K4965AGNM

**2.9 Table for Parameters of Test Software Setting**

During testing, Channel & Power Controlling Software provided by the customer was used to control the operating channel as well as the output power level. The RF output power selection is for the setting of RF output power expected by the customer and is going to be fixed on the firmware of the final end product.

<b>The Power Setting Parameter</b>						
<b>Power Level</b>		1				
<b>Test Software Version</b>		Telnet 192.168.1.254				
<b>Worst Modulation Mode</b>		<b>Number of Transmit Chains (NTX)</b>	<b>Frequency (MHz)</b>	<b>Power Setting</b>	<b>Output Power</b>	<b>Data Rate / MCS</b>
Ant. 1	802.11b	1Stream 1TX(SISO)	2412	21.25	22.18	1Mbps
Ant. 1	802.11b	1Stream 1TX(SISO)	2437	19.50	19.84	1Mbps
Ant. 1	802.11b	1Stream 1TX(SISO)	2462	21.00	21.93	1Mbps
Ant. 2	802.11b	1Stream 1TX(SISO)	2412	21.25	22.31	1Mbps
Ant. 2	802.11b	1Stream 1TX(SISO)	2437	19.50	19.57	1Mbps
Ant. 2	802.11b	1Stream 1TX(SISO)	2462	21.00	22.02	1Mbps
Ant. 1	802.11g	1Stream 1TX(SISO)	2412	18.50	18.36	6Mbps
Ant. 1	802.11g	1Stream 1TX(SISO)	2437	22.00	21.38	6Mbps
Ant. 1	802.11g	1Stream 1TX(SISO)	2462	18.25	18.07	6Mbps
Ant. 2	802.11g	1Stream 1TX(SISO)	2412	18.50	18.04	6Mbps
Ant. 2	802.11g	1Stream 1TX(SISO)	2437	22.00	21.94	6Mbps
Ant. 2	802.11g	1Stream 1TX(SISO)	2462	18.25	17.62	6Mbps
Ant. 1	802.11n 20MHz	1Stream 1TX(SISO)	2412	18.50	18.37	MCS0
Ant. 1	802.11n 20MHz	1Stream 1TX(SISO)	2437	22.00	21.56	MCS0
Ant. 1	802.11n 20MHz	1Stream 1TX(SISO)	2462	18.25	18.17	MCS0
Ant. 2	802.11n 20MHz	1Stream 1TX(SISO)	2412	18.50	18.29	MCS0
Ant. 2	802.11n 20MHz	1Stream 1TX(SISO)	2437	22.00	22.27	MCS0
Ant. 2	802.11n 20MHz	1Stream 1TX(SISO)	2462	18.25	17.59	MCS0
Ant. 1+2	802.11n 20MHz	2Stream 2TX (SDM)	2412	17.00	19.84	MCS8
Ant. 1+2	802.11n 20MHz	2Stream 2TX (SDM)	2437	23.00	25.79	MCS8
Ant. 1+2	802.11n 20MHz	2Stream 2TX (SDM)	2462	17.50	19.98	MCS8
Ant. 1	802.11n 40MHz	1Stream 1TX(SISO)	2422	17.25	17.23	MCS0
Ant. 1	802.11n 40MHz	1Stream 1TX(SISO)	2437	19.25	18.79	MCS0
Ant. 1	802.11n 40MHz	1Stream 1TX(SISO)	2452	18.25	18.11	MCS0
Ant. 2	802.11n 40MHz	1Stream 1TX(SISO)	2422	17.25	17.09	MCS0
Ant. 2	802.11n 40MHz	1Stream 1TX(SISO)	2437	19.25	18.71	MCS0
Ant. 2	802.11n 40MHz	1Stream 1TX(SISO)	2452	18.25	17.31	MCS0
Ant. 1+2	802.11n 40MHz	2Stream 2TX (SDM)	2422	14.25	17.64	MCS8
Ant. 1+2	802.11n 40MHz	2Stream 2TX (SDM)	2437	18.25	20.97	MCS8
Ant. 1+2	802.11n 40MHz	2Stream 2TX (SDM)	2452	16.25	19.28	MCS8



2.10 Test Configuration

2.10.1 AC Power Line Conduction Emissions Test Configuration

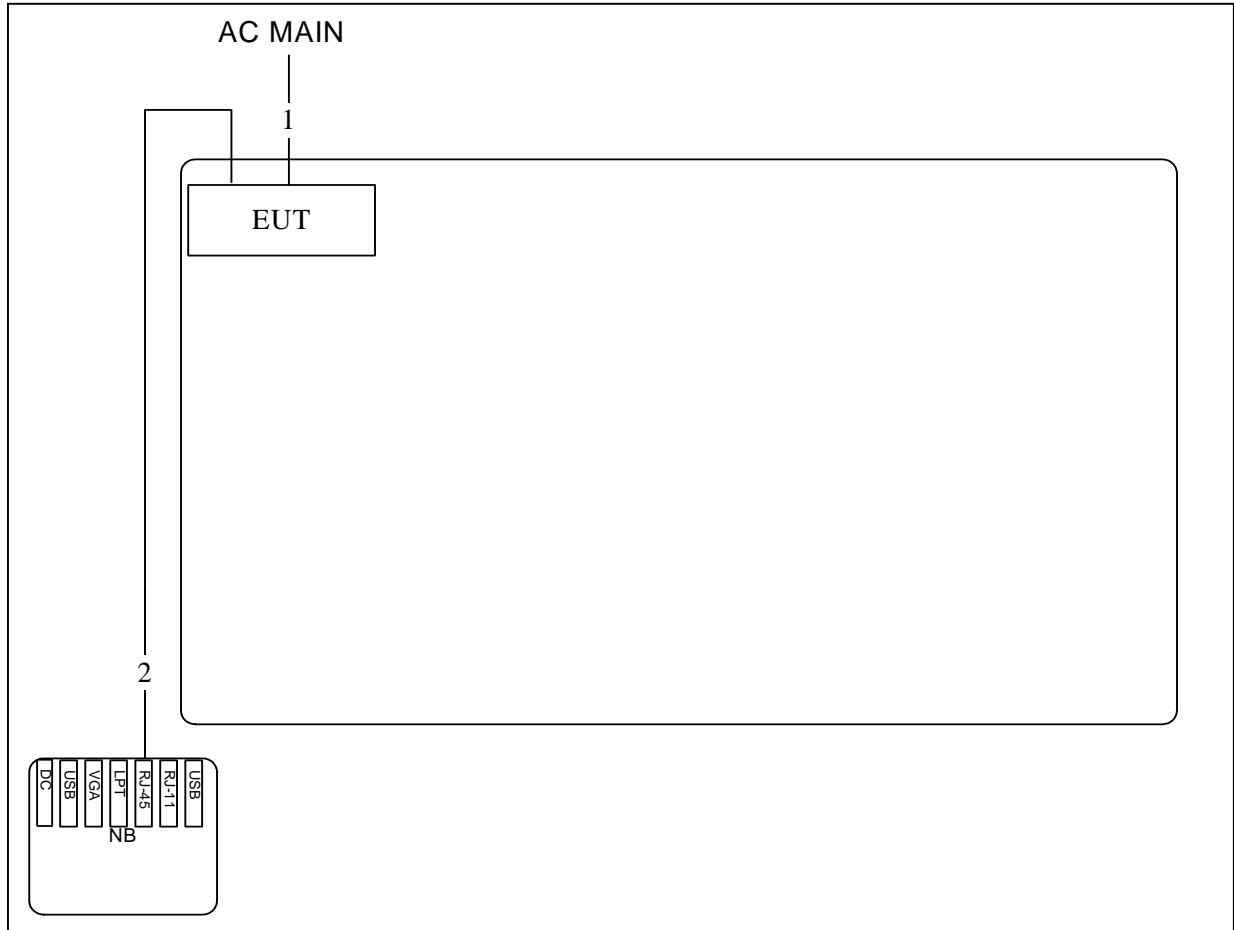

Item	Connection	Shield	Length
1	Power cable	No	1.5M
2	RJ-45 cable	No	10M

2.10.2 Radiation Emissions Test Configuration

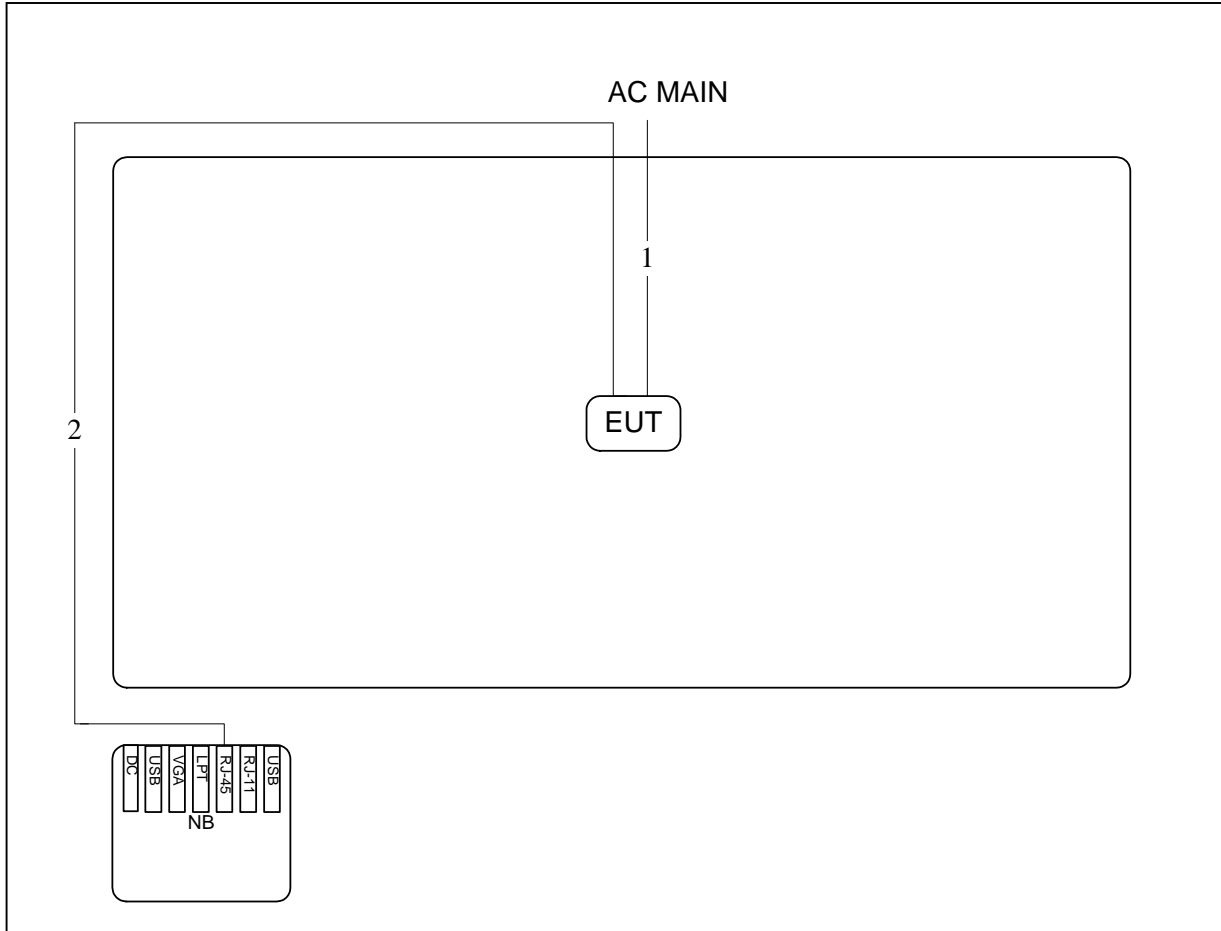

Item	Connection	Shield	Length
1	Power cable	No	1.5M
2	RJ-45 cable	No	10M

### 3 TEST RESULT

#### 3.1 AC Power Line Conducted Emissions Measurement

##### 3.1.1 Limit

For this product which is designed to be connected to the AC power line, the radio frequency voltage that is conducted back onto the AC power line on any frequency or frequencies within the band 150 kHz to 30 MHz shall not exceed below limits table.

Frequency (MHz)	QP Limit (dBuV)	AV Limit (dBuV)
0.15~0.5	66~56	56~46
0.5~5	56	46
5~30	60	50

##### 3.1.2 Measuring Instruments and Setting

Please refer to section 4 of equipments list in this report. The following table is the setting of the receiver.

Receiver Parameters	Setting
Attenuation	10 dB
Start Frequency	0.15 MHz
Stop Frequency	30 MHz
IF Bandwidth	9 KHz

##### 3.1.3 Test Procedures

1. Configure the EUT according to ANSI C63.10. The EUT or host of EUT has to be placed 0.4 meter far from the conducting wall of the shielding room and at least 80 centimeters from any other grounded conducting surface.
2. Connect EUT or host of EUT to the power mains through a line impedance stabilization network (LISN).
3. All the support units are connected to the other LISNs. The LISN should provide 50uH/50ohms coupling impedance.
4. The frequency range from 150 KHz to 30 MHz was searched.
5. Set the test-receiver system to Peak Detect Function and Specified Bandwidth with Maximum Hold Mode.
6. The measurement has to be done between each power line and ground at the power terminal.

**3.1.4 Test Setup Layout**

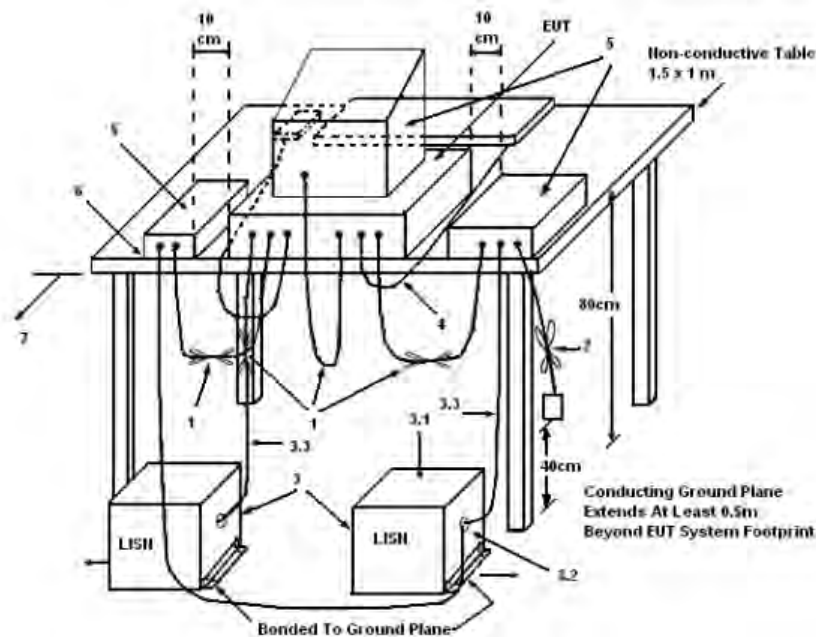

**LEGEND:**

1. Interconnecting cables that hang closer than 40 cm to the ground plane shall be folded back and forth in the center forming a bundle 30 to 40 cm long.
2. I/O cables that are not connected to a peripheral shall be bundled in the center. The end of the cable may be terminated, if required, using the correct terminating impedance. The overall length shall not exceed 1 m.
3. EUT connected to one LISN. Unused LISN measuring port connectors shall be terminated in 50 Ω. LISN can be placed on top of, or immediately beneath, reference ground plane.
4. All other equipment powered from additional LISN(s).
5. Multiple outlet strip can be used for multiple power cords of non-EUT equipment.
6. LISN at least 80 cm from nearest part of EUT chassis.
7. Cables of hand-operated devices, such as keyboards, mice, etc., shall be placed as for normal use.
8. Non-EUT components of EUT system being tested.
9. Rear of EUT, including peripherals, shall all be aligned and flush with rear of tabletop.
10. Rear of tabletop shall be 40 cm removed from a vertical conducting plane that is bonded to the ground plane.

**3.1.5 Test Deviation**

There is no deviation with the original standard.

**3.1.6 EUT Operation during Test**

The EUT was placed on the test table and programmed in normal function.

3.1.7 Results of AC Power Line Conducted Emissions Measurement

Temperature	24°C	Humidity	48%
Test Engineer	Hank Yang	Phase	Line
Configuration	CTX		

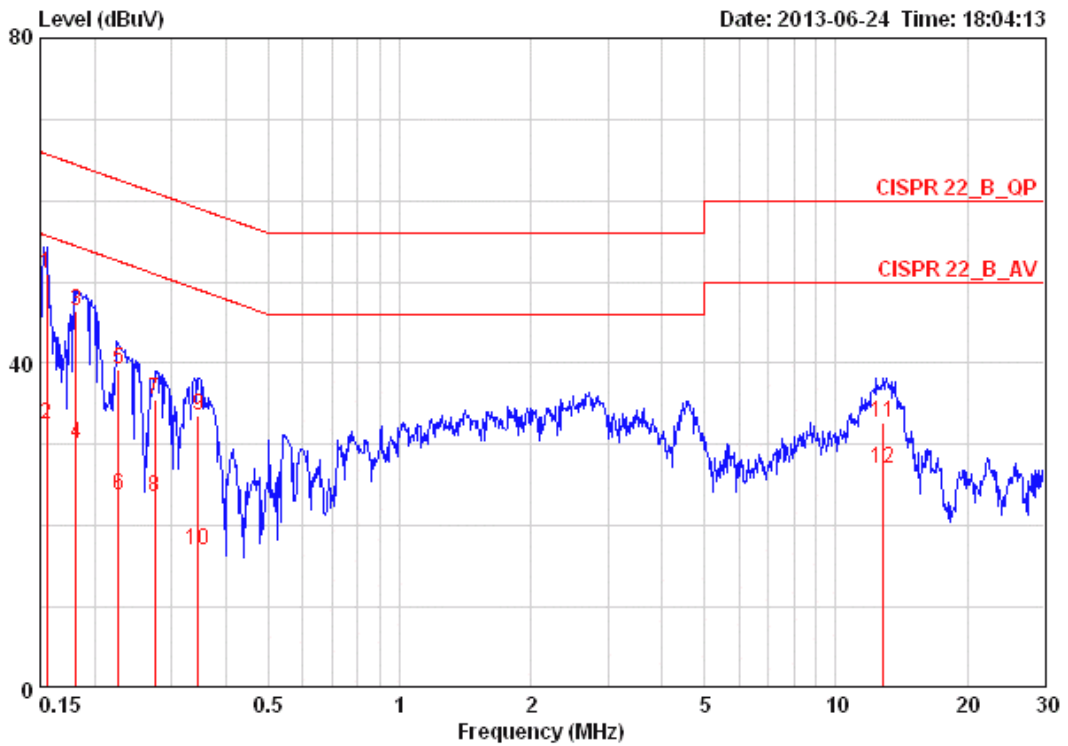

	Freq	Level	Over	Limit	Read	LISN	Cable		
	MHz	dBuV	Limit	Line	Level	Factor	Loss	Pol/Phase	Remark
			dB	dBuV	dBuV	dB	dB		
1	0.15567	51.01	-14.68	65.69	50.67	0.16	0.18	LINE	QP
2	0.15567	32.41	-23.28	55.69	32.07	0.16	0.18	LINE	AVERAGE
3	0.18152	46.48	-17.93	64.42	46.14	0.15	0.19	LINE	QP
4	0.18152	30.14	-24.27	54.42	29.80	0.15	0.19	LINE	AVERAGE
5	0.22676	39.32	-23.25	62.57	38.97	0.15	0.20	LINE	QP
6	0.22676	23.68	-28.89	52.57	23.33	0.15	0.20	LINE	AVERAGE
7	0.27442	35.46	-25.52	60.98	35.11	0.15	0.20	LINE	QP
8	0.27442	23.61	-27.37	50.98	23.26	0.15	0.20	LINE	AVERAGE
9	0.34463	33.51	-25.58	59.09	33.16	0.15	0.20	LINE	QP
10	0.34463	16.96	-32.13	49.09	16.61	0.15	0.20	LINE	AVERAGE
11	12.852	32.72	-27.28	60.00	31.94	0.38	0.40	LINE	QP
12	12.852	26.94	-23.06	50.00	26.16	0.38	0.40	LINE	AVERAGE

Note 1: The test was passed at the minimum margin that marked by the frame in the following data  
 Note 2: The emission levels of other frequencies were very low against the limit.  
 Note 3: Q.P. and AV. are abbreviations of quasi-peak and average individually.  
 Note 4: Corrected Reading (dBµV) = LISN Factor + Cable Loss + Read Level = Level  
 Note 5: Over Limit value = level - Limit value

Temperature	24°C	Humidity	48%
Test Engineer	Hank Yang	Phase	Neutral
Configuration	CTX		

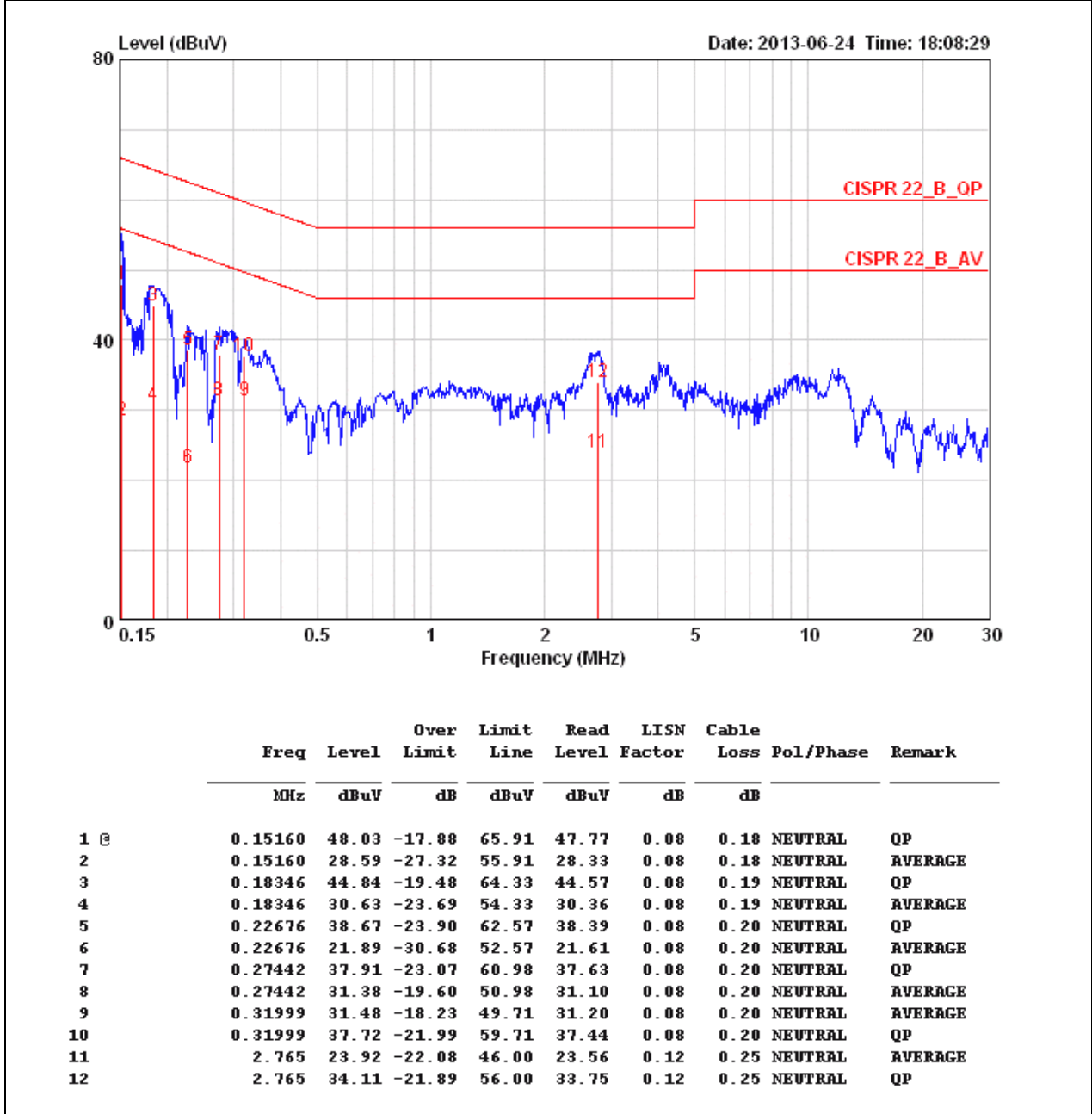

Note 1: The test was passed at the minimum margin that marked by the frame in the following data  
 Note 2: The emission levels of other frequencies were very low against the limit.  
 Note 3: Q.P. and AV. are abbreviations of quasi-peak and average individually.  
 Note 4: Corrected Reading (dBuV) = LISN Factor + Cable Loss + Read Level = Level  
 Note 5: Over Limit value = level - Limit value

**3.2 Maximum Conducted Output Power Measurement**

**3.2.1 Limit**

For systems using digital modulation in the 2400-2483.5MHz, the limit for peak output power is 30dBm. The limited has to be reduced by the amount in dB that the gain of the antenna exceed 6dBi. In case of point-to-point operation, the limit has to be reduced by 1dB for every 3dB that the directional gain of the antenna exceeds 6dBi.

**3.2.2 Measuring Instruments and Setting**

Please refer to section 5 of equipments list in this report. The following table is the setting of spectrum analyzer.

<b>Power Meter Parameter</b>	<b>Setting</b>
Filter No.	Auto
Measurement time	0.135 s ~ 26 s
Power Sensor	MA2411B

**3.2.3 Test Procedures**

1. Test was performed in accordance with Measurement of Digital Transmission Systems Operating under KDB 558074 D01 DTS Meas Guidance v03, 04/08/2013
2. The average power sensor was used on the output port of the EUT. A power meter was used to read the response of the average power sensor and enable the trigger function to get the all on time transmission . Record the average power level.
3. Multiple antenna system was performed in accordance with KDB 662911 D01 v02 Directional Gain Calculations for In-Band Measurements

(i) If any transmit signals are correlated with each other,

$$\text{Directional gain} = G_{ANT} + 10 \log(N_{ANT} / N_{SS}) \text{ dBi}$$

If all transmit signals are completely uncorrelated with each other,

$$\text{Directional gain} = G_{ANT} \text{ dBi}$$

(ii) For power measurements on IEEE 802.11 devices,

$$G_{ANT} = 10 \log[(10^{G1/10} + 10^{G2/10} + \dots + 10^{GN/10}) / N_{ANT}] \text{ dBi}$$

Array Gain = 0 dB (i.e., no array gain) for  $N_{ANT} \leq 4$ ;

Array Gain = 0 dB (i.e., no array gain) for channel widths  $\geq 40$  MHz for any  $N_{ANT}$  ;

Array Gain =  $5 \log(N_{ANT} / N_{SS})$  dB or 3 dB, whichever is less, for 20-MHz channel widths with  $N_{ANT} \geq 5$ .

4. When measuring maximum conducted output power with multiple antenna systems, add every result of the values by mathematic formula.

**3.2.4 Test Setup Layout**

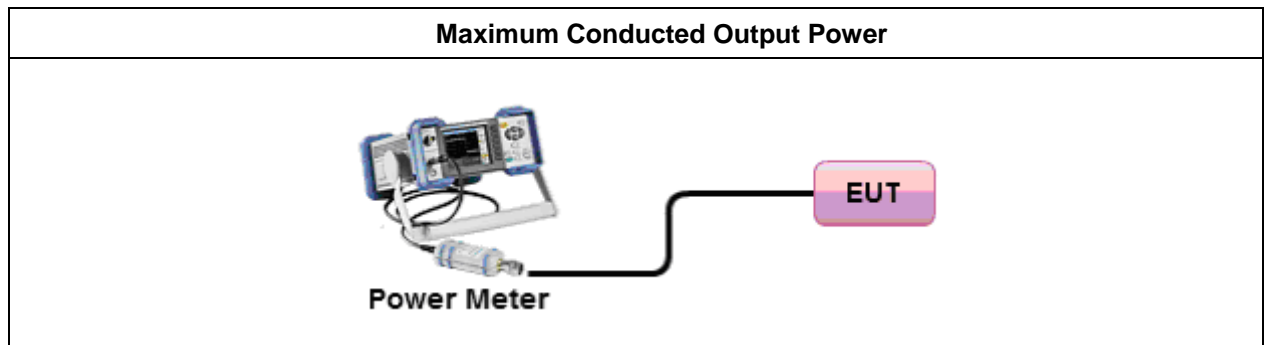

**3.2.5 Test Deviation**

There is no deviation with the original standard.

**3.2.6 EUT Operation during Test**

The EUT was programmed to be in continuously transmitting mode.



3.2.7 Test Result for Maximum Conducted Output Power

Test date	Jun. 13, 2013	Test Site No.	TH01-CB
Temperature	25°C	Humidity	56%
Test Engineer	Denis Su	Configuration	802.11b
Duty Cycle	100%	Duty Factor	0 dB

The power meter can be triggered/signal-gated such that the power is measured only when the EUT is transmitting at its maximum power control level.

Configuration IEEE 802.11b <Ant. 1>

Channel	Frequency	Conducted Power (dBm)	Antenna Gain (dBi)	Max. Limit (dBm)	Result
1	2412 MHz	22.18	2.9	30.00	Complies
6	2437 MHz	19.84	2.07	30.00	Complies
11	2462 MHz	21.93	1.58	30.00	Complies

Note: Uncorrelated Directional gain =  $G_{ANT}$  dBi, < 6dBi

Configuration IEEE 802.11b <Ant. 2>

Channel	Frequency	Conducted Power (dBm)	Antenna Gain (dBi)	Max. Limit (dBm)	Result
1	2412 MHz	22.31	1.84	30.00	Complies
6	2437 MHz	19.57	2.33	30.00	Complies
11	2462 MHz	22.02	2.44	30.00	Complies

Note: Uncorrelated Directional gain =  $G_{ANT}$  dBi, < 6dBi

<b>Test date</b>	Jun. 13, 2013	<b>Test Site No.</b>	TH01-CB
<b>Temperature</b>	25°C	<b>Humidity</b>	56%
<b>Test Engineer</b>	Denis Su	<b>Configuration</b>	802.11g
<b>Duty Cycle</b>	98.56%	<b>Duty Factor</b>	0.06 dB

The power meter can be triggered/signal-gated such that the power is measured only when the EUT is transmitting at its maximum power control level.

**Configuration IEEE 802.11g <Ant. 1>**

Channel	Frequency	Conducted Power (dBm)	Antenna Gain (dBi)	Max. Limit (dBm)	Result
1	2412 MHz	18.36	2.9	30.00	Complies
6	2437 MHz	21.38	2.07	30.00	Complies
11	2462 MHz	18.07	1.58	30.00	Complies

**Note: Uncorrelated Directional gain =  $G_{ANT}$  dBi, < 6dBi**

**Configuration IEEE 802.11g <Ant. 2>**

Channel	Frequency	Conducted Power (dBm)	Antenna Gain (dBi)	Max. Limit (dBm)	Result
1	2412 MHz	18.04	1.84	30.00	Complies
6	2437 MHz	21.94	2.33	30.00	Complies
11	2462 MHz	17.62	2.44	30.00	Complies

**Note: Uncorrelated Directional gain =  $G_{ANT}$  dBi, < 6dBi**

<b>Test date</b>	Jun. 13, 2013	<b>Test Site No.</b>	TH01-CB
<b>Temperature</b>	25°C	<b>Humidity</b>	56%
<b>Test Engineer</b>	Denis Su	<b>Configuration</b>	802.11n
<b>Duty Cycle</b>	98.96%: Ant.1 / Ant. 2 96.51%: Ant.1 + Ant. 2	<b>Duty Factor</b>	0.05 dB: Ant.1 / Ant. 2 0.15 dB: Ant.1 + Ant. 2

The power meter can be triggered/signal-gated such that the power is measured only when the EUT is transmitting at its maximum power control level.

**Configuration of IEEE 802.11n 20MHz MCS0 <Ant. 1>**

Channel	Frequency	Conducted Power (dBm)	Antenna Gain (dBi)	Max. Limit (dBm)	Result
1	2412 MHz	18.37	2.9	30.00	Complies
6	2437 MHz	21.56	2.07	30.00	Complies
11	2462 MHz	18.17	1.58	30.00	Complies

**Note: Uncorrelated Directional gain =  $G_{ANT}$  dBi, < 6dBi**

**Configuration of IEEE 802.11n 20MHz MCS0 <Ant. 2>**

Channel	Frequency	Conducted Power (dBm)	Antenna Gain (dBi)	Max. Limit (dBm)	Result
1	2412 MHz	18.29	1.84	30.00	Complies
6	2437 MHz	22.27	2.33	30.00	Complies
11	2462 MHz	17.59	2.44	30.00	Complies

**Note: Uncorrelated Directional gain =  $G_{ANT}$  dBi, < 6dBi**

**Configuration of IEEE 802.11n 20MHz MCS8 <SDM mode Ant. 1 + Ant. 2>**

Channel	Frequency	Ant. 1 Conducted Power (dBm)	Ant. 1 Gain (dBi)	Ant. 2 Conducted Power (dBm)	Ant. 2 Gain (dBi)	Total Conducted Power (dBm)	Max. Limit (dBm)	Result
1	2412 MHz	17.31	2.9	16.29	1.84	19.84	30.00	Complies
6	2437 MHz	22.36	2.07	23.16	2.33	25.79	30.00	Complies
11	2462 MHz	17.27	1.58	16.65	2.44	19.98	30.00	Complies

**Note: Uncorrelated Directional gain =  $G_{ANT}$  dBi**

$$G_{ANT} = 10 \log\left[\frac{10^{G1/10} + 10^{G2/10} + \dots + 10^{GN/10}}{N_{ANT}}\right] \text{ dBi}$$

**For Power measurements :  $N_{ANT} \leq 4$ ; Array Gain= 0dBi**

**CH1=10 log[(1.950+1.528)/2] + 0= 2.40dBi < 6dBi**

**CH6=10 log[(1.611+1.710)/2] + 0= 2.20dBi < 6dBi**

**CH11=10 log[(1.439+1.754)/2] + 0= 2.03dBi < 6dBi**

**EX:CH1**

**CH1 : Total Power = Ant1+Ant2= 17.31dBm+16.29dBm=10 log(52.83mW+42.56mW)= 19.84dBm**

Test date	Jun. 13, 2013	Test Site No.	TH01-CB
Temperature	25°C	Humidity	56%
Test Engineer	Denis Su	Configuration	802.11n
Duty Cycle	98.96%: Ant.1 / Ant. 2 94.11%: Ant.1 + Ant. 2	Duty Factor	0.05 dB: Ant.1 / Ant. 2 0.26 dB: Ant.1 + Ant. 2

The power meter can be triggered/signal-gated such that the power is measured only when the EUT is transmitting at its maximum power control level.

Configuration of IEEE 802.11n 40MHz MCS0 <Ant. 1>

Channel	Frequency	Conducted Power (dBm)	Antenna Gain (dBi)	Max. Limit (dBm)	Result
3	2422 MHz	17.23	2.41	30.00	Complies
6	2437 MHz	18.79	2.07	30.00	Complies
9	2452 MHz	18.11	1.51	30.00	Complies

Note: Uncorrelated Directional gain =  $G_{ANT}$  dBi, < 6dBi

Configuration of IEEE 802.11n 40MHz MCS0 <Ant. 2>

Channel	Frequency	Conducted Power (dBm)	Antenna Gain (dBi)	Max. Limit (dBm)	Result
3	2422 MHz	17.09	1.81	30.00	Complies
6	2437 MHz	18.71	2.33	30.00	Complies
9	2452 MHz	17.31	1.23	30.00	Complies

Note: Uncorrelated Directional gain =  $G_{ANT}$  dBi, < 6dBi

Configuration of IEEE 802.11n 40MHz MCS8 <SDM mode Ant. 1 + Ant. 2>

Channel	Frequency	Ant. 1 Conducted Power (dBm)	Ant. 1 Gain (dBi)	Ant. 2 Conducted Power (dBm)	Ant. 2 Gain (dBi)	Total Conducted Power (dBm)	Max. Limit (dBm)	Result
3	2422 MHz	14.82	2.41	14.44	1.81	17.64	30.00	Complies
6	2437 MHz	17.96	2.07	17.95	2.33	20.97	30.00	Complies
9	2452 MHz	16.21	1.51	16.33	1.23	19.28	30.00	Complies

Note: Uncorrelated Directional gain =  $G_{ANT}$  dBi

$$G_{ANT} = 10 \log[(10^{G1/10} + 10^{G2/10} + \dots + 10^{GN/10})/N_{ANT}] \text{ dBi}$$

$$CH3 = 10 \log[(1.742+1.517)/2] + 0 = 2.12\text{dBi} < 6\text{dBi}$$

$$CH6 = 10 \log[(1.611+1.710)/2] + 0 = 2.20\text{dBi} < 6\text{dBi}$$

$$CH9 = 10 \log[(1.416+1.237)/2] + 0 = 1.22 \text{ dBi} < 6\text{dBi}$$

EX: CH3

$$CH3 : \text{Total Power} = \text{Ant1}+\text{Ant2} = 14.82\text{dBm}+14.44\text{dBm} = 10 \log(30.34\text{mW}+27.80\text{mW}) = 17.64\text{dBm}$$

**3.3 Power Spectral Density Measurement**

**3.3.1 Limit**

For digitally modulated systems, the power spectral density conducted from the intentional radiator to the antenna shall not be greater than 8 dBm in any 3 kHz band during any time interval of continuous transmission.

**3.3.2 Measuring Instruments and Setting**

Please refer to section 4 of equipments list in this report. The following table is the setting of Spectrum Analyzer.

Power Meter Parameter	Setting
Attenuation	Auto
Span Frequency	Set span to at least 1.5 times the DTS channel bandwidth.
RBW	≥ 3 kHz.
VBW	≥3 x RBW.
Detector	RMS
Trace	Averaging(RMS) mode over a minimum of 100 traces
Sweep Time	Auto

**3.3.3 Test Procedures**

1. Test was performed in accordance with Measurement of Digital Transmission Systems Operating under KDB 558074 D01 DTS Meas Guidance v03, 04/08/2013
2. Multiple antenna system was performed in accordance with KDB 662911 D01 v02 in-Band Power Spectral Density(PSD) Measurements(b) Measure and sum spectral maxima across the outputs. (as described in preceding section)

(i) If any transmit signals are correlated with each other,

$$\text{Directional gain} = G_{ANT} + 10 \log(N_{ANT} / N_{SS}) \text{ dBi}$$

If all transmit signals are completely uncorrelated with each other,

$$\text{Directional gain} = G_{ANT} \text{ dBi}$$

(ii) For power spectral density (PSD) measurements on all devices,

$$G_{ANT} = 10 \log[(10^{G1/10} + 10^{G2/10} + \dots + 10^{GN/10})/N_{ANT}] \text{ dBi}$$

$$\text{Array Gain} = 10 \log(N_{ANT} / N_{SS}) \text{ dB.}$$

3. The transmitter output (antenna port) was connected to the spectrum analyzer. This measurement requires that EUT could be configured to transmit continuously(at a minimum duty cycle of 98%) at full power over the measurement duration. Time intervals during which the transmitter is off or transmitting at reduced power levels shall not be included
4. The resulting PSD level must be ≤ 8 dBm.

**3.3.4 Test Setup Layout**

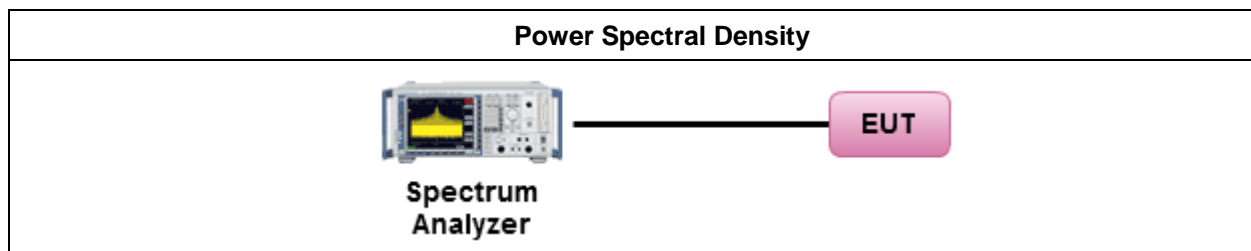

**3.3.5 Test Deviation**

There is no deviation with the original standard.

**3.3.6 EUT Operation during Test**

The EUT was programmed to be in continuously transmitting mode.

3.3.7 Test Result of Power Spectral Density

Test date	Jun. 13, 2013	Test Site No.	TH01-CB
Temperature	25°C	Humidity	56%
Test Engineer	Denis Su	Configuration	802.11b
Duty Cycle	100%	Duty Factor	0 dB

Configuration IEEE 802.11b <Worst mode: Ant. 2>

Channel	Frequency	Power Density (dBm/3kHz)	Total Power Density (dBm/3kHz)	Antenna Gain (dBi)	Power Density Limit (dBm/3kHz)	Result
1	2412 MHz	-9.72	-9.72	1.84	8.00	Complies
6	2437 MHz	-11.27	-11.27	2.33	8.00	Complies
11	2462 MHz	-9.58	-9.58	2.44	8.00	Complies

Note 1: Uncorrelated Directional gain =  $G_{ANT}$  dBi, < 6dBi

Note 2: Power Density + Duty Factor = Total Power Density

Power Density Plot on Configuration IEEE 802.11b / Ant. 2 / 2412 MHz

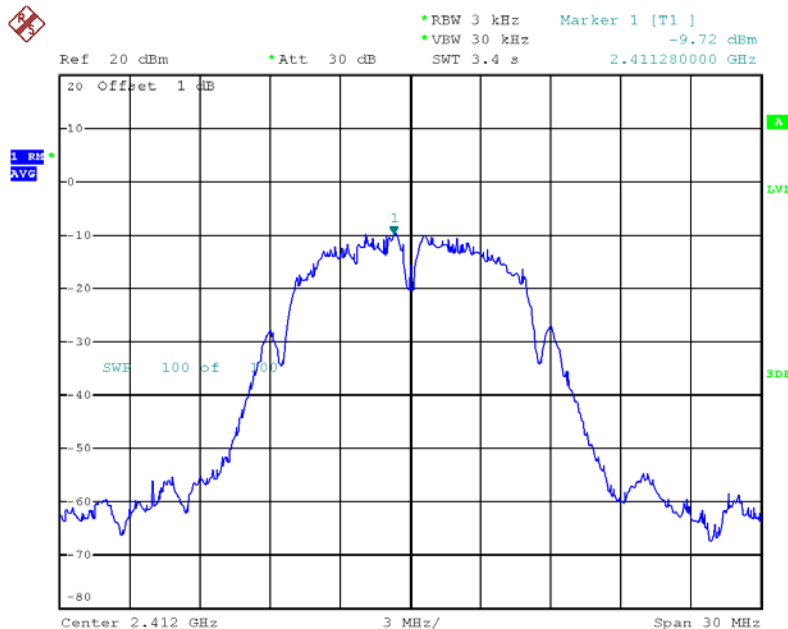

Date: 1.JUL.2013 12:26:21



Power Density Plot on Configuration IEEE 802.11b / Ant. 2 / 2437 MHz

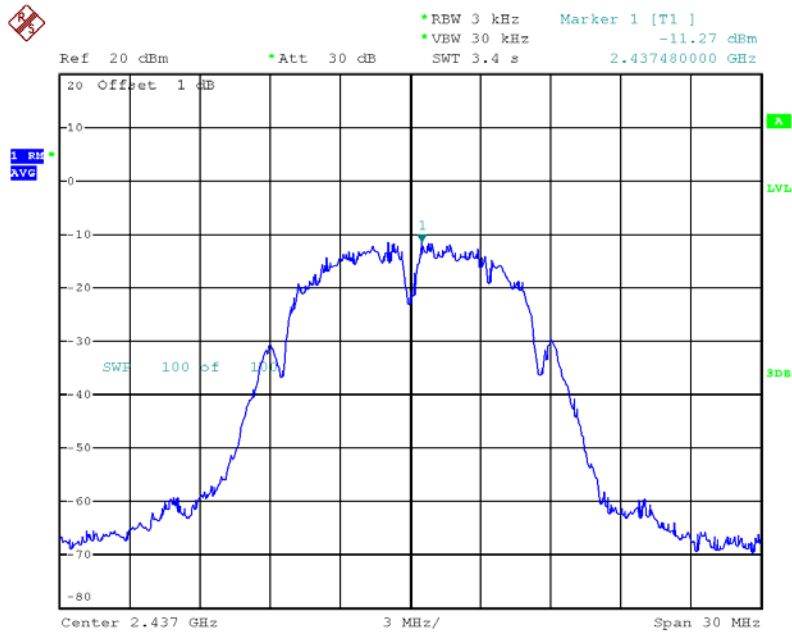

Date: 1.JUL.2013 12:30:13

Power Density Plot on Configuration IEEE 802.11b / Ant. 2 / 2462 MHz

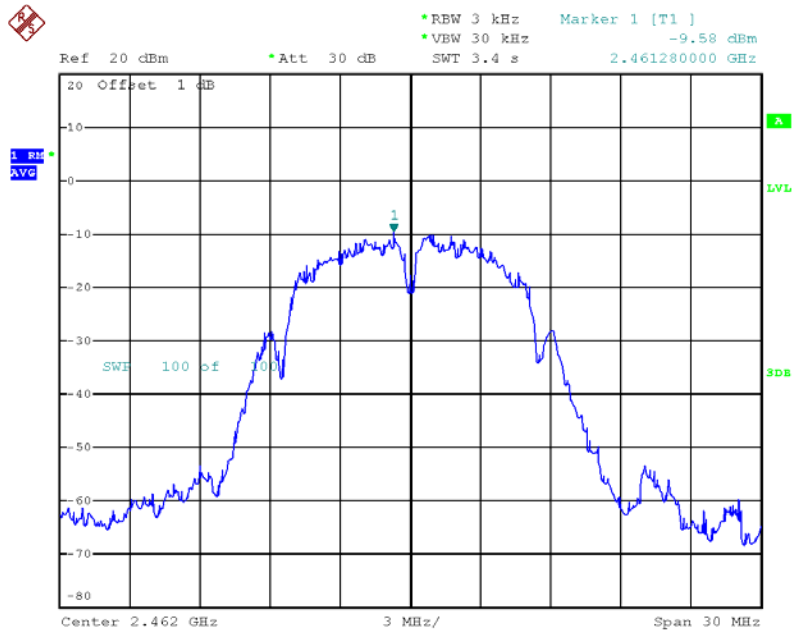

Date: 1.JUL.2013 12:30:47

<b>Test date</b>	Jun. 13, 2013	<b>Test Site No.</b>	TH01-CB
<b>Temperature</b>	25°C	<b>Humidity</b>	56%
<b>Test Engineer</b>	Denis Su	<b>Configuration</b>	802.11g
<b>Duty Cycle</b>	98.56%	<b>Duty Factor</b>	0.06 dB

**Configuration IEEE 802.11g <Worst mode: Ant. 1>**

Channel	Frequency	Power Density (dBm/3kHz)	Total Power Density (dBm/3kHz)	Antenna Gain (dBi)	Power Density Limit (dBm/3kHz)	Result
1	2412 MHz	-16.55	-16.49	2.9	8.00	Complies
11	2462 MHz	-16.50	-16.44	1.58	8.00	Complies

**Note 1: Uncorrelated Directional gain =  $G_{ANT}$  dBi, < 6dBi**

**Note 2: Power Density + Duty Factor = Total Power Density**

**Configuration IEEE 802.11g <Worst mode: Ant. 2>**

Channel	Frequency	Power Density (dBm/3kHz)	Total Power Density (dBm/3kHz)	Antenna Gain (dBi)	Power Density Limit (dBm/3kHz)	Result
6	2437 MHz	-12.43	-12.37	2.33	8.00	Complies

**Note 1: Uncorrelated Directional gain =  $G_{ANT}$  dBi, < 6dBi**

**Note 2: Power Density + Duty Factor = Total Power Density**

Power Density Plot on Configuration IEEE 802.11g / Ant. 1 / 2412 MHz

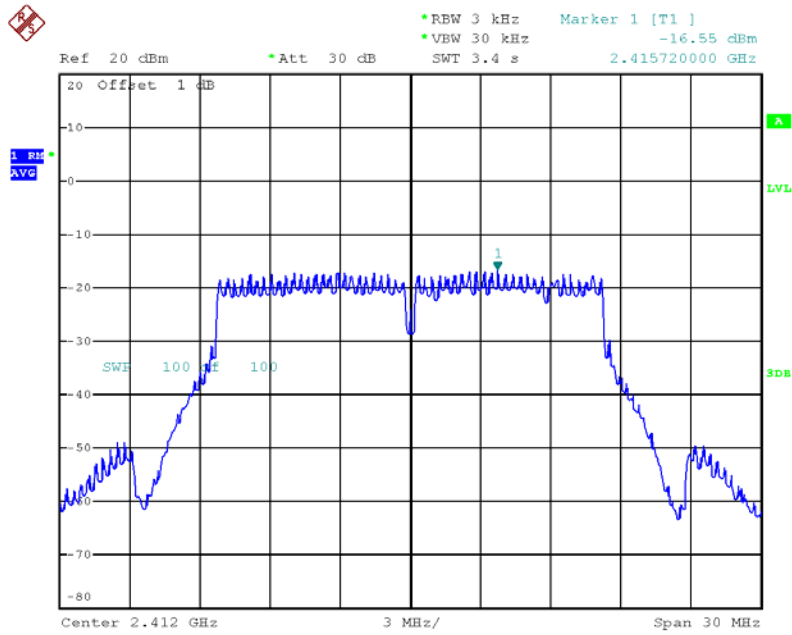

Date: 1.JUL.2013 12:33:10

Power Density Plot on Configuration IEEE 802.11g / Ant. 2 / 2437 MHz

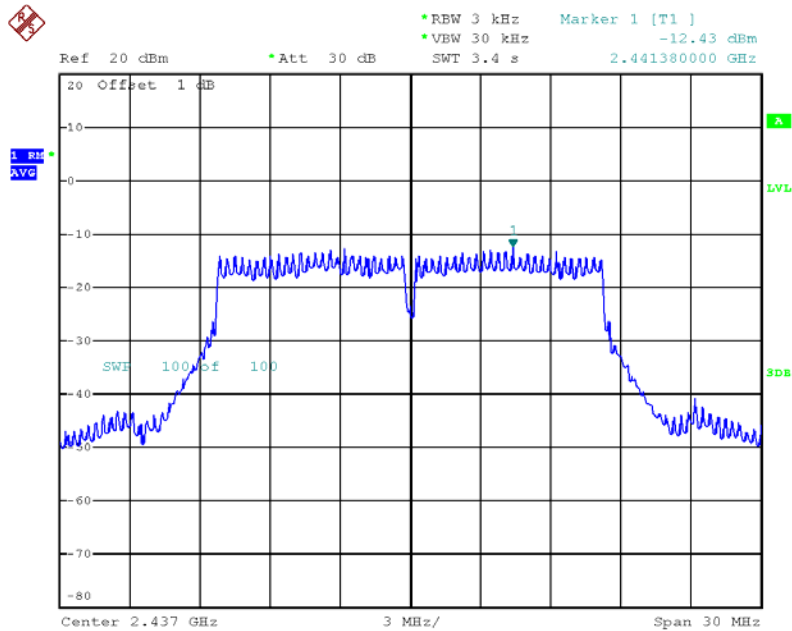

Date: 1.JUL.2013 12:32:01

Power Density Plot on Configuration IEEE 802.11g / Ant. 1 / 2462 MHz

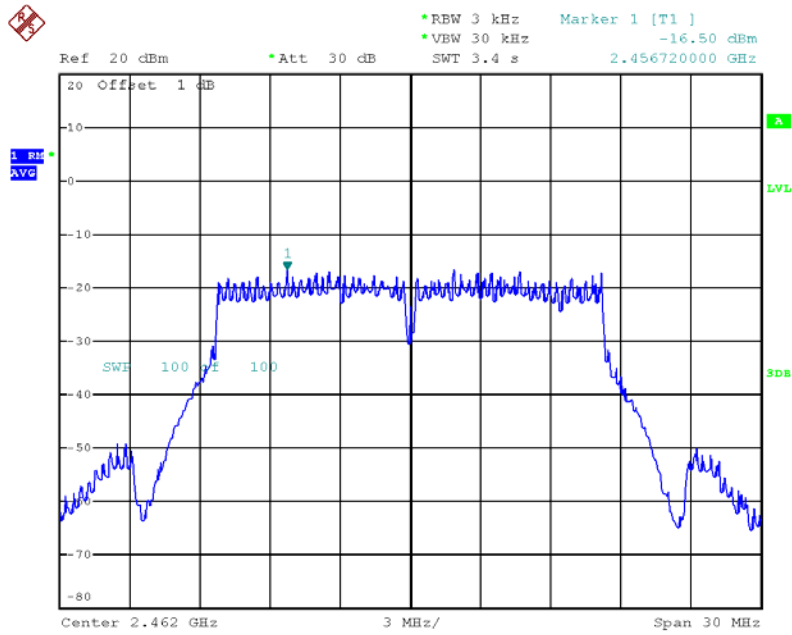

Date: 1.JUL.2013 12:33:43

<b>Test date</b>	Jun. 13, 2013	<b>Test Site No.</b>	TH01-CB
<b>Temperature</b>	25°C	<b>Humidity</b>	56%
<b>Test Engineer</b>	Denis Su	<b>Configuration</b>	802.11n
<b>Duty Cycle</b>	98.96%: Ant.1 / Ant. 2 96.51%: Ant.1 + Ant. 2	<b>Duty Factor</b>	0.05 dB: Ant.1 / Ant. 2 0.15 dB: Ant.1 + Ant. 2

**Configuration of IEEE 802.11n 20MHz MCS0 <Worst mode: Ant. 1>**

Channel	Frequency	Power Density (dBm/3kHz)	Total Power Density (dBm/3kHz)	Antenna Gain (dBi)	Power Density Limit (dBm/3kHz)	Result
1	2412 MHz	-16.04	-15.99	2.9	8.00	Complies
11	2462 MHz	-16.54	-16.49	1.58	8.00	Complies

**Note 1: Uncorrelated Directional gain =  $G_{ANT}$  dBi, < 6dBi**

**Note 2: Power Density + Duty Factor = Total Power Density**

**Configuration of IEEE 802.11n 20MHz MCS0 <Worst mode: Ant. 2>**

Channel	Frequency	Power Density (dBm/3kHz)	Total Power Density (dBm/3kHz)	Antenna Gain (dBi)	Power Density Limit (dBm/3kHz)	Result
6	2437 MHz	-12.96	-12.91	2.33	8.00	Complies

**Note 1: Uncorrelated Directional gain =  $G_{ANT}$  dBi, < 6dBi**

**Note 2: Power Density + Duty Factor = Total Power Density**

Configuration of IEEE 802.11n 20MHz MCS8 <SDM mode: Ant. 1 + Ant. 2>

Channel	Frequency	Ant. 1 Power Density (dBm/3kHz)	Ant. 1 Gain (dBi)	Ant. 2 Power Density (dBm/3kHz)	Ant. 2 Gain (dBi)	Total Power Density (dBm/3kHz)	Power Density Limit (dBm/3kHz)	Result
		Chain 1		Chain 2				
1	2412 MHz	-17.72	2.9	-18.88	1.84	-15.10	8.00	Complies
6	2437 MHz	-12.17	2.07	-11.75	2.33	-8.79	8.00	Complies
11	2462 MHz	-17.70	1.58	-18.03	2.44	-14.70	8.00	Complies

Note 1: Uncorrelated Directional gain =  $G_{ANT}$  dBi, < 6dBi

$$G_{ANT} = 10 \log[(10^{G1/10} + 10^{G2/10} + \dots + 10^{GN/10}) / N_{ANT}] \text{ dBi}$$

$$CH1 = 10 \log[(1.950 + 1.528) / 2] + 0 = 2.40 \text{ dBi} < 6 \text{ dBi}$$

$$CH6 = 10 \log[(1.611 + 1.710) / 2] + 0 = 2.20 \text{ dBi} < 6 \text{ dBi}$$

$$CH11 = 10 \log[(1.439 + 1.754) / 2] + 0 = 2.03 \text{ dBi} < 6 \text{ dBi}$$

EX:CH6

$$\begin{aligned} \text{Total PSD} &= \text{Ant1} + \text{Ant2} = -12.17 \text{ dBm} + -11.75 \text{ dBm} = 10 \log(0.0607 \text{ mW} + 0.0668 \text{ mW}) + 0.15 \text{ dB} \\ &= -8.79 \text{ dBm/3kHz} \end{aligned}$$

Power Density Plot on Configuration of IEEE 802.11n 20MHz MCS0 / Ant. 1/ 2412 MHz

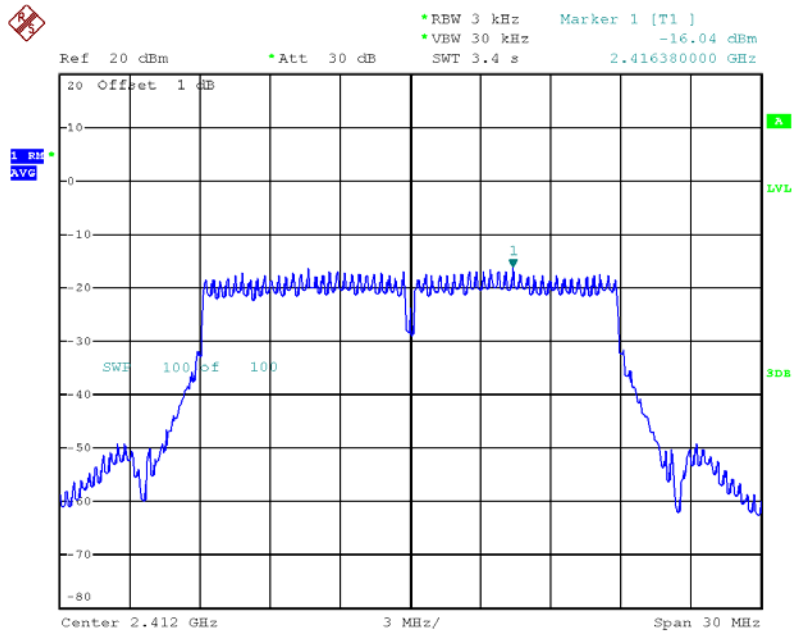

Date: 1.JUL.2013 12:37:42

Power Density Plot on Configuration of IEEE 802.11n 20MHz MCS0 / Ant. 2/ 2437 MHz

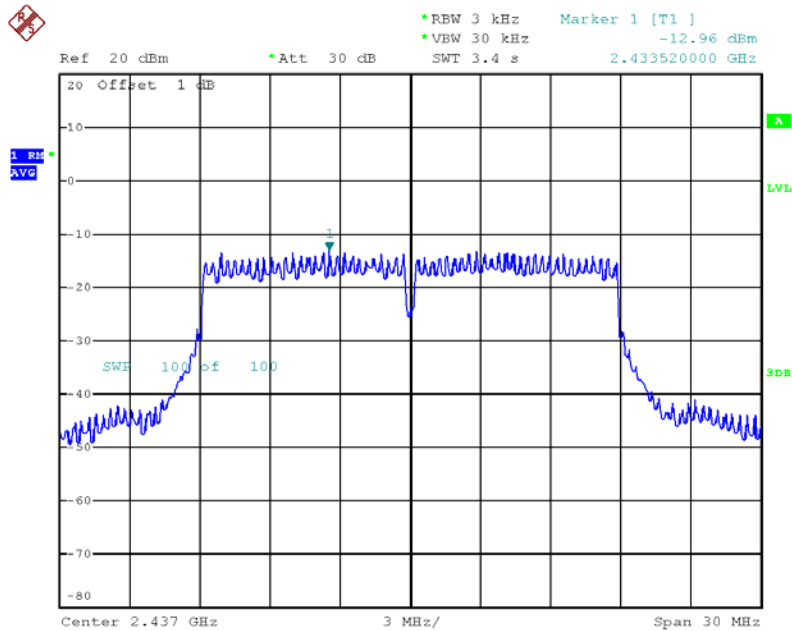

Date: 1.JUL.2013 12:38:56

Power Density Plot on Configuration of IEEE 802.11n 20MHz MCS0 / Ant. 1 / 2462 MHz

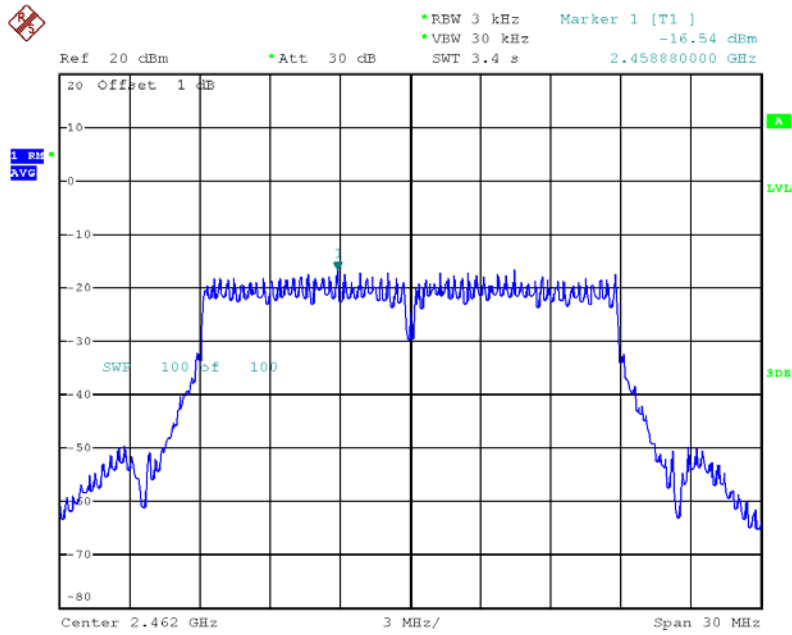

Date: 1.JUL.2013 12:36:26



Power Density Plot on Configuration of IEEE 802.11n 20MHz MCS8 / Ant. 1 / 2412 MHz

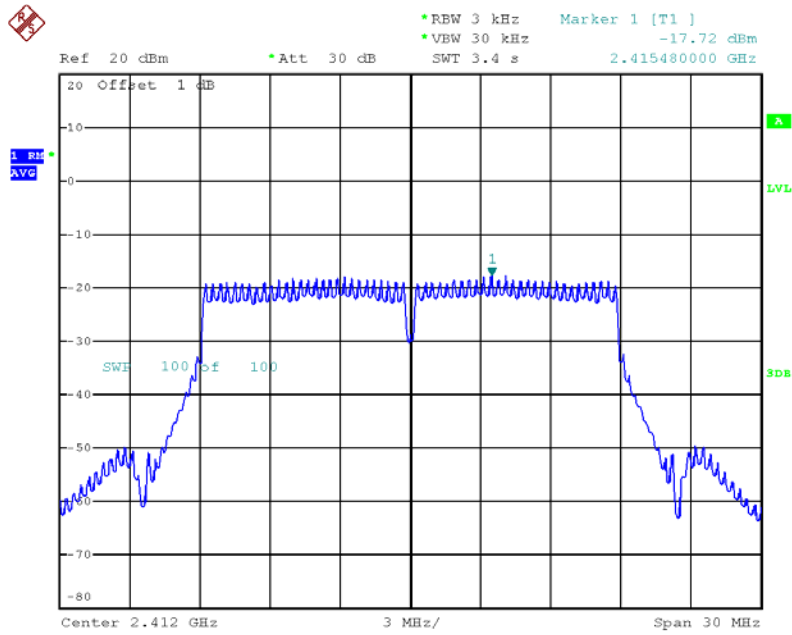

Date: 1.JUL.2013 12:54:46

Power Density Plot on Configuration of IEEE 802.11n 20MHz MCS8 / Ant. 2 / 2412 MHz

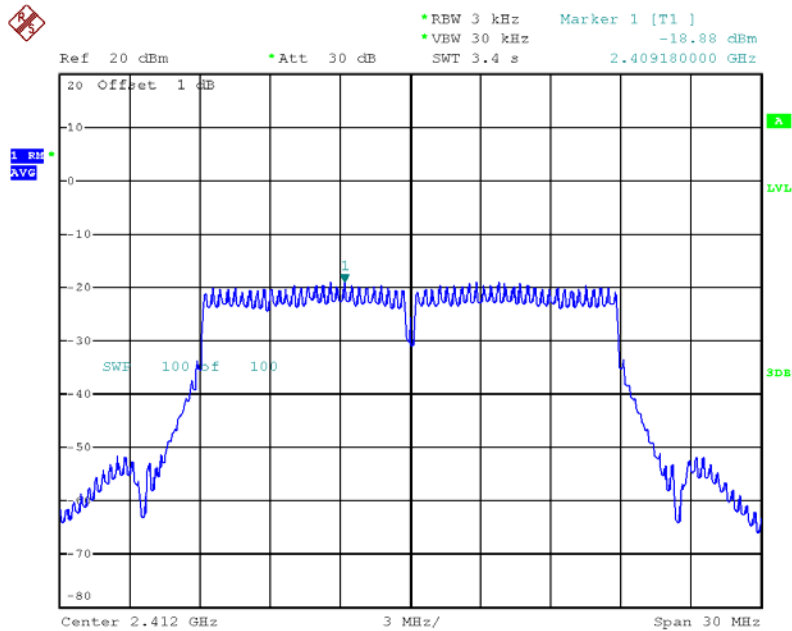

Date: 1.JUL.2013 12:53:53

Power Density Plot on Configuration of IEEE 802.11n 20MHz MCS8 / Ant. 1 / 2437 MHz

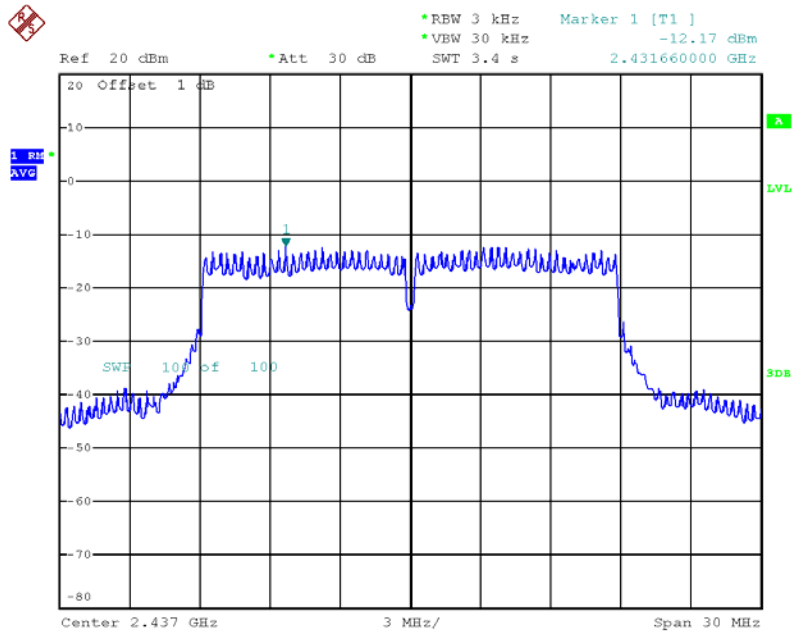

Date: 1.JUL.2013 12:57:33

Power Density Plot on Configuration of IEEE 802.11n 20MHz MCS8 / Ant. 2 / 2437 MHz

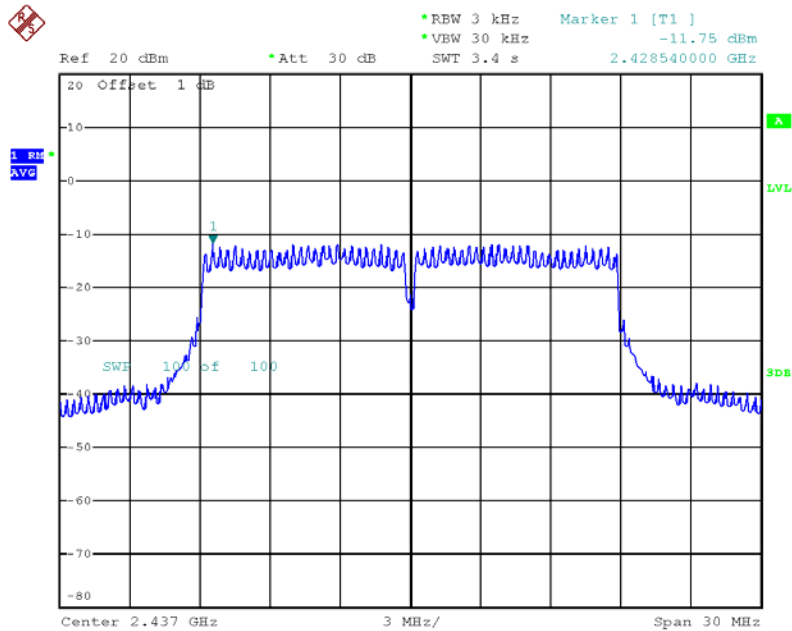

Date: 1.JUL.2013 12:58:04

Power Density Plot on Configuration of IEEE 802.11n 20MHz MCS8 / Ant. 1 / 2462 MHz

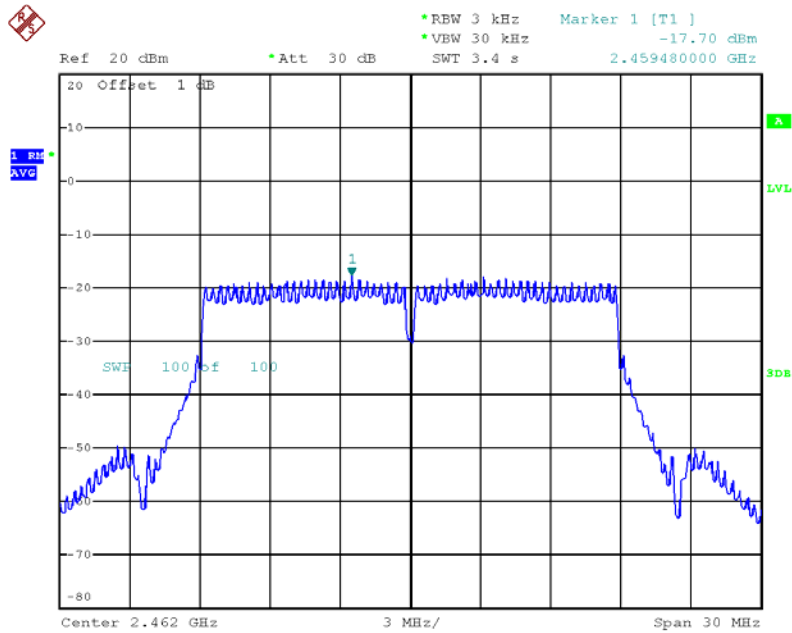

Date: 1.JUL.2013 12:59:49

Power Density Plot on Configuration of IEEE 802.11n 20MHz MCS8 / Ant. 2 / 2462 MHz

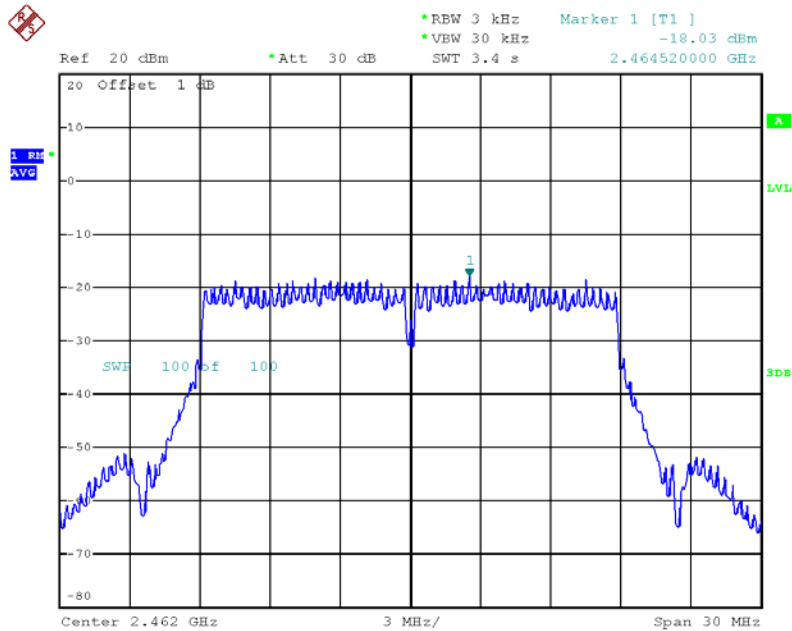

Date: 1.JUL.2013 12:59:20

<b>Test date</b>	Jun. 13, 2013	<b>Test Site No.</b>	TH01-CB
<b>Temperature</b>	25°C	<b>Humidity</b>	56%
<b>Test Engineer</b>	Denis Su	<b>Configuration</b>	802.11n
<b>Duty Cycle</b>	98.96%: Ant.1 / Ant. 2 94.11%: Ant.1 + Ant. 2	<b>Duty Factor</b>	0.05 dB: Ant.1 / Ant. 2 0.26 dB: Ant.1 + Ant. 2

**Configuration of IEEE 802.11n 40MHz MCS0 <Worst mode: Ant. 1>**

Channel	Frequency	Power Density (dBm/3kHz)	Total Power Density (dBm/3kHz)	Antenna Gain (dBi)	Power Density Limit (dBm/3kHz)	Result
6	2437 MHz	-20.88	-20.83	2.07	8.00	Complies
9	2452 MHz	-19.67	-19.62	1.51	8.00	Complies

**Note 1: Uncorrelated Directional gain =  $G_{ANT}$  dBi, < 6dBi**

**Note 2: Power Density + Duty Factor = Total Power Density**

**Configuration of IEEE 802.11n 40MHz MCS0 <Worst mode: Ant. 2>**

Channel	Frequency	Power Density (dBm/3kHz)	Total Power Density (dBm/3kHz)	Antenna Gain (dBi)	Power Density Limit (dBm/3kHz)	Result
3	2422 MHz	-18.25	-18.20	1.81	8.00	Complies

**Note 1: Uncorrelated Directional gain =  $G_{ANT}$  dBi, < 6dBi**

**Note 2: Power Density + Duty Factor = Total Power Density**

Configuration of IEEE 802.11n 40MHz MCS8 <SDM mode: Ant. 1 + Ant. 2>

Channel	Frequency	Ant. 1 Power Density (dBm/3kHz)	Ant. 1 Gain (dBi)	Ant. 2 Power Density (dBm/3kHz)	Ant. 2 Gain (dBi)	Total Power Density (dBm/3kHz)	Power Density Limit (dBm/3kHz)	Result
3	2422 MHz	-22.23	2.9	-22.63	1.84	-19.15	8.00	Complies
6	2437 MHz	-19.11	2.07	-19.33	2.33	-15.94	8.00	Complies
9	2452 MHz	-21.79	1.58	-21.10	2.44	-18.16	8.00	Complies

Note 1: Uncorrelated Directional gain =  $G_{ANT}$  dBi, < 6dBi

$$G_{ANT} = 10 \log[(10^{G1/10} + 10^{G2/10} + \dots + 10^{GN/10}) / N_{ANT}] \text{ dBi}$$

CH3=10 log[(1.742+1.517)/2] + 0= 2.12dBi < 6dBi

CH6=10 log[(1.611+1.710)/2] + 0= 2.20dBi < 6dBi

CH9=10 log[(1.416+1.237)/2] + 0=1.22 dBi < 6dBi

EX:CH6

Total PSD= Ant1+Ant2= -19.11dBm+ -19.33dBm=10 log(0.0123mW+0.0117mW)+ 0.15dB

= -15.94dBm/3kHz

Power Density Plot on Configuration of IEEE 802.11n 40MHz MCS0 / Ant. 2 / 2422 MHz

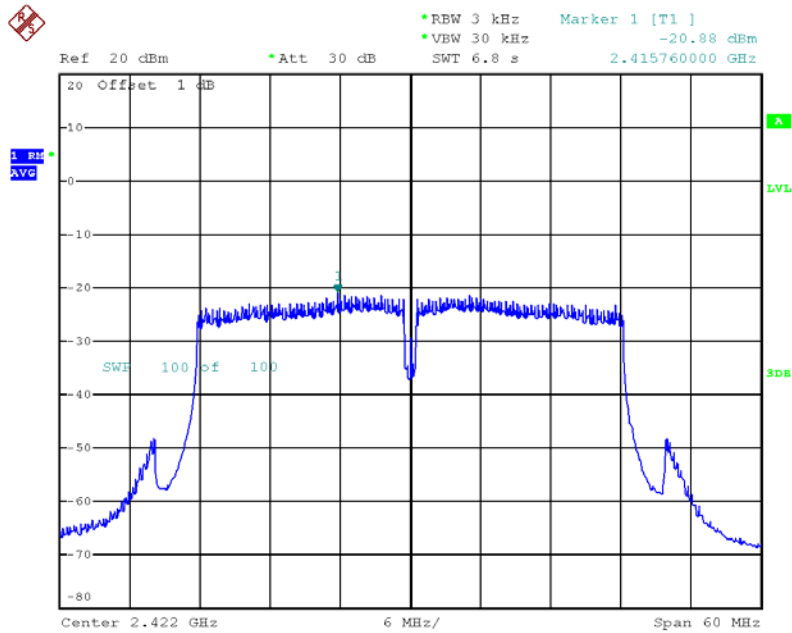

Date: 1.JUL.2013 12:42:50

Power Density Plot on Configuration of IEEE 802.11n 40MHz MCS0 / Ant. 1 / 2437 MHz

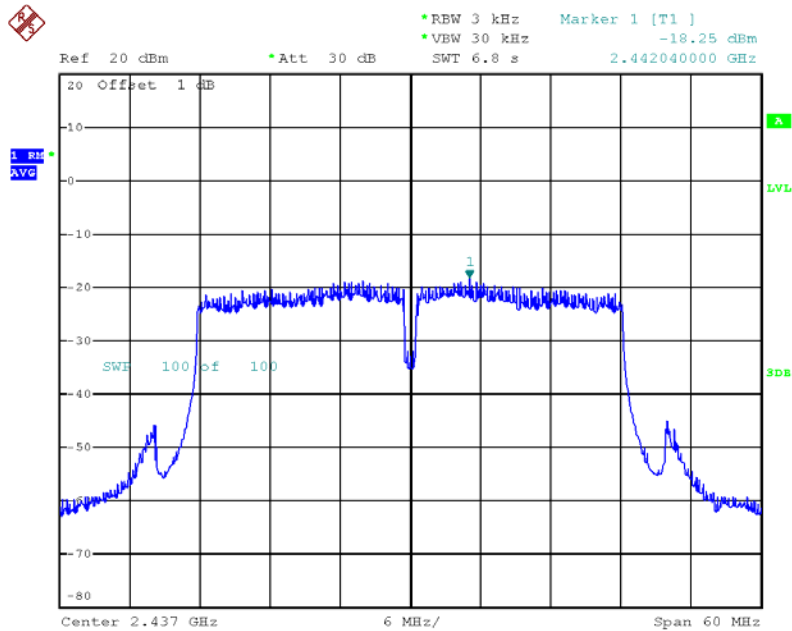

Date: 1.JUL.2013 12:40:54

Power Density Plot on Configuration of IEEE 802.11n 40MHz MCS0 / Ant. 1 / 2452 MHz

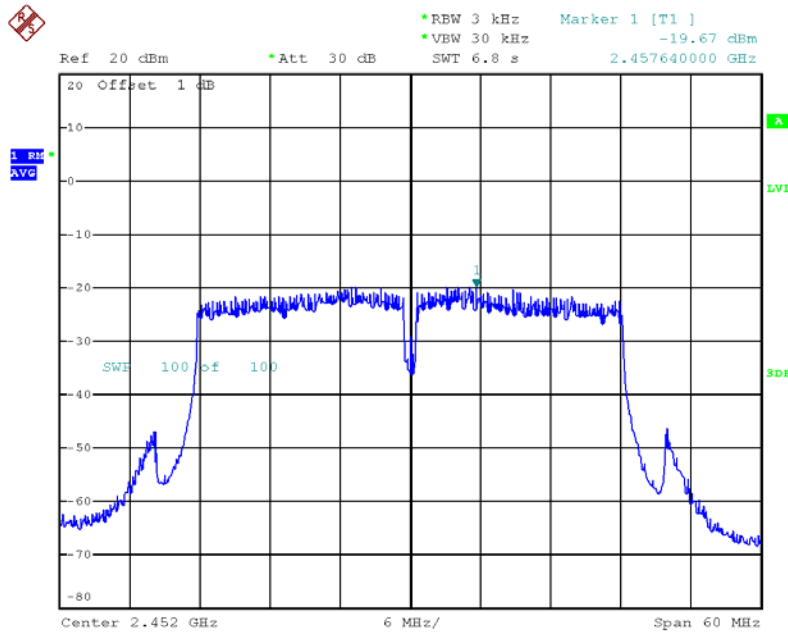

Date: 1.JUL.2013 12:43:38

Power Density Plot on Configuration of IEEE 802.11n 40MHz MCS8 / Ant. 1 / 2422 MHz

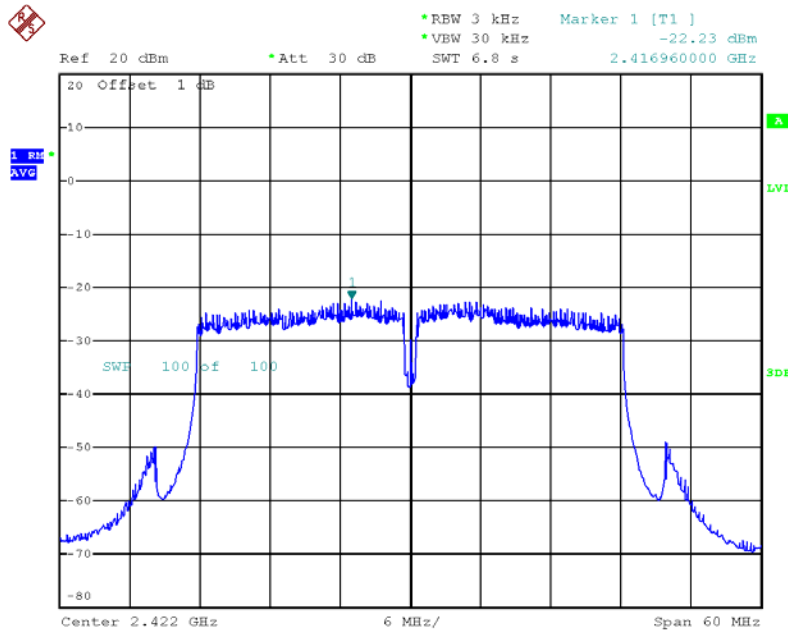

Date: 1.JUL.2013 12:45:51

Power Density Plot on Configuration of IEEE 802.11n 40MHz MCS8 / Ant. 2 / 2422 MHz

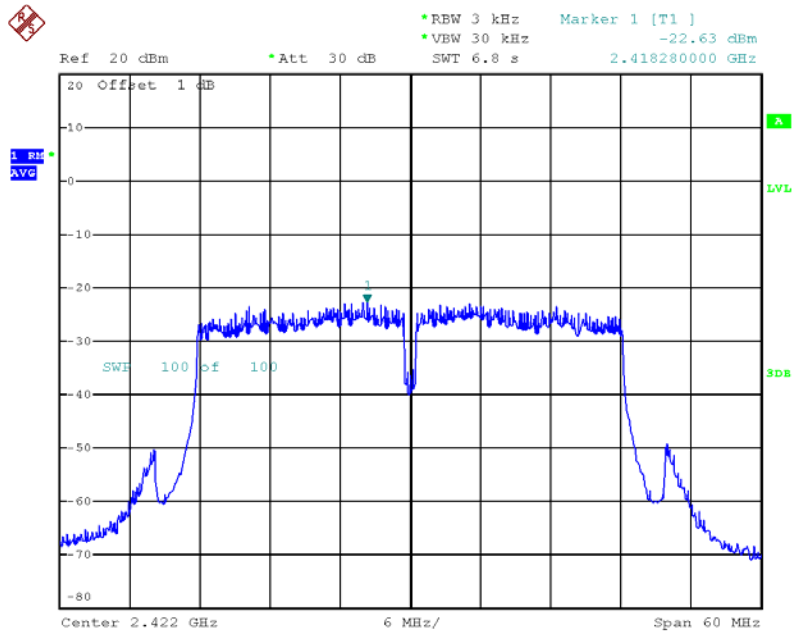

Date: 1.JUL.2013 12:46:23

Power Density Plot on Configuration of IEEE 802.11n 40MHz MCS8 / Ant. 1 / 2437 MHz

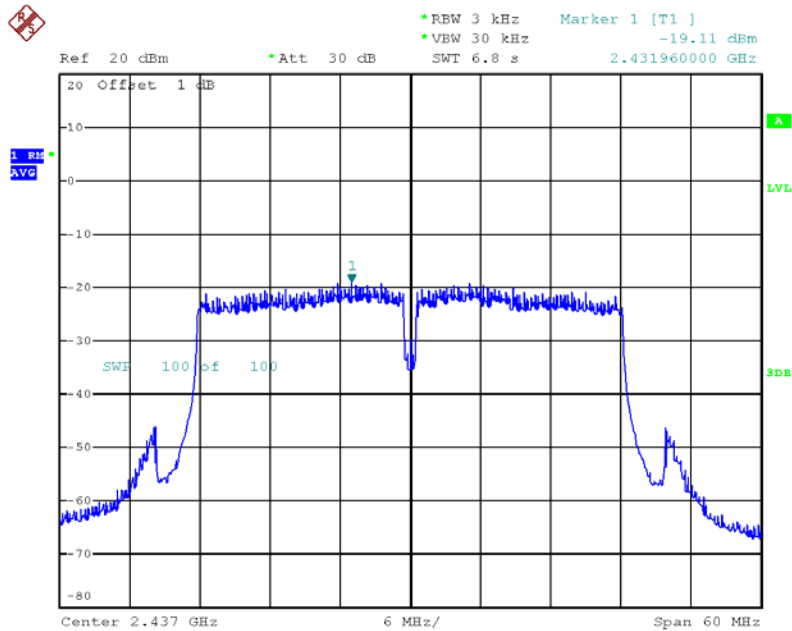

Date: 1.JUL.2013 12:48:43



Power Density Plot on Configuration of IEEE 802.11n 40MHz MCS8 / Ant. 2 / 2437 MHz

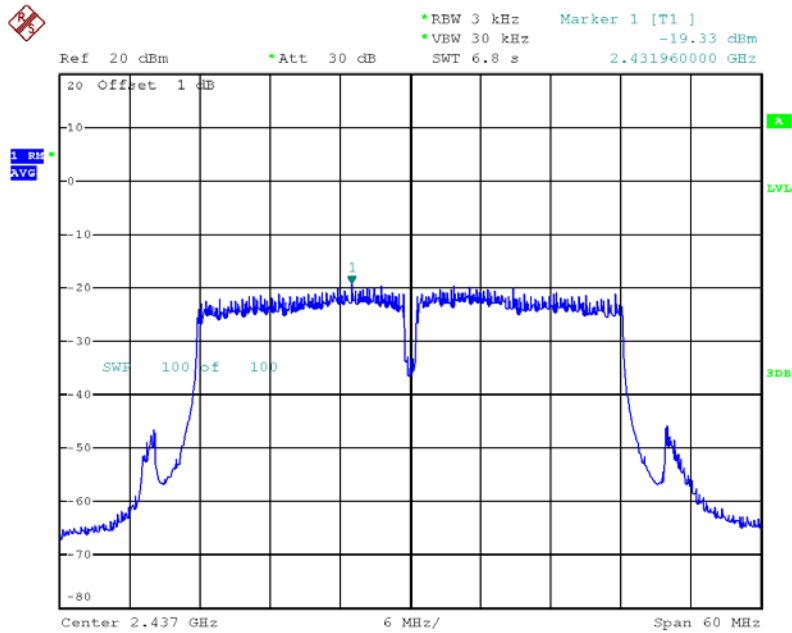

Date: 1.JUL.2013 12:47:22

Power Density Plot on Configuration of IEEE 802.11n 40MHz MCS8 / Ant. 1 / 2452 MHz

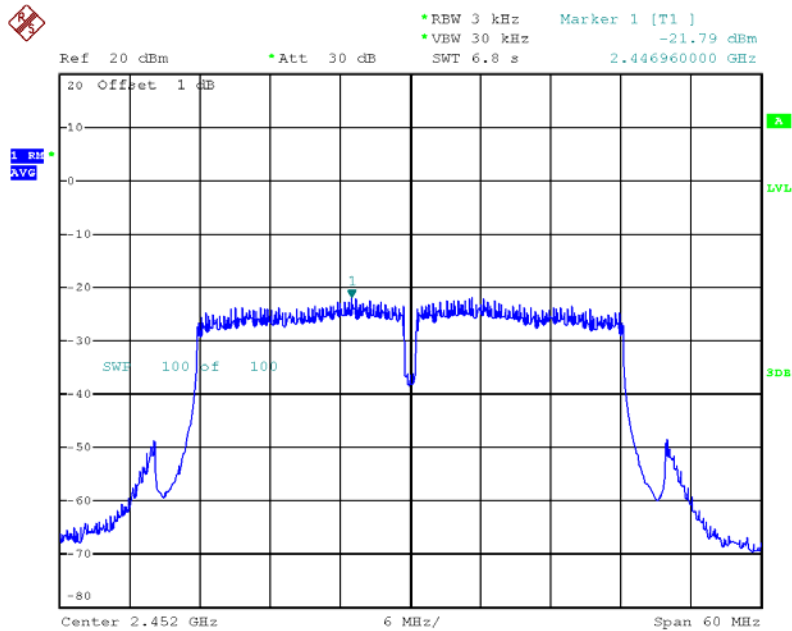

Date: 1.JUL.2013 12:51:36

Power Density Plot on Configuration of IEEE 802.11n 40MHz MCS8 / Ant. 2 / 2452 MHz

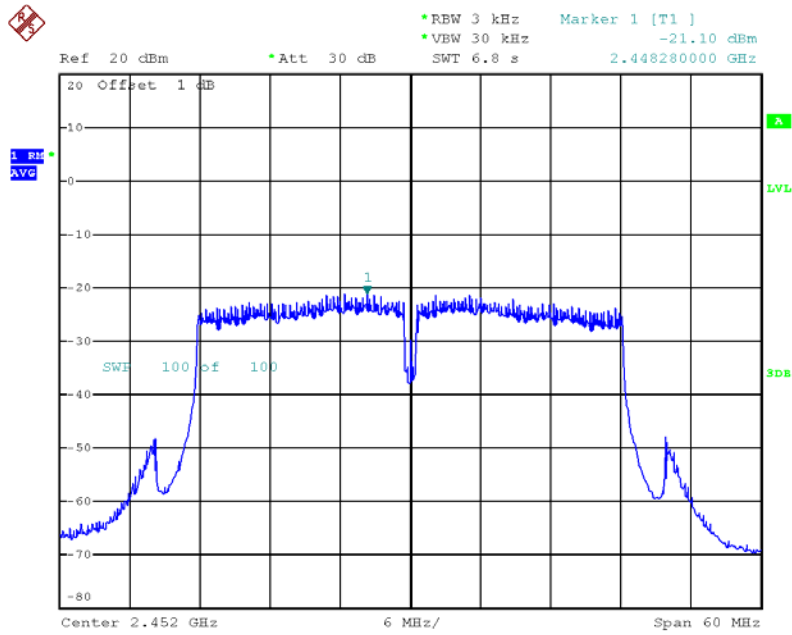

Date: 1.JUL.2013 12:50:38

**3.4 6dB Spectrum Bandwidth Measurement**

**3.4.1 Limit**

For digital modulation systems, the minimum 6dB bandwidth shall be at least 500 kHz.

**3.4.2 Measuring Instruments and Setting**

Please refer to section 4 of equipments list in this report. The following table is the setting of Spectrum Analyzer.

Spectrum Parameters	Setting
Attenuation	Auto
Span Frequency	> 6dB Bandwidth
RBW	100 kHz.
VBW	≥ 3 x RBW
Detector	Peak
Trace	Max Hold
Sweep Time	Auto

**3.4.3 Test Procedures**

1. Test was performed in accordance with Measurement of Digital Transmission Systems Operating under KDB 558074 D01 DTS Meas Guidance v03, 04/08/2013
2. Multiple antennas system was performed in accordance with KDB 662911 D01 v02 Emission Testing of Transmitters with Multiple Outputs in the Same Band
3. The transmitter output (antenna port) was connected to the spectrum analyzer in peak hold mode.
4. Measured the spectrum width with power higher than 6d account by this measurement.

**3.4.4 Test Setup Layout**

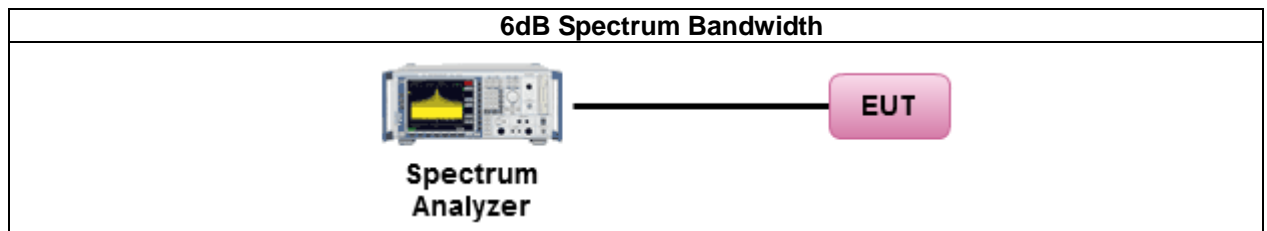

**3.4.5 Test Deviation**

There is no deviation with the original standard.

**3.4.6 EUT Operation during Test**

The EUT was programmed to be in continuously transmitting mode.

3.4.7 Test Result of 6dB Spectrum Bandwidth

Test date	Jun. 13, 2013	Test Site No.	TH01-CB
Temperature	25°C	Humidity	56%
Test Engineer	Denis Su	Configuration	802.11b

Configuration IEEE 802.11b <Worst mode: Ant. 2>

Channel	Frequency	6dB Bandwidth (MHz)	99% Occupied Bandwidth (MHz)	Min. Limit (kHz)	Test Result
1	2412 MHz	8.08	10.16	500	Complies
6	2437 MHz	7.52	10.24	500	Complies
11	2462 MHz	8.08	10.16	500	Complies

6 dB Bandwidth Plot on Configuration IEEE 802.11b / Ant. 2 / 2412 MHz

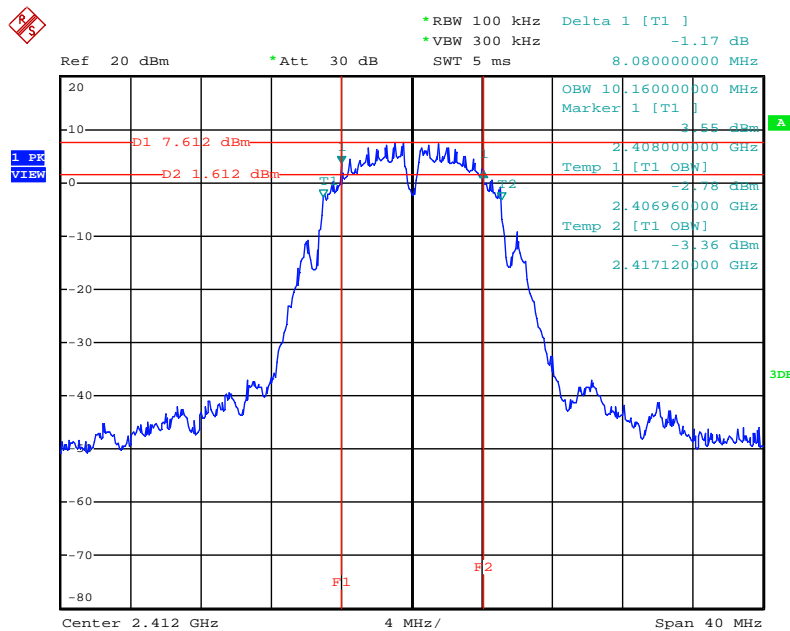

Date: 13.JUN.2013 13:14:23

6 dB Bandwidth Plot on Configuration IEEE 802.11b / Ant. 2 / 2437 MHz

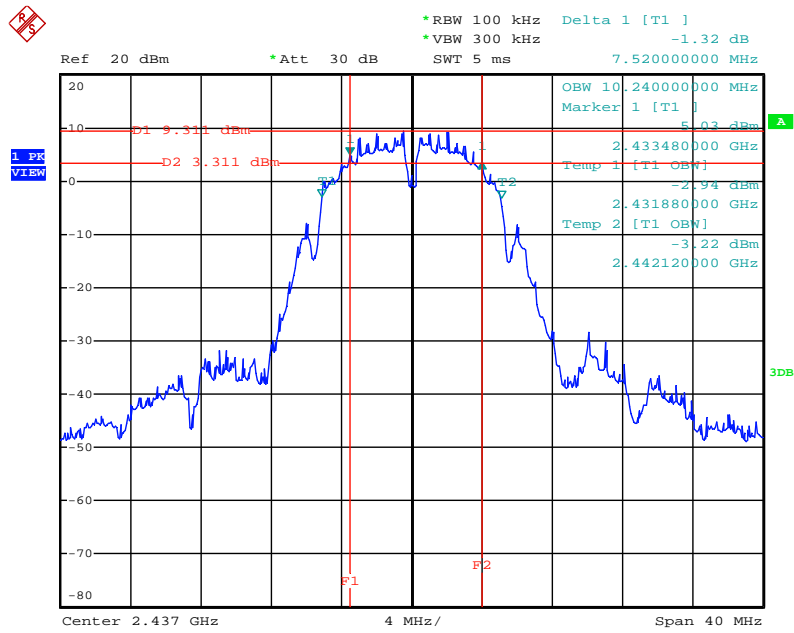

Date: 13.JUN.2013 13:13:24

6 dB Bandwidth Plot on Configuration IEEE 802.11b / Ant. 2 / 2462 MHz

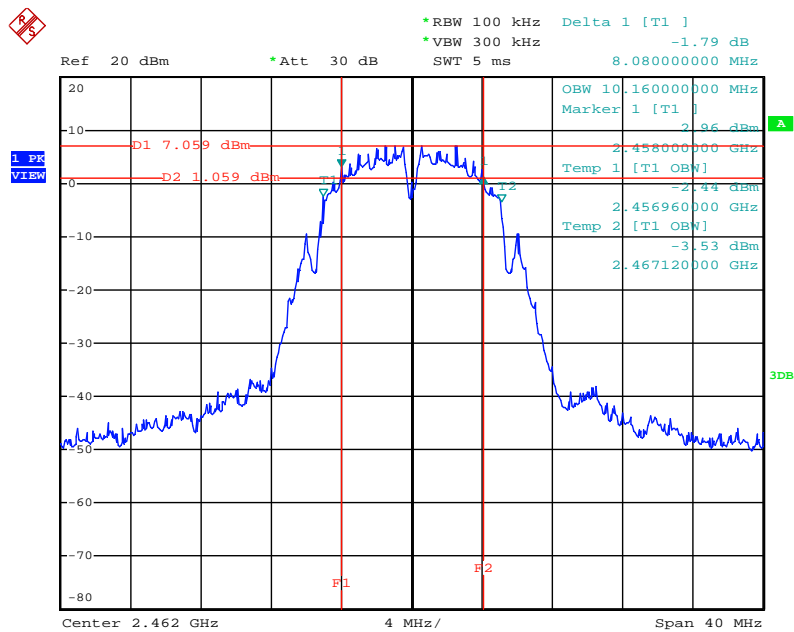

Date: 13.JUN.2013 13:13:53

Test date	Jun. 13, 2013	Test Site No.	TH01-CB
Temperature	25°C	Humidity	56%
Test Engineer	Denis Su	Configuration	802.11g

Configuration IEEE 802.11g <Worst mode: Ant. 1>

Channel	Frequency	6dB Bandwidth (MHz)	99% Occupied Bandwidth (MHz)	Min. Limit (kHz)	Test Result
1	2412 MHz	16.40	16.56	500	Complies
11	2462 MHz	16.40	16.56	500	Complies

Configuration IEEE 802.11g <Worst mode: Ant. 2>

Channel	Frequency	6dB Bandwidth (MHz)	99% Occupied Bandwidth (MHz)	Min. Limit (kHz)	Test Result
6	2437 MHz	16.32	16.64	500	Complies

6 dB Bandwidth Plot on Configuration IEEE 802.11g / Ant. 1 / 2412 MHz

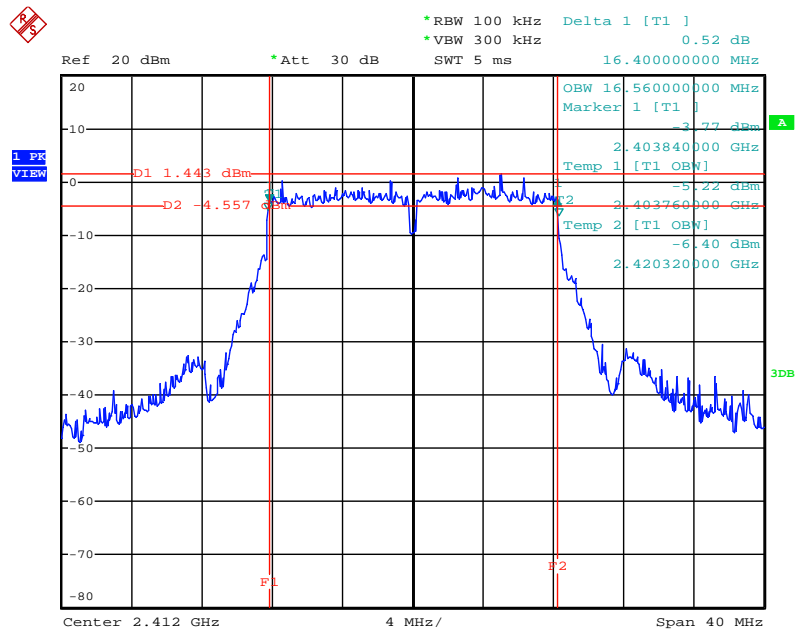

Date: 13.JUN.2013 13:15:36

6 dB Bandwidth Plot on Configuration IEEE 802.11g / Ant. 2 / 2437 MHz

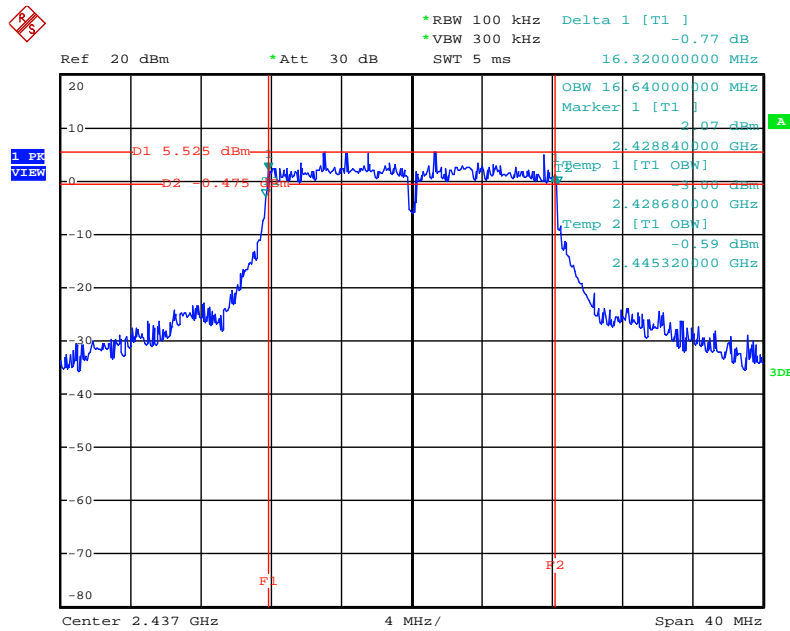

Date: 13.JUN.2013 13:16:45

6 dB Bandwidth Plot on Configuration IEEE 802.11g / Ant. 1 / 2462 MHz

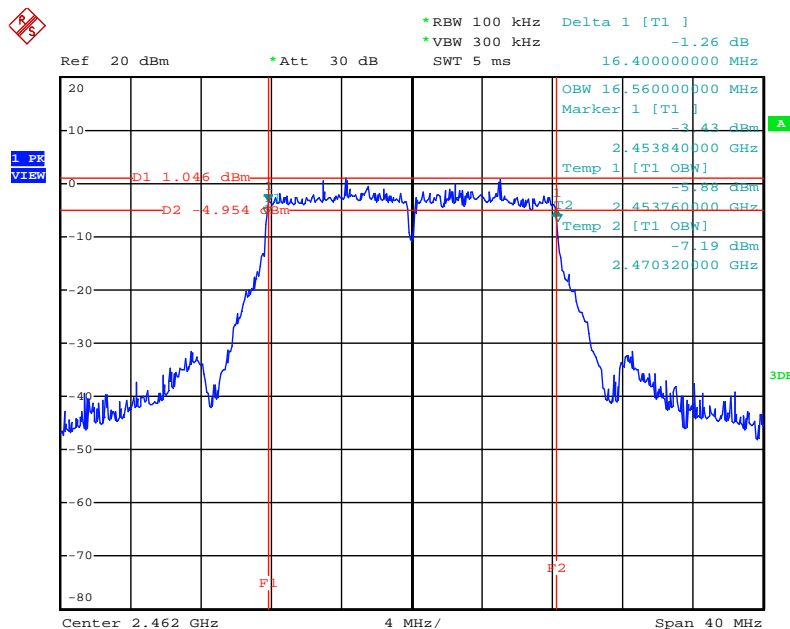

Date: 13.JUN.2013 13:16:14

<b>Test date</b>	Jun. 13, 2013	<b>Test Site No.</b>	TH01-CB
<b>Temperature</b>	25°C	<b>Humidity</b>	56%
<b>Test Engineer</b>	Denis Su	<b>Configuration</b>	802.11n

**Configuration of IEEE 802.11n 20MHz MCS0 <Worst mode: Ant. 1>**

Channel	Frequency	6dB Bandwidth (MHz)	99% Occupied Bandwidth (MHz)	Min. Limit (kHz)	Test Result
1	2412 MHz	17.60	17.68	500	Complies
11	2462 MHz	17.60	17.76	500	Complies

**Configuration of IEEE 802.11n 20MHz MCS0 <Worst mode: Ant. 2>**

Channel	Frequency	6dB Bandwidth (MHz)	99% Occupied Bandwidth (MHz)	Min. Limit (kHz)	Test Result
6	2437 MHz	17.60	17.76	500	Complies

**Configuration of IEEE 802.11n 20MHz MCS8 <SDM mode: Ant. 1 + Ant. 2>**

Channel	Frequency	6dB Bandwidth (MHz)	99% Occupied Bandwidth (MHz)	Min. Limit (kHz)	Test Result
1	2412 MHz	17.60	17.76	500	Complies
6	2437 MHz	16.32	17.76	500	Complies
11	2462 MHz	17.60	17.76	500	Complies



6 dB Bandwidth Plot on Configuration of IEEE 802.11n 20MHz MCS0 / Ant. 1 / 2412 MHz

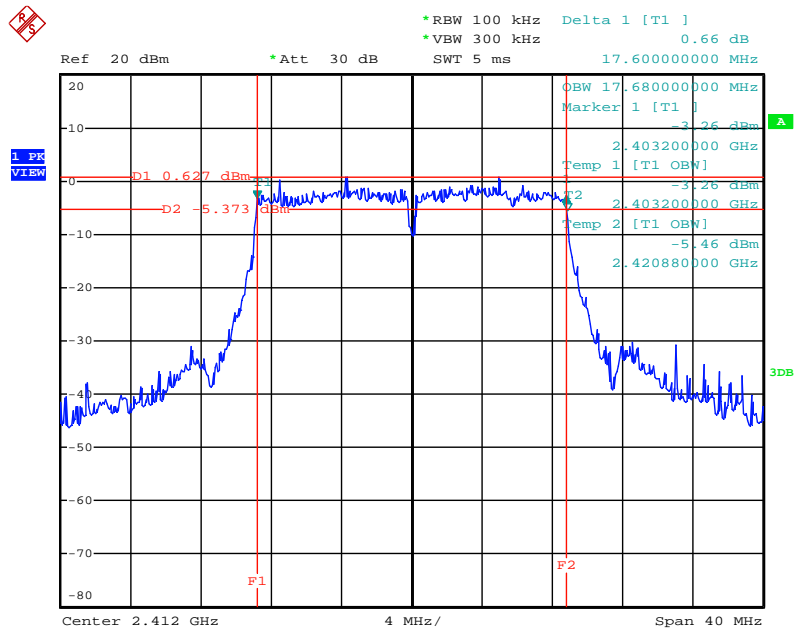

Date: 13.JUN.2013 13:18:17

6 dB Bandwidth Plot on Configuration of IEEE 802.11n 20MHz MCS0 / Ant. 2 / 2437 MHz

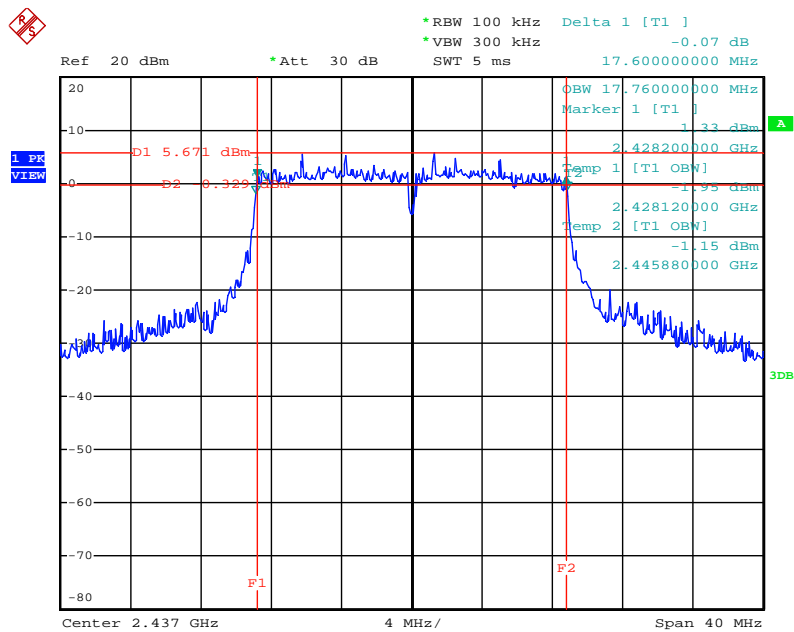

Date: 13.JUN.2013 13:22:13

6 dB Bandwidth Plot on Configuration of IEEE 802.11n 20MHz MCS0 / Ant. 1 / 2462 MHz

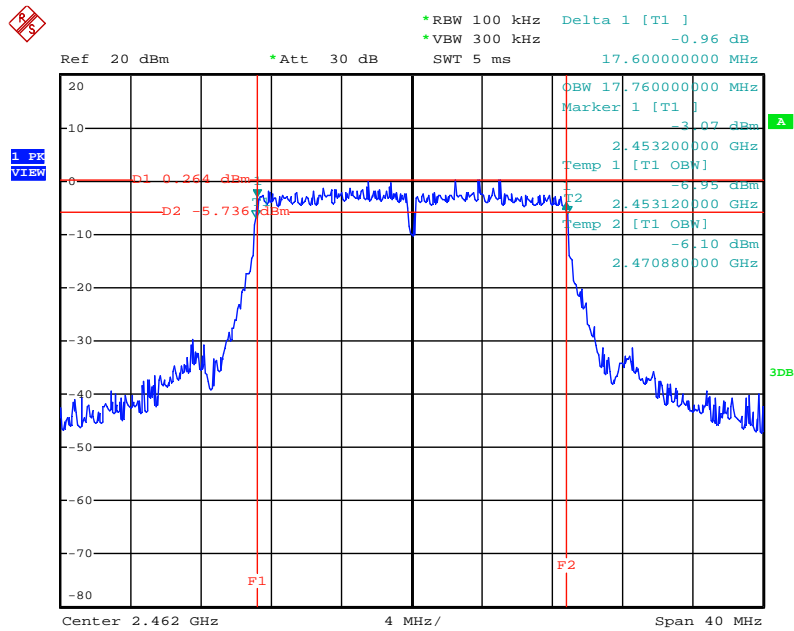

Date: 13.JUN.2013 13:21:32

6 dB Bandwidth Plot on Configuration of IEEE 802.11n 20MHz MCS8 / Ant. 1 + Ant. 2 / 2412 MHz

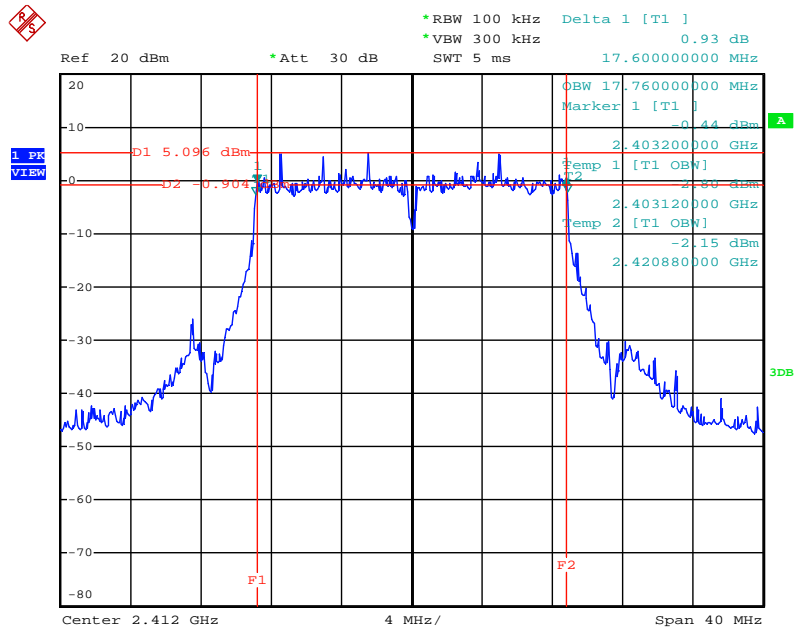

Date: 13.JUN.2013 13:07:59

6 dB Bandwidth Plot on Configuration of IEEE 802.11n 20MHz MCS8 / Ant. 1 + Ant. 2 / 2437 MHz

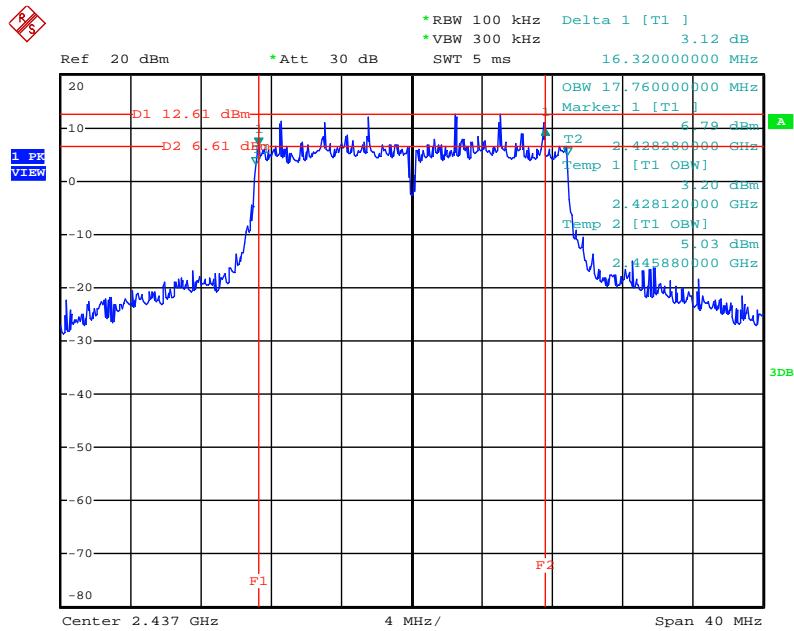

Date: 13.JUN.2013 13:08:31

6 dB Bandwidth Plot on Configuration of IEEE 802.11n 20MHz MCS8 / Ant. 1 + Ant. 2 / 2462 MHz

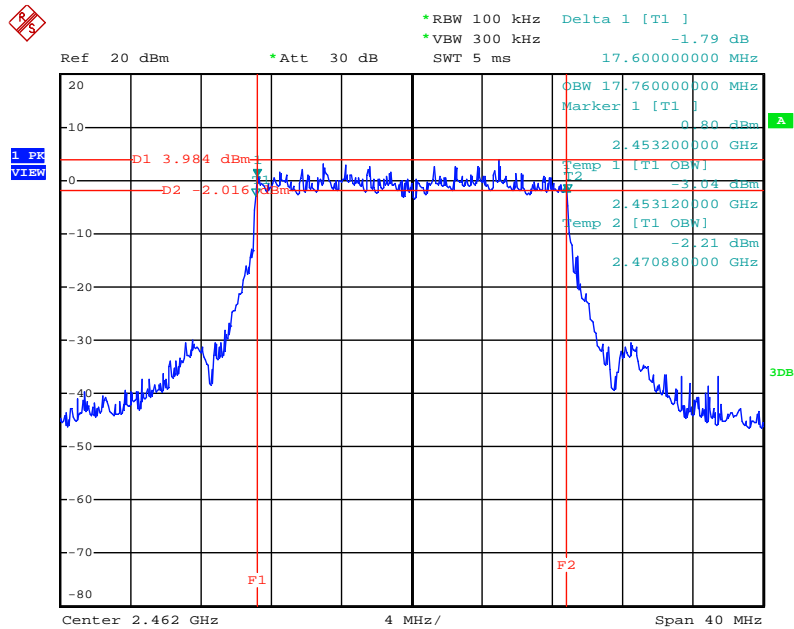

Date: 13.JUN.2013 13:09:06

<b>Test date</b>	Jun. 13, 2013	<b>Test Site No.</b>	TH01-CB
<b>Temperature</b>	25°C	<b>Humidity</b>	56%
<b>Test Engineer</b>	Denis Su	<b>Configuration</b>	802.11n

**Configuration of IEEE 802.11n 40MHz MCS0 <Worst mode: Ant. 1>**

Channel	Frequency	6dB Bandwidth (MHz)	99% Occupied Bandwidth (MHz)	Min. Limit (kHz)	Test Result
6	2437 MHz	34.88	36.16	500	<b>Complies</b>
9	2452 MHz	35.04	36.16	500	<b>Complies</b>

**Configuration of IEEE 802.11n 40MHz MCS0 <Worst mode: Ant. 2>**

Channel	Frequency	6dB Bandwidth (MHz)	99% Occupied Bandwidth (MHz)	Min. Limit (kHz)	Test Result
3	2422 MHz	35.52	36.00	500	<b>Complies</b>

**Configuration of IEEE 802.11n 40MHz MCS8 <SDM mode: Ant. 1 + Ant. 2>**

Channel	Frequency	6dB Bandwidth (MHz)	99% Occupied Bandwidth (MHz)	Min. Limit (kHz)	Test Result
3	2422 MHz	35.20	36.00	500	<b>Complies</b>
6	2437 MHz	35.20	35.84	500	<b>Complies</b>
9	2452 MHz	32.64	35.84	500	<b>Complies</b>

6 dB Bandwidth Plot on Configuration of IEEE 802.11n 40MHz MCS0 / Ant. 2 / 2422 MHz

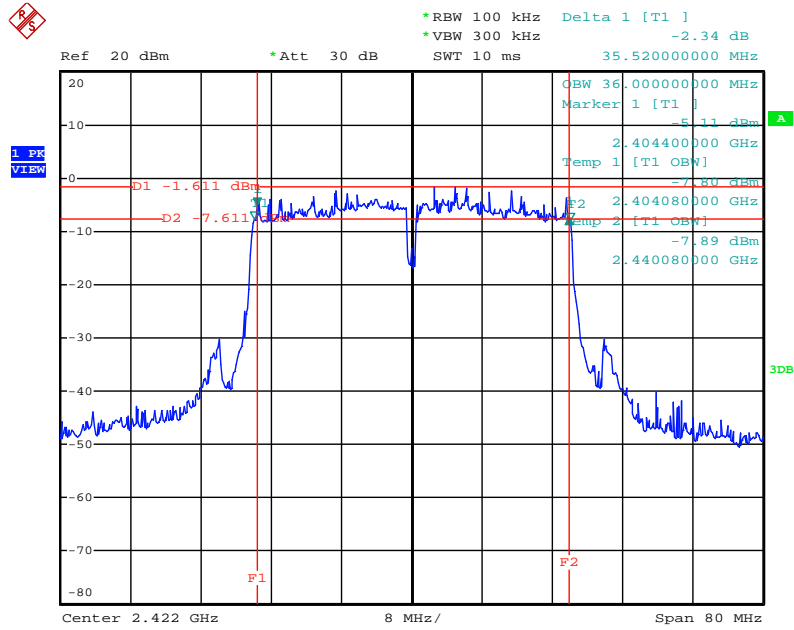

Date: 13.JUN.2013 13:24:02

6 dB Bandwidth Plot on Configuration of IEEE 802.11n 40MHz MCS0 / Ant. 1 / 2437 MHz

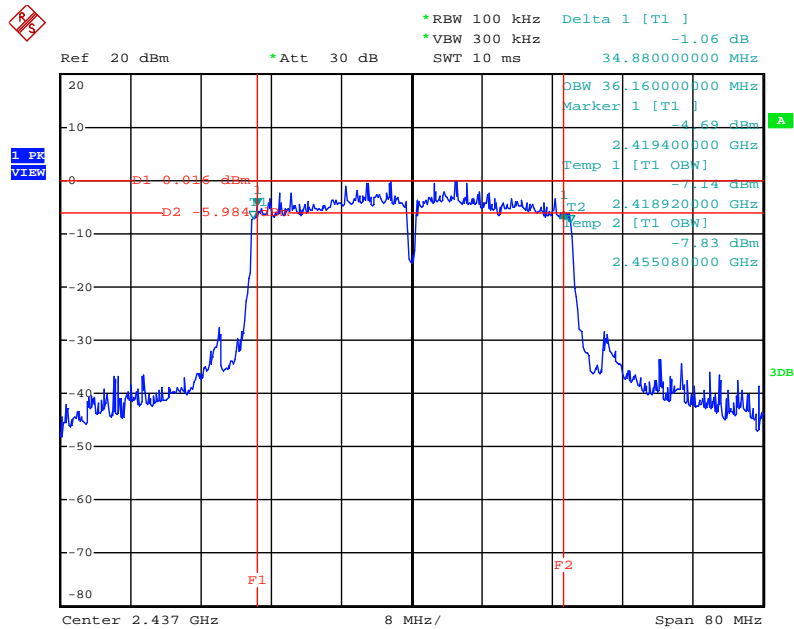

Date: 13.JUN.2013 13:24:53

6 dB Bandwidth Plot on Configuration of IEEE 802.11n 40MHz MCS0 / Ant. 1 / 2452 MHz

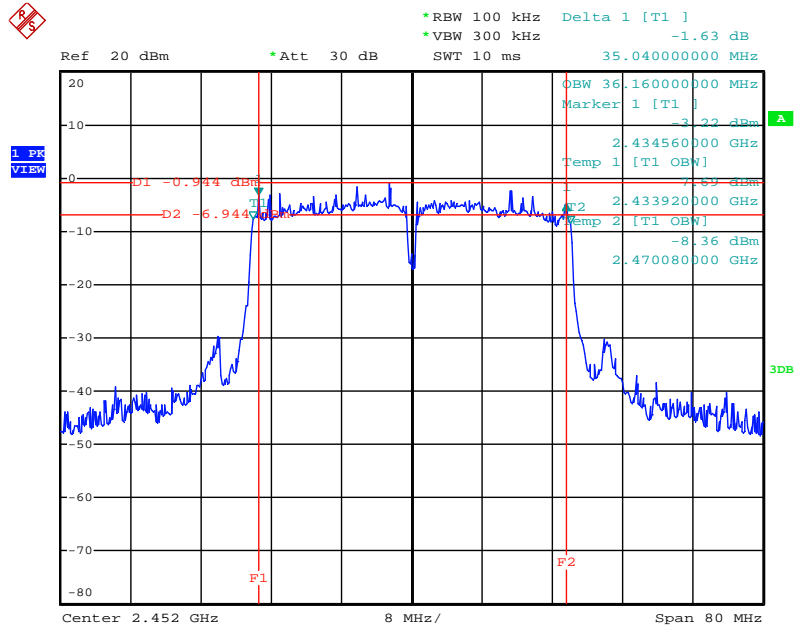

Date: 13.JUN.2013 13:25:16

6 dB Bandwidth Plot on Configuration of IEEE 802.11n 40MHz MCS8 / Ant. 1 + Ant. 2 / 2422 MHz

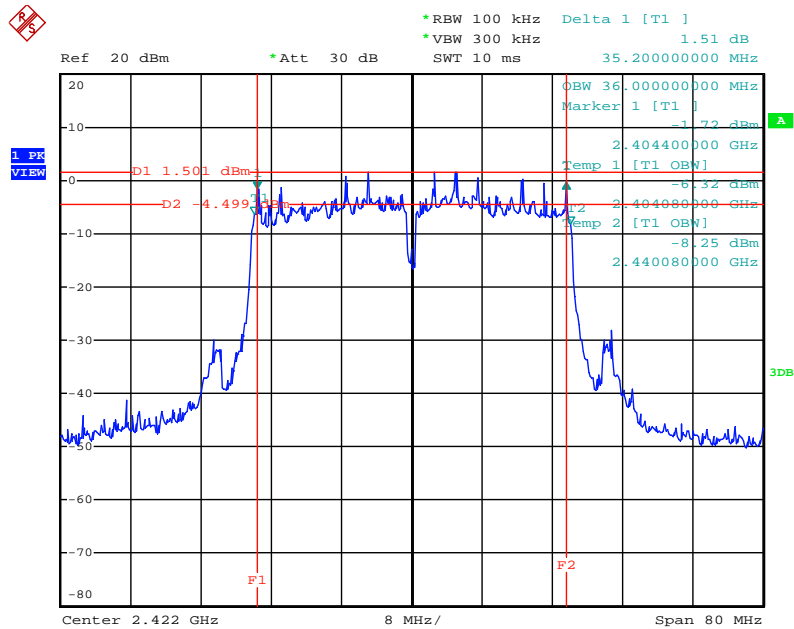

Date: 13.JUN.2013 13:10:00

6 dB Bandwidth Plot on Configuration of IEEE 802.11n 40MHz MCS8 / Ant. 1 + Ant. 2 / 2437 MHz

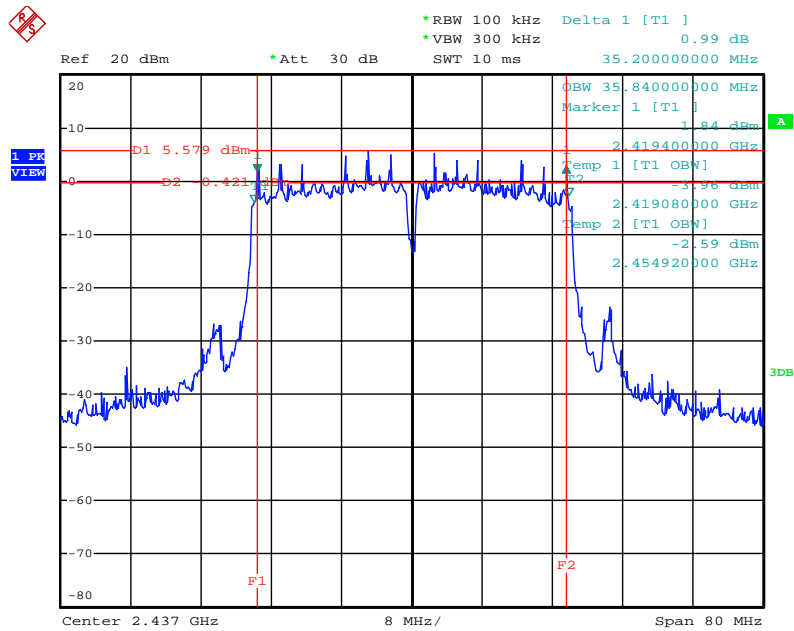

Date: 13.JUN.2013 13:11:00

6 dB Bandwidth Plot on Configuration of IEEE 802.11n 40MHz MCS8 / Ant. 1 + Ant. 2 / 2452 MHz

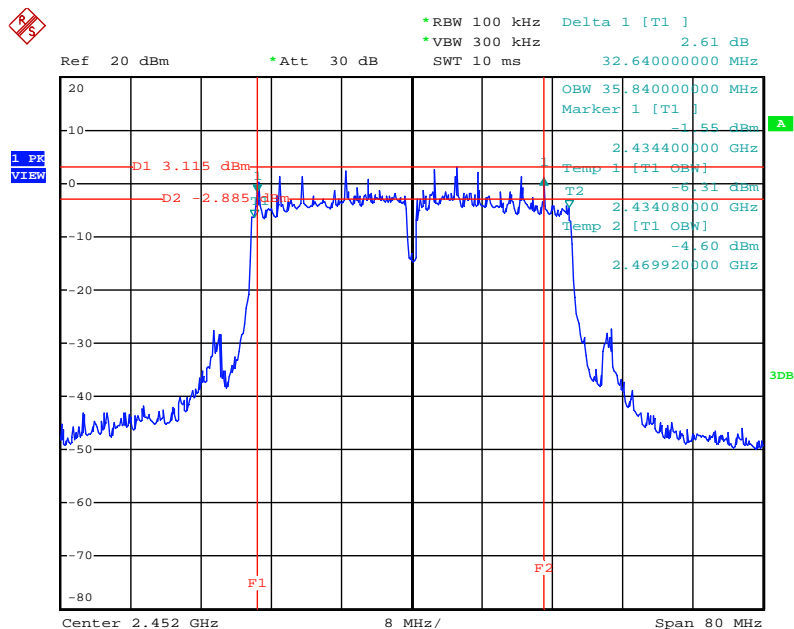

Date: 13.JUN.2013 13:11:46

**3.5 Radiated Emissions Measurement**

**3.5.1 Limit**

30dBc in any 100 kHz bandwidth outside the operating frequency band. In case the emission fall within the restricted band specified on 15.205(a), then the 15.209(a) limit in the table below has to be followed..

<b>Frequencies (MHz)</b>	<b>Field Strength (microvolt/meter)</b>	<b>Measurement Distance (meters)</b>
0.009~0.490	2400/F(KHz)	300
0.490~1.705	24000/F(KHz)	30
1.705~30.0	30	30
30~88	100	3
88~216	150	3
216~960	200	3
Above 960	500	3

**3.5.2 Measuring Instruments and Setting**

Please refer to section 5 of equipments list in this report. The following table is the setting of spectrum analyzer and receiver.

<b>Spectrum Parameter</b>	<b>Setting</b>
Attenuation	Auto
Start Frequency	1GHz
Stop Frequency	10th carrier harmonic
RBW / VBW (Emission in restricted band)	1MHz / 3MHz for Peak, 1MHz / 10Hz for Average
RBW / VBW (Emission in non-restricted band)	100kHz / 300kHz for peak

<b>Receiver Parameter</b>	<b>Setting</b>
Attenuation	Auto
Start ~ Stop Frequency	9kHz~150kHz / RBW 200Hz for QP
Start ~ Stop Frequency	150kHz~30MHz / RBW 9kHz for QP
Start ~ Stop Frequency	30MHz~1GHz / RBW 120kHz for QP



**3.5.3 Test Procedures**

1. Test was performed in accordance with Measurement of Digital Transmission Systems Operating under KDB 558074 D01 DTS Meas Guidance v03, 04/08/2013
2. Multiple antennas system was performed in accordance with KDB 662911 D02 v02 Emission Testing of Transmitters with Multiple Outputs in the Same Band, The worst case directional gain will occur when  $N_{SS} = 1$ ; therefore, it is especially important to ensure that the device complies with all emission limits for the case of  $N_{SS} = 1$ , (or with the lowest possible value of  $N_{SS} = 1$ , if the device always uses spatial multiplexing). The application filing must clearly include a proper justification for the lowest value  $N_{SS}$  used.
3. Configure the EUT according to ANSI C63.10. The EUT was placed on the top of the turntable 0.8 meter above ground. The phase center of the receiving antenna mounted on the top of a height-variable antenna tower was placed 3 meters far away from the turntable.
4. Power on the EUT and all the supporting units. The turntable was rotated by 360 degrees to determine the position of the highest radiation.
5. The height of the broadband receiving antenna was varied between one meter and four meters above ground to find the maximum emissions field strength of both horizontal and vertical polarization.
6. For each suspected emissions, the antenna tower was scan (from 1 m to 4 m) and then the turntable was rotated (from 0 degree to 360 degrees) to find the maximum reading.
7. Set the test-receiver system to Peak or CISPR quasi-peak Detect Function with specified bandwidth under Maximum Hold Mode.
8. For emissions above 1GHz, use 1MHz VBW and 3MHz RBW for peak reading. Then 1MHz RBW and 10Hz VBW for average reading in spectrum analyzer.
9. When the radiated emissions limits are expressed in terms of the average value of the emissions, and pulsed operation is employed, the measurement field strength shall be determined by averaging over one complete pulse train, including blanking intervals, as long as the pulse train does not exceed 0.1 seconds. As an alternative (provided the transmitter operates for longer than 0.1 seconds) or in cases where the pulse train exceeds 0.1 seconds, the measured field strength shall be determined from the average absolute voltage during a 0.1 second interval during which the field strength is at its maximum value.
10. If the emissions level of the EUT in peak mode was 3 dB lower than the average limit specified, then testing will be stopped and peak values of EUT will be reported, otherwise, the emissions which do not have 3 dB margin will be repeated one by one using the quasi-peak method for below 1GHz.
11. For testing above 1GHz, the emissions level of the EUT in peak mode was lower than average limit (that means the emissions level in peak mode also complies with the limit in average mode), then testing will be stopped and peak values of EUT will be reported, otherwise, the emissions will be measured in average mode again and reported.
12. In case the emission is lower than 30MHz, loop antenna has to be used for measurement and the recorded data should be QP measured by receiver. High – Low scan is not required in this case.

3.5.4 Test Setup Layout

For Radiated Emissions below 1GHz (9kHz~30MHz)

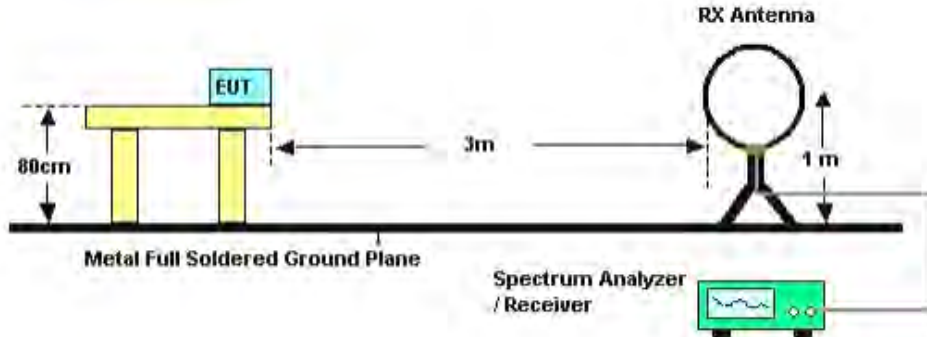

For Radiated Emissions below 1GHz (30MHz~1GHz)

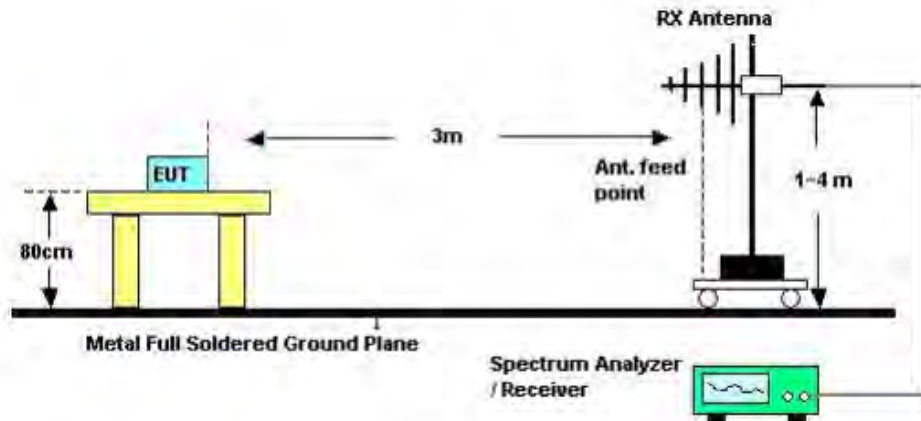

For Radiated Emissions above 1GHz

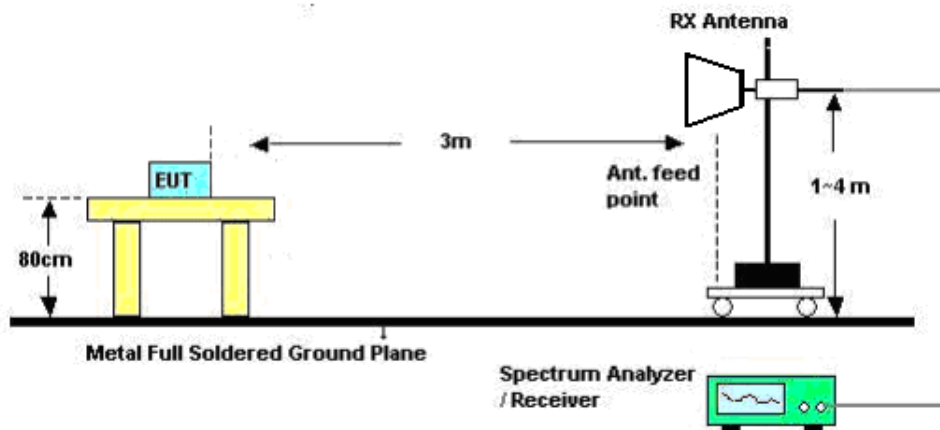

3.5.5 Test Deviation

There are no deviations with the original standard.

**3.5.6 EUT Operation during Test**

The EUT was programmed to be in continuously transmitting mode.

**3.5.7 Results of Radiated Emissions (9kHz~30MHz)**

<b>Frequency Range</b>	9kHz~30MHz	<b>Test Site No.</b>	03CH01-CB
<b>Temperature</b>	25.6°C	<b>Humidity</b>	56%
<b>Test Engineer</b>	Jim Huang	<b>Configurations</b>	CTX
<b>Test Date</b>	Jun. 20, 2013		

<b>Freq. (MHz)</b>	<b>Level (dBuV)</b>	<b>Over Limit (dB)</b>	<b>Limit Line (dBuV)</b>	<b>Remark</b>
-	-	-	-	See Note

**Note:**

The amplitude of spurious emissions that are attenuated by more than 20 dB below the permissible value has no need to be reported.

Distance extrapolation factor = 40 log (specific distance / test distance) (dB);

Limit line = specific limits (dBuV) + distance extrapolation factor.

3.5.8 Results of Radiated Emissions (30MHz~1GHz)

Frequency Range	30MHz~1GHz	Test Site No.	03CH01-CB
Temperature	25.6°C	Humidity	56%
Test Engineer	Jim Huang	Configurations	CTX

Horizontal

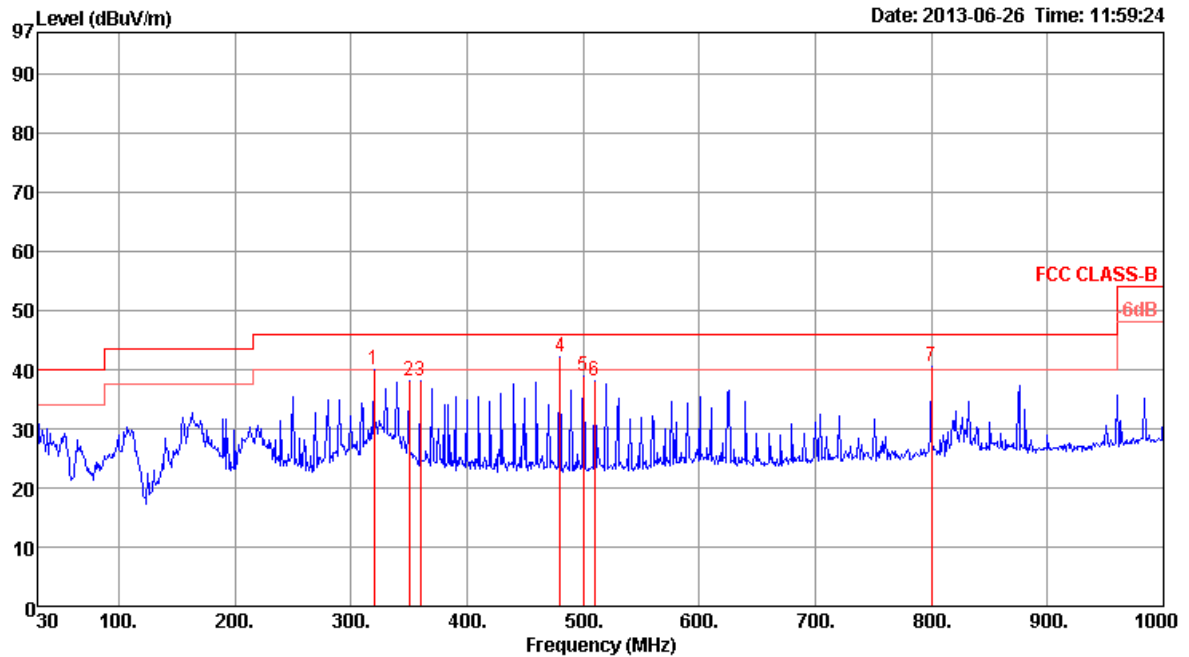

	Freq	Level	Limit Line	Over Limit	Read Level	Cable Loss	Antenna Factor	Preamp Factor	Remark	A/Pos	T/Pos	Pol/Phase
	MHz	dBuV/m	dBuV/m	dB	dBuV	dB	dB/m	dB		cm	deg	
1	320.03	40.12	46.00	-5.88	51.18	2.06	13.91	27.03	Peak	100	0	HORIZONTAL
2	350.10	38.18	46.00	-7.82	48.61	2.10	14.72	27.25	Peak	100	0	HORIZONTAL
3	359.80	38.09	46.00	-7.91	48.28	2.14	14.99	27.32	Peak	100	0	HORIZONTAL
4	480.08	42.12	46.00	-3.88	50.22	2.59	17.31	28.00	Peak	100	0	HORIZONTAL
5	500.45	38.82	46.00	-7.18	46.62	2.67	17.63	28.10	Peak	100	0	HORIZONTAL
6	510.15	38.21	46.00	-7.79	45.88	2.69	17.74	28.10	Peak	100	0	HORIZONTAL
7	800.18	40.56	46.00	-5.44	45.17	3.22	19.77	27.60	Peak	100	0	HORIZONTAL

Note:

The amplitude of spurious emissions which are attenuated by more than 20 dB below the permissible value has no need to be reported.

Emission level (dBuV/m) = 20 log Emission level (uV/m).

Corrected Reading: Antenna Factor + Cable Loss + Read Level - Preamp Factor = Level.

Vertical

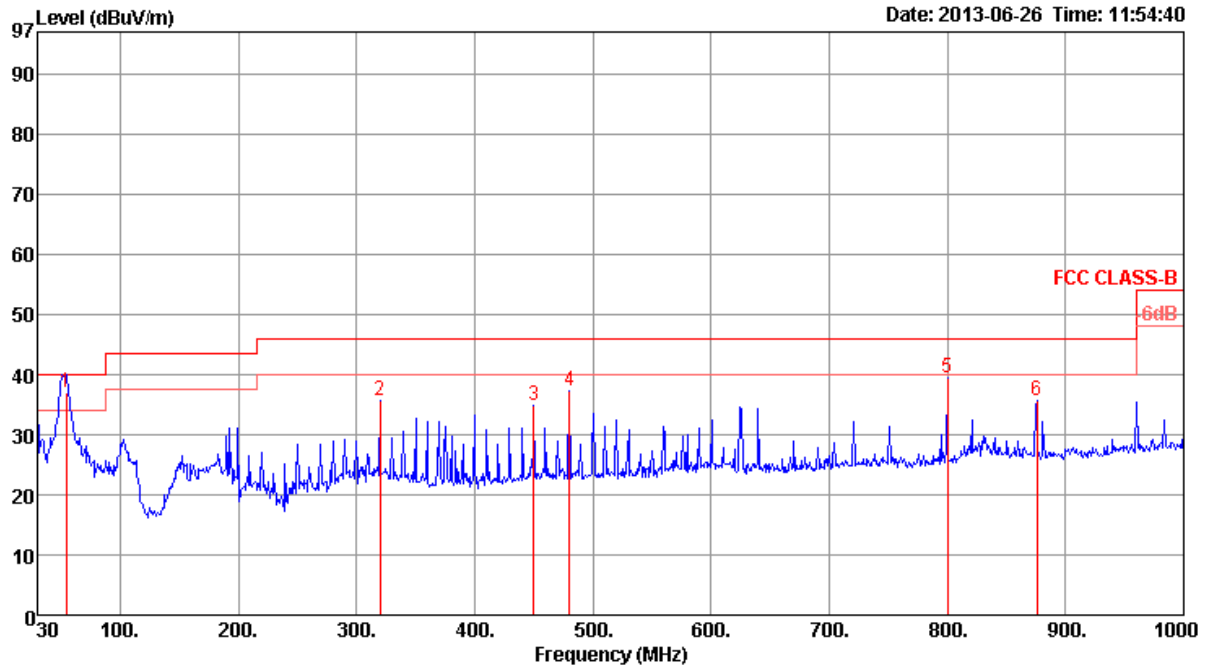

	Freq	Level	Limit	Over	Read	Cable	Antenna	Preamp	Remark	A/Pos	T/Pos	Pol/Phase
	MHz	dBuV/m	dBuV/m	dB	dBuV	dB	dB/m	dB		cm	deg	
1	54.25	36.98	40.00	-3.02	56.08	0.85	7.83	27.78	QP	100	144	VERTICAL
2	320.03	35.69	46.00	-10.31	46.75	2.06	13.91	27.03	Peak	400	0	VERTICAL
3	450.01	34.94	46.00	-11.06	43.48	2.47	16.84	27.85	Peak	400	0	VERTICAL
4	480.08	37.17	46.00	-8.83	45.27	2.59	17.31	28.00	Peak	400	0	VERTICAL
5	800.18	39.37	46.00	-6.63	43.98	3.22	19.77	27.60	Peak	400	0	VERTICAL
6	875.84	35.59	46.00	-10.41	39.23	3.46	20.35	27.45	Peak	400	0	VERTICAL

Note:

The amplitude of spurious emissions which are attenuated by more than 20 dB below the permissible value has no need to be reported.

Emission level (dBuV/m) = 20 log Emission level (uV/m).

Corrected Reading: Antenna Factor + Cable Loss + Read Level - Preamp Factor = Level.

**3.5.9 Results for Radiated Emissions (1GHz~10<sup>th</sup> Harmonic)**

Following channel(s) was (were) selected for the final test as listed below.

<b>MODE</b>	<b>TX Chain</b>	<b>TESTED CHANNEL</b>	<b>MODULATION TECHNOLOGY</b>	<b>MODULATION TYPE</b>	<b>DATA RATE (Mbps)</b>
802.11b	Ant.1	1, 6, 11	DSSS	DBPSK	1
802.11b	Ant.2	1, 6, 11	DSSS	DBPSK	1
802.11g	Ant.1	1, 6, 11	OFDM	BPSK	6
802.11g	Ant.2	1, 6, 11	OFDM	BPSK	6
802.11n 20MHz	Ant.1	1, 6, 11	OFDM	BPSK	MCS0 (6.5)
802.11n 20MHz	Ant.2	1, 6, 11	OFDM	BPSK	MCS0 (6.5)
802.11n 20MHz	Ant.1+2 (SDM)	1, 6, 11	OFDM	BPSK	MCS8 (13)
802.11n 40MHz	Ant.1	3, 6, 9	OFDM	BPSK	MCS0 (13)
802.11n 40MHz	Ant.2	3, 6, 9	OFDM	BPSK	MCS0 (13)
802.11n 40MHz	Ant.1+2 (SDM)	3, 6, 9	OFDM	BPSK	MCS8 (27)

Transmitter Radiated Emissions (1GHz~10th Harmonic)					
Operating Mode	IEEE 802.11b CH 1 / Ant. 1			Polarization	H
Temperature	25.6°C	Humidity	56%	Test Engineer	Jim Huang

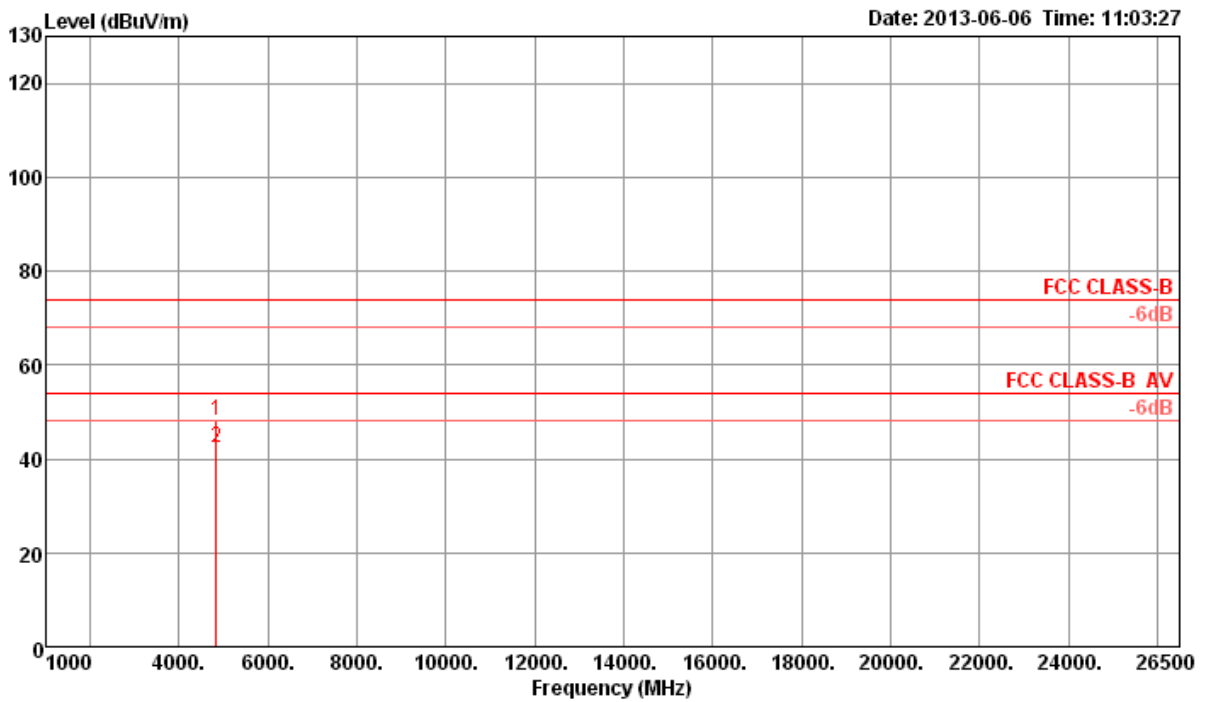

	Freq	Level	Limit	Over	Read	Cable	Antenna	Preamp	Remark	A/Pos	T/Pos	Pol/Phase
	MHz	dBuV/m	dBuV/m	dB	dBuV	dB	dB/m	dB		cm	deg	
1	4823.94	48.24	74.00	-25.76	46.90	3.31	33.06	35.03	Peak	101	302	HORIZONTAL
2	4824.00	42.23	54.00	-11.77	40.89	3.31	33.06	35.03	Average	101	302	HORIZONTAL

Note 1: The amplitude of spurious emissions which are attenuated by more than 20 dB below the permissible value has no need to be reported.  
 Note 2: Emission level (dBuV/m) = 20 log Emission level (uV/m).  
 Note 3: Corrected Reading: Antenna Factor + Cable Loss + Read Level - Preamp Factor = Level.  
 Note 4: Measurement receive antenna polarization: H (Horizontal), V (Vertical)

Transmitter Radiated Emissions (1GHz~10th Harmonic)					
Operating Mode	IEEE 802.11b CH 1 / Ant. 1			Polarization	V
Temperature	25.6°C	Humidity	56%	Test Engineer	Jim Huang

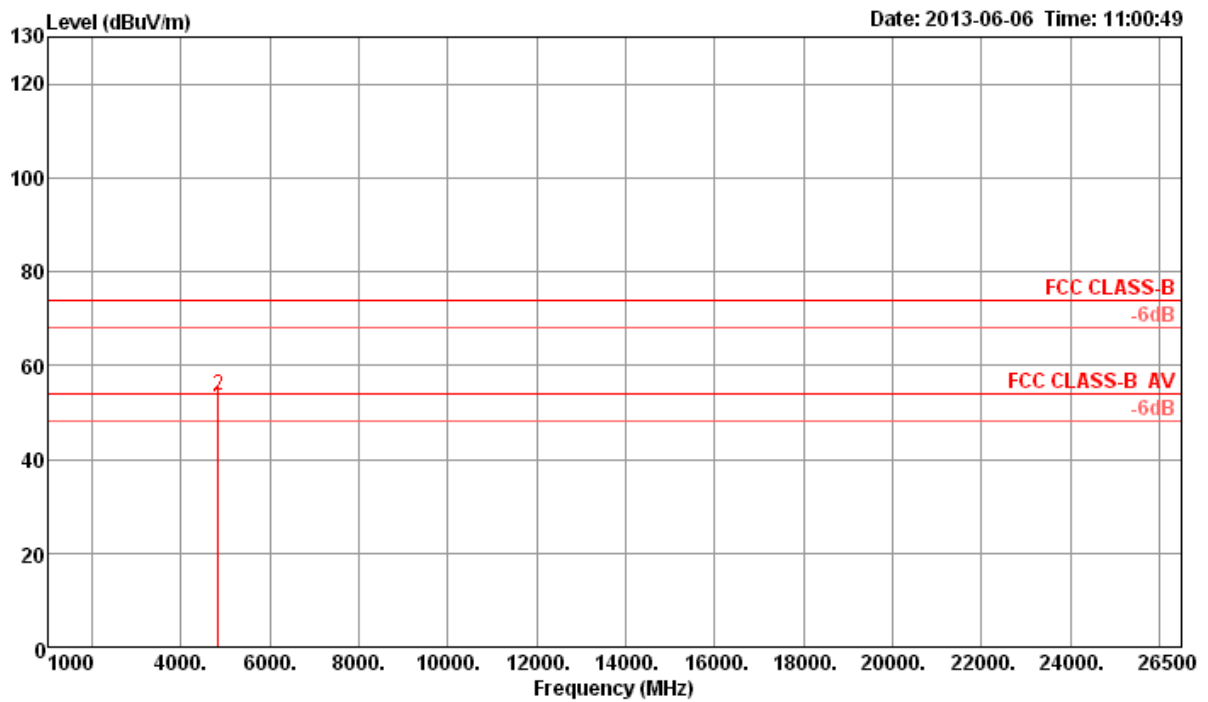

	Freq	Level	Limit	Over	Read	Cable	Antenna	Preamp	Remark	A/Pos	T/Pos	Pol/Phase
	MHz	dBuV/m	dBuV/m	dB	dBuV	dB	dB/m	dB		cm	deg	
1	4823.99	51.17	54.00	-2.83	49.83	3.31	33.06	35.03	Average	164	84	VERTICAL
2	4824.00	53.56	74.00	-20.44	52.22	3.31	33.06	35.03	Peak	164	84	VERTICAL

Note 1: The amplitude of spurious emissions which are attenuated by more than 20 dB below the permissible value has no need to be reported.

Note 2: Emission level (dBuV/m) = 20 log Emission level (uV/m).

Note 3: Corrected Reading: Antenna Factor + Cable Loss + Read Level - Preamp Factor = Level.

Note 4: Measurement receive antenna polarization: H (Horizontal), V (Vertical)



Transmitter Radiated Emissions (1GHz~10th Harmonic)					
Operating Mode	IEEE 802.11b CH 6 / Ant. 1			Polarization	H
Temperature	25.6°C	Humidity	56%	Test Engineer	Jim Huang

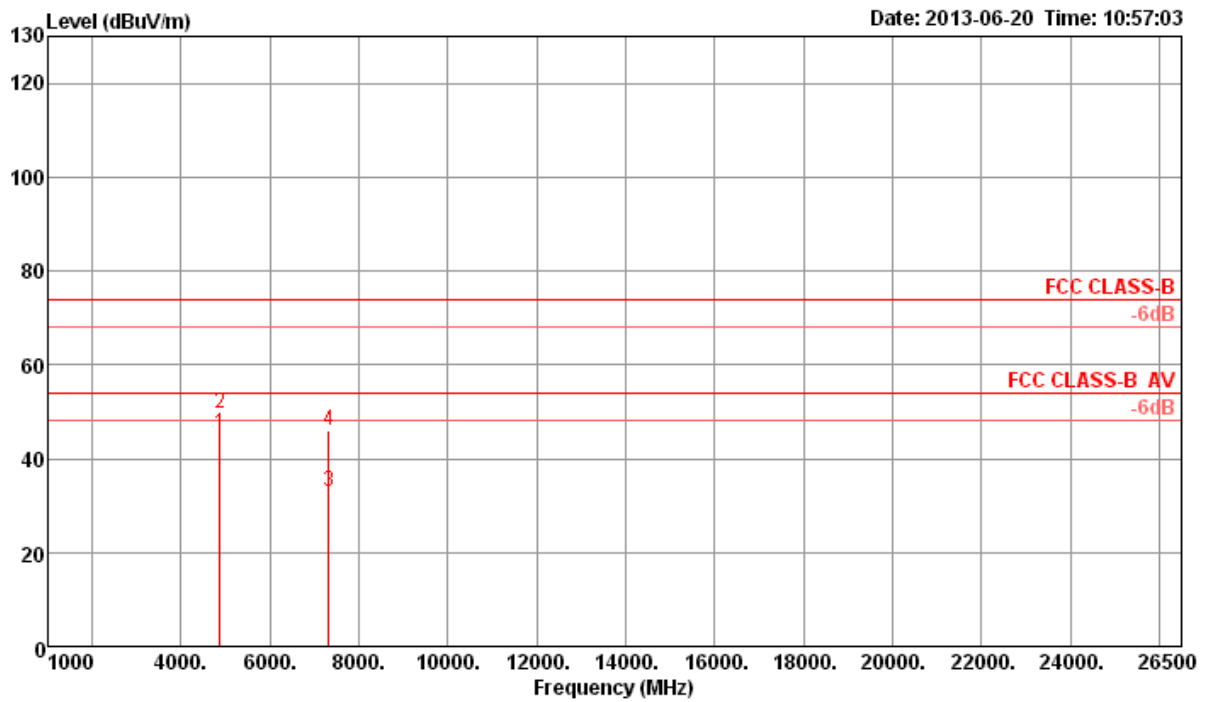

	Freq	Level	Limit	Over	Read	Cable	Antenna	Preamp	Remark	A/Pos	T/Pos	Pol/Phase
	MHz	dBuV/m	dBuV/m	dB	dBuV	dB	dB/m	dB		cm	deg	
1	4873.99	45.13	54.00	-8.87	43.67	3.33	33.16	35.03	Average	212	19	HORIZONTAL
2	4874.02	49.52	74.00	-24.48	48.06	3.33	33.16	35.03	Peak	212	19	HORIZONTAL
3	7309.38	33.12	54.00	-20.88	28.50	4.06	35.96	35.40	Average	100	233	HORIZONTAL
4	7313.21	45.90	74.00	-28.10	41.28	4.06	35.96	35.40	Peak	100	233	HORIZONTAL

Note 1: The amplitude of spurious emissions which are attenuated by more than 20 dB below the permissible value has no need to be reported.

Note 2: Emission level (dBuV/m) = 20 log Emission level (uV/m).

Note 3: Corrected Reading: Antenna Factor + Cable Loss + Read Level - Preamp Factor = Level.

Note 4: Measurement receive antenna polarization: H (Horizontal), V (Vertical)

Transmitter Radiated Emissions (1GHz~10th Harmonic)					
Operating Mode	IEEE 802.11b CH 6 / Ant. 1			Polarization	V
Temperature	25.6°C	Humidity	56%	Test Engineer	Jim Huang

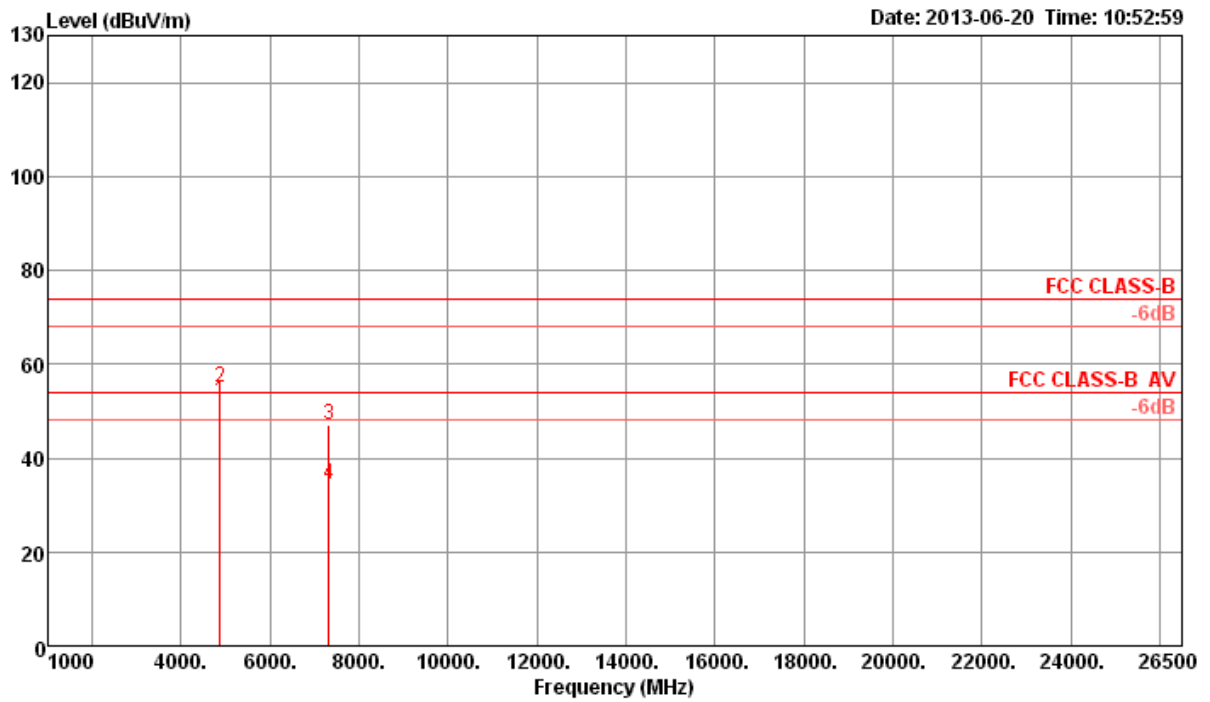

	Freq	Level	Limit	Over	Read	Cable	Antenna	Preamp	Remark	A/Pos	T/Pos	Pol/Phase
	MHz	dBuV/m	dBuV/m	dB	dBuV	dB	dB/m	dB		cm	deg	
1	4874.00	52.28	54.00	-1.72	50.82	3.33	33.16	35.03	Average	176	88	VERTICAL
2	4874.01	55.00	74.00	-19.00	53.54	3.33	33.16	35.03	Peak	176	88	VERTICAL
3	7309.95	47.03	74.00	-26.97	42.41	4.06	35.96	35.40	Peak	100	110	VERTICAL
4	7311.80	34.52	54.00	-19.48	29.90	4.06	35.96	35.40	Average	100	110	VERTICAL

Note 1: The amplitude of spurious emissions which are attenuated by more than 20 dB below the permissible value has no need to be reported.

Note 2: Emission level (dBuV/m) = 20 log Emission level (uV/m).

Note 3: Corrected Reading: Antenna Factor + Cable Loss + Read Level - Preamp Factor = Level.

Note 4: Measurement receive antenna polarization: H (Horizontal), V (Vertical)

Transmitter Radiated Emissions (1GHz~10th Harmonic)					
Operating Mode	IEEE 802.11b CH 11 / Ant. 1			Polarization	H
Temperature	25.6°C	Humidity	56%	Test Engineer	Jim Huang

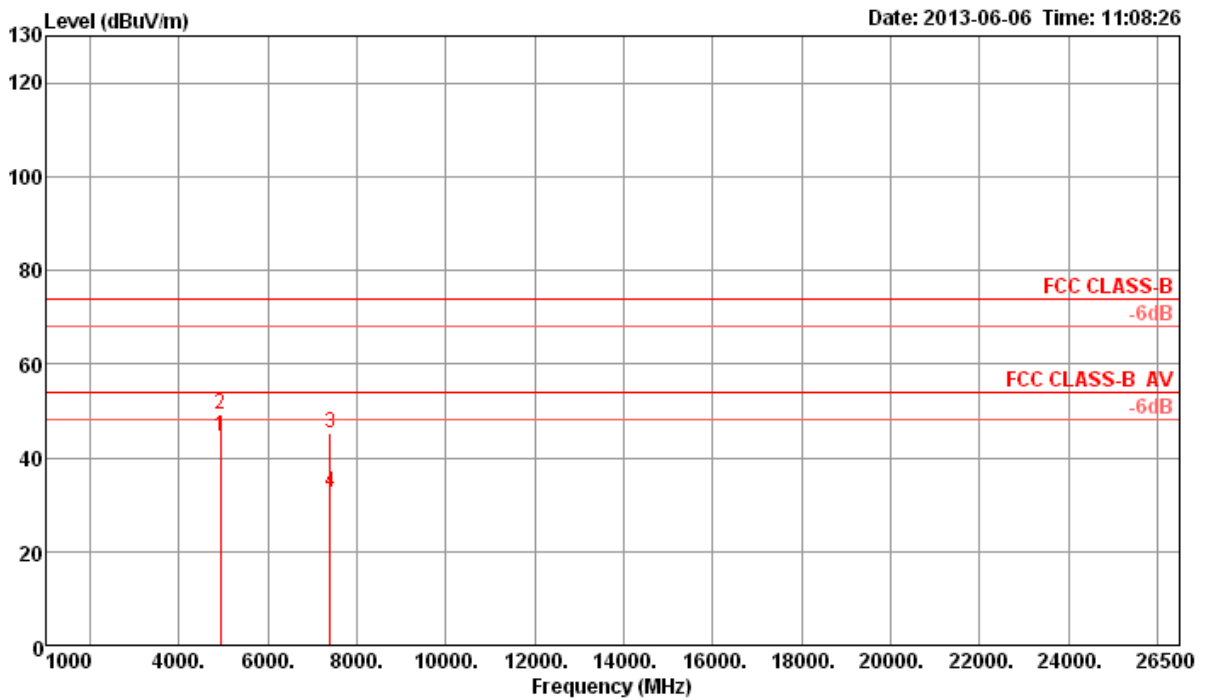

	Freq	Level	Limit	Over	Read	Cable	Antenna	Preamp	Remark	A/Pos	T/Pos	Pol/Phase
	MHz	dBuV/m	dBuV/m	dB	dBuV	dB	dB/m	dB		cm	deg	
1	4924.00	44.66	54.00	-9.34	43.06	3.35	33.26	35.01	Average	189	165	HORIZONTAL
2	4924.04	49.25	74.00	-24.75	47.65	3.35	33.26	35.01	Peak	189	165	HORIZONTAL
3	7385.46	45.20	74.00	-28.80	40.45	4.06	36.09	35.40	Peak	100	222	HORIZONTAL
4	7387.41	32.55	54.00	-21.45	27.80	4.06	36.09	35.40	Average	100	222	HORIZONTAL

Note 1: The amplitude of spurious emissions which are attenuated by more than 20 dB below the permissible value has no need to be reported.

Note 2: Emission level (dBuV/m) = 20 log Emission level (uV/m).

Note 3: Corrected Reading: Antenna Factor + Cable Loss + Read Level - Preamp Factor = Level.

Note 4: Measurement receive antenna polarization: H (Horizontal), V (Vertical)

Transmitter Radiated Emissions (1GHz~10th Harmonic)					
Operating Mode	IEEE 802.11b CH 11 / Ant. 1			Polarization	V
Temperature	25.6°C	Humidity	56%	Test Engineer	Jim Huang

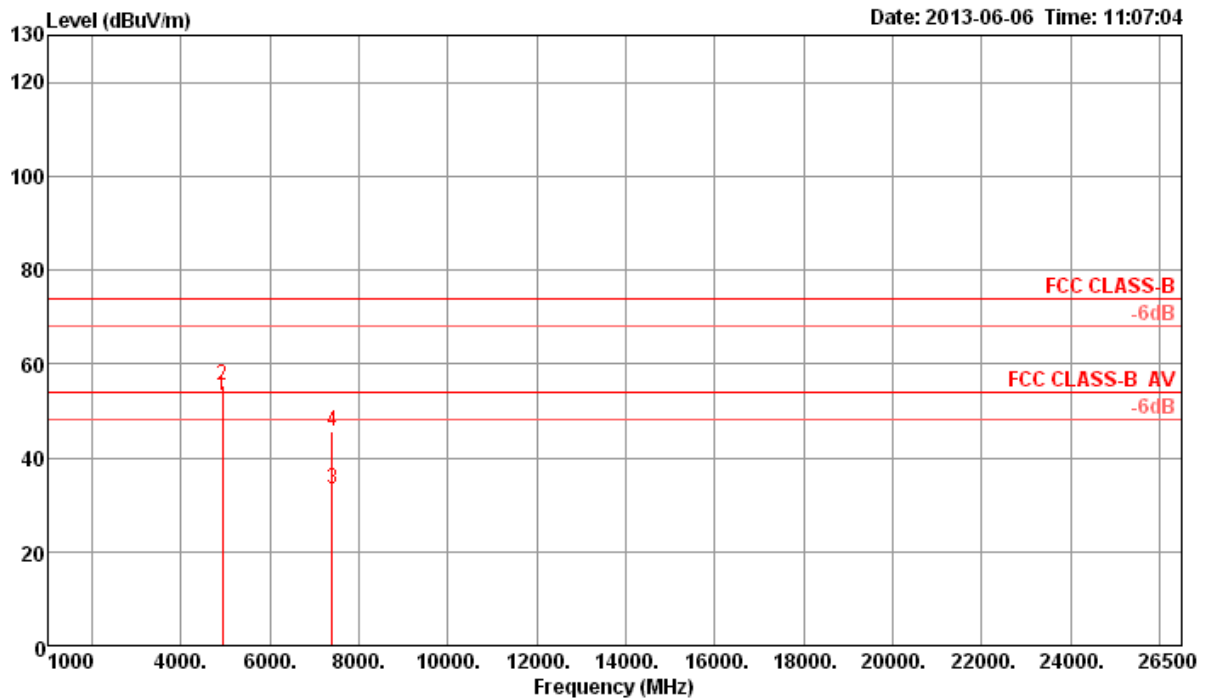

	Freq	Level	Limit	Over	Read	Cable	Antenna	Preamp	Remark	A/Pos	T/Pos	Pol/Phase
	MHz	dBuV/m	dBuV/m	dB	dBuV	dB	dB/m	dB		cm	deg	
1	4924.01	53.19	54.00	-0.81	51.59	3.35	33.26	35.01	Average	168	88	VERTICAL
2	4924.06	55.50	74.00	-18.50	53.90	3.35	33.26	35.01	Peak	168	88	VERTICAL
3	7384.99	33.34	54.00	-20.66	28.59	4.06	36.09	35.40	Average	100	266	VERTICAL
4	7385.20	45.71	74.00	-28.29	40.96	4.06	36.09	35.40	Peak	100	266	VERTICAL

Note 1: The amplitude of spurious emissions which are attenuated by more than 20 dB below the permissible value has no need to be reported.

Note 2: Emission level (dBuV/m) = 20 log Emission level (uV/m).

Note 3: Corrected Reading: Antenna Factor + Cable Loss + Read Level - Preamp Factor = Level.

Note 4: Measurement receive antenna polarization: H (Horizontal), V (Vertical)

Transmitter Radiated Emissions (1GHz~10th Harmonic)					
Operating Mode	IEEE 802.11b CH 1 / Ant. 2			Polarization	H
Temperature	25.6°C	Humidity	56%	Test Engineer	Jim Huang

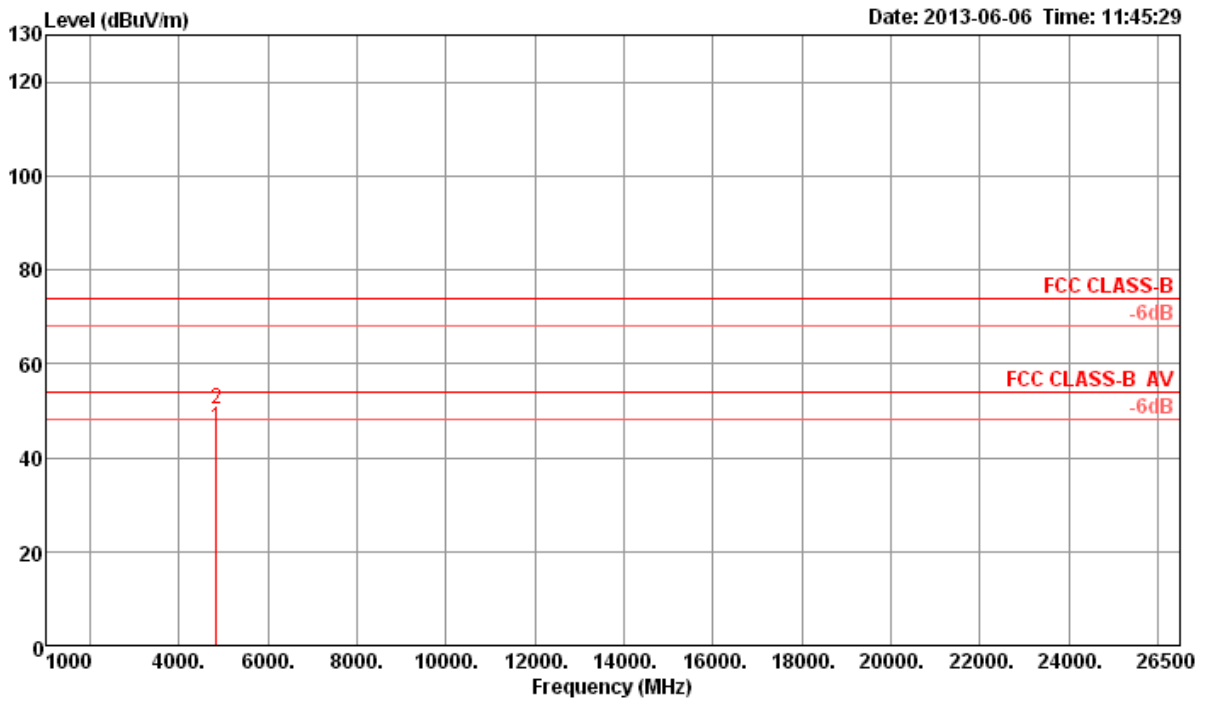

	Freq	Level	Limit	Over	Read	Cable	Antenna	Preamp	Remark	A/Pos	T/Pos	Pol/Phase
	MHz	dBuV/m	dBuV/m	dB	dBuV	dB	dB/m	dB		cm	deg	
1	4824.00	46.53	54.00	-7.47	45.19	3.31	33.06	35.03	Average	179	49	HORIZONTAL
2	4824.04	50.35	74.00	-23.65	49.01	3.31	33.06	35.03	Peak	179	49	HORIZONTAL

Note 1: The amplitude of spurious emissions which are attenuated by more than 20 dB below the permissible value has no need to be reported.  
 Note 2: Emission level (dBuV/m) = 20 log Emission level (uV/m).  
 Note 3: Corrected Reading: Antenna Factor + Cable Loss + Read Level - Preamp Factor = Level.  
 Note 4: Measurement receive antenna polarization: H (Horizontal), V (Vertical)

Transmitter Radiated Emissions (1GHz~10th Harmonic)					
Operating Mode	IEEE 802.11b CH 1 / Ant. 2			Polarization	V
Temperature	25.6°C	Humidity	56%	Test Engineer	Jim Huang

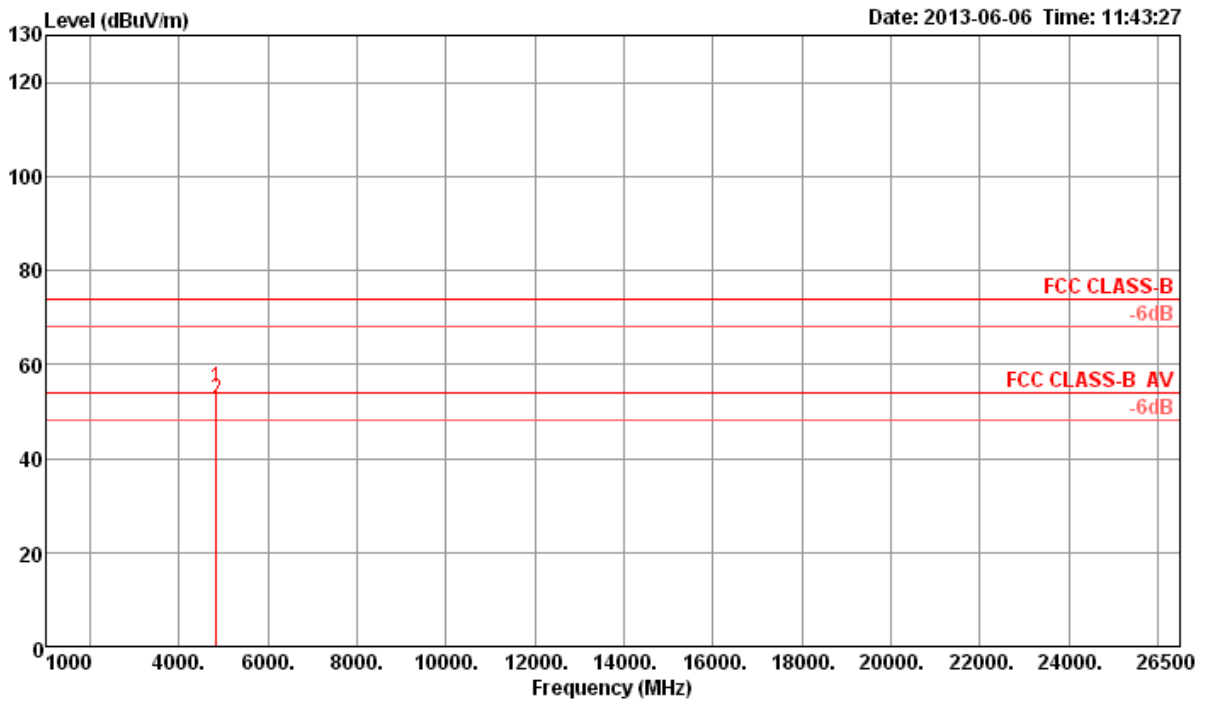

	Freq	Level	Limit	Over	Read	Cable	Antenna	Preamp	Remark	A/Pos	T/Pos	Pol/Phase
	MHz	dBuV/m	dBuV/m	dB	dBuV	dB	dB/m	dB		cm	deg	
1	4823.96	54.98	74.00	-19.02	53.64	3.31	33.06	35.03	Peak	105	8	VERTICAL
2	4824.00	52.65	54.00	-1.35	51.31	3.31	33.06	35.03	Average	105	8	VERTICAL

Note 1: The amplitude of spurious emissions which are attenuated by more than 20 dB below the permissible value has no need to be reported.

Note 2: Emission level (dBuV/m) = 20 log Emission level (uV/m).

Note 3: Corrected Reading: Antenna Factor + Cable Loss + Read Level - Preamp Factor = Level.

Note 4: Measurement receive antenna polarization: H (Horizontal), V (Vertical)

Transmitter Radiated Emissions (1GHz~10th Harmonic)					
Operating Mode	IEEE 802.11b CH 6 / Ant. 2			Polarization	H
Temperature	25.6°C	Humidity	56%	Test Engineer	Jim Huang

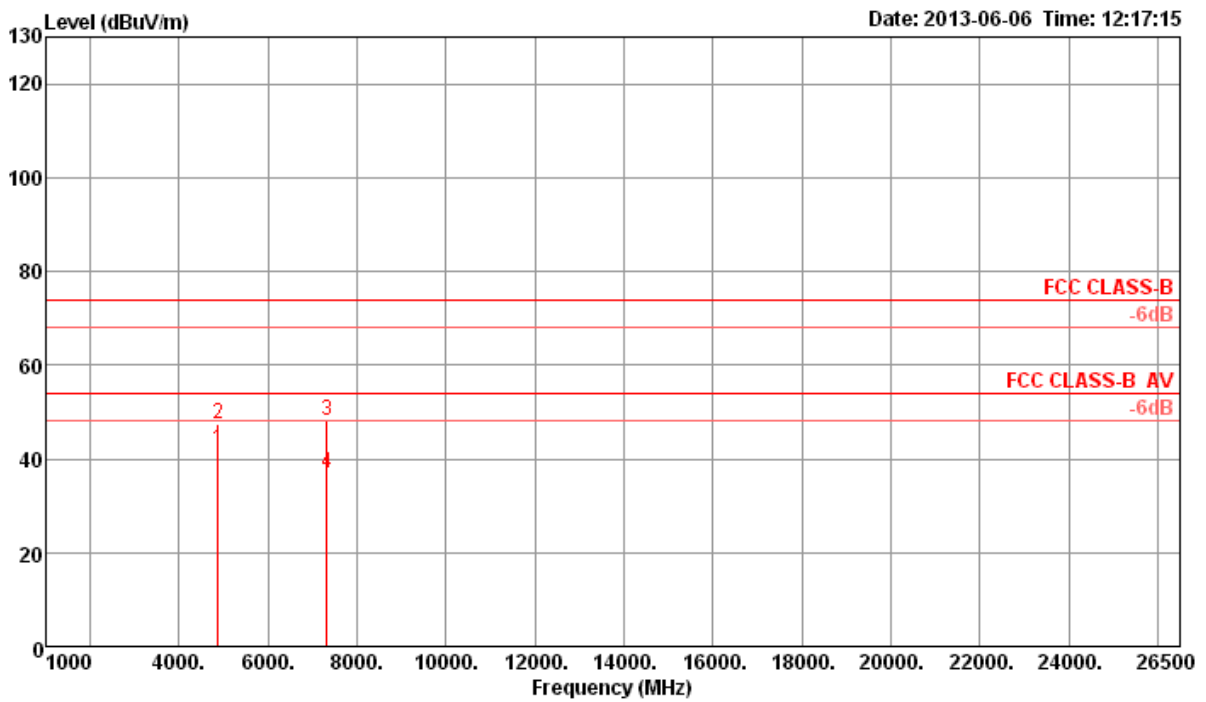

	Freq	Level	Limit	Over	Read	Cable	Antenna	Preamp	Remark	A/Pos	T/Pos	Pol/Phase
	MHz	dBuV/m	dBuV/m	dB	dBuV	dB	dB/m	dB		cm	deg	
1	4874.01	41.86	54.00	-12.14	40.40	3.33	33.16	35.03	Average	100	2	HORIZONTAL
2	4874.10	47.58	74.00	-26.42	46.12	3.33	33.16	35.03	Peak	100	2	HORIZONTAL
3	7310.20	48.22	74.00	-25.78	43.60	4.06	35.96	35.40	Peak	100	328	HORIZONTAL
4	7310.23	36.82	54.00	-17.18	32.20	4.06	35.96	35.40	Average	100	328	HORIZONTAL

Note 1: The amplitude of spurious emissions which are attenuated by more than 20 dB below the permissible value has no need to be reported.

Note 2: Emission level (dBuV/m) = 20 log Emission level (uV/m).

Note 3: Corrected Reading: Antenna Factor + Cable Loss + Read Level - Preamp Factor = Level.

Note 4: Measurement receive antenna polarization: H (Horizontal), V (Vertical)

Transmitter Radiated Emissions (1GHz~10th Harmonic)					
Operating Mode	IEEE 802.11b CH 6 / Ant. 2			Polarization	V
Temperature	25.6°C	Humidity	56%	Test Engineer	Jim Huang

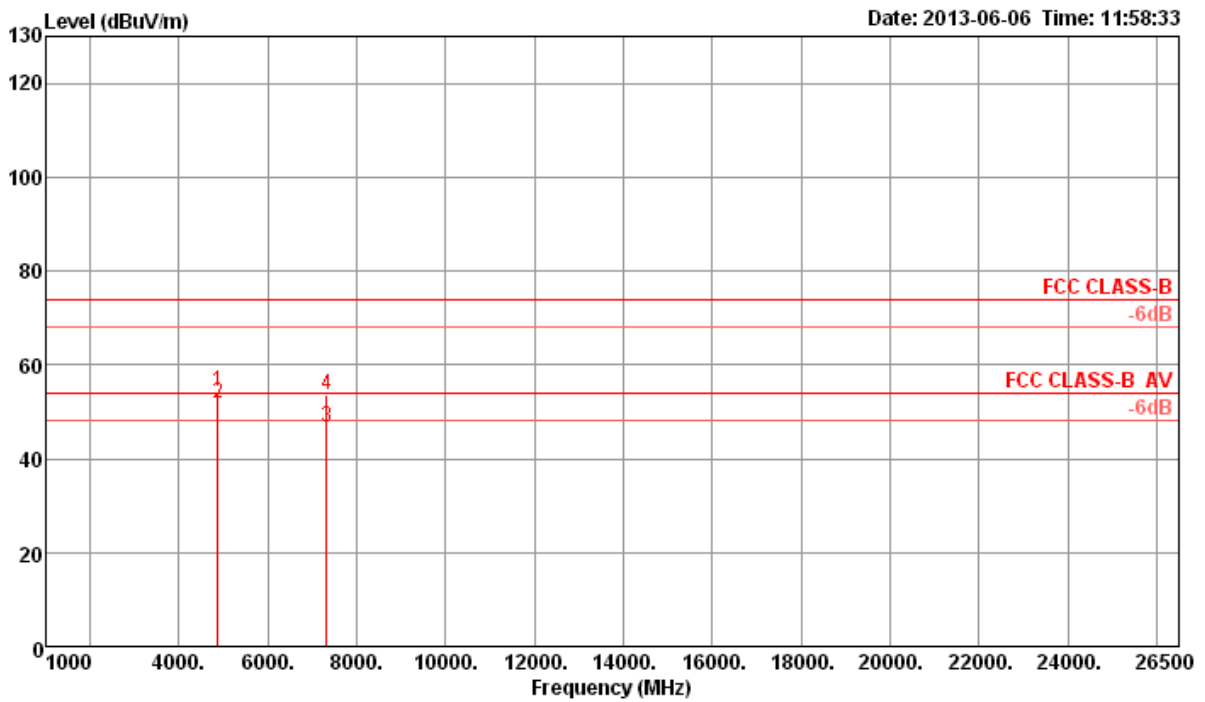

	Freq	Level	Limit	Over	Read	Cable	Antenna	Preamp	Remark	A/Pos	T/Pos	Pol/Phase
	MHz	dBuV/m	dBuV/m	dB	dBuV	dB	dB/m	dB		cm	deg	
1	4873.98	54.33	74.00	-19.67	52.87	3.33	33.16	35.03	Peak	103	356	VERTICAL
2	4873.99	51.83	54.00	-2.17	50.37	3.33	33.16	35.03	Average	103	356	VERTICAL
3	7310.27	46.78	54.00	-7.22	42.16	4.06	35.96	35.40	Average	188	17	VERTICAL
4	7310.89	53.54	74.00	-20.46	48.92	4.06	35.96	35.40	Peak	188	17	VERTICAL

Note 1: The amplitude of spurious emissions which are attenuated by more than 20 dB below the permissible value has no need to be reported.

Note 2: Emission level (dBuV/m) = 20 log Emission level (uV/m).

Note 3: Corrected Reading: Antenna Factor + Cable Loss + Read Level - Preamp Factor = Level.

Note 4: Measurement receive antenna polarization: H (Horizontal), V (Vertical)



Transmitter Radiated Emissions (1GHz~10th Harmonic)					
Operating Mode	IEEE 802.11b CH 11 / Ant. 2			Polarization	H
Temperature	25.6°C	Humidity	56%	Test Engineer	Jim Huang

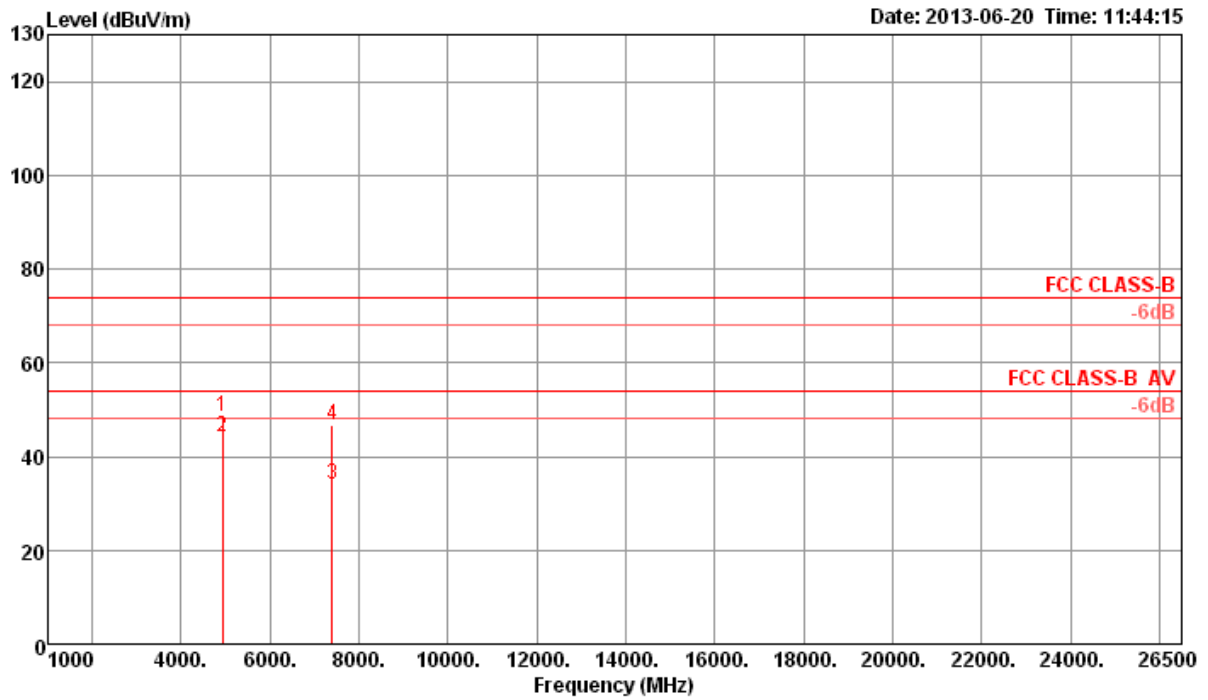

	Freq	Level	Limit Line	Over Limit	Read Level	Cable Loss	Antenna Factor	Preamp Factor	Remark	A/Pos	T/Pos	Pol/Phase
	MHz	dBuV/m	dBuV/m	dB	dBuV	dB	dB/m	dB		cm	deg	
1	4923.94	48.54	74.00	-25.46	46.94	3.35	33.26	35.01	Peak	186	50	HORIZONTAL
2	4924.02	44.08	54.00	-9.92	42.48	3.35	33.26	35.01	Average	186	50	HORIZONTAL
3	7385.10	33.87	54.00	-20.13	29.12	4.06	36.09	35.40	Average	100	199	HORIZONTAL
4	7387.52	46.59	74.00	-27.41	41.84	4.06	36.09	35.40	Peak	100	199	HORIZONTAL

Note 1: The amplitude of spurious emissions which are attenuated by more than 20 dB below the permissible value has no need to be reported.

Note 2: Emission level (dBuV/m) = 20 log Emission level (uV/m).

Note 3: Corrected Reading: Antenna Factor + Cable Loss + Read Level - Preamp Factor = Level.

Note 4: Measurement receive antenna polarization: H (Horizontal), V (Vertical)

Transmitter Radiated Emissions (1GHz~10th Harmonic)					
Operating Mode	IEEE 802.11b CH 11 / Ant. 2			Polarization	V
Temperature	25.6°C	Humidity	56%	Test Engineer	Jim Huang

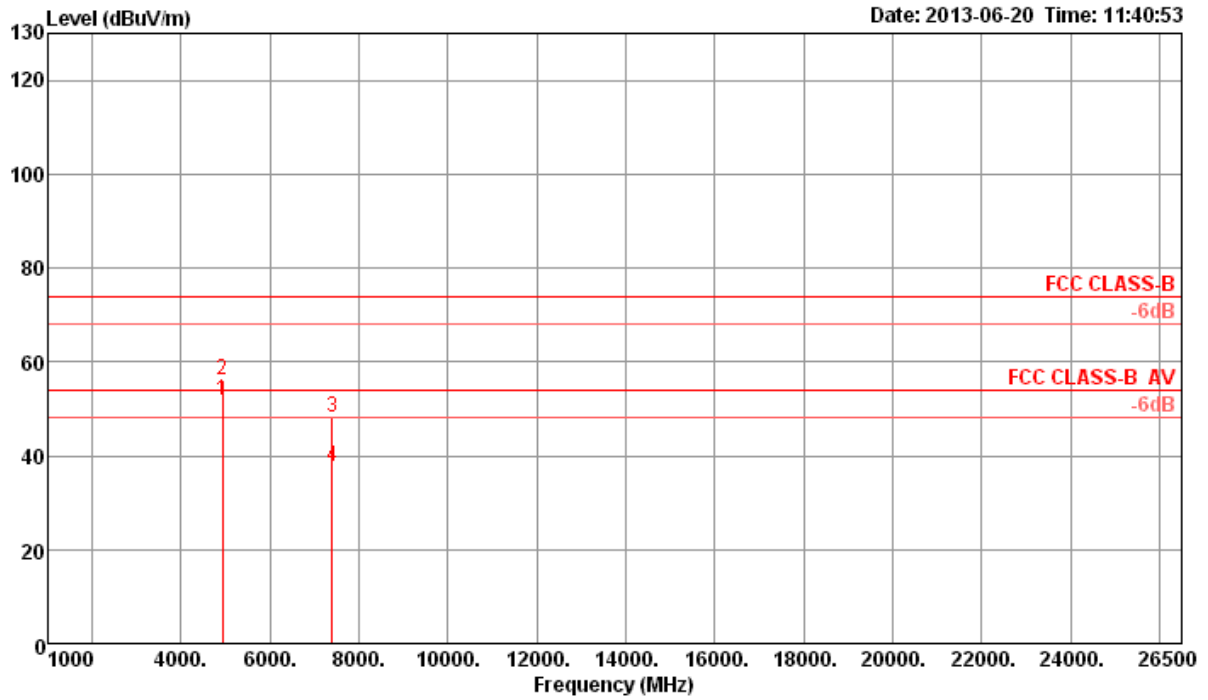

	Freq	Level	Limit	Over	Read	Cable	Antenna	Preamp	Remark	A/Pos	T/Pos	Pol/Phase
	MHz	dBuV/m	dBuV/m	dB	dBuV	dB	dB/m	dB		cm	deg	
1	4923.99	51.62	54.00	-2.38	50.02	3.35	33.26	35.01	Average	100	211	VERTICAL
2	4924.04	55.95	74.00	-18.05	54.35	3.35	33.26	35.01	Peak	100	211	VERTICAL
3	7385.50	48.17	74.00	-25.83	43.42	4.06	36.09	35.40	Peak	100	80	VERTICAL
4	7386.87	37.55	54.00	-16.45	32.80	4.06	36.09	35.40	Average	100	80	VERTICAL

Note 1: The amplitude of spurious emissions which are attenuated by more than 20 dB below the permissible value has no need to be reported.  
 Note 2: Emission level (dBuV/m) = 20 log Emission level (uV/m).  
 Note 3: Corrected Reading: Antenna Factor + Cable Loss + Read Level - Preamp Factor = Level.  
 Note 4: Measurement receive antenna polarization: H (Horizontal), V (Vertical)

Transmitter Radiated Emissions (1GHz~10th Harmonic)					
Operating Mode	IEEE 802.11g CH 1 / Ant. 1			Polarization	H
Temperature	25.6°C	Humidity	56%	Test Engineer	Jim Huang

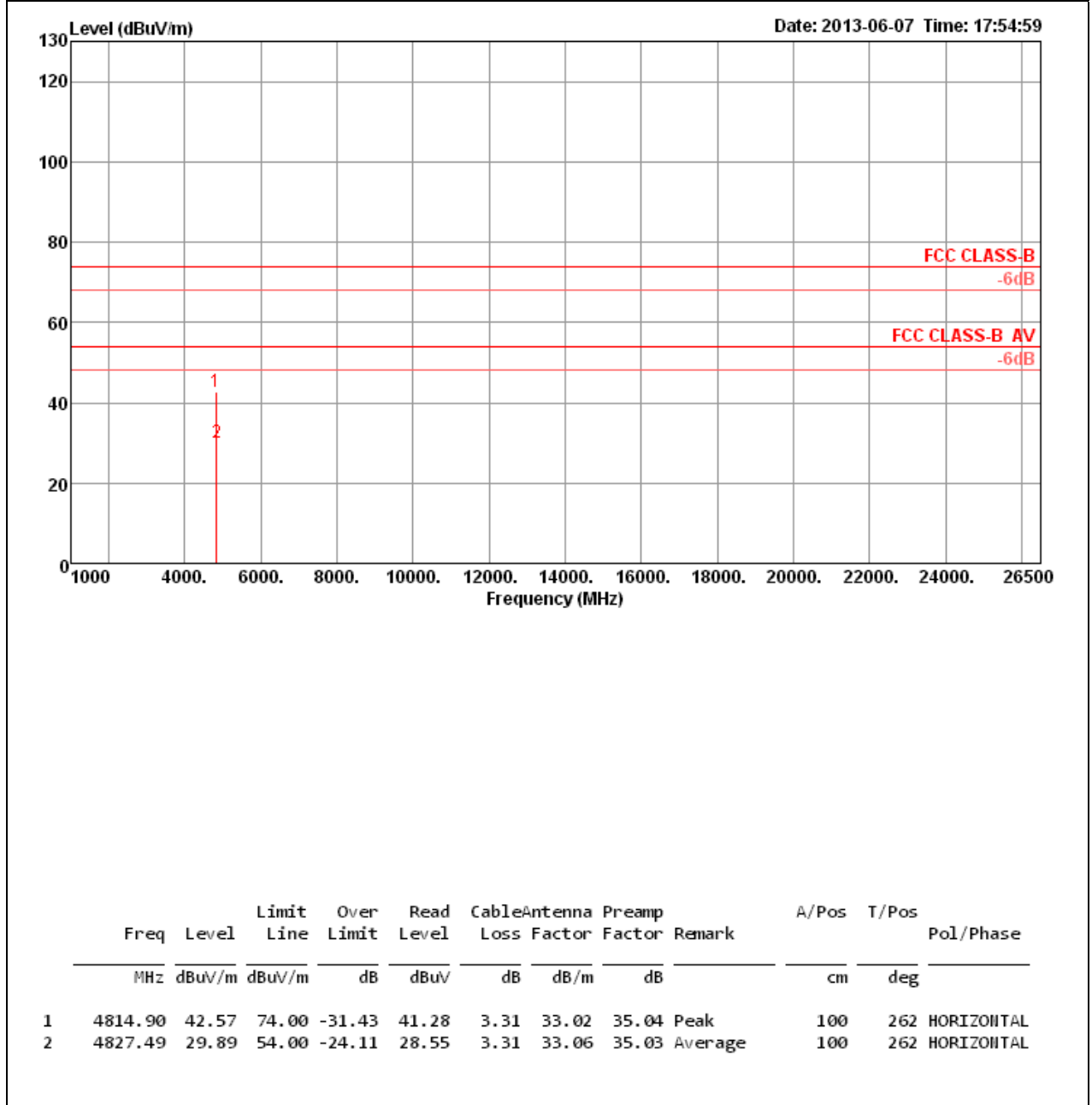

	Freq	Level	Limit	Over	Read	Cable	Antenna	Preamp	Remark	A/Pos	T/Pos	Pol/Phase
	MHz	dBuV/m	dBuV/m	dB	dBuV	dB	dB/m	dB		cm	deg	
1	4814.90	42.57	74.00	-31.43	41.28	3.31	33.02	35.04	Peak	100	262	HORIZONTAL
2	4827.49	29.89	54.00	-24.11	28.55	3.31	33.06	35.03	Average	100	262	HORIZONTAL

Note 1: The amplitude of spurious emissions which are attenuated by more than 20 dB below the permissible value has no need to be reported.  
 Note 2: Emission level (dBuV/m) = 20 log Emission level (uV/m).  
 Note 3: Corrected Reading: Antenna Factor + Cable Loss + Read Level - Preamp Factor = Level.  
 Note 4: Measurement receive antenna polarization: H (Horizontal), V (Vertical)

Transmitter Radiated Emissions (1GHz~10th Harmonic)					
Operating Mode	IEEE 802.11g CH 1 / Ant. 1			Polarization	V
Temperature	25.6°C	Humidity	56%	Test Engineer	Jim Huang

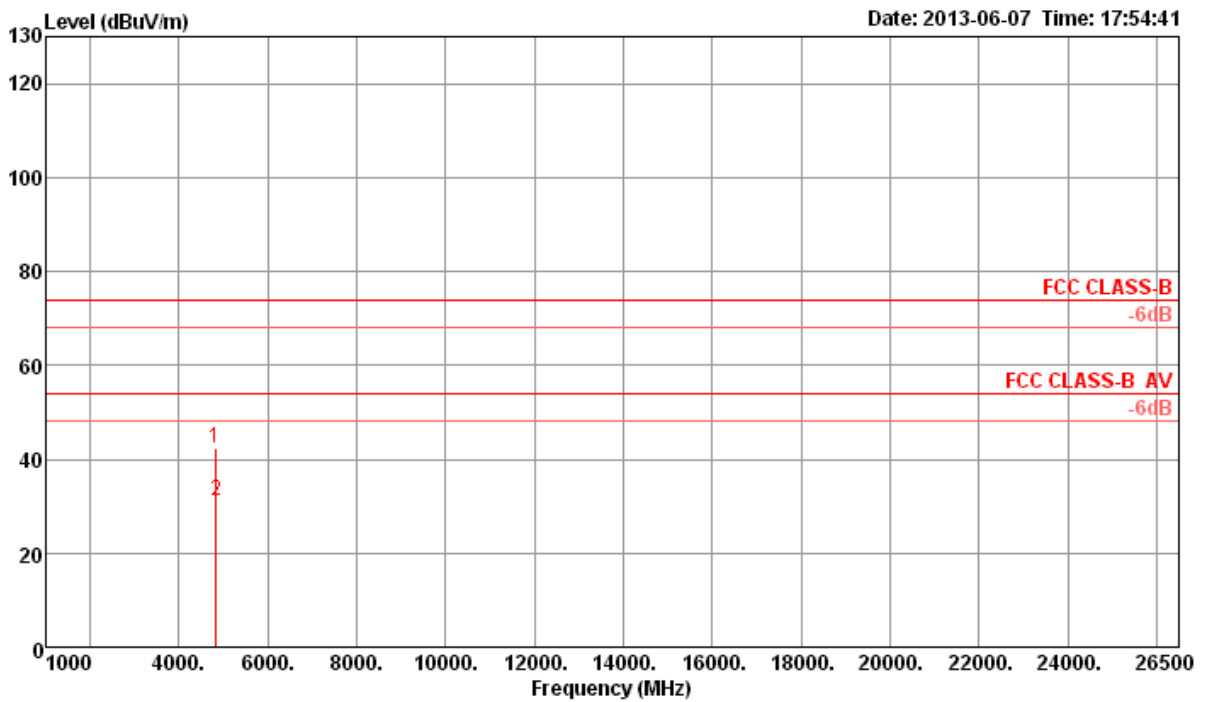

	Freq	Level	Limit	Over	Read	Cable	Antenna	Preamp	Remark	A/Pos	T/Pos	Pol/Phase
	MHz	dBuV/m	dBuV/m	dB	dBuV	dB	dB/m	dB		cm	deg	
1	4817.24	42.46	74.00	-31.54	41.17	3.31	33.02	35.04	Peak	100	163	VERTICAL
2	4824.29	31.29	54.00	-22.71	29.95	3.31	33.06	35.03	Average	100	163	VERTICAL

Note 1: The amplitude of spurious emissions which are attenuated by more than 20 dB below the permissible value has no need to be reported.

Note 2: Emission level (dBuV/m) = 20 log Emission level (uV/m).

Note 3: Corrected Reading: Antenna Factor + Cable Loss + Read Level - Preamp Factor = Level.

Note 4: Measurement receive antenna polarization: H (Horizontal), V (Vertical)

Transmitter Radiated Emissions (1GHz~10th Harmonic)					
Operating Mode	IEEE 802.11g CH 6 / Ant. 1			Polarization	H
Temperature	25.6°C	Humidity	56%	Test Engineer	Jim Huang

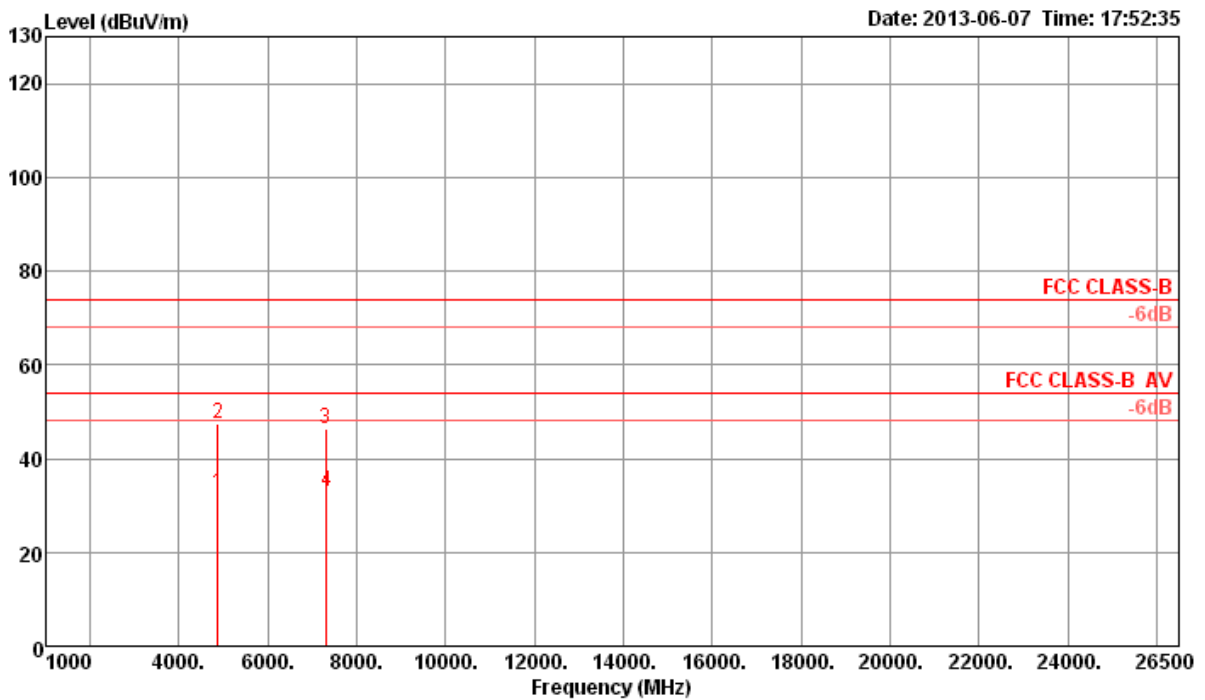

	Freq	Level	Limit	Over	Read	Cable	Antenna	Preamp	Remark	A/Pos	T/Pos	Pol/Phase
	MHz	dBuV/m	dBuV/m	dB	dBuV	dB	dB/m	dB		cm	deg	
1	4873.62	32.72	54.00	-21.28	31.26	3.33	33.16	35.03	Average	100	205	HORIZONTAL
2	4874.90	47.34	74.00	-26.66	45.88	3.33	33.16	35.03	Peak	100	205	HORIZONTAL
3	7296.34	46.27	74.00	-27.73	41.69	4.06	35.92	35.40	Peak	100	240	HORIZONTAL
4	7313.64	33.01	54.00	-20.99	28.39	4.06	35.96	35.40	Average	100	240	HORIZONTAL

Note 1: The amplitude of spurious emissions which are attenuated by more than 20 dB below the permissible value has no need to be reported.

Note 2: Emission level (dBuV/m) = 20 log Emission level (uV/m).

Note 3: Corrected Reading: Antenna Factor + Cable Loss + Read Level - Preamp Factor = Level.

Note 4: Measurement receive antenna polarization: H (Horizontal), V (Vertical)

Transmitter Radiated Emissions (1GHz~10th Harmonic)					
Operating Mode	IEEE 802.11g CH 6 / Ant. 1			Polarization	V
Temperature	25.6°C	Humidity	56%	Test Engineer	Jim Huang

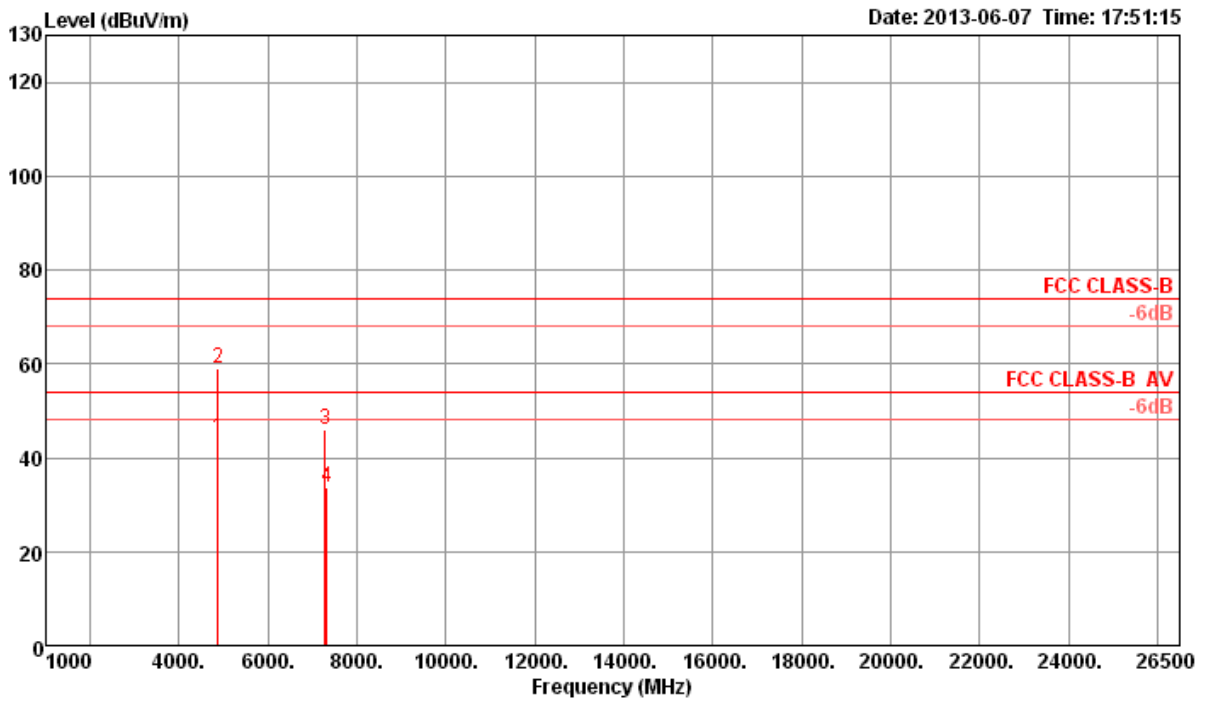

	Freq	Level	Limit	Over	Read	Cable	Antenna	Preamp	Remark	A/Pos	T/Pos	Pol/Phase
	MHz	dBuV/m	dBuV/m	dB	dBuV	dB	dB/m	dB		cm	deg	
1	4875.12	44.11	54.00	-9.89	42.65	3.33	33.16	35.03	Average	169	80	VERTICAL
2	4877.13	59.06	74.00	-14.94	57.60	3.33	33.16	35.03	Peak	169	80	VERTICAL
3	7287.36	45.83	74.00	-28.17	41.28	4.06	35.89	35.40	Peak	100	140	VERTICAL
4	7309.72	33.52	54.00	-20.48	28.90	4.06	35.96	35.40	Average	100	140	VERTICAL

Note 1: The amplitude of spurious emissions which are attenuated by more than 20 dB below the permissible value has no need to be reported.

Note 2: Emission level (dBuV/m) = 20 log Emission level (uV/m).

Note 3: Corrected Reading: Antenna Factor + Cable Loss + Read Level - Preamp Factor = Level.

Note 4: Measurement receive antenna polarization: H (Horizontal), V (Vertical)

Transmitter Radiated Emissions (1GHz~10th Harmonic)					
Operating Mode	IEEE 802.11g CH 11 / Ant. 1			Polarization	H
Temperature	25.6°C	Humidity	56%	Test Engineer	Jim Huang

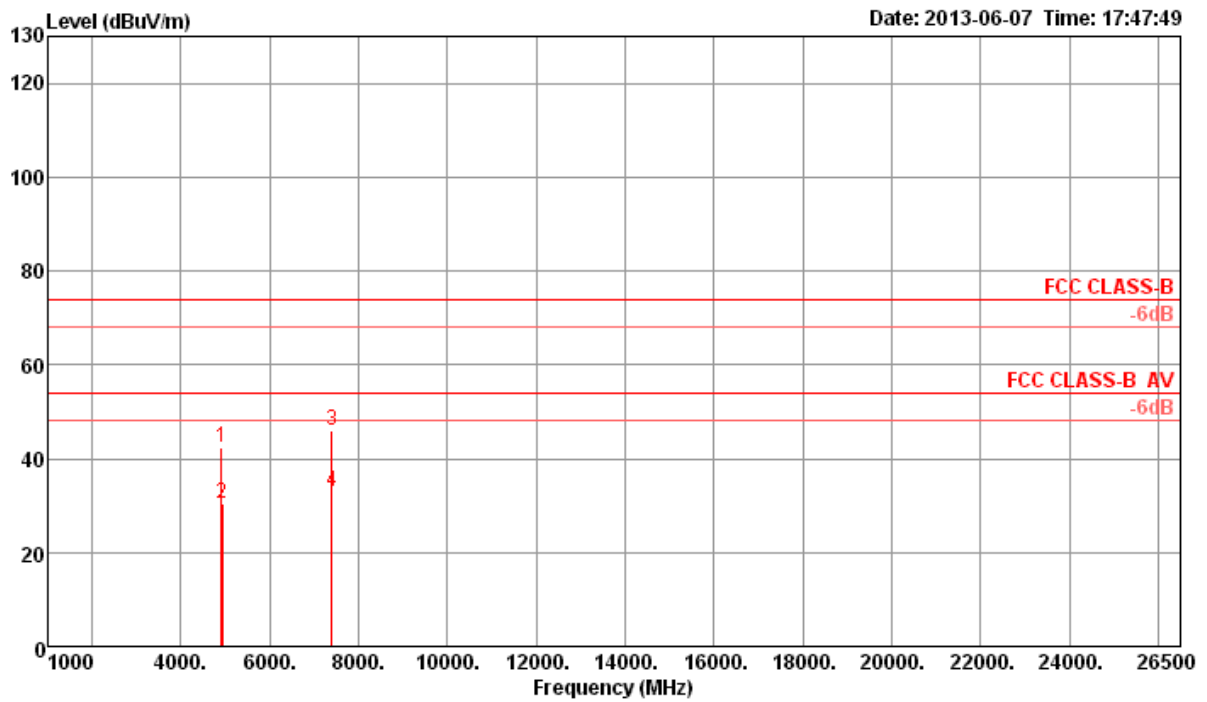

	Freq	Level	Limit	Over	Read	Cable	Antenna	Preamp	Remark	A/Pos	T/Pos	Pol/Phase
	MHz	dBuV/m	dBuV/m	dB	dBuV	dB	dB/m	dB		cm	deg	
1	4914.29	42.52	74.00	-31.48	40.96	3.35	33.23	35.02	Peak	100	162	HORIZONTAL
2	4924.67	30.39	54.00	-23.61	28.79	3.35	33.26	35.01	Average	100	162	HORIZONTAL
3	7388.47	46.16	74.00	-27.84	41.41	4.06	36.09	35.40	Peak	100	312	HORIZONTAL
4	7392.64	33.00	54.00	-21.00	28.21	4.06	36.13	35.40	Average	100	312	HORIZONTAL

Note 1: The amplitude of spurious emissions which are attenuated by more than 20 dB below the permissible value has no need to be reported.

Note 2: Emission level (dBuV/m) = 20 log Emission level (uV/m).

Note 3: Corrected Reading: Antenna Factor + Cable Loss + Read Level - Preamp Factor = Level.

Note 4: Measurement receive antenna polarization: H (Horizontal), V (Vertical)

Transmitter Radiated Emissions (1GHz~10th Harmonic)					
Operating Mode	IEEE 802.11g CH 11 / Ant. 1			Polarization	V
Temperature	25.6°C	Humidity	56%	Test Engineer	Jim Huang

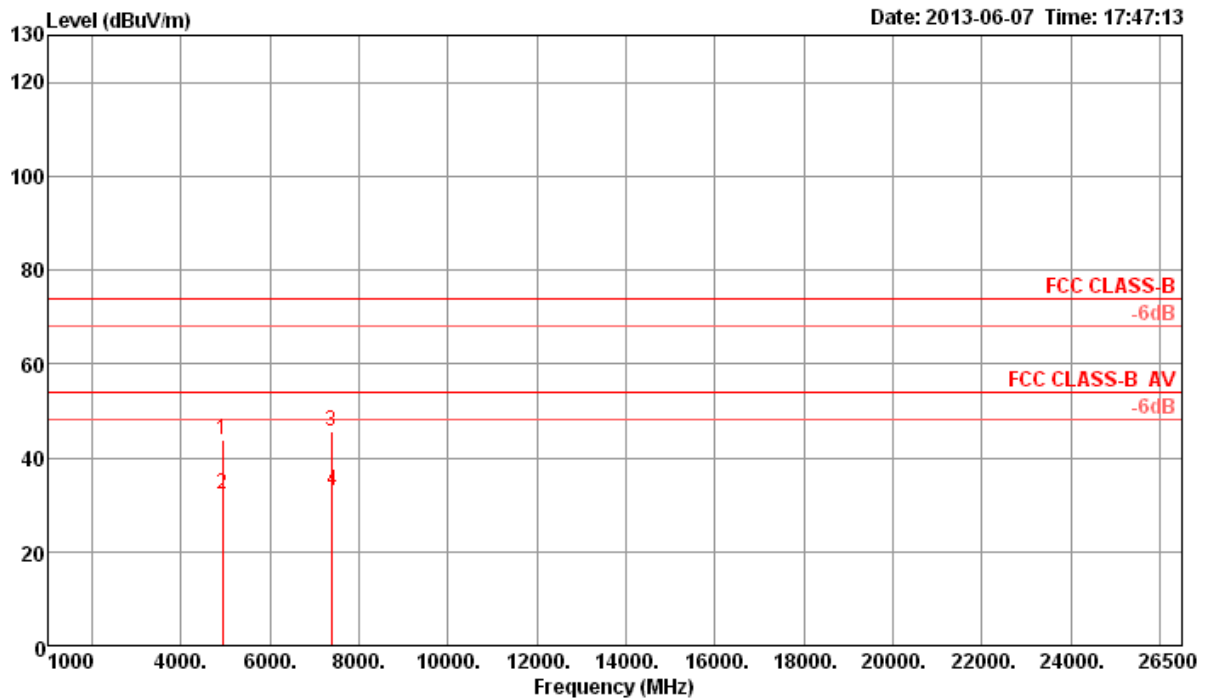

	Freq	Level	Limit	Over	Read	Cable	Antenna	Preamp	Remark	A/Pos	T/Pos	Pol/Phase
	MHz	dBuV/m	dBuV/m	dB	dBuV	dB	dB/m	dB		cm	deg	
1	4925.60	43.79	74.00	-30.21	42.19	3.35	33.26	35.01	Peak	100	125	VERTICAL
2	4928.42	32.20	54.00	-21.80	30.60	3.35	33.26	35.01	Average	100	125	VERTICAL
3	7376.83	45.56	74.00	-28.44	40.81	4.06	36.09	35.40	Peak	100	223	VERTICAL
4	7393.66	33.06	54.00	-20.94	28.27	4.06	36.13	35.40	Average	100	223	VERTICAL

Note 1: The amplitude of spurious emissions which are attenuated by more than 20 dB below the permissible value has no need to be reported.

Note 2: Emission level (dBuV/m) = 20 log Emission level (uV/m).

Note 3: Corrected Reading: Antenna Factor + Cable Loss + Read Level - Preamp Factor = Level.

Note 4: Measurement receive antenna polarization: H (Horizontal), V (Vertical)



Transmitter Radiated Emissions (1GHz~10th Harmonic)					
Operating Mode	IEEE 802.11g CH 1 / Ant. 2			Polarization	H
Temperature	25.6°C	Humidity	56%	Test Engineer	Jim Huang

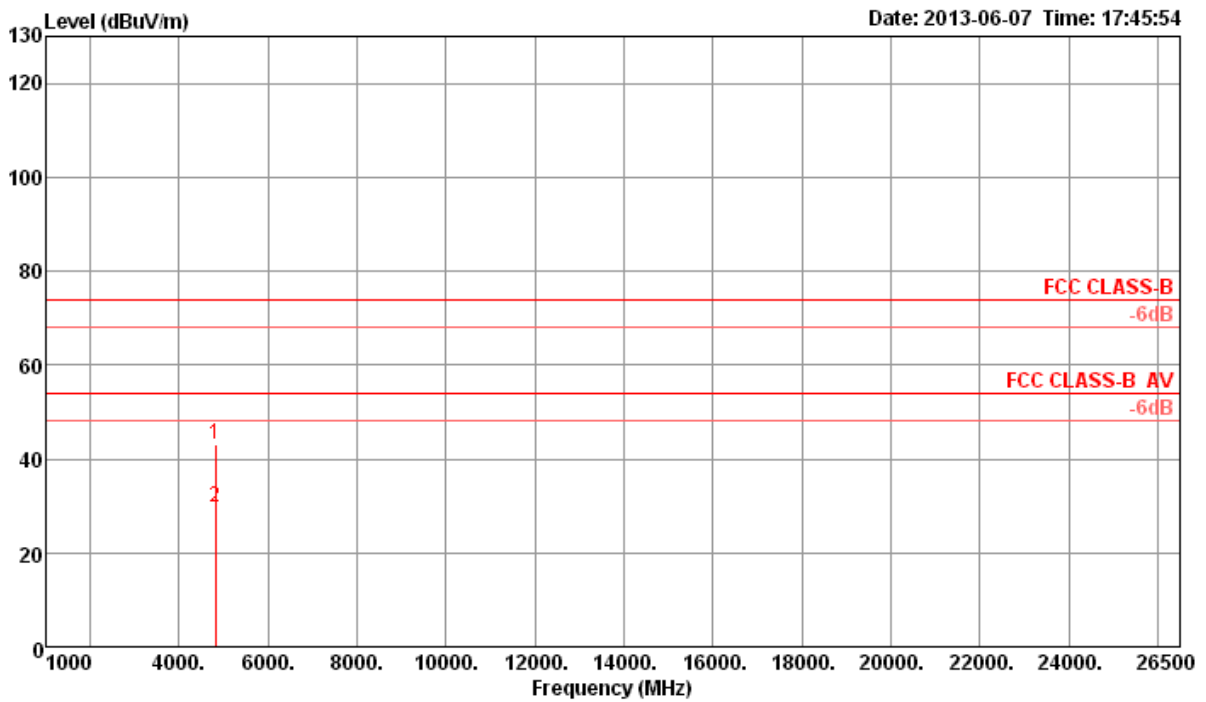

	Freq	Level	Limit	Over	Read	Cable	Antenna	Preamp	Remark	A/Pos	T/Pos	Pol/Phase
	MHz	dBuV/m	dBuV/m	dB	dBuV	dB	dB/m	dB		cm	deg	
1	4816.34	42.91	74.00	-31.09	41.62	3.31	33.02	35.04	Peak	100	230	HORIZONTAL
2	4818.33	29.81	54.00	-24.19	28.51	3.31	33.02	35.03	Average	100	230	HORIZONTAL

Note 1: The amplitude of spurious emissions which are attenuated by more than 20 dB below the permissible value has no need to be reported.

Note 2: Emission level (dBuV/m) = 20 log Emission level (uV/m).

Note 3: Corrected Reading: Antenna Factor + Cable Loss + Read Level - Preamp Factor = Level.

Note 4: Measurement receive antenna polarization: H (Horizontal), V (Vertical)

Transmitter Radiated Emissions (1GHz~10th Harmonic)					
Operating Mode	IEEE 802.11g CH 1 / Ant. 2			Polarization	V
Temperature	25.6°C	Humidity	56%	Test Engineer	Jim Huang

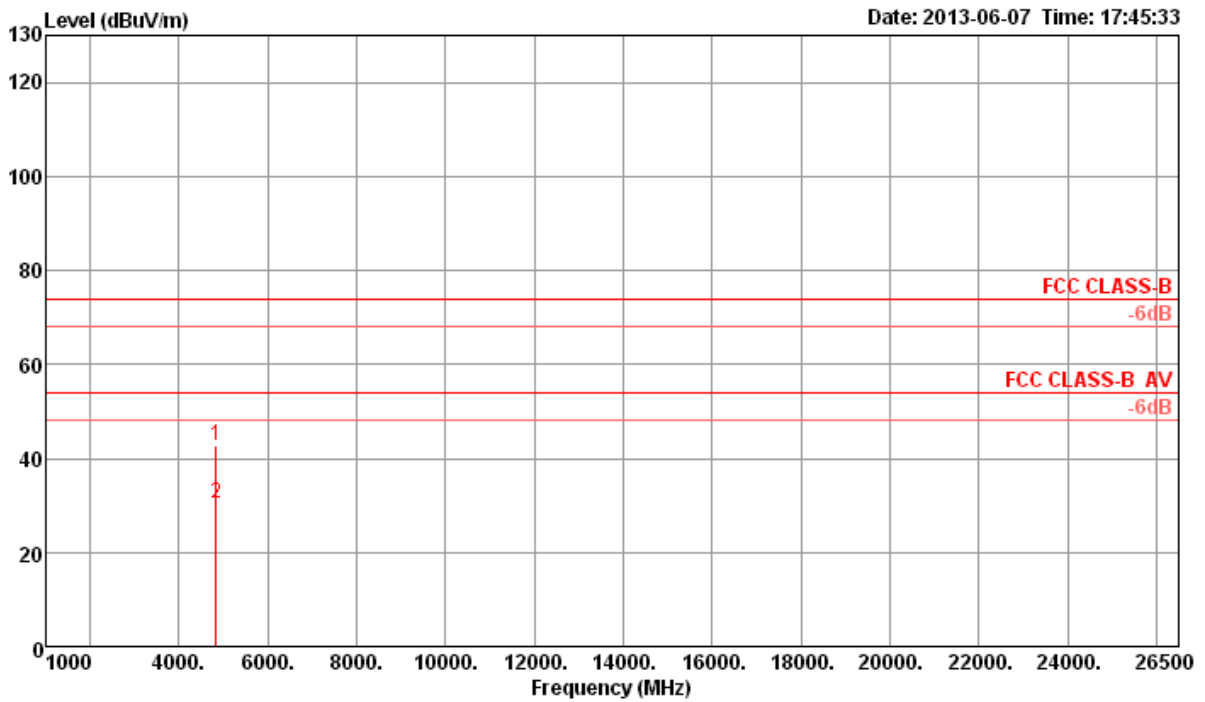

	Freq	Level	Limit	Over	Read	Cable	Antenna	Preamp	Remark	A/Pos	T/Pos	Pol/Phase
	MHz	dBuV/m	dBuV/m	dB	dBuV	dB	dB/m	dB		cm	deg	
1	4827.91	42.71	74.00	-31.29	41.37	3.31	33.06	35.03	Peak	100	129	VERTICAL
2	4828.04	30.48	54.00	-23.52	29.14	3.31	33.06	35.03	Average	100	129	VERTICAL

Note 1: The amplitude of spurious emissions which are attenuated by more than 20 dB below the permissible value has no need to be reported.  
 Note 2: Emission level (dBuV/m) = 20 log Emission level (uV/m).  
 Note 3: Corrected Reading: Antenna Factor + Cable Loss + Read Level - Preamp Factor = Level.  
 Note 4: Measurement receive antenna polarization: H (Horizontal), V (Vertical)

Transmitter Radiated Emissions (1GHz~10th Harmonic)					
Operating Mode	IEEE 802.11g CH 6 / Ant. 2			Polarization	H
Temperature	25.6°C	Humidity	56%	Test Engineer	Jim Huang

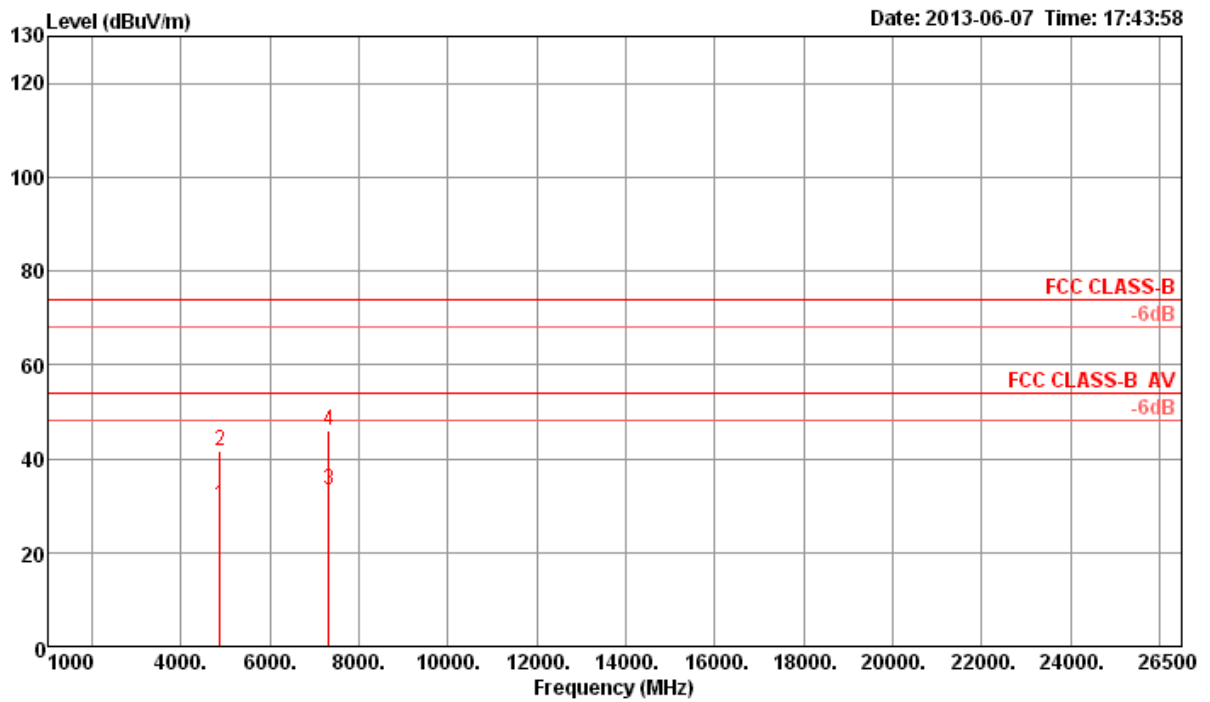

	Freq	Level	Limit	Over	Read	Cable	Antenna	Preamp	Remark	A/Pos	T/Pos	Pol/Phase
	MHz	dBuV/m	dBuV/m	dB	dBuV	dB	dB/m	dB		cm	deg	
1	4874.29	30.02	54.00	-23.98	28.56	3.33	33.16	35.03	Average	100	225	HORIZONTAL
2	4877.11	41.71	74.00	-32.29	40.25	3.33	33.16	35.03	Peak	100	225	HORIZONTAL
3	7310.46	33.30	54.00	-20.70	28.68	4.06	35.96	35.40	Average	100	65	HORIZONTAL
4	7314.53	46.07	74.00	-27.93	41.45	4.06	35.96	35.40	Peak	100	65	HORIZONTAL

Note 1: The amplitude of spurious emissions which are attenuated by more than 20 dB below the permissible value has no need to be reported.  
 Note 2: Emission level (dBuV/m) = 20 log Emission level (uV/m).  
 Note 3: Corrected Reading: Antenna Factor + Cable Loss + Read Level - Preamp Factor = Level.  
 Note 4: Measurement receive antenna polarization: H (Horizontal), V (Vertical)

Transmitter Radiated Emissions (1GHz~10th Harmonic)					
Operating Mode	IEEE 802.11g CH 6 / Ant. 2			Polarization	V
Temperature	25.6°C	Humidity	56%	Test Engineer	Jim Huang

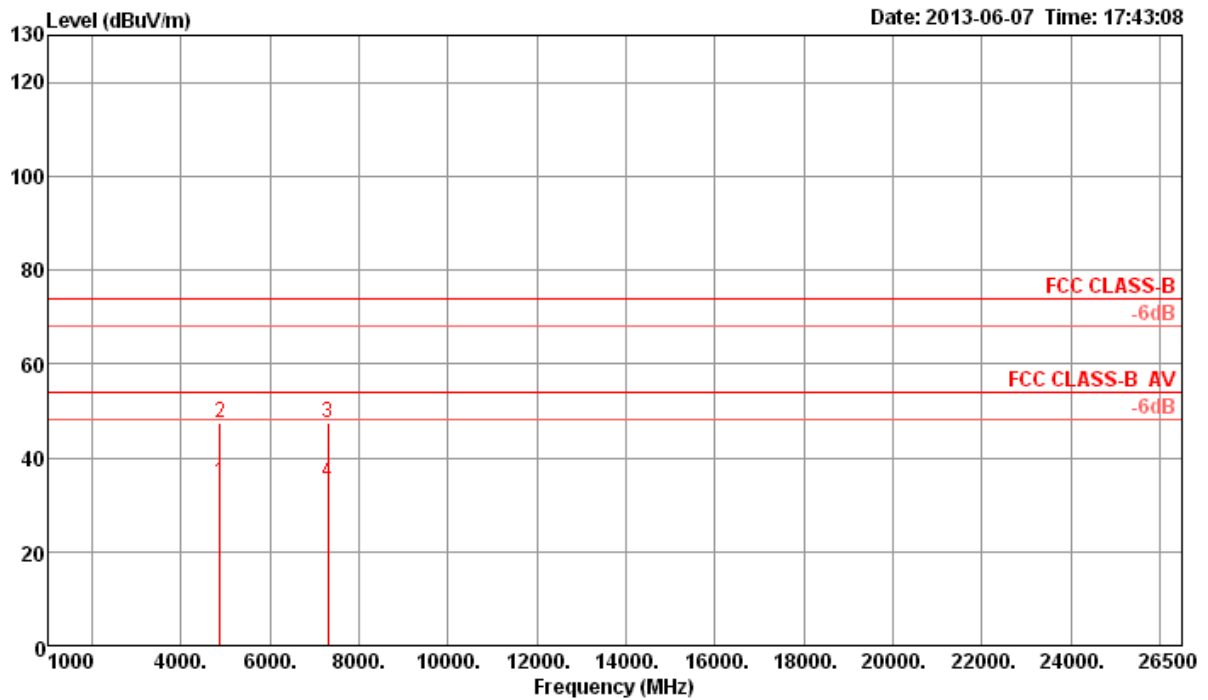

	Freq	Level	Limit	Over	Read	Cable	Antenna	Preamp	Remark	A/Pos	T/Pos	Pol/Phase
	MHz	dBuV/m	dBuV/m	dB	dBuV	dB	dB/m	dB		cm	deg	
1	4872.30	34.78	54.00	-19.22	33.32	3.33	33.16	35.03	Average	100	358	VERTICAL
2	4874.26	47.28	74.00	-26.72	45.82	3.33	33.16	35.03	Peak	100	358	VERTICAL
3	7305.30	47.54	74.00	-26.46	42.96	4.06	35.92	35.40	Peak	100	202	VERTICAL
4	7307.76	34.63	54.00	-19.37	30.01	4.06	35.96	35.40	Average	100	202	VERTICAL

Note 1: The amplitude of spurious emissions which are attenuated by more than 20 dB below the permissible value has no need to be reported.

Note 2: Emission level (dBuV/m) = 20 log Emission level (uV/m).

Note 3: Corrected Reading: Antenna Factor + Cable Loss + Read Level - Preamp Factor = Level.

Note 4: Measurement receive antenna polarization: H (Horizontal), V (Vertical)

Transmitter Radiated Emissions (1GHz~10th Harmonic)					
Operating Mode	IEEE 802.11g CH 11 / Ant. 2			Polarization	H
Temperature	25.6°C	Humidity	56%	Test Engineer	Jim Huang

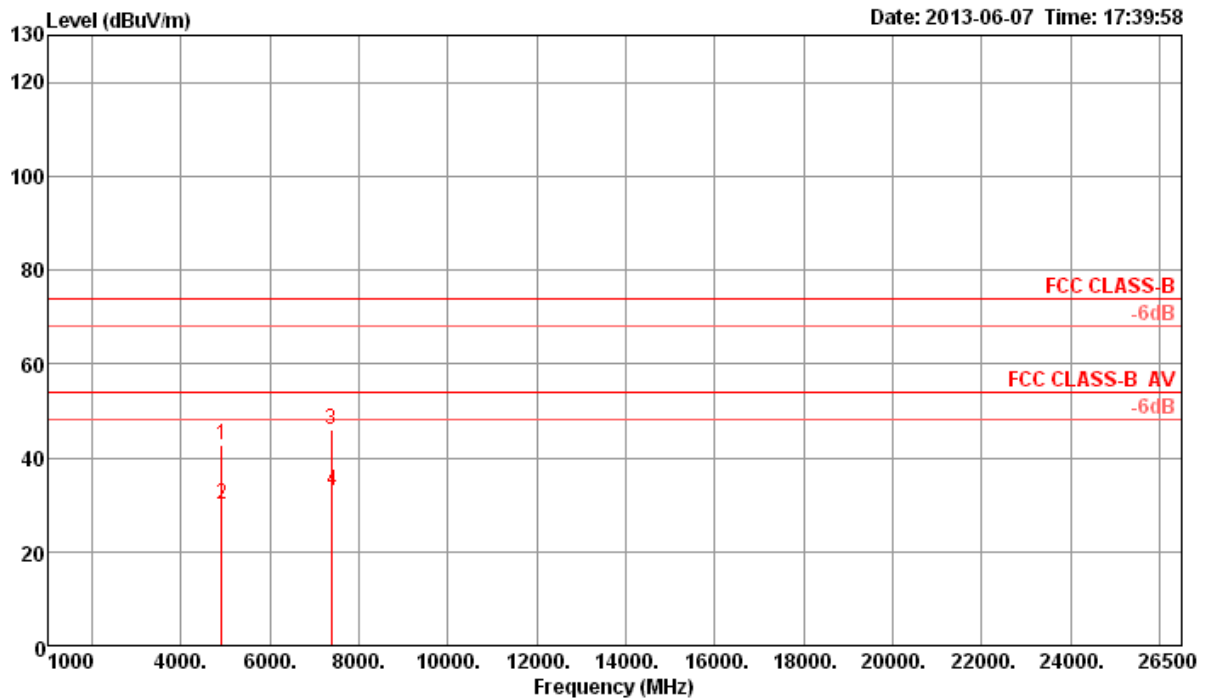

	Freq	Level	Limit	Over	Read	Cable	Antenna	Preamp	Remark	A/Pos	T/Pos	Pol/Phase
	MHz	dBuV/m	dBuV/m	dB	dBuV	dB	dB/m	dB		cm	deg	
1	4916.56	42.72	74.00	-31.28	41.16	3.35	33.23	35.02	Peak	100	313	HORIZONTAL
2	4916.79	29.94	54.00	-24.06	28.38	3.35	33.23	35.02	Average	100	313	HORIZONTAL
3	7377.54	46.09	74.00	-27.91	41.34	4.06	36.09	35.40	Peak	100	269	HORIZONTAL
4	7385.68	32.96	54.00	-21.04	28.21	4.06	36.09	35.40	Average	100	269	HORIZONTAL

Note 1: The amplitude of spurious emissions which are attenuated by more than 20 dB below the permissible value has no need to be reported.

Note 2: Emission level (dBuV/m) = 20 log Emission level (uV/m).

Note 3: Corrected Reading: Antenna Factor + Cable Loss + Read Level - Preamp Factor = Level.

Note 4: Measurement receive antenna polarization: H (Horizontal), V (Vertical)

Transmitter Radiated Emissions (1GHz~10th Harmonic)					
Operating Mode	IEEE 802.11g CH 11 / Ant. 2			Polarization	V
Temperature	25.6°C	Humidity	56%	Test Engineer	Jim Huang

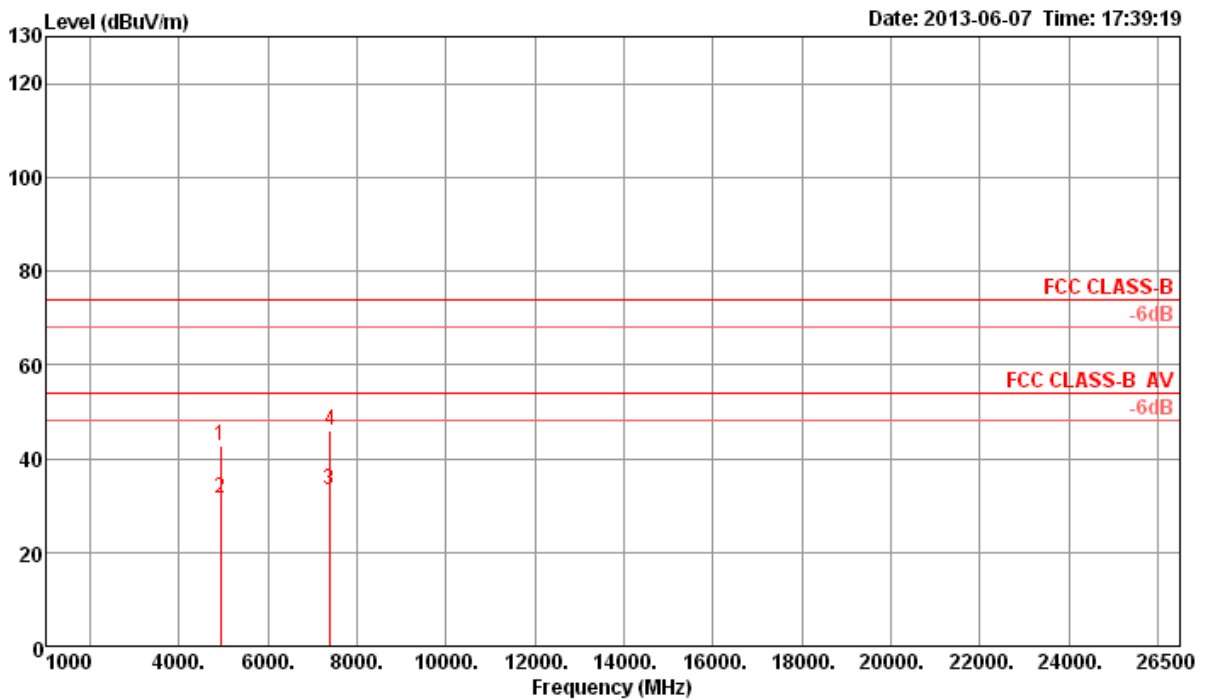

	Freq	Level	Limit	Over	Read	Cable	Antenna	Preamp	Remark	A/Pos	T/Pos	Pol/Phase
	MHz	dBuV/m	dBuV/m	dB	dBuV	dB	dB/m	dB		cm	deg	
1	4923.20	42.67	74.00	-31.33	41.07	3.35	33.26	35.01	Peak	100	47	VERTICAL
2	4924.26	31.35	54.00	-22.65	29.75	3.35	33.26	35.01	Average	100	47	VERTICAL
3	7383.44	33.28	54.00	-20.72	28.53	4.06	36.09	35.40	Average	100	173	VERTICAL
4	7395.90	46.16	74.00	-27.84	41.37	4.06	36.13	35.40	Peak	100	173	VERTICAL

Note 1: The amplitude of spurious emissions which are attenuated by more than 20 dB below the permissible value has no need to be reported.

Note 2: Emission level (dBuV/m) = 20 log Emission level (uV/m).

Note 3: Corrected Reading: Antenna Factor + Cable Loss + Read Level - Preamp Factor = Level.

Note 4: Measurement receive antenna polarization: H (Horizontal), V (Vertical)

Transmitter Radiated Emissions (1GHz~10th Harmonic)					
Operating Mode	IEEE 802.11n MCS0 20MHz CH 1 / Ant. 1			Polarization	H
Temperature	25.6°C	Humidity	56%	Test Engineer	Jim Huang

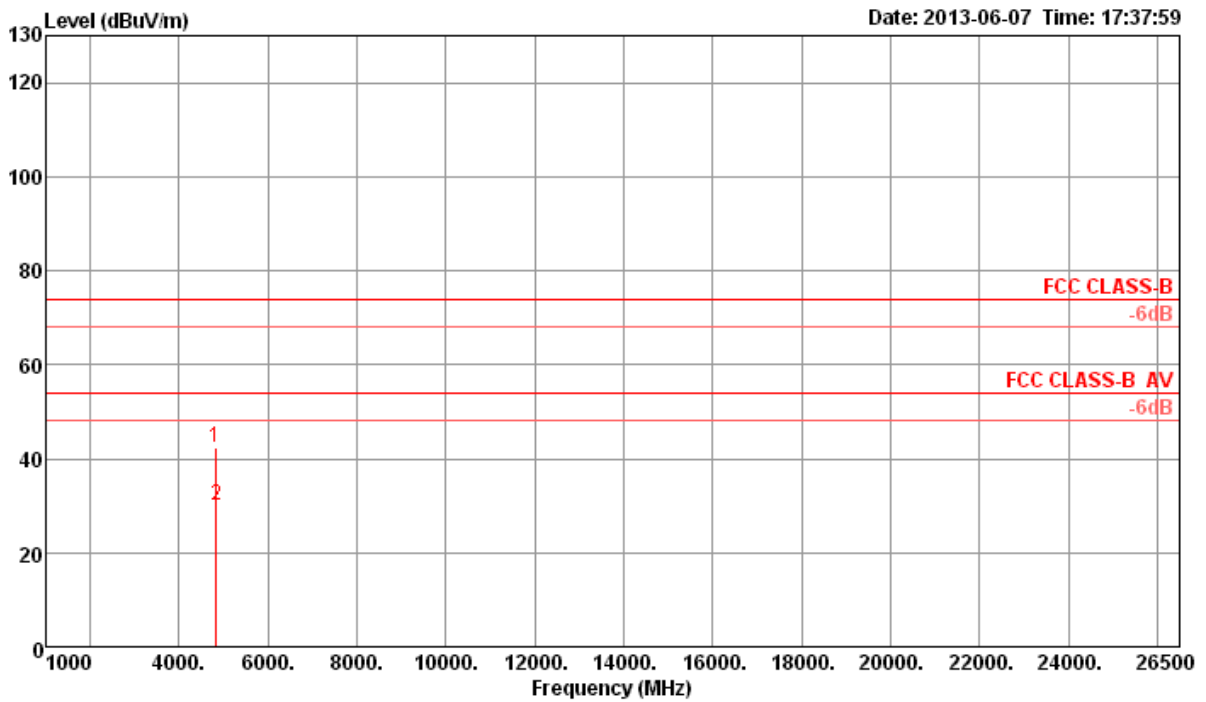

	Freq	Level	Limit Line	Over Limit	Read Level	Cable Loss	Antenna Factor	Preamp Factor	Remark	A/Pos	T/Pos	Pol/Phase
	MHz	dBuV/m	dBuV/m	dB	dBuV	dB	dB/m	dB		cm	deg	
1	4822.27	42.21	74.00	-31.79	40.87	3.31	33.06	35.03	Peak	100	198	HORIZONTAL
2	4829.87	29.88	54.00	-24.12	28.54	3.31	33.06	35.03	Average	100	198	HORIZONTAL

Note 1: The amplitude of spurious emissions which are attenuated by more than 20 dB below the permissible value has no need to be reported.  
 Note 2: Emission level (dBuV/m) = 20 log Emission level (uV/m).  
 Note 3: Corrected Reading: Antenna Factor + Cable Loss + Read Level - Preamp Factor = Level.  
 Note 4: Measurement receive antenna polarization: H (Horizontal), V (Vertical)

Transmitter Radiated Emissions (1GHz~10th Harmonic)					
Operating Mode	IEEE 802.11n MCS0 20MHz CH 1 / Ant. 1			Polarization	V
Temperature	25.6°C	Humidity	56%	Test Engineer	Jim Huang

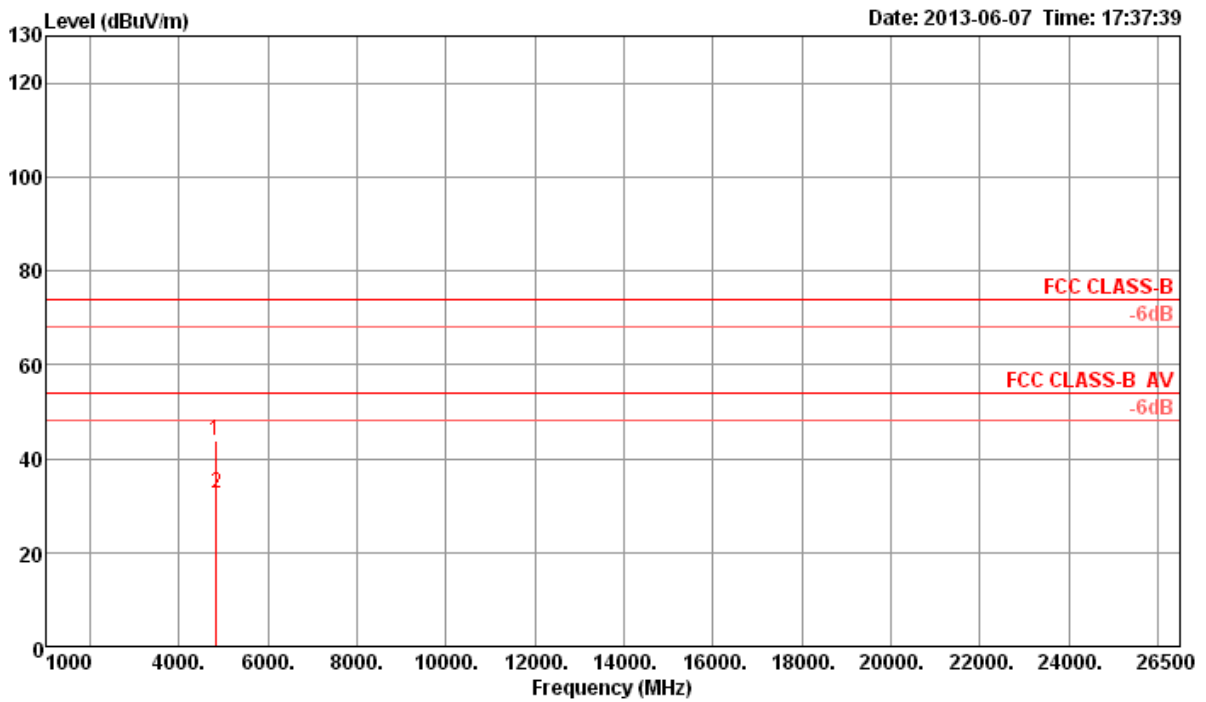

	Freq	Level	Limit	Over	Read	Cable	Antenna	Preamp	Remark	A/Pos	T/Pos	Pol/Phase
	MHz	dBuV/m	dBuV/m	dB	dBuV	dB	dB/m	dB		cm	deg	
1	4816.40	43.99	74.00	-30.01	42.70	3.31	33.02	35.04	Peak	100	92	VERTICAL
2	4824.48	32.50	54.00	-21.50	31.16	3.31	33.06	35.03	Average	100	92	VERTICAL

Note 1: The amplitude of spurious emissions which are attenuated by more than 20 dB below the permissible value has no need to be reported.

Note 2: Emission level (dBuV/m) = 20 log Emission level (uV/m).

Note 3: Corrected Reading: Antenna Factor + Cable Loss + Read Level - Preamp Factor = Level.

Note 4: Measurement receive antenna polarization: H (Horizontal), V (Vertical)



Transmitter Radiated Emissions (1GHz~10th Harmonic)					
Operating Mode	IEEE 802.11n MCS0 20MHz CH 6 / Ant. 1			Polarization	H
Temperature	25.6°C	Humidity	56%	Test Engineer	Jim Huang

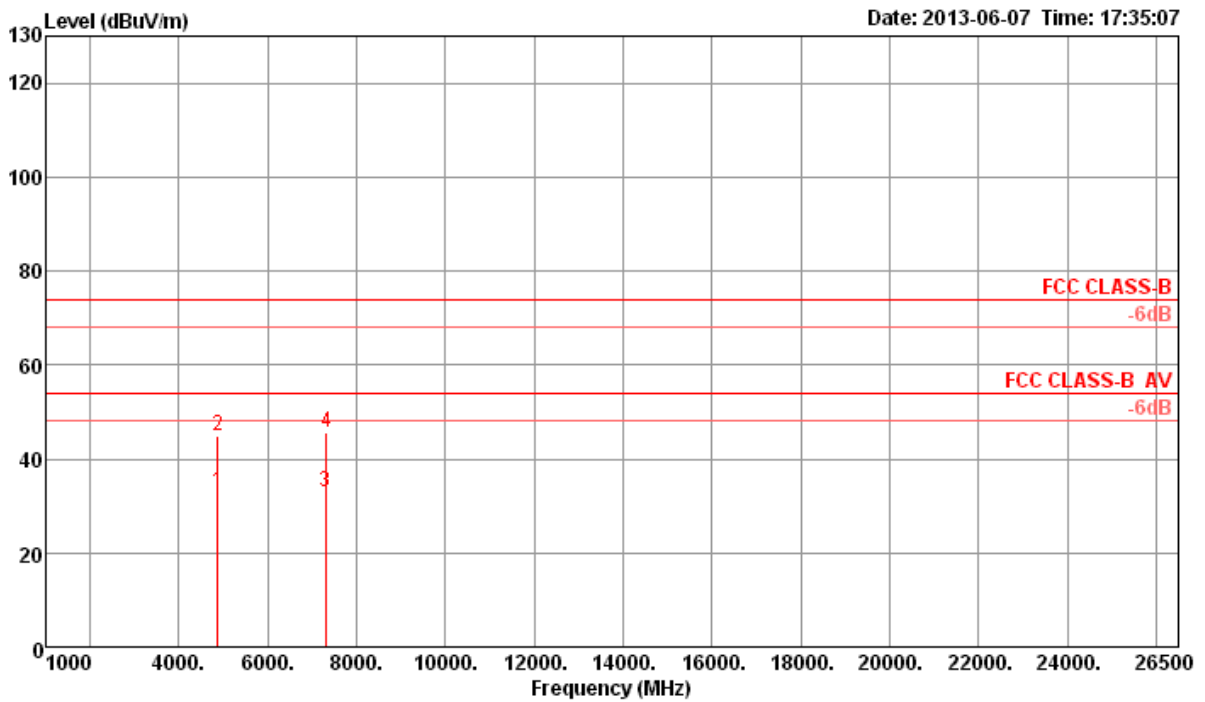

	Freq	Level	Limit	Over	Read	Cable	Antenna	Preamp	Remark	A/Pos	T/Pos	Pol/Phase
	MHz	dBuV/m	dBuV/m	dB	dBuV	dB	dB/m	dB		cm	deg	
1	4874.13	32.93	54.00	-21.07	31.47	3.33	33.16	35.03	Average	100	140	HORIZONTAL
2	4878.07	44.83	74.00	-29.17	43.37	3.33	33.16	35.03	Peak	100	140	HORIZONTAL
3	7306.58	33.12	54.00	-20.88	28.54	4.06	35.92	35.40	Average	100	290	HORIZONTAL
4	7314.88	45.67	74.00	-28.33	41.05	4.06	35.96	35.40	Peak	100	290	HORIZONTAL

Note 1: The amplitude of spurious emissions which are attenuated by more than 20 dB below the permissible value has no need to be reported.

Note 2: Emission level (dBuV/m) = 20 log Emission level (uV/m).

Note 3: Corrected Reading: Antenna Factor + Cable Loss + Read Level - Preamp Factor = Level.

Note 4: Measurement receive antenna polarization: H (Horizontal), V (Vertical)

Transmitter Radiated Emissions (1GHz~10th Harmonic)					
Operating Mode	IEEE 802.11n MCS0 20MHz CH 6 / Ant. 1			Polarization	V
Temperature	25.6°C	Humidity	56%	Test Engineer	Jim Huang

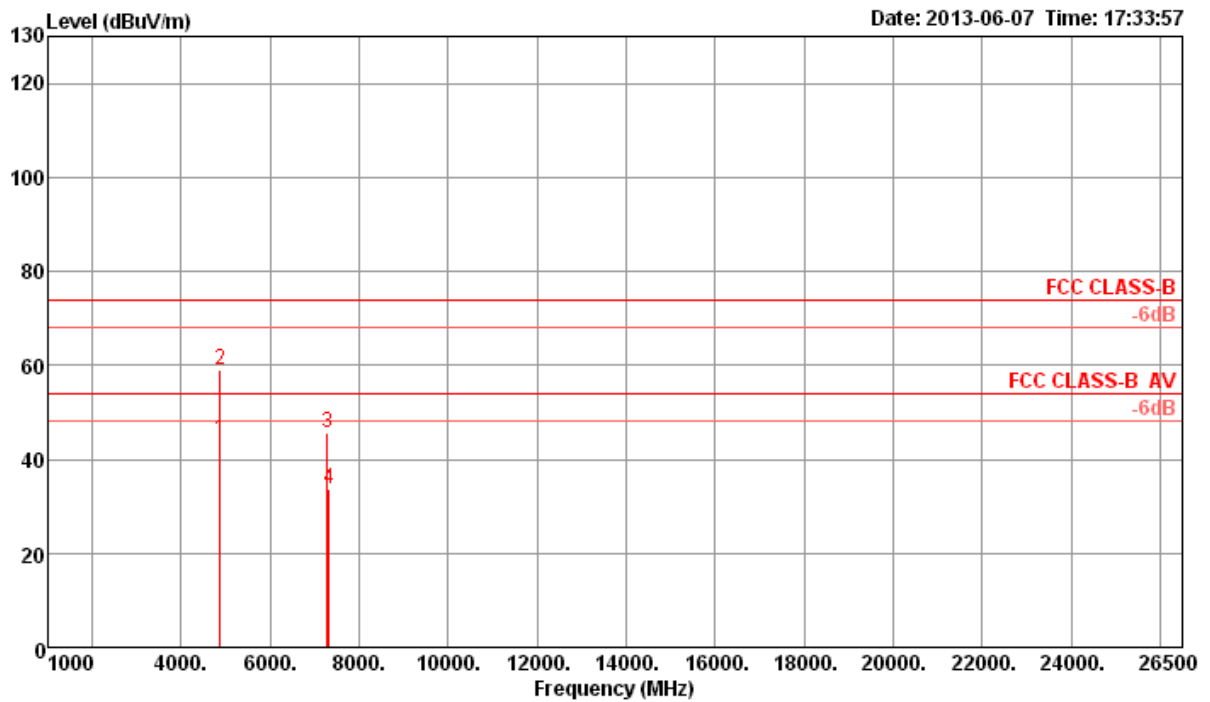

	Freq	Level	Limit	Over	Read	Cable	Antenna	Preamp	Remark	A/Pos	T/Pos	Pol/Phase
	MHz	dBuV/m	dBuV/m	dB	dBuV	dB	dB/m	dB		cm	deg	
1	4874.40	44.07	54.00	-9.93	42.61	3.33	33.16	35.03	Average	171	78	VERTICAL
2	4877.21	59.07	74.00	-14.93	57.61	3.33	33.16	35.03	Peak	171	78	VERTICAL
3	7286.64	45.75	74.00	-28.25	41.20	4.06	35.89	35.40	Peak	100	185	VERTICAL
4	7309.96	33.74	54.00	-20.26	29.12	4.06	35.96	35.40	Average	100	185	VERTICAL

Note 1: The amplitude of spurious emissions which are attenuated by more than 20 dB below the permissible value has no need to be reported.

Note 2: Emission level (dBuV/m) = 20 log Emission level (uV/m).

Note 3: Corrected Reading: Antenna Factor + Cable Loss + Read Level - Preamp Factor = Level.

Note 4: Measurement receive antenna polarization: H (Horizontal), V (Vertical)

Transmitter Radiated Emissions (1GHz~10th Harmonic)					
Operating Mode	IEEE 802.11n MCS0 20MHz CH 11 / Ant. 1			Polarization	H
Temperature	25.6°C	Humidity	56%	Test Engineer	Jim Huang

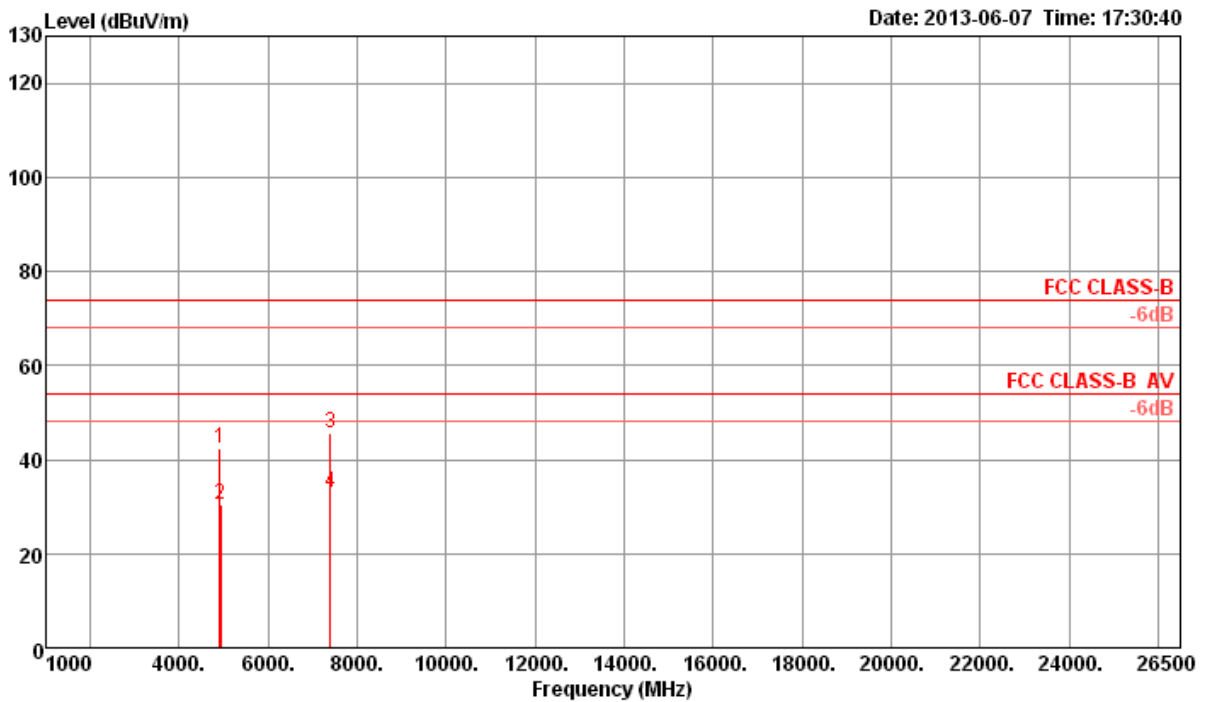

	Freq	Level	Limit	Over	Read	Cable	Antenna	Preamp	Remark	A/Pos	T/Pos	Pol/Phase
	MHz	dBuV/m	dBuV/m	dB	dBuV	dB	dB/m	dB		cm	deg	
1	4916.92	42.25	74.00	-31.75	40.69	3.35	33.23	35.02	Peak	100	178	HORIZONTAL
2	4924.35	30.35	54.00	-23.65	28.75	3.35	33.26	35.01	Average	100	178	HORIZONTAL
3	7387.92	45.69	74.00	-28.31	40.94	4.06	36.09	35.40	Peak	100	277	HORIZONTAL
4	7395.58	32.97	54.00	-21.03	28.18	4.06	36.13	35.40	Average	100	277	HORIZONTAL

Note 1: The amplitude of spurious emissions which are attenuated by more than 20 dB below the permissible value has no need to be reported.

Note 2: Emission level (dBuV/m) = 20 log Emission level (uV/m).

Note 3: Corrected Reading: Antenna Factor + Cable Loss + Read Level - Preamp Factor = Level.

Note 4: Measurement receive antenna polarization: H (Horizontal), V (Vertical)

Transmitter Radiated Emissions (1GHz~10th Harmonic)					
Operating Mode	IEEE 802.11n MCS0 20MHz CH 11 / Ant. 1			Polarization	V
Temperature	25.6°C	Humidity	56%	Test Engineer	Jim Huang

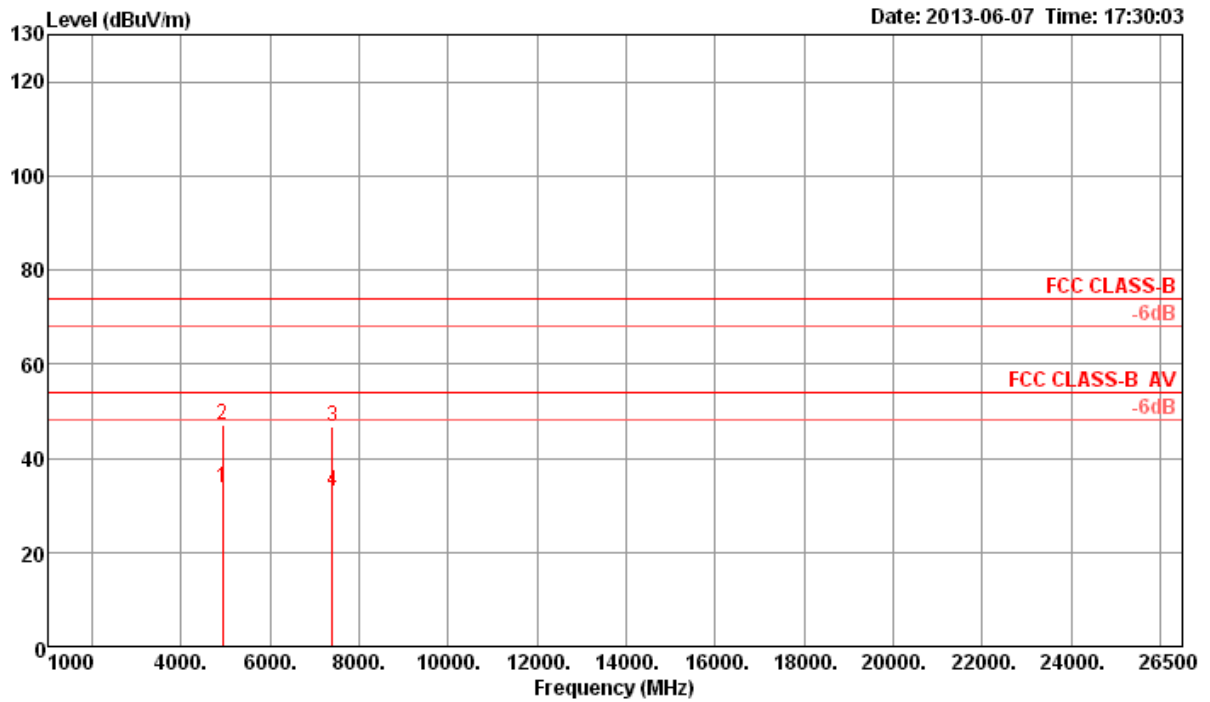

	Freq	Level	Limit Line	Over Limit	Read Level	Cable Loss	Antenna Factor	Preamp Factor	Remark	A/Pos	T/Pos	Pol/Phase
	MHz	dBuV/m	dBuV/m	dB	dBuV	dB	dB/m	dB		cm	deg	
1	4924.51	33.59	54.00	-20.41	31.99	3.35	33.26	35.01	Average	100	76	VERTICAL
2	4927.30	47.13	74.00	-26.87	45.53	3.35	33.26	35.01	Peak	100	76	VERTICAL
3	7389.62	46.56	74.00	-27.44	41.81	4.06	36.09	35.40	Peak	100	166	VERTICAL
4	7390.74	33.05	54.00	-20.95	28.30	4.06	36.09	35.40	Average	100	166	VERTICAL

Note 1: The amplitude of spurious emissions which are attenuated by more than 20 dB below the permissible value has no need to be reported.

Note 2: Emission level (dBuV/m) = 20 log Emission level (uV/m).

Note 3: Corrected Reading: Antenna Factor + Cable Loss + Read Level - Preamp Factor = Level.

Note 4: Measurement receive antenna polarization: H (Horizontal), V (Vertical)

Transmitter Radiated Emissions (1GHz~10th Harmonic)					
Operating Mode	IEEE 802.11n MCS0 20MHz CH 1 / Ant. 2			Polarization	H
Temperature	25.6°C	Humidity	56%	Test Engineer	Jim Huang

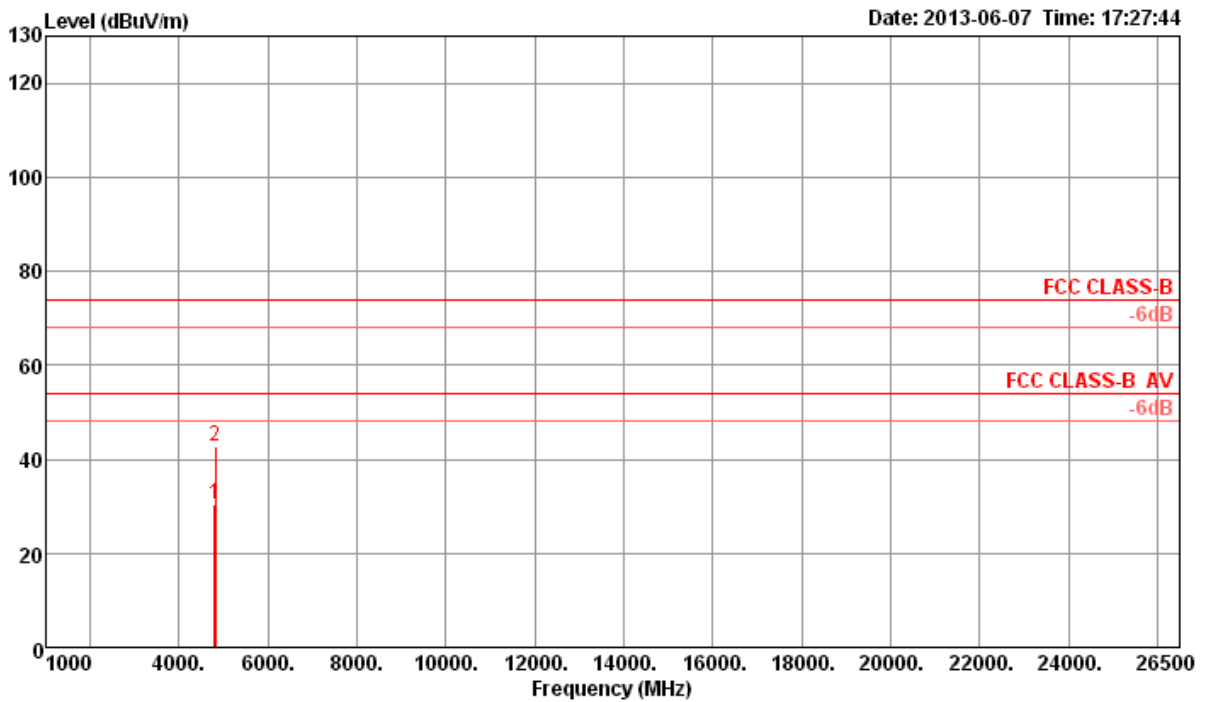

	Freq	Level	Limit	Over	Read	Cable	Antenna	Preamp	Remark	A/Pos	T/Pos	Pol/Phase
	MHz	dBuV/m	dBuV/m	dB	dBuV	dB	dB/m	dB		cm	deg	
1	4800.12	30.37	54.00	-23.63	29.13	3.29	32.99	35.04	Average	100	256	HORIZONTAL
2	4818.71	42.59	74.00	-31.41	41.29	3.31	33.02	35.03	Peak	100	256	HORIZONTAL

Note 1: The amplitude of spurious emissions which are attenuated by more than 20 dB below the permissible value has no need to be reported.

Note 2: Emission level (dBuV/m) = 20 log Emission level (uV/m).

Note 3: Corrected Reading: Antenna Factor + Cable Loss + Read Level - Preamp Factor = Level.

Note 4: Measurement receive antenna polarization: H (Horizontal), V (Vertical)

Transmitter Radiated Emissions (1GHz~10th Harmonic)					
Operating Mode	IEEE 802.11n MCS0 20MHz CH 1 / Ant. 2			Polarization	V
Temperature	25.6°C	Humidity	56%	Test Engineer	Jim Huang

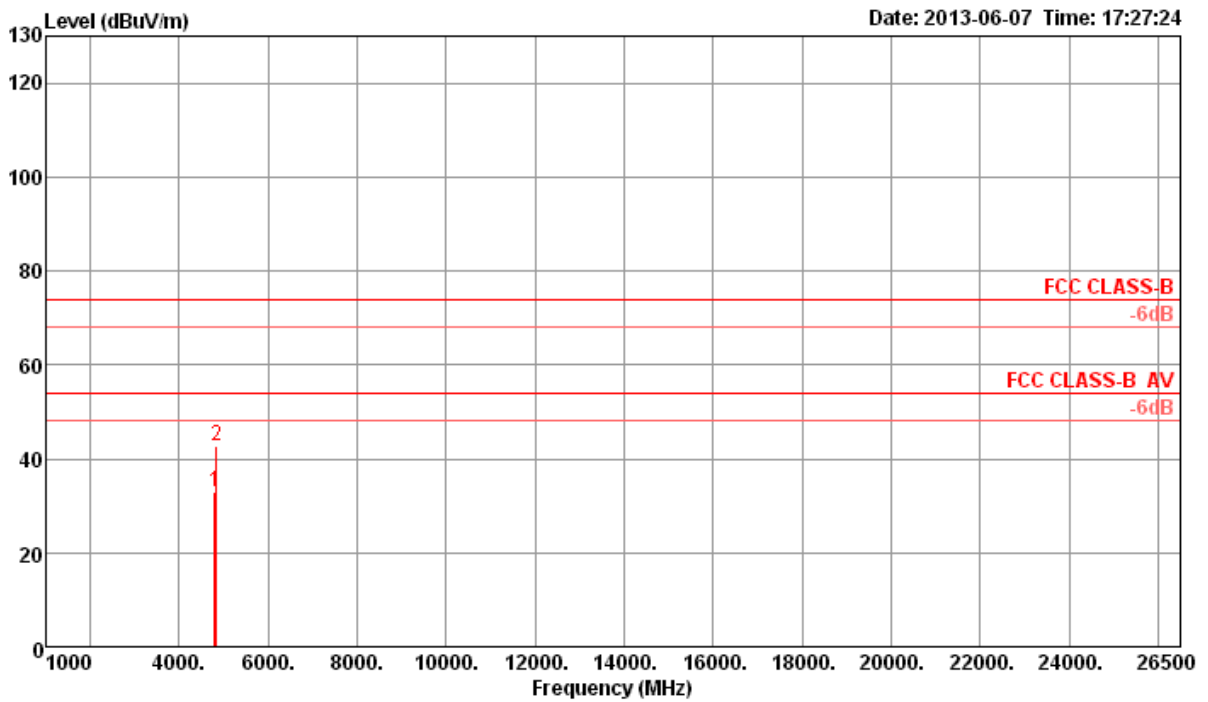

	Freq	Level	Limit	Over	Read	Cable	Antenna	Preamp	Remark	A/Pos	T/Pos	Pol/Phase
	MHz	dBuV/m	dBuV/m	dB	dBuV	dB	dB/m	dB		cm	deg	
1	4800.12	32.82	54.00	-21.18	31.58	3.29	32.99	35.04	Average	100	157	VERTICAL
2	4840.99	42.68	74.00	-31.32	41.30	3.32	33.09	35.03	Peak	100	157	VERTICAL

Note 1: The amplitude of spurious emissions which are attenuated by more than 20 dB below the permissible value has no need to be reported.

Note 2: Emission level (dBuV/m) = 20 log Emission level (uV/m).

Note 3: Corrected Reading: Antenna Factor + Cable Loss + Read Level - Preamp Factor = Level.

Note 4: Measurement receive antenna polarization: H (Horizontal), V (Vertical)

Transmitter Radiated Emissions (1GHz~10th Harmonic)					
Operating Mode	IEEE 802.11n MCS0 20MHz CH 6 / Ant. 2			Polarization	H
Temperature	25.6°C	Humidity	56%	Test Engineer	Jim Huang

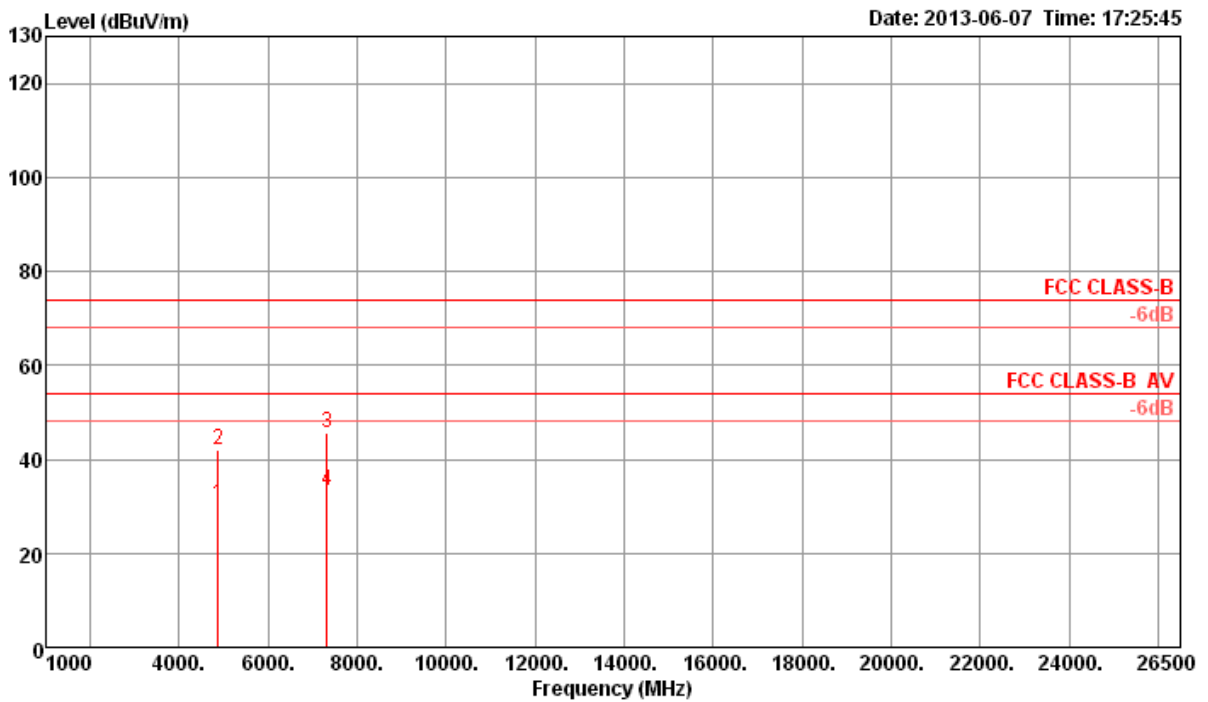

	Freq	Level	Limit	Over	Read	Cable	Antenna	Preamp	Remark	A/Pos	T/Pos	Pol/Phase
	MHz	dBuV/m	dBuV/m	dB	dBuV	dB	dB/m	dB		cm	deg	
1	4874.56	30.36	54.00	-23.64	28.90	3.33	33.16	35.03	Average	100	287	HORIZONTAL
2	4879.05	41.98	74.00	-32.02	40.52	3.33	33.16	35.03	Peak	100	287	HORIZONTAL
3	7309.48	45.81	74.00	-28.19	41.19	4.06	35.96	35.40	Peak	100	119	HORIZONTAL
4	7310.84	33.28	54.00	-20.72	28.66	4.06	35.96	35.40	Average	100	119	HORIZONTAL

Note 1: The amplitude of spurious emissions which are attenuated by more than 20 dB below the permissible value has no need to be reported.  
 Note 2: Emission level (dBuV/m) = 20 log Emission level (uV/m).  
 Note 3: Corrected Reading: Antenna Factor + Cable Loss + Read Level - Preamp Factor = Level.  
 Note 4: Measurement receive antenna polarization: H (Horizontal), V (Vertical)

Transmitter Radiated Emissions (1GHz~10th Harmonic)					
Operating Mode	IEEE 802.11n MCS0 20MHz CH 6 / Ant. 2			Polarization	V
Temperature	25.6°C	Humidity	56%	Test Engineer	Jim Huang

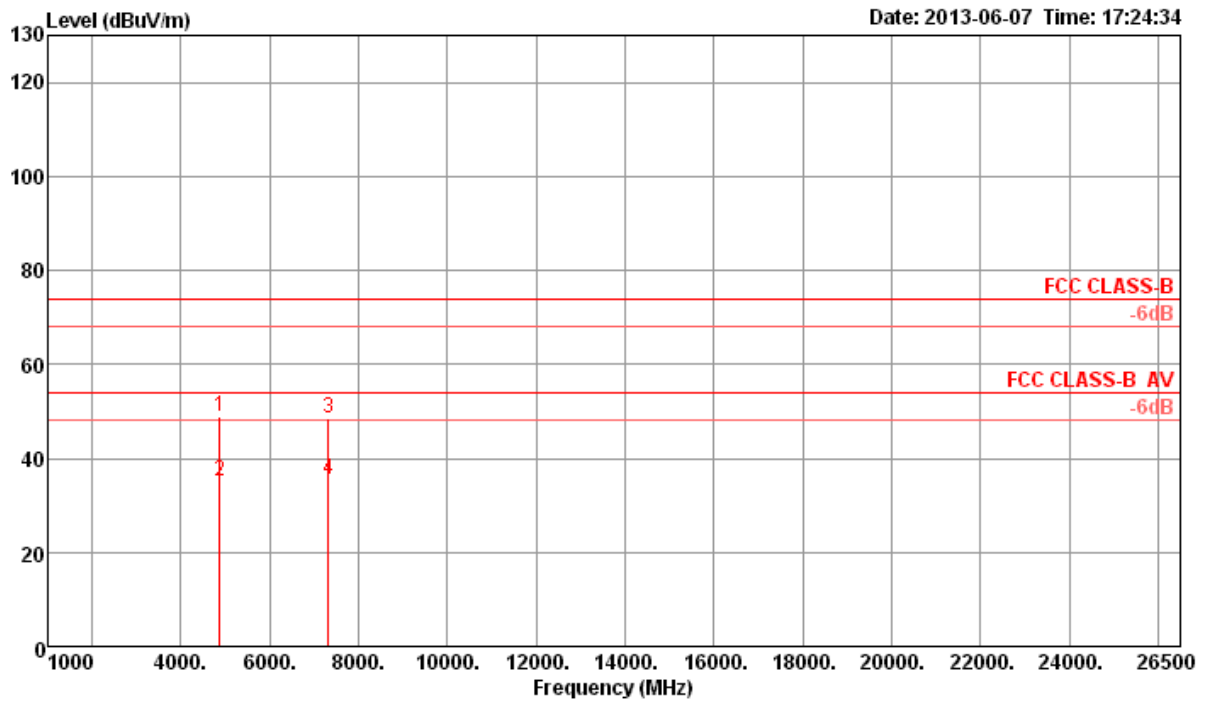

	Freq	Level	Limit	Over	Read	Cable	Antenna	Preamp	Remark	A/Pos	T/Pos	Pol/Phase
	MHz	dBuV/m	dBuV/m	dB	dBuV	dB	dB/m	dB		cm	deg	
1	4873.92	49.02	74.00	-24.98	47.56	3.33	33.16	35.03	Peak	101	358	VERTICAL
2	4874.40	34.95	54.00	-19.05	33.49	3.33	33.16	35.03	Average	101	358	VERTICAL
3	7308.44	48.41	74.00	-25.59	43.79	4.06	35.96	35.40	Peak	100	28	VERTICAL
4	7310.12	35.37	54.00	-18.63	30.75	4.06	35.96	35.40	Average	100	28	VERTICAL

Note 1: The amplitude of spurious emissions which are attenuated by more than 20 dB below the permissible value has no need to be reported.

Note 2: Emission level (dBuV/m) = 20 log Emission level (uV/m).

Note 3: Corrected Reading: Antenna Factor + Cable Loss + Read Level - Preamp Factor = Level.

Note 4: Measurement receive antenna polarization: H (Horizontal), V (Vertical)



Transmitter Radiated Emissions (1GHz~10th Harmonic)					
Operating Mode	IEEE 802.11n MCS0 20MHz CH 11 / Ant. 2			Polarization	H
Temperature	25.6°C	Humidity	56%	Test Engineer	Jim Huang

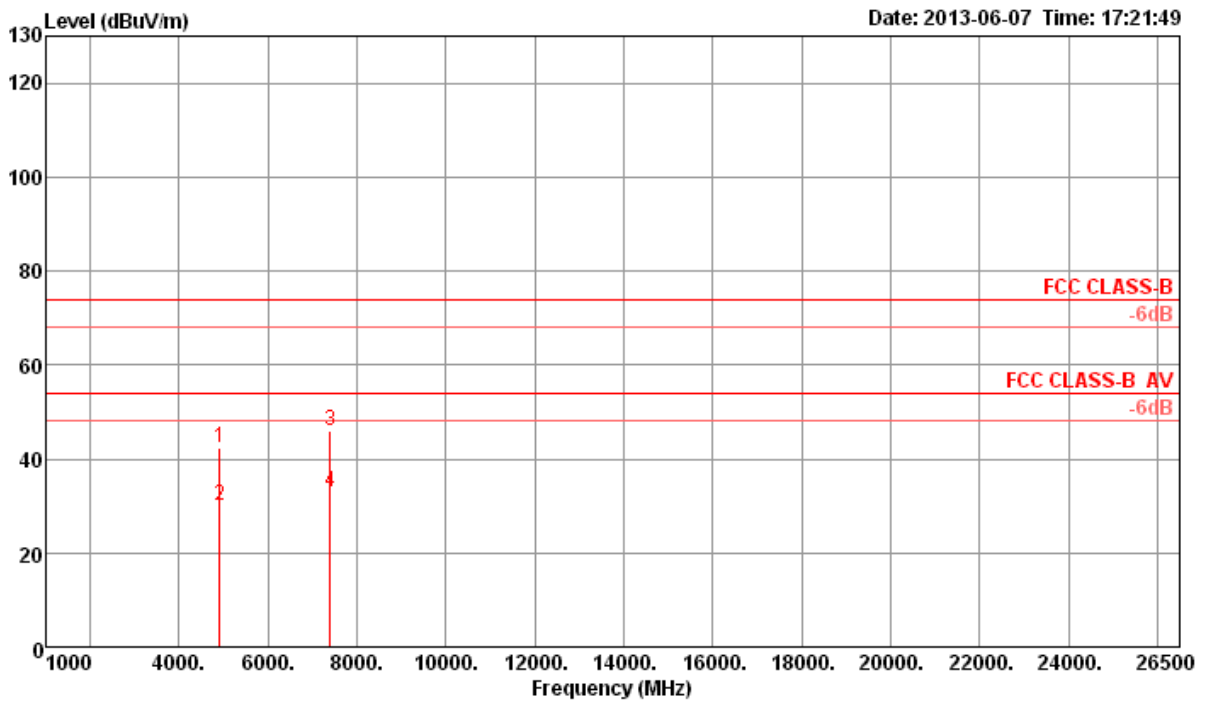

	Freq	Level	Limit	Over	Read	Cable	Antenna	Preamp	Remark	A/Pos	T/Pos	Pol/Phase
	MHz	dBuV/m	dBuV/m	dB	dBuV	dB	dB/m	dB		cm	deg	
1	4914.13	42.49	74.00	-31.51	40.94	3.34	33.23	35.02	Peak	100	196	HORIZONTAL
2	4917.62	30.08	54.00	-23.92	28.52	3.35	33.23	35.02	Average	100	196	HORIZONTAL
3	7387.96	45.92	74.00	-28.08	41.17	4.06	36.09	35.40	Peak	100	331	HORIZONTAL
4	7394.49	33.08	54.00	-20.92	28.29	4.06	36.13	35.40	Average	100	331	HORIZONTAL

Note 1: The amplitude of spurious emissions which are attenuated by more than 20 dB below the permissible value has no need to be reported.  
 Note 2: Emission level (dBuV/m) = 20 log Emission level (uV/m).  
 Note 3: Corrected Reading: Antenna Factor + Cable Loss + Read Level - Preamp Factor = Level.  
 Note 4: Measurement receive antenna polarization: H (Horizontal), V (Vertical)

Transmitter Radiated Emissions (1GHz~10th Harmonic)					
Operating Mode	IEEE 802.11n MCS0 20MHz CH 11 / Ant. 2			Polarization	V
Temperature	25.6°C	Humidity	56%	Test Engineer	Jim Huang

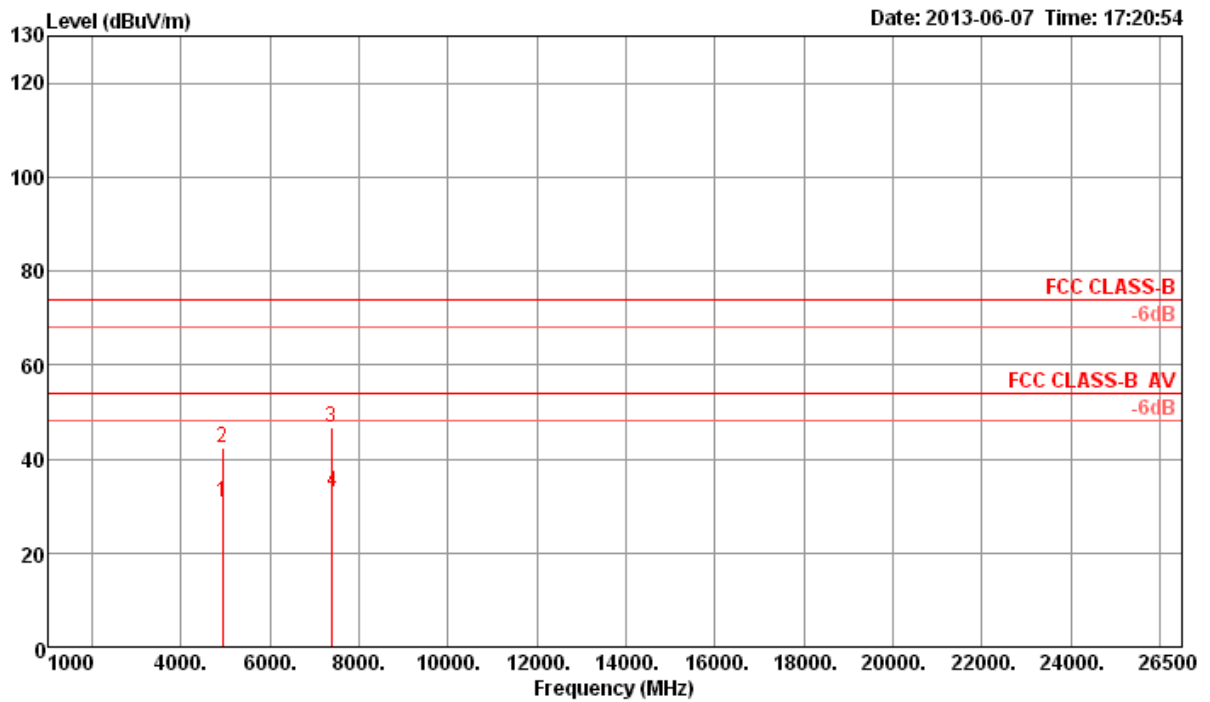

	Freq	Level	Limit Line	Over Limit	Read Level	Cable Loss	Antenna Factor	Preamp Factor	Remark	A/Pos	T/Pos	Pol/Phase
	MHz	dBuV/m	dBuV/m	dB	dBuV	dB	dB/m	dB		cm	deg	
1	4924.71	30.69	54.00	-23.31	29.09	3.35	33.26	35.01	Average	100	122	VERTICAL
2	4928.36	42.54	74.00	-31.46	40.94	3.35	33.26	35.01	Peak	100	122	VERTICAL
3	7378.21	46.64	74.00	-27.36	41.89	4.06	36.09	35.40	Peak	100	197	VERTICAL
4	7388.24	33.04	54.00	-20.96	28.29	4.06	36.09	35.40	Average	100	197	VERTICAL

Note 1: The amplitude of spurious emissions which are attenuated by more than 20 dB below the permissible value has no need to be reported.

Note 2: Emission level (dBuV/m) = 20 log Emission level (uV/m).

Note 3: Corrected Reading: Antenna Factor + Cable Loss + Read Level - Preamp Factor = Level.

Note 4: Measurement receive antenna polarization: H (Horizontal), V (Vertical)

Transmitter Radiated Emissions (1GHz~10th Harmonic)					
Operating Mode	IEEE 802.11n MCS8 20MHz CH 1 / Ant. 1 + Ant. 2			Polarization	H
Temperature	25.6°C	Humidity	56%	Test Engineer	Jim Huang

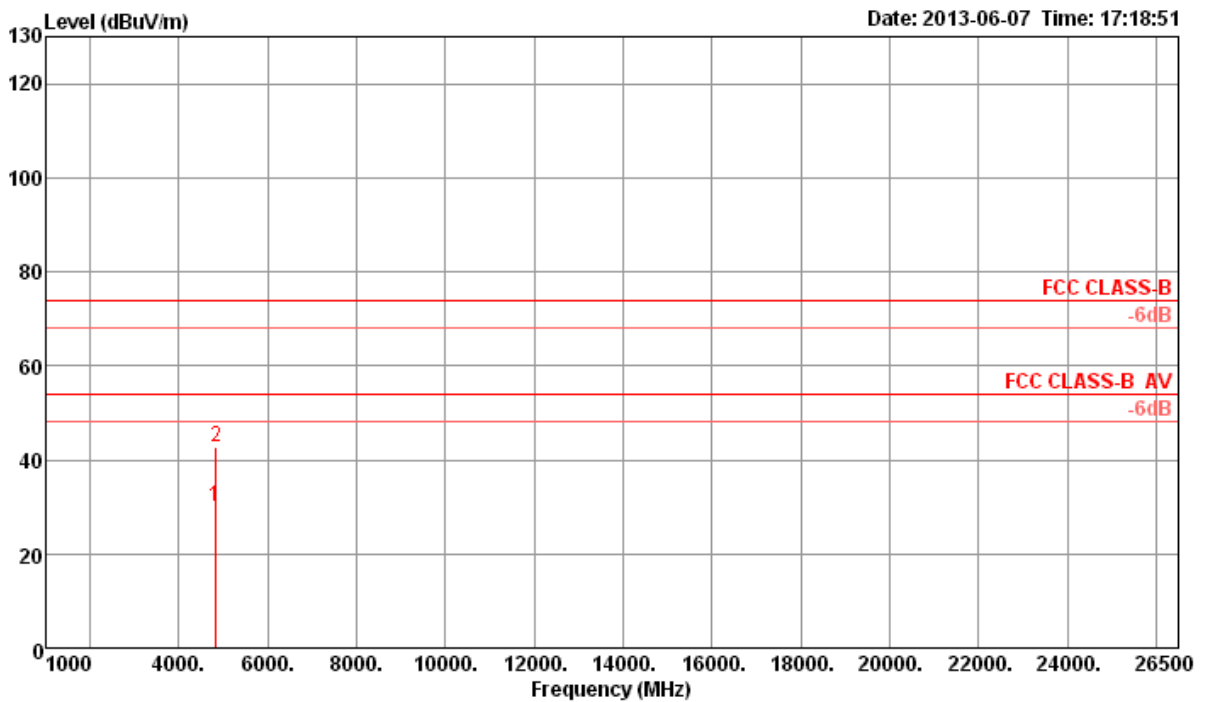

	Freq	Level	Limit	Over	Read	Cable	Antenna	Preamp	Remark	A/Pos	T/Pos	Pol/Phase
	MHz	dBuV/m	dBuV/m	dB	dBuV	dB	dB/m	dB		cm	deg	
1	4818.26	30.02	54.00	-23.98	28.72	3.31	33.02	35.03	Average	100	226	HORIZONTAL
2	4826.44	42.60	74.00	-31.40	41.26	3.31	33.06	35.03	Peak	100	226	HORIZONTAL

Note 1: The amplitude of spurious emissions which are attenuated by more than 20 dB below the permissible value has no need to be reported.

Note 2: Emission level (dBuV/m) = 20 log Emission level (uV/m).

Note 3: Corrected Reading: Antenna Factor + Cable Loss + Read Level - Preamp Factor = Level.

Note 4: Measurement receive antenna polarization: H (Horizontal), V (Vertical)

Transmitter Radiated Emissions (1GHz~10th Harmonic)					
Operating Mode	IEEE 802.11n MCS8 20MHz CH 1 / Ant. 1 + Ant. 2			Polarization	V
Temperature	25.6°C	Humidity	56%	Test Engineer	Jim Huang

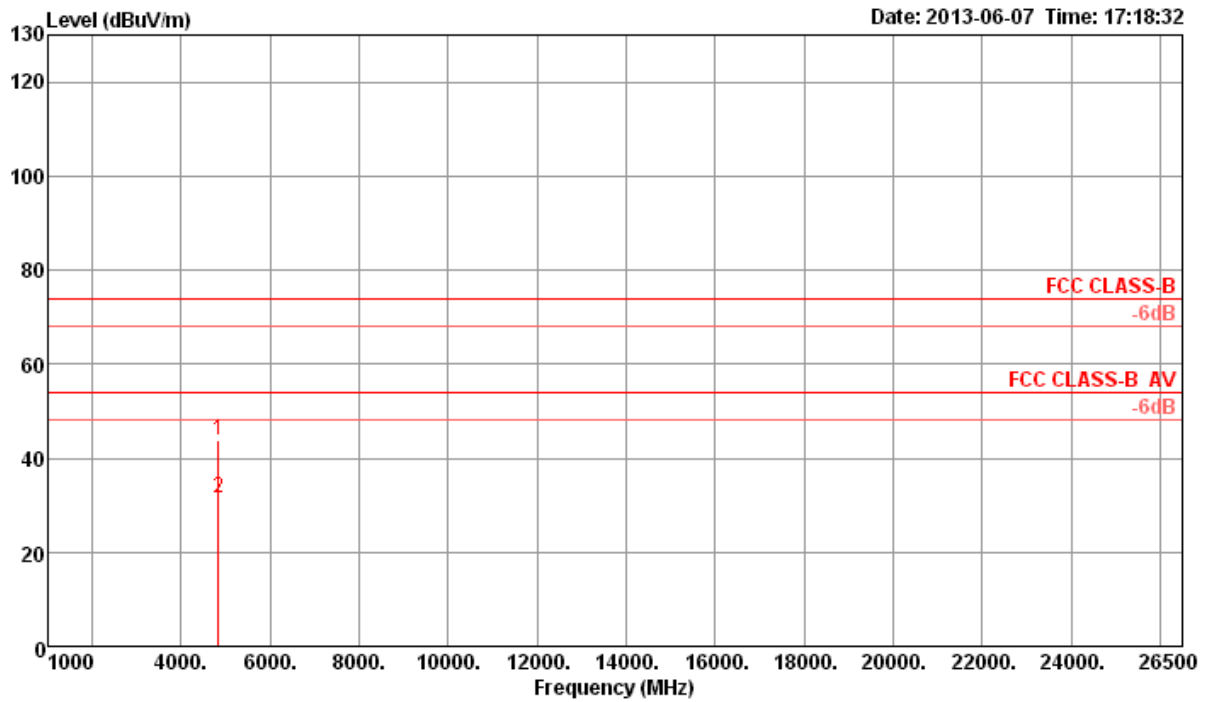

	Freq	Level	Limit	Over	Read	Cable	Antenna	Preamp	Remark	A/Pos	T/Pos	Pol/Phase
	MHz	dBuV/m	dBuV/m	dB	dBuV	dB	dB/m	dB		cm	deg	
1	4824.10	43.73	74.00	-30.27	42.39	3.31	33.06	35.03	Peak	100	340	VERTICAL
2	4828.84	31.60	54.00	-22.40	30.26	3.31	33.06	35.03	Average	100	340	VERTICAL

Note 1: The amplitude of spurious emissions which are attenuated by more than 20 dB below the permissible value has no need to be reported.

Note 2: Emission level (dBuV/m) = 20 log Emission level (uV/m).

Note 3: Corrected Reading: Antenna Factor + Cable Loss + Read Level - Preamp Factor = Level.

Note 4: Measurement receive antenna polarization: H (Horizontal), V (Vertical)

Transmitter Radiated Emissions (1GHz~10th Harmonic)					
Operating Mode	IEEE 802.11n MCS8 20MHz CH 6 / Ant. 1 + Ant. 2			Polarization	H
Temperature	25.6°C	Humidity	56%	Test Engineer	Jim Huang

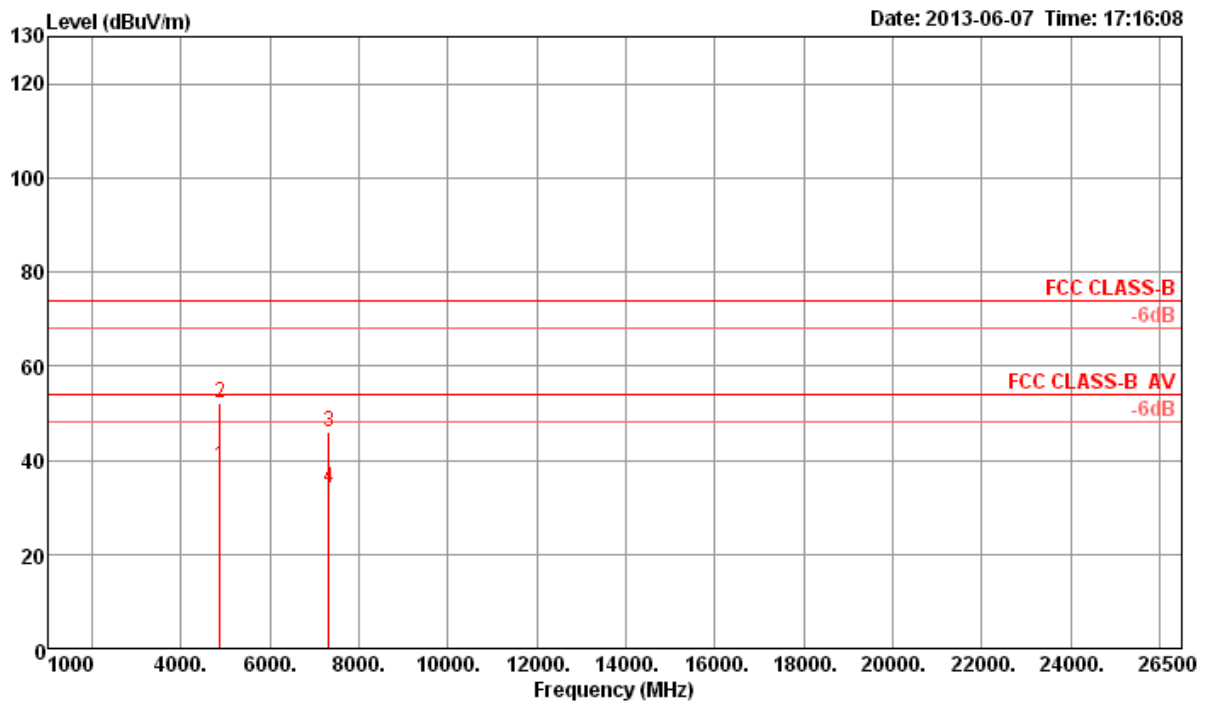

	Freq	Level	Limit	Over	Read	Cable	Antenna	Preamp	Remark	A/Pos	T/Pos	Pol/Phase
	MHz	dBuV/m	dBuV/m	dB	dBuV	dB	dB/m	dB		cm	deg	
1	4875.64	38.61	54.00	-15.39	37.15	3.33	33.16	35.03	Average	186	36	HORIZONTAL
2	4878.14	52.27	74.00	-21.73	50.81	3.33	33.16	35.03	Peak	186	36	HORIZONTAL
3	7309.85	46.15	74.00	-27.85	41.53	4.06	35.96	35.40	Peak	100	242	HORIZONTAL
4	7315.78	33.95	54.00	-20.05	29.33	4.06	35.96	35.40	Average	100	242	HORIZONTAL

Note 1: The amplitude of spurious emissions which are attenuated by more than 20 dB below the permissible value has no need to be reported.

Note 2: Emission level (dBuV/m) = 20 log Emission level (uV/m).

Note 3: Corrected Reading: Antenna Factor + Cable Loss + Read Level - Preamp Factor = Level.

Note 4: Measurement receive antenna polarization: H (Horizontal), V (Vertical)

Transmitter Radiated Emissions (1GHz~10th Harmonic)					
Operating Mode	IEEE 802.11n MCS8 20MHz CH 6 / Ant. 1 + Ant. 2			Polarization	V
Temperature	25.6°C	Humidity	56%	Test Engineer	Jim Huang

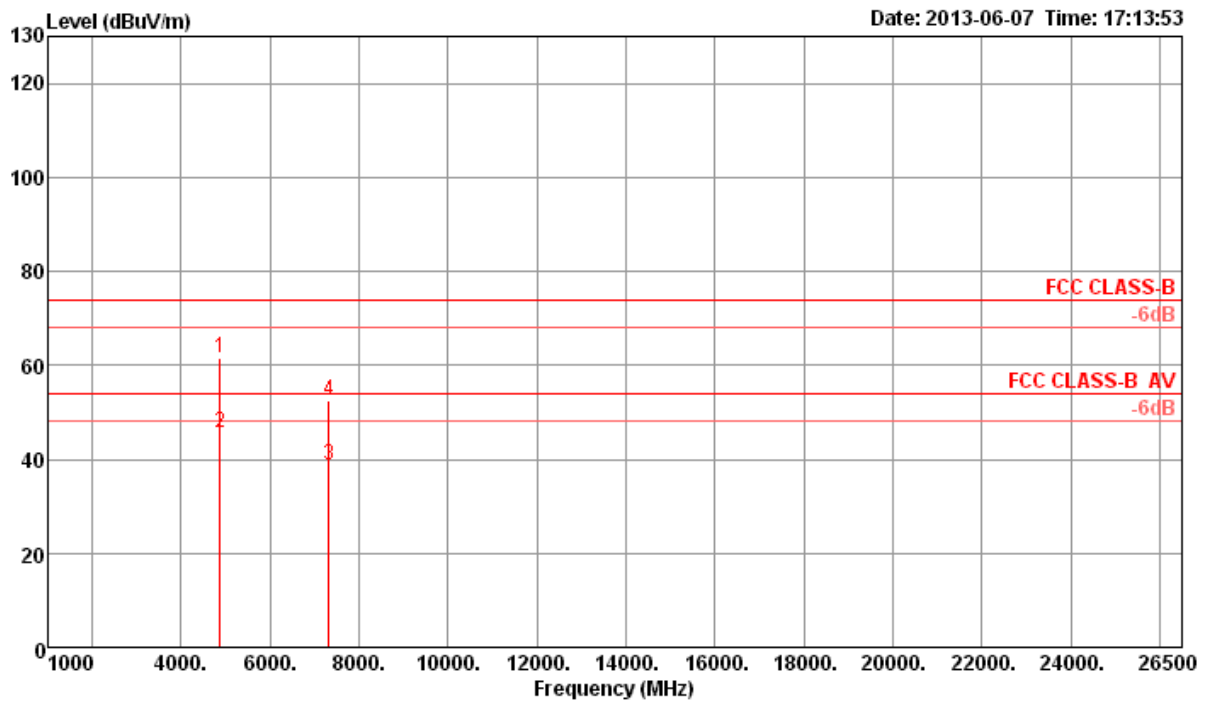

	Freq	Level	Limit	Over	Read	Cable	Antenna	Preamp	Remark	A/Pos	T/Pos	Pol/Phase
	MHz	dBuV/m	dBuV/m	dB	dBuV	dB	dB/m	dB		cm	deg	
1	4874.67	61.52	74.00	-12.48	60.06	3.33	33.16	35.03	Peak	169	79	VERTICAL
2	4874.90	45.68	54.00	-8.32	44.22	3.33	33.16	35.03	Average	169	79	VERTICAL
3	7311.26	38.70	54.00	-15.30	34.08	4.06	35.96	35.40	Average	154	271	VERTICAL
4	7315.78	52.38	74.00	-21.62	47.76	4.06	35.96	35.40	Peak	154	271	VERTICAL

Note 1: The amplitude of spurious emissions which are attenuated by more than 20 dB below the permissible value has no need to be reported.

Note 2: Emission level (dBuV/m) = 20 log Emission level (uV/m).

Note 3: Corrected Reading: Antenna Factor + Cable Loss + Read Level - Preamp Factor = Level.

Note 4: Measurement receive antenna polarization: H (Horizontal), V (Vertical)

Transmitter Radiated Emissions (1GHz~10th Harmonic)					
Operating Mode	IEEE 802.11n MCS8 20MHz CH 11 / Ant. 1 + Ant. 2			Polarization	H
Temperature	25.6°C	Humidity	56%	Test Engineer	Jim Huang

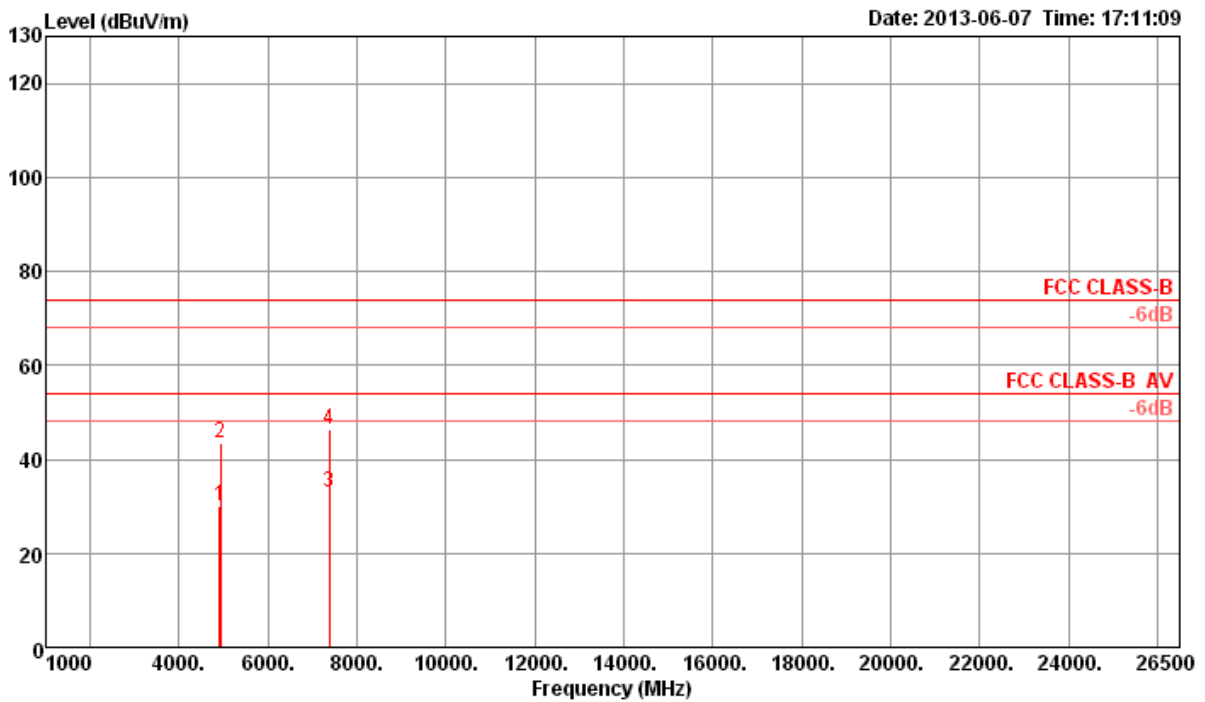

	Freq	Level	Limit	Over	Read	Cable	Antenna	Preamp	Remark	A/Pos	T/Pos	Pol/Phase
	MHz	dBuV/m	dBuV/m	dB	dBuV	dB	dB/m	dB		cm	deg	
1	4916.31	30.17	54.00	-23.83	28.61	3.35	33.23	35.02	Average	100	349	HORIZONTAL
2	4924.39	43.60	74.00	-30.40	42.00	3.35	33.26	35.01	Peak	100	349	HORIZONTAL
3	7377.25	33.00	54.00	-21.00	28.25	4.06	36.09	35.40	Average	100	298	HORIZONTAL
4	7384.37	46.29	74.00	-27.71	41.54	4.06	36.09	35.40	Peak	100	298	HORIZONTAL

Note 1: The amplitude of spurious emissions which are attenuated by more than 20 dB below the permissible value has no need to be reported.

Note 2: Emission level (dBuV/m) = 20 log Emission level (uV/m).

Note 3: Corrected Reading: Antenna Factor + Cable Loss + Read Level - Preamp Factor = Level.

Note 4: Measurement receive antenna polarization: H (Horizontal), V (Vertical)

Transmitter Radiated Emissions (1GHz~10th Harmonic)					
Operating Mode	IEEE 802.11n MCS8 20MHz CH 11 / Ant. 1 + Ant. 2			Polarization	V
Temperature	25.6°C	Humidity	56%	Test Engineer	Jim Huang

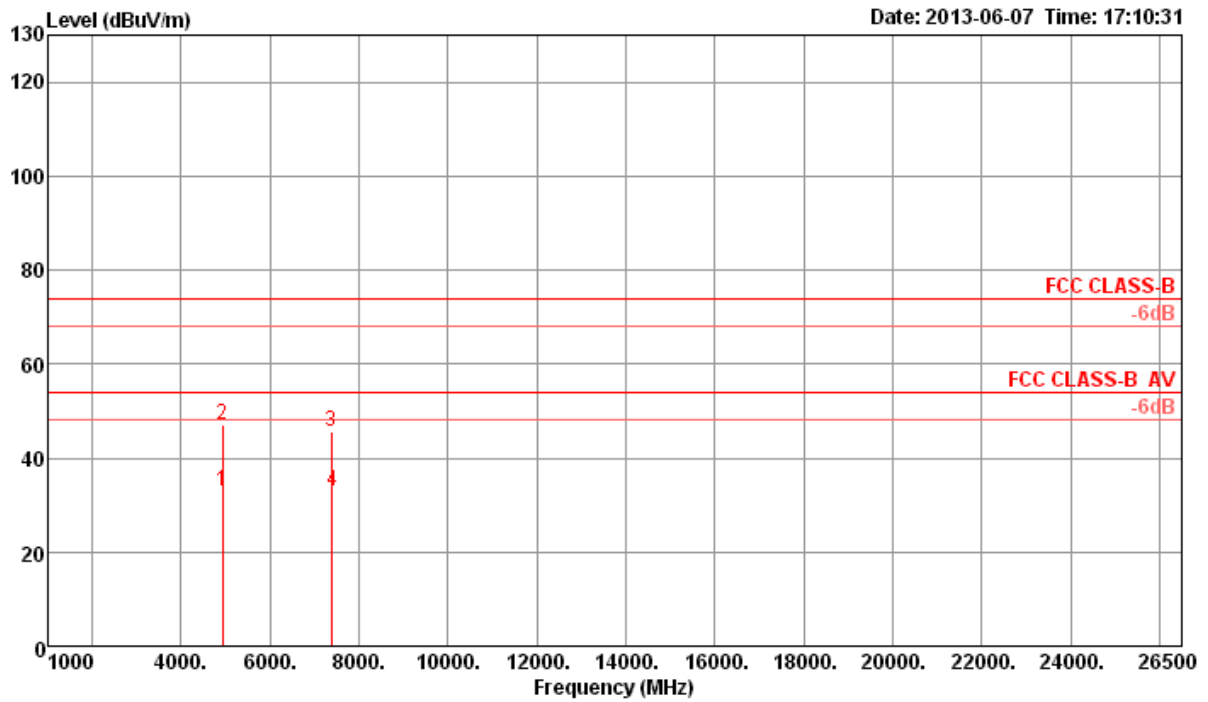

	Freq	Level	Limit	Over	Read	Cable	Antenna	Preamp	Remark	A/Pos	T/Pos	Pol/Phase
	MHz	dBuV/m	dBuV/m	dB	dBuV	dB	dB/m	dB		cm	deg	
1	4924.19	32.77	54.00	-21.23	31.17	3.35	33.26	35.01	Average	100	77	VERTICAL
2	4927.72	47.18	74.00	-26.82	45.58	3.35	33.26	35.01	Peak	100	77	VERTICAL
3	7380.90	45.75	74.00	-28.25	41.00	4.06	36.09	35.40	Peak	100	184	VERTICAL
4	7386.58	33.13	54.00	-20.87	28.38	4.06	36.09	35.40	Average	100	184	VERTICAL

Note 1: The amplitude of spurious emissions which are attenuated by more than 20 dB below the permissible value has no need to be reported.

Note 2: Emission level (dBuV/m) = 20 log Emission level (uV/m).

Note 3: Corrected Reading: Antenna Factor + Cable Loss + Read Level - Preamp Factor = Level.

Note 4: Measurement receive antenna polarization: H (Horizontal), V (Vertical)



Transmitter Radiated Emissions (1GHz~10th Harmonic)					
Operating Mode	IEEE 802.11n MCS0 40MHz CH 3 / Ant. 1			Polarization	H
Temperature	25.6°C	Humidity	56%	Test Engineer	Jim Huang

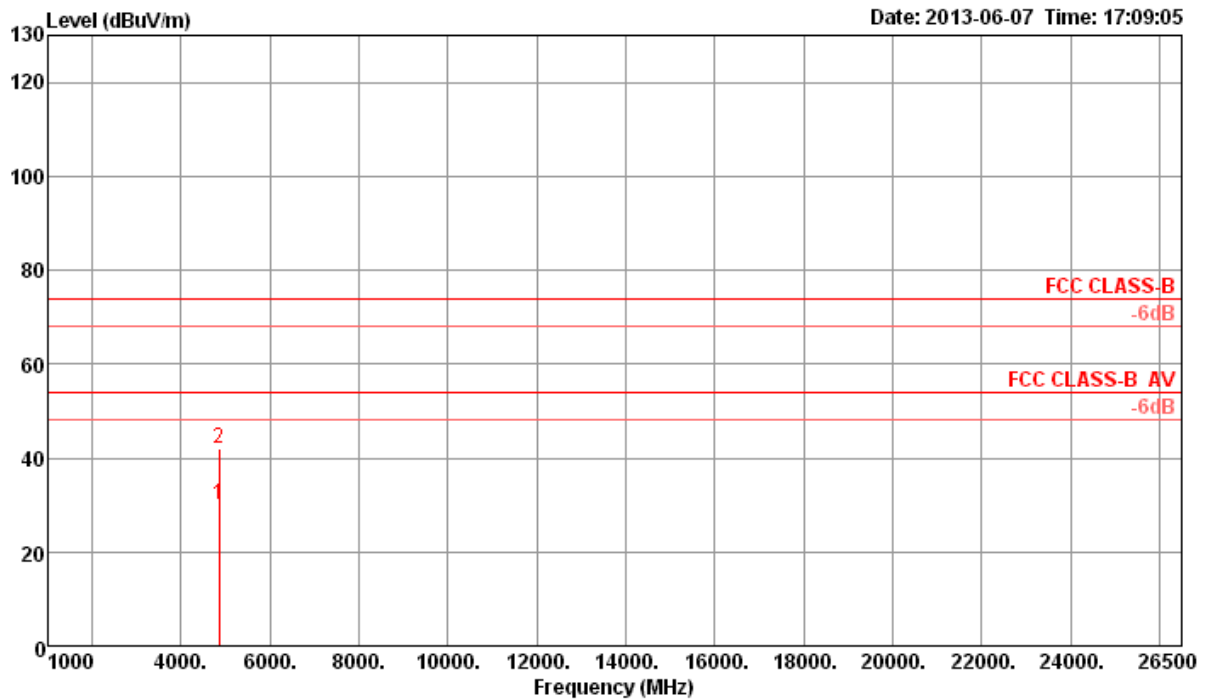

	Freq	Level	Limit	Over	Read	Cable	Antenna	Preamp	Remark	A/Pos	T/Pos	Pol/Phase
	MHz	dBuV/m	dBuV/m	dB	dBuV	dB	dB/m	dB		cm	deg	
1	4842.97	29.93	54.00	-24.07	28.55	3.32	33.09	35.03	Average	100	245	HORIZONTAL
2	4852.78	41.93	74.00	-32.07	40.55	3.32	33.09	35.03	Peak	100	245	HORIZONTAL

Note 1: The amplitude of spurious emissions which are attenuated by more than 20 dB below the permissible value has no need to be reported.

Note 2: Emission level (dBuV/m) = 20 log Emission level (uV/m).

Note 3: Corrected Reading: Antenna Factor + Cable Loss + Read Level - Preamp Factor = Level.

Note 4: Measurement receive antenna polarization: H (Horizontal), V (Vertical)

Transmitter Radiated Emissions (1GHz~10th Harmonic)					
Operating Mode	IEEE 802.11n MCS0 40MHz CH 3 / Ant. 1			Polarization	V
Temperature	25.6°C	Humidity	56%	Test Engineer	Jim Huang

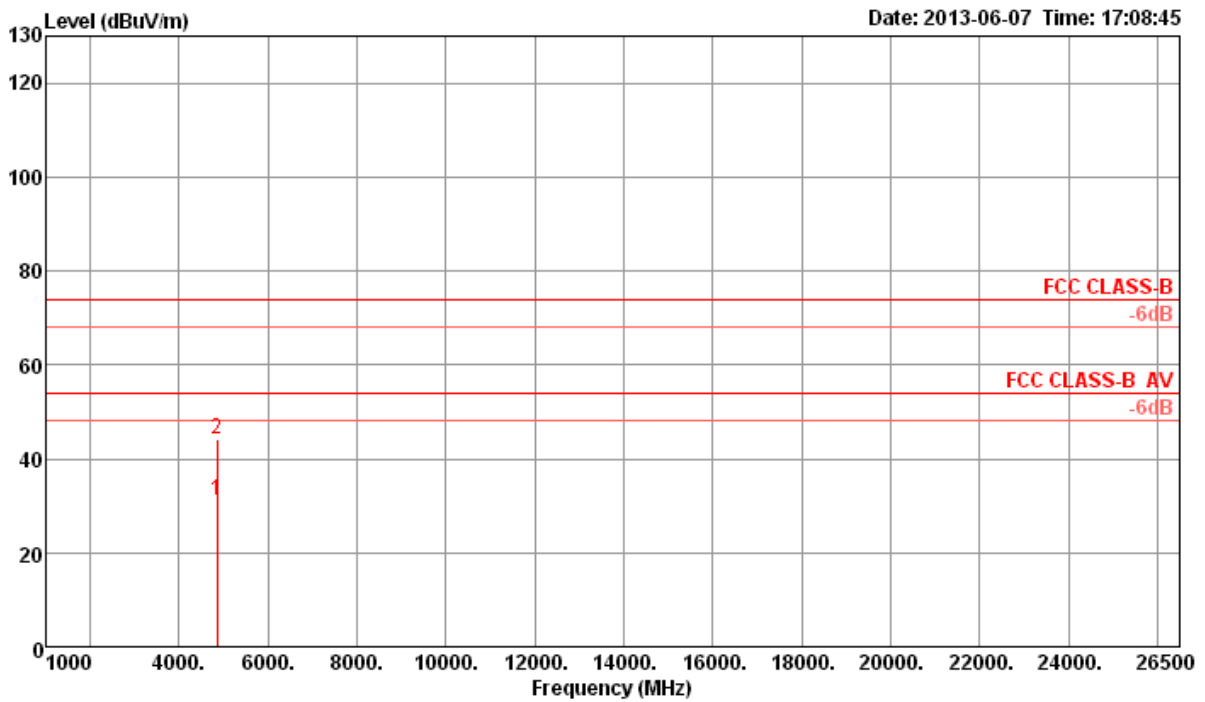

	Freq	Level	Limit	Over	Read	Cable	Antenna	Preamp	Remark	A/Pos	T/Pos	Pol/Phase
	MHz	dBuV/m	dBuV/m	dB	dBuV	dB	dB/m	dB		cm	deg	
1	4843.65	31.08	54.00	-22.92	29.70	3.32	33.09	35.03	Average	100	129	VERTICAL
2	4852.27	44.14	74.00	-29.86	42.76	3.32	33.09	35.03	Peak	100	129	VERTICAL

Note 1: The amplitude of spurious emissions which are attenuated by more than 20 dB below the permissible value has no need to be reported.

Note 2: Emission level (dBuV/m) = 20 log Emission level (uV/m).

Note 3: Corrected Reading: Antenna Factor + Cable Loss + Read Level - Preamp Factor = Level.

Note 4: Measurement receive antenna polarization: H (Horizontal), V (Vertical)

Transmitter Radiated Emissions (1GHz~10th Harmonic)					
Operating Mode	IEEE 802.11n MCS0 40MHz CH 6 / Ant. 1			Polarization	H
Temperature	25.6°C	Humidity	56%	Test Engineer	Jim Huang

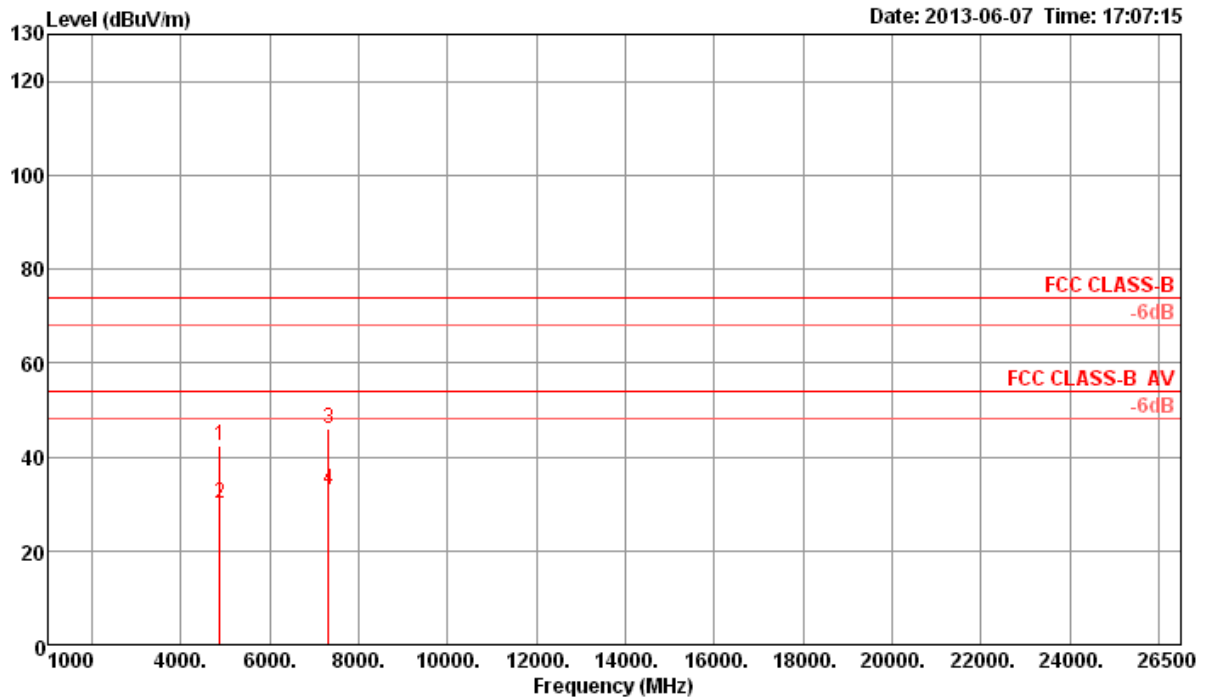

Line	Freq MHz	Level dBuV/m	Limit Line dBuV/m	Over Limit dB	Read Level dBuV	Cable Loss dB	Antenna Factor dB/m	Preamp Factor dB	Remark	A/Pos cm	T/Pos deg	Pol/Phase
1	4867.11	42.53	74.00	-31.47	41.11	3.33	33.12	35.03	Peak	100	238	HORIZONTAL
2	4869.77	29.96	54.00	-24.04	28.54	3.33	33.12	35.03	Average	100	238	HORIZONTAL
3	7311.13	45.91	74.00	-28.09	41.29	4.06	35.96	35.40	Peak	100	107	HORIZONTAL
4	7320.74	32.89	54.00	-21.11	28.27	4.06	35.96	35.40	Average	100	107	HORIZONTAL

Note 1: The amplitude of spurious emissions which are attenuated by more than 20 dB below the permissible value has no need to be reported.

Note 2: Emission level (dBuV/m) = 20 log Emission level (uV/m).

Note 3: Corrected Reading: Antenna Factor + Cable Loss + Read Level - Preamp Factor = Level.

Note 4: Measurement receive antenna polarization: H (Horizontal), V (Vertical)

Transmitter Radiated Emissions (1GHz~10th Harmonic)					
Operating Mode	IEEE 802.11n MCS0 40MHz CH 6 / Ant. 1			Polarization	V
Temperature	25.6°C	Humidity	56%	Test Engineer	Jim Huang

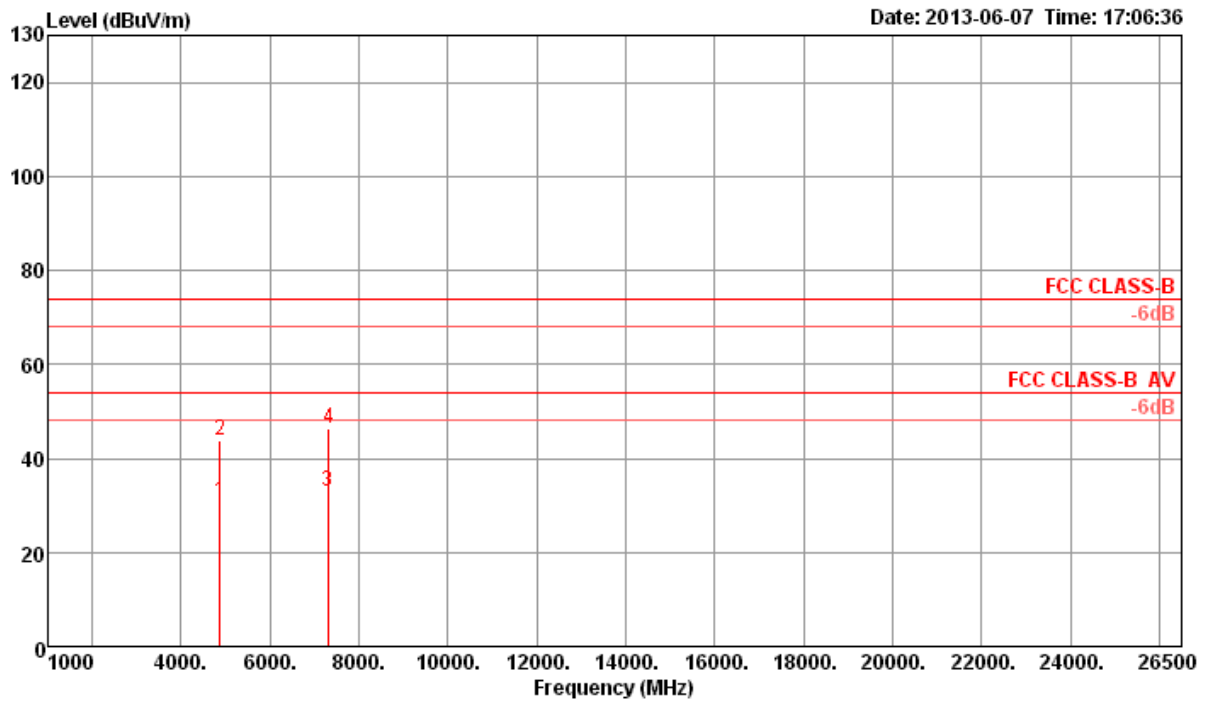

	Freq	Level	Limit	Over	Read	Cable	Antenna	Preamp	Remark	A/Pos	T/Pos	Pol/Phase
	MHz	dBuV/m	dBuV/m	dB	dBuV	dB	dB/m	dB		cm	deg	
1	4867.72	30.91	54.00	-23.09	29.49	3.33	33.12	35.03	Average	100	326	VERTICAL
2	4869.16	43.73	74.00	-30.27	42.31	3.33	33.12	35.03	Peak	100	326	VERTICAL
3	7306.00	32.88	54.00	-21.12	28.30	4.06	35.92	35.40	Average	100	209	VERTICAL
4	7309.49	46.24	74.00	-27.76	41.62	4.06	35.96	35.40	Peak	100	209	VERTICAL

Note 1: The amplitude of spurious emissions which are attenuated by more than 20 dB below the permissible value has no need to be reported.

Note 2: Emission level (dBuV/m) = 20 log Emission level (uV/m).

Note 3: Corrected Reading: Antenna Factor + Cable Loss + Read Level - Preamp Factor = Level.

Note 4: Measurement receive antenna polarization: H (Horizontal), V (Vertical)

Transmitter Radiated Emissions (1GHz~10th Harmonic)					
Operating Mode	IEEE 802.11n MCS0 40MHz CH 9 / Ant. 1			Polarization	H
Temperature	25.6°C	Humidity	56%	Test Engineer	Jim Huang

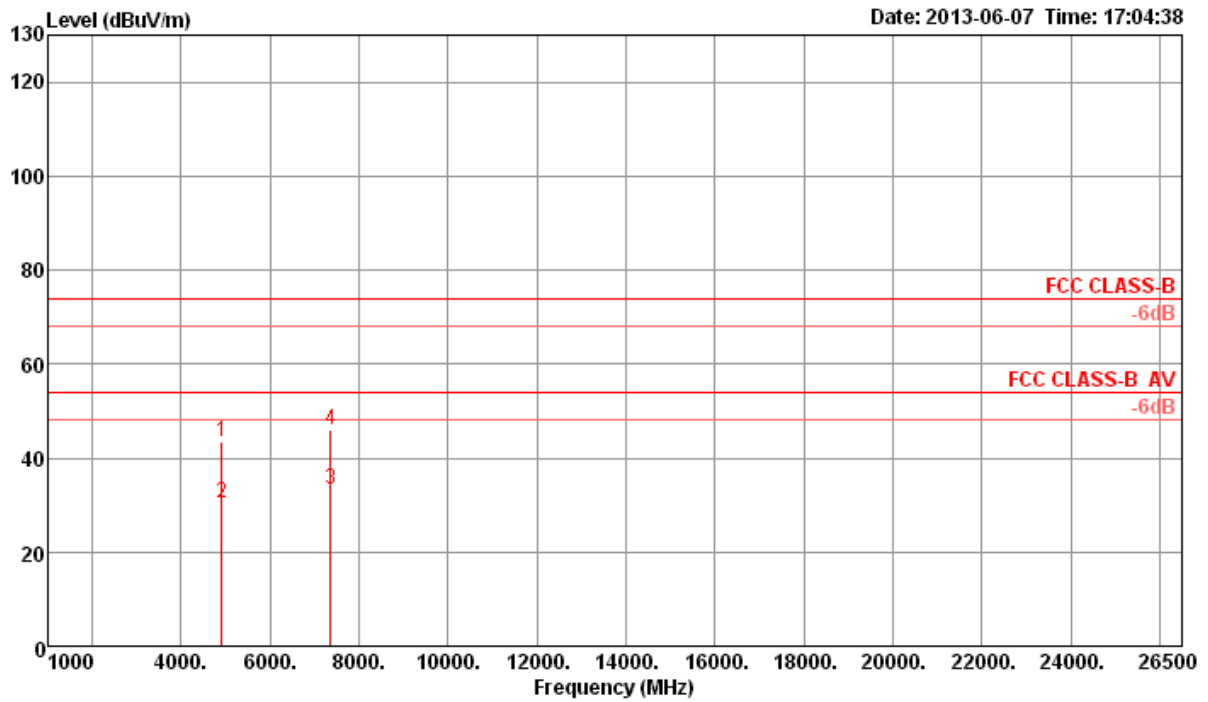

	Freq	Level	Limit	Over	Read	Cable	Antenna	Preamp	Remark	A/Pos	T/Pos	Pol/Phase
	MHz	dBuV/m	dBuV/m	dB	dBuV	dB	dB/m	dB		cm	deg	
1	4912.24	43.28	74.00	-30.72	41.73	3.34	33.23	35.02	Peak	100	196	HORIZONTAL
2	4913.74	30.31	54.00	-23.69	28.76	3.34	33.23	35.02	Average	100	196	HORIZONTAL
3	7355.26	33.33	54.00	-20.67	28.65	4.06	36.02	35.40	Average	100	50	HORIZONTAL
4	7357.60	46.02	74.00	-27.98	41.34	4.06	36.02	35.40	Peak	100	50	HORIZONTAL

Note 1: The amplitude of spurious emissions which are attenuated by more than 20 dB below the permissible value has no need to be reported.

Note 2: Emission level (dBuV/m) = 20 log Emission level (uV/m).

Note 3: Corrected Reading: Antenna Factor + Cable Loss + Read Level - Preamp Factor = Level.

Note 4: Measurement receive antenna polarization: H (Horizontal), V (Vertical)

Transmitter Radiated Emissions (1GHz~10th Harmonic)					
Operating Mode	IEEE 802.11n MCS0 40MHz CH 9 / Ant. 1			Polarization	V
Temperature	25.6°C	Humidity	56%	Test Engineer	Jim Huang

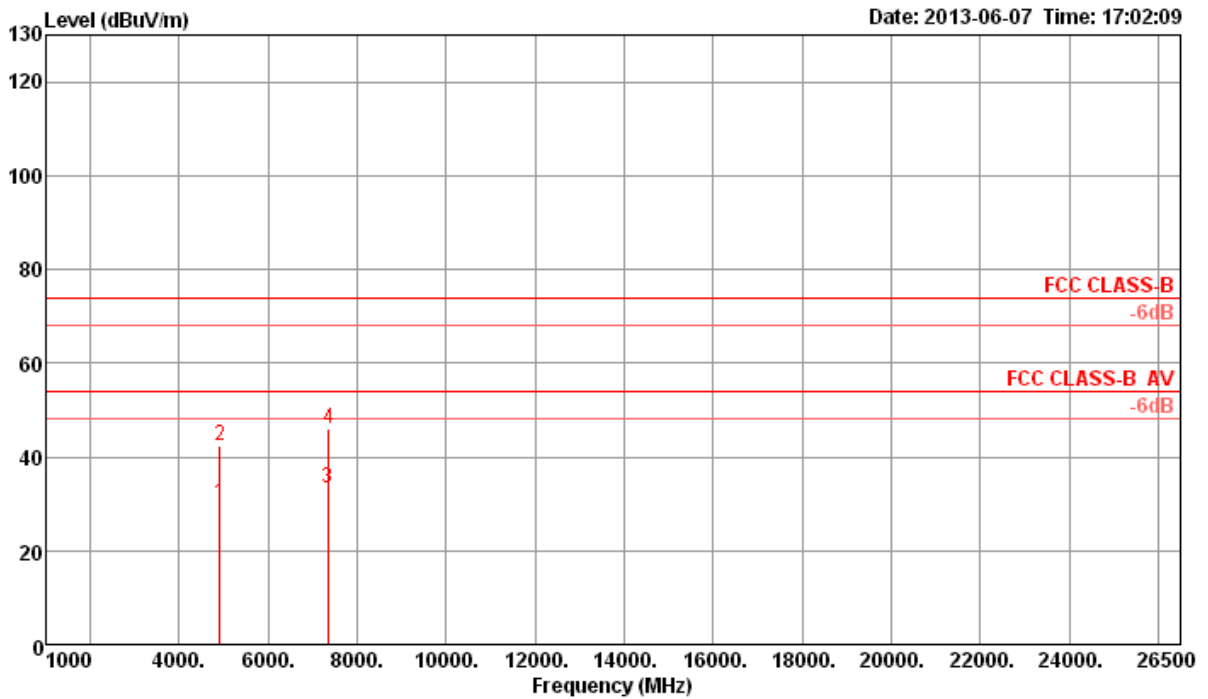

	Freq	Level	Limit	Over	Read	Cable	Antenna	Preamp	Remark	A/Pos	T/Pos	Pol/Phase
	MHz	dBuV/m	dBuV/m	dB	dBuV	dB	dB/m	dB		cm	deg	
1	4903.36	30.12	54.00	-23.88	28.61	3.34	33.19	35.02	Average	100	200	VERTICAL
2	4912.94	42.35	74.00	-31.65	40.80	3.34	33.23	35.02	Peak	100	200	VERTICAL
3	7346.10	33.15	54.00	-20.85	28.47	4.06	36.02	35.40	Average	100	293	VERTICAL
4	7359.56	45.93	74.00	-28.07	41.21	4.06	36.06	35.40	Peak	100	293	VERTICAL

Note 1: The amplitude of spurious emissions which are attenuated by more than 20 dB below the permissible value has no need to be reported.  
 Note 2: Emission level (dBuV/m) = 20 log Emission level (uV/m).  
 Note 3: Corrected Reading: Antenna Factor + Cable Loss + Read Level - Preamp Factor = Level.  
 Note 4: Measurement receive antenna polarization: H (Horizontal), V (Vertical)

Transmitter Radiated Emissions (1GHz~10th Harmonic)					
Operating Mode	IEEE 802.11n MCS0 40MHz CH 3 / Ant. 2			Polarization	H
Temperature	25.6°C	Humidity	56%	Test Engineer	Jim Huang

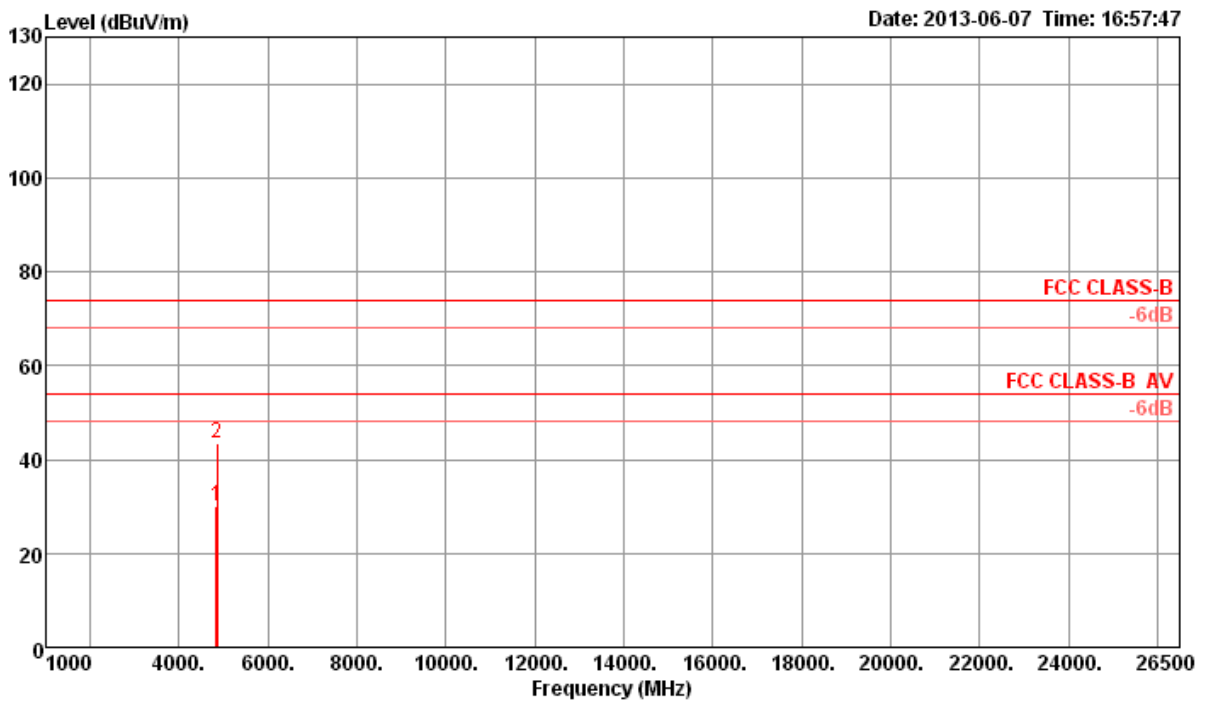

	Freq	Level	Limit	Over	Read	Cable	Antenna	Preamp	Remark	A/Pos	T/Pos	Pol/Phase
	MHz	dBuV/m	dBuV/m	dB	dBuV	dB	dB/m	dB		cm	deg	
1	4839.19	29.94	54.00	-24.06	28.56	3.32	33.09	35.03	Average	100	309	HORIZONTAL
2	4842.62	43.29	74.00	-30.71	41.91	3.32	33.09	35.03	Peak	100	309	HORIZONTAL

Note 1: The amplitude of spurious emissions which are attenuated by more than 20 dB below the permissible value has no need to be reported.  
 Note 2: Emission level (dBuV/m) = 20 log Emission level (uV/m).  
 Note 3: Corrected Reading: Antenna Factor + Cable Loss + Read Level - Preamp Factor = Level.  
 Note 4: Measurement receive antenna polarization: H (Horizontal), V (Vertical)

Transmitter Radiated Emissions (1GHz~10th Harmonic)					
Operating Mode	IEEE 802.11n MCS0 40MHz CH 3 / Ant. 2			Polarization	V
Temperature	25.6°C	Humidity	56%	Test Engineer	Jim Huang

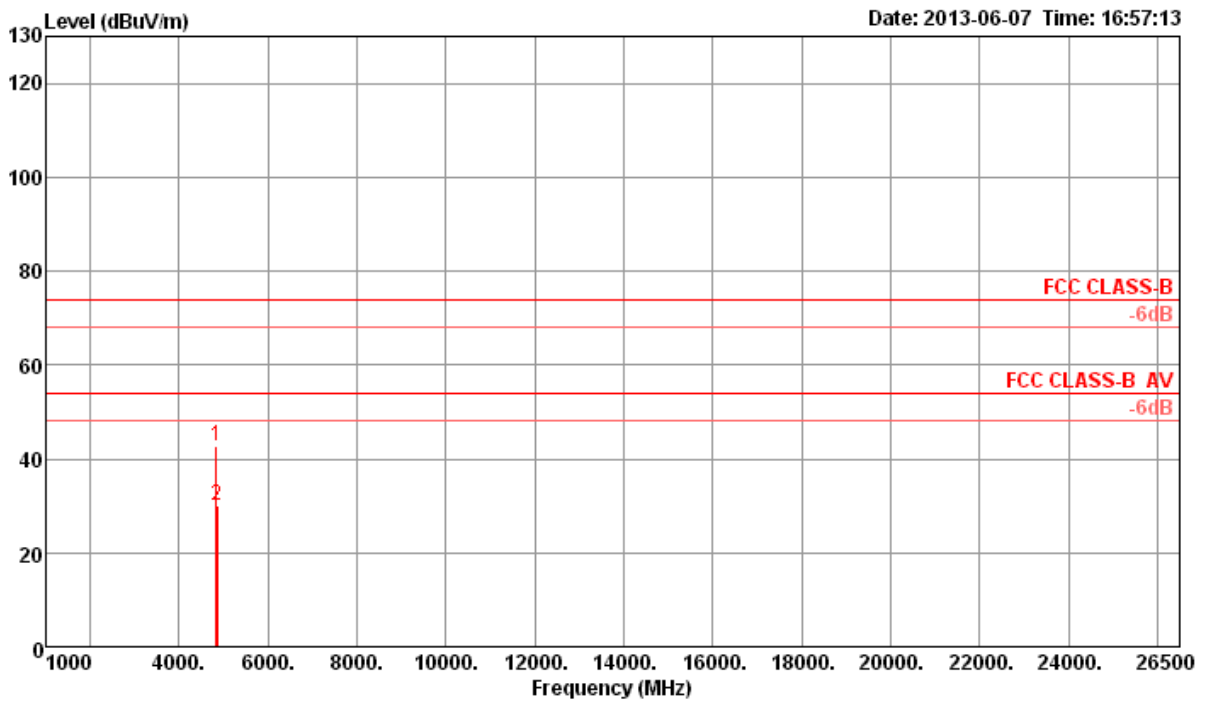

	Freq	Level	Limit	Over	Read	Cable	Antenna	Preamp	Remark	A/Pos	T/Pos	Pol/Phase
	MHz	dBuV/m	dBuV/m	dB	dBuV	dB	dB/m	dB		cm	deg	
1	4840.86	42.82	74.00	-31.18	41.44	3.32	33.09	35.03	Peak	100	180	VERTICAL
2	4844.93	30.16	54.00	-23.84	28.78	3.32	33.09	35.03	Average	100	180	VERTICAL

Note 1: The amplitude of spurious emissions which are attenuated by more than 20 dB below the permissible value has no need to be reported.

Note 2: Emission level (dBuV/m) = 20 log Emission level (uV/m).

Note 3: Corrected Reading: Antenna Factor + Cable Loss + Read Level - Preamp Factor = Level.

Note 4: Measurement receive antenna polarization: H (Horizontal), V (Vertical)



Transmitter Radiated Emissions (1GHz~10th Harmonic)					
Operating Mode	IEEE 802.11n MCS0 40MHz CH 6 / Ant. 2			Polarization	H
Temperature	25.6°C	Humidity	56%	Test Engineer	Jim Huang

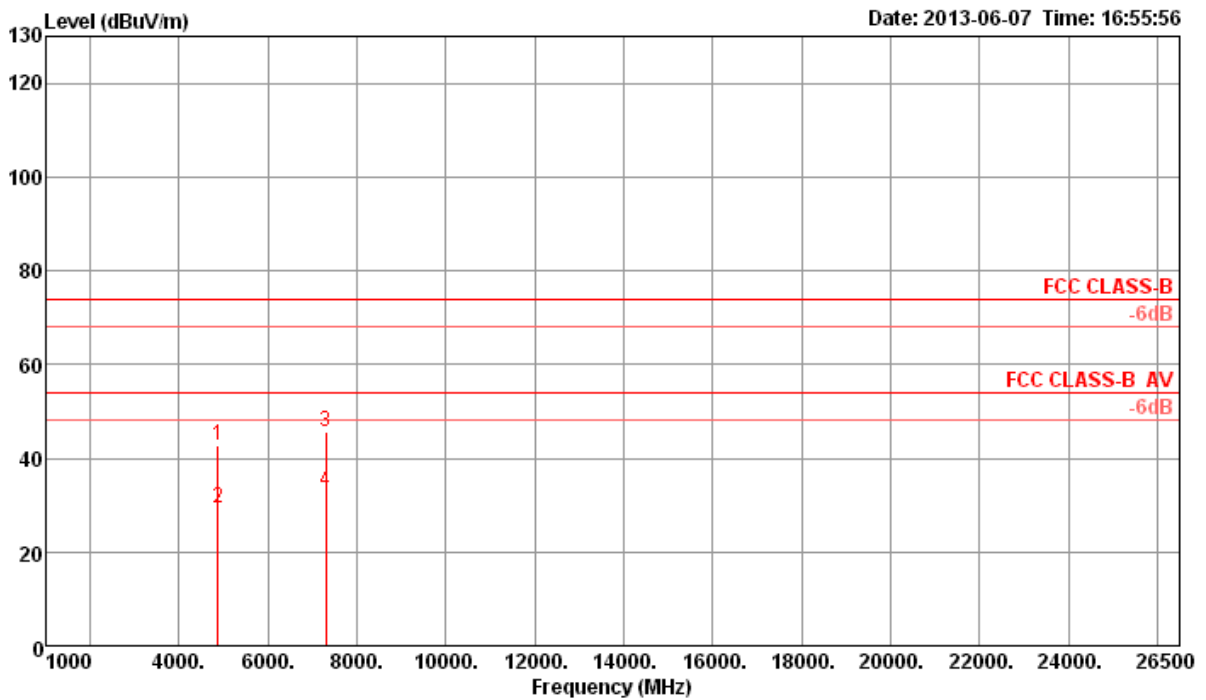

	Freq	Level	Limit	Over	Read	Cable	Antenna	Preamp	Remark	A/Pos	T/Pos	Pol/Phase
	MHz	dBuV/m	dBuV/m	dB	dBuV	dB	dB/m	dB		cm	deg	
1	4875.38	42.74	74.00	-31.26	41.28	3.33	33.16	35.03	Peak	100	37	HORIZONTAL
2	4878.78	29.42	54.00	-24.58	27.96	3.33	33.16	35.03	Average	100	37	HORIZONTAL
3	7301.42	45.63	74.00	-28.37	41.05	4.06	35.92	35.40	Peak	100	114	HORIZONTAL
4	7303.08	33.04	54.00	-20.96	28.46	4.06	35.92	35.40	Average	100	114	HORIZONTAL

Note 1: The amplitude of spurious emissions which are attenuated by more than 20 dB below the permissible value has no need to be reported.

Note 2: Emission level (dBuV/m) = 20 log Emission level (uV/m).

Note 3: Corrected Reading: Antenna Factor + Cable Loss + Read Level - Preamp Factor = Level.

Note 4: Measurement receive antenna polarization: H (Horizontal), V (Vertical)

Transmitter Radiated Emissions (1GHz~10th Harmonic)					
Operating Mode	IEEE 802.11n MCS0 40MHz CH 6 / Ant. 2			Polarization	V
Temperature	25.6°C	Humidity	56%	Test Engineer	Jim Huang

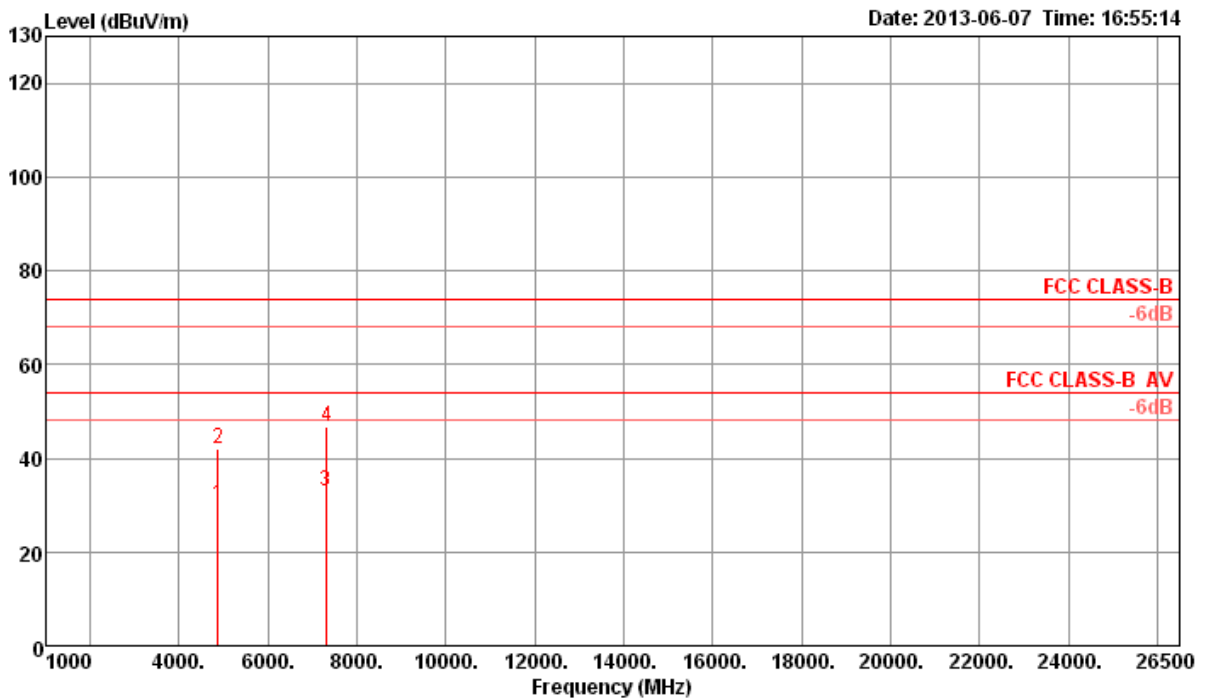

	Freq	Level	Limit	Over	Read	Cable	Antenna	Preamp	Remark	A/Pos	T/Pos	Pol/Phase
	MHz	dBuV/m	dBuV/m	dB	dBuV	dB	dB/m	dB		cm	deg	
1	4873.84	30.02	54.00	-23.98	28.56	3.33	33.16	35.03	Average	100	117	VERTICAL
2	4880.25	41.97	74.00	-32.03	40.51	3.33	33.16	35.03	Peak	100	117	VERTICAL
3	7301.06	32.99	54.00	-21.01	28.41	4.06	35.92	35.40	Average	100	241	VERTICAL
4	7311.77	46.75	74.00	-27.25	42.13	4.06	35.96	35.40	Peak	100	241	VERTICAL

Note 1: The amplitude of spurious emissions which are attenuated by more than 20 dB below the permissible value has no need to be reported.

Note 2: Emission level (dBuV/m) = 20 log Emission level (uV/m).

Note 3: Corrected Reading: Antenna Factor + Cable Loss + Read Level - Preamp Factor = Level.

Note 4: Measurement receive antenna polarization: H (Horizontal), V (Vertical)

Transmitter Radiated Emissions (1GHz~10th Harmonic)					
Operating Mode	IEEE 802.11n MCS0 40MHz CH 9 / Ant. 2			Polarization	H
Temperature	25.6°C	Humidity	56%	Test Engineer	Jim Huang

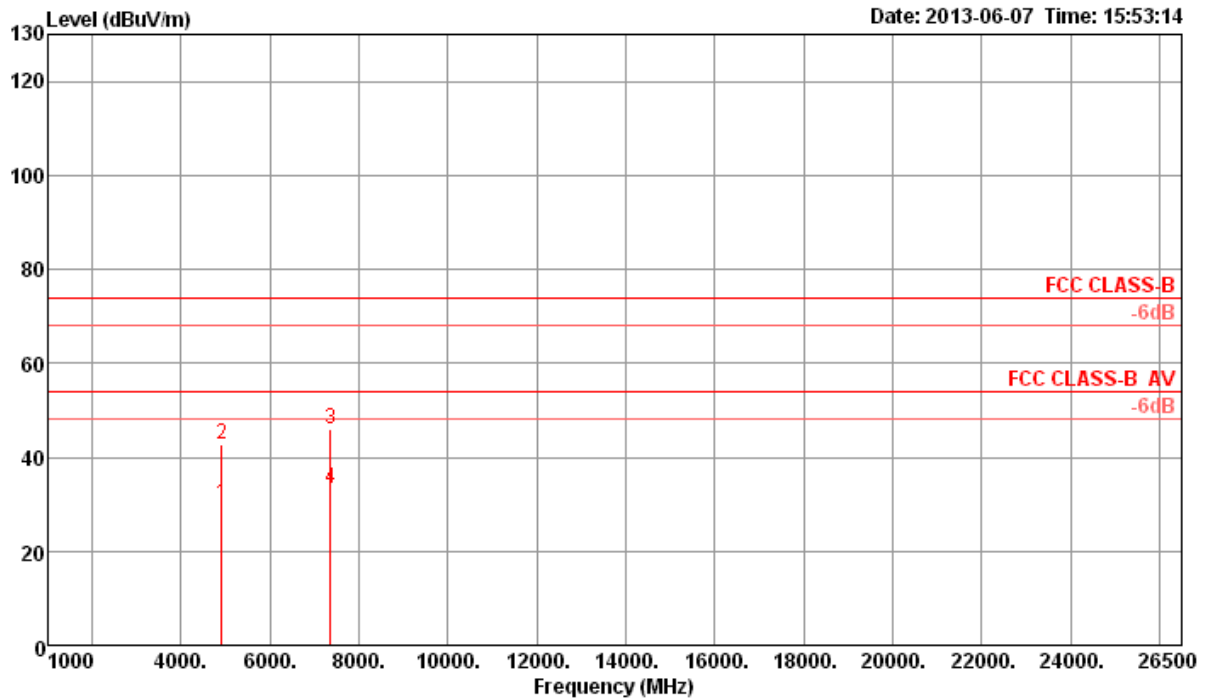

	Limit	Over	Read	Cable	Antenna	Preamp		A/Pos	T/Pos			
-----	Line	Limit	Level	Loss	Factor	Factor	Remark			Pol/Phase		
	dBuV/m	dB	dBuV	dB	dB/m	dB		cm	deg			
1	4901.37	29.97	54.00	-24.03	28.46	3.34	33.19	35.02	Average	100	290	HORIZONTAL
2	4904.13	42.65	74.00	-31.35	41.14	3.34	33.19	35.02	Peak	100	290	HORIZONTAL
3	7348.92	45.93	74.00	-28.07	41.25	4.06	36.02	35.40	Peak	100	109	HORIZONTAL
4	7351.77	33.33	54.00	-20.67	28.65	4.06	36.02	35.40	Average	100	109	HORIZONTAL

Note 1: The amplitude of spurious emissions which are attenuated by more than 20 dB below the permissible value has no need to be reported.

Note 2: Emission level (dBuV/m) = 20 log Emission level (uV/m).

Note 3: Corrected Reading: Antenna Factor + Cable Loss + Read Level - Preamp Factor = Level.

Note 4: Measurement receive antenna polarization: H (Horizontal), V (Vertical)

Transmitter Radiated Emissions (1GHz~10th Harmonic)					
Operating Mode	IEEE 802.11n MCS0 40MHz CH 9 / Ant. 2			Polarization	V
Temperature	25.6°C	Humidity	56%	Test Engineer	Jim Huang

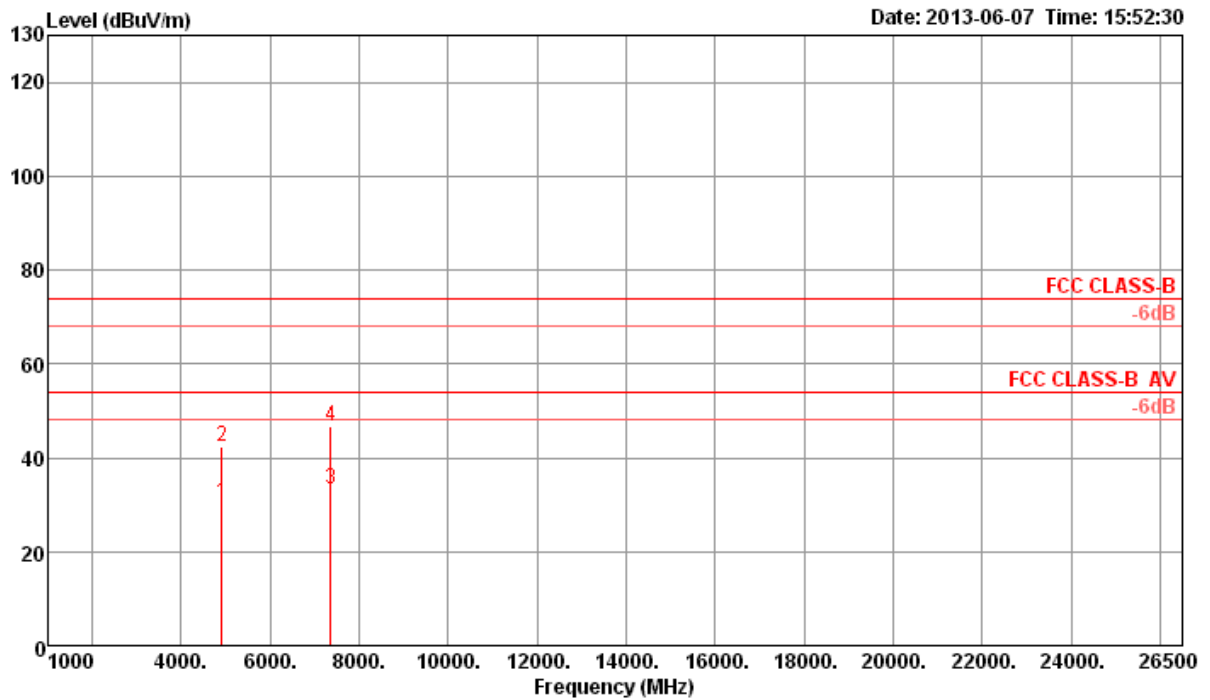

	Freq	Level	Limit	Over	Read	Cable	Antenna	Preamp	Remark	A/Pos	T/Pos	Pol/Phase
	MHz	dBuV/m	dBuV/m	dB	dBuV	dB	dB/m	dB		cm	deg	
1	4902.14	30.33	54.00	-23.67	28.82	3.34	33.19	35.02	Average	100	297	VERTICAL
2	4906.85	42.42	74.00	-31.58	40.87	3.34	33.23	35.02	Peak	100	297	VERTICAL
3	7346.67	33.31	54.00	-20.69	28.63	4.06	36.02	35.40	Average	100	226	VERTICAL
4	7354.49	46.74	74.00	-27.26	42.06	4.06	36.02	35.40	Peak	100	226	VERTICAL

Note 1: The amplitude of spurious emissions which are attenuated by more than 20 dB below the permissible value has no need to be reported.

Note 2: Emission level (dBuV/m) = 20 log Emission level (uV/m).

Note 3: Corrected Reading: Antenna Factor + Cable Loss + Read Level - Preamp Factor = Level.

Note 4: Measurement receive antenna polarization: H (Horizontal), V (Vertical)

Transmitter Radiated Emissions (1GHz~10th Harmonic)					
Operating Mode	IEEE 802.11n MCS8 40MHz CH 3 / Ant. 1 + Ant. 2			Polarization	H
Temperature	25.6°C	Humidity	56%	Test Engineer	Jim Huang

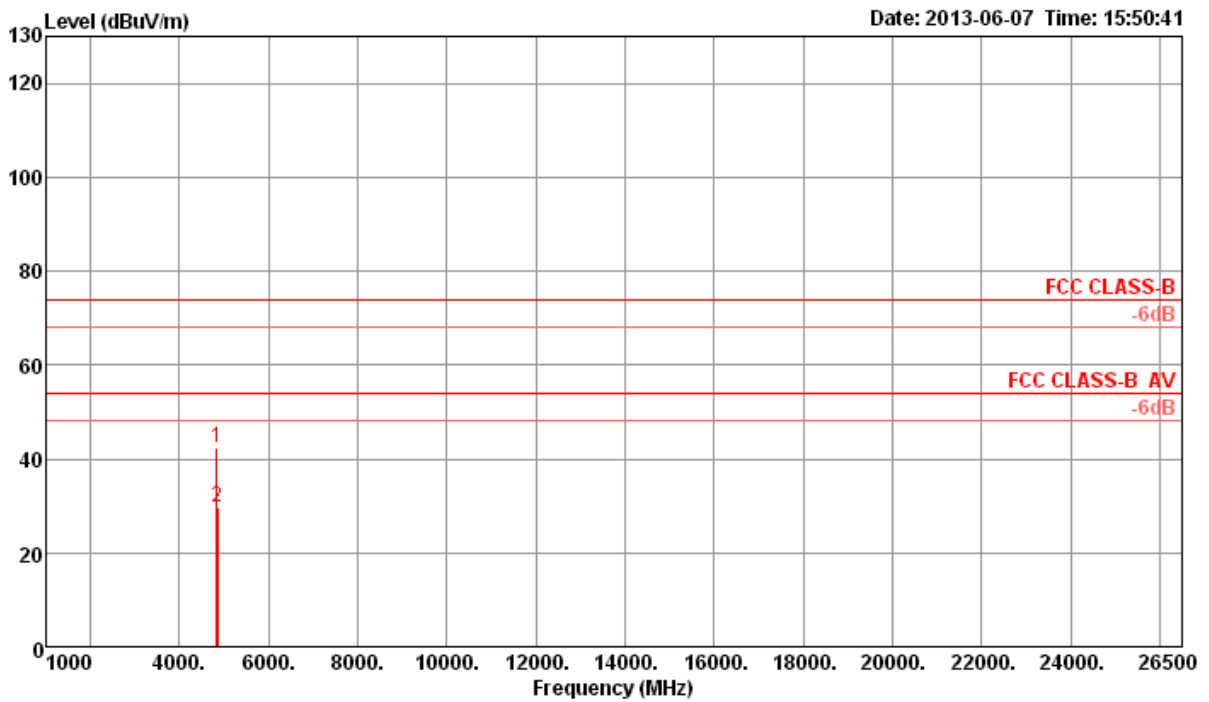

	Freq	Level	Limit	Over	Read	Cable	Antenna	Preamp	Remark	A/Pos	T/Pos	Pol/Phase
	MHz	dBuV/m	dBuV/m	dB	dBuV	dB	dB/m	dB		cm	deg	
1	4837.24	42.28	74.00	-31.72	40.91	3.31	33.09	35.03	Peak	100	73	HORIZONTAL
2	4844.39	29.83	54.00	-24.17	28.45	3.32	33.09	35.03	Average	100	73	HORIZONTAL

Note 1: The amplitude of spurious emissions which are attenuated by more than 20 dB below the permissible value has no need to be reported.

Note 2: Emission level (dBuV/m) = 20 log Emission level (uV/m).

Note 3: Corrected Reading: Antenna Factor + Cable Loss + Read Level - Preamp Factor = Level.

Note 4: Measurement receive antenna polarization: H (Horizontal), V (Vertical)

Transmitter Radiated Emissions (1GHz~10th Harmonic)					
Operating Mode	IEEE 802.11n MCS8 40MHz CH 3 / Ant. 1 + Ant. 2			Polarization	V
Temperature	25.6°C	Humidity	56%	Test Engineer	Jim Huang

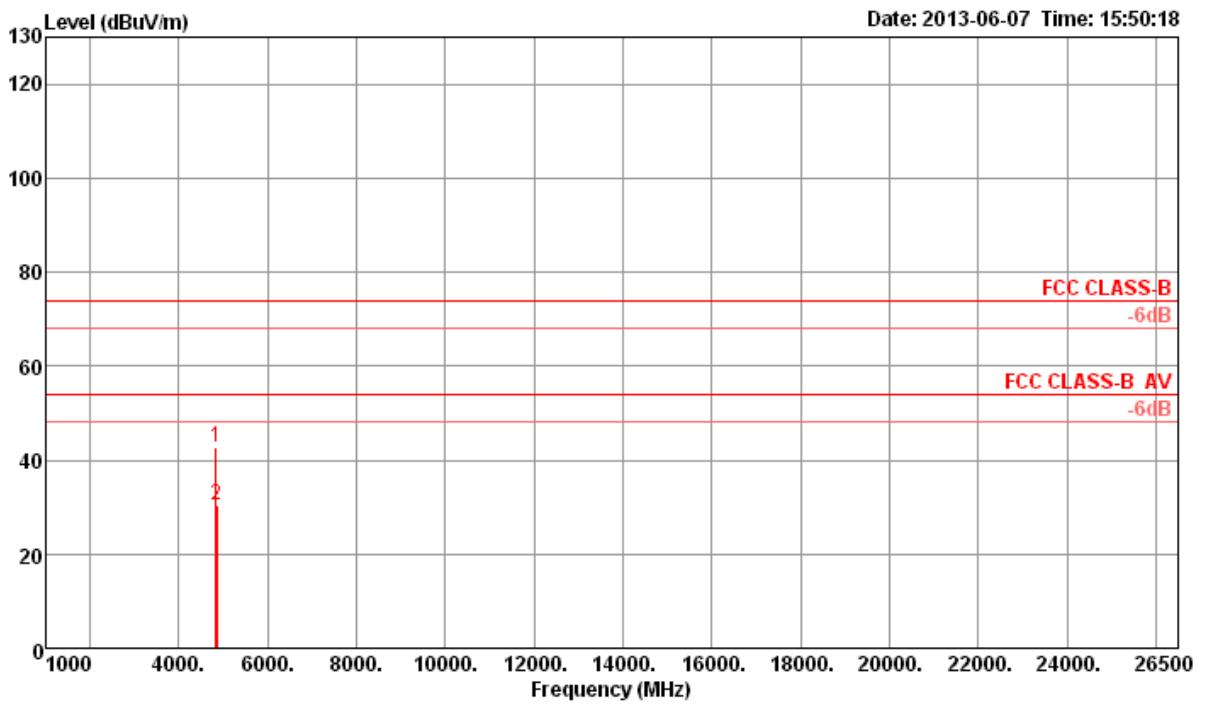

	Freq	Level	Limit	Over	Read	Cable	Antenna	Preamp	Remark	A/Pos	T/Pos	Pol/Phase
	MHz	dBuV/m	dBuV/m	dB	dBuV	dB	dB/m	dB		cm	deg	
1	4838.26	42.76	74.00	-31.24	41.38	3.32	33.09	35.03	Peak	100	179	VERTICAL
2	4843.94	30.44	54.00	-23.56	29.06	3.32	33.09	35.03	Average	100	179	VERTICAL

Note 1: The amplitude of spurious emissions which are attenuated by more than 20 dB below the permissible value has no need to be reported.

Note 2: Emission level (dBuV/m) = 20 log Emission level (uV/m).

Note 3: Corrected Reading: Antenna Factor + Cable Loss + Read Level - Preamp Factor = Level.

Note 4: Measurement receive antenna polarization: H (Horizontal), V (Vertical)

Transmitter Radiated Emissions (1GHz~10th Harmonic)					
Operating Mode	IEEE 802.11n MCS8 40MHz CH 6 / Ant. 1 + Ant. 2			Polarization	H
Temperature	25.6°C	Humidity	56%	Test Engineer	Jim Huang

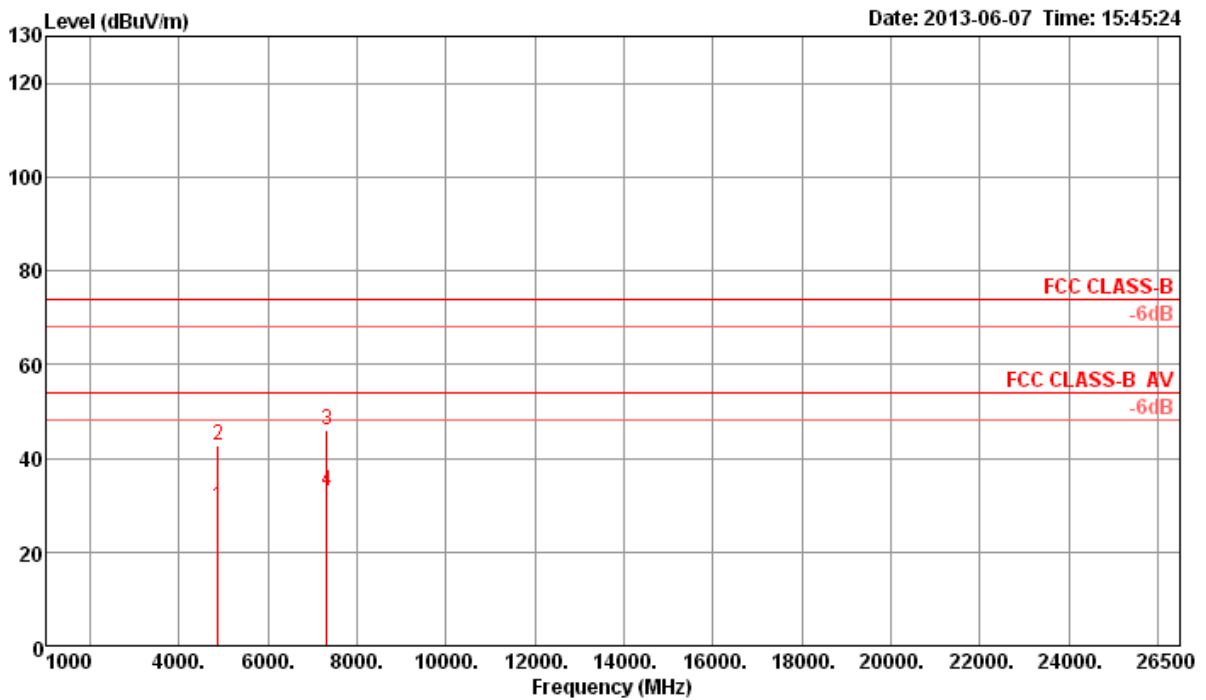

	Freq	Level	Limit	Over	Read	Cable	Antenna	Preamp	Remark	A/Pos	T/Pos	Pol/Phase
	MHz	dBuV/m	dBuV/m	dB	dBuV	dB	dB/m	dB		cm	deg	
1	4876.02	29.76	54.00	-24.24	28.30	3.33	33.16	35.03	Average	100	189	HORIZONTAL
2	4877.40	42.85	74.00	-31.15	41.39	3.33	33.16	35.03	Peak	100	189	HORIZONTAL
3	7308.24	45.99	74.00	-28.01	41.37	4.06	35.96	35.40	Peak	100	323	HORIZONTAL
4	7309.46	32.92	54.00	-21.08	28.30	4.06	35.96	35.40	Average	100	323	HORIZONTAL

Note 1: The amplitude of spurious emissions which are attenuated by more than 20 dB below the permissible value has no need to be reported.  
 Note 2: Emission level (dBuV/m) = 20 log Emission level (uV/m).  
 Note 3: Corrected Reading: Antenna Factor + Cable Loss + Read Level - Preamp Factor = Level.  
 Note 4: Measurement receive antenna polarization: H (Horizontal), V (Vertical)

Transmitter Radiated Emissions (1GHz~10th Harmonic)					
Operating Mode	IEEE 802.11n MCS8 40MHz CH 6 / Ant. 1 + Ant. 2			Polarization	V
Temperature	25.6°C	Humidity	56%	Test Engineer	Jim Huang

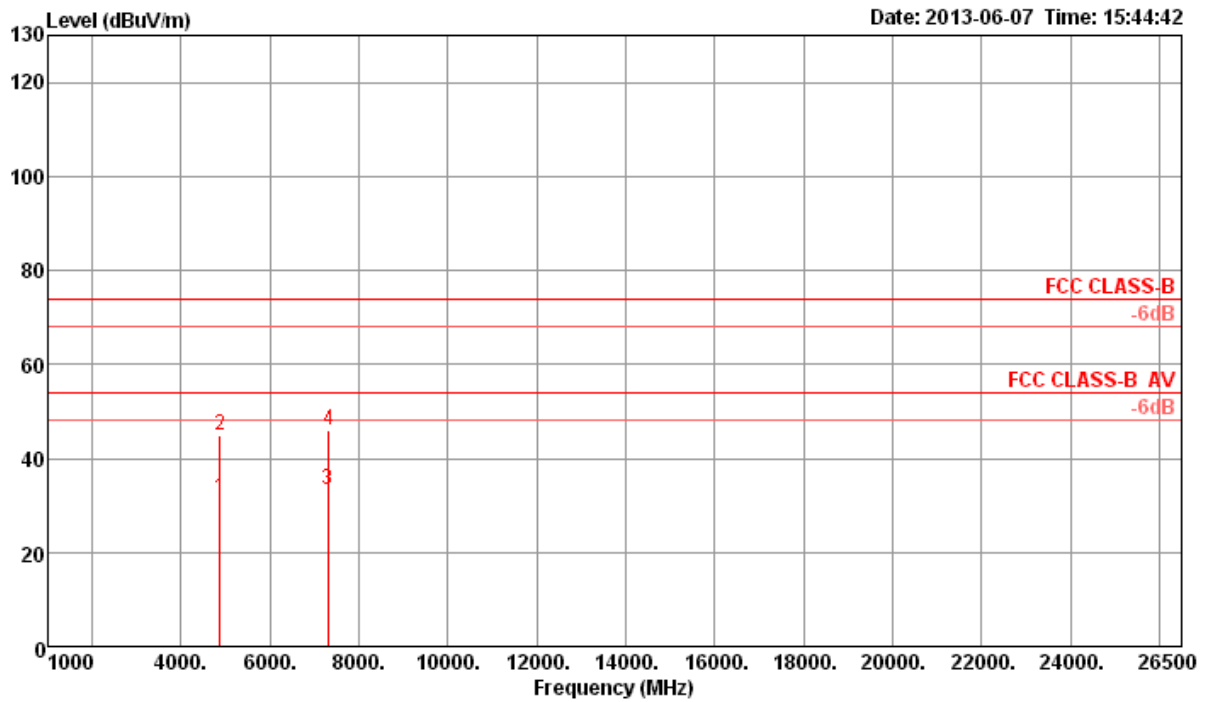

	Freq	Level	Limit	Over	Read	Cable	Antenna	Preamp	Remark	A/Pos	T/Pos	Pol/Phase
	MHz	dBuV/m	dBuV/m	dB	dBuV	dB	dB/m	dB		cm	deg	
1	4873.71	31.52	54.00	-22.48	30.06	3.33	33.16	35.03	Average	100	125	VERTICAL
2	4874.83	44.76	74.00	-29.24	43.30	3.33	33.16	35.03	Peak	100	125	VERTICAL
3	7302.96	33.23	54.00	-20.77	28.65	4.06	35.92	35.40	Average	100	215	VERTICAL
4	7308.66	46.01	74.00	-27.99	41.39	4.06	35.96	35.40	Peak	100	215	VERTICAL

Note 1: The amplitude of spurious emissions which are attenuated by more than 20 dB below the permissible value has no need to be reported.

Note 2: Emission level (dBuV/m) = 20 log Emission level (uV/m).

Note 3: Corrected Reading: Antenna Factor + Cable Loss + Read Level - Preamp Factor = Level.

Note 4: Measurement receive antenna polarization: H (Horizontal), V (Vertical)



Transmitter Radiated Emissions (1GHz~10th Harmonic)					
Operating Mode	IEEE 802.11n MCS8 40MHz CH 9 / Ant. 1 + Ant. 2			Polarization	H
Temperature	25.6°C	Humidity	56%	Test Engineer	Jim Huang

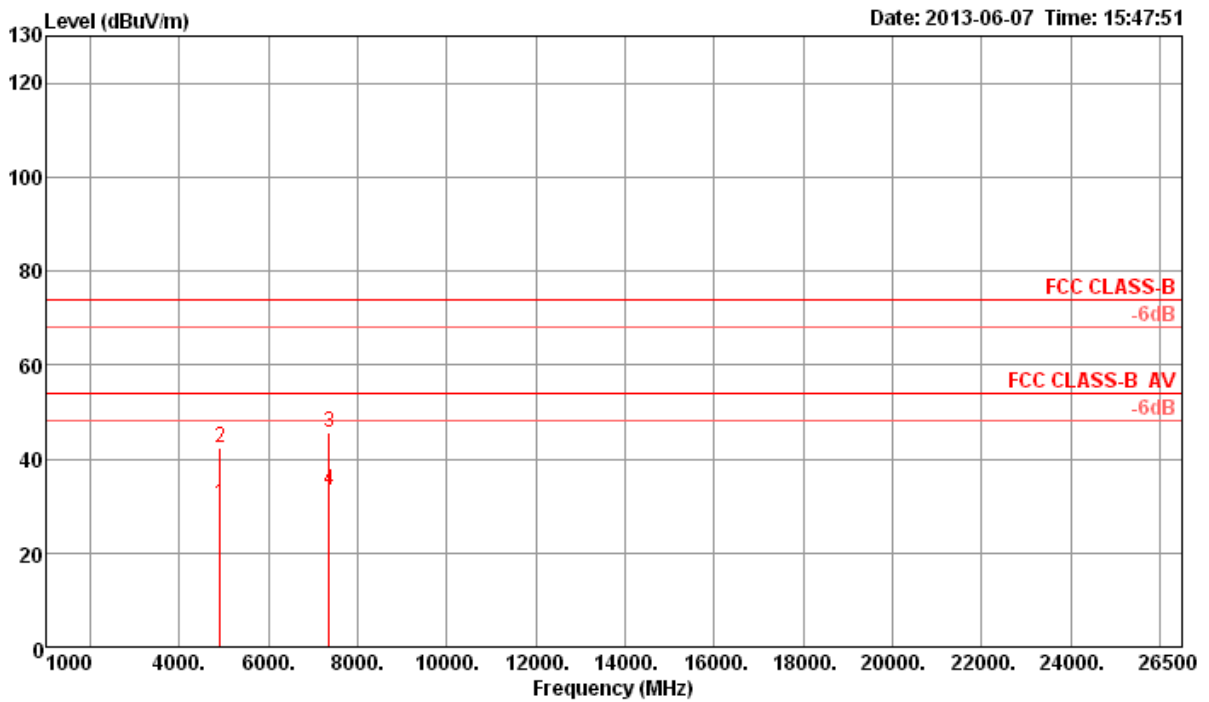

	Freq	Level	Limit	Over	Read	Cable	Antenna	Preamp	Remark	A/Pos	T/Pos	Pol/Phase
	MHz	dBuV/m	dBuV/m	dB	dBuV	dB	dB/m	dB		cm	deg	
1	4901.89	30.29	54.00	-23.71	28.78	3.34	33.19	35.02	Average	100	61	HORIZONTAL
2	4911.76	42.51	74.00	-31.49	40.96	3.34	33.23	35.02	Peak	100	61	HORIZONTAL
3	7356.48	45.52	74.00	-28.48	40.84	4.06	36.02	35.40	Peak	100	143	HORIZONTAL
4	7361.83	33.44	54.00	-20.56	28.72	4.06	36.06	35.40	Average	100	143	HORIZONTAL

Note 1: The amplitude of spurious emissions which are attenuated by more than 20 dB below the permissible value has no need to be reported.

Note 2: Emission level (dBuV/m) = 20 log Emission level (uV/m).

Note 3: Corrected Reading: Antenna Factor + Cable Loss + Read Level - Preamp Factor = Level.

Note 4: Measurement receive antenna polarization: H (Horizontal), V (Vertical)

Transmitter Radiated Emissions (1GHz~10th Harmonic)					
Operating Mode	IEEE 802.11n MCS8 40MHz CH 9 / Ant. 1 + Ant. 2			Polarization	V
Temperature	25.6°C	Humidity	56%	Test Engineer	Jim Huang

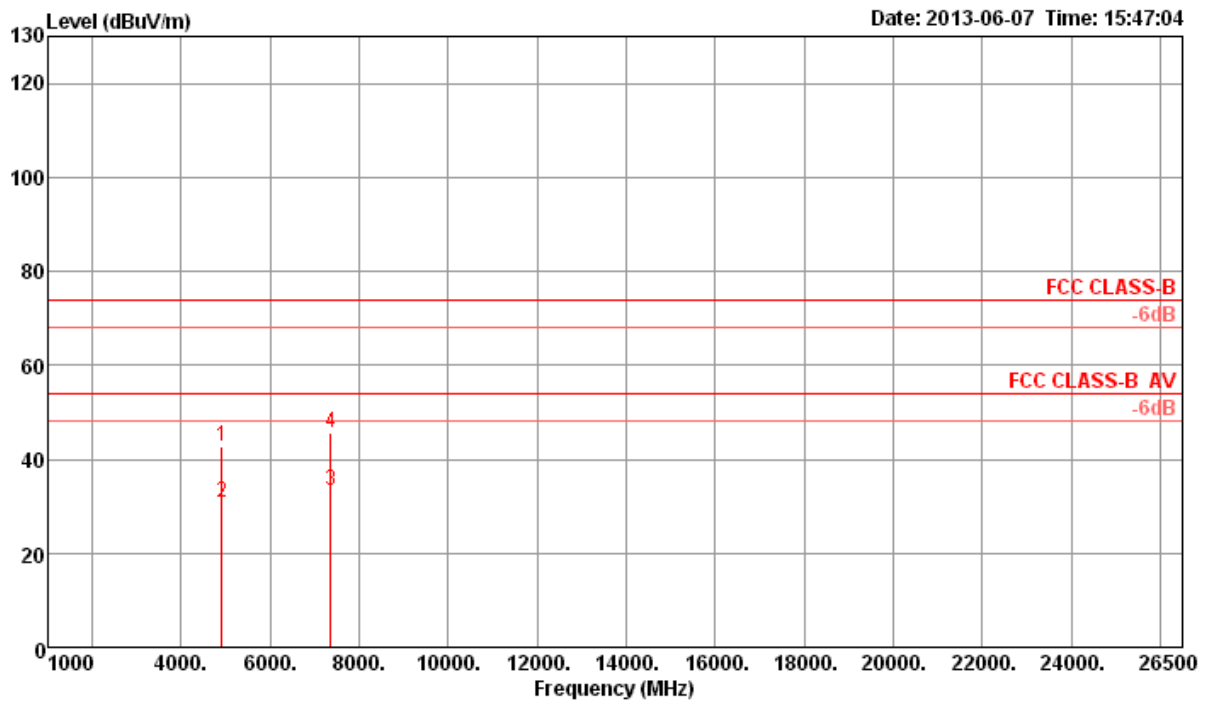

	Freq	Level	Limit	Over	Read	Cable	Antenna	Preamp	Remark	A/Pos	T/Pos	Pol/Phase
	MHz	dBuV/m	dBuV/m	dB	dBuV	dB	dB/m	dB		cm	deg	
1	4908.97	42.59	74.00	-31.41	41.04	3.34	33.23	35.02	Peak	100	145	VERTICAL
2	4912.21	30.83	54.00	-23.17	29.28	3.34	33.23	35.02	Average	100	145	VERTICAL
3	7354.05	33.41	54.00	-20.59	28.73	4.06	36.02	35.40	Average	100	255	VERTICAL
4	7363.28	45.75	74.00	-28.25	41.03	4.06	36.06	35.40	Peak	100	255	VERTICAL

Note 1: The amplitude of spurious emissions which are attenuated by more than 20 dB below the permissible value has no need to be reported.

Note 2: Emission level (dBuV/m) = 20 log Emission level (uV/m).

Note 3: Corrected Reading: Antenna Factor + Cable Loss + Read Level - Preamp Factor = Level.

Note 4: Measurement receive antenna polarization: H (Horizontal), V (Vertical)

### 3.6 Band Edge and Fundamental Emissions Measurement

#### 3.6.1 Limit

20dBc in any 100 kHz bandwidth outside the operating frequency band. In case the emission fall within the restricted band specified on 15.205(a), then the 15.209(a) limit in the table below has to be followed.

Frequencies (MHz)	Field Strength (microvolt/meter)	Measurement Distance (meters)
0.009~0.490	2400/F(KHz)	300
0.490~1.705	24000/F(KHz)	30
1.705~30.0	30	30
30~88	100	3
88~216	150	3
216~960	200	3
Above 960	500	3

#### 3.6.2 Measuring Instruments and Setting

Please refer to section 4 of equipments list in this report. The following table is the setting of the spectrum analyzer.

Spectrum Analyzer	Setting
Attenuation	Auto
Span Frequency	100 MHz
RBW / VBW (Emission in restricted band)	1MHz / 3MHz for Peak, 1MHz / 10Hz for Average
RBW / VBW (Emission in non-restricted band)	100 KHz /300 KHz for Peak

#### 3.6.3 Test Procedures

1. The test procedure is the same as section 3.5.3, only the frequency range investigated is limited to 100MHz around bandedges.
2. In case the emission is fail due to the used RBW/VBW is too wide, marker-delta method of FCC Public Notice DA00-705 will be followed.

#### 3.6.4 Test Setup Layout

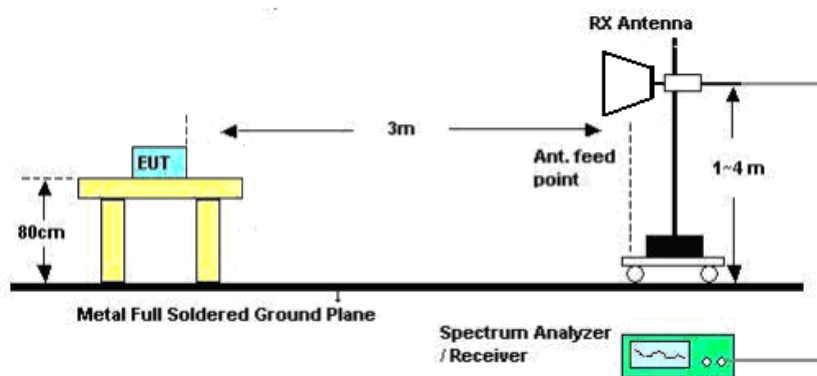

**3.6.5 Test Deviation**

There is no deviation with the original standard.

**3.6.6 EUT Operation during Test**

The EUT was programmed to be in continuously transmitting mode.

**3.6.7 Test Result of Band Edge and Fundamental Emissions**

Following channel(s) was (were) selected for the final test as listed below.

<b>MODE</b>	<b>TX Chain</b>	<b>TESTED CHANNEL</b>	<b>MODULATION TECHNOLOGY</b>	<b>MODULATION TYPE</b>	<b>DATA RATE (Mbps)</b>
802.11b	Ant.1	1, 6, 11	DSSS	DBPSK	1
802.11b	Ant.2	1, 6, 11	DSSS	DBPSK	1
802.11g	Ant.1	1, 6, 11	OFDM	BPSK	6
802.11g	Ant.2	1, 6, 11	OFDM	BPSK	6
802.11n 20MHz	Ant.1	1, 6, 11	OFDM	BPSK	MCS0 (6.5)
802.11n 20MHz	Ant.2	1, 6, 11	OFDM	BPSK	MCS0 (6.5)
802.11n 20MHz	Ant.1+2 (SDM)	1, 6, 11	OFDM	BPSK	MCS8 (13)
802.11n 40MHz	Ant.1	3, 6, 9	OFDM	BPSK	MCS0 (13)
802.11n 40MHz	Ant.2	3, 6, 9	OFDM	BPSK	MCS0 (13)
802.11n 40MHz	Ant.1+2 (SDM)	3, 6, 9	OFDM	BPSK	MCS8 (27)

Band Edge and Fundamental Emissions					
Operating Mode	IEEE 802.11b CH 1 / Ant. 1			Polarization	H
Temperature	25.6°C	Humidity	56%	Test Engineer	Jim Huang

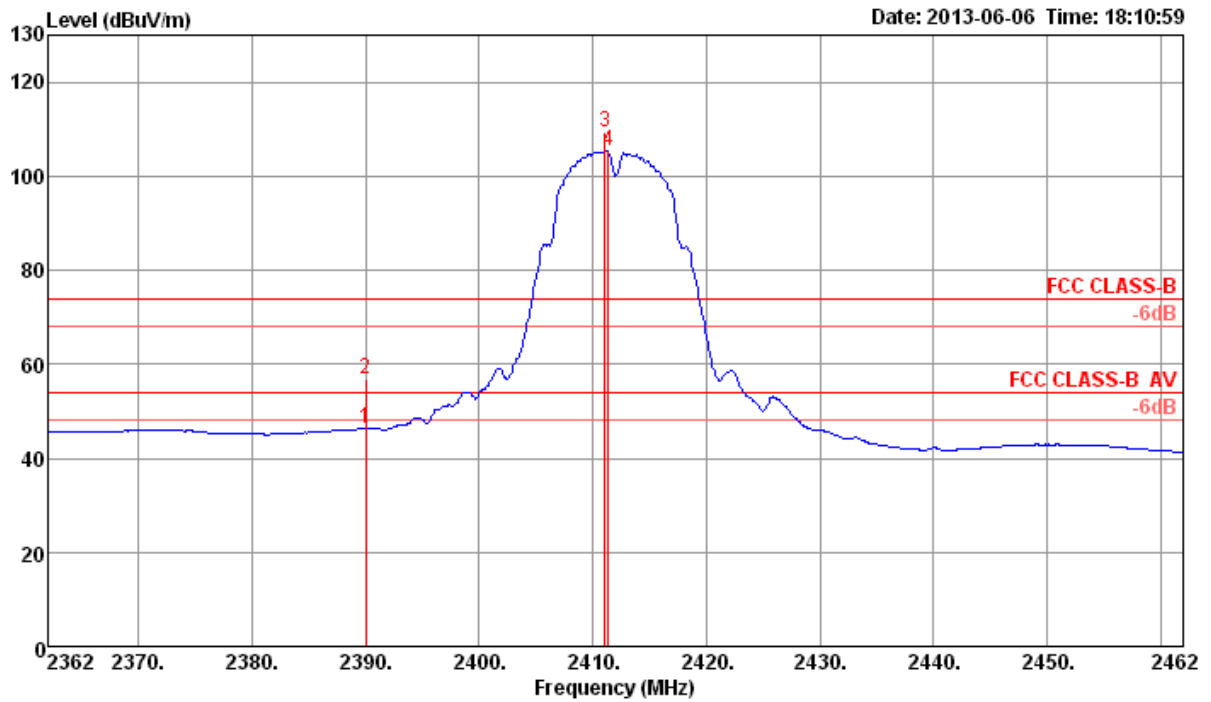

	Freq	Level	Limit	Over	Read	Cable	Antenna	Preamp	Remark	A/Pos	T/Pos	Pol/Phase
	MHz	dBuV/m	dBuV/m	dB	dBuV	dB	dB/m	dB		cm	deg	
1	2390.00	46.33	54.00	-7.67	15.94	2.22	28.17	0.00	Average	100	17	HORIZONTAL
2	2390.00	56.89	74.00	-17.11	26.50	2.22	28.17	0.00	Peak	100	17	HORIZONTAL
3	2411.04	109.18			78.75	2.22	28.21	0.00	Peak	100	17	HORIZONTAL
4	2411.36	105.40			74.97	2.22	28.21	0.00	Average	100	17	HORIZONTAL

Note 1: Item 3, 4 are the fundamental frequency at 2412 MHz  
 Note 2: Emission level (dBuV/m) = 20 log Emission level (uV/m).  
 Note 3: Corrected Reading: Antenna Factor + Cable Loss + Read Level - Preamp Factor = Level.  
 Note 4: Measurement receive antenna polarization: H (Horizontal), V (Vertical)

Band Edge and Fundamental Emissions					
Operating Mode	I IEEE 802.11b CH 6 / Ant. 1			Polarization	V
Temperature	25.6°C	Humidity	56%	Test Engineer	Jim Huang

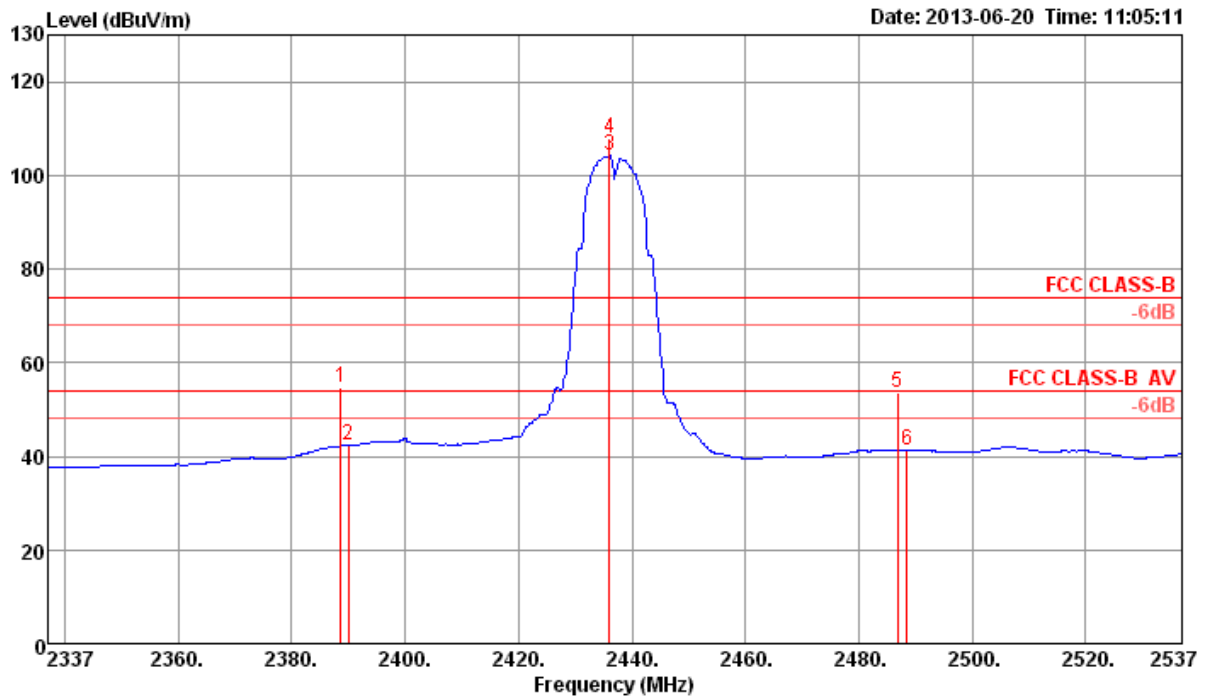

Item	Freq MHz	Level dBuV/m	Limit Line dBuV/m	Over Limit dB	Read Level dBuV	Cable Loss dB	Antenna Factor dB/m	Preamp Factor dB	Remark	A/Pos cm	T/Pos deg	PoI/Phase
1	2388.72	54.68	74.00	-19.32	24.30	2.21	28.17	0.00	Peak	104	36	VERTICAL
2	2390.00	42.25	54.00	-11.75	11.86	2.22	28.17	0.00	Average	104	36	VERTICAL
3	2436.04	104.17			73.65	2.23	28.29	0.00	Average	104	36	VERTICAL
4	2436.04	108.08			77.56	2.23	28.29	0.00	Peak	104	36	VERTICAL
5	2486.86	53.72	74.00	-20.28	23.05	2.26	28.41	0.00	Peak	104	36	VERTICAL
6	2488.46	41.44	54.00	-12.56	10.77	2.26	28.41	0.00	Average	104	36	VERTICAL

Note 1: Item 3, 4 are the fundamental frequency at 2437 MHz  
 Note 2: Emission level (dBuV/m) = 20 log Emission level (uV/m).  
 Note 3: Corrected Reading: Antenna Factor + Cable Loss + Read Level - Preamp Factor = Level.  
 Note 4: Measurement receive antenna polarization: H (Horizontal), V (Vertical)

Band Edge and Fundamental Emissions					
Operating Mode	IEEE 802.11b CH 11 / Ant. 1			Polarization	V
Temperature	25.6°C	Humidity	56%	Test Engineer	Jim Huang

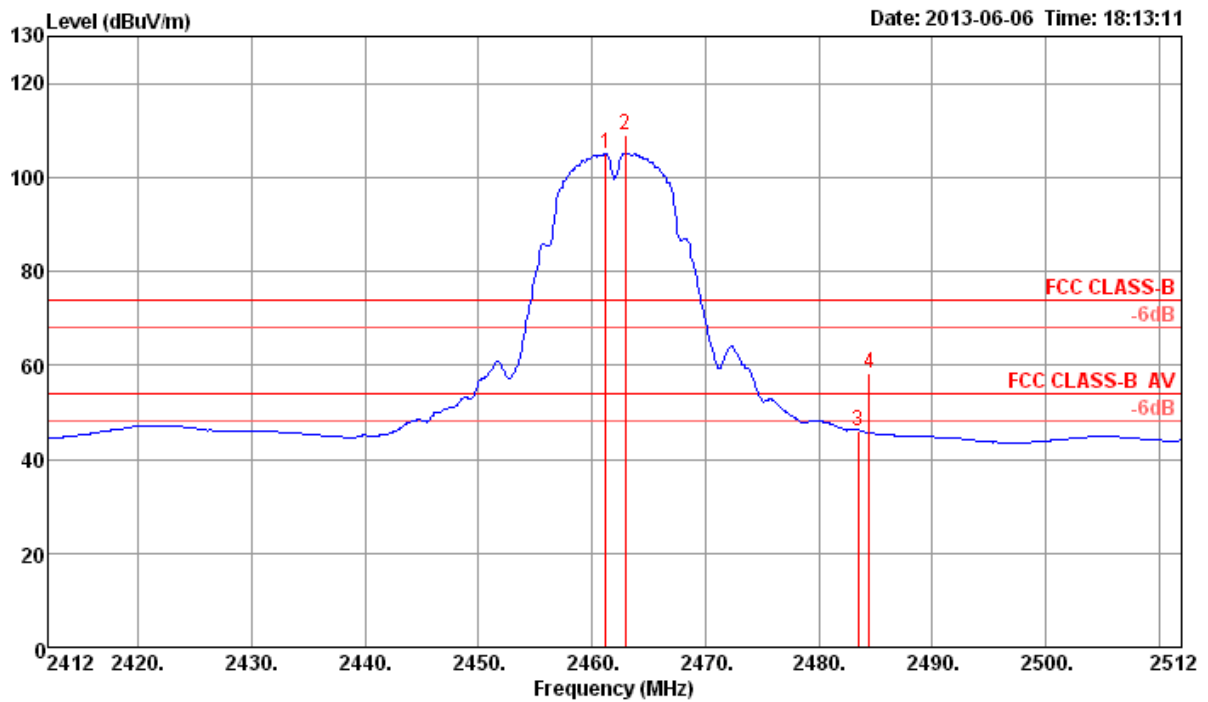

	Freq	Level	Limit	Over	Read	Cable	Antenna	Preamp	Remark	A/Pos	T/Pos	Pol/Phase
	MHz	dBuV/m	dBuV/m	dB	dBuV	dB	dB/m	dB		cm	deg	
1	2461.20	105.06			74.49	2.24	28.33	0.00	Average	100	22	VERTICAL
2	2462.96	109.00			78.43	2.24	28.33	0.00	Peak	100	22	VERTICAL
3	2483.50	45.98	54.00	-8.02	15.35	2.26	28.37	0.00	Average	100	22	VERTICAL
4	2484.46	58.42	74.00	-15.58	27.79	2.26	28.37	0.00	Peak	100	22	VERTICAL

Note 1: Item 1, 2 are the fundamental frequency at 2462MHz  
 Note 2: Emission level (dBuV/m) = 20 log Emission level (uV/m).  
 Note 3: Corrected Reading: Antenna Factor + Cable Loss + Read Level - Preamp Factor = Level.  
 Note 4: Measurement receive antenna polarization: H (Horizontal), V (Vertical)

Band Edge and Fundamental Emissions					
Operating Mode	IEEE 802.11b CH 1 / Ant. 2			Polarization	V
Temperature	25.6°C	Humidity	56%	Test Engineer	Jim Huang

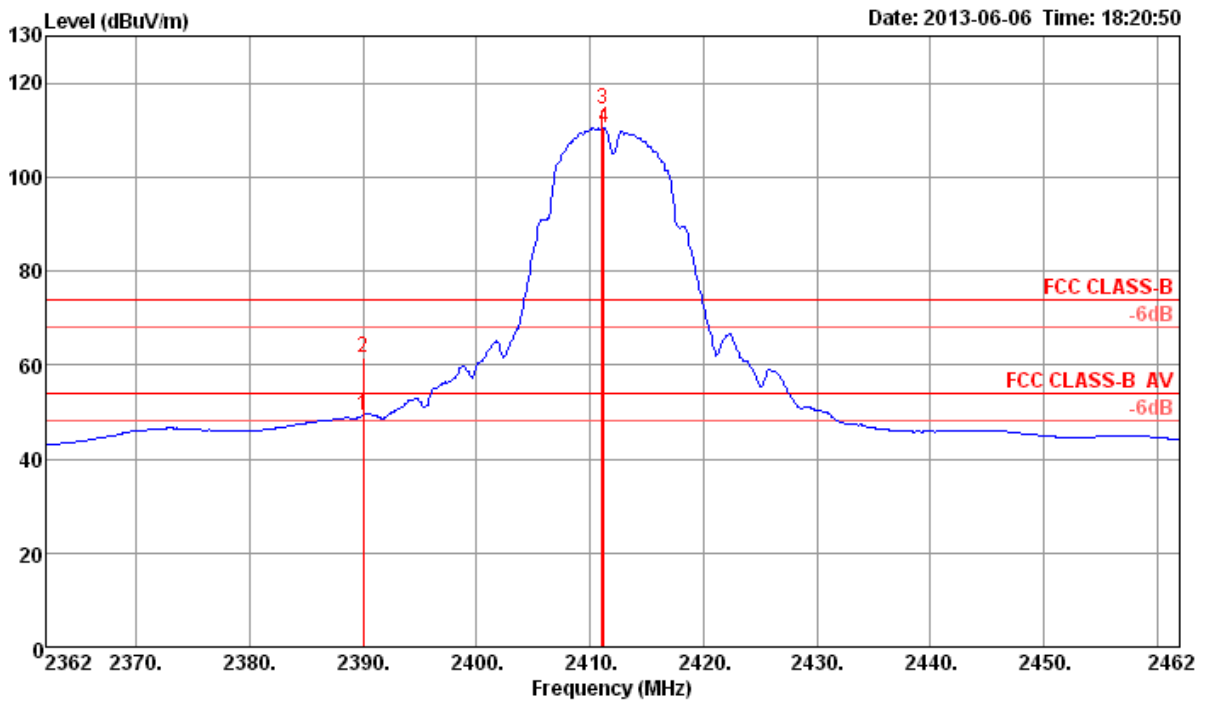

	Freq	Level	Limit	Over	Read	Cable	Antenna	Preamp	Remark	A/Pos	T/Pos	Pol/Phase
	MHz	dBuV/m	dBuV/m	dB	dBuV	dB	dB/m	dB		cm	deg	
1	2390.00	49.35	54.00	-4.65	18.96	2.22	28.17	0.00	Average	100	5	VERTICAL
2	2390.00	61.51	74.00	-12.49	31.12	2.22	28.17	0.00	Peak	100	5	VERTICAL
3	2411.04	114.27			83.84	2.22	28.21	0.00	Peak	100	5	VERTICAL
4	2411.20	110.39			79.96	2.22	28.21	0.00	Average	100	5	VERTICAL

Note 1: Item 3, 4 are the fundamental frequency at 2412 MHz  
 Note 2: Emission level (dBuV/m) = 20 log Emission level (uV/m).  
 Note 3: Corrected Reading: Antenna Factor + Cable Loss + Read Level - Preamp Factor = Level.  
 Note 4: Measurement receive antenna polarization: H (Horizontal), V (Vertical)



Band Edge and Fundamental Emissions					
Operating Mode	IEEE 802.11b CH 6 / Ant. 2			Polarization	V
Temperature	25.6°C	Humidity	56%	Test Engineer	Jim Huang

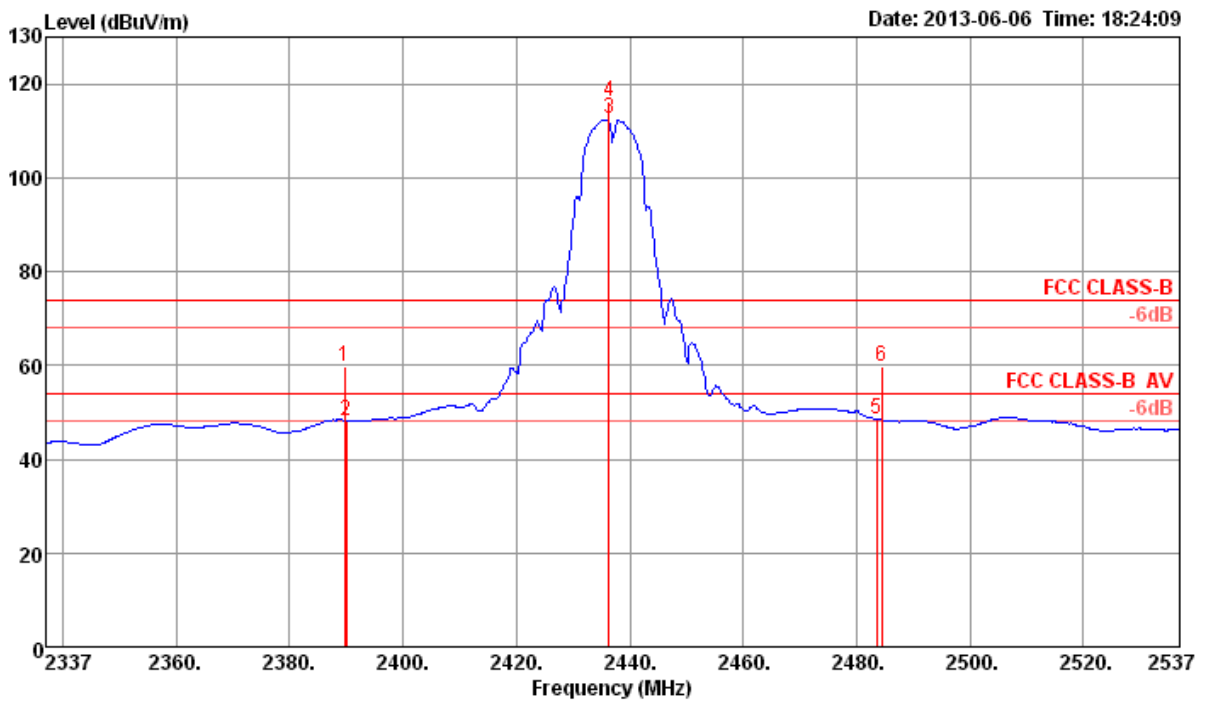

	Freq	Level	Limit	Over	Read	Cable	Antenna	Preamp	Remark	A/Pos	T/Pos	Pol/Phase
	MHz	dBuV/m	dBuV/m	dB	dBuV	dB	dB/m	dB		cm	deg	
1	2389.68	59.91	74.00	-14.09	29.53	2.21	28.17	0.00	Peak	100	335	VERTICAL
2	2390.00	48.24	54.00	-5.76	17.85	2.22	28.17	0.00	Average	100	335	VERTICAL
3	2436.36	112.50			81.98	2.23	28.29	0.00	Average	100	335	VERTICAL
4	2436.36	116.31			85.79	2.23	28.29	0.00	Peak	100	335	VERTICAL
5	2483.50	48.57	54.00	-5.43	17.94	2.26	28.37	0.00	Average	100	335	VERTICAL
6	2484.46	59.64	74.00	-14.36	29.01	2.26	28.37	0.00	Peak	100	335	VERTICAL

Note 1: Item 3, 4 are the fundamental frequency at 2437 MHz  
 Note 2: Emission level (dBUV/m) = 20 log Emission level (uV/m).  
 Note 3: Corrected Reading: Antenna Factor + Cable Loss + Read Level - Preamp Factor = Level.  
 Note 4: Measurement receive antenna polarization: H (Horizontal), V (Vertical)

Band Edge and Fundamental Emissions					
Operating Mode	IEEE 802.11b CH 11 / Ant. 2			Polarization	V
Temperature	25.6°C	Humidity	56%	Test Engineer	Jim Huang

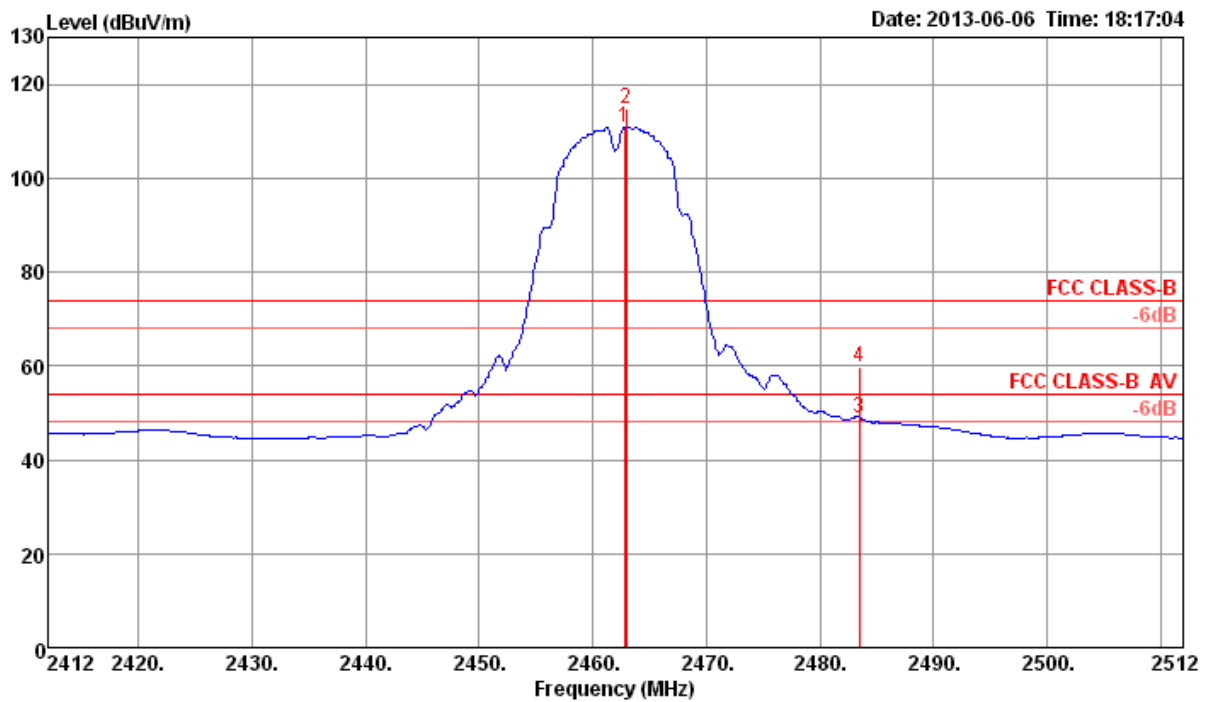

	Freq	Level	Limit	Over	Read	Cable	Antenna	Preamp	Remark	A/Pos	T/Pos	Pol/Phase
	MHz	dBuV/m	dBuV/m	dB	dBuV	dB	dB/m	dB		cm	deg	
1	2462.80	110.77			80.20	2.24	28.33	0.00	Average	100	150	VERTICAL
2	2462.96	114.84			84.27	2.24	28.33	0.00	Peak	100	150	VERTICAL
3	2483.50	48.89	54.00	-5.11	18.26	2.26	28.37	0.00	Average	100	150	VERTICAL
4	2483.50	59.71	74.00	-14.29	29.08	2.26	28.37	0.00	Peak	100	150	VERTICAL

Note 1: Item 1, 2 are the fundamental frequency at 2462MHz  
 Note 2: Emission level (dBuV/m) = 20 log Emission level (uV/m).  
 Note 3: Corrected Reading: Antenna Factor + Cable Loss + Read Level - Preamp Factor = Level.  
 Note 4: Measurement receive antenna polarization: H (Horizontal), V (Vertical)

Band Edge and Fundamental Emissions					
Operating Mode	IEEE 802.11g CH 1 / Ant. 1			Polarization	H
Temperature	25.6°C	Humidity	56%	Test Engineer	Jim Huang

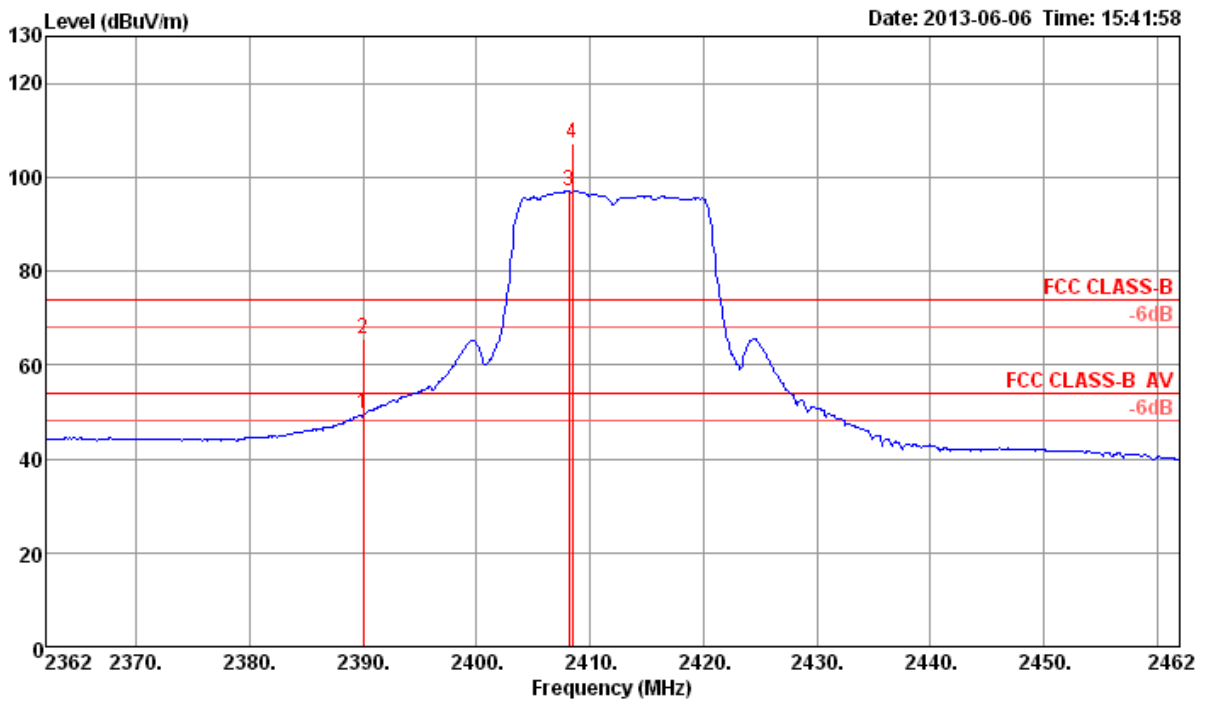

	Freq	Level	Limit	Over	Read	Cable	Antenna	Preamp	Remark	A/Pos	T/Pos	Pol/Phase
	MHz	dBuV/m	dBuV/m	dB	dBuV	dB	dB/m	dB		cm	deg	
1	2390.00	49.50	54.00	-4.50	19.11	2.22	28.17	0.00	Average	100	19	HORIZONTAL
2	2390.00	65.66	74.00	-8.34	35.27	2.22	28.17	0.00	Peak	100	19	HORIZONTAL
3	2408.15	97.04			66.61	2.22	28.21	0.00	Average	100	19	HORIZONTAL
4	2408.47	107.13			76.70	2.22	28.21	0.00	Peak	100	19	HORIZONTAL

Note 1: Item 3, 4 are the fundamental frequency at 2412 MHz  
 Note 2: Emission level (dBuV/m) = 20 log Emission level (uV/m).  
 Note 3: Corrected Reading: Antenna Factor + Cable Loss + Read Level - Preamp Factor = Level.  
 Note 4: Measurement receive antenna polarization: H (Horizontal), V (Vertical)

Band Edge and Fundamental Emissions					
Operating Mode	IEEE 802.11g CH 6 / Ant. 1			Polarization	V
Temperature	25.6°C	Humidity	56%	Test Engineer	Jim Huang

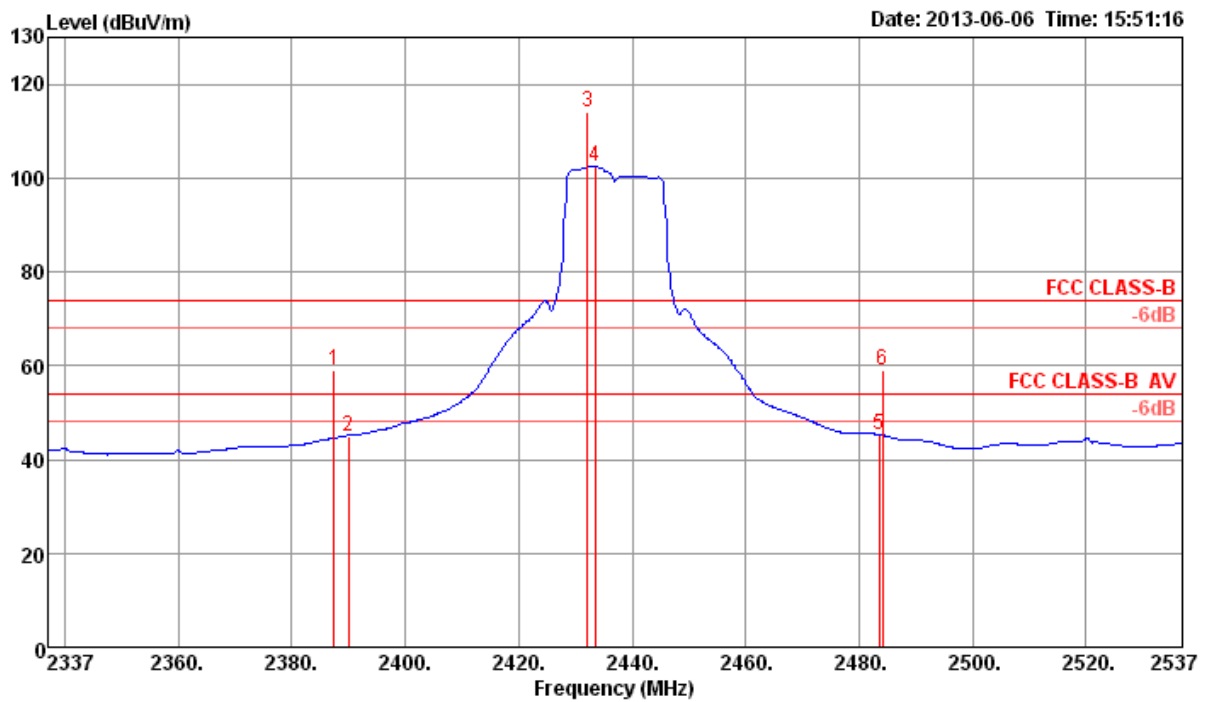

	Freq	Level	Limit	Over	Read	Cable	Antenna	Preamp	Remark	A/Pos	T/Pos	Pol/Phase
	MHz	dBuV/m	dBuV/m	dB	dBuV	dB	dB/m	dB		cm	deg	
1	2387.44	59.00	74.00	-15.00	28.62	2.21	28.17	0.00	Peak	100	22	VERTICAL
2	2390.00	45.08	54.00	-8.92	14.69	2.22	28.17	0.00	Average	100	22	VERTICAL
3	2432.19	114.23			83.75	2.23	28.25	0.00	Peak	100	22	VERTICAL
4	2433.47	102.51			72.03	2.23	28.25	0.00	Average	100	22	VERTICAL
5	2483.50	45.26	54.00	-8.74	14.63	2.26	28.37	0.00	Average	100	22	VERTICAL
6	2484.14	58.86	74.00	-15.14	28.23	2.26	28.37	0.00	Peak	100	22	VERTICAL

Note 1: Item 3, 4 are the fundamental frequency at 2437 MHz  
 Note 2: Emission level (dBuV/m) = 20 log Emission level (uV/m).  
 Note 3: Corrected Reading: Antenna Factor + Cable Loss + Read Level - Preamp Factor = Level.  
 Note 4: Measurement receive antenna polarization: H (Horizontal), V (Vertical)

Band Edge and Fundamental Emissions						
Operating Mode	IEEE 802.11g CH 11 / Ant. 1				Polarization	V
Temperature	25.6°C	Humidity	56%	Test Engineer	Jim Huang	

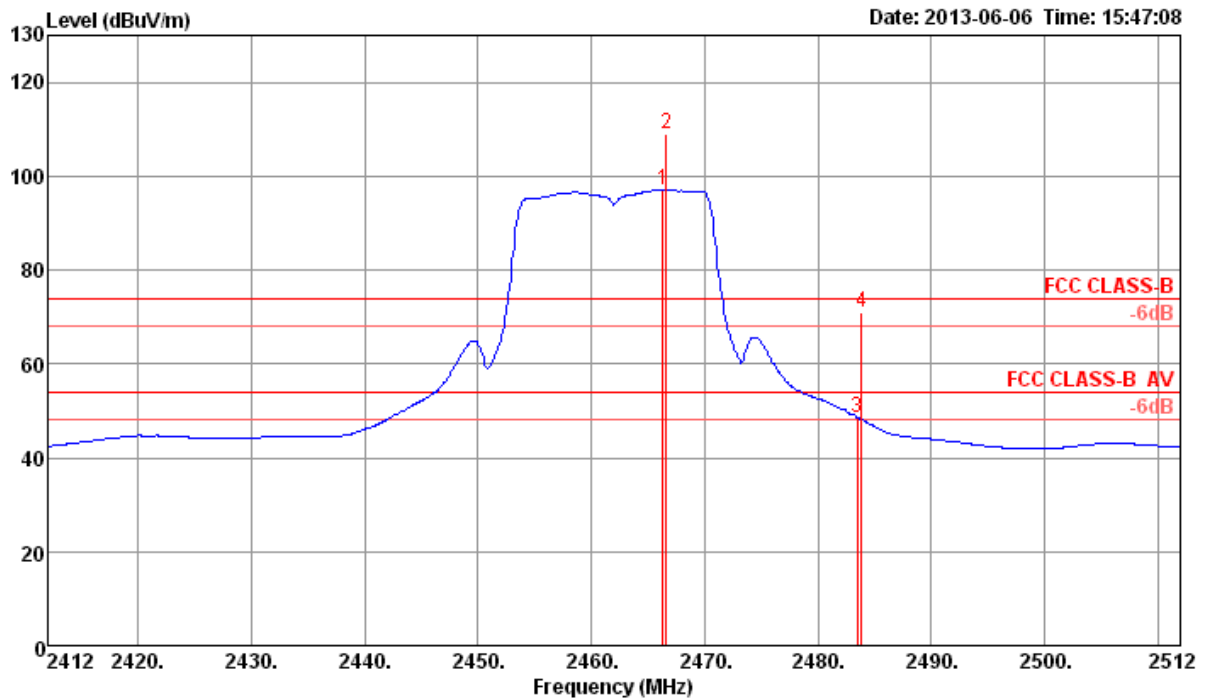

	Freq	Level	Limit	Over	Read	Cable	Antenna	Preamp	Remark	A/Pos	T/Pos	Pol/Phase
	MHz	dBuV/m	dBuV/m	dB	dBuV	dB	dB/m	dB		cm	deg	
1	2466.33	97.02			66.43	2.26	28.33	0.00	Average	100	22	VERTICAL
2	2466.65	108.88			78.29	2.26	28.33	0.00	Peak	100	22	VERTICAL
3	2483.50	48.50	54.00	-5.50	17.87	2.26	28.37	0.00	Average	100	22	VERTICAL
4	2483.82	71.10	74.00	-2.90	40.47	2.26	28.37	0.00	Peak	100	22	VERTICAL

Note 1: Item 1, 2 are the fundamental frequency at 2462MHz  
 Note 2: Emission level (dBuV/m) = 20 log Emission level (uV/m).  
 Note 3: Corrected Reading: Antenna Factor + Cable Loss + Read Level - Preamp Factor = Level.  
 Note 4: Measurement receive antenna polarization: H (Horizontal), V (Vertical)

Band Edge and Fundamental Emissions					
Operating Mode	IEEE 802.11g CH 1 / Ant. 2			Polarization	V
Temperature	25.6°C	Humidity	56%	Test Engineer	Jim Huang

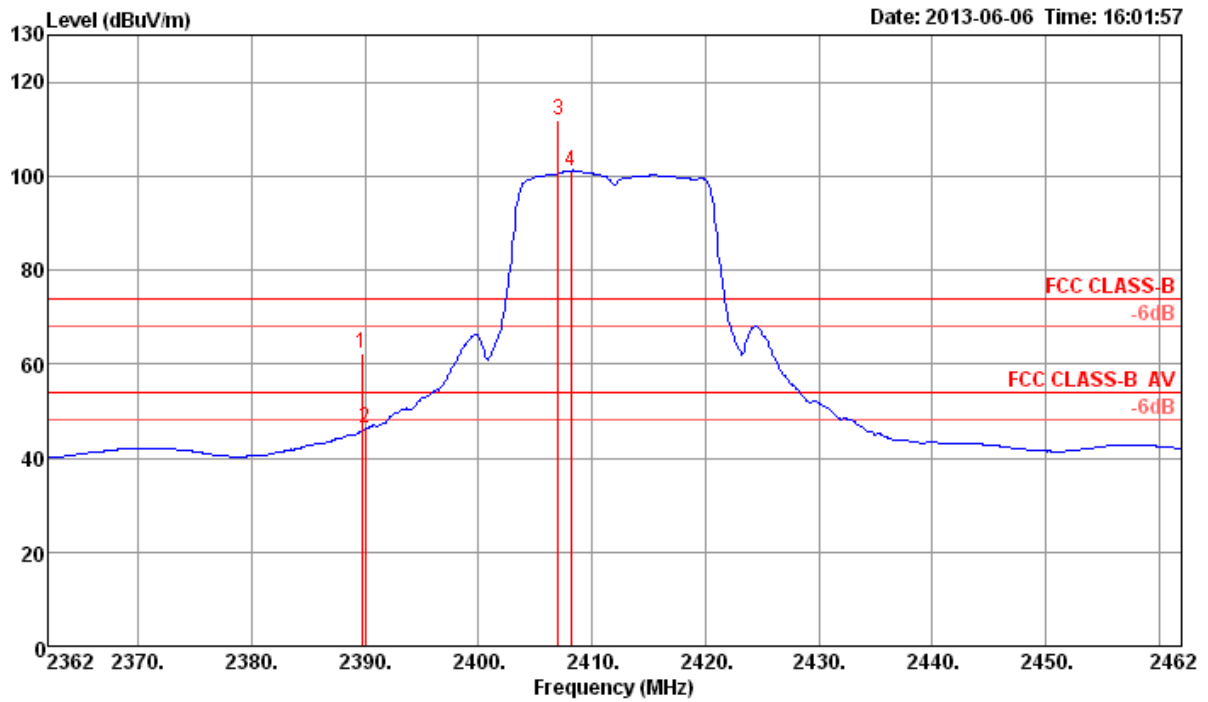

	Freq	Level	Limit	Over	Read	Cable	Antenna	Preamp	Remark	A/Pos	T/Pos	Pol/Phase
	MHz	dBuV/m	dBuV/m	dB	dBuV	dB	dB/m	dB		cm	deg	
1	2389.68	62.20	74.00	-11.80	31.82	2.21	28.17	0.00	Peak	100	358	VERTICAL
2	2390.00	46.28	54.00	-7.72	15.89	2.22	28.17	0.00	Average	100	358	VERTICAL
3	2407.03	111.91			81.48	2.22	28.21	0.00	Peak	100	358	VERTICAL
4	2408.15	101.14			70.71	2.22	28.21	0.00	Average	100	358	VERTICAL

Note 1: Item 3, 4 are the fundamental frequency at 2412 MHz  
 Note 2: Emission level (dBuV/m) = 20 log Emission level (uV/m).  
 Note 3: Corrected Reading: Antenna Factor + Cable Loss + Read Level - Preamp Factor = Level.  
 Note 4: Measurement receive antenna polarization: H (Horizontal), V (Vertical)

Band Edge and Fundamental Emissions					
Operating Mode	IEEE 802.11g CH 6 / Ant. 2			Polarization	V
Temperature	25.6°C	Humidity	56%	Test Engineer	Jim Huang

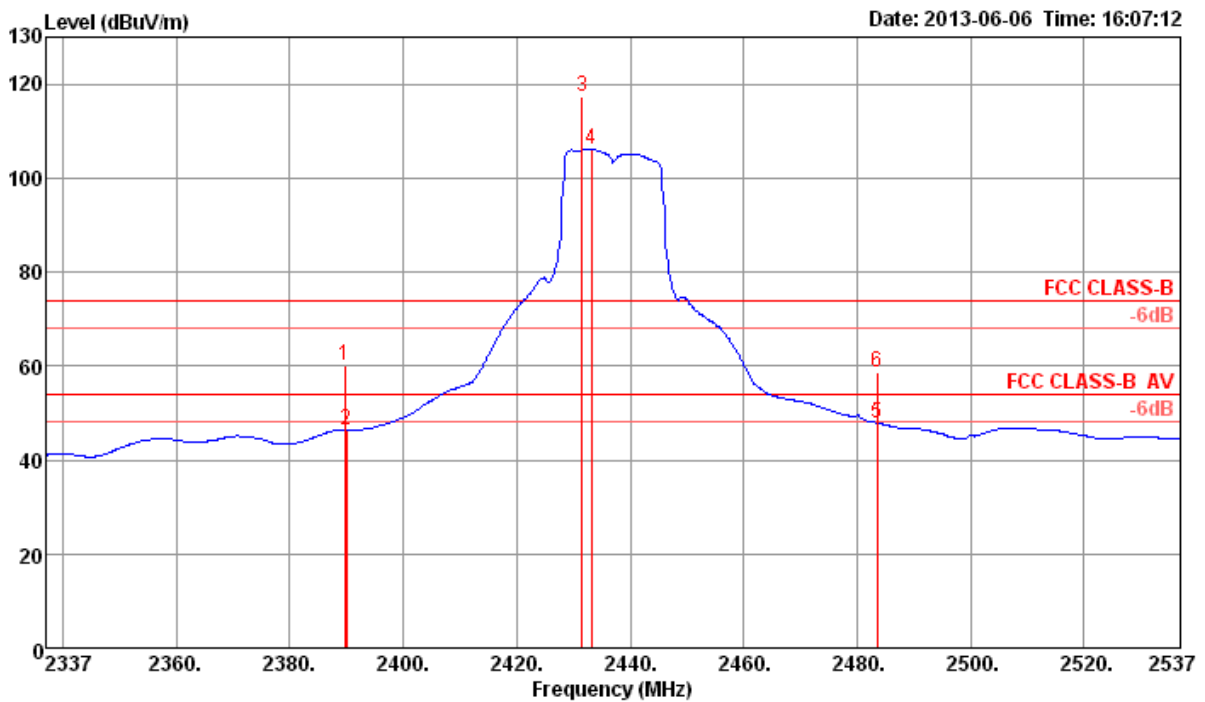

	Freq	Level	Limit	Over	Read	Cable	Antenna	Preamp	Remark	A/Pos	T/Pos	Pol/Phase
	MHz	dBuV/m	dBuV/m	dB	dBuV	dB	dB/m	dB		cm	deg	
1	2389.68	60.03	74.00	-13.97	29.65	2.21	28.17	0.00	Peak	100	336	VERTICAL
2	2390.00	46.39	54.00	-7.61	16.00	2.22	28.17	0.00	Average	100	336	VERTICAL
3	2431.55	117.17			86.69	2.23	28.25	0.00	Peak	100	336	VERTICAL
4	2433.15	106.12			75.64	2.23	28.25	0.00	Average	100	336	VERTICAL
5	2483.50	47.86	54.00	-6.14	17.23	2.26	28.37	0.00	Average	100	336	VERTICAL
6	2483.50	58.62	74.00	-15.38	27.99	2.26	28.37	0.00	Peak	100	336	VERTICAL

Note 1: Item 3, 4 are the fundamental frequency at 2437 MHz  
 Note 2: Emission level (dBuV/m) = 20 log Emission level (uV/m).  
 Note 3: Corrected Reading: Antenna Factor + Cable Loss + Read Level - Preamp Factor = Level.  
 Note 4: Measurement receive antenna polarization: H (Horizontal), V (Vertical)

Band Edge and Fundamental Emissions						
Operating Mode	IEEE 802.11g CH 11 / Ant. 2				Polarization	V
Temperature	25.6°C	Humidity	56%	Test Engineer	Jim Huang	

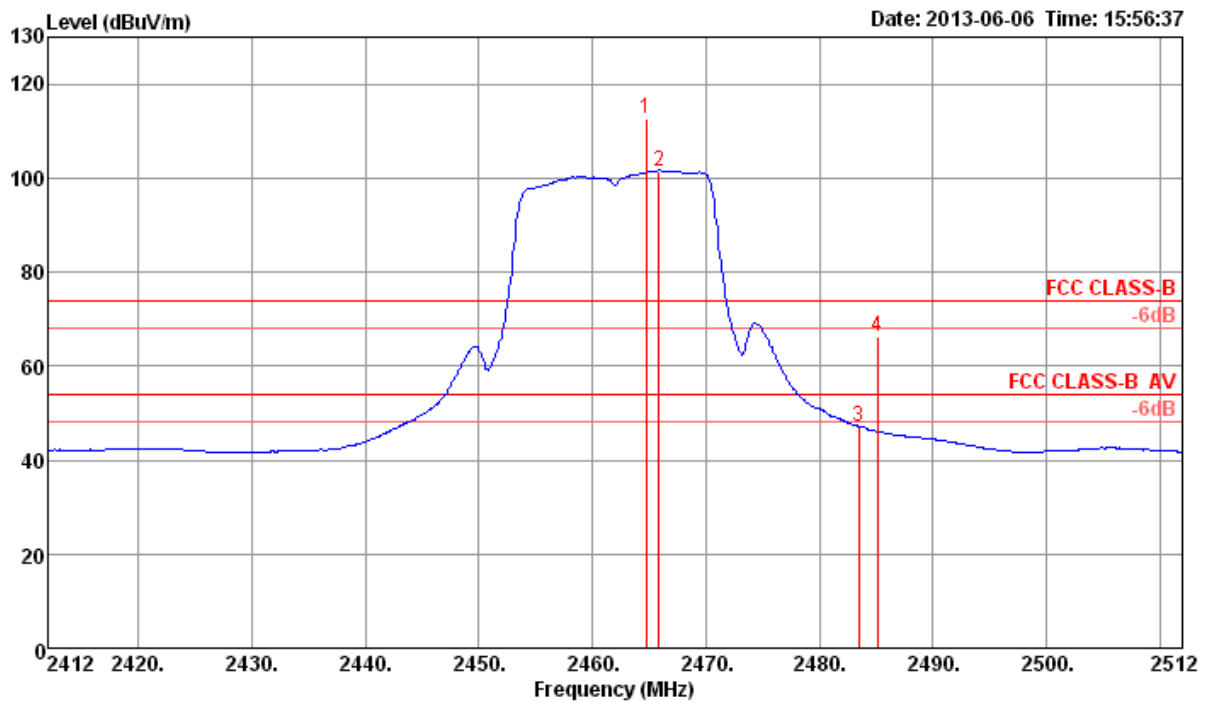

	Freq	Level	Limit	Over	Read	Cable	Antenna	Preamp	Remark	A/Pos	T/Pos	Pol/Phase
	MHz	dBuV/m	dBuV/m	dB	dBuV	dB	dB/m	dB		cm	deg	
1	2464.72	112.48			81.91	2.24	28.33	0.00	Peak	100	150	VERTICAL
2	2465.85	101.53			70.96	2.24	28.33	0.00	Average	100	150	VERTICAL
3	2483.50	47.11	54.00	-6.89	16.48	2.26	28.37	0.00	Average	100	150	VERTICAL
4	2485.10	66.42	74.00	-7.58	35.75	2.26	28.41	0.00	Peak	100	150	VERTICAL

Note 1: Item 1, 2 are the fundamental frequency at 2462MHz  
 Note 2: Emission level (dBuV/m) = 20 log Emission level (uV/m).  
 Note 3: Corrected Reading: Antenna Factor + Cable Loss + Read Level - Preamp Factor = Level.  
 Note 4: Measurement receive antenna polarization: H (Horizontal), V (Vertical)



Band Edge and Fundamental Emissions					
Operating Mode	IEEE 802.11n MCS0 20MHz CH 1 / Ant. 1			Polarization	H
Temperature	25.6°C	Humidity	56%	Test Engineer	Jim Huang

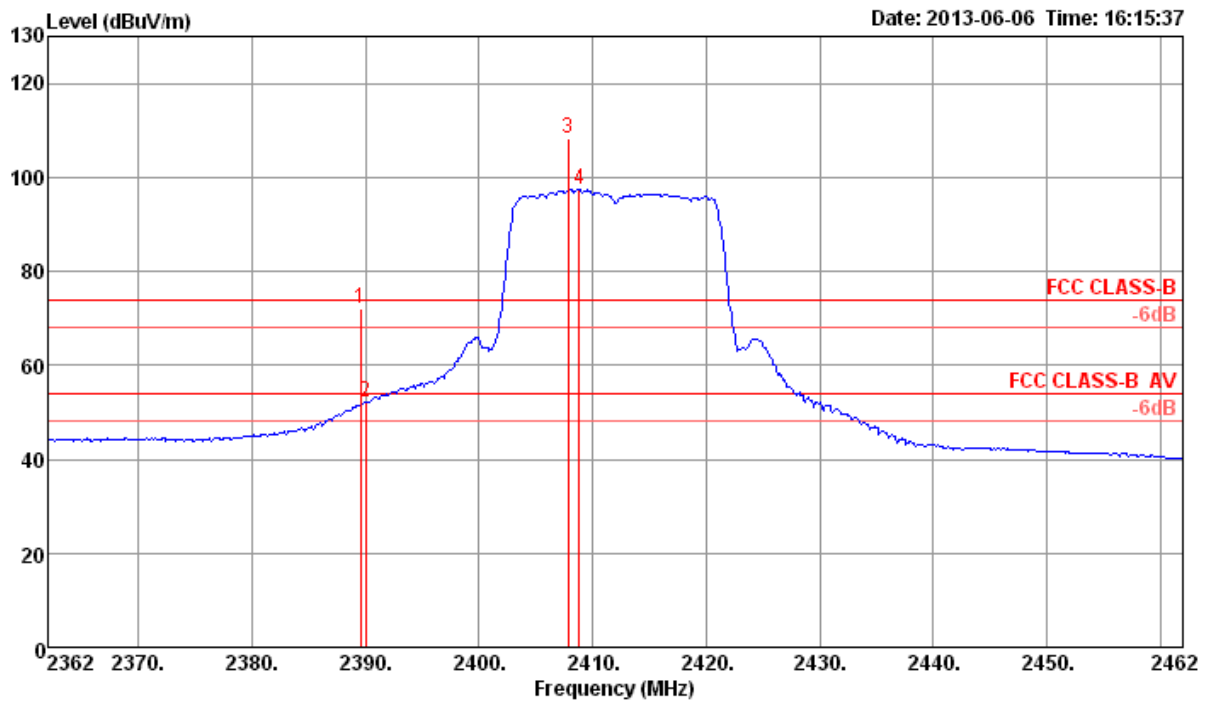

	Freq	Level	Limit	Over	Read	Cable	Antenna	Preamp	Remark	A/Pos	T/Pos	Pol/Phase
	MHz	dBuV/m	dBuV/m	dB	dBuV	dB	dB/m	dB		cm	deg	
1	2389.52	72.08	74.00	-1.92	41.70	2.21	28.17	0.00	Peak	100	18	HORIZONTAL
2	2390.00	52.16	54.00	-1.84	21.77	2.22	28.17	0.00	Average	100	18	HORIZONTAL
3	2407.83	108.40			77.97	2.22	28.21	0.00	Peak	100	18	HORIZONTAL
4	2408.80	97.36			66.93	2.22	28.21	0.00	Average	100	18	HORIZONTAL

Note 1: Item 3, 4 are the fundamental frequency at 2412 MHz  
 Note 2: Emission level (dBuV/m) = 20 log Emission level (uV/m).  
 Note 3: Corrected Reading: Antenna Factor + Cable Loss + Read Level - Preamp Factor = Level.  
 Note 4: Measurement receive antenna polarization: H (Horizontal), V (Vertical)

Band Edge and Fundamental Emissions					
Operating Mode	IEEE 802.11n MCS0 20MHz CH 6 / Ant. 1			Polarization	V
Temperature	25.6°C	Humidity	56%	Test Engineer	Jim Huang

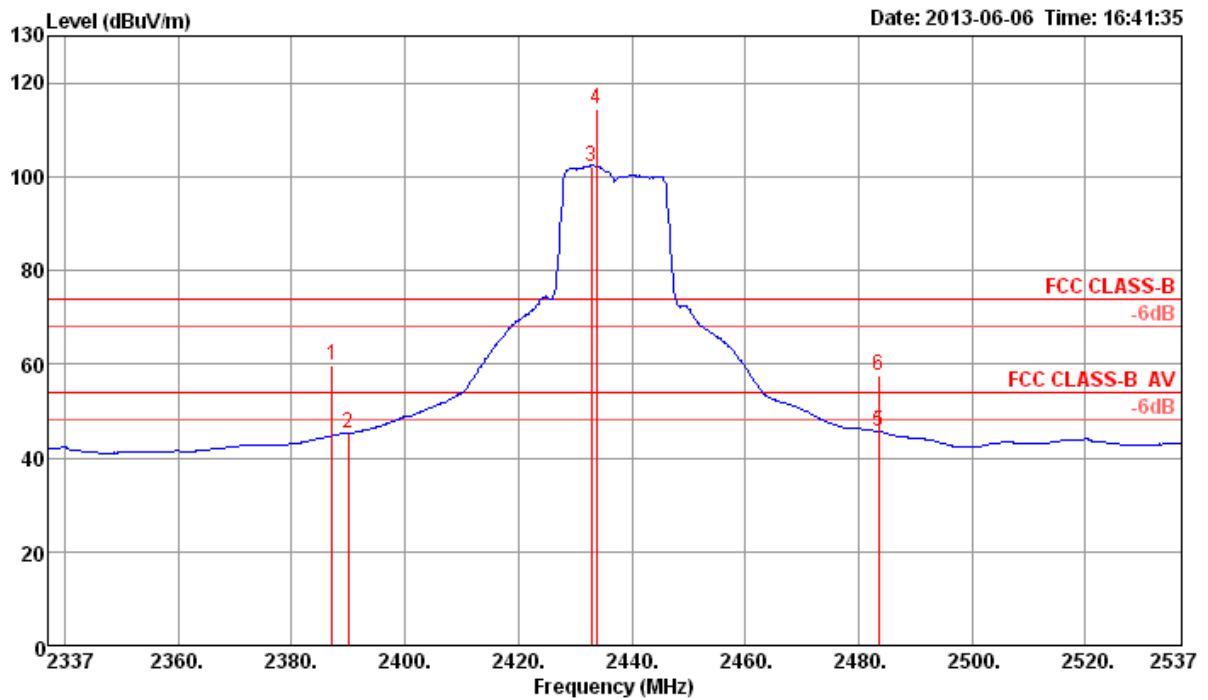

	Freq	Level	Limit	Over	Read	Cable	Antenna	Preamp	Remark	A/Pos	T/Pos	Pol/Phase
	MHz	dBuV/m	dBuV/m	dB	dBuV	dB	dB/m	dB		cm	deg	
1	2387.12	59.81	74.00	-14.19	29.43	2.21	28.17	0.00	Peak	100	23	VERTICAL
2	2390.00	45.20	54.00	-8.80	14.81	2.22	28.17	0.00	Average	100	23	VERTICAL
3	2432.83	102.27			71.79	2.23	28.25	0.00	Average	100	23	VERTICAL
4	2433.80	114.32			83.84	2.23	28.25	0.00	Peak	100	23	VERTICAL
5	2483.50	45.50	54.00	-8.50	14.87	2.26	28.37	0.00	Average	100	23	VERTICAL
6	2483.50	57.51	74.00	-16.49	26.88	2.26	28.37	0.00	Peak	100	23	VERTICAL

Note 1: Item 3, 4 are the fundamental frequency at 2437 MHz  
 Note 2: Emission level (dBuV/m) = 20 log Emission level (uV/m).  
 Note 3: Corrected Reading: Antenna Factor + Cable Loss + Read Level - Preamp Factor = Level.  
 Note 4: Measurement receive antenna polarization: H (Horizontal), V (Vertical)

Band Edge and Fundamental Emissions					
Operating Mode	IEEE 802.11n MCS0 20MHz CH 11 / Ant. 1			Polarization	V
Temperature	25.6°C	Humidity	56%	Test Engineer	Jim Huang

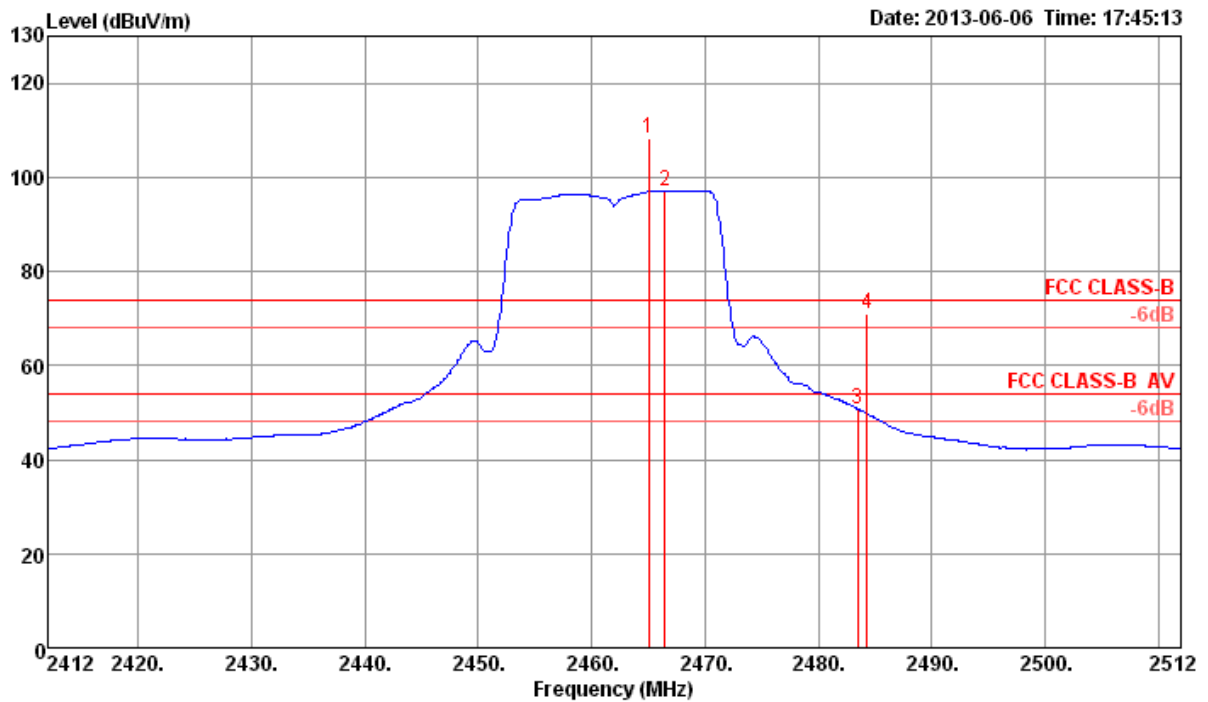

	Freq	Level	Limit	Over	Read	Cable	Antenna	Preamp	Remark	A/Pos	T/Pos	Pol/Phase
	MHz	dBuV/m	dBuV/m	dB	dBuV	dB	dB/m	dB		cm	deg	
1	2465.05	108.31			77.74	2.24	28.33	0.00	Peak	99	21	VERTICAL
2	2466.49	97.13			66.54	2.26	28.33	0.00	Average	99	21	VERTICAL
3	2483.50	50.72	54.00	-3.28	20.09	2.26	28.37	0.00	Average	99	21	VERTICAL
4	2484.30	70.83	74.00	-3.17	40.20	2.26	28.37	0.00	Peak	99	21	VERTICAL

Note 1: Item 1, 2 are the fundamental frequency at 2462MHz  
 Note 2: Emission level (dBuV/m) = 20 log Emission level (uV/m).  
 Note 3: Corrected Reading: Antenna Factor + Cable Loss + Read Level - Preamp Factor = Level.  
 Note 4: Measurement receive antenna polarization: H (Horizontal), V (Vertical)

Band Edge and Fundamental Emissions					
Operating Mode	IEEE 802.11n MCS0 20MHz CH 1 / Ant. 2			Polarization	V
Temperature	25.6°C	Humidity	56%	Test Engineer	Jim Huang

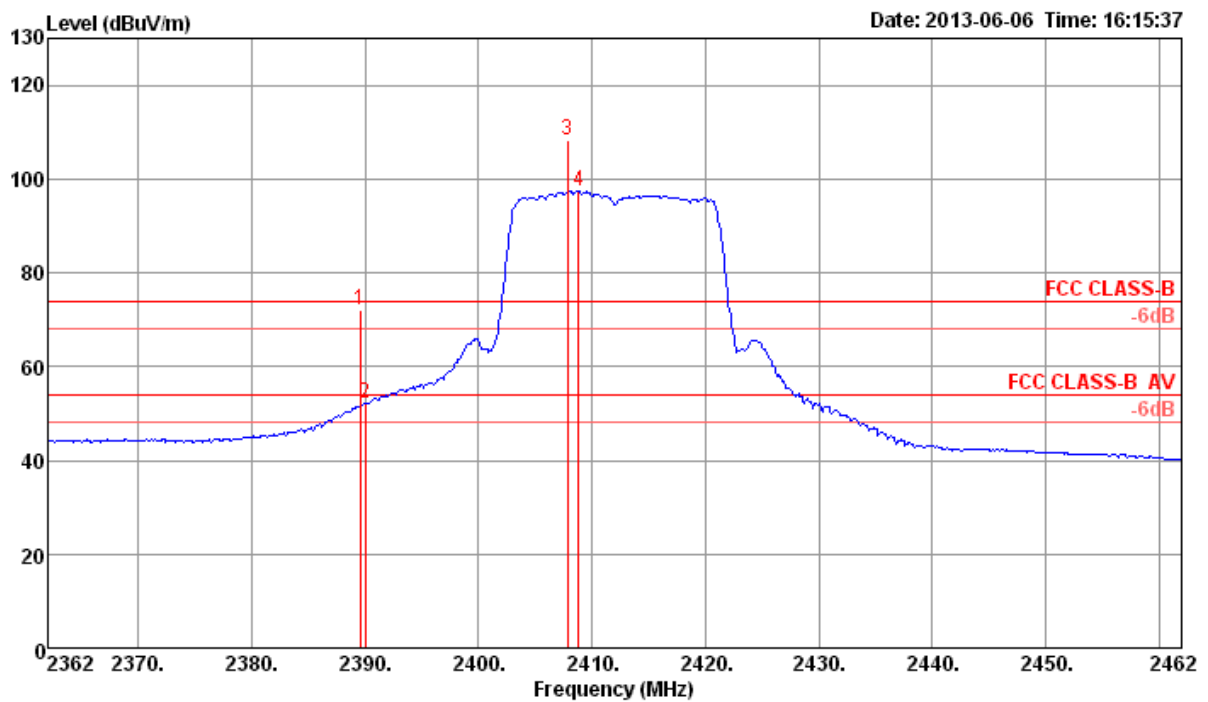

	Freq	Level	Limit Line	Over Limit	Read Level	Cable Loss	Antenna Factor	Preamp Factor	Remark	A/Pos	T/Pos	Pol/Phase
	MHz	dBuV/m	dBuV/m	dB	dBuV	dB	dB/m	dB		cm	deg	
1	2389.52	72.08	74.00	-1.92	41.70	2.21	28.17	0.00	Peak	100	18	HORIZONTAL
2	2390.00	52.16	54.00	-1.84	21.77	2.22	28.17	0.00	Average	100	18	HORIZONTAL
3	2407.83	108.40			77.97	2.22	28.21	0.00	Peak	100	18	HORIZONTAL
4	2408.80	97.36			66.93	2.22	28.21	0.00	Average	100	18	HORIZONTAL

Note 1: Item 3, 4 are the fundamental frequency at 2412 MHz  
 Note 2: Emission level (dBuV/m) = 20 log Emission level (uV/m).  
 Note 3: Corrected Reading: Antenna Factor + Cable Loss + Read Level - Preamp Factor = Level.  
 Note 4: Measurement receive antenna polarization: H (Horizontal), V (Vertical)

Band Edge and Fundamental Emissions					
Operating Mode	IEEE 802.11n MCS0 20MHz CH 6 / Ant. 2			Polarization	V
Temperature	25.6°C	Humidity	56%	Test Engineer	Jim Huang

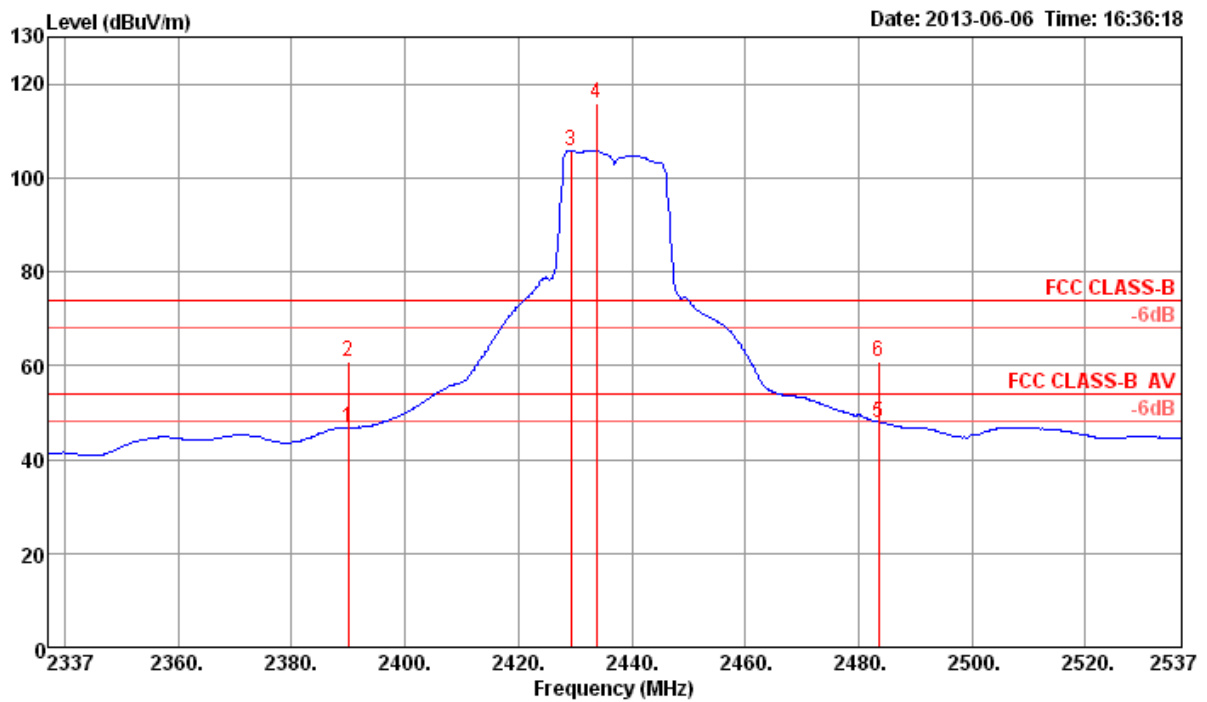

	Freq	Level	Limit	Over	Read	Cable	Antenna	Preamp	Remark	A/Pos	T/Pos	Pol/Phase
	MHz	dBuV/m	dBuV/m	dB	dBuV	dB	dB/m	dB		cm	deg	
1	2390.00	46.86	54.00	-7.14	16.47	2.22	28.17	0.00	Average	100	336	VERTICAL
2	2390.00	60.92	74.00	-13.08	30.53	2.22	28.17	0.00	Peak	100	336	VERTICAL
3	2429.31	105.80			75.32	2.23	28.25	0.00	Average	100	336	VERTICAL
4	2433.80	116.00			85.52	2.23	28.25	0.00	Peak	100	336	VERTICAL
5	2483.50	47.96	54.00	-6.04	17.33	2.26	28.37	0.00	Average	100	336	VERTICAL
6	2483.50	60.74	74.00	-13.26	30.11	2.26	28.37	0.00	Peak	100	336	VERTICAL

Note 1: Item 3, 4 are the fundamental frequency at 2437 MHz  
 Note 2: Emission level (dBuV/m) = 20 log Emission level (uV/m).  
 Note 3: Corrected Reading: Antenna Factor + Cable Loss + Read Level - Preamp Factor = Level.  
 Note 4: Measurement receive antenna polarization: H (Horizontal), V (Vertical)

Band Edge and Fundamental Emissions					
Operating Mode	IEEE 802.11n MCS0 20MHz CH 11 / Ant. 2			Polarization	V
Temperature	25.6°C	Humidity	56%	Test Engineer	Jim Huang

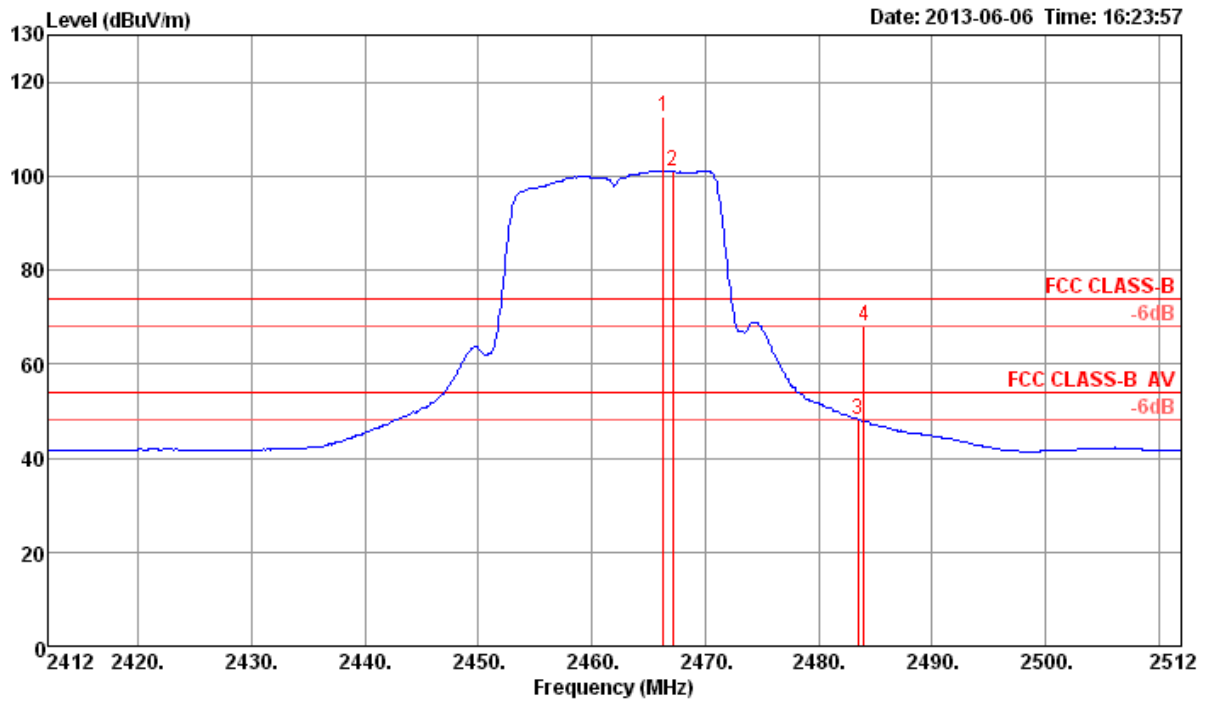

	Freq	Level	Limit	Over	Read	Cable	Antenna	Preamp	Remark	A/Pos	T/Pos	Pol/Phase
	MHz	dBuV/m	dBuV/m	dB	dBuV	dB	dB/m	dB		cm	deg	
1	2466.33	112.63			82.04	2.26	28.33	0.00	Peak	100	150	VERTICAL
2	2467.13	101.10			70.51	2.26	28.33	0.00	Average	100	150	VERTICAL
3	2483.50	48.29	54.00	-5.71	17.66	2.26	28.37	0.00	Average	100	150	VERTICAL
4	2483.98	68.05	74.00	-5.95	37.42	2.26	28.37	0.00	Peak	100	150	VERTICAL

Note 1: Item 1, 2 are the fundamental frequency at 2462MHz  
 Note 2: Emission level (dBuV/m) = 20 log Emission level (uV/m).  
 Note 3: Corrected Reading: Antenna Factor + Cable Loss + Read Level - Preamp Factor = Level.  
 Note 4: Measurement receive antenna polarization: H (Horizontal), V (Vertical)

Band Edge and Fundamental Emissions					
Operating Mode	IEEE 802.11n MCS8 20MHz CH 1 / Ant. 1 + Ant. 2			Polarization	V
Temperature	25.6°C	Humidity	56%	Test Engineer	Jim Huang

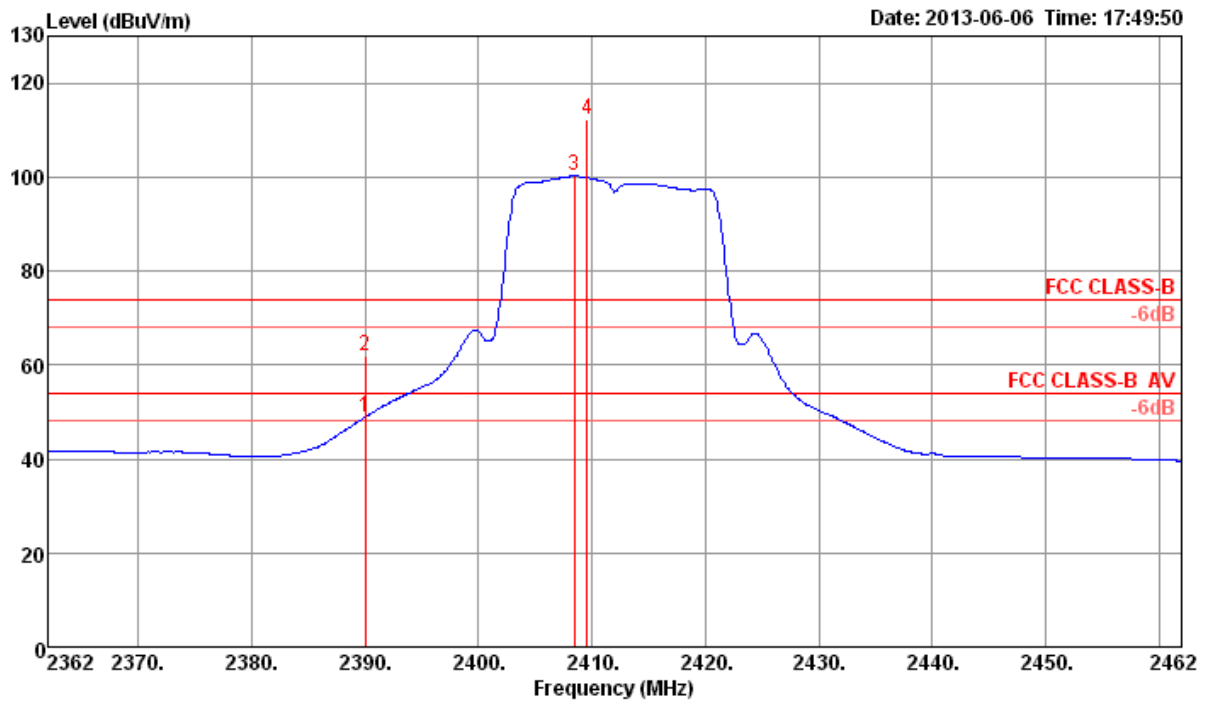

	Freq	Level	Limit	Over	Read	Cable	Antenna	Preamp	Remark	A/Pos	T/Pos	Pol/Phase
	MHz	dBuV/m	dBuV/m	dB	dBuV	dB	dB/m	dB		cm	deg	
1	2390.00	48.98	54.00	-5.02	18.59	2.22	28.17	0.00	Average	100	292	VERTICAL
2	2390.00	61.88	74.00	-12.12	31.49	2.22	28.17	0.00	Peak	100	292	VERTICAL
3	2408.47	100.19			69.76	2.22	28.21	0.00	Average	100	292	VERTICAL
4	2409.60	112.24			81.81	2.22	28.21	0.00	Peak	100	292	VERTICAL

Note 1: Item 3, 4 are the fundamental frequency at 2412 MHz  
 Note 2: Emission level (dBuV/m) = 20 log Emission level (uV/m).  
 Note 3: Corrected Reading: Antenna Factor + Cable Loss + Read Level - Preamp Factor = Level.  
 Note 4: Measurement receive antenna polarization: H (Horizontal), V (Vertical)

Band Edge and Fundamental Emissions					
Operating Mode	IEEE 802.11n MCS8 20MHz CH 6 / Ant. 1 + Ant. 2			Polarization	V
Temperature	25.6°C	Humidity	56%	Test Engineer	Jim Huang

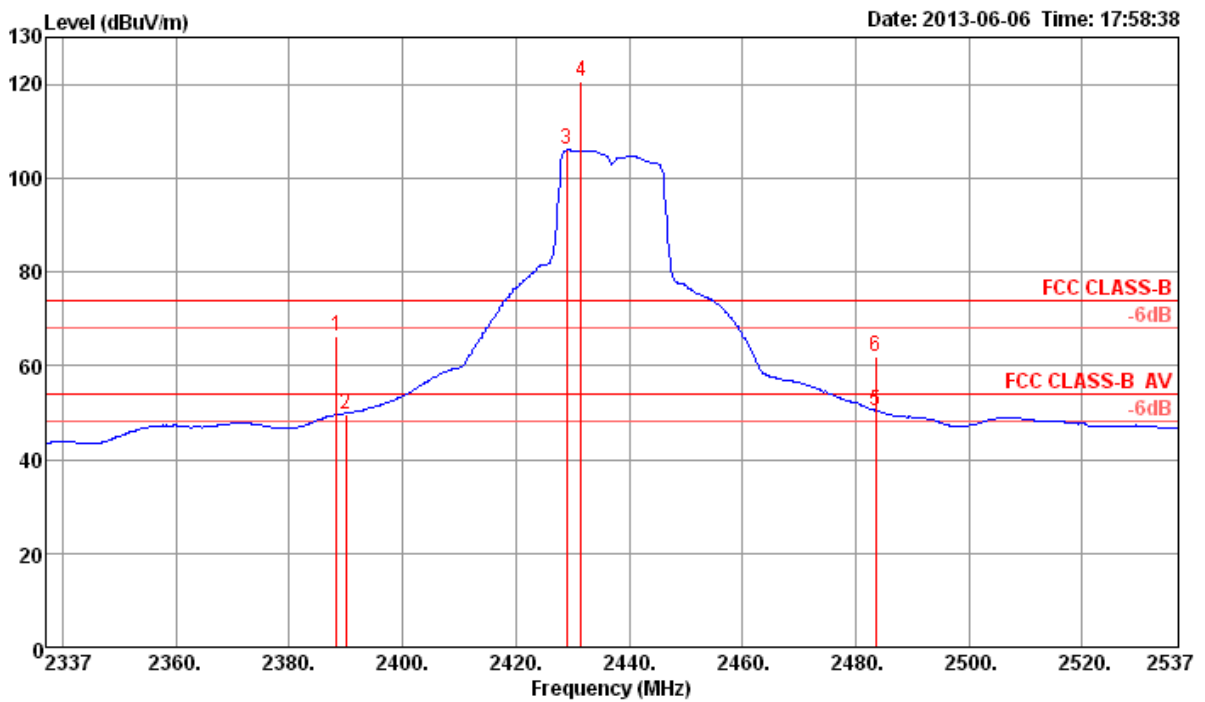

	Freq	Level	Limit	Over	Read	Cable	Antenna	Preamp	Remark	A/Pos	T/Pos	Pol/Phase
	MHz	dBuV/m	dBuV/m	dB	dBuV	dB	dB/m	dB		cm	deg	
1	2388.40	66.09	74.00	-7.91	35.71	2.21	28.17	0.00	Peak	100	334	VERTICAL
2	2390.00	49.79	54.00	-4.21	19.40	2.22	28.17	0.00	Average	100	334	VERTICAL
3	2428.99	105.99			75.51	2.23	28.25	0.00	Average	100	334	VERTICAL
4	2431.55	120.49			90.01	2.23	28.25	0.00	Peak	100	334	VERTICAL
5	2483.50	50.37	54.00	-3.63	19.74	2.26	28.37	0.00	Average	100	334	VERTICAL
6	2483.50	61.99	74.00	-12.01	31.36	2.26	28.37	0.00	Peak	100	334	VERTICAL

Note 1: Item 3, 4 are the fundamental frequency at 2437 MHz  
 Note 2: Emission level (dBuV/m) = 20 log Emission level (uV/m).  
 Note 3: Corrected Reading: Antenna Factor + Cable Loss + Read Level - Preamp Factor = Level.  
 Note 4: Measurement receive antenna polarization: H (Horizontal), V (Vertical)



Band Edge and Fundamental Emissions					
Operating Mode	IEEE 802.11n MCS8 20MHz CH 11 / Ant. 1 + Ant. 2			Polarization	V
Temperature	25.6°C	Humidity	56%	Test Engineer	Jim Huang

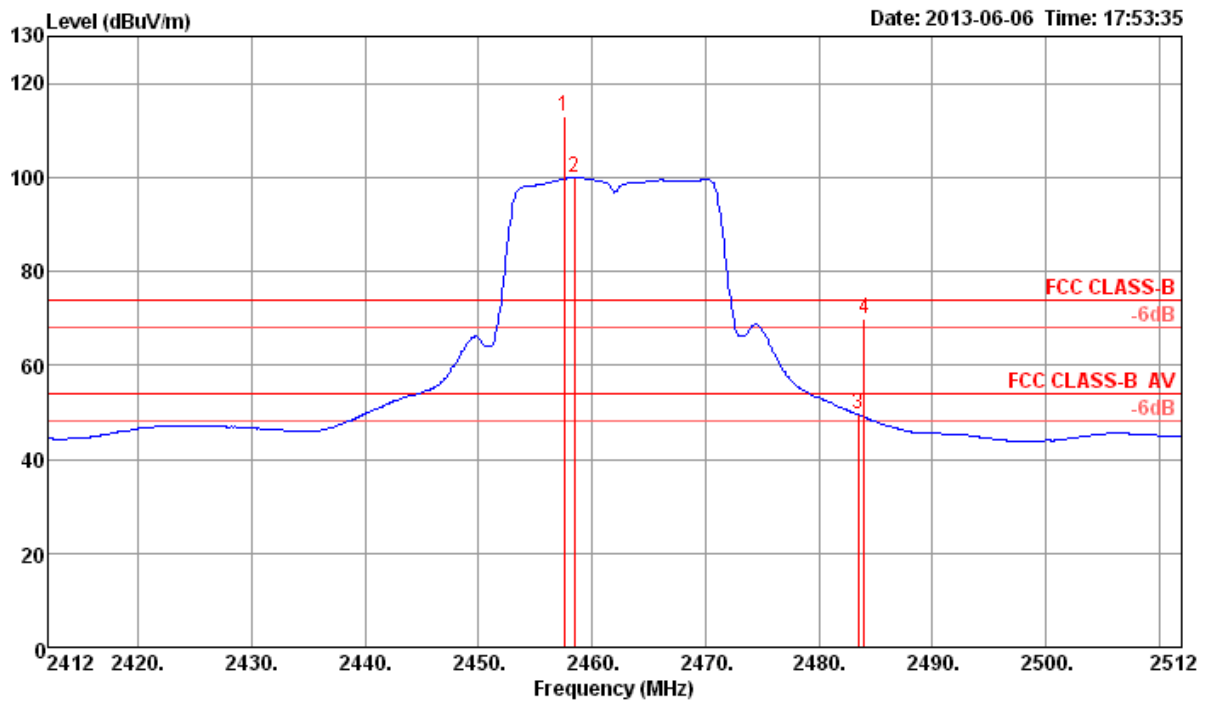

	Freq	Level	Limit	Over	Read	Cable	Antenna	Preamp	Remark	A/Pos	T/Pos	Pol/Phase
	MHz	dBuV/m	dBuV/m	dB	dBuV	dB	dB/m	dB		cm	deg	
1	2457.51	112.95			82.38	2.24	28.33	0.00	Peak	101	335	VERTICAL
2	2458.47	100.04			69.47	2.24	28.33	0.00	Average	101	335	VERTICAL
3	2483.50	49.53	54.00	-4.47	18.90	2.26	28.37	0.00	Average	101	335	VERTICAL
4	2483.98	69.83	74.00	-4.17	39.20	2.26	28.37	0.00	Peak	101	335	VERTICAL

Note 1: Item 1, 2 are the fundamental frequency at 2462MHz  
 Note 2: Emission level (dBuV/m) = 20 log Emission level (uV/m).  
 Note 3: Corrected Reading: Antenna Factor + Cable Loss + Read Level - Preamp Factor = Level.  
 Note 4: Measurement receive antenna polarization: H (Horizontal), V (Vertical)

Band Edge and Fundamental Emissions					
Operating Mode	IEEE 802.11n MCS0 40MHz CH 3 / Ant. 1			Polarization	V
Temperature	25.6°C	Humidity	56%	Test Engineer	Jim Huang

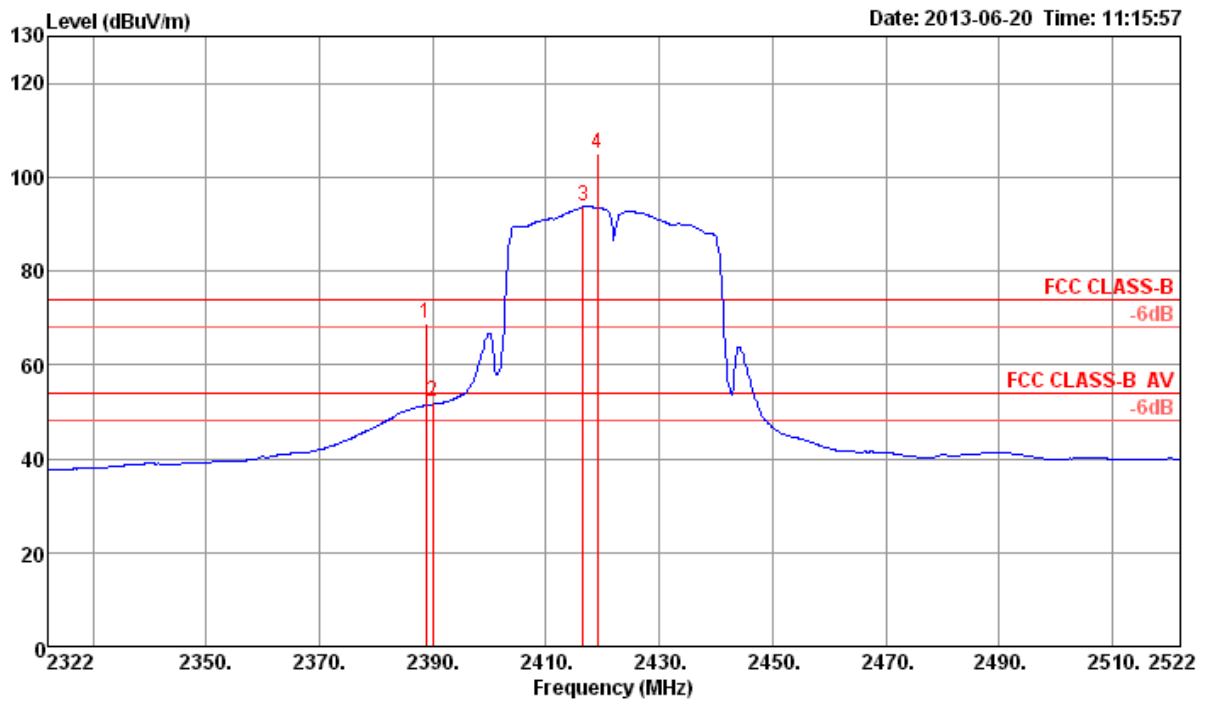

	Freq	Level	Limit	Over	Read	Cable	Antenna	Preamp	Remark	A/Pos	T/Pos	Pol/Phase
	MHz	dBuV/m	dBuV/m	dB	dBuV	dB	dB/m	dB		cm	deg	
1	2388.72	68.73	74.00	-5.27	38.35	2.21	28.17	0.00	Peak	100	47	VERTICAL
2	2390.00	52.22	54.00	-1.78	21.83	2.22	28.17	0.00	Average	100	47	VERTICAL
3	2416.55	93.72			63.28	2.23	28.21	0.00	Average	100	47	VERTICAL
4	2419.12	105.09			74.61	2.23	28.25	0.00	Peak	100	47	VERTICAL

Note 1: Item 3, 4 are the fundamental frequency at 2422 MHz  
 Note 2: Emission level (dBuV/m) = 20 log Emission level (uV/m).  
 Note 3: Corrected Reading: Antenna Factor + Cable Loss + Read Level - Preamp Factor = Level.  
 Note 4: Measurement receive antenna polarization: H (Horizontal), V (Vertical)

Band Edge and Fundamental Emissions					
Operating Mode	IEEE 802.11n MCS0 40MHz CH 6 / Ant. 1			Polarization	V
Temperature	25.6°C	Humidity	56%	Test Engineer	Jim Huang

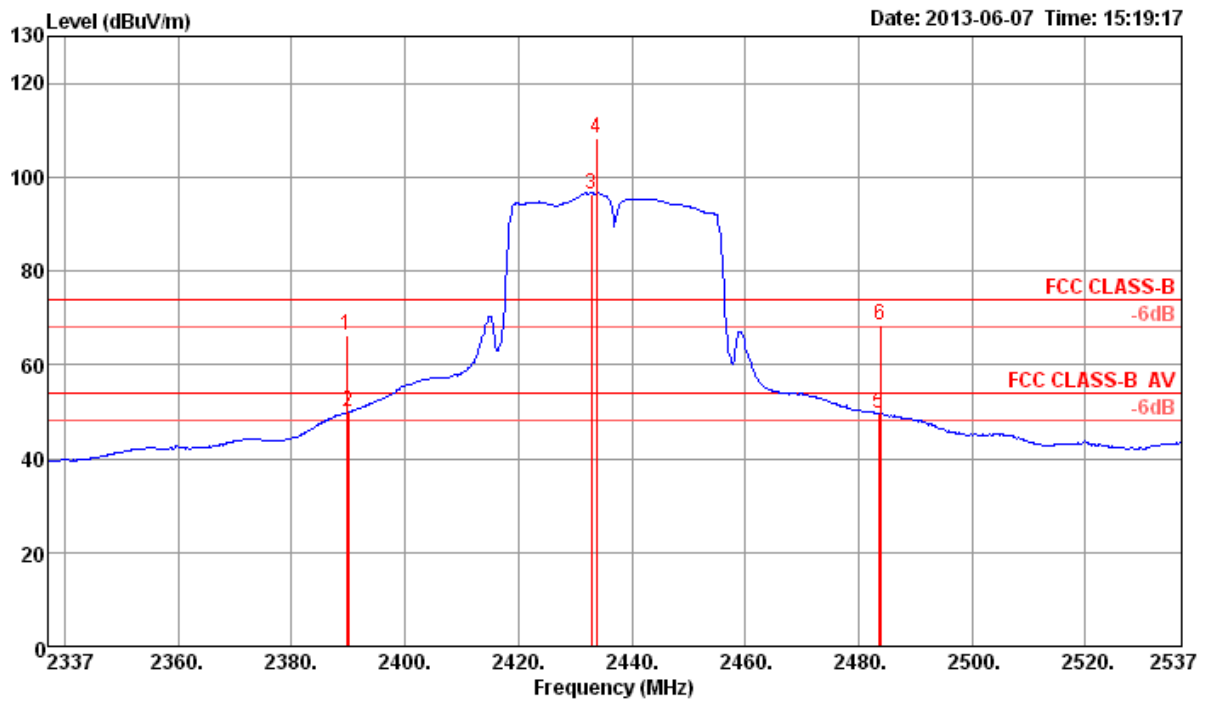

	Freq	Level	Limit	Over	Read	Cable	Antenna	Preamp	Remark	A/Pos	T/Pos	Pol/Phase
	MHz	dBuV/m	dBuV/m	dB	dBuV	dB	dB/m	dB		cm	deg	
1	2389.68	66.21	74.00	-7.79	35.83	2.21	28.17	0.00	Peak	100	25	VERTICAL
2	2390.00	49.87	54.00	-4.13	19.48	2.22	28.17	0.00	Average	100	25	VERTICAL
3	2432.83	96.50			66.02	2.23	28.25	0.00	Average	100	25	VERTICAL
4	2433.80	108.42			77.94	2.23	28.25	0.00	Peak	100	25	VERTICAL
5	2483.50	49.60	54.00	-4.40	18.97	2.26	28.37	0.00	Average	100	25	VERTICAL
6	2483.82	68.34	74.00	-5.66	37.71	2.26	28.37	0.00	Peak	100	25	VERTICAL

Note 1: Item 3, 4 are the fundamental frequency at 2437 MHz  
 Note 2: Emission level (dBuV/m) = 20 log Emission level (uV/m).  
 Note 3: Corrected Reading: Antenna Factor + Cable Loss + Read Level - Preamp Factor = Level.  
 Note 4: Measurement receive antenna polarization: H (Horizontal), V (Vertical)

Band Edge and Fundamental Emissions					
Operating Mode	IEEE 802.11n MCS0 40MHz CH 9 / Ant. 1			Polarization	V
Temperature	25.6°C	Humidity	56%	Test Engineer	Jim Huang

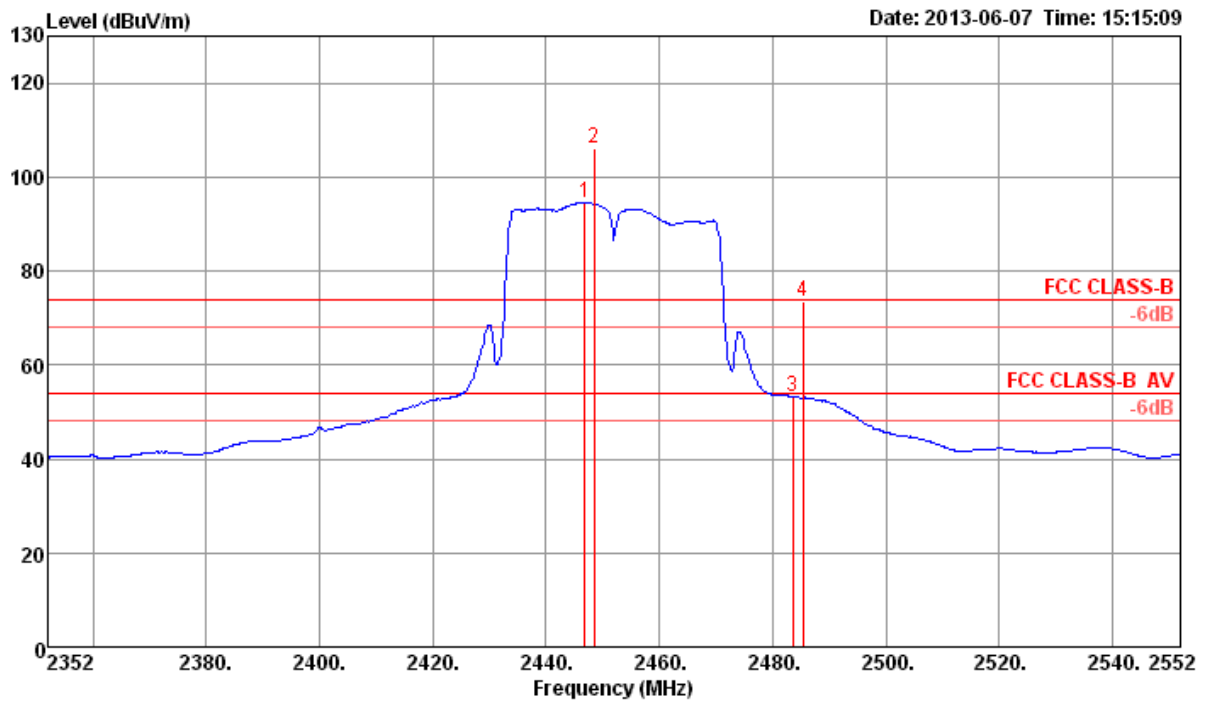

	Freq	Level	Limit	Over	Read	Cable	Antenna	Preamp	Remark	A/Pos	T/Pos	Pol/Phase
	MHz	dBuV/m	dBuV/m	dB	dBuV	dB	dB/m	dB		cm	deg	
1	2446.87	94.64			64.11	2.24	28.29	0.00	Average	100	26	VERTICAL
2	2448.47	106.04			75.51	2.24	28.29	0.00	Peak	100	26	VERTICAL
3	2483.50	53.21	54.00	-0.79	22.58	2.26	28.37	0.00	Average	100	26	VERTICAL
4	2485.42	73.33	74.00	-0.67	42.66	2.26	28.41	0.00	Peak	100	26	VERTICAL

Note 1: Item 1, 2 are the fundamental frequency at 2452 MHz  
 Note 2: Emission level (dBuV/m) = 20 log Emission level (uV/m).  
 Note 3: Corrected Reading: Antenna Factor + Cable Loss + Read Level - Preamp Factor = Level.  
 Note 4: Measurement receive antenna polarization: H (Horizontal), V (Vertical)

Band Edge and Fundamental Emissions					
Operating Mode	IEEE 802.11n MCS0 40MHz CH 3 / Ant. 2			Polarization	V
Temperature	25.6°C	Humidity	56%	Test Engineer	Jim Huang

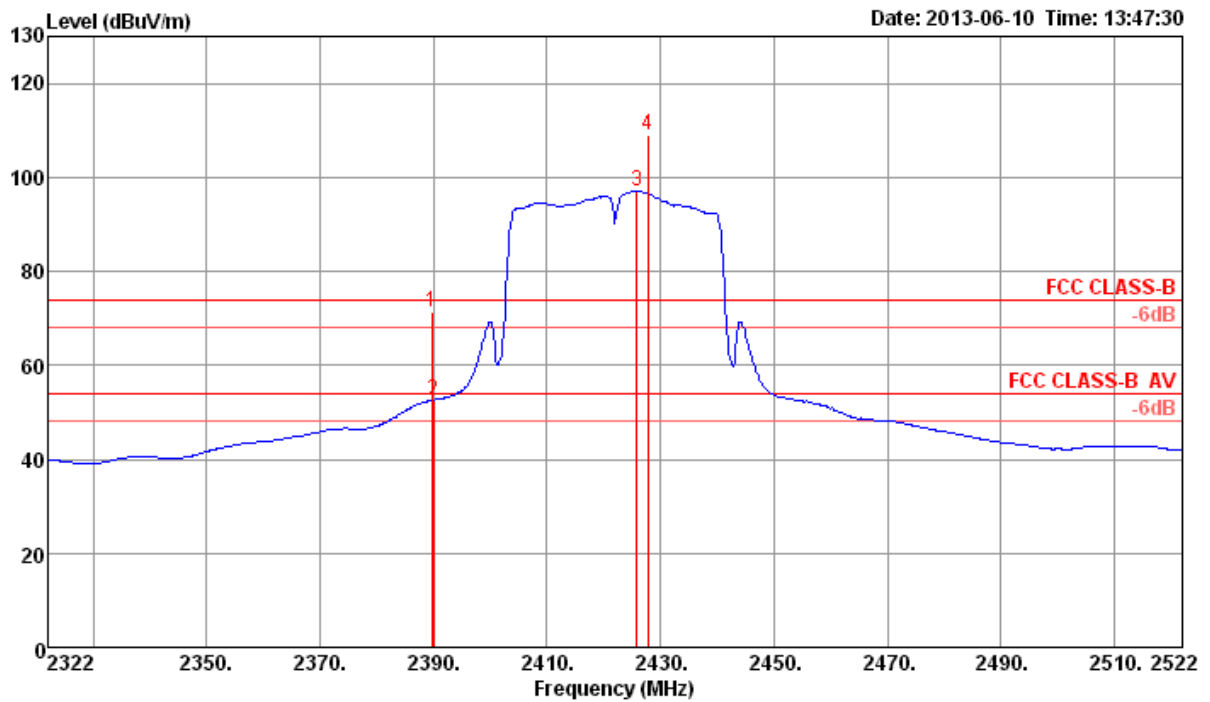

	Freq	Level	Limit	Over	Read	Cable	Antenna	Preamp	Remark	A/Pos	T/Pos	Pol/Phase
	MHz	dBuV/m	dBuV/m	dB	dBuV	dB	dB/m	dB		cm	deg	
1	2389.68	71.36	74.00	-2.64	40.98	2.21	28.17	0.00	Peak	100	335	VERTICAL
2	2390.00	52.54	54.00	-1.46	22.15	2.22	28.17	0.00	Average	100	335	VERTICAL
3	2425.85	96.90			66.42	2.23	28.25	0.00	Average	100	335	VERTICAL
4	2427.77	109.03			78.55	2.23	28.25	0.00	Peak	100	335	VERTICAL

Note 1: Item 3, 4 are the fundamental frequency at 2422 MHz  
 Note 2: Emission level (dBuV/m) = 20 log Emission level (uV/m).  
 Note 3: Corrected Reading: Antenna Factor + Cable Loss + Read Level - Preamp Factor = Level.  
 Note 4: Measurement receive antenna polarization: H (Horizontal), V (Vertical)

Band Edge and Fundamental Emissions					
Operating Mode	IEEE 802.11n MCS0 40MHz CH 6 / Ant. 2			Polarization	V
Temperature	25.6°C	Humidity	56%	Test Engineer	Jim Huang

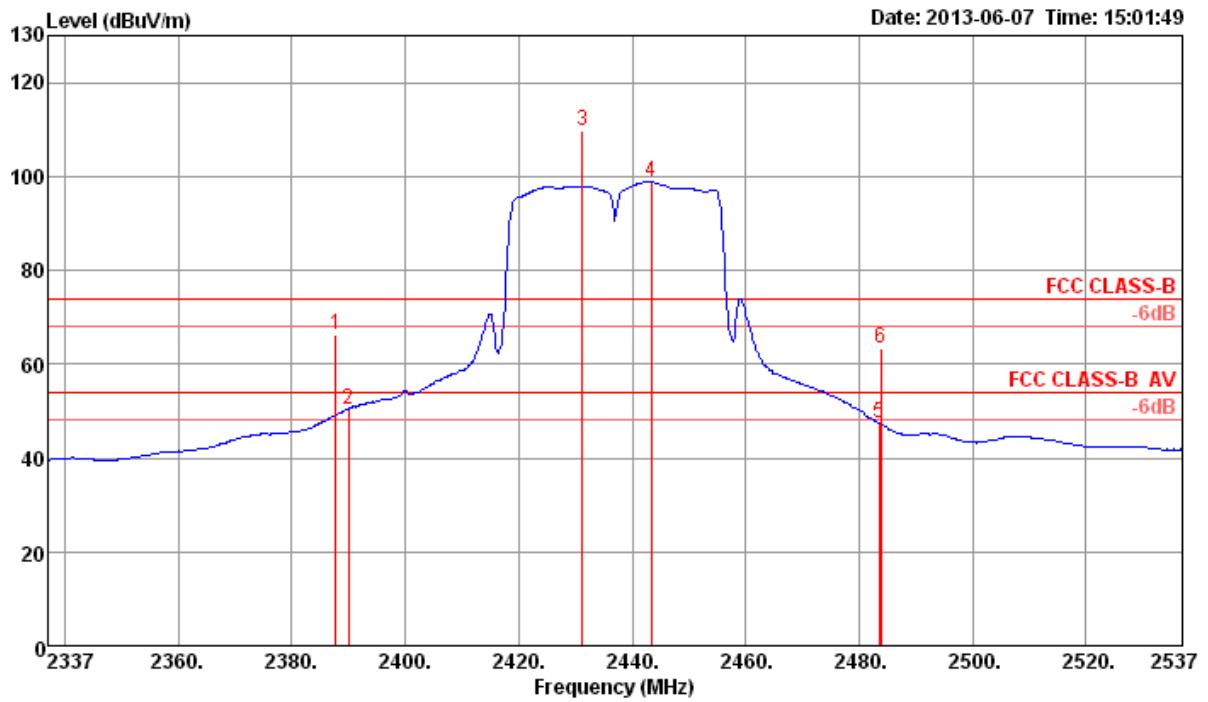

	Freq	Level	Limit	Over	Read	Cable	Antenna	Preamp	Remark	A/Pos	T/Pos	Pol/Phase
	MHz	dBuV/m	dBuV/m	dB	dBuV	dB	dB/m	dB		cm	deg	
1	2387.76	66.15	74.00	-7.85	35.77	2.21	28.17	0.00	Peak	100	337	VERTICAL
2	2390.00	50.35	54.00	-3.65	19.96	2.22	28.17	0.00	Average	100	337	VERTICAL
3	2431.23	109.88			79.40	2.23	28.25	0.00	Peak	100	337	VERTICAL
4	2443.41	98.78			68.25	2.24	28.29	0.00	Average	100	337	VERTICAL
5	2483.50	47.44	54.00	-6.56	16.81	2.26	28.37	0.00	Average	100	337	VERTICAL
6	2483.82	63.38	74.00	-10.62	32.75	2.26	28.37	0.00	Peak	100	337	VERTICAL

Note 1: Item 3, 4 are the fundamental frequency at 2437 MHz  
 Note 2: Emission level (dBuV/m) = 20 log Emission level (uV/m).  
 Note 3: Corrected Reading: Antenna Factor + Cable Loss + Read Level - Preamp Factor = Level.  
 Note 4: Measurement receive antenna polarization: H (Horizontal), V (Vertical)

Band Edge and Fundamental Emissions					
Operating Mode	IEEE 802.11n MCS0 40MHz CH 9 / Ant. 2			Polarization	V
Temperature	25.6°C	Humidity	56%	Test Engineer	Jim Huang

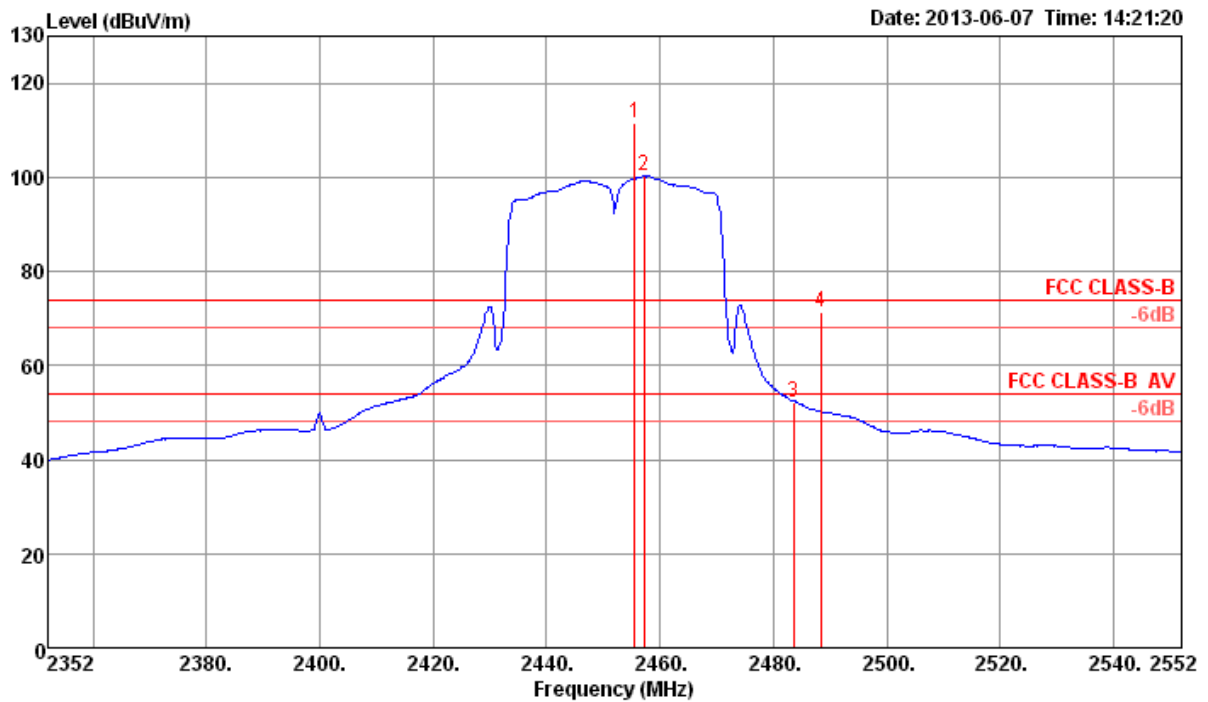

	Freq	Level	Limit	Over	Read	CableAntenna	Preamp	Remark	A/Pos	T/Pos	Pol/Phase
	MHz	dBuV/m	dBuV/m	dB	dBuV	dB	dB/m	dB	cm	deg	
1	2455.53	111.38			80.81	2.24	28.33	0.00 Peak	100	329	VERTICAL
2	2457.13	100.26			69.69	2.24	28.33	0.00 Average	100	329	VERTICAL
3	2483.50	52.28	54.00	-1.72	21.65	2.26	28.37	0.00 Average	100	329	VERTICAL
4	2488.31	71.31	74.00	-2.69	40.64	2.26	28.41	0.00 Peak	100	329	VERTICAL

Note 1: Item 1, 2 are the fundamental frequency at 2452 MHz  
 Note 2: Emission level (dBuV/m) = 20 log Emission level (uV/m).  
 Note 3: Corrected Reading: Antenna Factor + Cable Loss + Read Level - Preamp Factor = Level.  
 Note 4: Measurement receive antenna polarization: H (Horizontal), V (Vertical)

Band Edge and Fundamental Emissions					
Operating Mode	IEEE 802.11n MCS8 40MHz CH 3 / Ant. 1 + Ant. 2			Polarization	V
Temperature	25.6°C	Humidity	56%	Test Engineer	Jim Huang

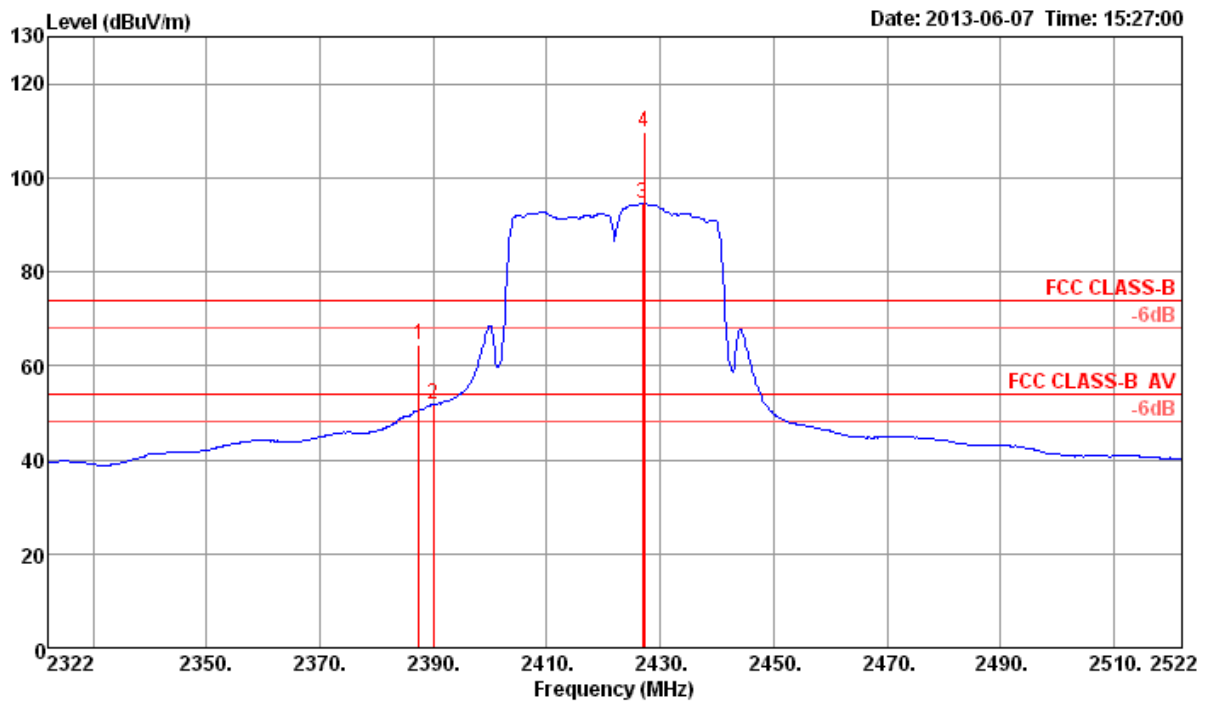

	Freq	Level	Limit	Over	Read	Cable	Antenna	Preamp	Remark	A/Pos	T/Pos	Pol/Phase
	MHz	dBuV/m	dBuV/m	dB	dBuV	dB	dB/m	dB		cm	deg	
1	2387.44	64.53	74.00	-9.47	34.15	2.21	28.17	0.00	Peak	100	352	VERTICAL
2	2390.00	51.79	54.00	-2.21	21.40	2.22	28.17	0.00	Average	100	352	VERTICAL
3	2426.81	94.54			64.06	2.23	28.25	0.00	Average	100	352	VERTICAL
4	2427.13	109.62			79.14	2.23	28.25	0.00	Peak	100	352	VERTICAL

Note 1: Item 3, 4 are the fundamental frequency at 2422 MHz  
 Note 2: Emission level (dBuV/m) = 20 log Emission level (uV/m).  
 Note 3: Corrected Reading: Antenna Factor + Cable Loss + Read Level - Preamp Factor = Level.  
 Note 4: Measurement receive antenna polarization: H (Horizontal), V (Vertical)



Band Edge and Fundamental Emissions					
Operating Mode	IEEE 802.11n MCS8 40MHz CH 6 / Ant. 1 + Ant. 2			Polarization	V
Temperature	25.6°C	Humidity	56%	Test Engineer	Jim Huang

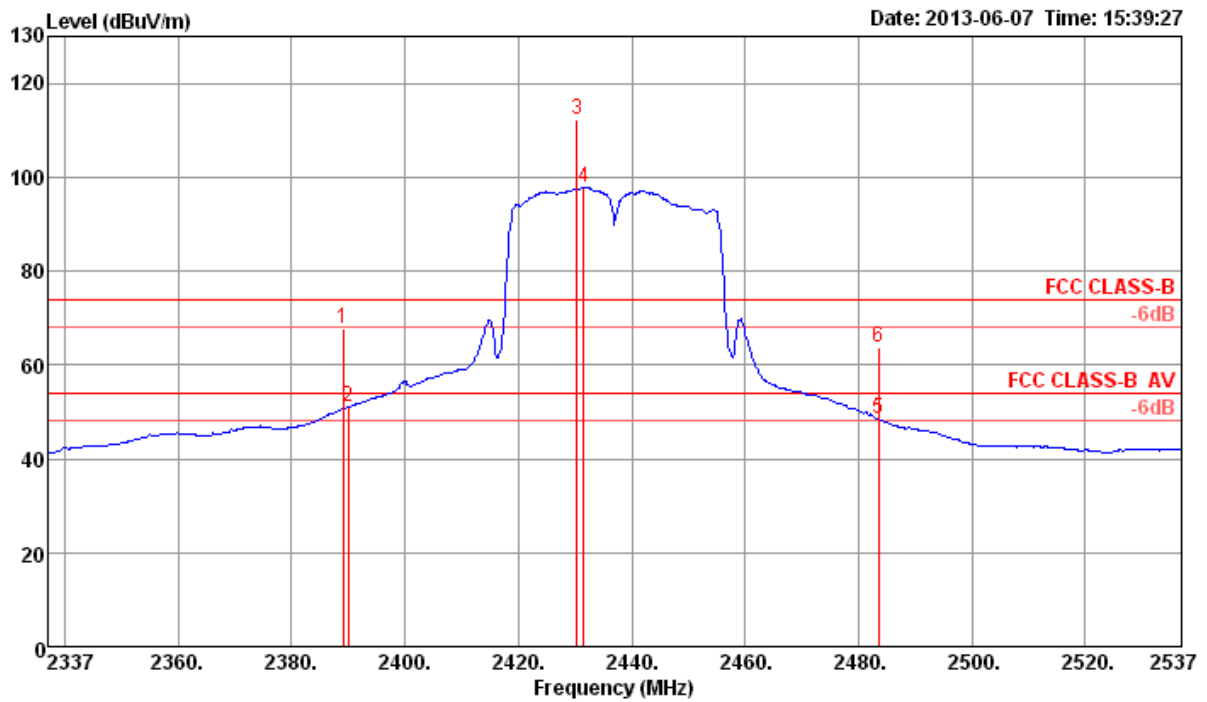

	Freq	Level	Limit	Over	Read	Cable	Antenna	Preamp	Remark	A/Pos	T/Pos	Pol/Phase
	MHz	dBuV/m	dBuV/m	dB	dBuV	dB	dB/m	dB		cm	deg	
1	2389.04	67.59	74.00	-6.41	37.21	2.21	28.17	0.00	Peak	100	353	VERTICAL
2	2390.00	50.91	54.00	-3.09	20.52	2.22	28.17	0.00	Average	100	353	VERTICAL
3	2430.27	112.23			81.75	2.23	28.25	0.00	Peak	100	353	VERTICAL
4	2431.55	97.73			67.25	2.23	28.25	0.00	Average	100	353	VERTICAL
5	2483.50	48.45	54.00	-5.55	17.82	2.26	28.37	0.00	Average	100	353	VERTICAL
6	2483.50	63.61	74.00	-10.39	32.98	2.26	28.37	0.00	Peak	100	353	VERTICAL

Note 1: Item 3, 4 are the fundamental frequency at 2437 MHz  
 Note 2: Emission level (dBuV/m) = 20 log Emission level (uV/m).  
 Note 3: Corrected Reading: Antenna Factor + Cable Loss + Read Level - Preamp Factor = Level.  
 Note 4: Measurement receive antenna polarization: H (Horizontal), V (Vertical)

Band Edge and Fundamental Emissions					
Operating Mode	IEEE 802.11n MCS8 40MHz CH 9 / Ant. 1 + Ant. 2			Polarization	V
Temperature	25.6°C	Humidity	56%	Test Engineer	Jim Huang

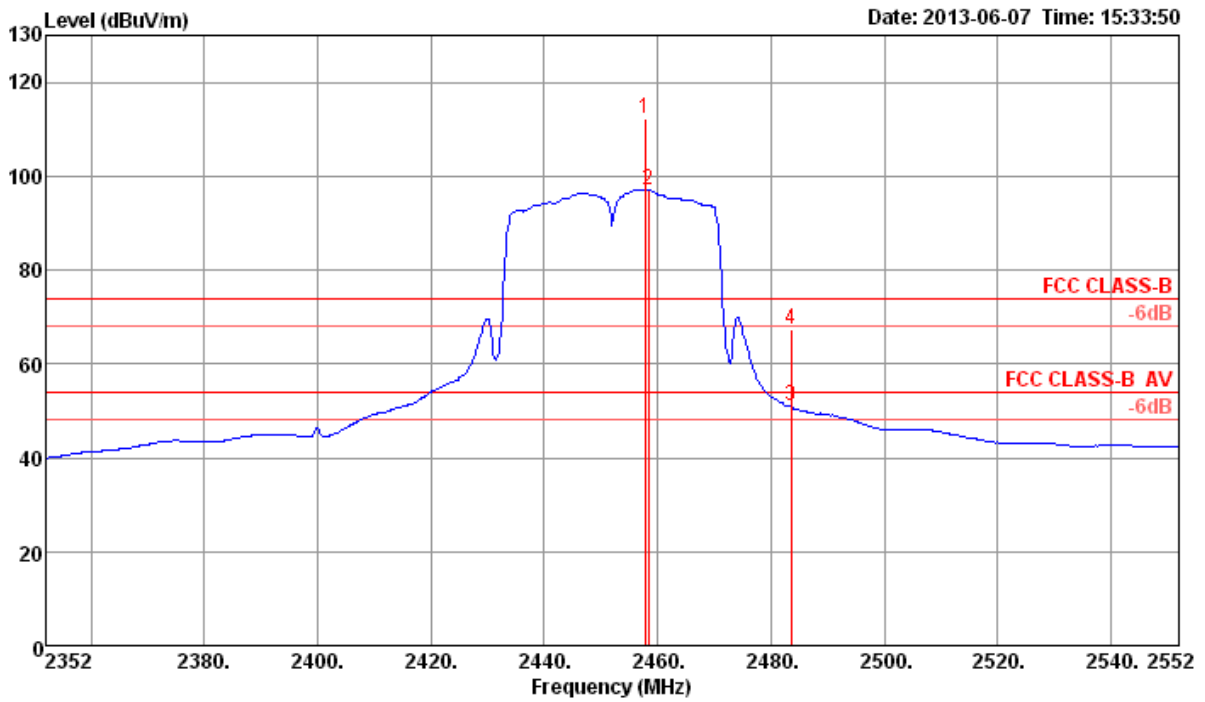

	Freq	Level	Limit	Over	Read	Cable	Antenna	Preamp	Remark	A/Pos	T/Pos	Pol/Phase
	MHz	dBuV/m	dBuV/m	dB	dBuV	dB	dB/m	dB		cm	deg	
1	2457.77	112.39			81.82	2.24	28.33	0.00	Peak	100	336	VERTICAL
2	2458.41	97.10			66.53	2.24	28.33	0.00	Average	100	336	VERTICAL
3	2483.50	50.95	54.00	-3.05	20.32	2.26	28.37	0.00	Average	100	336	VERTICAL
4	2483.50	67.42	74.00	-6.58	36.79	2.26	28.37	0.00	Peak	100	336	VERTICAL

Note 1: Item 1, 2 are the fundamental frequency at 2452 MHz  
 Note 2: Emission level (dBuV/m) = 20 log Emission level (uV/m).  
 Note 3: Corrected Reading: Antenna Factor + Cable Loss + Read Level - Preamp Factor = Level.  
 Note 4: Measurement receive antenna polarization: H (Horizontal), V (Vertical)

**3.6.8 Results of Emission not in Restricted Band**

Following channel(s) was (were) selected for the final test as listed below.

<b>MODE</b>	<b>TX Chain</b>	<b>TESTED CHANNEL</b>	<b>MODULATION TECHNOLOGY</b>	<b>MODULATION TYPE</b>	<b>DATA RATE (Mbps)</b>
802.11b	Ant.1	1, 11	DSSS	DBPSK	1
802.11b	Ant.2	1, 11	DSSS	DBPSK	1
802.11g	Ant.1	1, 11	OFDM	BPSK	6
802.11g	Ant.2	1, 11	OFDM	BPSK	6
802.11n 20MHz	Ant.1	1, 11	OFDM	BPSK	MCS0 (6.5)
802.11n 20MHz	Ant.2	1, 11	OFDM	BPSK	MCS0 (6.5)
802.11n 20MHz	Ant.1+2 (SDM)	1, 11	OFDM	BPSK	MCS8 (13)
802.11n 40MHz	Ant.1	3, 9	OFDM	BPSK	MCS0 (13)
802.11n 40MHz	Ant.2	3, 9	OFDM	BPSK	MCS0 (13)
802.11n 40MHz	Ant.1+2 (SDM)	3, 9	OFDM	BPSK	MCS8 (27)

Low Band Edge Plot on Configuration IEEE 802.11b / Reference Level / Ant. 1

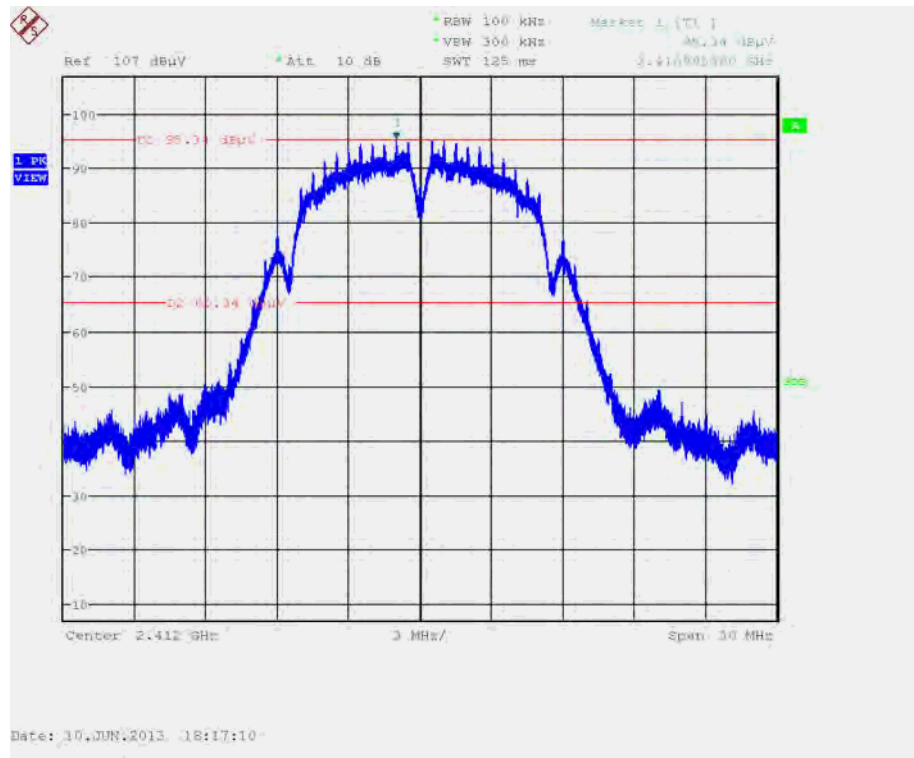

Low Band Edge Plot on Configuration IEEE 802.11b / 2412 MHz / Ant. 1

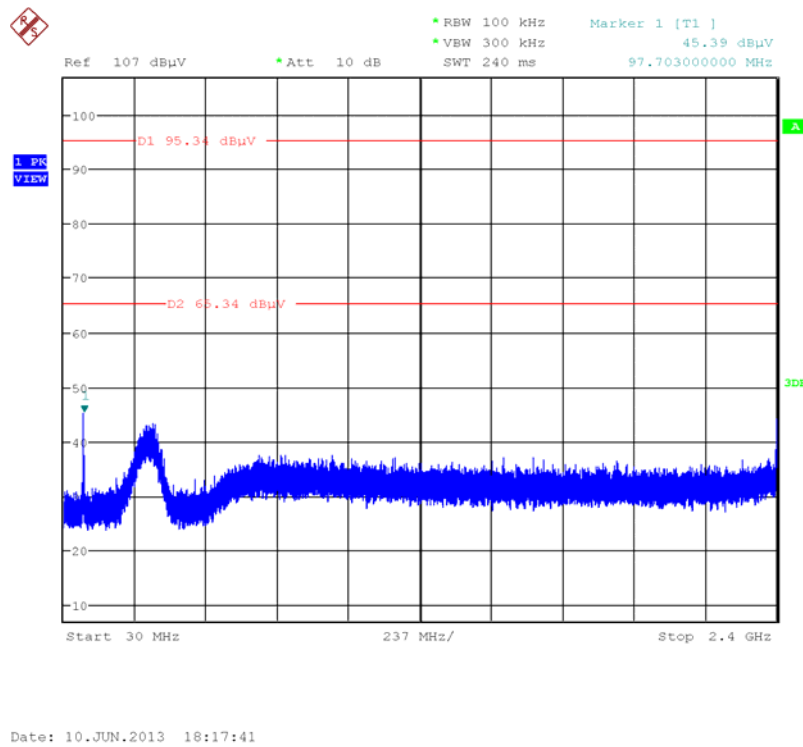

Low Band Edge Plot on Configuration IEEE 802.11b / 2412 MHz / Ant. 1

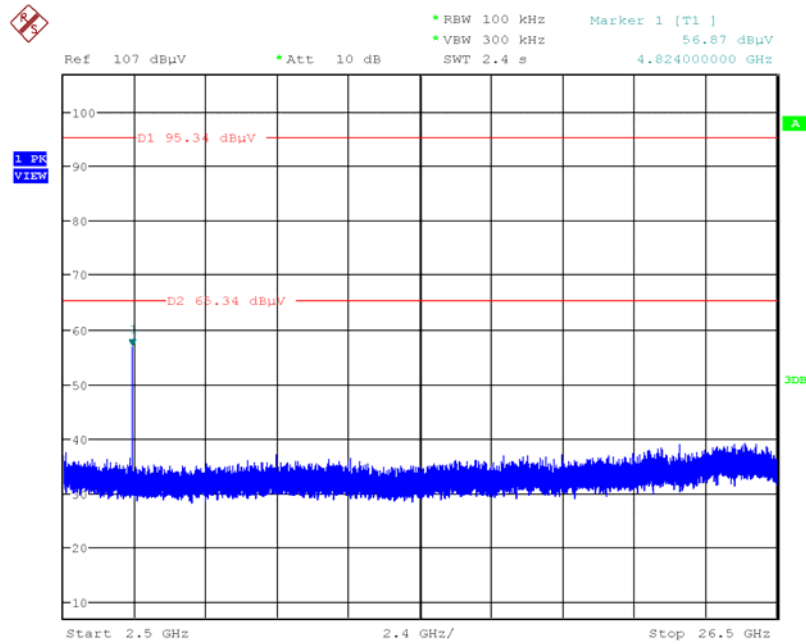

Date: 10.JUN.2013 18:18:24

Low Band Edge Plot on Configuration IEEE 802.11b / 2462 MHz / Ant. 1

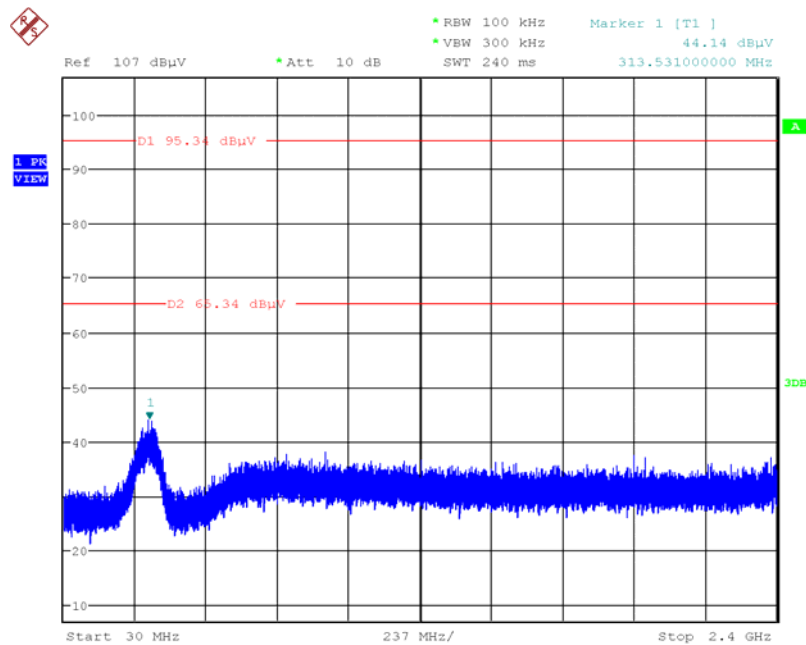

Date: 10.JUN.2013 18:19:35

Low Band Edge Plot on Configuration IEEE 802.11b / 2462 MHz / Ant. 1

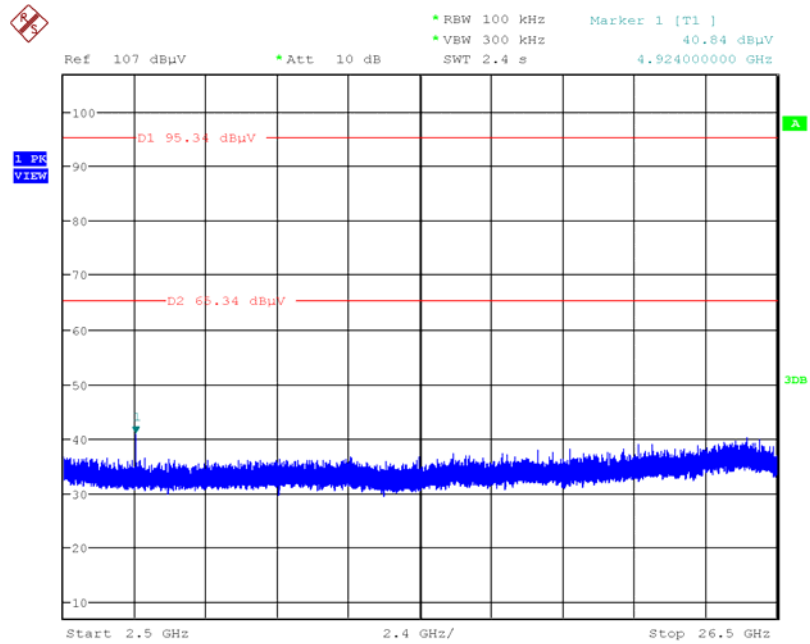

Date: 10.JUN.2013 18:20:42

Low Band Edge Plot on Configuration IEEE 802.11b / Reference Level / Ant. 2



Low Band Edge Plot on Configuration IEEE 802.11b / 2412 MHz / Ant. 2

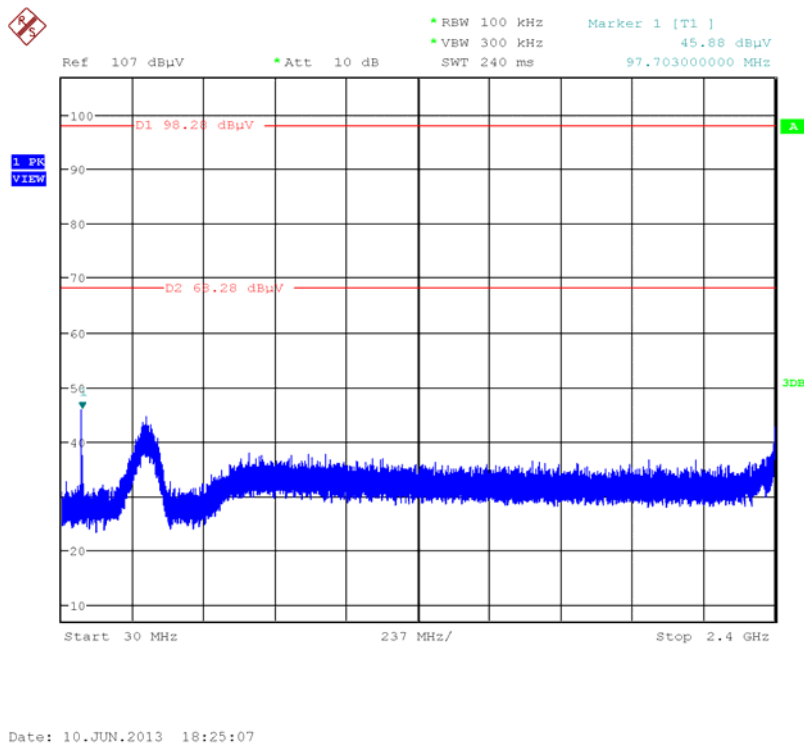

Low Band Edge Plot on Configuration IEEE 802.11b / 2412 MHz / Ant. 2

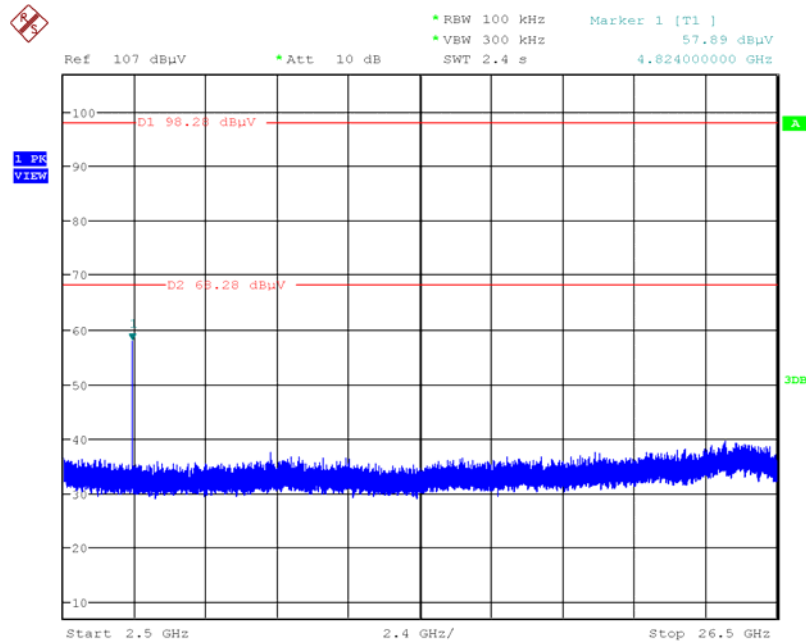

Date: 10.JUN.2013 18:26:23

Low Band Edge Plot on Configuration IEEE 802.11b / 2462 MHz / Ant. 2

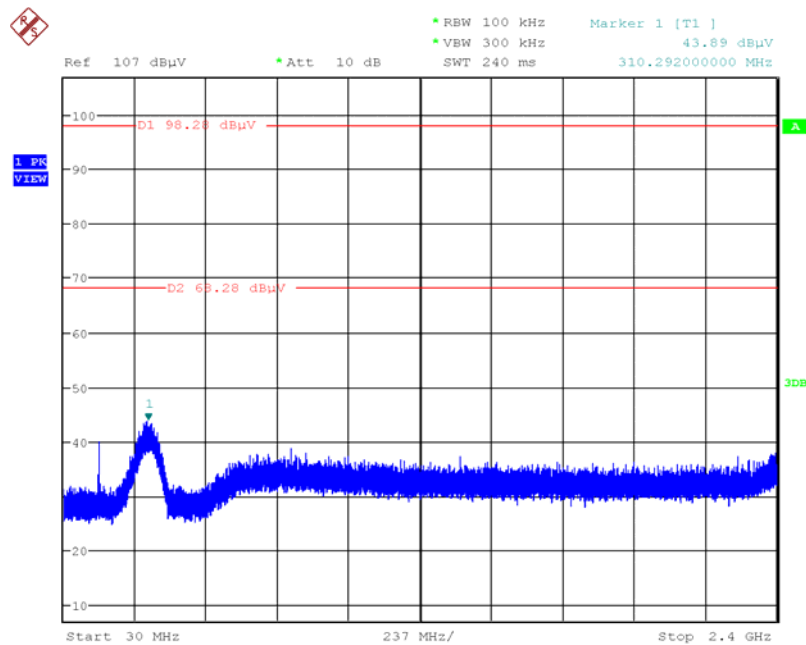

Date: 10.JUN.2013 18:27:26



Low Band Edge Plot on Configuration IEEE 802.11b / 2462 MHz / Ant. 2

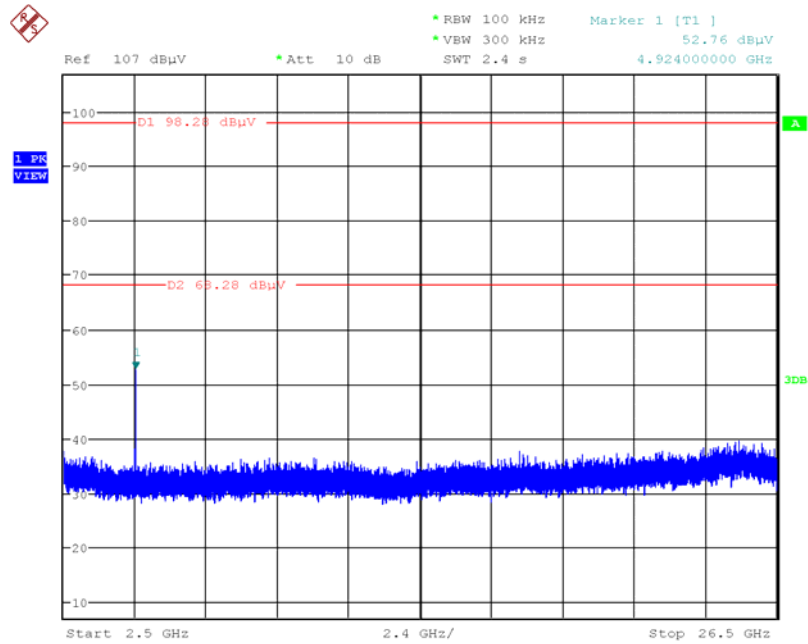

Date: 10.JUN.2013 18:27:55

Low Band Edge Plot on Configuration IEEE 802.11g / Reference Level / Ant. 1

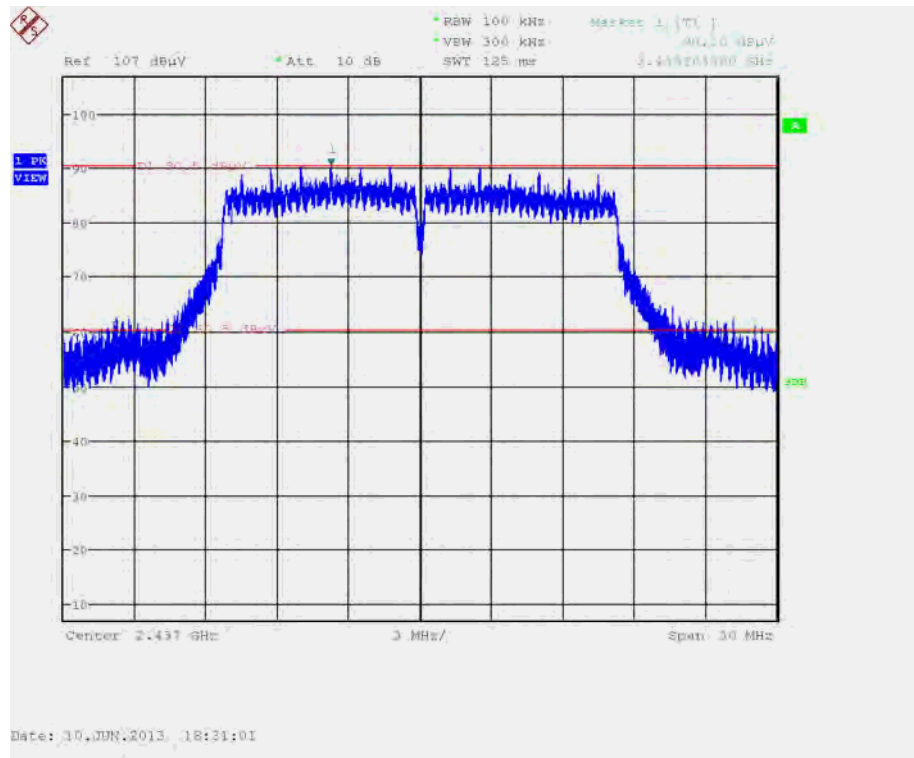

Low Band Edge Plot on Configuration IEEE 802.11g / 2412 MHz / Ant. 1

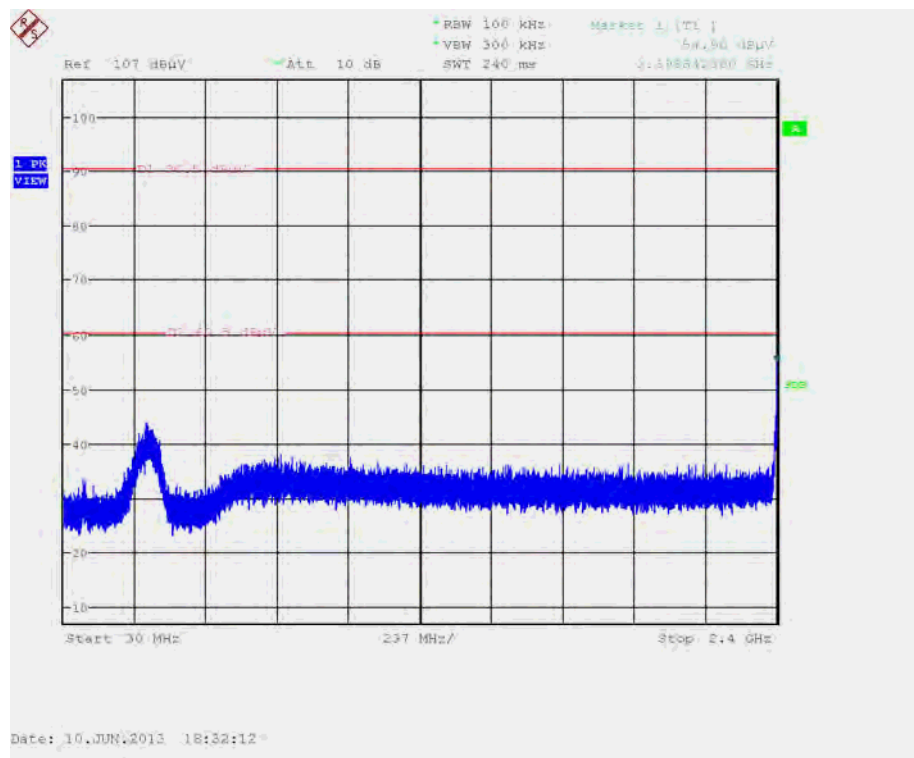

Low Band Edge Plot on Configuration IEEE 802.11g / 2412 MHz / Ant. 1

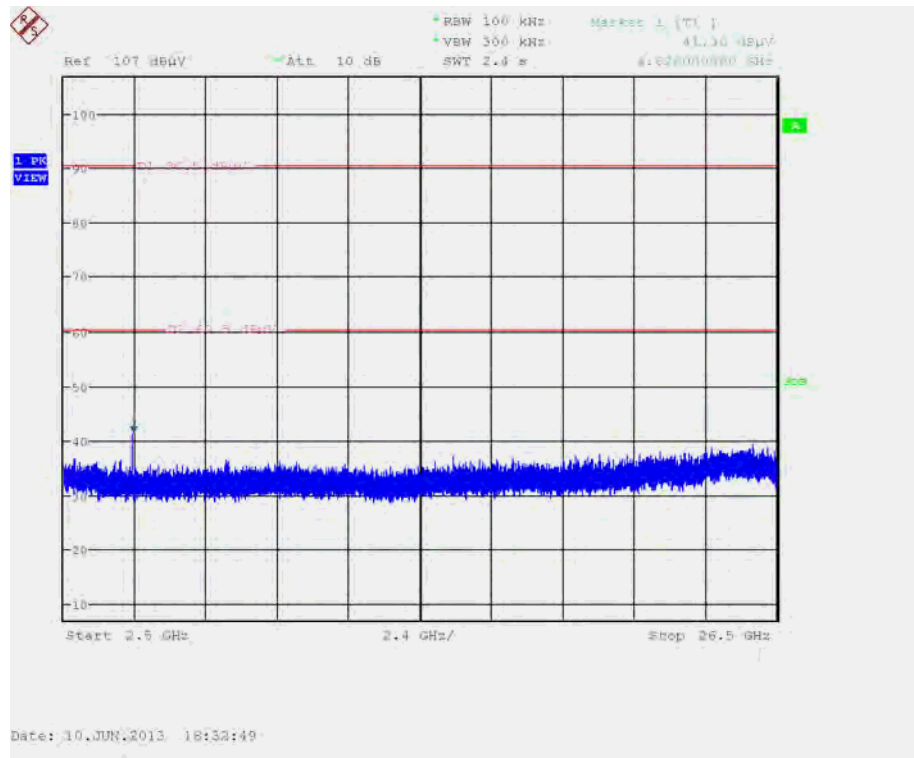

Low Band Edge Plot on Configuration IEEE 802.11g / 2462 MHz / Ant. 1

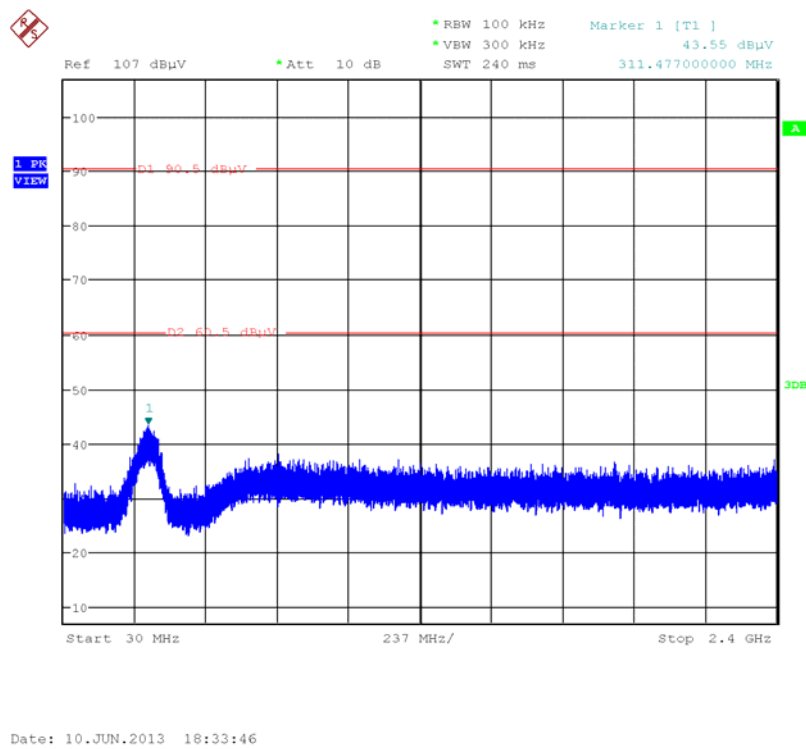

Low Band Edge Plot on Configuration IEEE 802.11g / 2462 MHz / Ant. 1

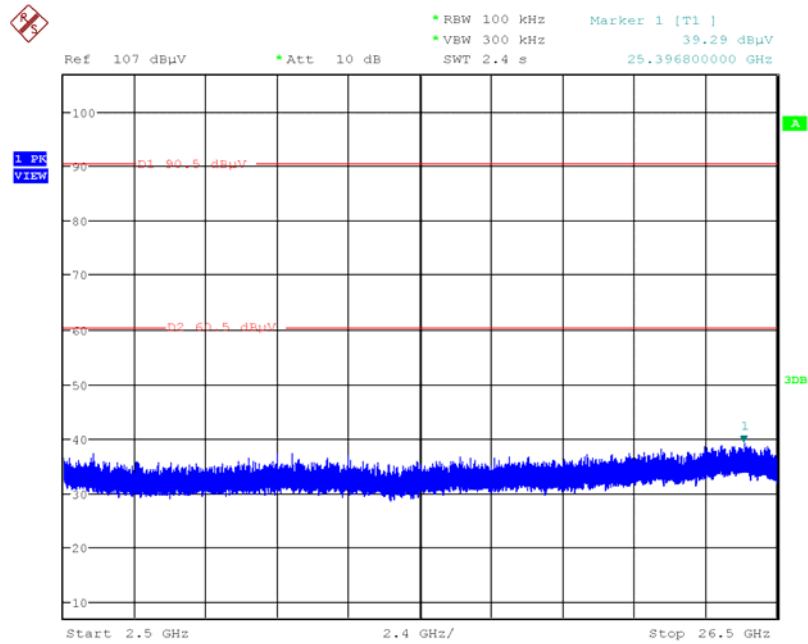

Date: 10.JUN.2013 18:34:24

Low Band Edge Plot on Configuration IEEE 802.11g / Reference Level / Ant. 2

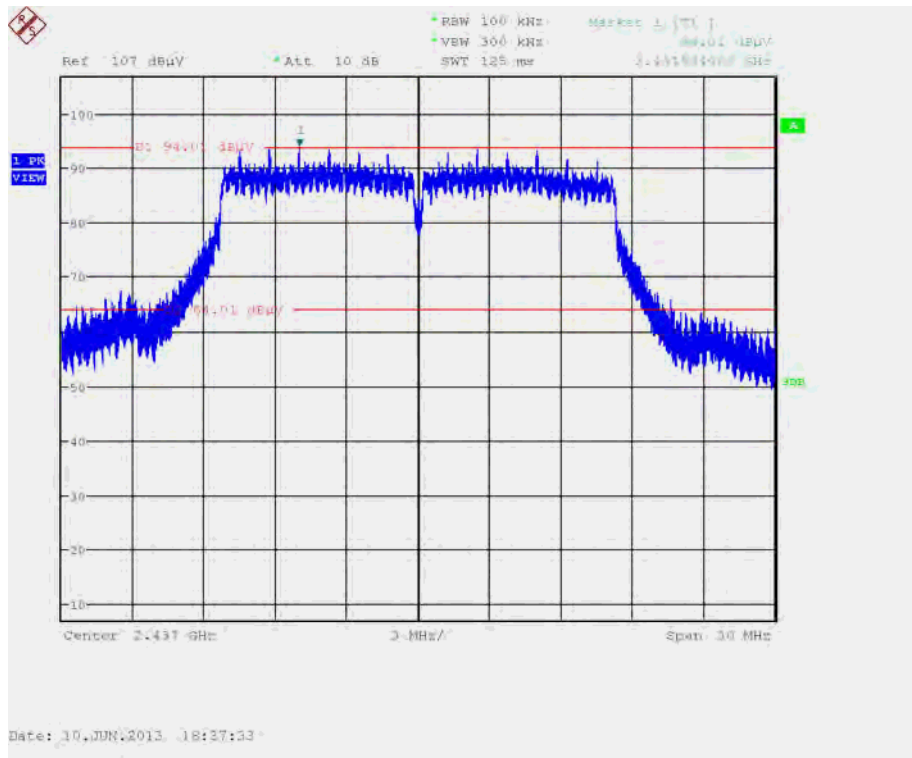

Low Band Edge Plot on Configuration IEEE 802.11g / 2412 MHz / Ant. 2

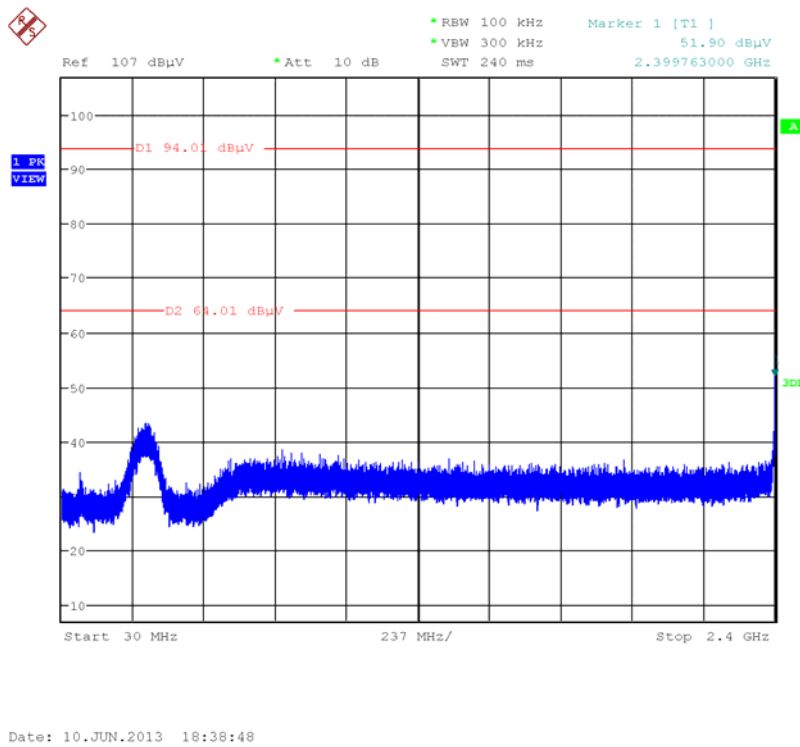

Low Band Edge Plot on Configuration IEEE 802.11g / 2412 MHz / Ant. 2

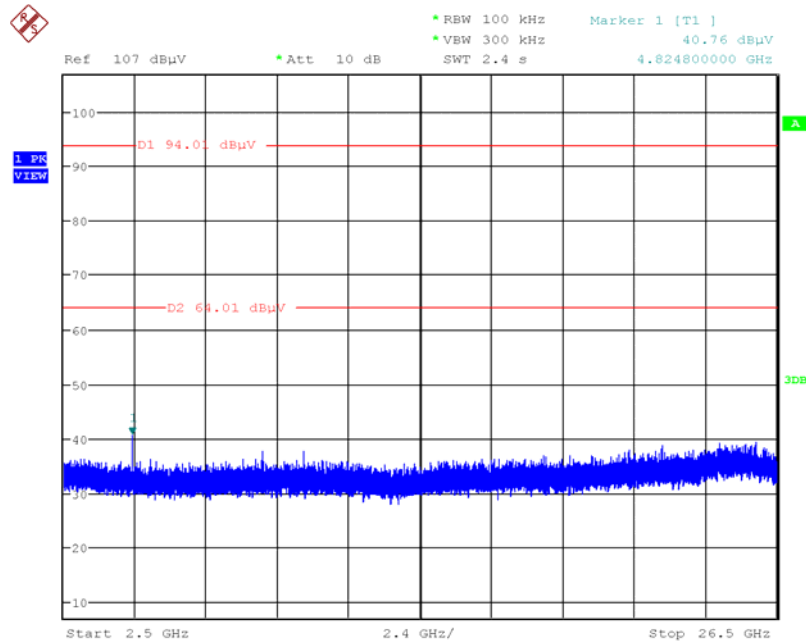

Date: 10.JUN.2013 18:39:26

Low Band Edge Plot on Configuration IEEE 802.11g / 2462 MHz / Ant. 2

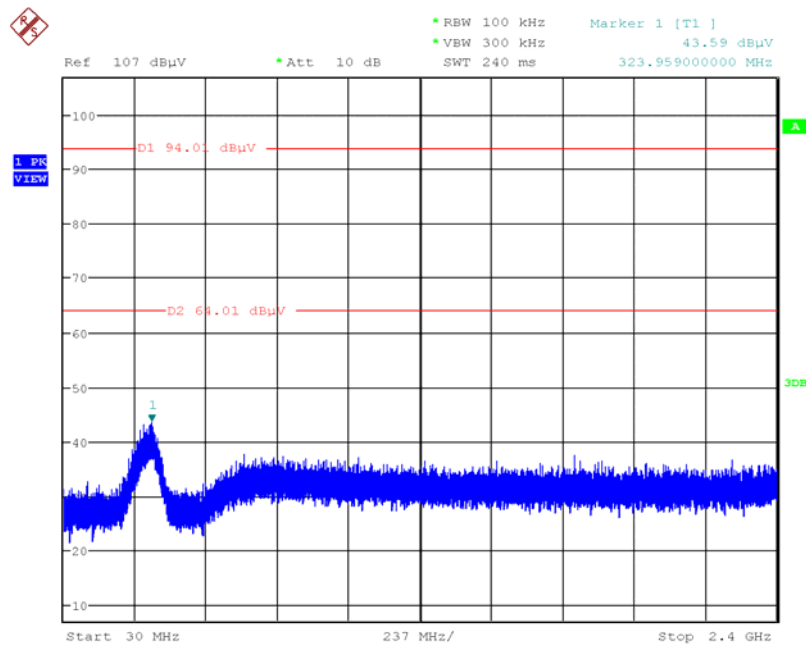

Date: 10.JUN.2013 18:40:24

Low Band Edge Plot on Configuration IEEE 802.11g / 2462 MHz / Ant. 2

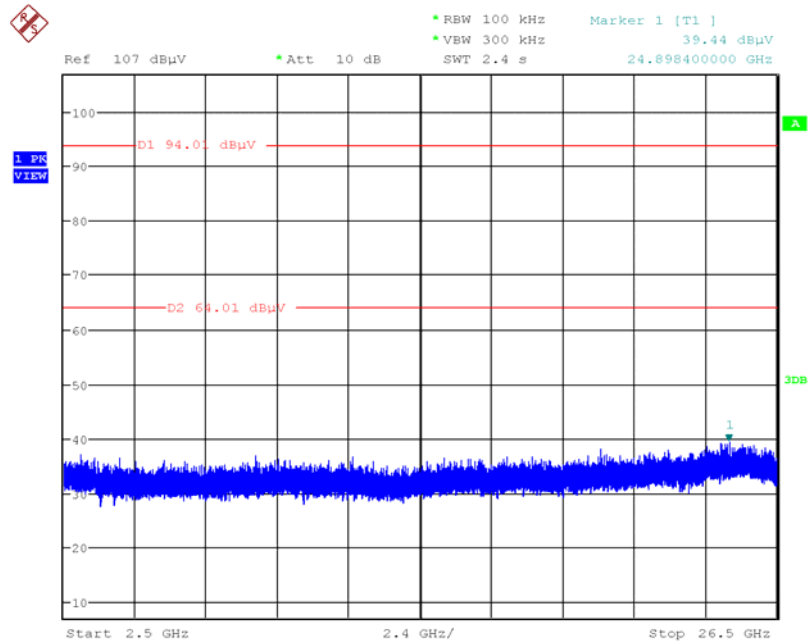

Date: 10.JUN.2013 18:41:24

Low Band Edge Plot on Configuration IEEE 802.11n MCS0 20MHz / Reference Level / Ant. 1

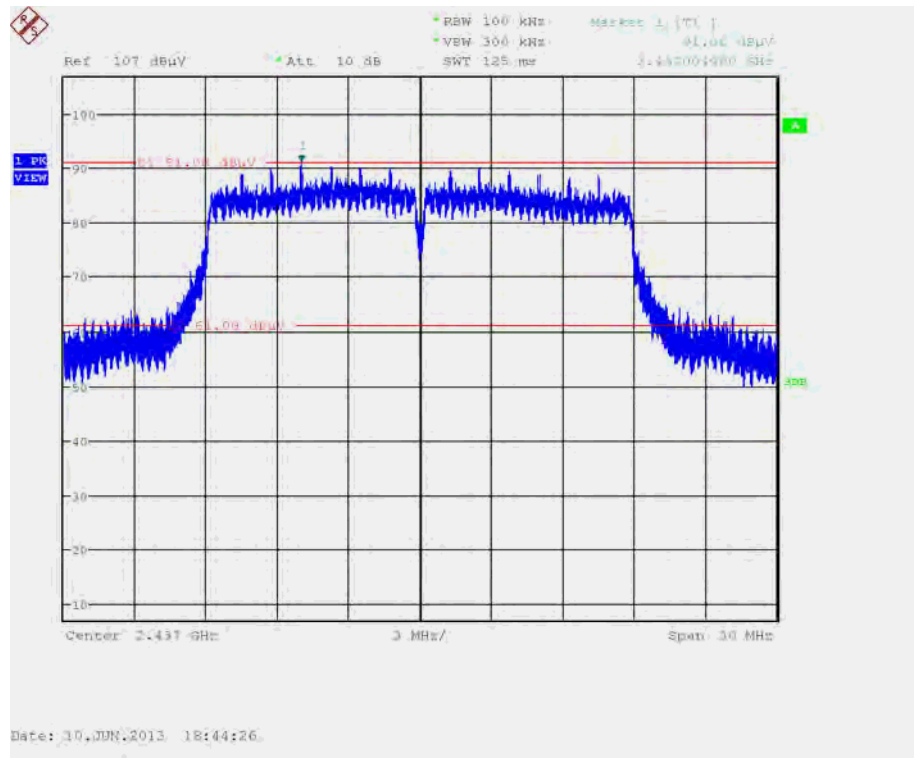

Low Band Edge Plot on Configuration IEEE 802.11n MCS0 20MHz / 2412 MHz / Ant. 1

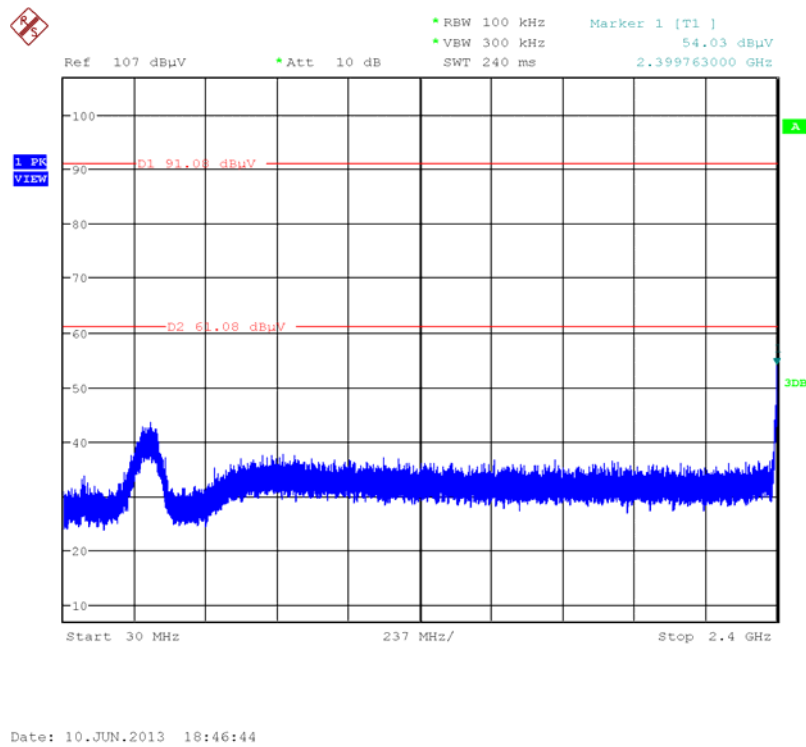



Low Band Edge Plot on Configuration IEEE 802.11n MCS0 20MHz / 2412 MHz / Ant. 1

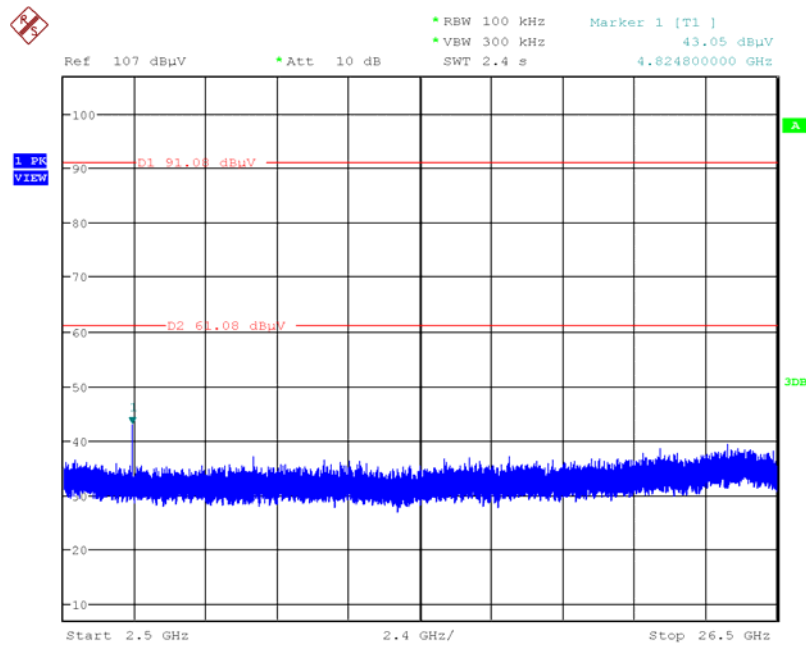

Date: 10.JUN.2013 18:47:13

Low Band Edge Plot on Configuration IEEE 802.11n MCS0 20MHz / 2462 MHz / Ant. 1

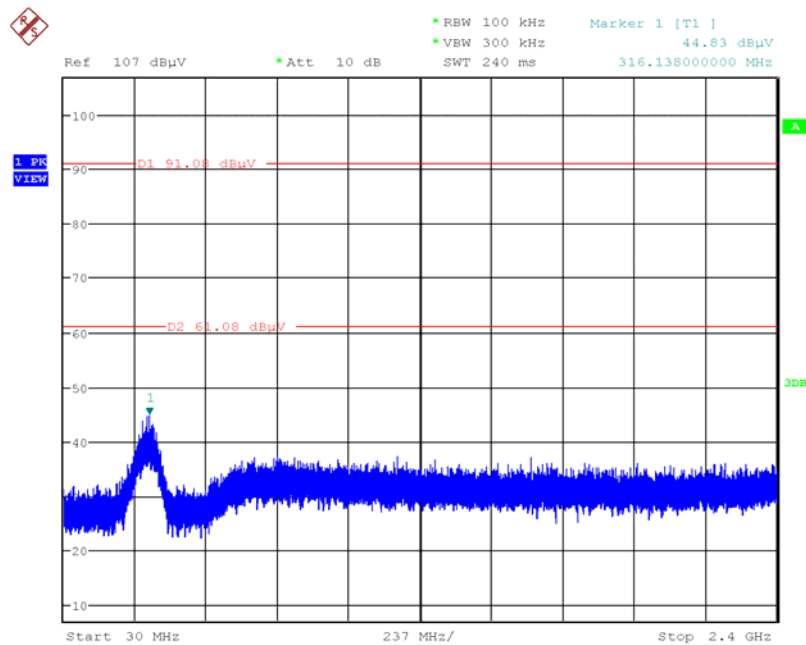

Date: 10.JUN.2013 18:48:03

Low Band Edge Plot on Configuration IEEE 802.11n MCS0 20MHz / 2462 MHz / Ant. 1

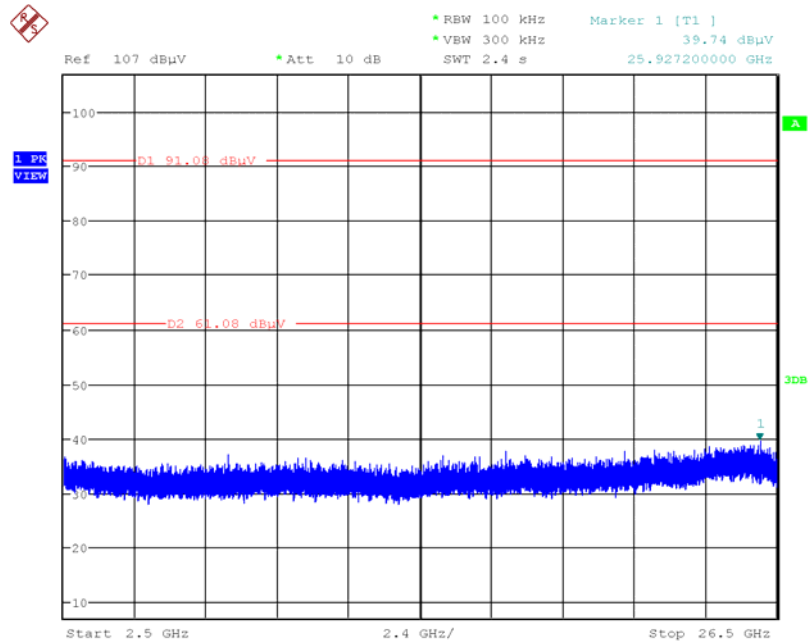

Date: 10.JUN.2013 18:48:37

Low Band Edge Plot on Configuration IEEE 802.11n MCS0 20MHz / Reference Level / Ant. 2

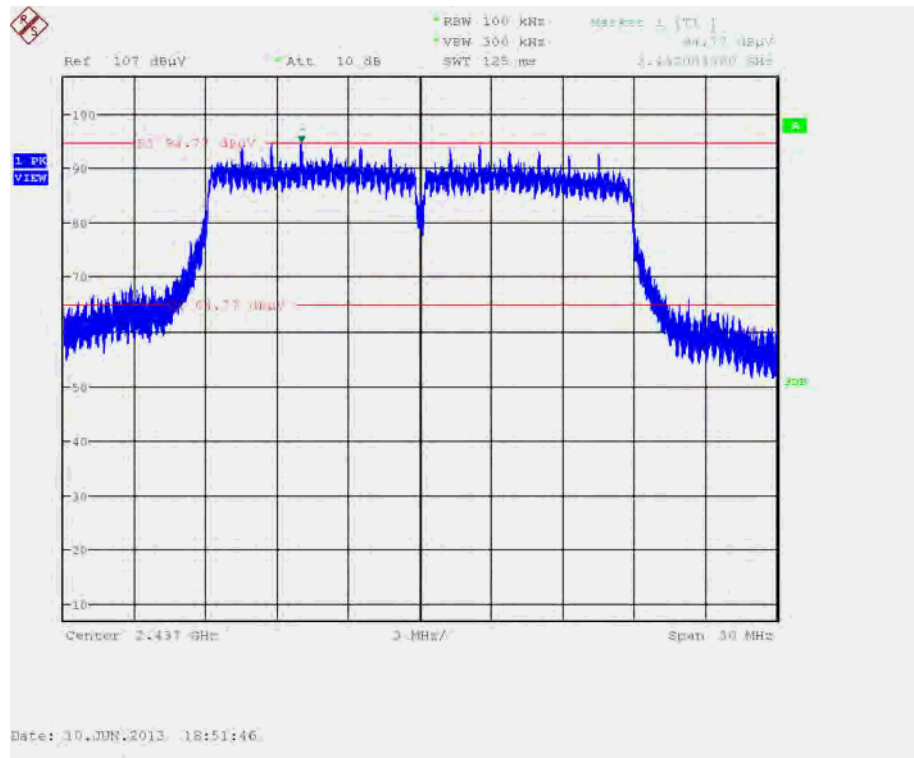

Low Band Edge Plot on Configuration IEEE 802.11n MCS0 20MHz / 2412 MHz / Ant. 2

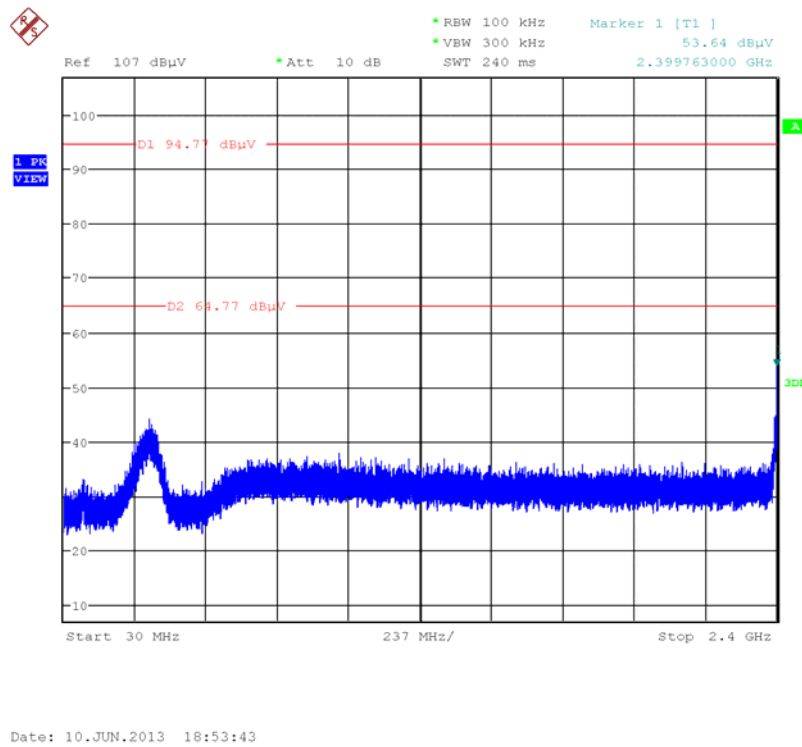

Low Band Edge Plot on Configuration IEEE 802.11n MCS0 20MHz / 2412 MHz / Ant. 2

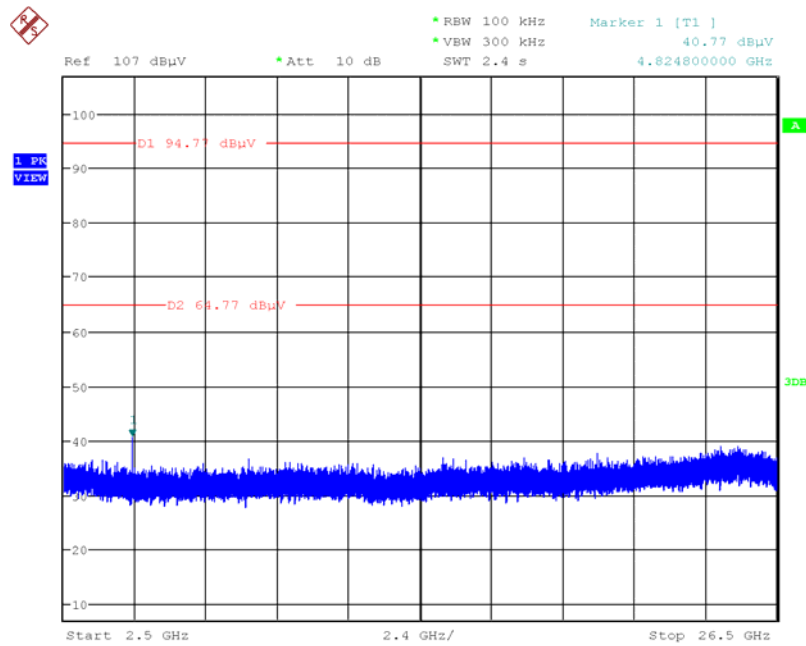

Date: 10.JUN.2013 18:54:13

Low Band Edge Plot on Configuration IEEE 802.11n MCS0 20MHz / 2462 MHz / Ant. 2

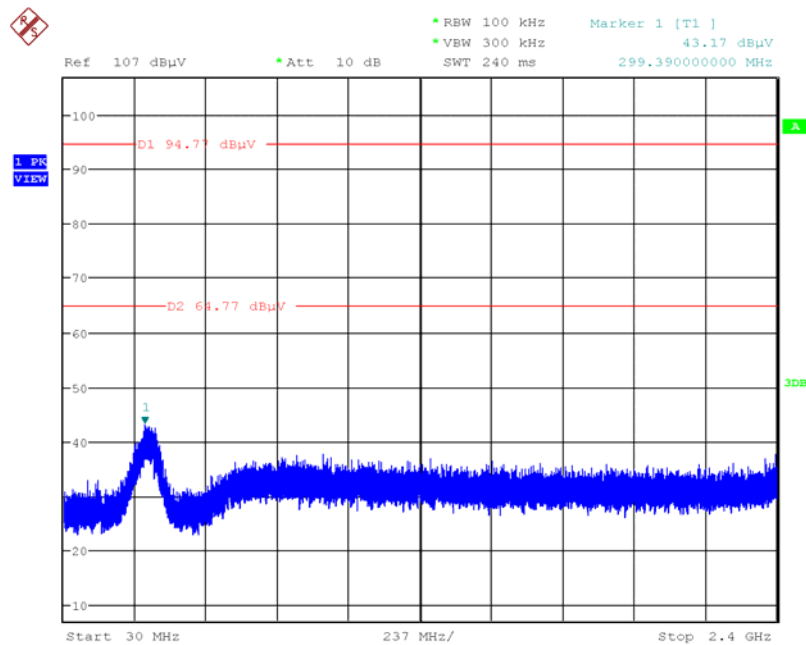

Date: 10.JUN.2013 18:55:03

Low Band Edge Plot on Configuration IEEE 802.11n MCS0 20MHz / 2462 MHz / Ant. 2

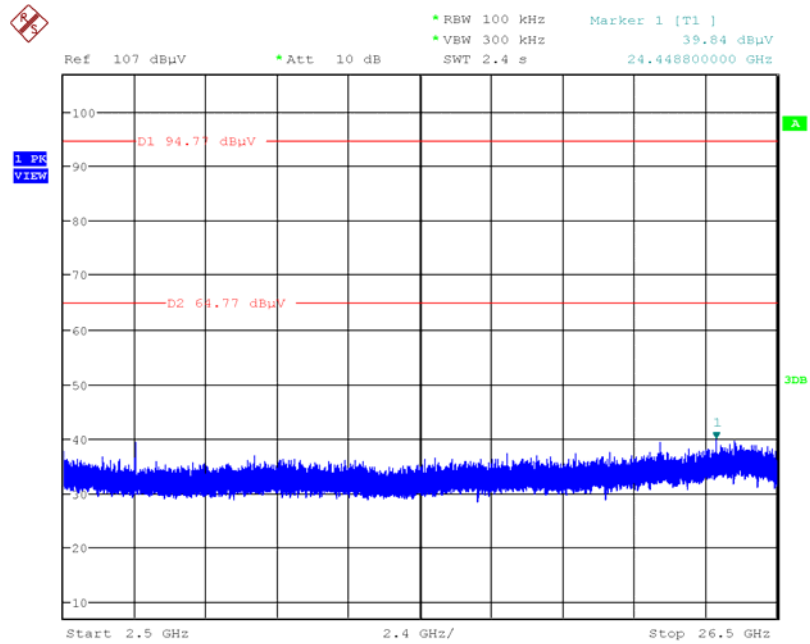

Date: 10.JUN.2013 18:55:32

Low Band Edge Plot on Configuration IEEE 802.11n MCS8 20MHz / Reference Level / Ant. 1 + Ant. 2

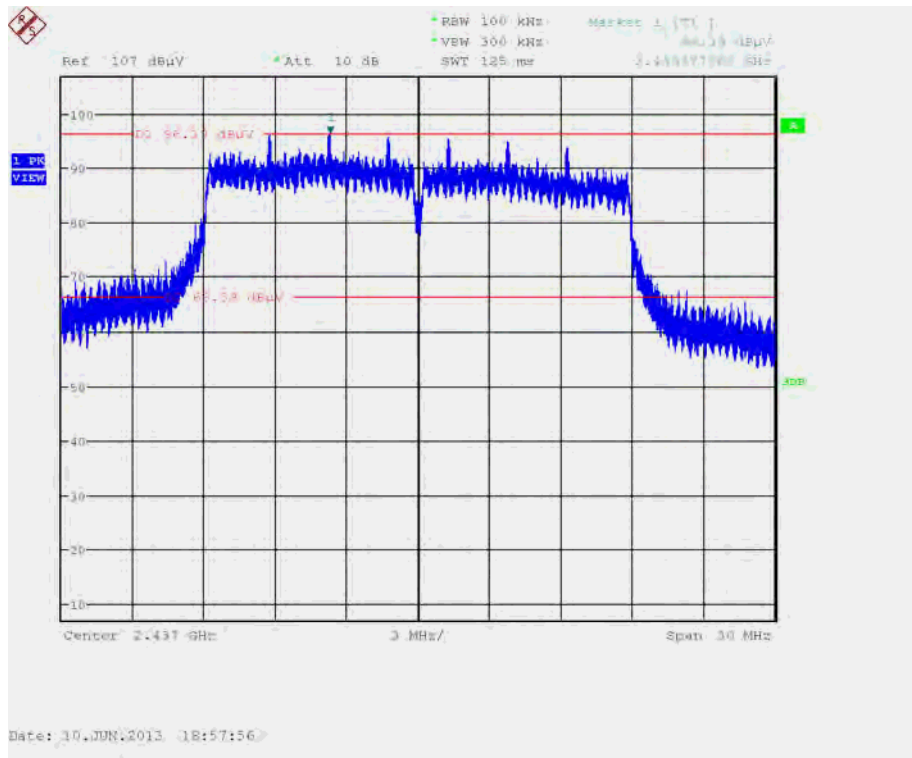

Low Band Edge Plot on Configuration IEEE 802.11n MCS8 20MHz / 2412 MHz / Ant. 1 + Ant. 2

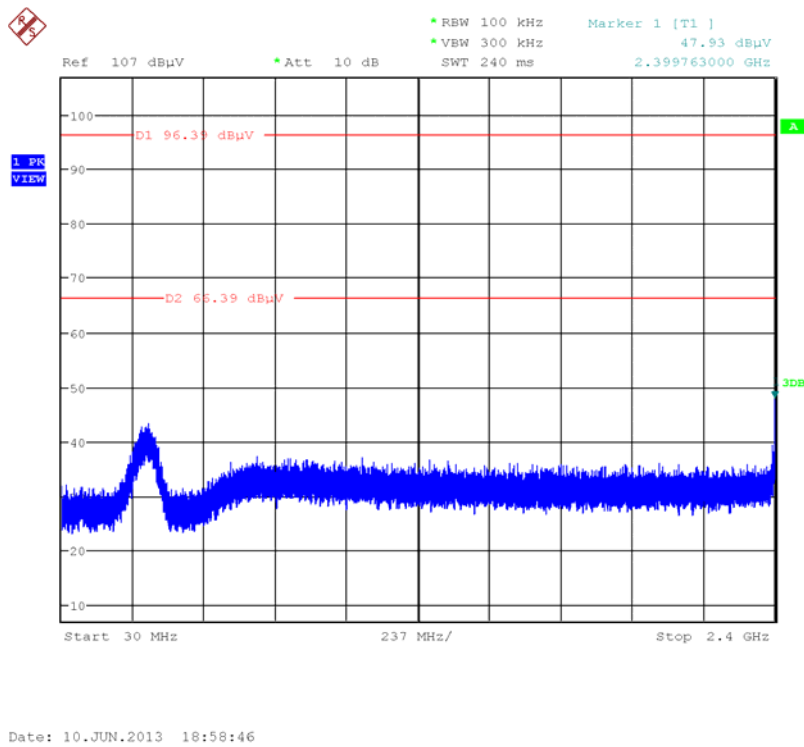

Low Band Edge Plot on Configuration IEEE 802.11n MCS8 20MHz / 2412 MHz / Ant. 1 + Ant. 2

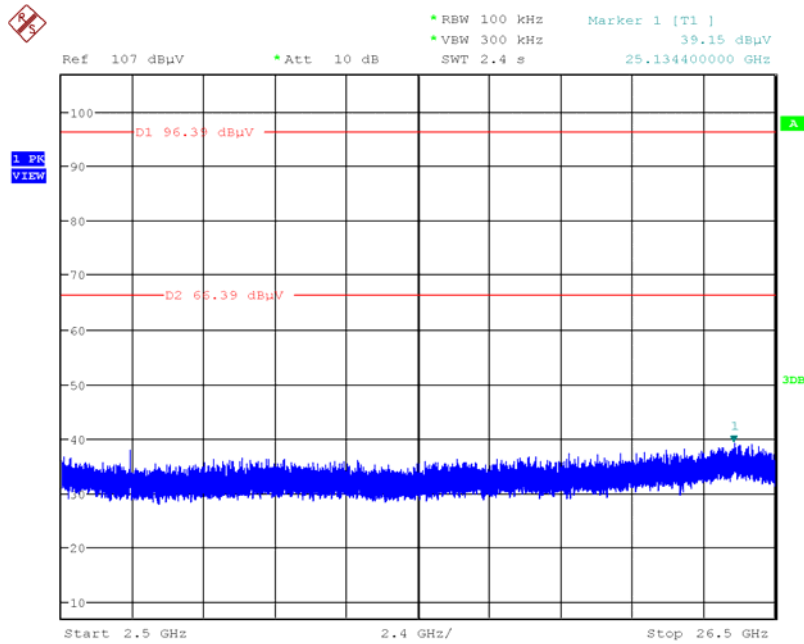

Date: 10.JUN.2013 18:59:12

Low Band Edge Plot on Configuration IEEE 802.11n MCS8 20MHz / 2462 MHz / Ant. 1 + Ant. 2

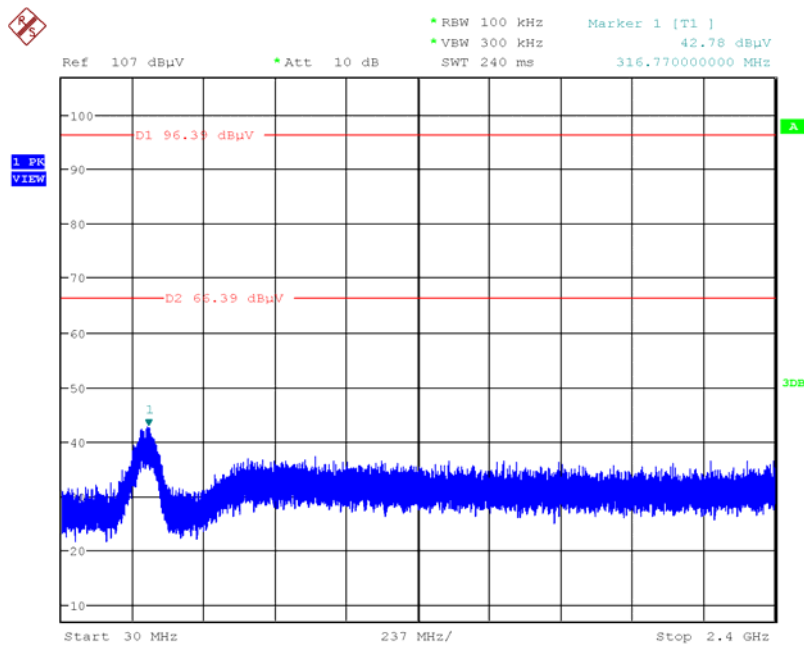

Date: 10.JUN.2013 18:59:50

Low Band Edge Plot on Configuration IEEE 802.11n MCS8 20MHz / 2462 MHz / Ant. 1 + Ant. 2

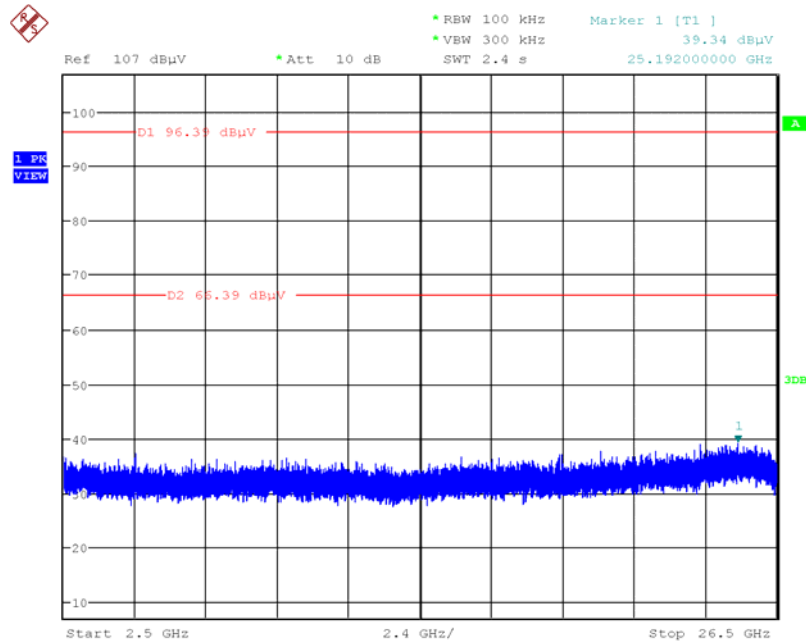

Date: 10.JUN.2013 19:00:14



Low Band Edge Plot on Configuration IEEE 802.11n MCS0 40MHz / Reference Level / Ant. 1

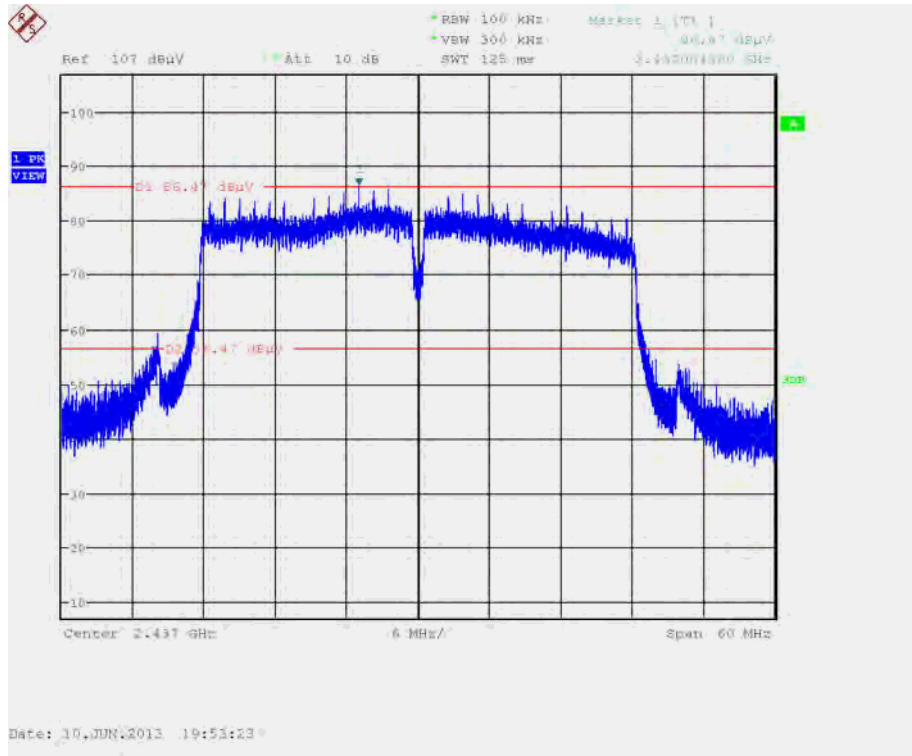

Low Band Edge Plot on Configuration IEEE 802.11n MCS0 40MHz / 2422 MHz / Ant. 1

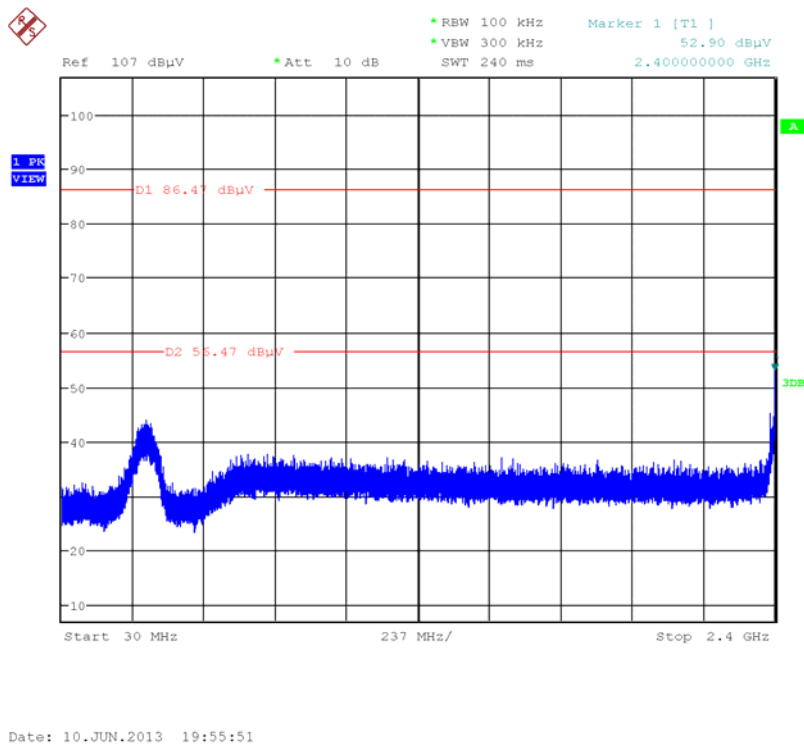

Low Band Edge Plot on Configuration IEEE 802.11n MCS0 40MHz / 2422 MHz / Ant. 1

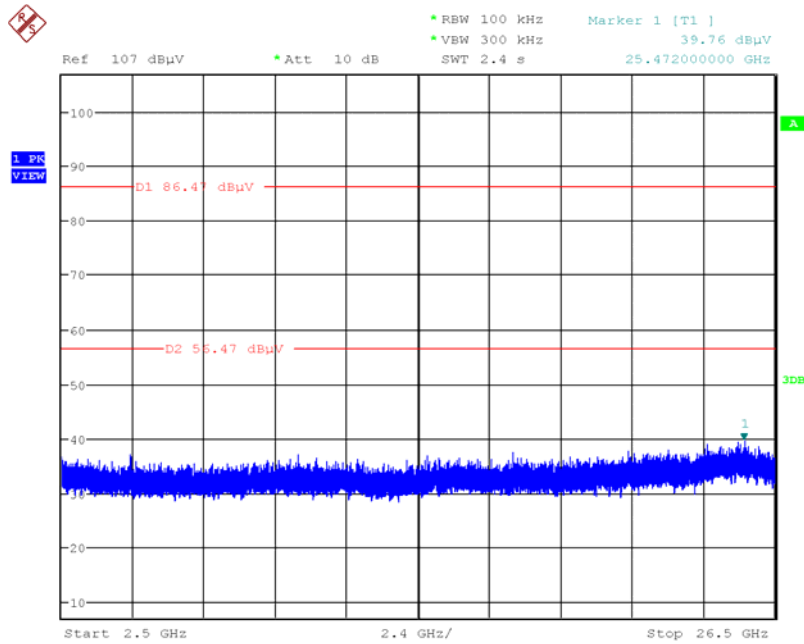

Date: 10.JUN.2013 19:56:20

Low Band Edge Plot on Configuration IEEE 802.11n MCS0 40MHz / 2452 MHz / Ant. 1

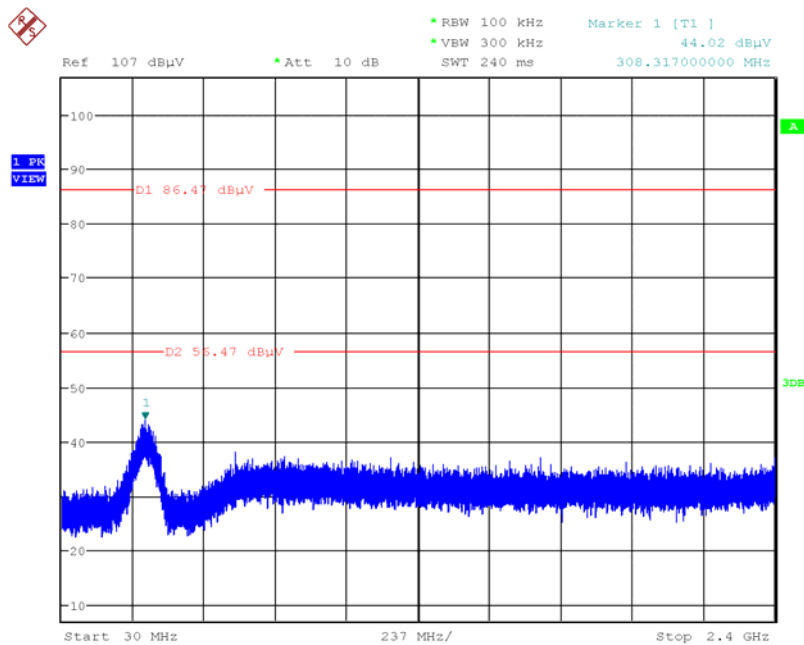

Date: 10.JUN.2013 19:54:20

Low Band Edge Plot on Configuration IEEE 802.11n MCS0 40MHz / 2452 MHz / Ant. 1

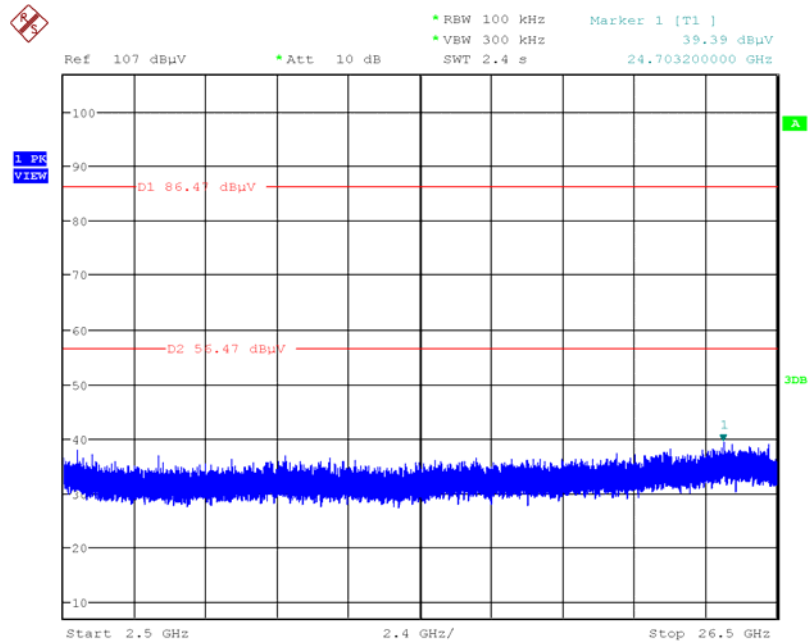

Date: 10.JUN.2013 19:54:45

Low Band Edge Plot on Configuration IEEE 802.11n MCS0 40MHz / Reference Level / Ant. 2

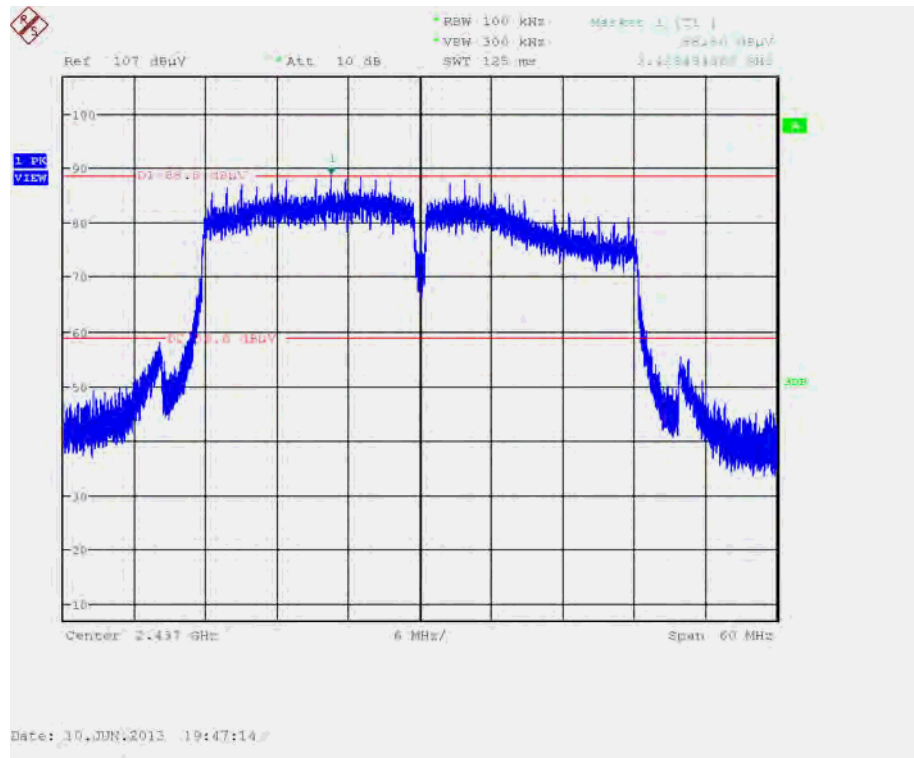

Low Band Edge Plot on Configuration IEEE 802.11n MCS0 40MHz / 2422 MHz / Ant. 2

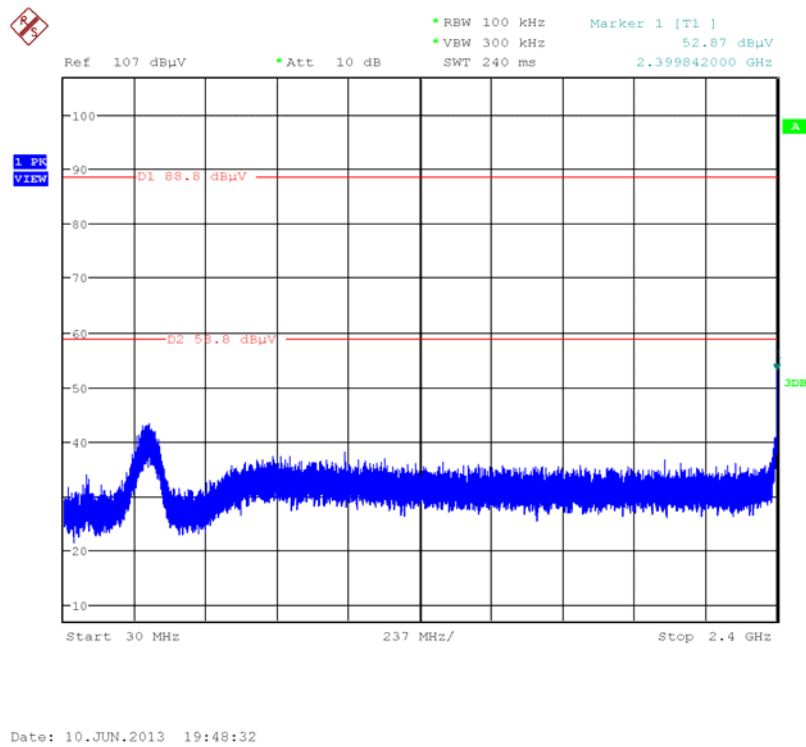

Low Band Edge Plot on Configuration IEEE 802.11n MCS0 40MHz / 2422 MHz / Ant. 2

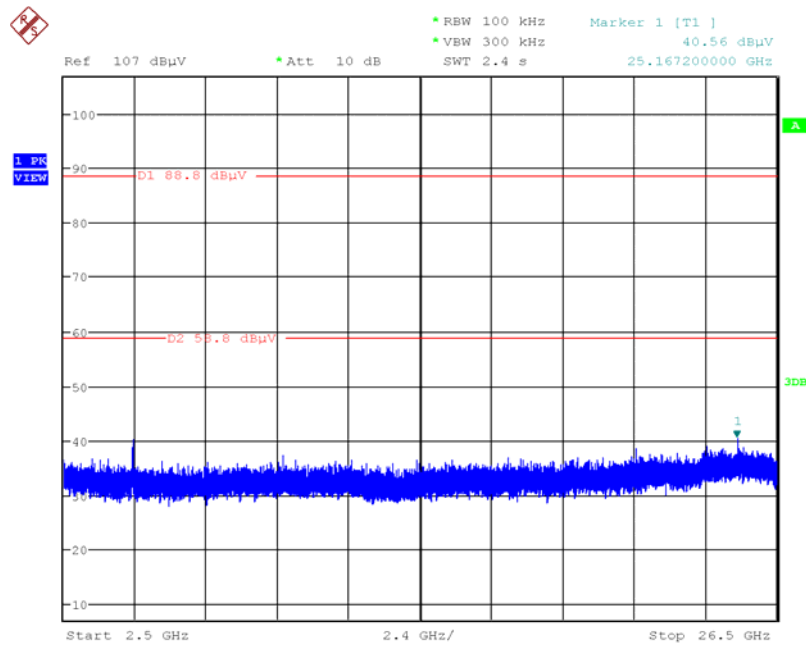

Date: 10.JUN.2013 19:49:00

Low Band Edge Plot on Configuration IEEE 802.11n MCS0 40MHz / 2452 MHz / Ant. 2

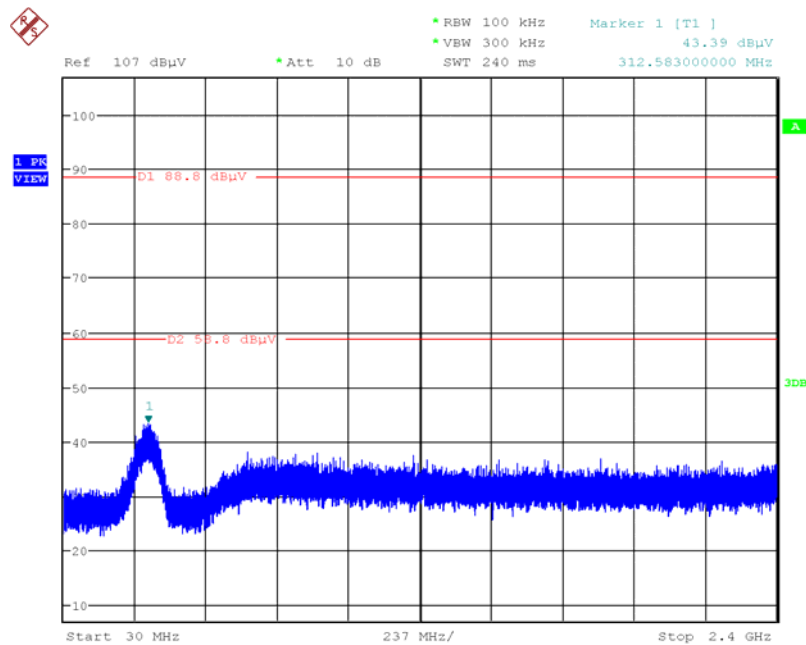

Date: 10.JUN.2013 19:49:44

Low Band Edge Plot on Configuration IEEE 802.11n MCS0 40MHz / 2452 MHz / Ant. 2

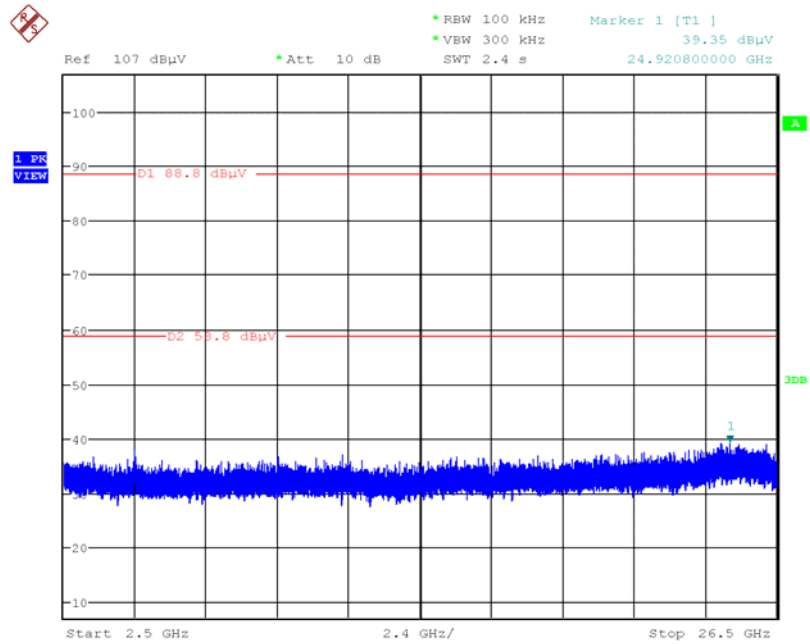

Date: 10.JUN.2013 19:50:16

Low Band Edge Plot on Configuration IEEE 802.11n MCS8 40MHz / Reference Level / Ant. 1 + Ant. 2

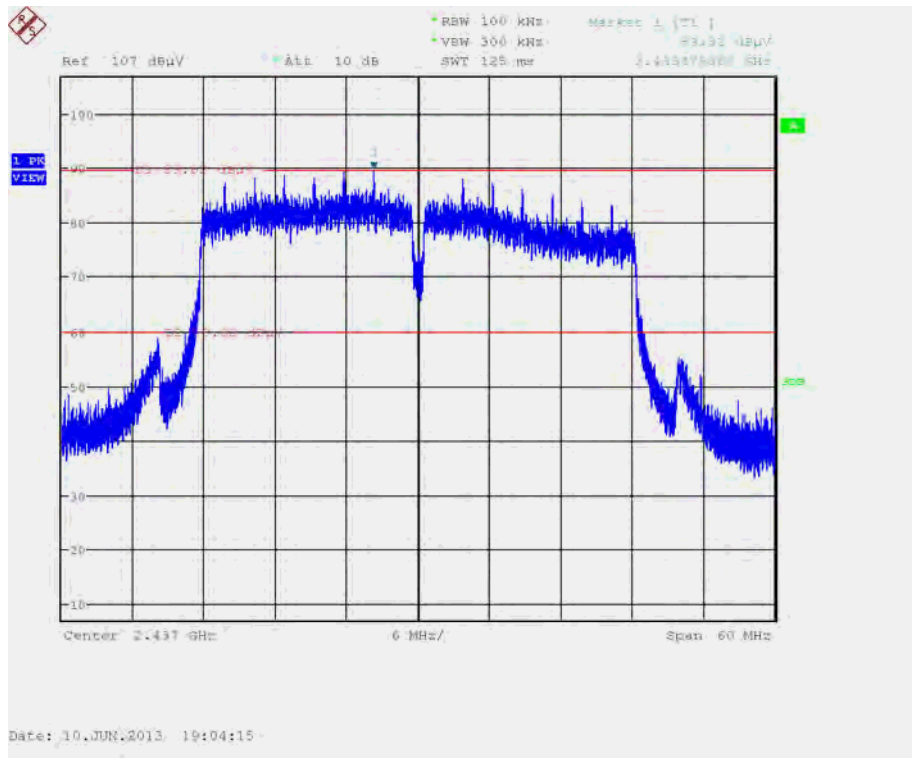

Low Band Edge Plot on Configuration IEEE 802.11n MCS8 40MHz / 2422 MHz / Ant. 1 + Ant. 2

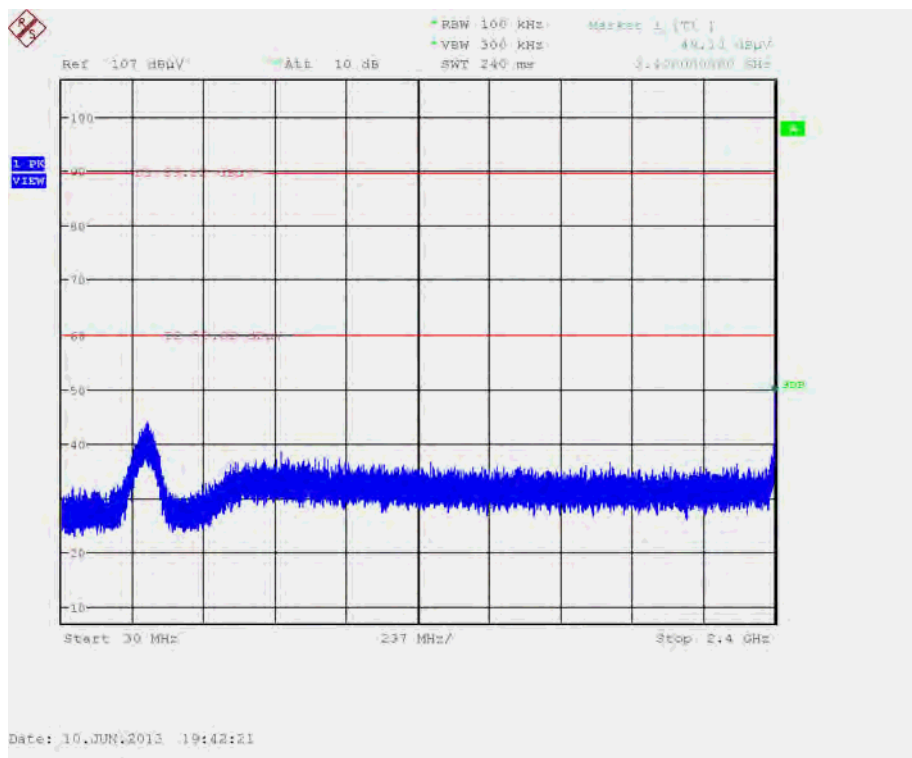

Low Band Edge Plot on Configuration IEEE 802.11n MCS8 40MHz / 2422 MHz / Ant. 1 + Ant. 2

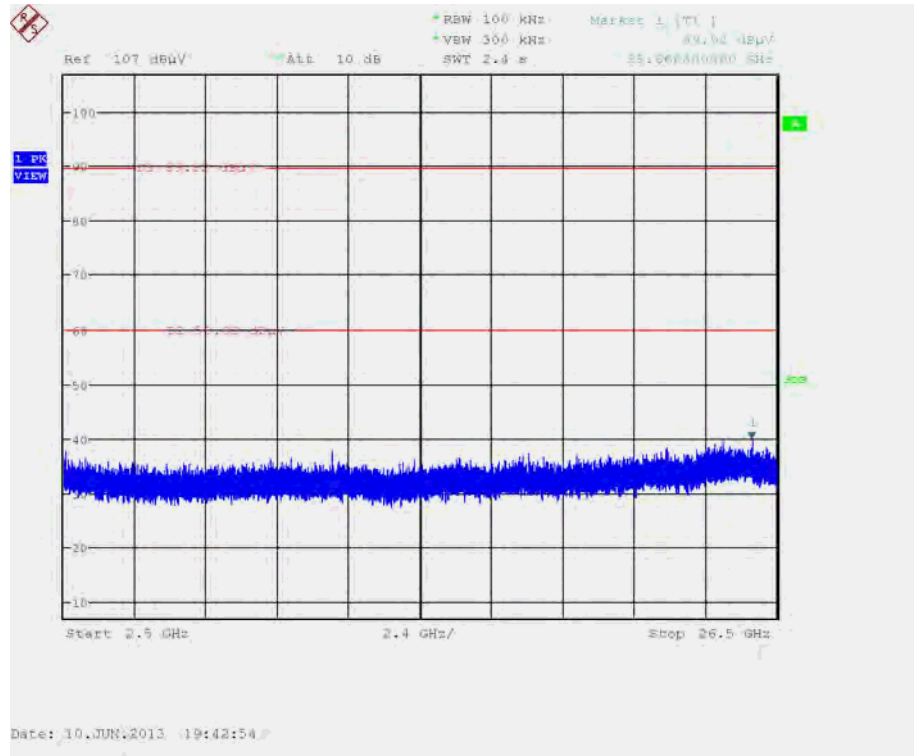

Low Band Edge Plot on Configuration IEEE 802.11n MCS8 40MHz / 2452 MHz / Ant. 1 + Ant. 2

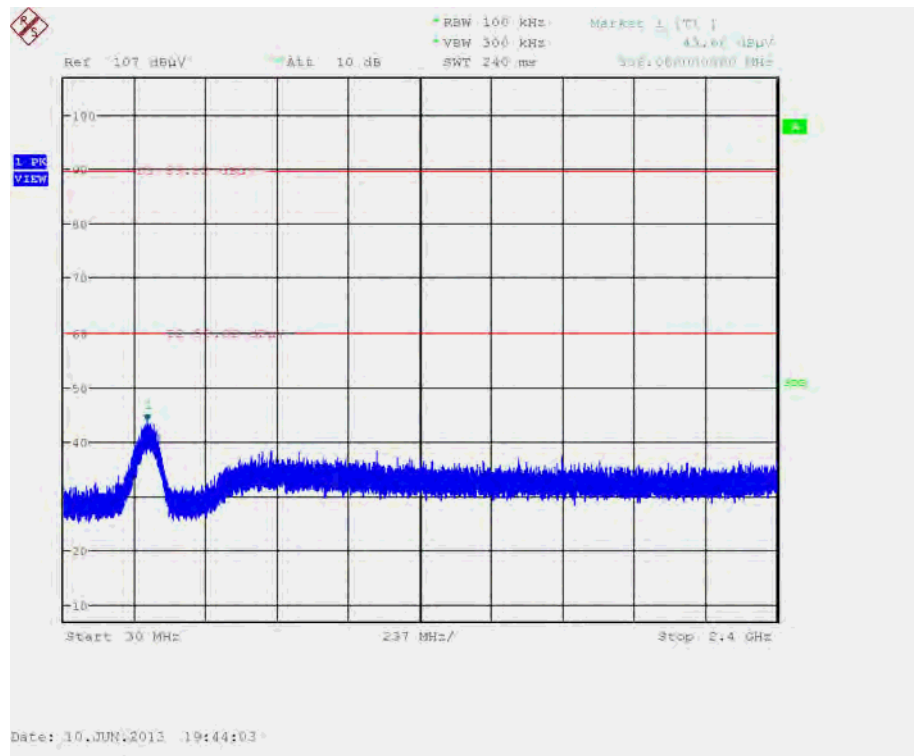





### **3.7 Antenna Requirements**

#### **3.7.1 Limit**

Except for special regulations, the Low-power Radio-frequency Devices must not be equipped with any jacket for installing an antenna with extension cable. An intentional radiator shall be designed to ensure that no antenna other than that furnished by the responsible party shall be used with the device. The use of a permanently attached antenna or of an antenna that uses a unique coupling to the intentional radiator shall be considered sufficient to comply with the provisions of this Section. The manufacturer may design the unit so that the user can replace a broken antenna, but the use of a standard antenna jack or electrical connector is prohibited. Further, this requirement does not apply to intentional radiators that must be professionally installed.

#### **3.7.2 Antenna Connector Construction**

Please refer to section 2.3 in this test report; antenna connector complied with the requirements.

**4 LIST OF MEASURING EQUIPMENTS**

Instrument	Manufacturer	Model No.	Serial No.	Characteristics	Calibration Date	Remark
EMI Test Receiver	R&S	ESCS 30	100377	9kHz ~ 2.75GHz	Oct. 23, 2012	Conduction (CO01-CB)
LISN	F.C.C.	FCC-LISN-50-16-2	04083	150kHz ~ 100MHz	Nov. 26, 2012	Conduction (CO01-CB)
V- LISN	Schwarzbeck	NSLK 8127	8127478	9kHz ~ 30MHz	Jun. 26, 2012	Conduction (CO01-CB)
Impulsbegrenzer Pulse Limiter	Rohde&Schwarz	ESH3-Z2	100430	9kHz~30MHz	Feb. 21, 2013	Conduction (CO01-CB)
COND Cable	Woken	Cable	01	0.15MHz~30MHz	Dec. 04, 2012	Conduction (CO01-CB)
Software	Audix	E3	5.410e	-	-	Conduction (CO01-CB)
BILOG ANTENNA	Schaffner	CBL6112D	22021	20MHz ~ 2GHz	Apr. 16, 2013	Radiation (03CH01-CB)
Loop Antenna	Teseq	HLA 6120	24155	9 kHz - 30 MHz	Nov. 05, 2012*	Radiation (03CH01-CB)
Horn Antenna	EMCO	3115	00075790	750MHz~18GHz	Nov. 27, 2012	Radiation (03CH01-CB)
Horn Antenna	SCHWARZBEAK	BBHA 9170	BBHA9170252	15GHz ~ 40GHz	Nov. 23, 2012	Radiation (03CH01-CB)
Pre-Amplifier	Agilent	8447D	2944A10991	0.1MHz ~ 1.3GHz	Nov. 27, 2012	Radiation (03CH01-CB)
Pre-Amplifier	Agilent	8449B	3008A02310	1GHz ~ 26.5GHz	Nov. 23, 2012	Radiation (03CH01-CB)
Pre-Amplifier	WM	TF-130N-R1	923365	26.5GHz ~ 40GHz	Jul. 31, 2012	Radiation (03CH01-CB)
Spectrum analyzer	R&S	FSP40	100056	9KHz~40GHz	Nov. 16, 2012	Radiation (03CH01-CB)
EMI Test Receiver	R&S	ESCS 30	100355	9KHz ~ 2.75GHz	Apr. 12, 2013	Radiation (03CH01-CB)
Turn Table	INN CO	CO 2000	N/A	0 ~ 360 degree	N.C.R	Radiation (03CH01-CB)
Antenna Mast	INN CO	CO2000	N/A	1 m - 4 m	N.C.R	Radiation (03CH01-CB)
RF Cable-low	Woken	Low Cable-1	N/A	30 MHz - 1 GHz	Nov. 18, 2012	Radiation (03CH01-CB)
RF Cable-high	Woken	High Cable-1	N/A	1 GHz – 26.5 GHz	Nov. 18, 2012	Radiation (03CH01-CB)
RF Cable-high	Woken	High Cable-2	N/A	1 GHz – 26.5 GHz	Nov. 18, 2012	Radiation (03CH01-CB)
RF Cable-high	Woken	High Cable-3	N/A	1 GHz - 40 GHz	Nov. 18, 2012	Radiation (03CH01-CB)
RF Cable-high	Woken	High Cable-4	N/A	1 GHz - 40 GHz	Nov. 18, 2012	Radiation (03CH01-CB)
Signal analyzer	R&S	FSV40	100979	9kHz~40GHz	Oct. 08, 2012	Conducted (TH01-CB)
RF Power Divider	Woken	2 Way	0120A02056002D	2GHz ~ 18GHz	Nov. 18, 2012	Conducted (TH01-CB)
RF Cable-high	Woken	High Cable-7	-	1 GHz – 26.5 GHz	Nov. 19, 2012	Conducted (TH01-CB)

<b>Instrument</b>	<b>Manufacturer</b>	<b>Model No.</b>	<b>Serial No.</b>	<b>Characteristics</b>	<b>Calibration Date</b>	<b>Remark</b>
RF Cable-high	Woken	High Cable-8	-	1 GHz – 26.5 GHz	Nov. 19, 2012	Conducted (TH01-CB)
RF Cable-high	Woken	High Cable-9	-	1 GHz – 26.5 GHz	Nov. 19, 2012	Conducted (TH01-CB)
RF Cable-high	Woken	High Cable-10	-	1 GHz – 26.5 GHz	Nov. 19, 2012	Conducted (TH01-CB)
RF Cable-high	Woken	High Cable-11	-	1 GHz – 26.5 GHz	Nov. 19, 2012	Conducted (TH01-CB)
Power Sensor	Anritsu	MA2411B	0917223	300MHz~40GHz	Nov. 28, 2012	Conducted (TH01-CB)
Power Meter	Anritsu	ML2495A	1035008	300MHz~40GHz	Nov. 27, 2012	Conducted (TH01-CB)

Note: Calibration Interval of instruments listed above is one year.

\*Calibration Interval of instruments listed above is two year.

N.C.R. means Non-Calibration required.

## 5 TEST LOCATION

SHIJR	ADD : 6Fl., No. 106, Sec. 1, Shintai 5th Rd., Shijr City, Taipei, Taiwan 221, R.O.C. TEL : 886-2-2696-2468 FAX : 886-2-2696-2255
HWA YA	ADD : No. 52, Hwa Ya 1st Rd., Kwei-Shan Hsiang, Tao Yuan Hsien, Taiwan, R.O.C. TEL : 886-3-327-3456 FAX : 886-3-318-0055
LINKOU	ADD : No. 30-2, Dingfu Tsuen, Linkou Shiang, Taipei, Taiwan 244, R.O.C TEL : 886-2-2601-1640 FAX : 886-2-2601-1695
DUNGHU	ADD : No. 3, Lane 238, Kangle St., Neihu Chiu, Taipei, Taiwan 114, R.O.C. TEL : 886-2-2631-4739 FAX : 886-2-2631-9740
JUNGHE	ADD : 7Fl., No. 758, Jungjeng Rd., Junghe City, Taipei, Taiwan 235, R.O.C. TEL : 886-2-8227-2020 FAX : 886-2-8227-2626
NEIHU	ADD : 4Fl., No. 339, Hsin Hu 2 <sup>nd</sup> Rd., Taipei 114, Taiwan, R.O.C. TEL : 886-2-2794-8886 FAX : 886-2-2794-9777
JHUBEI	ADD : No.8, Lane 724, Bo-ai St., Jhubei City, HsinChu County 302, Taiwan, R.O.C. TEL : 886-3-656-9065 FAX : 886-3-656-9085

## 6 MEASUREMENT UNCERTAINTY

### Uncertainty of Conducted Emission Measurement (150kHz ~ 30MHz)

Contribution	Uncertainty of $x_i$			$u(x_i)$
	Value	Unit	Probability Distribution k	
Receiver reading	0.026	dB	normal(k=2)	0.013
Cable loss	0.002	dB	normal(k=2)	0.001
AMN/LISN specification	1.200	dB	normal(k=2)	0.600
Mismatch Receiver VSWR 1= AMN/LISN VSWR 2=	-0.080	dB	U-shaped	0.060
combined standard uncertainty $Ue(y)$	1.2			
Measuring uncertainty for a level of confidence of 95% $U=2Ue(y)$	2.4			

### Uncertainty of Conducted Emission Measurement

Contribution	Uncertainty of $x_i$			$u(x_i)$
	Value	Unit	Probability Distribution k	
Cable loss	0.038	dB	normal(k=2)	0.019
Attenuator	0.047	dB	normal(k=2)	0.024
Power Meter specification	0.300	dB	normal(k=2)	0.150
Power Sensor specification	0.300	dB	normal(k=2)	0.150
Mismatch Receiver VSWR 1= Antenna VSWR 2= Pre Amplifier VSWR 3=	-0.080	dB	U-shaped	0.060
combined standard uncertainty $Ue(y)$	0.403			
Measuring uncertainty for a level of confidence of 95% $U=2Ue(y)$	0.806			

**Uncertainty of Radiated Emission Measurement (30MHz ~ 1,000MHz)**

Contribution	Uncertainty of $x_i$			$u(x_i)$
	Value	Unit	Probability Distribution k	
Receiver reading	0.1727	dB	normal(k=1)	0.1727
Cable loss	0.1736	dB	normal(k=2)	0.0868
Antenna gain	0.1687	dB	normal(k=2)	0.0843
Site imperfection	0.4898	dB	Triangular	0.2
Pre-amplifier gain	0.3661	dB	normal(k=2)	0.183
Transmitter antenna	1.7	dB	rectangular	0.9815
Signal generator	0.5	dB	rectangular	0.2887
Mismatch	0.08	dB	u-shape	0.244
Spectrum analyzer	0.5	dB	rectangular	0.2887
combined standard uncertainty $Ue(y)$	1.1434			
Measuring uncertainty for a level of confidence of 95% $U=2Ue(y)$	2.2869			

**Uncertainty of Radiated Emission Measurement (1GHz ~ 18GHz)**

Contribution	Uncertainty of $x_i$			$u(x_i)$
	Value	Unit	Probability Distribution k	
Receiver reading	0.1908	dB	normal(k=1)	0.1908
Cable loss	0.1685	dB	normal(k=2)	0.0843
Antenna gain	0.1912	dB	normal(k=2)	0.0956
Site imperfection	1.3091	dB	Triangular	0.5344
Pre-amplifier gain	0.3043	dB	normal(k=2)	0.1521
Transmitter antenna	1.7	dB	rectangular	0.9815
Signal generator	0.5	dB	rectangular	0.2887
Mismatch	0.08	dB	u-shape	0.244
Spectrum analyzer	0.8	dB	rectangular	0.4619
combined standard uncertainty $Ue(y)$	1.2965			
Measuring uncertainty for a level of confidence of 95% $U=2Ue(y)$	2.593			

**Uncertainty of Radiated Emission Measurement (18GHz ~ 40GHz)**

Contribution	Uncertainty of $x_i$			$u(x_i)$
	Value	Unit	Probability Distribution k	
Receiver reading	0.1864	dB	normal(k=1)	0.1864
Cable loss	0.1666	dB	normal(k=2)	0.0833
Antenna gain	0.1904	dB	normal(k=2)	0.0952
Site imperfection	0.4882	dB	Triangular	0.1993
Pre-amplifier gain	0.2688	dB	normal(k=2)	0.1344
Transmitter antenna	1.7	dB	rectangular	0.9815
Signal generator	0.5	dB	rectangular	0.2887
Mismatch	0.08	dB	u-shape	0.244
Spectrum analyzer	0.8	dB	rectangular	0.4619
combined standard uncertainty $U_e(y)$	1.1874			
Measuring uncertainty for a level of confidence of 95% $U=2U_e(y)$	2.3749			