

FCC Test Report

Report No.: RF151123E05A R1

FCC ID: RSE-TG788VV3NP

Equipment Name: Technicolor Gateway

Trade Name: technicolor

Model Number: TG788v v3

Product Code: DSLCBH788PR

Received Date: Feb. 24, 2017

Test Date: Mar. 13 to 16, 2017

Issued Date: May 26, 2017

Applicant: Technicolor Delivery Technologies Belgium

Address: Prins Boudewijnlaan 47, 2650 EDEGEM BELGIUM

Issued By: Bureau Veritas Consumer Products Services (H.K.) Ltd., Taoyuan Branch
Hsin Chu Laboratory

Lab Address: E-2, No.1, Li Hsin 1st Road, Hsinchu Science Park, Hsinchu City 300,
Taiwan R.O.C.



This report is for your exclusive use. Any copying or replication of this report to or for any other person or entity, or use of our name or trademark, is permitted only with our prior written permission. This report sets forth our findings solely with respect to the test samples identified herein. The results set forth in this report are not indicative or representative of the quality or characteristics of the lot from which a test sample was taken or any similar or identical product unless specifically and expressly noted. Our report includes all of the tests requested by you and the results thereof based upon the information that you provided to us. You have 60 days from date of issuance of this report to notify us of any material error or omission caused by our negligence, provided, however, that such notice shall be in writing and shall specifically address the issue you wish to raise. A failure to raise such issue within the prescribed time shall constitute your unqualified acceptance of the completeness of this report, the tests conducted and the correctness of the report contents. Unless specific mention, the uncertainty of measurement has been explicitly taken into account to declare the compliance or non-compliance to the specification. The report must not be used by the client to claim product certification, approval, or endorsement by TAF or any government agencies.

Table of Contents

Release Control Record	4
1 Certificate of Conformity	5
2 Summary of Test Results	6
2.1 Measurement Uncertainty	6
2.2 Modification Record	6
3 General Information	7
3.1 Basic Description of Equipment Under Test (WLAN 2.4GHz)	7
3.2 Accessories	9
3.3 Feature of Equipment under Test	9
3.4 Information Provided by the Manufacturer	9
3.5 General Description of Applied Standards	10
3.6 Cabling Attached to the Equipment	11
3.7 Panel Drawing	12
3.8 Transmit Operating Mode	13
3.9 Antenna Requirements	13
3.10 Antenna Information	14
3.11 Table for Carrier Frequency	16
3.12 Table for Test Modes	17
3.13 Parameters of Test Software Setting	18
3.14 On Time and Duty Cycle	19
3.15 Testing Location Information	20
3.16 EUT Diagram and Support Equipment	21
4 Test Types and Results	23
4.1 AC Power Conducted Emissions Measurement	23
4.1.1 Limit	23
4.1.2 Measuring Instruments and Setting	23
4.1.3 Test Procedures	23
4.1.4 Test Setup Layout	24
4.1.5 Test Deviation	24
4.1.6 EUT Operating during Test	25
4.1.7 Test Results of AC Power Conducted Emissions	25
4.2 Maximum Conducted Output Power Measurement	27
4.2.1 Limit	27
4.2.2 Measuring Instruments and Setting	27
4.2.3 Test Procedures	27
4.2.4 Test Setup Layout	28
4.2.5 Test Deviation	28
4.2.6 EUT Operating Conditions	28
4.2.7 Test Results of Maximum Conducted Output Power	29
4.3 Power Spectral Density Measurement	31
4.3.1 Limit	31
4.3.2 Measuring Instruments and Setting	31
4.3.3 Test Procedures	31
4.3.4 Test Setup Layout	32
4.3.5 Test Deviation	32
4.3.6 EUT Operating Conditions	32
4.3.7 Test Results of Power Spectral Density	33
4.4 6dB Bandwidth Measurement	39
4.4.1 Limit	39
4.4.2 Measuring Instruments and Setting	39
4.4.3 Test Procedures	39
4.4.4 Test Setup Layout	40
4.4.5 Test Deviation	40

4.4.6	EUT Operating Conditions.....	40
4.4.7	Test Results of 6dB Bandwidth.....	41
4.5	Occupied Bandwidth Measurement.....	47
4.5.1	Measuring Instruments and Setting.....	47
4.5.2	Test Procedure.....	47
4.5.3	Test Setup Layout.....	47
4.5.4	Test Deviation.....	48
4.5.5	EUT Operating Conditions.....	48
4.5.6	Test Results of Occupied Bandwidth.....	49
4.6	Radiated Emissions Measurement.....	54
4.6.1	Limit.....	54
4.6.2	Measuring Instruments and Setting.....	54
4.6.3	Test Procedure.....	55
4.6.4	Test Setup Layout.....	56
4.6.5	Test Deviation.....	57
4.6.6	EUT Operating Conditions.....	57
4.6.7	Test Results of Radiated Emissions.....	58
4.7	Band Edge and Fundamental Emissions Measurement.....	84
4.7.1	Limit.....	84
4.7.2	Measuring Instruments and Setting.....	84
4.7.3	Test Procedure.....	84
4.7.4	Test Setup Layout.....	85
4.7.5	Test Deviation.....	86
4.7.6	EUT Operating Conditions.....	86
4.7.7	Test Results of Band Edge and Fundamental Emissions.....	87
4.7.8	Test Results of Band Edge and Emissions not in Restricted Bands.....	111
4.8	List of Test Instruments.....	118
Appendix A. Photographs of EUT.....		121
Appendix B. Photographs of Test.....		136
	For Conducted Emissions Test.....	136
	For Radiated Emissions below 1 GHz Test.....	137
	For Radiated Emissions above 1 GHz Test.....	138
Appendix C. List of test command.....		140
Appendix D. Information on the Testing Laboratories.....		238

Release Control Record

Issue No.	Description	Date Issued
RF151123E05A	Original release.	May 08, 2017
RF151123E05A R1	Modified the adapter information.	May 26, 2017

1 Certificate of Conformity

Equipment Name: Technicolor Gateway

Trade Name: technicolor

Test Model: TG788v v3

Product Code: DSLCBH788PR

Sample Status: Product Unit

Applicant: Technicolor Delivery Technologies Belgium

Test Date: Mar. 13 to 16, 2017

Standards: 47 CFR FCC Part 15, Subpart C (Section 15.247)
ANSI C63.10: 2013

The above equipment has been tested by **Bureau Veritas Consumer Products Services (H.K.) Ltd., Taoyuan Branch**, and found compliance with the requirement of the above standards. The test record, data evaluation & Equipment Under Test (EUT) configurations represented herein are true and accurate accounts of the measurements of the sample's RF EMI characteristics under the conditions specified in this report.

Prepared by :



Date: May 26, 2017

Claire Kuan / Specialist

Approved by :

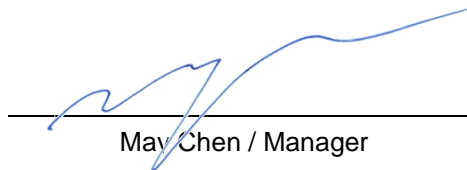

Date: May 26, 2017

May Chen / Manager

2 Summary of Test Results

Applied Standard: 47 CFR FCC Part 15 Subpart C					
Section	Ref. Std. Clause	Description	Measured	Limit	Result
3.9	15.203	Antenna Requirements	-	-	PASS
4.1	15.207	AC Power Conducted Emissions	Margin is -3.37dB at 0.15000MHz.	-	PASS
4.2	15.247(b)(3)	Maximum Conducted Output Power	Power [dBm]: 11b: 16.93 dBm 11g: 18.31 dBm 11n(20M): 20.85 dBm 11n(40M): 16.15 dBm	30 dBm	PASS
4.3	15.247(e)	Power Spectral Density	PSD [dBm]: 11b: -9.96 dBm/3kHz 11g: -14.29 dBm/3kHz 11n(20M): -10.15 dBm/3kHz 11n(40M): -18.20 dBm/3kHz	8dBm/3kHz	PASS
4.4	15.247(a)(2)	6dB Spectrum Bandwidth	Bandwidth [MHz]: 11b: 8.11 MHz 11g: 15.11 MHz 20MHz: 15.16 MHz 11n(40M): 35.18 MHz	≥500kHz	PASS
4.5	-	Occupied Bandwidth	Bandwidth [MHz]: 11b: 10.20 MHz 11g: 17.52 MHz 11n(20M): 17.64 MHz 11n(40M): 36.72 MHz	FCC 15.207	-
4.6	15.247(d)	Radiated Emissions	Margin is -2.5dB at 4874.00MHz	-	PASS
4.7	15.247(a)(2)	Band Edge Emissions	Margin is -0.2dB at 2483.50MHz.	-	PASS

2.1 Measurement Uncertainty

Where relevant, the following measurement uncertainty levels have been estimated for tests performed on the EUT as specified in CISPR 16-4-2:

Measurement	Frequency	Expanded Uncertainty (k=2) (±)
Conducted Emissions at mains ports	150kHz ~ 30MHz	1.84 dB
Radiated Emissions up to 1 GHz	30MHz ~ 1GHz	5.30 dB
Radiated Emissions above 1 GHz	1GHz ~ 6GHz	4.78 dB
	6GHz ~ 18GHz	4.52 dB
	18GHz ~ 40GHz	5.08 dB

2.2 Modification Record

There were no modifications required for compliance.

3 General Information

3.1 Basic Description of Equipment Under Test (WLAN 2.4GHz)

Items	Description
Equipment Name	Technicolor Gateway
Trade Name	technicolor
Model Number	TG788v v3
Product Code	DSL CBH788PR
FCC ID	RSE-TG788VV3NP
Power Type	From power adapter
Antenna	Refer section 3.10
EUT Stage	<input checked="" type="checkbox"/> Product Unit <input type="checkbox"/> Pre-Sample
Operating Band and Conducted Output Power	2400~2483.5MHz
	<input checked="" type="checkbox"/> IEEE 802.11b: 16.93 dBm
	<input checked="" type="checkbox"/> IEEE 802.11g: 18.31 dBm
	<input checked="" type="checkbox"/> IEEE 802.11n (20MHz): 20.85 dBm
	<input checked="" type="checkbox"/> IEEE 802.11n (40MHz): 16.15 dBm
Product Type	For IEEE 802.11b: WLAN(1TX, 2RX) For IEEE 802.11g: WLAN(1TX, 2RX) For IEEE 802.11n: WLAN(2TX, 2RX)
Nominal Bandwidth	20MHz / 40MHz
Modulation	802.11b: DSSS (DBPSK, DQPSK, CCK) 802.11g: OFDM (BPSK / QPSK / 16QAM / 64QAM) 802.11n: (BPSK / QPSK / 16QAM / 64QAM) See the below table
Data Rate (Mbps)	802.11b mode :DSSS (1/2/5.5/11) 802.11g mode :OFDM (6/9/12/18/24/36/48/54) 802.11n(20MHz) mode(MCS0~MCS15) 802.11n(40MHz) mode(MCS0~MCS15) See the below table
I/O Ports	DSL x 1 FXS x 2 Ethernet x 4 USB 2.0 x 1
Hardware Version	LAB2
Software Version	16.1.7599

EUT	xDSL	LAN	2.4G WLAN	FXS	USB 2.0
TG788v v3	• (POTS)	• (4 ports 10/100M)	• (802.11n 2x2) Normal power	• (2 ports)	•

And Product code : DSL CBH788PR

IEEE Std. 802.11n modulation and data rate information

MCS Index	Spatial Streams	Modulation Type	Coding Rate	Data Rate (Mbit/s)			
				20 MHz channel		40 MHz channel	
				800ns GI	400ns GI	800ns GI	400ns GI
0	1	BPSK	1/2	6.5	7.2	13.5	15
1		QPSK	1/2	13	14.4	27	30
2		QPSK	3/4	19.5	21.7	40.5	45
3		16-QAM	1/2	26	28.9	54	60
4		16-QAM	3/4	39	43.3	81	90
5		64-QAM	2/3	52	57.8	108	120
6		64-QAM	3/4	58.5	65	121.5	135
7		64-QAM	5/6	65	72.2	135	150
8	2	BPSK	1/2	13	14.4	27	30
9		QPSK	1/2	26	28.9	54	60
10		QPSK	3/4	39	43.3	81	90
11		16-QAM	1/2	52	57.8	108	120
12		16-QAM	3/4	78	86.7	162	180
13		64-QAM	2/3	104	115.6	216	240
14		64-QAM	3/4	117	130	243	270
15		64-QAM	5/6	130	144.4	270	300

Note: GI means guard interval.

3.2 Accessories

Power supply:

Brand:	AcBel
Model:	WAE007 ADKG2
Input:	100-240V, 0.7A, 50/60Hz
Output:	12V, 1.5A (1.5m, without ferrite core, non-shielding)

3.3 Feature of Equipment under Test

Please refer to user manual.

3.4 Information Provided by the Manufacturer

Interface Availability

Interface Model	DSL	FXS	Ethernet 10/100 Mbps	DC 12Vdc	USB 2.0	WLAN 802.11b/g/n (2.4GHz 2*2)
TG788v v3	● (1 port)	● (2 port)	● (4 port)	● (1.5A)	● (1 port)	●

● : Equipped

○ : Not Equipped

3.5 General Description of Applied Standards

The EUT is a RF Product. According to the specifications of the manufacturer, it must comply with the requirements of the following standards:

FCC Part 15, Subpart C (15.247)

KDB 558074 D01 DTS Meas Guidance v04, 04/05/2017

KDB 662911 D01 Multiple Transmitter Output v02r01, 10/31/2013

ANSI C63.10-2013

All test items have been performed and recorded as per the above standards.

NOTE: The EUT has been verified to comply with the requirements of FCC Part 15, Subpart B, Class B (DoC). The test report has been issued separately.

3.6 Cabling Attached to the Equipment

Cable and Interconnection

Interface	Cable Type	Cable Length Delivered with the Modem	"Real Life" Cable Length that can be Attached to this Type of Interface	Cable Length to be used for Testing	Internal/ External Connection
Ethernet	UTP Cat 5	1 meter	> 10 meter	10 meter	Internal
DSL	UTP Cat 3	1 meter	> 10 meter	10 meter	External
FXS	UTP Cat 3	1 meter	> 10 meter	10 meter	Internal
AC power	-	-	-	-	External

3.7 Panel Drawing



3.8 Transmit Operating Mode

Transmit Operating Mode				Transmit Multiple Antennas						
<input checked="" type="checkbox"/>	Operating mode 1 (single antenna)			<input checked="" type="checkbox"/>	1TX					
<input checked="" type="checkbox"/>	Operating mode 2 (multiple antenna, no beam forming)			<input checked="" type="checkbox"/>	2TX	<input type="checkbox"/>	3TX	<input type="checkbox"/>	4TX	
<input type="checkbox"/>	Operating mode 3 (multiple antenna, with beam forming)			<input type="checkbox"/>	2TX	<input type="checkbox"/>	3TX	<input type="checkbox"/>	4TX	
<input checked="" type="checkbox"/>	802.11b	Operating mode	<input checked="" type="checkbox"/>	1TX	<input type="checkbox"/>	2TX	<input type="checkbox"/>	3TX	<input type="checkbox"/>	Cyclic shift
<input checked="" type="checkbox"/>	802.11g	Operating mode	<input checked="" type="checkbox"/>	1TX	<input type="checkbox"/>	2TX	<input type="checkbox"/>	3TX	<input type="checkbox"/>	Cyclic shift
<input checked="" type="checkbox"/>	802.11n(20MHz)	Operating mode	<input checked="" type="checkbox"/>	1TX	<input checked="" type="checkbox"/>	2TX	<input type="checkbox"/>	3TX	<input type="checkbox"/>	Cyclic shift
<input checked="" type="checkbox"/>	802.11n(40MHz)	Operating mode	<input checked="" type="checkbox"/>	1TX	<input checked="" type="checkbox"/>	2TX	<input type="checkbox"/>	3TX	<input type="checkbox"/>	Cyclic shift

Note: For 802.11n, MCS0~MCS7: 1S1T SISO and 1S2T CDD; MCS8~MCS15: 2S2T SDM mode

3.9 Antenna Requirements

Except for special regulations, the Low-power Radio-frequency Devices must not be equipped with any jacket for installing an antenna with extension cable. An intentional radiator shall be designed to ensure that no antenna other than that furnished by the responsible party shall be used with the device. The use of a permanently attached antenna or of an antenna that uses a unique coupling to the intentional radiator shall be considered sufficient to comply with the provisions of this Section. The manufacturer may design the unit so that the user can replace a broken antenna, but the use of a standard antenna jack or electrical connector is prohibited. Further, this requirement does not apply to intentional radiators that must be professionally installed.

3.10 Antenna Information

Antenna Information				
Ant.	Brand	Model No.	Antenna Type	Connector
1	-	-	PCB Antenna	NA
2	-	-	PCB Antenna	NA

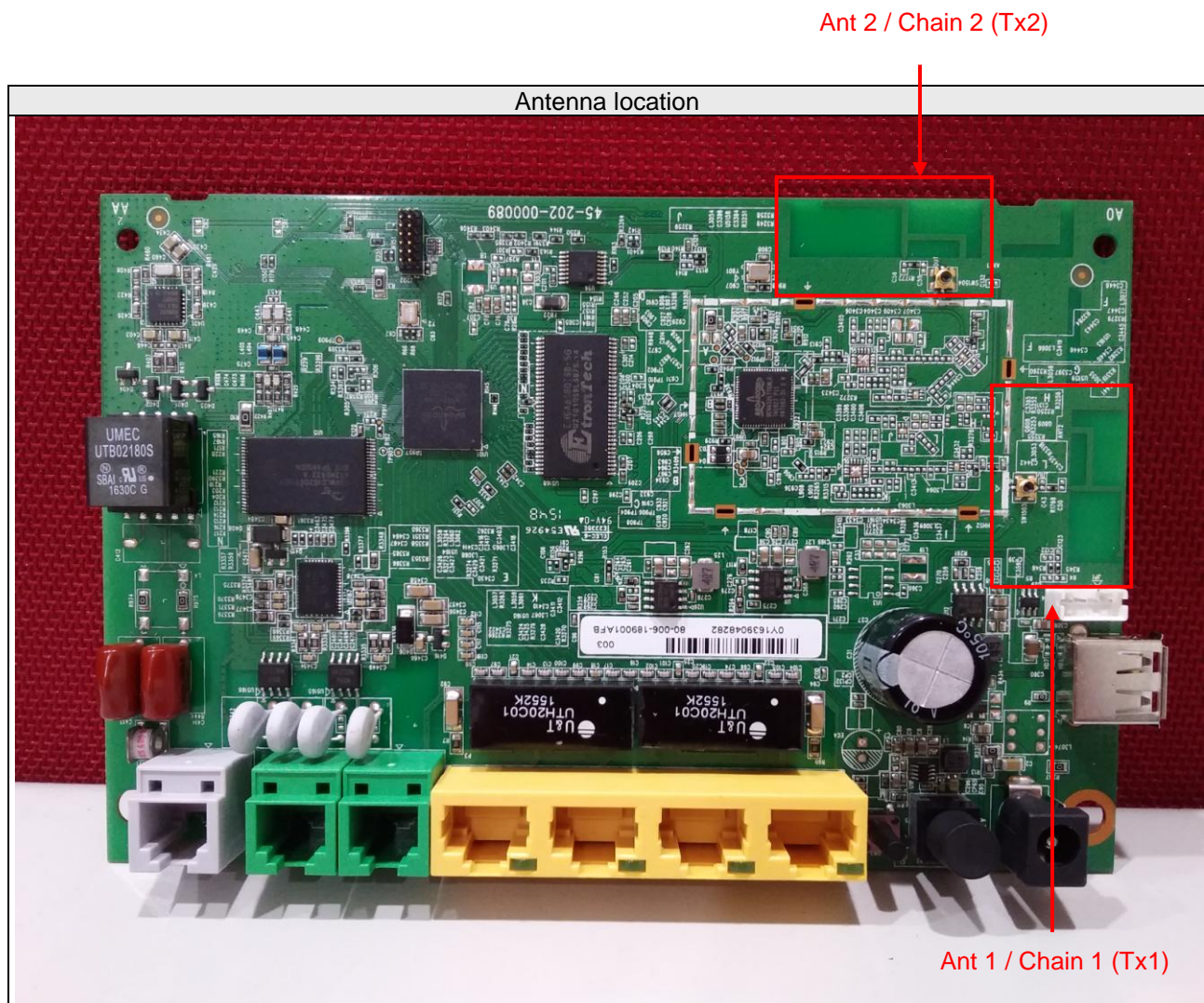

Frequency	Antenna Gain (dBi)			
	Ant. A1 (J711)		Ant. A2 (J710)	
	20 MHz	40 MHz	20 MHz	40 MHz
2412MHz	3.02	-	3.22	-
2422MHz	-	3.01	-	3.38
2437MHz	3.06	3.06	3.53	3.53
2452MHz	-	3.06	-	3.61
2462MHz	3.15	-	3.74	-

Frequency	Maximum Gain (dBi) for CDD mode			
	CDD mode (1 Stream 2 TX) for Power Gain		CDD mode (1 Stream 2 TX) for PSD Gain	
	20 MHz	40 MHz	20 MHz	40 MHz
2412MHz	3.22	-	6.13	-
2422MHz	-	3.38	-	6.21
2437MHz	3.53	3.53	6.31	6.31
2452MHz	-	3.61	-	6.35
2462MHz	3.74	-	6.46	-

Note:

- Maximum Correlated Directional Gain = $10 \log[(10 G_1 / 20 + 10 G_2 / 20 + \dots + 10 G_N / 20)^2 / N \text{ ANT}] \text{ dBi}$

Number of Transmitter Antennas & Bandwidth

Number of Transmitter Antennas	1TX		2TX	
	20 MHz	40 MHz	20 MHz	40 MHz
802.11b	V	X	X	X
802.11g	V	X	X	X
802.11n	V	V	V	V

3.11 Table for Carrier Frequency

Eleven channels are provided for 802.11b, 802.11g, 802.11n (20MHz):

Frequency Band	Channel No.	Frequency	Channel No.	Frequency
2400MHz ~ 2483.5 MHz	1	2412 MHz	7	2442MHz
	2	2417MHz	8	2447MHz
	3	2422MHz	9	2452MHz
	4	2427MHz	10	2457MHz
	5	2432MHz	11	2462MHz
	6	2437MHz		

Seven channels are provided for 802.11n (40MHz):

Frequency Band	Channel No.	Frequency	Channel No.	Frequency
2400MHz ~ 2483.5 MHz	3	2422 MHz	7	2442MHz
	4	2427MHz	8	2447MHz
	5	2432MHz	9	2452MHz
	6	2437MHz		

3.12 Table for Test Modes

Investigation has been done on all the possible configurations for searching the worst cases. The following table is a list of the test modes shown in this test report.

Test Items	Mode	Note	Channel	Data Rate	Antenna
AC Power Conducted Emissions	802.11n (20MHz)	OFDM/BPSK	6	-	1+2
Conducted Output Power	802.11b	DSSS/DBPSK	1/6/11	1Mbps	1
	802.11g	OFDM/BPSK	1/6/11	6Mbps	1
	802.11n (20MHz)		1/6/11	MCS0 1S2T(CDD)	1+2
	802.11n (40MHz)		3/6/9	MCS0 1S2T(CDD)	1+2
Power Spectral Density	802.11b	DSSS/DBPSK	1/6/11	1Mbps	1
	802.11g	OFDM/BPSK	1/6/11	6Mbps	1
	802.11n (20MHz)		1/6/11	MCS0 1S2T(CDD)	1+2
	802.11n (40MHz)		3/6/9	MCS0 1S2T(CDD)	1+2
6dB Bandwidth	802.11b	DSSS/DBPSK	1/6/11	1Mbps	1,
	802.11g	OFDM/BPSK	1/6/11	6Mbps	1
	802.11n (20MHz)		1/6/11	MCS0 1S2T(CDD)	1+2
	802.11n (40MHz)		3/6/9	MCS0 1S2T(CDD)	1+2
Band Edge Emissions	802.11b	DSSS/DBPSK	1/6/11	1Mbps	1
	802.11g	OFDM/BPSK	1/6/11	6Mbps	1
	802.11n (20MHz)		1/6/11	MCS0 1S2T(CDD)	1+2
	802.11n (40MHz)		3/6/9	MCS0 1S2T(CDD)	1+2
Radiated Emissions Above 1GHz	802.11b	DSSS/DBPSK	1/6/11	1Mbps	1
	802.11g	OFDM/BPSK	1/6/11	6Mbps	1
	802.11n (20MHz)		1/6/11	MCS0 1S2T(CDD)	1+2
	802.11n (40MHz)		3/6/9	MCS0 1S2T(CDD)	1+2
Radiated Emissions Below 1GHz	802.11n (20MHz)	OFDM/BPSK	6	-	1+2

3.13 Parameters of Test Software Setting

During testing, Channel & Power Controlling Software provided by the customer was used to control the operating channel as well as the output power level. The RF output power selection is for the setting of RF output power expected by the customer and is going to be fixed on the firmware of the final end product.

The Power Setting Parameter					
Test Software Version	Mtool 2.0.1.0				
Worst Modulation Mode	Number of Transmit Chains (NTX)	Frequency (MHz)	Maximum Output Power (dBm)	Power Setting	Data Rate / MCS
802.11b, Ant. 1	1Stream 1TX	2412	16.92	65	1Mbps
802.11b, Ant. 1	1Stream 1TX	2437	16.93	65	1Mbps
802.11b, Ant. 1	1Stream 1TX	2462	16.71	64	1Mbps
802.11g, Ant. 1	1Stream 1TX	2412	13.24	50	6Mbps
802.11g, Ant. 1	1Stream 1TX	2437	18.31	70	6Mbps
802.11g, Ant. 1	1Stream 1TX	2462	12.61	46	6Mbps
802.11n 20MHz, Ant. 1+2 (CDD)	1Stream 2TX	2412	15.55	46	MCS0
802.11n 20MHz, Ant. 1+2 (CDD)	1Stream 2TX	2437	20.85	68	MCS0
802.11n 20MHz, Ant. 1+2 (CDD)	1Stream 2TX	2462	14.81	41	MCS0
802.11n 40MHz, Ant. 1+2 (CDD)	1Stream 2TX	2422	13.33	36	MCS0
802.11n 40MHz, Ant. 1+2 (CDD)	1Stream 2TX	2437	16.15	49	MCS0
802.11n 40MHz, Ant. 1+2 (CDD)	1Stream 2TX	2452	11.92	30	MCS0

3.14 On Time and Duty Cycle

Mode	On Time (ms)	Period (ms)	Duty Cycle (%)	Duty Cycle Correction Factor (dB)	1/T Minimum VBW (kHz)
802.11b 1Tx Chain1	12.468	12.593	99	-	-
802.11g 1Tx Chain1	1.909	1.91	99.9	-	-
802.11n (20MHz) 2Tx CDD	1.905	1.938	98.3	-	-
802.11n (40MHz) 2Tx CDD	0.931	0.961	96.9	0.14	3

Note: Power measurement using sweep trigger and gating of the power meter, duty factor is not required.

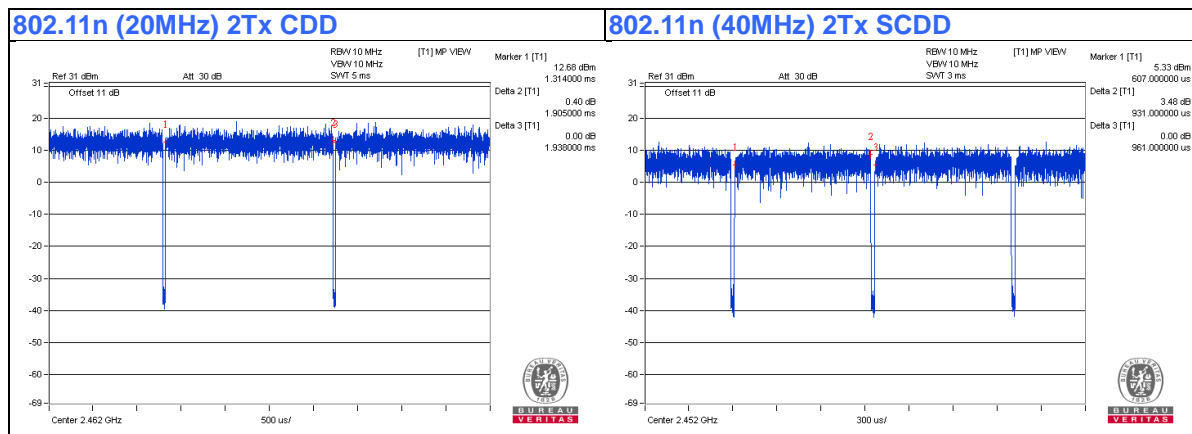
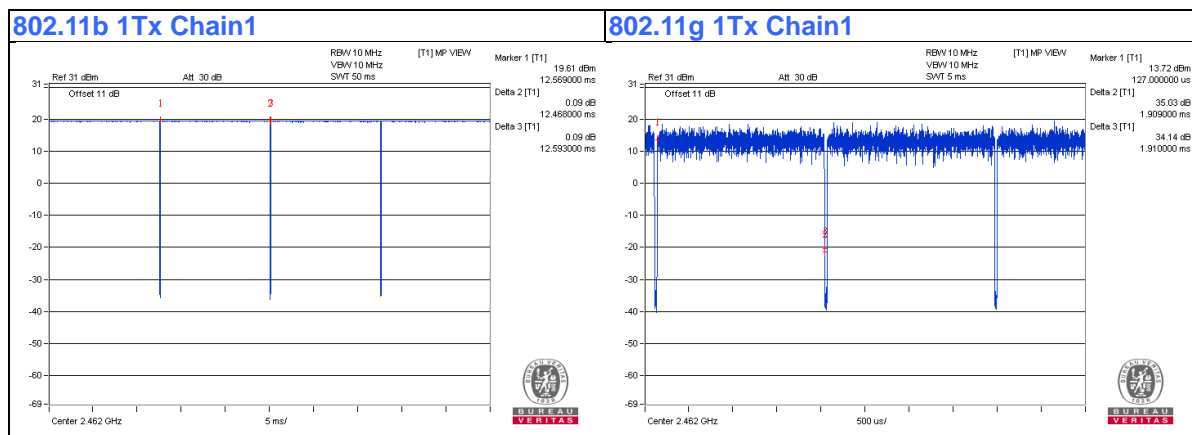

3.15 Testing Location Information

Test Site Location					
Address	(1) E-2, No.1, Li Hsin 1st Road, Hsinchu Science Park, Hsinchu City 300, Taiwan R.O.C.				
TEL	886-3-6668565				
FAX	886-3-6668323				
Test Site No.	Site Category	Location	FCC Reg. No.	IC Reg. No.	VCCI Reg. No
Conduction 1	Conduction	Hsinchu	-	-	-
Chamber 4	966 Chamber	Hsinchu	292998	20331-2	-
Oven 2	Oven	Hsinchu	-	-	-

3.16 EUT Diagram and Support Equipment

The EUT has been tested as an independent unit together with other necessary accessories or support units. The following support units or accessories were used to form a representative test configuration during the tests.

ID	Product	Brand	Model No.	Serial No.	FCC ID	Remarks
A.	Telephone	WONDER	WD-303	7C17KA04011	N/A	Provided by Lab
B.	Laptop	DELL	E5430	HYV4VY1	FCC DoC	Provided by Lab
C.	Co-Router	ZYXEL	IES-1000	S08024701597	FCC DoC	Provided by Lab
D.	iPod	Apple	MC749TA/A	CC4DN25WDFDM	N/A	Provided by Lab

Note:

1. All power cords of the above support units are non-shielded (1.8m).

ID	Descriptions	Qty.	Length (m)	Shielding (Yes/No)	Cores (Qty.)	Internal/external connection	Remarks
1.	DC Cable	1	1.5	No	0	Supplied by client	DC Cable
2.	RJ-11 Cable	1	10	No	0	Provided by Lab	RJ-11 Cable
3.	RJ-45 Cable	1	10	No	0	Provided by Lab	RJ-45 Cable
4.	RJ-11 Cable	1	10	No	0	Provided by Lab	RJ-11 Cable
5.	USB Cable	1	0.1	Yes	0	Provided by Lab	USB Cable

EUT Diagram

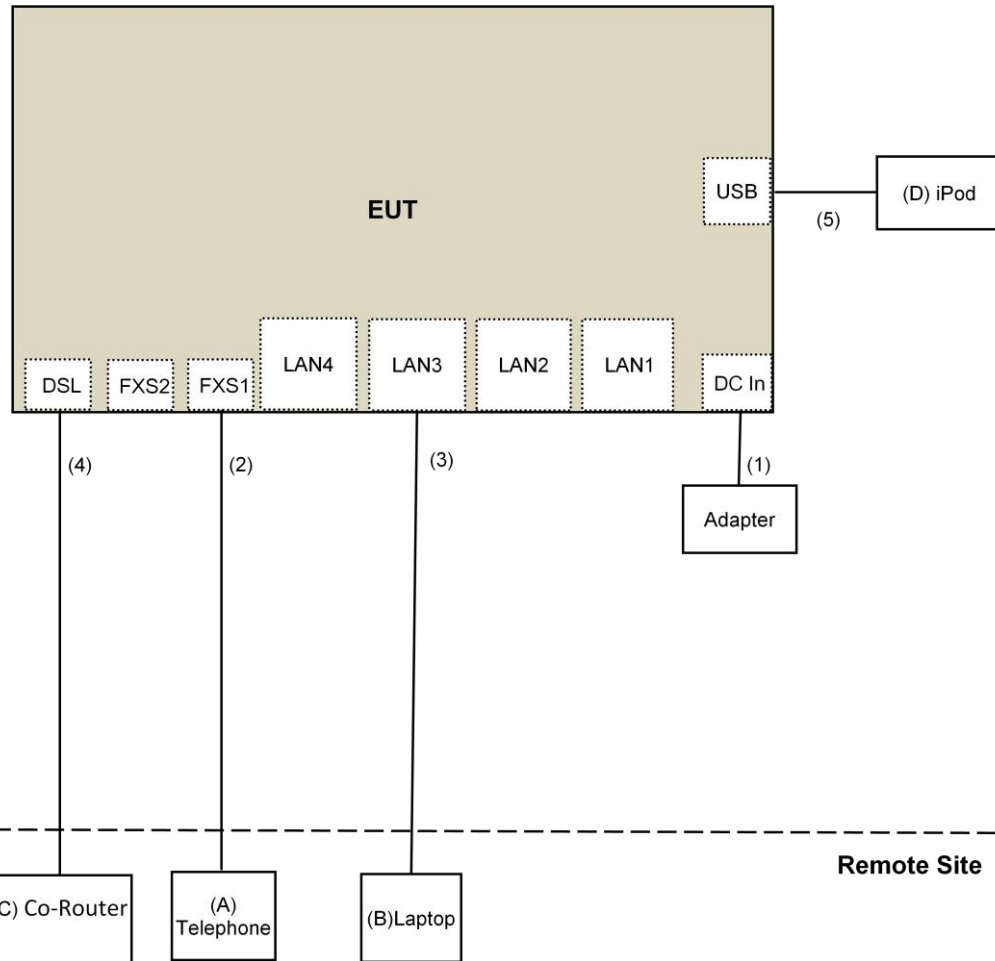

4 Test Types and Results

4.1 AC Power Conducted Emissions Measurement

4.1.1 Limit

For this product which is designed to be connected to the AC power line, the radio frequency voltage that is conducted back onto the AC power line on any frequency or frequencies within the band 150 kHz to 30 MHz shall not exceed below limits table.

Frequency (MHz)	Conducted Limit (dBuV)	
	Quasi-peak	Average
0.15 - 0.5	66 - 56	56 - 46
0.50 - 5.0	56	46
5.0 - 30.0	60	50

4.1.2 Measuring Instruments and Setting

Please refer to section 5 of equipments list in this report. The following table is the setting of the receiver

Receiver Parameters	Setting
Attenuation	10 dB
Start Frequency	0.15 MHz
Stop Frequency	30 MHz
IF Bandwidth	9 kHz

4.1.3 Test Procedures

1. Configure the EUT according to ANSI C63.10. The EUT or host of EUT has to be placed 0.4 meter far from the conducting wall of the shielding room and at least 80 centimeters from any other grounded conducting surface.
2. Connect EUT or host of EUT to the power mains through a line impedance stabilization network (LISN).
3. All the support units are connected to the other LISNs. The LISN should provide 50uH/50ohms coupling impedance.
4. The frequency range from 150 kHz to 30 MHz was searched.
5. Set the test-receiver system to Peak Detect Function and Specified Bandwidth with Maximum Hold Mode.
6. The measurement has to be done between each power line and ground at the power terminal.

4.1.4 Test Setup Layout

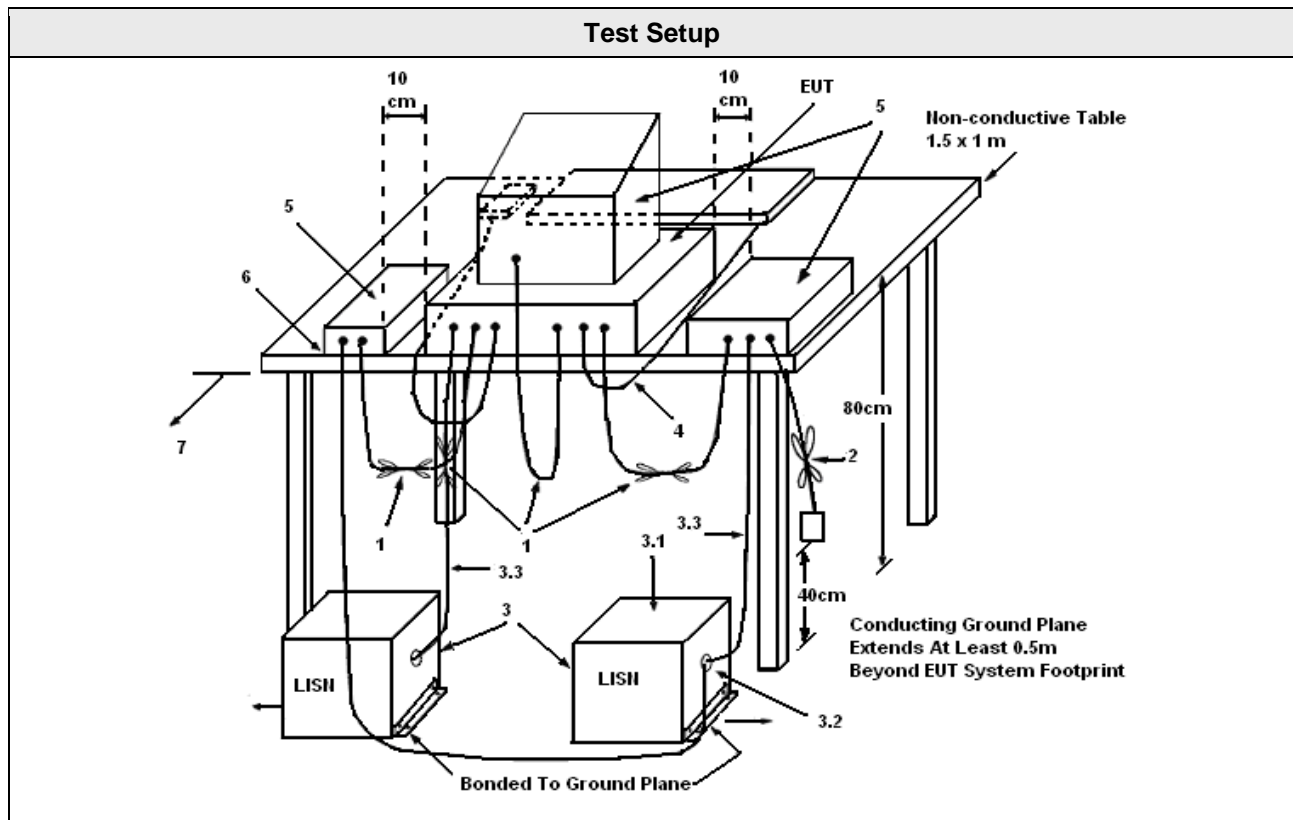

1. Interconnecting cables that hang closer than 40 cm to the ground plane shall be folded back and forth in the center forming a bundle 30 to 40 cm long.
2. I/O cables that are not connected to a peripheral shall be bundled in the center. The end of the cable may be terminated, if required, using the correct terminating impedance. The overall length shall not exceed 1 m.
3. EUT connected to one LISN. Unused LISN measuring port connectors shall be terminated in 50 Ω . LISN can be placed on top of, or immediately beneath, reference ground plane.
 - 3.1 All other equipment powered from additional LISN(s).
 - 3.2 Multiple outlet strip can be used for multiple power cords of non-EUT equipment.
 - 3.3 LISN at least 80 cm from nearest part of EUT chassis.
4. Cables of hand-operated devices, such as keyboards, mice, etc., shall be placed as for normal use.
5. Non-EUT components of EUT system being tested.
6. Rear of EUT, including peripherals, shall all be aligned and flush with rear of tabletop. Rear of tabletop shall be 40 cm removed from a vertical conducting plane that is bonded to the ground plane.

4.1.5 Test Deviation

There are no deviations with the original standard.

4.1.6 EUT Operating during Test

The EUT was placed on the test table and programmed in normal function.

4.1.7 Test Results of AC Power Conducted Emissions

Frequency Range	150kHz ~ 30MHz	Detector Function & Resolution Bandwidth	Quasi-Peak (QP) / Average (AV), 9kHz
Input Power	120Vac, 60Hz	Environmental Conditions	25°C, 75%RH
Tested by	Andy Ho		

Phase Of Power : Line (L)										
No	Frequency (MHz)	Correction Factor (dB)	Reading Value (dBuV)		Emission Level (dBuV)		Limit (dBuV)		Margin (dB)	
			Q.P.	AV.	Q.P.	AV.	Q.P.	AV.	Q.P.	AV.
1	0.15000	10.20	52.43	25.41	62.63	35.61	66.00	56.00	-3.37	-20.39
2	0.18516	10.20	44.73	29.29	54.93	39.49	64.25	54.25	-9.32	-14.76
3	0.34141	10.23	36.13	27.42	46.36	37.65	59.17	49.17	-12.81	-11.52
4	6.84375	10.51	31.13	24.96	41.64	35.47	60.00	50.00	-18.36	-14.53
5	12.66016	11.03	24.28	18.80	35.31	29.83	60.00	50.00	-24.69	-20.17
6	20.19922	11.70	23.07	17.74	34.77	29.44	60.00	50.00	-25.23	-20.56

Remarks:

1. Q.P. and AV. are abbreviations of quasi-peak and average individually.
2. The emission levels of other frequencies were very low against the limit.
3. Margin value = Emission level – Limit value
4. Correction factor = Insertion loss + Cable loss
5. Emission Level = Correction Factor + Reading Value

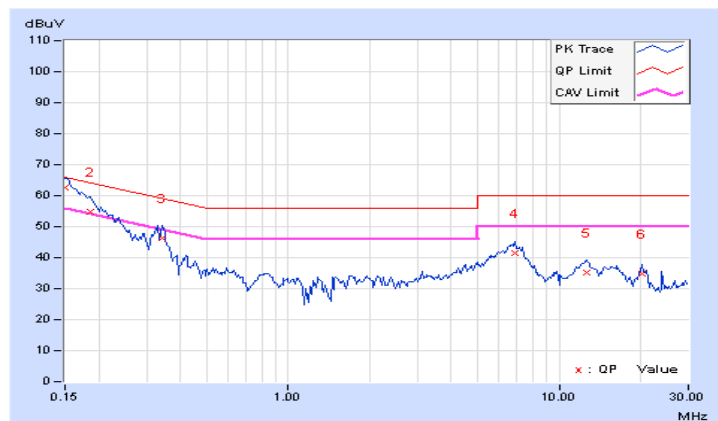

Frequency Range	150kHz ~ 30MHz	Detector Function & Resolution Bandwidth	Quasi-Peak (QP) / Average (AV), 9kHz
Input Power	120Vac, 60Hz	Environmental Conditions	25°C, 75%RH
Tested by	Andy Ho		

Phase Of Power : Neutral (N)										
No	Frequency (MHz)	Correction Factor (dB)	Reading Value (dBUV)		Emission Level (dBUV)		Limit (dBUV)		Margin (dB)	
			Q.P.	AV.	Q.P.	AV.	Q.P.	AV.	Q.P.	AV.
1	0.15000	10.19	51.93	30.35	62.12	40.54	66.00	56.00	-3.88	-15.46
2	0.18741	10.18	45.99	33.28	56.17	43.46	64.15	54.15	-7.98	-10.69
3	0.34122	10.22	35.18	27.12	45.40	37.34	59.17	49.17	-13.77	-11.83
4	3.72656	10.23	23.02	15.87	33.25	26.10	56.00	46.00	-22.75	-19.90
5	6.91797	10.42	30.99	26.52	41.41	36.94	60.00	50.00	-18.59	-13.06
6	24.00391	11.39	20.06	18.03	31.45	29.42	60.00	50.00	-28.55	-20.58

Remarks:

1. Q.P. and AV. are abbreviations of quasi-peak and average individually.
2. The emission levels of other frequencies were very low against the limit.
3. Margin value = Emission level – Limit value
4. Correction factor = Insertion loss + Cable loss
5. Emission Level = Correction Factor + Reading Value

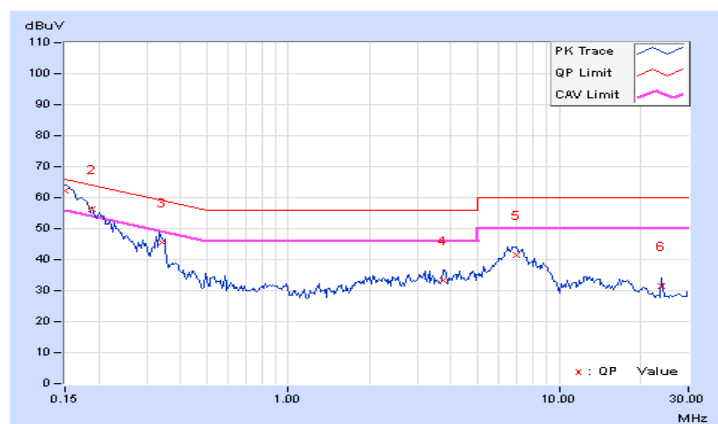

4.2 Maximum Conducted Output Power Measurement

4.2.1 Limit

For systems using digital modulation in the 2400–2483.5 MHz bands: 1 Watt (30dBm). The limit has to be reduced by the amount in dB that the gain of the antenna exceeds 6dBi. For point-to-point operation, the limit has to be reduced by 1dB for every 3dB that the directional gain of the antenna exceeds 6dBi.

4.2.2 Measuring Instruments and Setting

Please refer to section 4.8 of equipments list in this report. The following table is the setting of the power meter.

Power Meter Parameter	Setting
Power Measurement	Average(RMS), Peak
Rise Time	<8 ns typical 12ns maximum
Sensor Model	MA2411B

4.2.3 Test Procedures

- 1 Test was performed in accordance with Measurement of Digital Transmission Systems Operating under KDB558074 D01 DTS Meas Guidance v04, in section "Maximum conducted output power Method AVGPM-G", 04/05/2017
- 2 The average power sensor was used on the output port of the EUT. A power meter was used to read the response of the average power sensor and enable the trigger function to get the all on time transmission . Record the average power level.
- 3 When measuring maximum conducted output power with multiple antenna systems, add every result of the values by mathematic formula.

4.2.4 Test Setup Layout

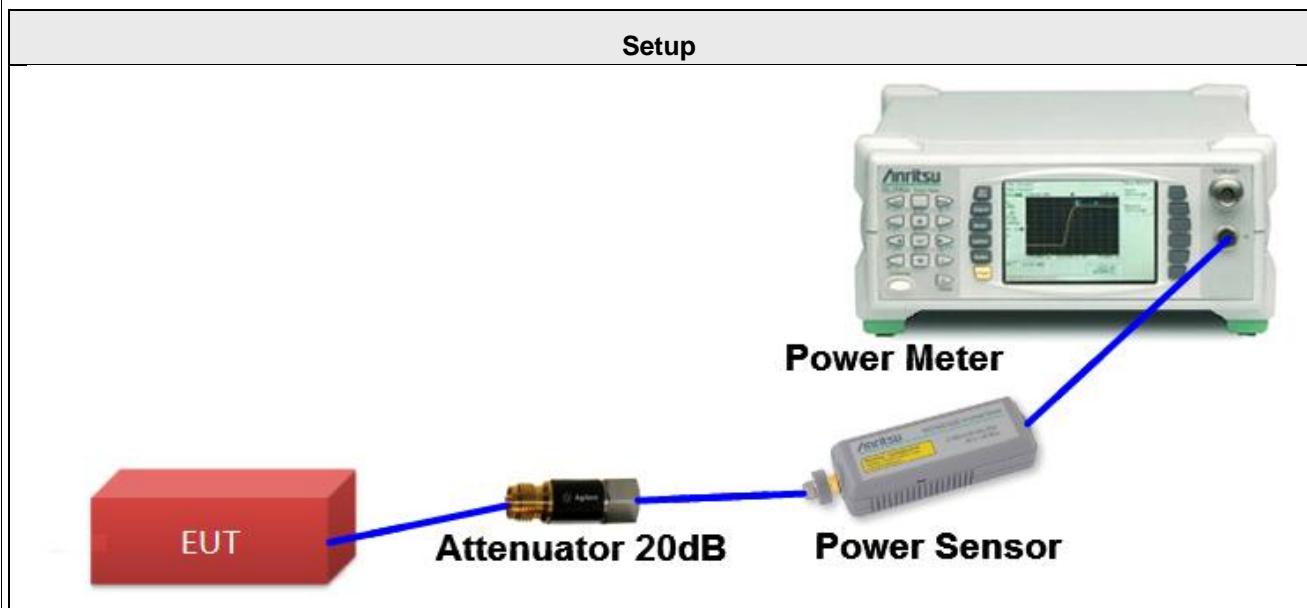

4.2.5 Test Deviation

There are no deviations with the original standard.

4.2.6 EUT Operating Conditions

The EUT was programmed to be in continuously transmitting mode.

4.2.7 Test Results of Maximum Conducted Output Power

Temperature	25°C	Humidity	60%
Test Engineer	Anderson Chen		

FOR AVERAGE POWER

802.11b 1Tx Chain1

Channel	Frequency (MHz)	Conducted Power (dBm)	Directional Gain (dBi)	Max. Limit (dBm)	Result
1	2412	16.92	3.02	30	PASS
6	2437	16.93	3.06	30	PASS
11	2462	16.71	3.15	30	PASS

802.11g 1Tx Chain1

Channel	Frequency (MHz)	Conducted Power (dBm)	Directional Gain (dBi)	Max. Limit (dBm)	Result
1	2412	13.24	3.02	30	PASS
6	2437	18.31	3.06	30	PASS
11	2462	12.61	3.15	30	PASS

802.11n (20MHz) 2Tx CDD

Channel	Frequency (MHz)	Conducted Power (dBm)			Directional Gain (dBi)	Max. Limit (dBm)	Result
		Chain 1	Chain 2	Total			
1	2412	12.55	12.52	15.55	3.22	30	PASS
6	2437	17.70	17.97	20.85	3.53	30	PASS
11	2462	11.82	11.78	14.81	3.74	30	PASS

Note:

1. Total Conducted Power = Conducted Power [TX 1(unit in W) + TX 2(unit in W)](unit in dBm)
2. Directional Gain <6dBi, so the limit doesn't reduce.

802.11n (40MHz) 2Tx CDD

Channel	Frequency (MHz)	Conducted Power (dBm)			Directional Gain (dBi)	Max. Limit (dBm)	Result
		Chain 1	Chain 2	Total			
3	2422	10.21	10.43	13.33	3.38	30	PASS
6	2437	12.94	13.33	16.15	3.53	30	PASS
9	2452	9.02	8.79	11.92	3.61	30	PASS

Note:

1. Total Conducted Power = Conducted Power [TX 1(unit in W) + TX 2(unit in W)](unit in dBm)
2. Directional Gain <6dBi, so the limit doesn't reduce.

4.3 Power Spectral Density Measurement

4.3.1 Limit

For digitally modulated systems, the conductive measured power spectral density(PSD) shall not be greater than 8 dBm in any 3 kHz bandwidth during any time interval of continuous transmission.

4.3.2 Measuring Instruments and Setting

Please refer to section 5 of equipments list in this report. The following table is the setting of the spectrum analyzer.

Spectrum Parameter	Setting
Attenuation	Auto
Span Frequency	Set the span to 1.5 times the DTS channel bandwidth.
RBW	Set the RBW \geq 3 kHz
VBW	Set the VBW \geq 3 x RBW
Detector	RMS
Trace	Average sweep count 100
Sweep Time	Auto couple

4.3.3 Test Procedures

- 1 The transmitter output (antenna port) was connected to the spectrum analyzer.
- 2 Test was performed in accordance with Measurement of Digital Transmission Systems Operating under KDB558074 D01 DTS Meas Guidance v04, in section "Maximum power spectral density level in the fundamental emissions Method AVGPSD-1", 04/05/2017.
- 3 Multiple antenna systems was performed in accordance KDB 662911 D01 v02r01 in-Band Power Spectral Density (PSD) Measurements (a) Measure and sum the spectra across the outputs (bin-by-bin summing).
- 4 This procedure may be used when the maximum (average) conducted output power was used to demonstrate compliance to the output power limit. The EUT must be configured to transmit continuously (duty cycle \geq 98%) to ensure that measurements are made only when the EUT is transmitting at its maximum power control level (no transmitter off time is to be considered).
- 5 Ensure that the number of measurement points in the sweep \geq 2 x span/RBW (use of a greater number of measurement points than this minimum requirement is recommended).
- 6 When measuring first spectral bin of output 1 is summed with that in the first spectral bin of output 2 and so on up to the Nth output to obtain the value for the first frequency bin of the summed spectrum. The summed spectrum value for each of the other frequency bins is computed in the same way.

4.3.4 Test Setup Layout

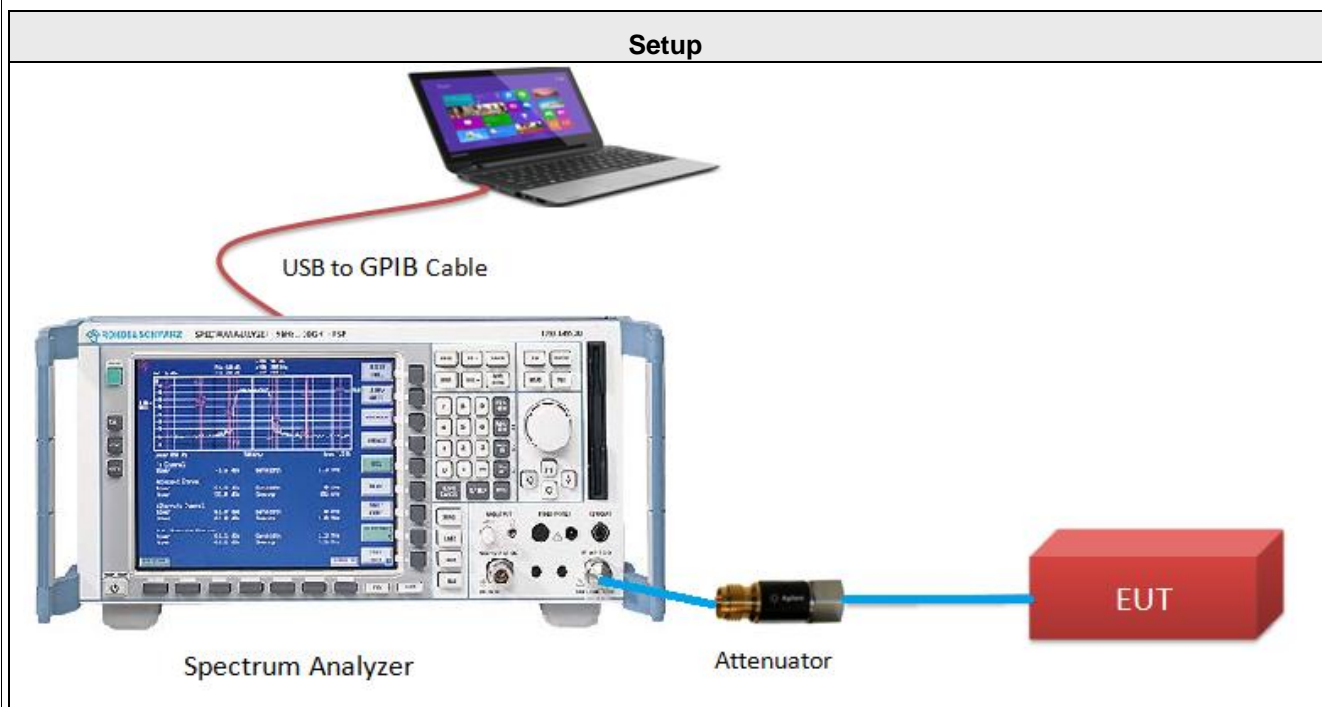

4.3.5 Test Deviation

There are no deviations with the original standard.

4.3.6 EUT Operating Conditions

The EUT was programmed to be in continuously transmitting mode.

4.3.7 Test Results of Power Spectral Density

Temperature	20°C	Humidity	62%
Test Engineer	Anderson Chen		

802.11b 1Tx Chain1

Channel	Frequency (MHz)	Power Density (dBm/3kHz)	Directional Gain (dBi)	Limit (dBm/3kHz)	Result
1	2412	-9.96	3.02	8	PASS
6	2437	-12.03	3.06	8	PASS
11	2462	-10.90	3.15	8	PASS

Note.1. Directional Gain <6dBi, so the limit doesn't reduce.

802.11g 1Tx Chain1

Channel	Frequency (MHz)	Power Density (dBm/3kHz)	Directional Gain (dBi)	Limit (dBm/3kHz)	Result
1	2412	-17.98	3.02	8	PASS
6	2437	-14.29	3.06	8	PASS
11	2462	-18.69	3.15	8	PASS

Note.1. Directional Gain <6dBi, so the limit doesn't reduce.

802.11n (20MHz) 2Tx CDD

Channel	Frequency (MHz)	PSD w/o Duty Factor (dBm/3kHz)			Directional Gain (dBi)	PSD With Duty Factor (dBm/3kHz)	Limit (dBm/3kHz)	Result
		Chain1	Chain2	Total				
1	2412	-18.63	-22.40	-17.11	6.13	-17.11	7.87	PASS
6	2437	-19.51	-10.69	-10.15	6.31	-10.15	7.69	PASS
11	2462	-19.35	-20.99	-17.08	6.46	-17.08	7.84	PASS

Note.

1. Channel 1 Directional Gain > 6dBi, so the limit is $8 - (6.13 - 6) = 7.87$ dBm/3kHz.
2. Channel 6 Directional Gain > 6dBi, so the limit is $8 - (6.31 - 6) = 7.69$ dBm/3kHz.
3. Channel 11 Directional Gain > 6dBi, so the limit is $8 - (6.46 - 6) = 7.84$ dBm/3kHz.

802.11n (40MHz) 2Tx CDD

Channel	Frequency (MHz)	PSD w/o Duty Factor (dBm/3kHz)			Directional Gain (dBi)	Duty Factor (dB)	PSD With Duty Factor (dBm/3kHz)	Limit (dBm/3kHz)	Result
		Chain1	Chain2	Total					
3	2422	-22.95	-28.78	-21.94	6.21	0.14	-21.80	7.79	PASS
6	2437	-27.12	-18.80	-18.20	6.31	0.14	-18.06	7.69	PASS
9	2452	-26.40	-25.93	-23.15	6.35	0.14	-23.01	7.65	PASS

Note.

1. Channel 3 Directional Gain > 6dBi, so the limit is $8 - (6.21 - 6) = 7.79$ dBm/3kHz.
2. Channel 6 Directional Gain > 6dBi, so the limit is $8 - (6.31 - 6) = 7.69$ dBm/3kHz.
3. Channel 9 Directional Gain > 6dBi, so the limit is $8 - (6.35 - 6) = 7.65$ dBm/3kHz.

SPECTRUM PLOT

802.11b 1Tx Chain1 2412 MHz

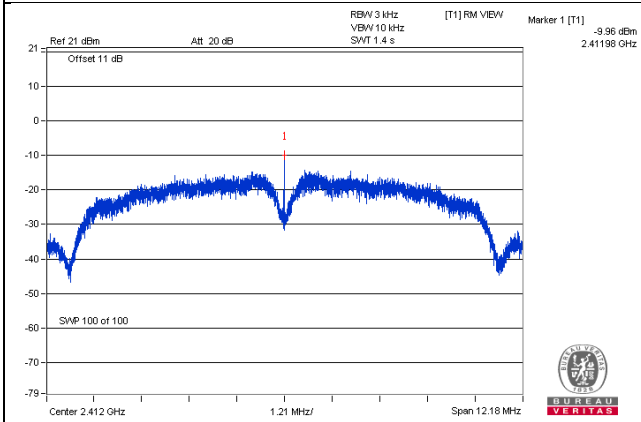

802.11b 1Tx Chain1 2437 MHz

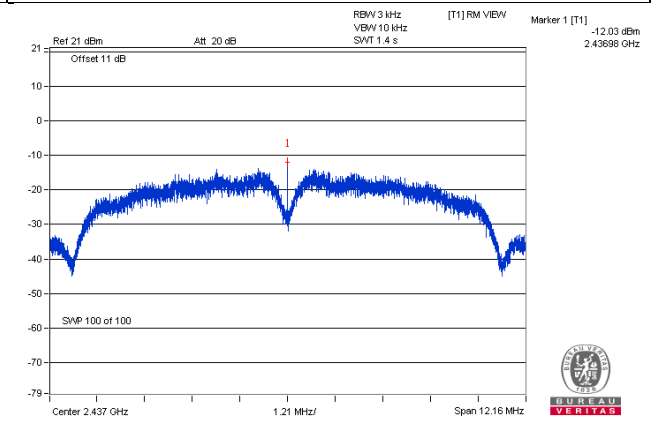

802.11b 1Tx Chain1 2462 MHz

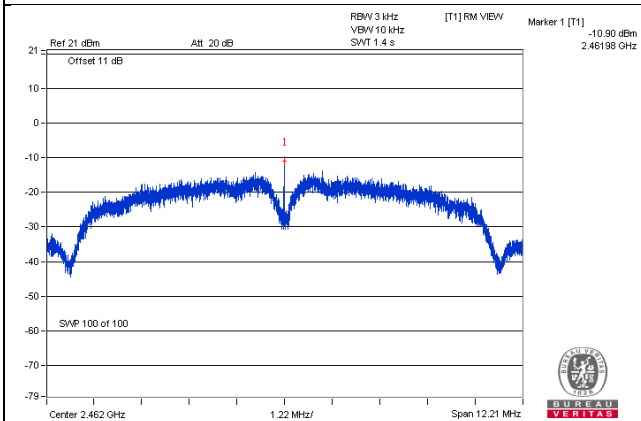

802.11g 1Tx Chain1 2412 MHz

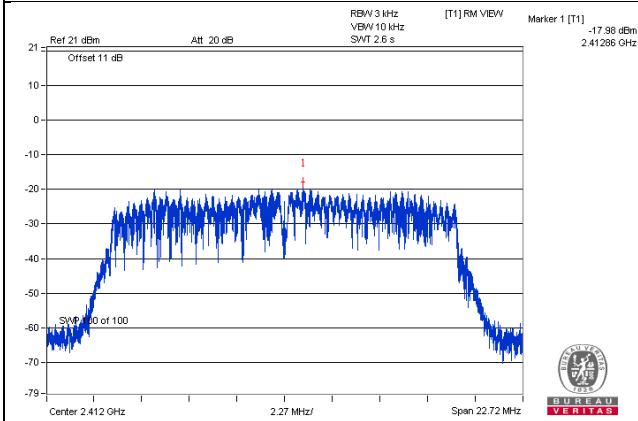

802.11g 1Tx Chain1 2437 MHz

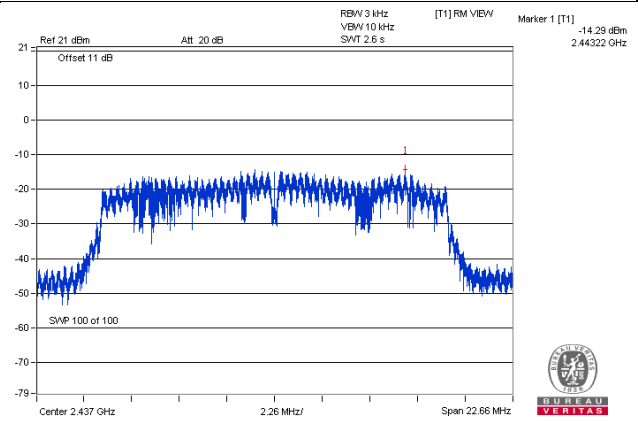

802.11g 1Tx Chain1 2462 MHz

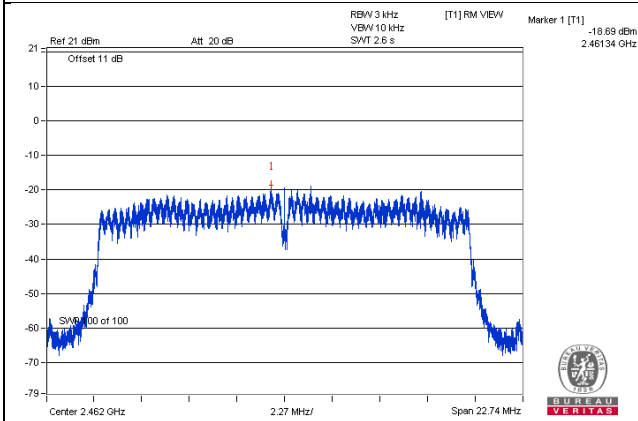

802.11n (20MHz) 2Tx CDD 2412 MHz

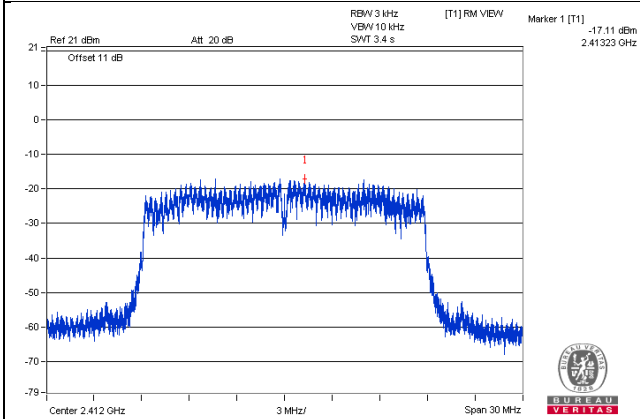

802.11n (20MHz) 2Tx CDD 2437 MHz

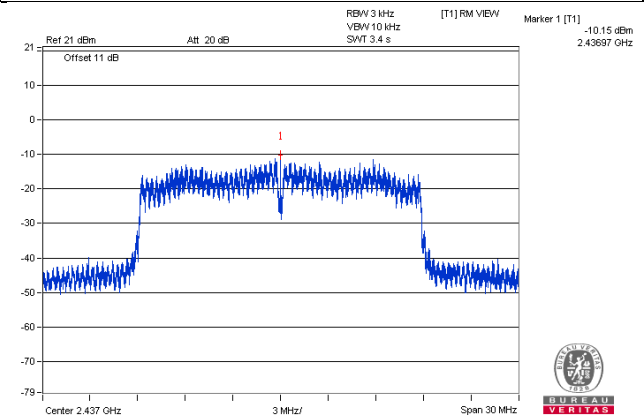

802.11n (20MHz) 2Tx CDD 2462 MHz

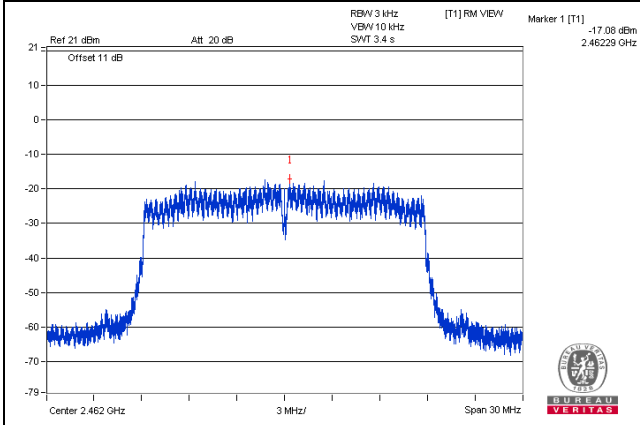

802.11n (40MHz) 2Tx CDD 2422 MHz

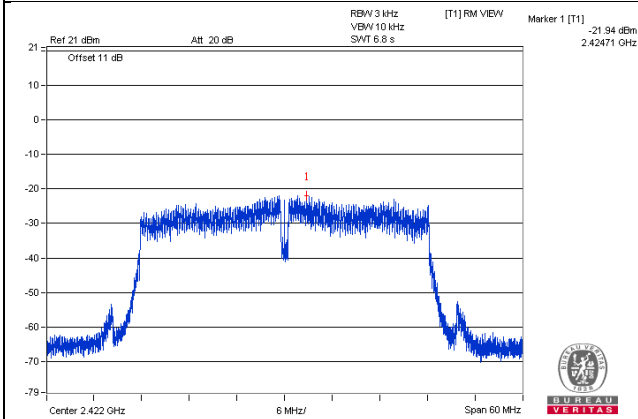

802.11n (40MHz) 2Tx CDD 2437 MHz

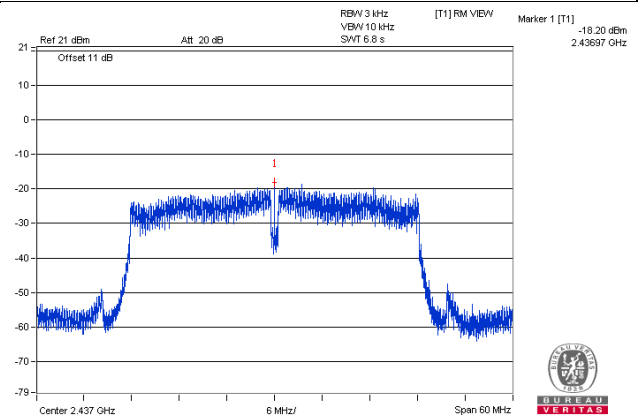

802.11n (40MHz) 2Tx CDD 2452 MHz

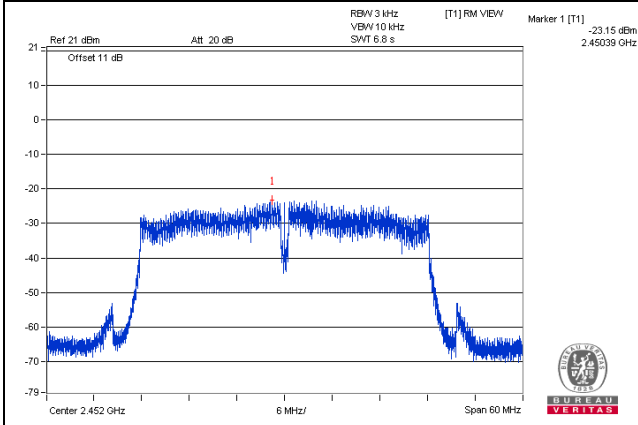

4.4 6dB Bandwidth Measurement

4.4.1 Limit

For digital modulation systems, the minimum 6dB bandwidth shall be at least 500 kHz

4.4.2 Measuring Instruments and Setting

The following table is the setting of the Spectrum Analyzer.

Spectrum Parameter	Setting
Attenuation	Auto
Span Frequency	> 6dB Bandwidth
RBW	100kHz
VBW	$\geq 3 \times \text{RBW}$
Detector	Peak
Trace	Max Hold
Sweep Time	Auto couple

4.4.3 Test Procedures

- 1 The transmitter output (antenna port) was connected to the spectrum analyzer in peak, Max hold mode.
- 2 For each RF output channel investigated, the spectrum analyzer center frequency was set to the channel carrier frequency. A peak reading was taken; two markers were set 6 dB below the maximum level on the right and the left side of the emissions.
- 3 The 6 dB bandwidth is the frequency difference between the two markers

4.4.4 Test Setup Layout

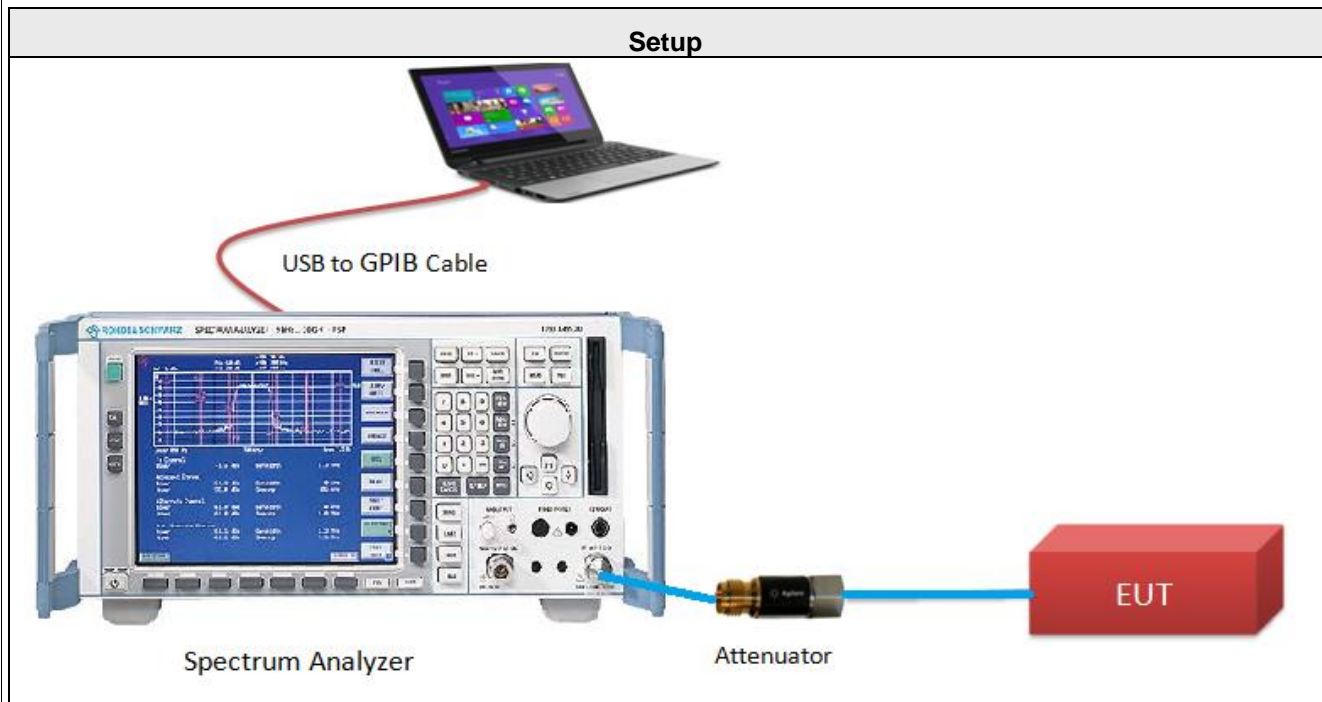

4.4.5 Test Deviation

There are no deviations with the original standard.

4.4.6 EUT Operating Conditions

The EUT was programmed to be in continuously transmitting mode.

4.4.7 Test Results of 6dB Bandwidth

Temperature	25°C	Humidity	60%
Test Engineer	Anderson Chen		

802.11b 1Tx Chain1

CHANNEL	FREQUENCY (MHz)	6dB BANDWIDTH (MHz)	MINIMUM LIMIT (MHz)	PASS / FAIL
1	2412	8.12	0.5	PASS
6	2437	8.11	0.5	PASS
11	2462	8.14	0.5	PASS

802.11g 1Tx Chain1

CHANNEL	FREQUENCY (MHz)	6dB BANDWIDTH (MHz)	MINIMUM LIMIT (MHz)	PASS / FAIL
1	2412	15.15	0.5	PASS
6	2437	15.11	0.5	PASS
11	2462	15.16	0.5	PASS

802.11n (20MHz) 2Tx CDD

CHANNEL	FREQUENCY (MHz)	6dB BANDWIDTH (MHz)		MINIMUM LIMIT (MHz)	PASS / FAIL
		CHAIN 1	CHAIN 2		
1	2412	15.17	15.18	0.5	PASS
6	2437	15.16	15.71	0.5	PASS
11	2462	15.17	16.31	0.5	PASS

802.11n (40MHz) 2Tx CDD

CHANNEL	FREQUENCY (MHz)	6dB BANDWIDTH (MHz)		MINIMUM LIMIT (MHz)	PASS / FAIL
		CHAIN 1	CHAIN 2		
3	2422	35.18	35.78	0.5	PASS
6	2437	35.31	36.42	0.5	PASS
9	2452	35.33	35.85	0.5	PASS

SPECTRUM PLOT

802.11b 1Tx Chain1 CH1

802.11b 1Tx Chain1 CH6

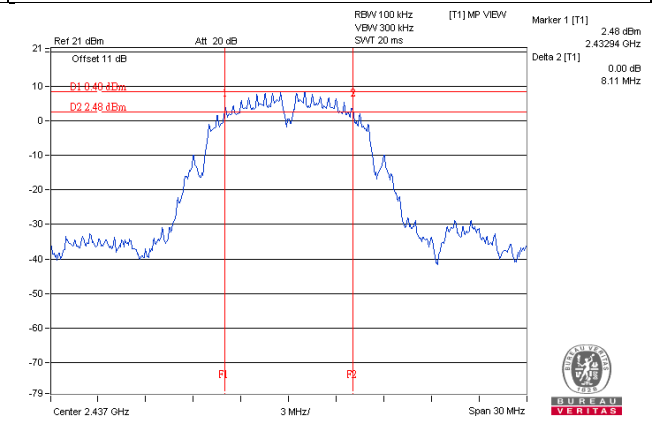
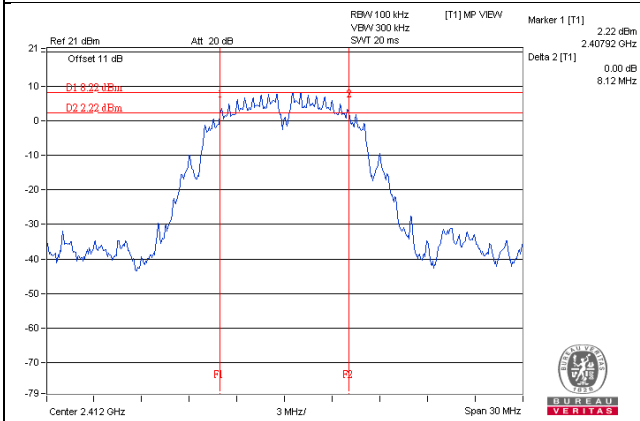

802.11b 1Tx Chain1 CH11

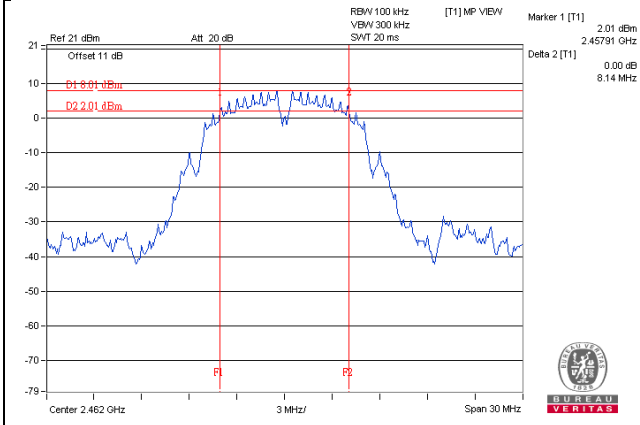

802.11g 1Tx Chain1 CH1

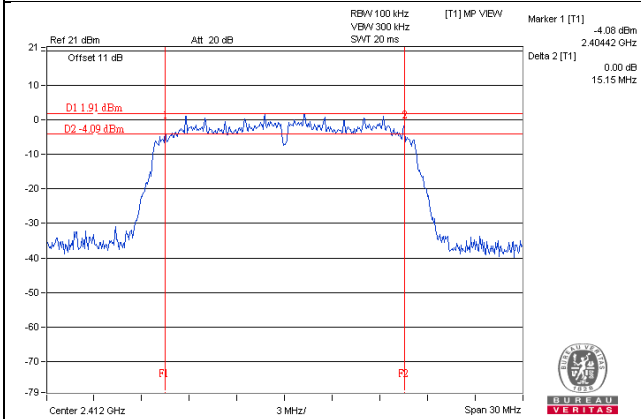

802.11g 1Tx Chain1 CH6

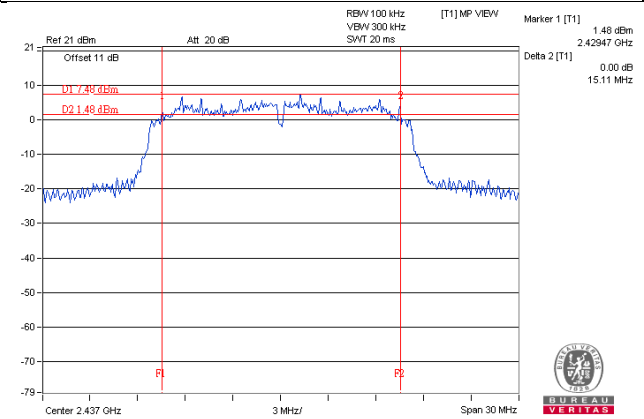

802.11g 1Tx Chain1 CH11

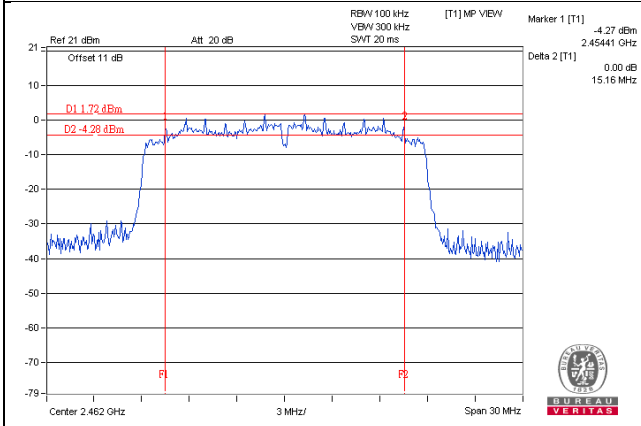

802.11n (20MHz) 2Tx CDD mode Chain1 CH1

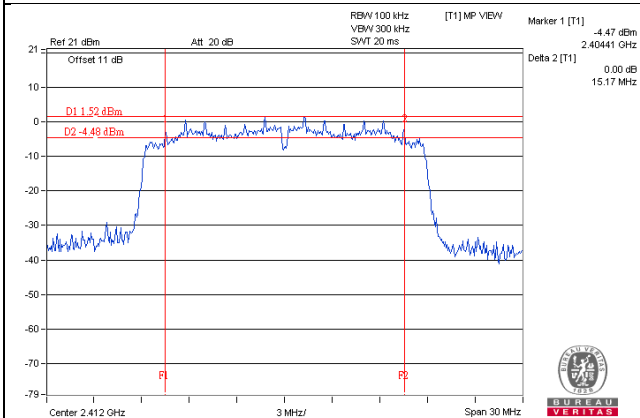

802.11n (20MHz) 2Tx CDD mode Chain2 CH1

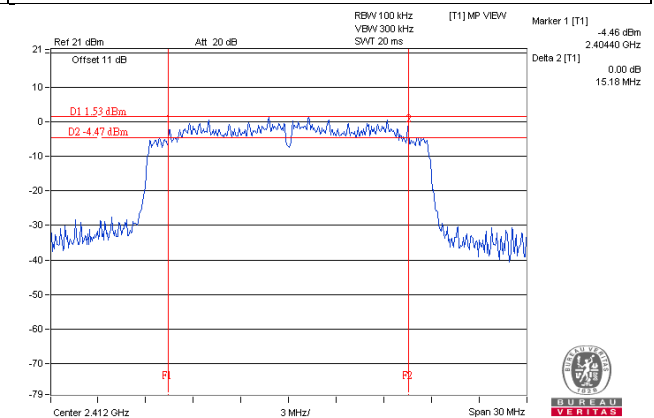

802.11n (20MHz) 2Tx CDD mode Chain1 CH6

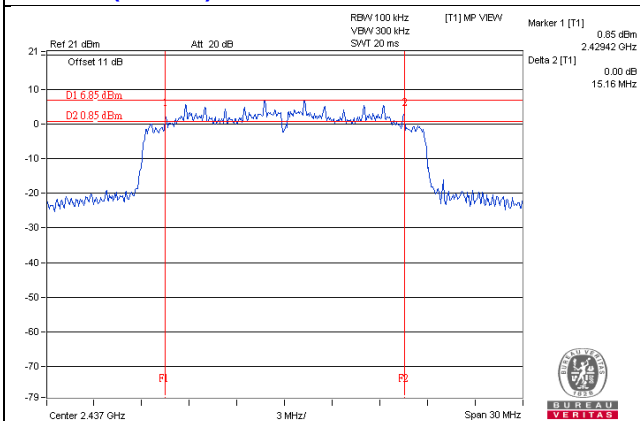

802.11n (20MHz) 2Tx CDD mode Chain2 CH6

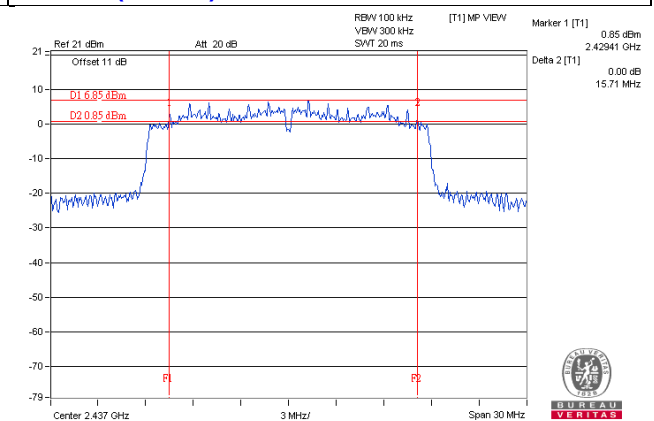

802.11n (20MHz) 2Tx CDD mode Chain1 CH11

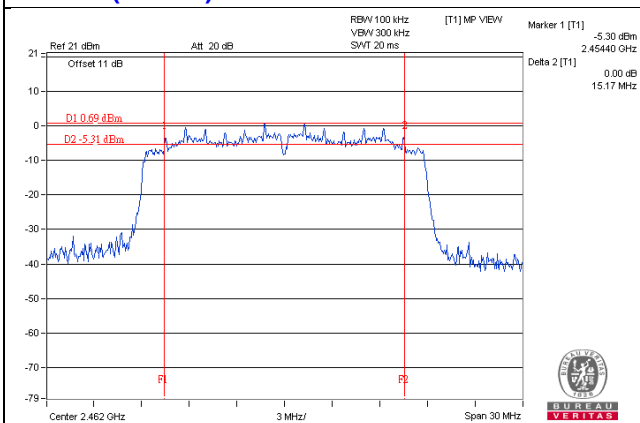

802.11n (20MHz) 2Tx CDD mode Chain2 CH11

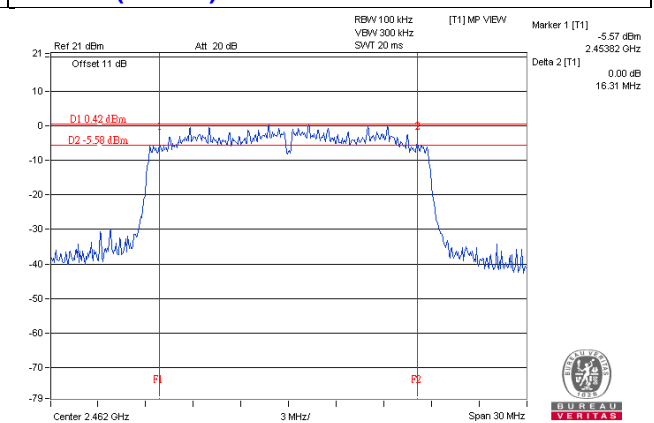

802.11n (40MHz) 2Tx CDD mode Chain1 CH3

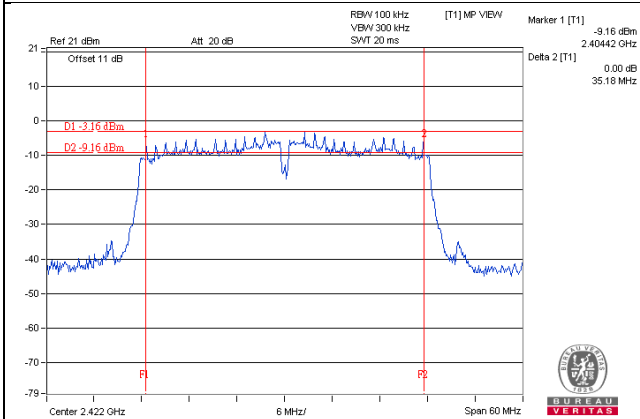

802.11n (40MHz) 2Tx CDD mode Chain2 CH3

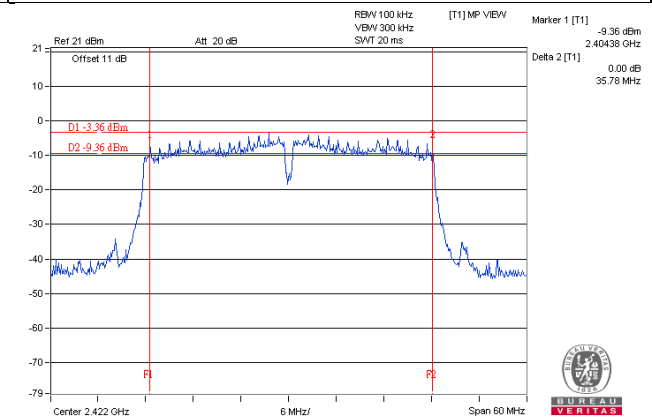

802.11n (40MHz) 2Tx CDD mode Chain1 CH6

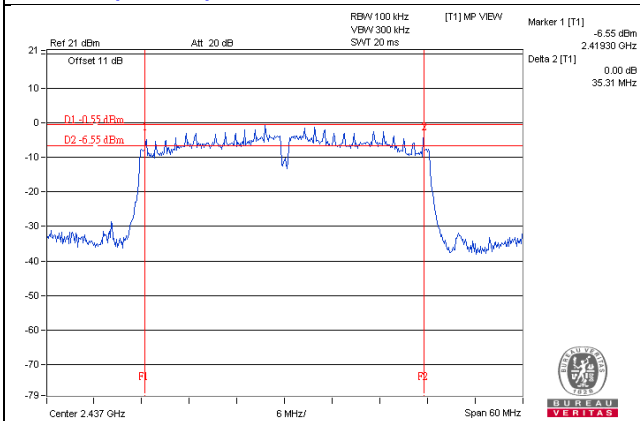

802.11n (40MHz) 2Tx CDD mode Chain2 CH6

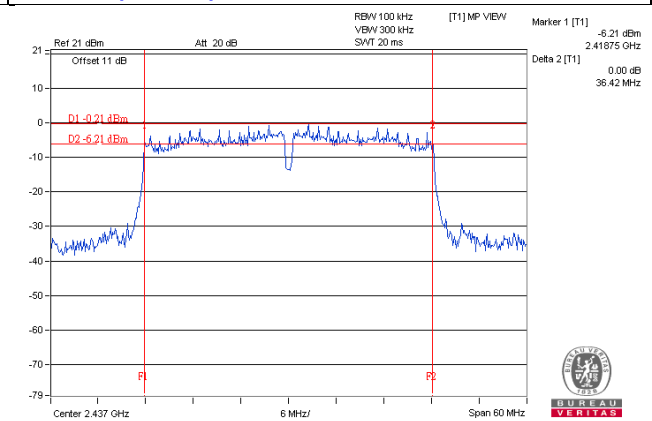

802.11n (40MHz) 2Tx CDD mode Chain1 CH9

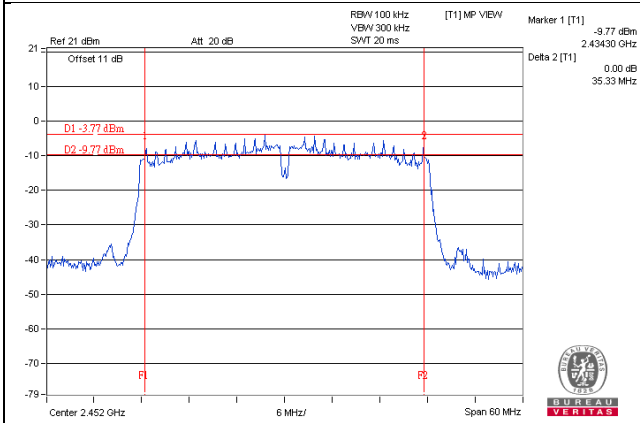

802.11n (40MHz) 2Tx CDD mode Chain2 CH9

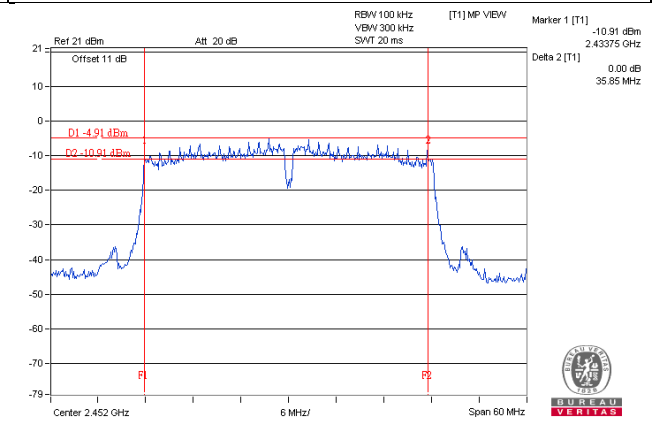

4.5 Occupied Bandwidth Measurement

4.5.1 Measuring Instruments and Setting

The following table is the setting of the Spectrum Analyzer.

Spectrum Parameter	Setting
Attenuation	Auto
RBW	1% to 5% of the anticipated emission bandwidth
VBW	$\geq 3 \times \text{RBW}$
Detector	Peak
Trace	Max Hold
Sweep Time	Auto couple

4.5.2 Test Procedure

- 1 The transmitter output (antenna port) was connected to the spectrum analyzer in peak, Max hold mode.
- 2 For each RF output channel investigated, the spectrum analyzer center frequency was set to the channel carrier frequency. The bandwidth of the fundamental frequency was measured by spectrum analyzer with resolution bandwidth in the range of 1% to 5% of the anticipated emission bandwidth, and a video bandwidth at least 3x the resolution bandwidth and set the detector to peak.
- 3 The width of a frequency band such that, below the lower and above the upper frequency limits, the mean powers emitted are each equal to a specified percentage 0.5 %of the total mean power of a given emission.

4.5.3 Test Setup Layout

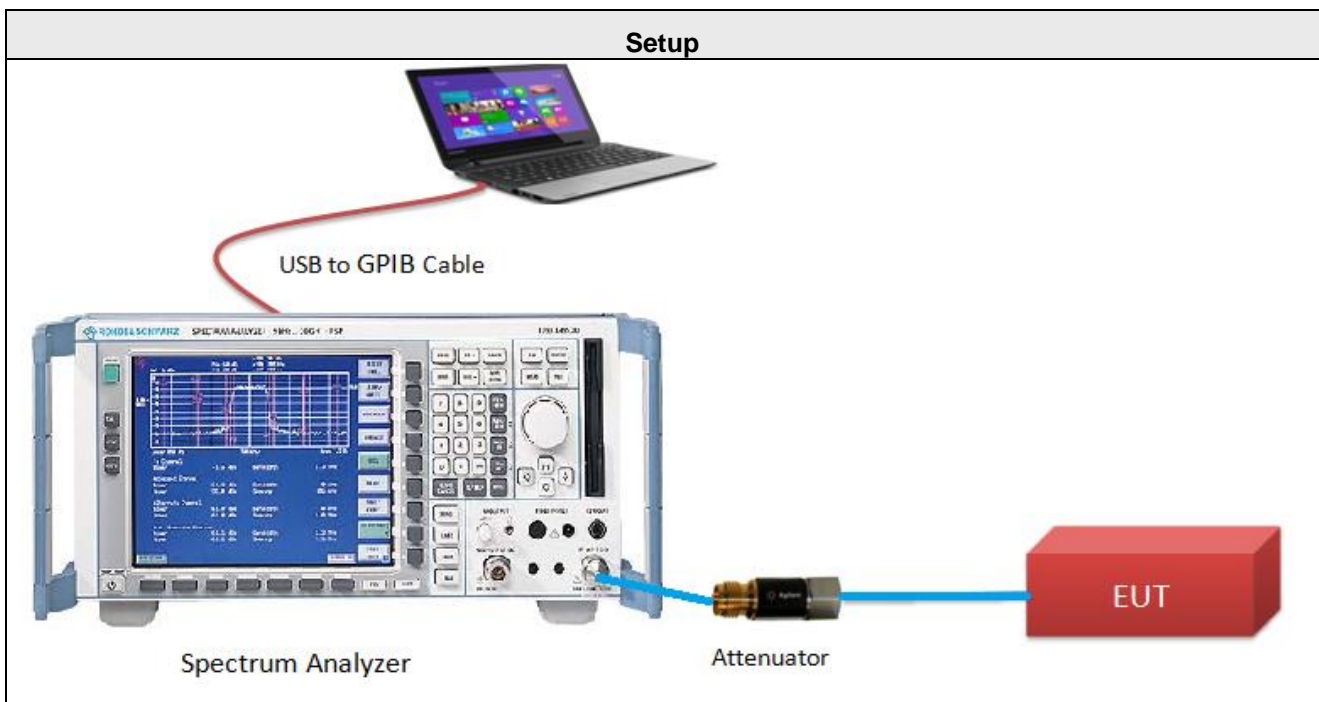

4.5.4 Test Deviation

There are no deviations with the original standard.

4.5.5 EUT Operating Conditions

The EUT was programmed to be in continuously transmitting mode.

4.5.6 Test Results of Occupied Bandwidth

Temperature	25°C	Humidity	60%
Test Engineer	Anderson Chen		

802.11b 1Tx Chain1

CHANNEL	FREQUENCY (MHz)	OCCUPIED BANDWIDTH (MHz)
1	2412	10.20
6	2437	10.20
11	2462	10.20

802.11g 1Tx Chain1

CHANNEL	FREQUENCY (MHz)	OCCUPIED BANDWIDTH (MHz)
1	2412	16.44
6	2437	16.92
11	2462	17.52

802.11n (20MHz) 2Tx CDD

CHANNEL	FREQUENCY (MHz)	OCCUPIED BANDWIDTH (MHz)	
		CHAIN 1	CHAIN 2
1	2412	17.52	17.40
6	2437	17.64	17.64
11	2462	17.52	17.52

802.11n (40MHz) 2Tx CDD

CHANNEL	FREQUENCY (MHz)	OCCUPIED BANDWIDTH (MHz)	
		CHAIN 1	CHAIN 2
3	2422	36.72	36.48
6	2437	36.72	36.48
9	2452	36.72	36.48

SPECTRUM PLOT

802.11b 1Tx Chain1 CH1

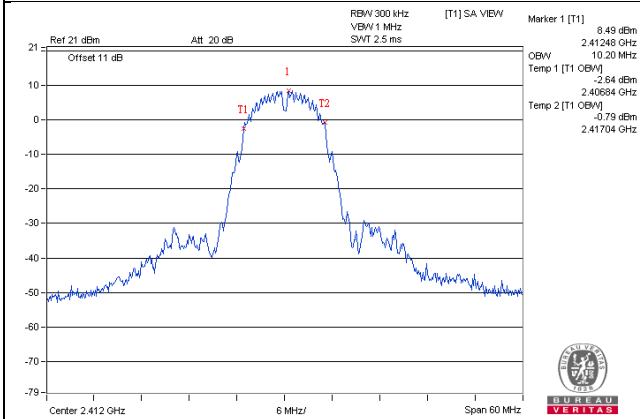

802.11b 1Tx Chain1 CH6

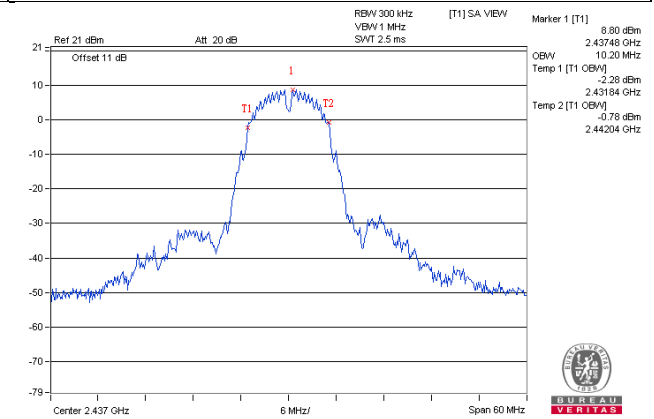

802.11b 1Tx Chain1 CH11

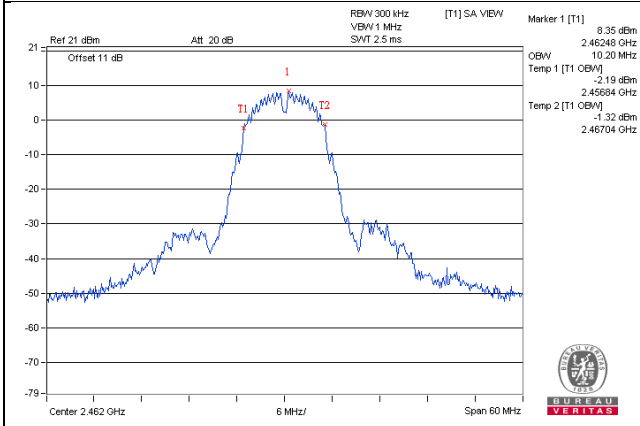

802.11g 1Tx Chain1 CH1

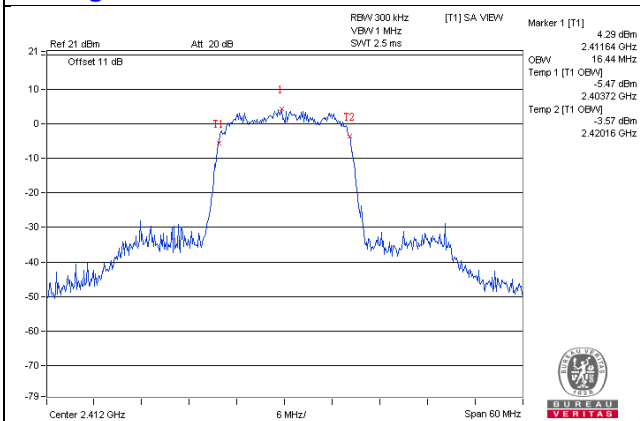

802.11g 1Tx Chain1 CH6

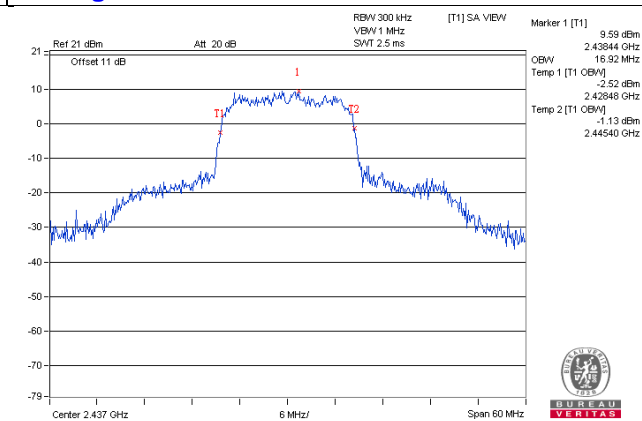

802.11g 1Tx Chain1 CH11

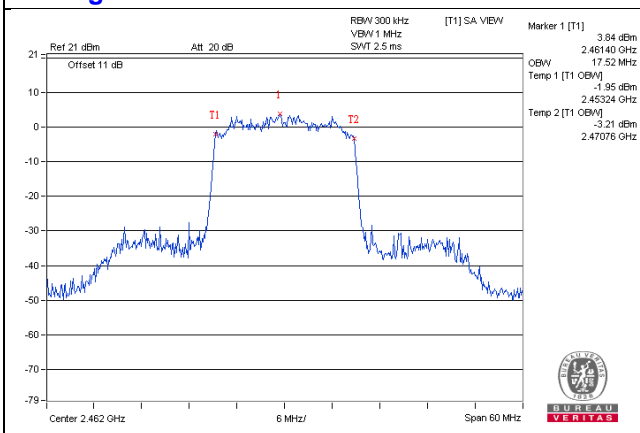

802.11n (20MHz) 2Tx CDD mode Chain1 CH1

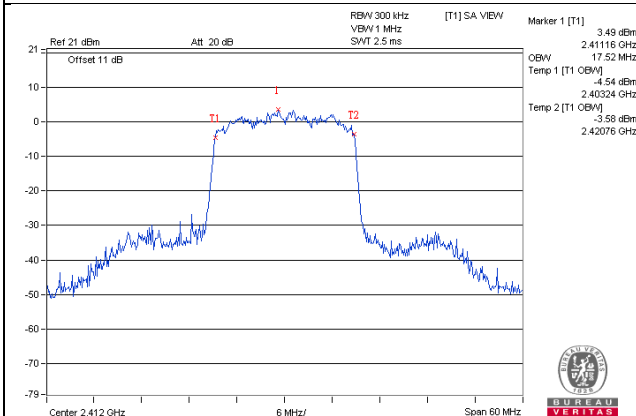

802.11n (20MHz) 2Tx CDD mode Chain2 CH1

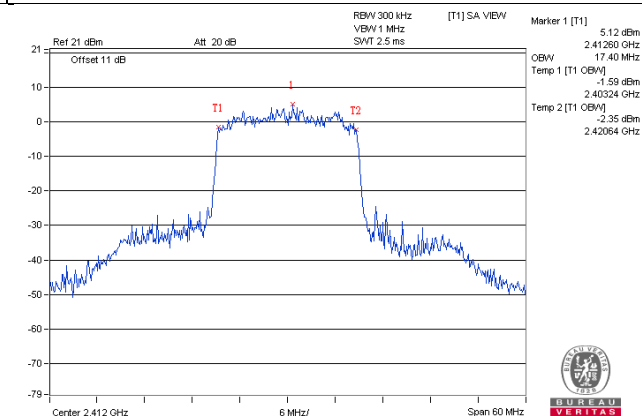

802.11n (20MHz) 2Tx CDD mode Chain1 CH6

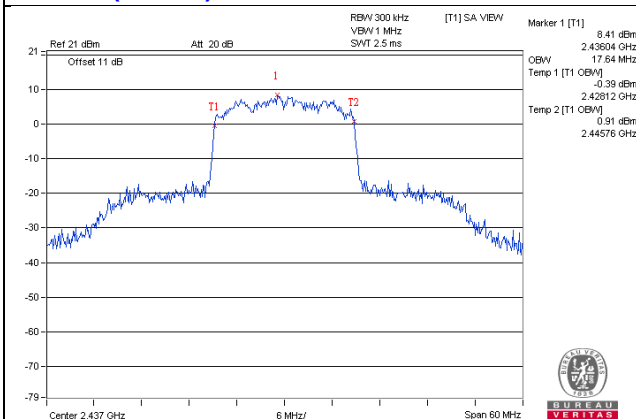

802.11n (20MHz) 2Tx CDD mode Chain2 CH6

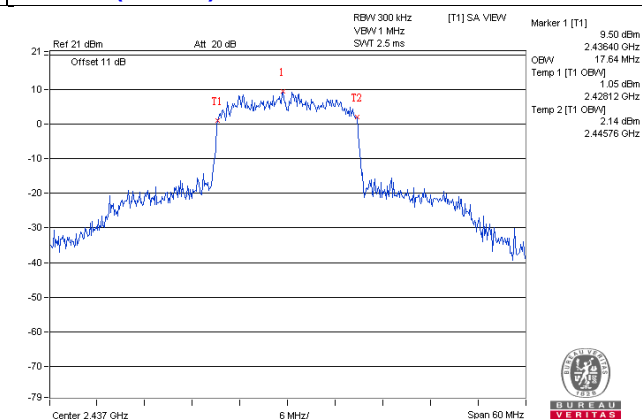

802.11n (20MHz) 2Tx CDD mode Chain1 CH11

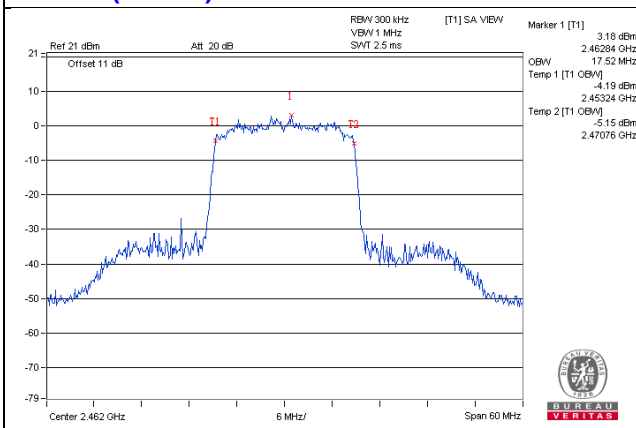

802.11n (20MHz) 2Tx CDD mode Chain2 CH11

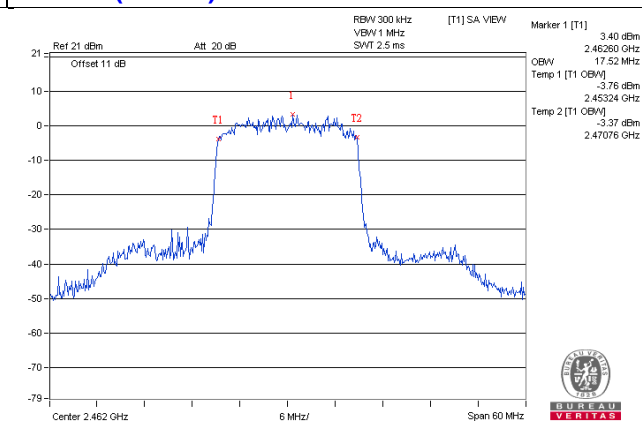

802.11n (40MHz) 2Tx CDD mode Chain1 CH3

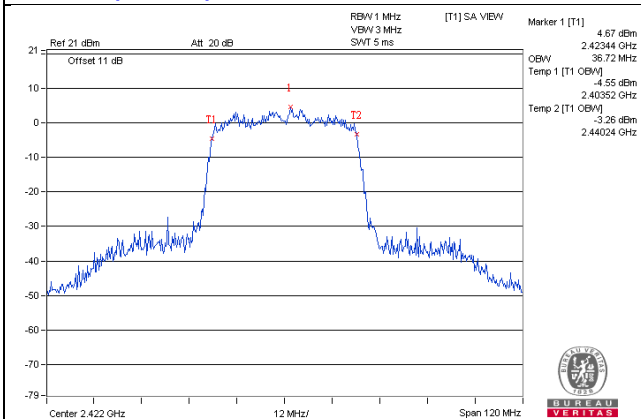

802.11n (40MHz) 2Tx CDD mode Chain2 CH3

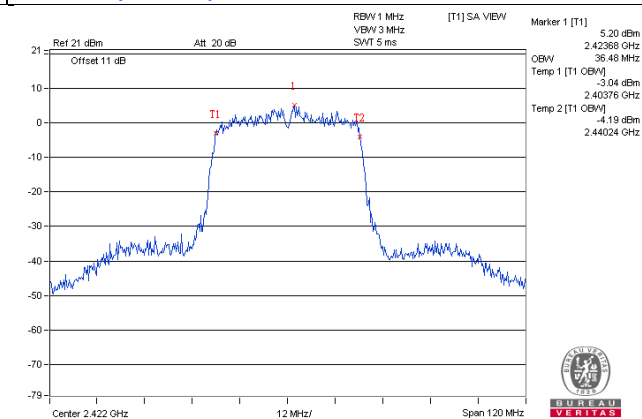

802.11n (40MHz) 2Tx CDD mode Chain1 CH6

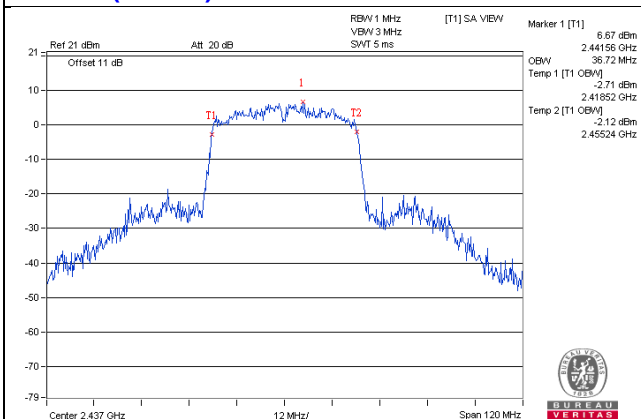

802.11n (40MHz) 2Tx CDD mode Chain2 CH6

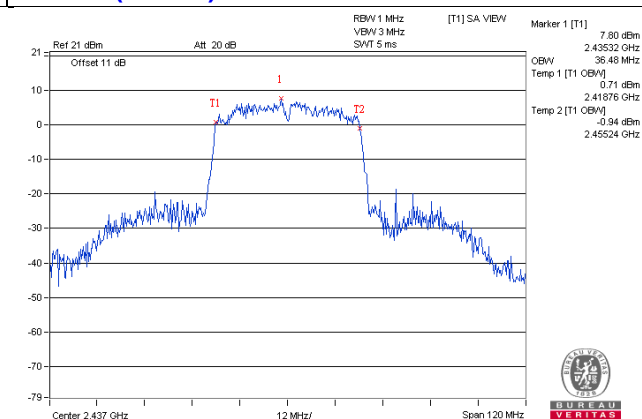

802.11n (40MHz) 2Tx CDD mode Chain1 CH9

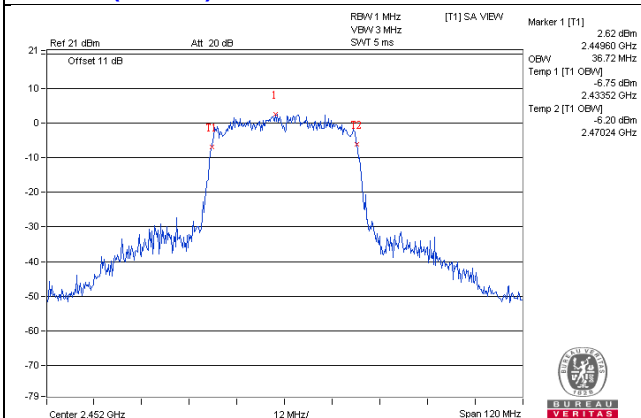

802.11n (40MHz) 2Tx CDD mode Chain2 CH9

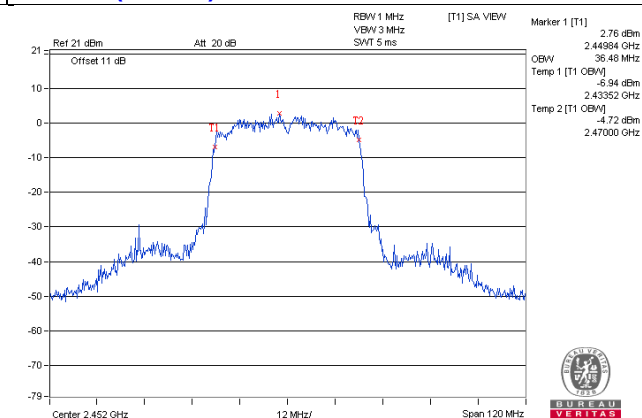

4.6 Radiated Emissions Measurement

4.6.1 Limit

30dBc in any 100 kHz bandwidth outside the operating frequency band. In case the emissions fall within the restricted band specified on 15.205(a), then the 15.209(a) limit in the table below has to be followed.

Frequency Range (MHz)	Field Strength (microvolts/meter)	Measurement Distance (meters)
0.009 ~ 0.490	2400/F(kHz)	300
0.490 ~ 1.705	24000/F(kHz)	30
1.705 ~ 30.0	30	30
30 ~ 88	100	3
88 ~ 216	150	3
216 ~ 960	200	3
Above 960	500	3

4.6.2 Measuring Instruments and Setting

Please refer to section 5 of equipments list in this report. The following table is the setting of spectrum analyzer and receiver.

Spectrum Parameter	Setting
Attenuation	Auto
Start Frequency	1000 MHz
Stop Frequency	10th carrier harmonic
RBW / VBW (Emissions in restricted band)	1MHz / 3MHz for Peak, 1 MHz / 1/T for Average
RBW / VBW (Emissions in non-restricted band)	100kHz / 300kHz for peak

Receiver Parameter	Setting
Attenuation	Auto
Start ~ Stop Frequency	9kHz~150kHz / RBW 200Hz for QP
Start ~ Stop Frequency	150kHz~30MHz / RBW 9kHz for QP
Start ~ Stop Frequency	30MHz~1000MHz / RBW 120kHz for QP

4.6.3 Test Procedure

- 1 Configure the EUT according to ANSI C63.10. The EUT was placed on the top of a rotating table 0.8 meters (for below 1GHz) / 1.5 meters (for above 1GHz) above the ground. The phase center of the receiving antenna mounted on the top of a height-variable antenna tower was placed 3 meters far away from the turntable.
- 2 Power on the EUT and all the supporting units. The turntable was rotated by 360 degrees to determine the position of the highest radiation.
- 3 The height of the broadband receiving antenna was varied between one meter and four meters above ground to find the maximum emissions field strength of both horizontal and vertical polarization.
- 4 For each suspected emissions, the antenna tower was scan (from 1 m to 4 m) and then the turntable was rotated (from 0 degree to 360 degrees) to find the maximum reading.
- 5 Set the test-receiver system to Peak or CISPR quasi-peak Detect Function with specified bandwidth under Maximum Hold Mode
- 6 For emissions above 1GHz, use 1MHz VBW and 3MHz RBW for peak reading. Then 1MHz RBW and 10Hz VBW for average reading in spectrum analyzer for Duty $\geq 98\%$, 1MHz RBW and VBW is $\geq 1/T$ for average reading in spectrum analyzer for Duty $< 98\%$.
- 7 When the radiated emissions limits are expressed in terms of the average value of the emissions, and pulsed operation is employed, the measurement field strength shall be determined by averaging over one complete pulse train, including blanking intervals, as long as the pulse train does not exceed 0.1 seconds. As an alternative (provided the transmitter operates for longer than 0.1 seconds) or where the pulse train exceeds 0.1 seconds, the measured field strength shall be determined from the average absolute voltage during a 0.1 second interval during which the field strength is at its maximum value.
- 8 If the emissions level of the EUT in peak mode was 3 dB lower than the average limit specified, then testing will be stopped and peak values of EUT will be reported, otherwise, the emissions which do not have 3 dB margin will be repeated one by one using the quasi-peak method for below 1GHz.
- 9 For testing above 1GHz, the emissions level of the EUT in peak mode was lower than average limit (that means the emissions level in peak mode also PASS with the limit in average mode), then testing will be stopped and peak values of EUT will be reported, otherwise, the emissions will be measured in average mode again and reported.
- 10 As the emission is lower than 30MHz, loop antenna has to be used for measurement and the recorded data should be QP measured by receiver. High – Low scan is not required in this case.

4.6.4 Test Setup Layout

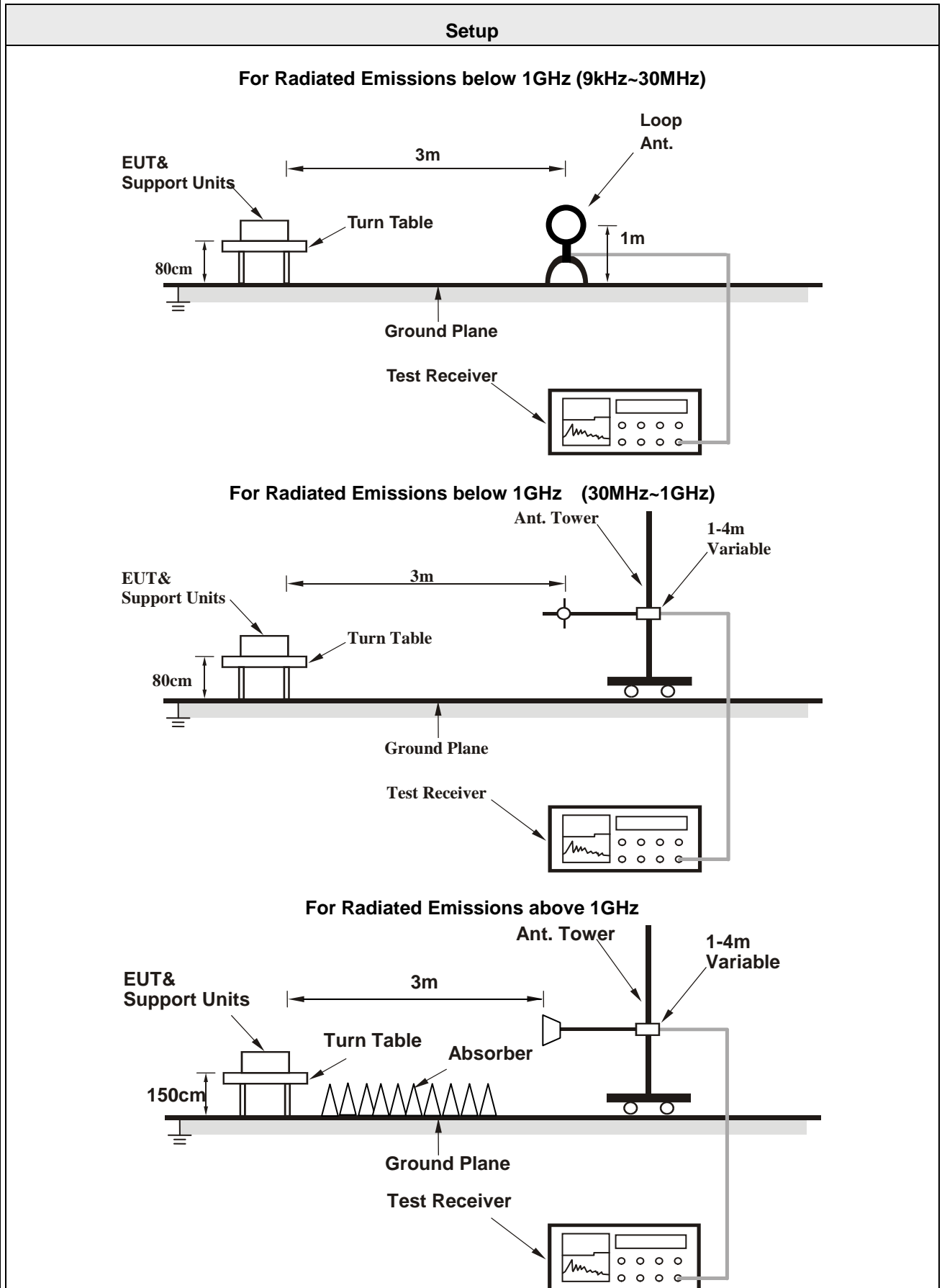

4.6.5 Test Deviation

There are no deviations with the original standard.

4.6.6 EUT Operating Conditions

The EUT was programmed to be in continuously transmitting mode.

4.6.7 Test Results of Radiated Emissions

Temperature	25°C	Humidity	65%
Test Engineer	Jyunchun Lin		

Radiated Emissions Range 9kHz~30MHz

The amplitude of spurious emissions which are attenuated by more than 20 dB below the permissible value has no need to be reported.

Radiated Emissions Range 30MHz~1GHz

802.11n (20MHz)

CHANNEL	TX Channel 6	DETECTOR FUNCTION	Quasi-Peak (QP)
FREQUENCY RANGE	30MHz ~ 1GHz		

ANTENNA POLARITY & TEST DISTANCE: HORIZONTAL AT 3 M

NO.	FREQ. (MHz)	EMISSION LEVEL (dBuV/m)	LIMIT (dBuV/m)	MARGIN (dB)	ANTENNA HEIGHT (m)	TABLE ANGLE (Degree)	RAW VALUE (dBuV)	CORRECTION FACTOR (dB/m)
1	40.28	28.9 QP	40.0	-11.1	3.00 H	163	37.6	-8.7
2	107.96	30.8 QP	43.5	-12.7	2.50 H	235	42.1	-11.3
3	164.78	35.6 QP	43.5	-7.9	2.00 H	90	43.9	-8.3
4	613.89	38.0 QP	46.0	-8.0	1.50 H	360	38.2	-0.2
5	800.03	38.3 QP	46.0	-7.7	1.50 H	360	35.8	2.5
6	859.18	37.6 QP	46.0	-8.4	1.50 H	360	34.3	3.3

REMARKS:

1. Emission Level(dBuV/m) = Raw Value(dBuV) + Correction Factor(dB/m)
2. Correction Factor(dB/m) = Antenna Factor(dB/m) + Cable Factor(dB) – Pre-Amplifier Factor(dB)
3. The other emission levels were very low against the limit.
4. Margin value = Emission Level – Limit value

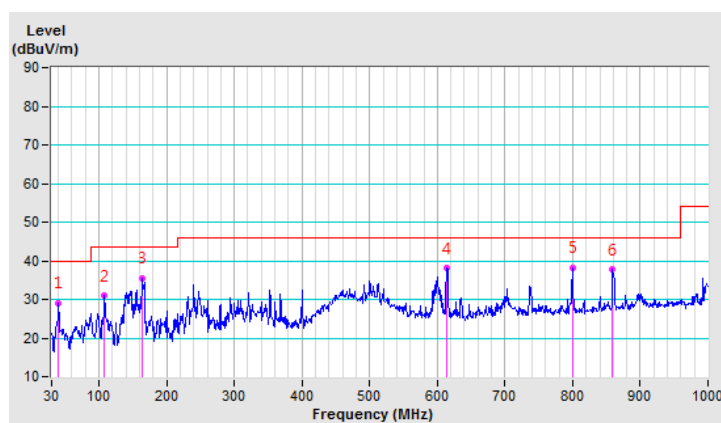

CHANNEL	TX Channel 6	DETECTOR FUNCTION	Quasi-Peak (QP)
FREQUENCY RANGE	30MHz ~ 1GHz		

ANTENNA POLARITY & TEST DISTANCE: VERTICAL AT 3 M								
NO.	FREQ. (MHz)	EMISSION LEVEL (dBuV/m)	LIMIT (dBuV/m)	MARGIN (dB)	ANTENNA HEIGHT (m)	TABLE ANGLE (Degree)	RAW VALUE (dBuV)	CORRECTION FACTOR (dB/m)
1	30.90	36.9 QP	40.0	-3.1	1.00 V	20	46.6	-9.7
2	45.62	35.8 QP	40.0	-4.2	1.50 V	0	44.1	-8.3
3	87.72	33.7 QP	40.0	-6.3	2.00 V	273	48.1	-14.4
4	164.78	32.2 QP	43.5	-11.3	1.00 V	360	40.5	-8.3
5	490.97	34.5 QP	46.0	-11.5	1.00 V	267	37.6	-3.1
6	614.93	35.6 QP	46.0	-10.4	1.00 V	58	35.8	-0.2

REMARKS:

1. Emission Level(dBuV/m) = Raw Value(dBuV) + Correction Factor(dB/m)
2. Correction Factor(dB/m) = Antenna Factor(dB/m) + Cable Factor(dB) – Pre-Amplifier Factor(dB)
3. The other emission levels were very low against the limit.
4. Margin value = Emission Level – Limit value

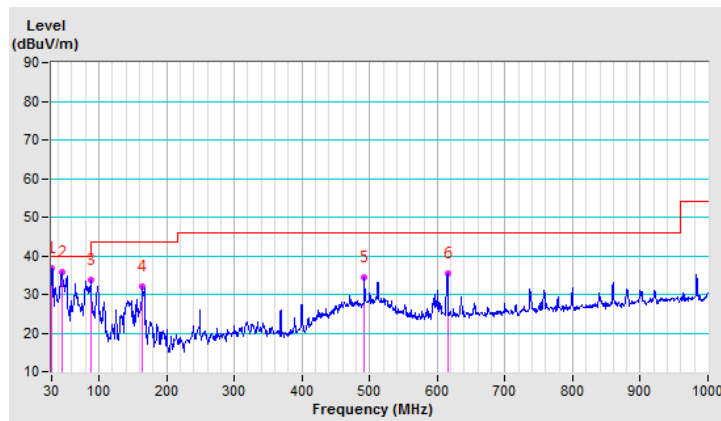

Radiated Emission Range 1GHz~10th Harmonic

1TX

802.11b

CHANNEL	TX Channel 1	DETECTOR FUNCTION	Peak (PK)
FREQUENCY RANGE	1GHz ~ 25GHz		Average (AV)

ANTENNA POLARITY & TEST DISTANCE: HORIZONTAL AT 3 M

NO.	FREQ. (MHz)	EMISSION LEVEL (dBuV/m)	LIMIT (dBuV/m)	MARGIN (dB)	ANTENNA HEIGHT (m)	TABLE ANGLE (Degree)	RAW VALUE (dBuV)	CORRECTION FACTOR (dB/m)
1	4824.00	51.9 PK	74.0	-22.1	1.20 H	318	49.7	2.2
2	4824.00	49.9 AV	54.0	-4.1	1.20 H	318	47.7	2.2

REMARKS:

1. Emission Level(dBuV/m) = Raw Value(dBuV) + Correction Factor(dB/m)
2. Correction Factor(dB/m) = Antenna Factor(dB/m) + Cable Factor(dB) – Pre-Amplifier Factor(dB)
3. The other emission levels were very low against the limit.
4. Margin value = Emission Level – Limit value

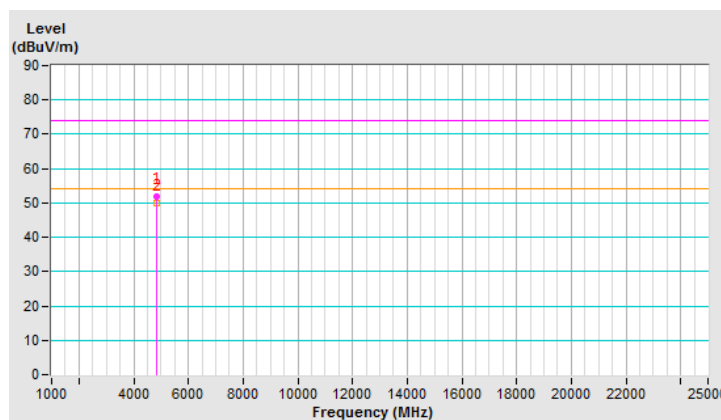

CHANNEL	TX Channel 1	DETECTOR FUNCTION	Peak (PK)
FREQUENCY RANGE	1GHz ~ 25GHz		Average (AV)

ANTENNA POLARITY & TEST DISTANCE: VERTICAL AT 3 M

NO.	FREQ. (MHz)	EMISSION LEVEL (dBuV/m)	LIMIT (dBuV/m)	MARGIN (dB)	ANTENNA HEIGHT (m)	TABLE ANGLE (Degree)	RAW VALUE (dBuV)	CORRECTION FACTOR (dB/m)
1	4824.00	46.5 PK	74.0	-27.5	1.45 V	272	44.3	2.2
2	4824.00	42.3 AV	54.0	-11.7	1.45 V	272	40.1	2.2

REMARKS:

1. Emission Level(dBuV/m) = Raw Value(dBuV) + Correction Factor(dB/m)
2. Correction Factor(dB/m) = Antenna Factor(dB/m) + Cable Factor(dB) – Pre-Amplifier Factor(dB)
3. The other emission levels were very low against the limit.
4. Margin value = Emission Level – Limit value

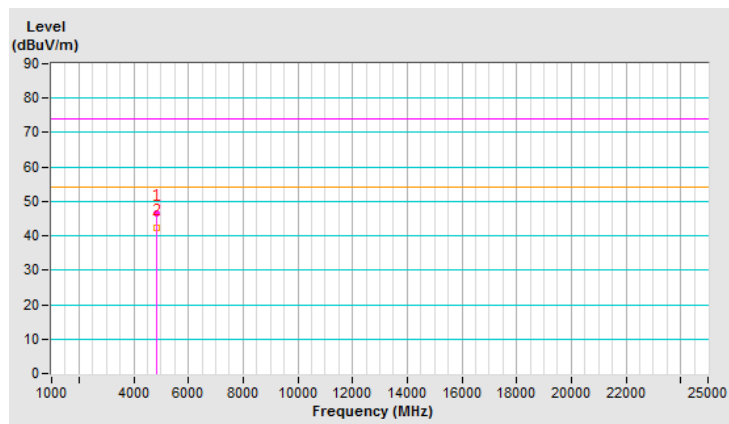

CHANNEL	TX Channel 6	DETECTOR FUNCTION	Peak (PK)
FREQUENCY RANGE	1GHz ~ 25GHz		Average (AV)

ANTENNA POLARITY & TEST DISTANCE: HORIZONTAL AT 3 M

NO.	FREQ. (MHz)	EMISSION LEVEL (dBuV/m)	LIMIT (dBuV/m)	MARGIN (dB)	ANTENNA HEIGHT (m)	TABLE ANGLE (Degree)	RAW VALUE (dBuV)	CORRECTION FACTOR (dB/m)
1	4874.00	52.2 PK	74.0	-21.8	1.21 H	307	49.9	2.3
2	4874.00	50.2 AV	54.0	-3.8	1.21 H	307	47.9	2.3
3	7311.00	45.6 PK	74.0	-28.4	1.00 H	334	37.2	8.4
4	7311.00	36.3 AV	54.0	-17.7	1.00 H	334	27.9	8.4

REMARKS:

1. Emission Level(dBuV/m) = Raw Value(dBuV) + Correction Factor(dB/m)
2. Correction Factor(dB/m) = Antenna Factor(dB/m) + Cable Factor(dB) – Pre-Amplifier Factor(dB)
3. The other emission levels were very low against the limit.
4. Margin value = Emission Level – Limit value

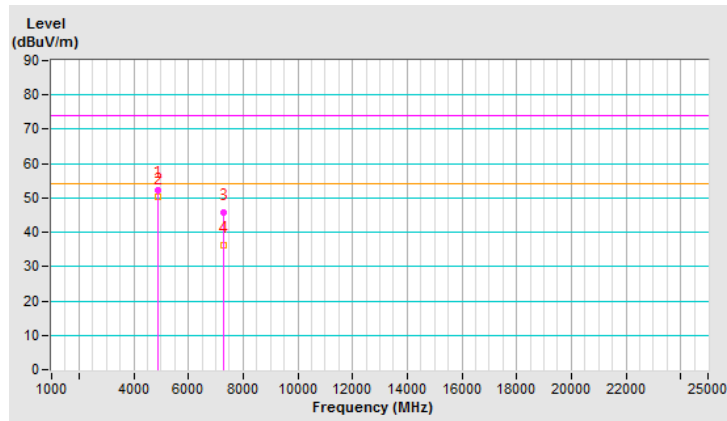

CHANNEL	TX Channel 6	DETECTOR FUNCTION	Peak (PK)
FREQUENCY RANGE	1GHz ~ 25GHz		Average (AV)

ANTENNA POLARITY & TEST DISTANCE: VERTICAL AT 3 M

NO.	FREQ. (MHz)	EMISSION LEVEL (dBuV/m)	LIMIT (dBuV/m)	MARGIN (dB)	ANTENNA HEIGHT (m)	TABLE ANGLE (Degree)	RAW VALUE (dBuV)	CORRECTION FACTOR (dB/m)
1	4874.00	46.6 PK	74.0	-27.4	1.46 V	271	44.3	2.3
2	4874.00	42.4 AV	54.0	-11.6	1.46 V	271	40.1	2.3
3	7311.00	46.0 PK	74.0	-28.0	1.42 V	336	37.6	8.4
4	7311.00	37.5 AV	54.0	-16.5	1.42 V	336	29.1	8.4

REMARKS:

1. Emission Level(dBuV/m) = Raw Value(dBuV) + Correction Factor(dB/m)
2. Correction Factor(dB/m) = Antenna Factor(dB/m) + Cable Factor(dB) – Pre-Amplifier Factor(dB)
3. The other emission levels were very low against the limit.
4. Margin value = Emission Level – Limit value

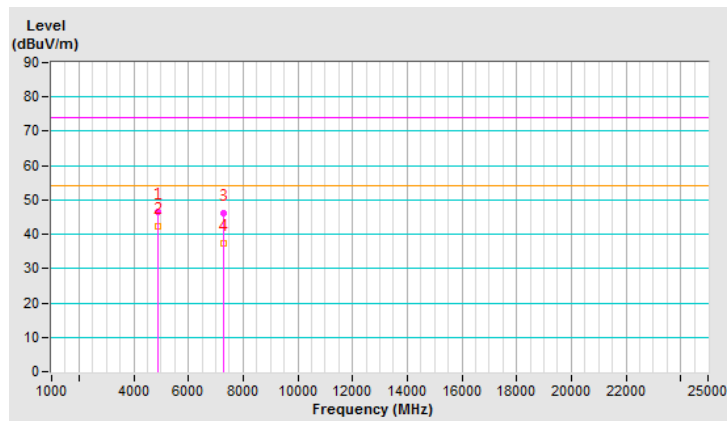

CHANNEL	TX Channel 11	DETECTOR FUNCTION	Peak (PK)
FREQUENCY RANGE	1GHz ~ 25GHz		Average (AV)

ANTENNA POLARITY & TEST DISTANCE: HORIZONTAL AT 3 M								
NO.	FREQ. (MHz)	EMISSION LEVEL (dBuV/m)	LIMIT (dBuV/m)	MARGIN (dB)	ANTENNA HEIGHT (m)	TABLE ANGLE (Degree)	RAW VALUE (dBuV)	CORRECTION FACTOR (dB/m)
1	4924.00	51.6 PK	74.0	-22.4	1.25 H	310	49.2	2.4
2	4924.00	49.8 AV	54.0	-4.2	1.25 H	310	47.4	2.4
3	7386.00	45.2 PK	74.0	-28.8	1.00 H	330	36.7	8.5
4	7386.00	36.1 AV	54.0	-17.9	1.00 H	330	27.6	8.5

REMARKS:

1. Emission Level(dBuV/m) = Raw Value(dBuV) + Correction Factor(dB/m)
2. Correction Factor(dB/m) = Antenna Factor(dB/m) + Cable Factor(dB) – Pre-Amplifier Factor(dB)
3. The other emission levels were very low against the limit.
4. Margin value = Emission Level – Limit value

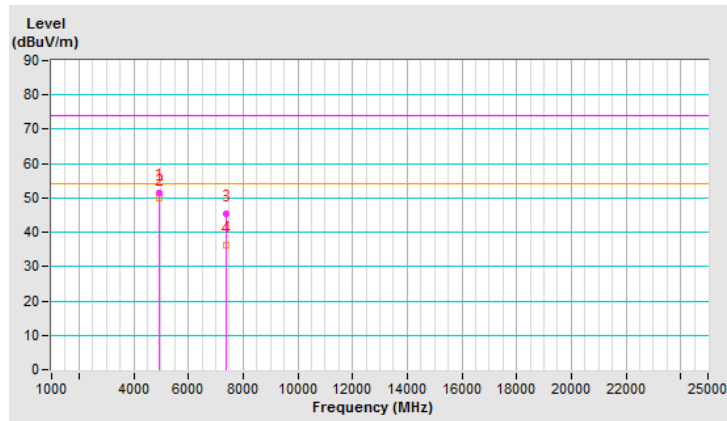

CHANNEL	TX Channel 11	DETECTOR FUNCTION	Peak (PK)
FREQUENCY RANGE	1GHz ~ 25GHz		Average (AV)

ANTENNA POLARITY & TEST DISTANCE: VERTICAL AT 3 M

NO.	FREQ. (MHz)	EMISSION LEVEL (dBuV/m)	LIMIT (dBuV/m)	MARGIN (dB)	ANTENNA HEIGHT (m)	TABLE ANGLE (Degree)	RAW VALUE (dBuV)	CORRECTION FACTOR (dB/m)
1	4924.00	46.2 PK	74.0	-27.8	1.45 V	270	43.8	2.4
2	4924.00	42.2 AV	54.0	-11.8	1.45 V	270	39.8	2.4
3	7386.00	45.7 PK	74.0	-28.3	1.42 V	322	37.2	8.5
4	7386.00	37.2 AV	54.0	-16.8	1.42 V	322	28.7	8.5

REMARKS:

1. Emission Level(dBuV/m) = Raw Value(dBuV) + Correction Factor(dB/m)
2. Correction Factor(dB/m) = Antenna Factor(dB/m) + Cable Factor(dB) – Pre-Amplifier Factor(dB)
3. The other emission levels were very low against the limit.
4. Margin value = Emission Level – Limit value

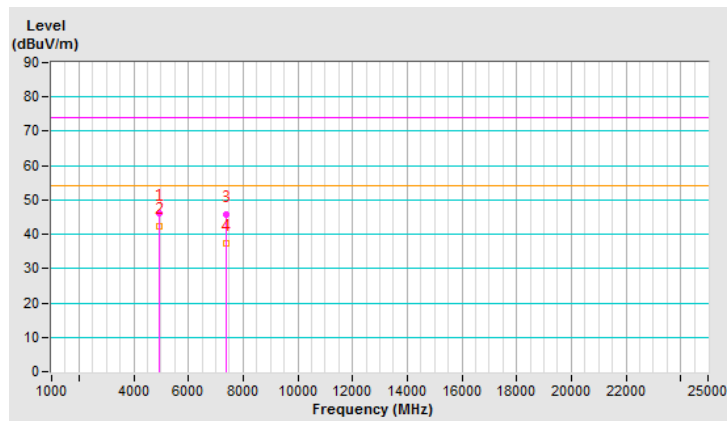

802.11g

CHANNEL	TX Channel 1	DETECTOR FUNCTION	Peak (PK)
FREQUENCY RANGE	1GHz ~ 25GHz		Average (AV)

ANTENNA POLARITY & TEST DISTANCE: HORIZONTAL AT 3 M

NO.	FREQ. (MHz)	EMISSION LEVEL (dBuV/m)	LIMIT (dBuV/m)	MARGIN (dB)	ANTENNA HEIGHT (m)	TABLE ANGLE (Degree)	RAW VALUE (dBuV)	CORRECTION FACTOR (dB/m)
1	4824.00	57.1 PK	74.0	-16.9	1.23 H	322	54.9	2.2
2	4824.00	43.0 AV	54.0	-11.0	1.23 H	322	40.8	2.2

REMARKS:

1. Emission Level(dBuV/m) = Raw Value(dBuV) + Correction Factor(dB/m)
2. Correction Factor(dB/m) = Antenna Factor(dB/m) + Cable Factor(dB) – Pre-Amplifier Factor(dB)
3. The other emission levels were very low against the limit.
4. Margin value = Emission Level – Limit value

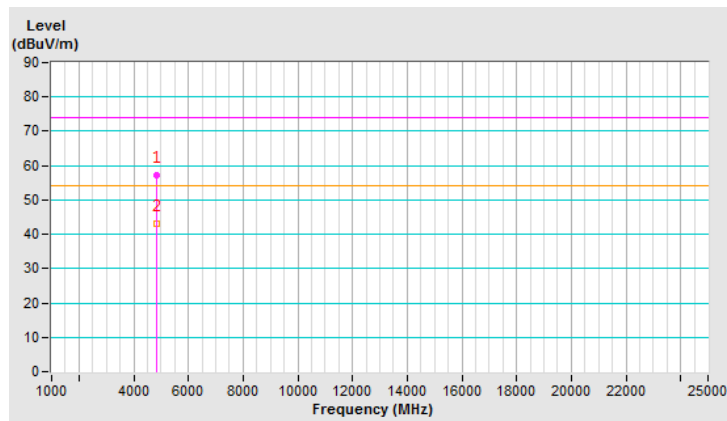

CHANNEL	TX Channel 1	DETECTOR FUNCTION	Peak (PK)
FREQUENCY RANGE	1GHz ~ 25GHz		Average (AV)

ANTENNA POLARITY & TEST DISTANCE: VERTICAL AT 3 M

NO.	FREQ. (MHz)	EMISSION LEVEL (dBuV/m)	LIMIT (dBuV/m)	MARGIN (dB)	ANTENNA HEIGHT (m)	TABLE ANGLE (Degree)	RAW VALUE (dBuV)	CORRECTION FACTOR (dB/m)
1	4824.00	50.3 PK	74.0	-23.7	1.42 V	274	48.1	2.2
2	4824.00	36.5 AV	54.0	-17.5	1.42 V	274	34.3	2.2

REMARKS:

1. Emission Level(dBuV/m) = Raw Value(dBuV) + Correction Factor(dB/m)
2. Correction Factor(dB/m) = Antenna Factor(dB/m) + Cable Factor(dB) – Pre-Amplifier Factor(dB)
3. The other emission levels were very low against the limit.
4. Margin value = Emission Level – Limit value

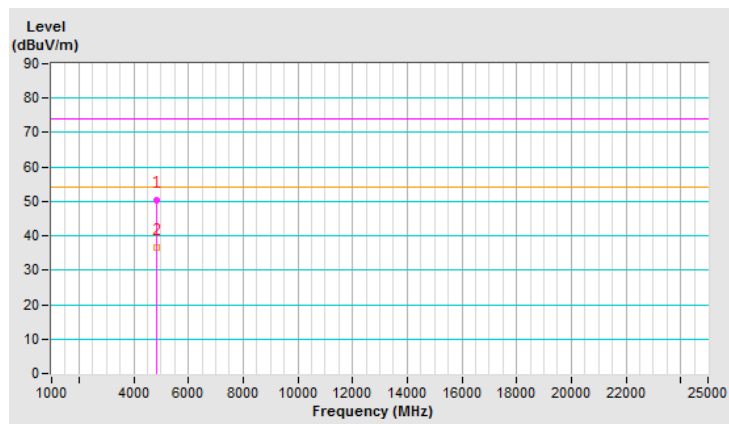

CHANNEL	TX Channel 6	DETECTOR FUNCTION	Peak (PK)
FREQUENCY RANGE	1GHz ~ 25GHz		Average (AV)

ANTENNA POLARITY & TEST DISTANCE: HORIZONTAL AT 3 M

NO.	FREQ. (MHz)	EMISSION LEVEL (dBuV/m)	LIMIT (dBuV/m)	MARGIN (dB)	ANTENNA HEIGHT (m)	TABLE ANGLE (Degree)	RAW VALUE (dBuV)	CORRECTION FACTOR (dB/m)
1	4874.00	57.9 PK	74.0	-16.1	1.21 H	307	55.6	2.3
2	4874.00	44.0 AV	54.0	-10.0	1.21 H	307	41.7	2.3
3	7311.00	47.2 PK	74.0	-26.8	1.00 H	333	38.8	8.4
4	7311.00	34.9 AV	54.0	-19.1	1.00 H	333	26.5	8.4

REMARKS:

1. Emission Level(dBuV/m) = Raw Value(dBuV) + Correction Factor(dB/m)
2. Correction Factor(dB/m) = Antenna Factor(dB/m) + Cable Factor(dB) – Pre-Amplifier Factor(dB)
3. The other emission levels were very low against the limit.
4. Margin value = Emission Level – Limit value

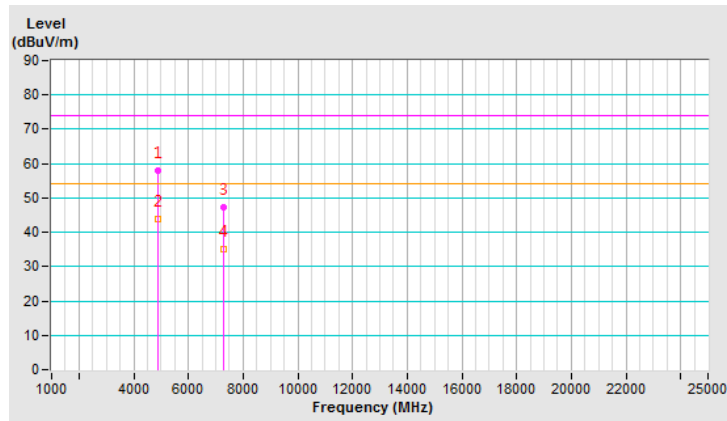

CHANNEL	TX Channel 6	DETECTOR FUNCTION	Peak (PK)
FREQUENCY RANGE	1GHz ~ 25GHz		Average (AV)

ANTENNA POLARITY & TEST DISTANCE: VERTICAL AT 3 M

NO.	FREQ. (MHz)	EMISSION LEVEL (dBuV/m)	LIMIT (dBuV/m)	MARGIN (dB)	ANTENNA HEIGHT (m)	TABLE ANGLE (Degree)	RAW VALUE (dBuV)	CORRECTION FACTOR (dB/m)
1	4874.00	50.8 PK	74.0	-23.2	1.40 V	278	48.5	2.3
2	4874.00	36.8 AV	54.0	-17.2	1.40 V	278	34.5	2.3
3	7311.00	48.8 PK	74.0	-25.2	1.40 V	346	40.4	8.4
4	7311.00	36.3 AV	54.0	-17.7	1.40 V	346	27.9	8.4

REMARKS:

1. Emission Level(dBuV/m) = Raw Value(dBuV) + Correction Factor(dB/m)
2. Correction Factor(dB/m) = Antenna Factor(dB/m) + Cable Factor(dB) – Pre-Amplifier Factor(dB)
3. The other emission levels were very low against the limit.
4. Margin value = Emission Level – Limit value

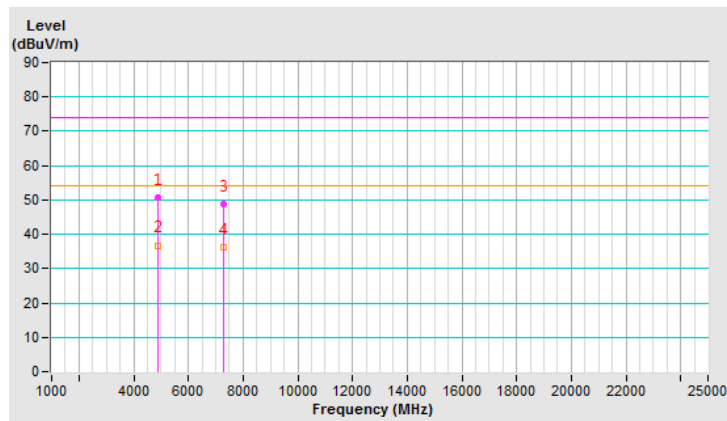

CHANNEL	TX Channel 11	DETECTOR FUNCTION	Peak (PK)
FREQUENCY RANGE	1GHz ~ 25GHz		Average (AV)

ANTENNA POLARITY & TEST DISTANCE: HORIZONTAL AT 3 M

NO.	FREQ. (MHz)	EMISSION LEVEL (dBuV/m)	LIMIT (dBuV/m)	MARGIN (dB)	ANTENNA HEIGHT (m)	TABLE ANGLE (Degree)	RAW VALUE (dBuV)	CORRECTION FACTOR (dB/m)
1	4924.00	57.7 PK	74.0	-16.3	1.18 H	294	55.3	2.4
2	4924.00	43.8 AV	54.0	-10.2	1.18 H	294	41.4	2.4
3	7386.00	47.1 PK	74.0	-26.9	1.00 H	337	38.6	8.5
4	7386.00	34.7 AV	54.0	-19.3	1.00 H	337	26.2	8.5

REMARKS:

1. Emission Level(dBuV/m) = Raw Value(dBuV) + Correction Factor(dB/m)
2. Correction Factor(dB/m) = Antenna Factor(dB/m) + Cable Factor(dB) – Pre-Amplifier Factor(dB)
3. The other emission levels were very low against the limit.
4. Margin value = Emission Level – Limit value

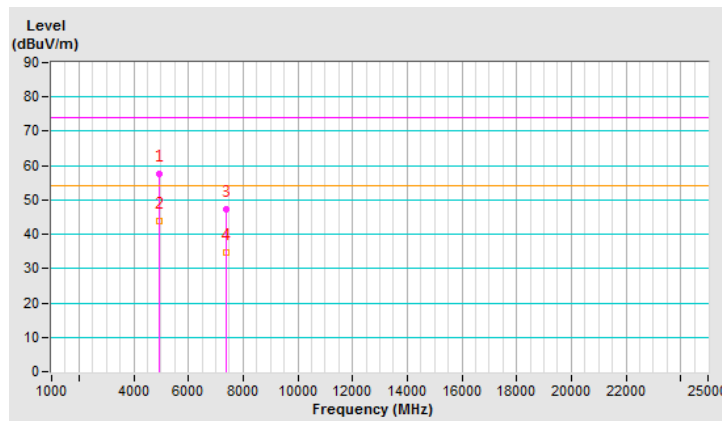

CHANNEL	TX Channel 11	DETECTOR FUNCTION	Peak (PK)
FREQUENCY RANGE	1GHz ~ 25GHz		Average (AV)

ANTENNA POLARITY & TEST DISTANCE: VERTICAL AT 3 M

NO.	FREQ. (MHz)	EMISSION LEVEL (dBuV/m)	LIMIT (dBuV/m)	MARGIN (dB)	ANTENNA HEIGHT (m)	TABLE ANGLE (Degree)	RAW VALUE (dBuV)	CORRECTION FACTOR (dB/m)
1	4924.00	49.8 PK	74.0	-24.2	1.36 V	274	47.4	2.4
2	4924.00	35.9 AV	54.0	-18.1	1.36 V	274	33.5	2.4
3	7386.00	48.7 PK	74.0	-25.3	1.40 V	349	40.2	8.5
4	7386.00	36.1 AV	54.0	-17.9	1.40 V	349	27.6	8.5

REMARKS:

1. Emission Level(dBuV/m) = Raw Value(dBuV) + Correction Factor(dB/m)
2. Correction Factor(dB/m) = Antenna Factor(dB/m) + Cable Factor(dB) – Pre-Amplifier Factor(dB)
3. The other emission levels were very low against the limit.
4. Margin value = Emission Level – Limit value

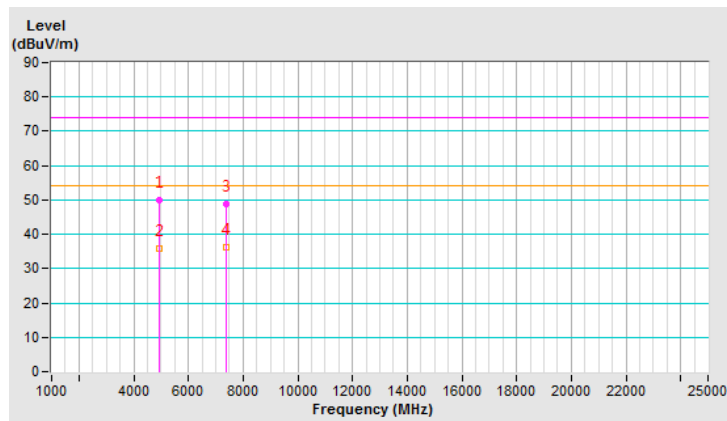

2TX

802.11n (20MHz)

CHANNEL	TX Channel 1	DETECTOR FUNCTION	Peak (PK)
FREQUENCY RANGE	1GHz ~ 25GHz		Average (AV)

ANTENNA POLARITY & TEST DISTANCE: HORIZONTAL AT 3 M								
NO.	FREQ. (MHz)	EMISSION LEVEL (dBuV/m)	LIMIT (dBuV/m)	MARGIN (dB)	ANTENNA HEIGHT (m)	TABLE ANGLE (Degree)	RAW VALUE (dBuV)	CORRECTION FACTOR (dB/m)
1	4824.00	39.1 PK	74.0	-34.9	1.42 H	208	36.9	2.2
2	4824.00	29.3 AV	54.0	-24.7	1.42 H	208	27.1	2.2

REMARKS:

1. Emission Level(dBuV/m) = Raw Value(dBuV) + Correction Factor(dB/m)
2. Correction Factor(dB/m) = Antenna Factor(dB/m) + Cable Factor(dB) – Pre-Amplifier Factor(dB)
3. The other emission levels were very low against the limit.
4. Margin value = Emission Level – Limit value

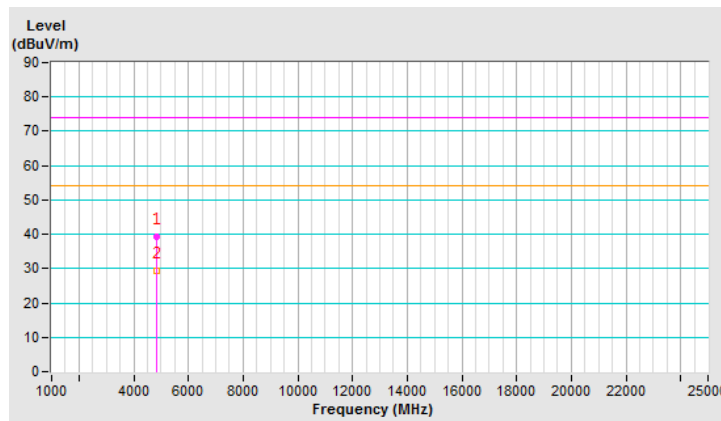

CHANNEL	TX Channel 1	DETECTOR FUNCTION	Peak (PK)
FREQUENCY RANGE	1GHz ~ 25GHz		Average (AV)

ANTENNA POLARITY & TEST DISTANCE: VERTICAL AT 3 M

NO.	FREQ. (MHz)	EMISSION LEVEL (dBuV/m)	LIMIT (dBuV/m)	MARGIN (dB)	ANTENNA HEIGHT (m)	TABLE ANGLE (Degree)	RAW VALUE (dBuV)	CORRECTION FACTOR (dB/m)
1	4824.00	53.5 PK	74.0	-20.5	2.22 V	62	51.3	2.2
2	4824.00	50.2 AV	54.0	-3.8	2.22 V	62	48.0	2.2

REMARKS:

1. Emission Level(dBuV/m) = Raw Value(dBuV) + Correction Factor(dB/m)
2. Correction Factor(dB/m) = Antenna Factor(dB/m) + Cable Factor(dB) – Pre-Amplifier Factor(dB)
3. The other emission levels were very low against the limit.
4. Margin value = Emission Level – Limit value

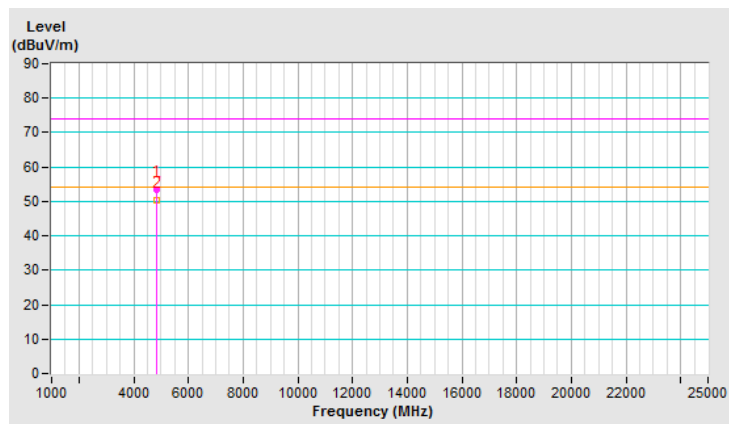

CHANNEL	TX Channel 6	DETECTOR FUNCTION	Peak (PK)
FREQUENCY RANGE	1GHz ~ 25GHz		Average (AV)

ANTENNA POLARITY & TEST DISTANCE: HORIZONTAL AT 3 M

NO.	FREQ. (MHz)	EMISSION LEVEL (dBuV/m)	LIMIT (dBuV/m)	MARGIN (dB)	ANTENNA HEIGHT (m)	TABLE ANGLE (Degree)	RAW VALUE (dBuV)	CORRECTION FACTOR (dB/m)
1	4874.00	39.6 PK	74.0	-34.4	1.40 H	221	37.3	2.3
2	4874.00	29.7 AV	54.0	-24.3	1.40 H	221	27.4	2.3
3	7311.00	55.9 PK	74.0	-18.1	1.04 H	43	47.5	8.4
4	7311.00	44.7 AV	54.0	-9.3	1.04 H	43	36.3	8.4

REMARKS:

1. Emission Level(dBuV/m) = Raw Value(dBuV) + Correction Factor(dB/m)
2. Correction Factor(dB/m) = Antenna Factor(dB/m) + Cable Factor(dB) – Pre-Amplifier Factor(dB)
3. The other emission levels were very low against the limit.
4. Margin value = Emission Level – Limit value

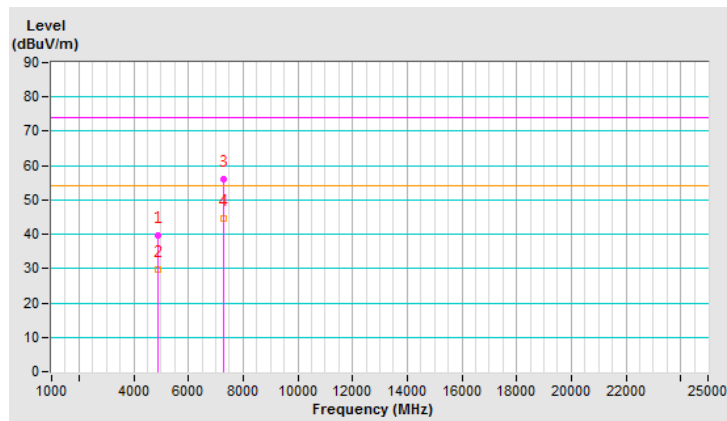

CHANNEL	TX Channel 6	DETECTOR FUNCTION	Peak (PK)
FREQUENCY RANGE	1GHz ~ 25GHz		Average (AV)

ANTENNA POLARITY & TEST DISTANCE: VERTICAL AT 3 M

NO.	FREQ. (MHz)	EMISSION LEVEL (dBuV/m)	LIMIT (dBuV/m)	MARGIN (dB)	ANTENNA HEIGHT (m)	TABLE ANGLE (Degree)	RAW VALUE (dBuV)	CORRECTION FACTOR (dB/m)
1	4874.00	64.7 PK	74.0	-9.3	2.16 V	54	62.4	2.3
2	4874.00	51.5 AV	54.0	-2.5	2.16 V	54	49.2	2.3
3	7311.00	60.7 PK	74.0	-13.3	3.95 V	339	52.3	8.4
4	7311.00	46.9 AV	54.0	-7.1	3.95 V	339	38.5	8.4

REMARKS:

1. Emission Level(dBuV/m) = Raw Value(dBuV) + Correction Factor(dB/m)
2. Correction Factor(dB/m) = Antenna Factor(dB/m) + Cable Factor(dB) – Pre-Amplifier Factor(dB)
3. The other emission levels were very low against the limit.
4. Margin value = Emission Level – Limit value

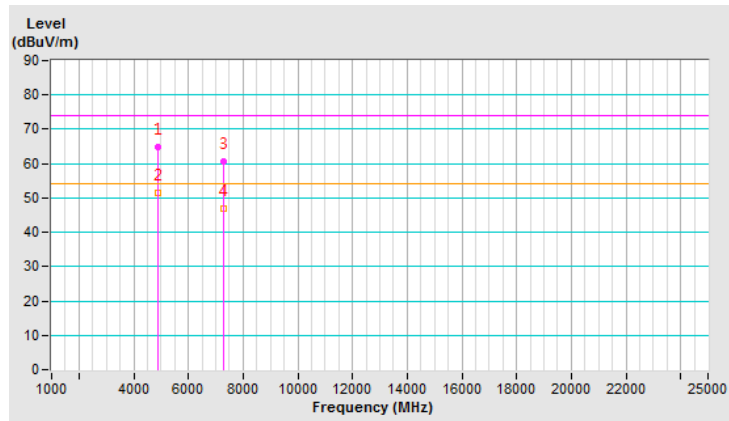

CHANNEL	TX Channel 11	DETECTOR FUNCTION	Peak (PK)
FREQUENCY RANGE	1GHz ~ 25GHz		Average (AV)

ANTENNA POLARITY & TEST DISTANCE: HORIZONTAL AT 3 M

NO.	FREQ. (MHz)	EMISSION LEVEL (dBuV/m)	LIMIT (dBuV/m)	MARGIN (dB)	ANTENNA HEIGHT (m)	TABLE ANGLE (Degree)	RAW VALUE (dBuV)	CORRECTION FACTOR (dB/m)
1	4924.00	39.0 PK	74.0	-35.0	1.40 H	235	36.6	2.4
2	4924.00	29.2 AV	54.0	-24.8	1.40 H	235	26.8	2.4
3	7386.00	55.4 PK	74.0	-18.6	1.03 H	39	46.9	8.5
4	7386.00	44.5 AV	54.0	-9.5	1.03 H	39	36.0	8.5

REMARKS:

1. Emission Level(dBuV/m) = Raw Value(dBuV) + Correction Factor(dB/m)
2. Correction Factor(dB/m) = Antenna Factor(dB/m) + Cable Factor(dB) – Pre-Amplifier Factor(dB)
3. The other emission levels were very low against the limit.
4. Margin value = Emission Level – Limit value

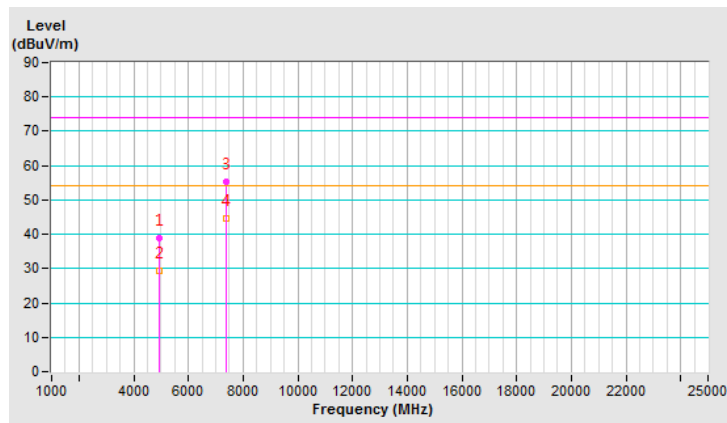

CHANNEL	TX Channel 11	DETECTOR FUNCTION	Peak (PK)
FREQUENCY RANGE	1GHz ~ 25GHz		Average (AV)

ANTENNA POLARITY & TEST DISTANCE: VERTICAL AT 3 M

NO.	FREQ. (MHz)	EMISSION LEVEL (dBuV/m)	LIMIT (dBuV/m)	MARGIN (dB)	ANTENNA HEIGHT (m)	TABLE ANGLE (Degree)	RAW VALUE (dBuV)	CORRECTION FACTOR (dB/m)
1	4924.00	63.6 PK	74.0	-10.4	2.18 V	54	61.2	2.4
2	4924.00	50.6 AV	54.0	-3.4	2.18 V	54	48.2	2.4
3	7386.00	59.6 PK	74.0	-14.4	3.95 V	338	51.1	8.5
4	7386.00	46.0 AV	54.0	-8.0	3.95 V	338	37.5	8.5

REMARKS:

1. Emission Level(dBuV/m) = Raw Value(dBuV) + Correction Factor(dB/m)
2. Correction Factor(dB/m) = Antenna Factor(dB/m) + Cable Factor(dB) – Pre-Amplifier Factor(dB)
3. The other emission levels were very low against the limit.
4. Margin value = Emission Level – Limit value

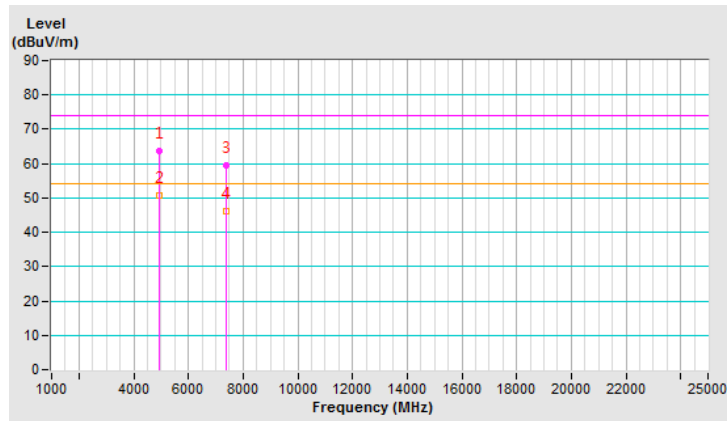

802.11n (40MHz)

CHANNEL	TX Channel 3	DETECTOR FUNCTION	Peak (PK)
FREQUENCY RANGE	1GHz ~ 25GHz		Average (AV)

ANTENNA POLARITY & TEST DISTANCE: HORIZONTAL AT 3 M								
NO.	FREQ. (MHz)	EMISSION LEVEL (dBuV/m)	LIMIT (dBuV/m)	MARGIN (dB)	ANTENNA HEIGHT (m)	TABLE ANGLE (Degree)	RAW VALUE (dBuV)	CORRECTION FACTOR (dB/m)
1	4844.00	43.2 PK	74.0	-30.8	1.49 H	222	40.9	2.3
2	4844.00	31.1 AV	54.0	-22.9	1.49 H	222	28.8	2.3
3	7266.00	42.1 PK	74.0	-31.9	1.09 H	51	33.7	8.4
4	7266.00	30.9 AV	54.0	-23.1	1.09 H	51	22.5	8.4

REMARKS:

1. Emission Level(dBuV/m) = Raw Value(dBuV) + Correction Factor(dB/m)
2. Correction Factor(dB/m) = Antenna Factor(dB/m) + Cable Factor(dB) – Pre-Amplifier Factor(dB)
3. The other emission levels were very low against the limit.
4. Margin value = Emission Level – Limit value

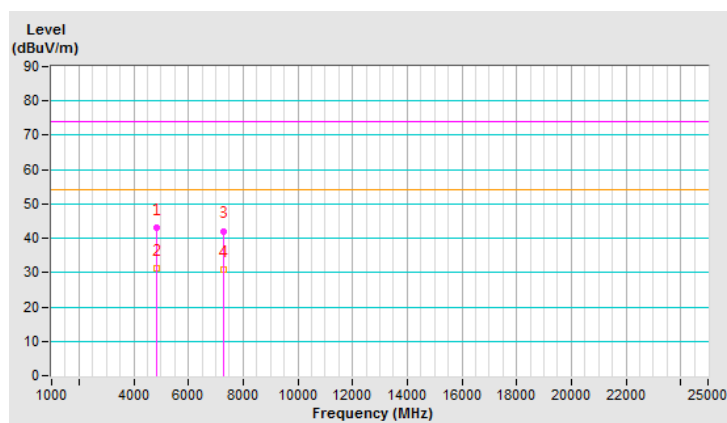

CHANNEL	TX Channel 3	DETECTOR FUNCTION	Peak (PK)
FREQUENCY RANGE	1GHz ~ 25GHz		Average (AV)

ANTENNA POLARITY & TEST DISTANCE: VERTICAL AT 3 M

NO.	FREQ. (MHz)	EMISSION LEVEL (dBuV/m)	LIMIT (dBuV/m)	MARGIN (dB)	ANTENNA HEIGHT (m)	TABLE ANGLE (Degree)	RAW VALUE (dBuV)	CORRECTION FACTOR (dB/m)
1	4844.00	44.7 PK	74.0	-29.3	2.63 V	42	42.4	2.3
2	4844.00	31.8 AV	54.0	-22.2	2.63 V	42	29.5	2.3
3	7266.00	42.3 PK	74.0	-31.7	1.47 V	307	33.9	8.4
4	7266.00	30.3 AV	54.0	-23.7	1.47 V	307	21.9	8.4

REMARKS:

1. Emission Level(dBuV/m) = Raw Value(dBuV) + Correction Factor(dB/m)
2. Correction Factor(dB/m) = Antenna Factor(dB/m) + Cable Factor(dB) – Pre-Amplifier Factor(dB)
3. The other emission levels were very low against the limit.
4. Margin value = Emission Level – Limit value

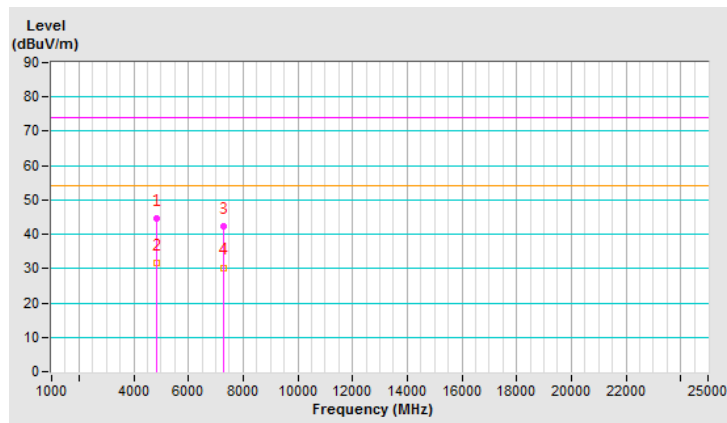

CHANNEL	TX Channel 6	DETECTOR FUNCTION	Peak (PK)
FREQUENCY RANGE	1GHz ~ 25GHz		Average (AV)

ANTENNA POLARITY & TEST DISTANCE: HORIZONTAL AT 3 M

NO.	FREQ. (MHz)	EMISSION LEVEL (dBuV/m)	LIMIT (dBuV/m)	MARGIN (dB)	ANTENNA HEIGHT (m)	TABLE ANGLE (Degree)	RAW VALUE (dBuV)	CORRECTION FACTOR (dB/m)
1	4874.00	44.1 PK	74.0	-29.9	1.46 H	225	41.8	2.3
2	4874.00	32.2 AV	54.0	-21.8	1.46 H	225	29.9	2.3
3	7311.00	42.2 PK	74.0	-31.8	1.07 H	45	33.8	8.4
4	7311.00	31.1 AV	54.0	-22.9	1.07 H	45	22.7	8.4

REMARKS:

1. Emission Level(dBuV/m) = Raw Value(dBuV) + Correction Factor(dB/m)
2. Correction Factor(dB/m) = Antenna Factor(dB/m) + Cable Factor(dB) – Pre-Amplifier Factor(dB)
3. The other emission levels were very low against the limit.
4. Margin value = Emission Level – Limit value

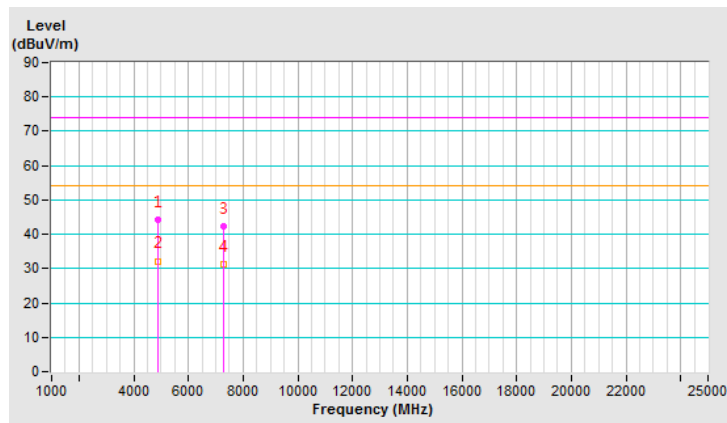

CHANNEL	TX Channel 6	DETECTOR FUNCTION	Peak (PK)
FREQUENCY RANGE	1GHz ~ 25GHz		Average (AV)

ANTENNA POLARITY & TEST DISTANCE: VERTICAL AT 3 M

NO.	FREQ. (MHz)	EMISSION LEVEL (dBuV/m)	LIMIT (dBuV/m)	MARGIN (dB)	ANTENNA HEIGHT (m)	TABLE ANGLE (Degree)	RAW VALUE (dBuV)	CORRECTION FACTOR (dB/m)
1	4874.00	44.9 PK	74.0	-29.1	2.63 V	44	42.6	2.3
2	4874.00	32.1 AV	54.0	-21.9	2.63 V	44	29.8	2.3
3	7311.00	42.9 PK	74.0	-31.1	1.50 V	313	34.5	8.4
4	7311.00	30.7 AV	54.0	-23.3	1.50 V	313	22.3	8.4

REMARKS:

1. Emission Level(dBuV/m) = Raw Value(dBuV) + Correction Factor(dB/m)
2. Correction Factor(dB/m) = Antenna Factor(dB/m) + Cable Factor(dB) – Pre-Amplifier Factor(dB)
3. The other emission levels were very low against the limit.
4. Margin value = Emission Level – Limit value

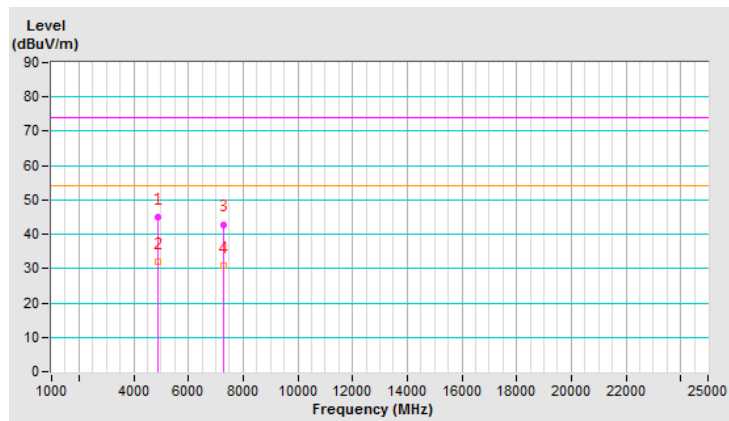

CHANNEL	TX Channel 9	DETECTOR FUNCTION	Peak (PK)
FREQUENCY RANGE	1GHz ~ 25GHz		Average (AV)

ANTENNA POLARITY & TEST DISTANCE: HORIZONTAL AT 3 M

NO.	FREQ. (MHz)	EMISSION LEVEL (dBuV/m)	LIMIT (dBuV/m)	MARGIN (dB)	ANTENNA HEIGHT (m)	TABLE ANGLE (Degree)	RAW VALUE (dBuV)	CORRECTION FACTOR (dB/m)
1	4904.00	43.0 PK	74.0	-31.0	1.42 H	235	40.6	2.4
2	4904.00	31.2 AV	54.0	-22.8	1.42 H	235	28.8	2.4
3	7356.00	42.0 PK	74.0	-32.0	1.02 H	50	33.5	8.5
4	7356.00	30.0 AV	54.0	-24.0	1.02 H	50	21.5	8.5

REMARKS:

1. Emission Level(dBuV/m) = Raw Value(dBuV) + Correction Factor(dB/m)
2. Correction Factor(dB/m) = Antenna Factor(dB/m) + Cable Factor(dB) – Pre-Amplifier Factor(dB)
3. The other emission levels were very low against the limit.
4. Margin value = Emission Level – Limit value

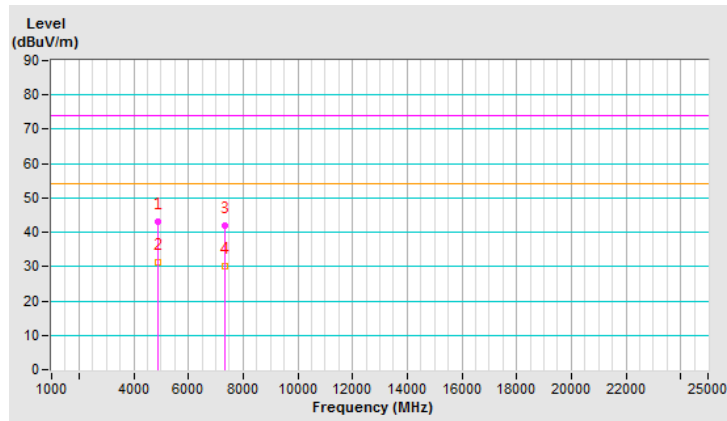

CHANNEL	TX Channel 9	DETECTOR FUNCTION	Peak (PK)
FREQUENCY RANGE	1GHz ~ 25GHz		Average (AV)

ANTENNA POLARITY & TEST DISTANCE: VERTICAL AT 3 M

NO.	FREQ. (MHz)	EMISSION LEVEL (dBuV/m)	LIMIT (dBuV/m)	MARGIN (dB)	ANTENNA HEIGHT (m)	TABLE ANGLE (Degree)	RAW VALUE (dBuV)	CORRECTION FACTOR (dB/m)
1	4904.00	44.1 PK	74.0	-29.9	2.59 V	58	41.7	2.4
2	4904.00	31.5 AV	54.0	-22.5	2.59 V	58	29.1	2.4
3	7356.00	42.1 PK	74.0	-31.9	1.49 V	304	33.6	8.5
4	7356.00	30.1 AV	54.0	-23.9	1.49 V	304	21.6	8.5

REMARKS:

1. Emission Level(dBuV/m) = Raw Value(dBuV) + Correction Factor(dB/m)
2. Correction Factor(dB/m) = Antenna Factor(dB/m) + Cable Factor(dB) – Pre-Amplifier Factor(dB)
3. The other emission levels were very low against the limit.
4. Margin value = Emission Level – Limit value

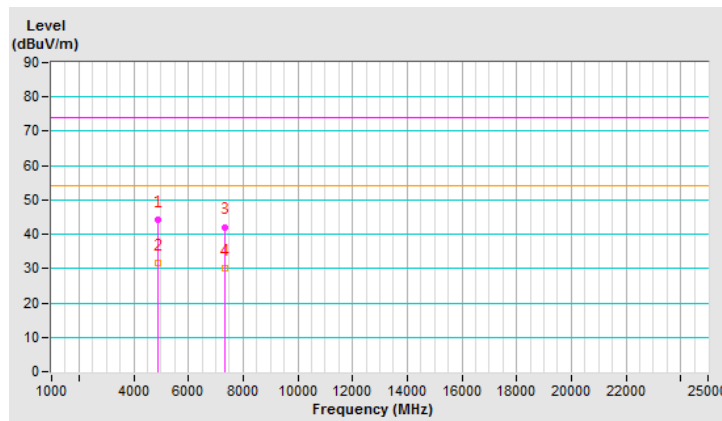

4.7 Band Edge and Fundamental Emissions Measurement

4.7.1 Limit

30dBc in any 100 kHz bandwidth outside the operating frequency band. In case the emissions fall within the restricted band specified on 15.205(a), then the 15.209(a) limit in the table below has to be followed

Frequency range (MHz)	Field Strength (mV/meter)	Measurement Distance (m)
0.009~0.490	2400/F(kHz)	300
0.490~1.705	24000/F(kHz)	30
1.705~30.0	30	30
30~88	100	3
88~216	150	3
216~960	200	3
Above 960	500	3

4.7.2 Measuring Instruments and Setting

Please refer to section 5 of equipments list in this report. The following table is the setting of spectrum analyzer and receiver.

Spectrum Parameter	Setting
Attenuation	Auto
Start Frequency	1000 MHz
Stop Frequency	10th carrier harmonic
RBW / VBW (Emissions in restricted band)	1MHz / 3MHz for Peak, 1 MHz / 1/T for Average
RBW / VBW (Emissions in non-restricted band)	100kHz / 300kHz for peak

4.7.3 Test Procedure

- 1 The test procedure is the same as section 4.6.3; only the frequency range investigated is 2310MHz to 2500MHz
- 2 Test for Emissions in non-restricted band was performed in accordance with KDB 558074 D01 v04 for Performing Compliance Measurements on Digital Transmission Systems (DTS) Operating Under §15.247 section 11 Unwanted Emissions into Non-Restricted Frequency Bands Measurement Procedure.

4.7.4 Test Setup Layout

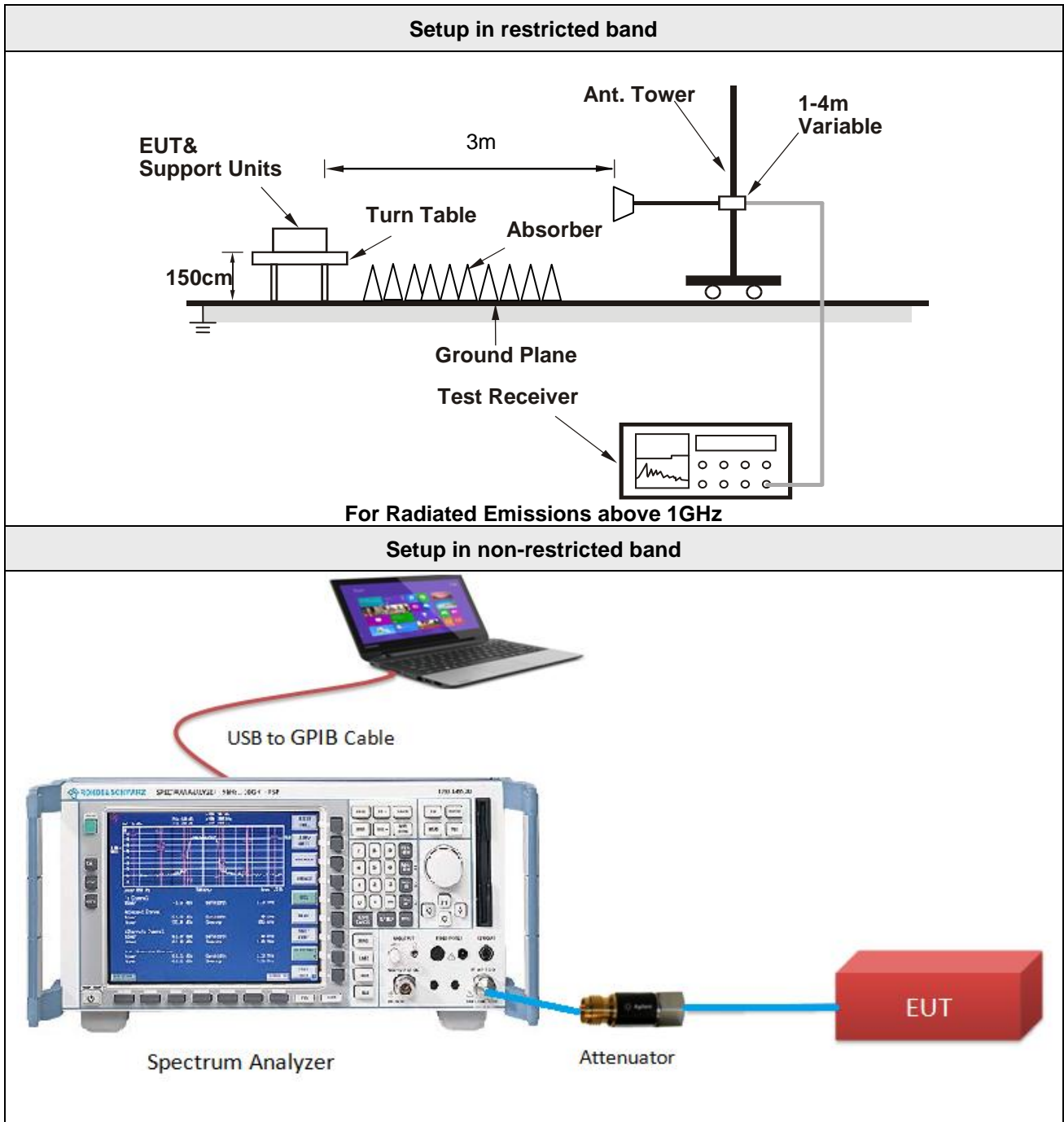

4.7.5 Test Deviation

There are no deviations with the original standard.

4.7.6 EUT Operating Conditions

The EUT was programmed to be in continuously transmitting mode.

CHANNEL	TX Channel 1	DETECTOR FUNCTION	Peak (PK)
FREQUENCY RANGE	1GHz ~ 25GHz		Average (AV)

ANTENNA POLARITY & TEST DISTANCE: VERTICAL AT 3 M

NO.	FREQ. (MHz)	EMISSION LEVEL (dBuV/m)	LIMIT (dBuV/m)	MARGIN (dB)	ANTENNA HEIGHT (m)	TABLE ANGLE (Degree)	RAW VALUE (dBuV)	CORRECTION FACTOR (dB/m)
1	2390.00	55.0 PK	74.0	-19.0	1.48 V	274	57.1	-2.1
2	2390.00	43.0 AV	54.0	-11.0	1.48 V	274	45.1	-2.1
3	*2412.00	107.0 PK			1.48 V	274	109.0	-2.0
4	*2412.00	104.7 AV			1.48 V	274	106.7	-2.0

REMARKS:

1. Emission Level(dBuV/m) = Raw Value(dBuV) + Correction Factor(dB/m)
2. Correction Factor(dB/m) = Antenna Factor(dB/m) + Cable Factor(dB) – Pre-Amplifier Factor(dB)
3. The other emission levels were very low against the limit.
4. Margin value = Emission Level – Limit value
5. " * ": Fundamental frequency.

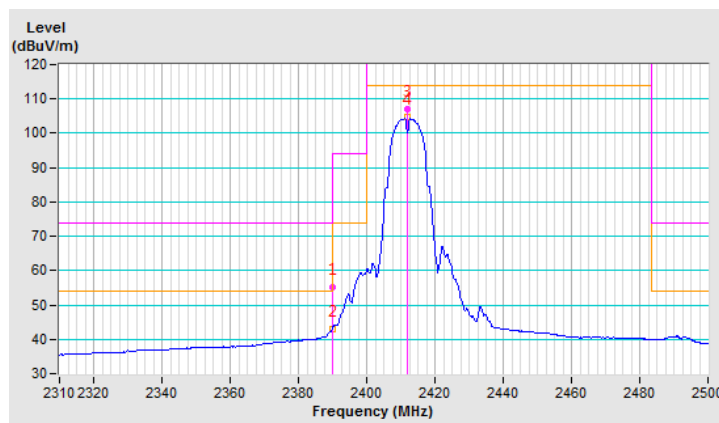

CHANNEL	TX Channel 6	DETECTOR FUNCTION	Peak (PK)
FREQUENCY RANGE	1GHz ~ 25GHz		Average (AV)

ANTENNA POLARITY & TEST DISTANCE: HORIZONTAL AT 3 M

NO.	FREQ. (MHz)	EMISSION LEVEL (dBuV/m)	LIMIT (dBuV/m)	MARGIN (dB)	ANTENNA HEIGHT (m)	TABLE ANGLE (Degree)	RAW VALUE (dBuV)	CORRECTION FACTOR (dB/m)
1	2390.00	49.7 PK	74.0	-24.3	1.04 H	44	51.8	-2.1
2	2390.00	37.4 AV	54.0	-16.6	1.04 H	44	39.5	-2.1
3	*2437.00	106.3 PK			1.04 H	44	108.2	-1.9
4	*2437.00	103.8 AV			1.04 H	44	105.7	-1.9
5	2483.50	51.4 PK	74.0	-22.6	1.04 H	44	53.1	-1.7
6	2483.50	38.1 AV	54.0	-15.9	1.04 H	44	39.8	-1.7

REMARKS:

1. Emission Level(dBuV/m) = Raw Value(dBuV) + Correction Factor(dB/m)
2. Correction Factor(dB/m) = Antenna Factor(dB/m) + Cable Factor(dB) – Pre-Amplifier Factor(dB)
3. The other emission levels were very low against the limit.
4. Margin value = Emission Level – Limit value
5. " * ": Fundamental frequency.

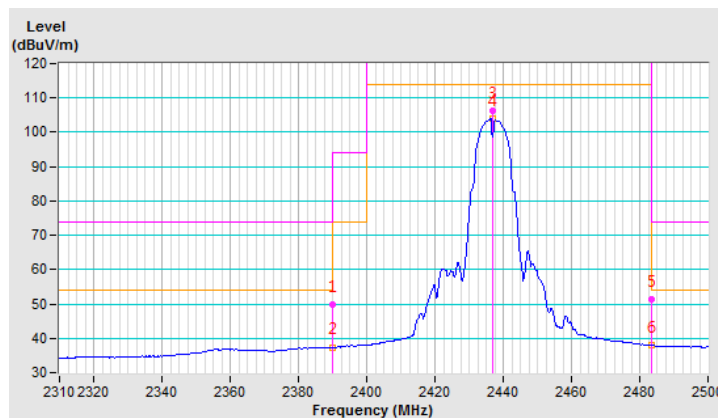

CHANNEL	TX Channel 6	DETECTOR FUNCTION	Peak (PK)
FREQUENCY RANGE	1GHz ~ 25GHz		Average (AV)

ANTENNA POLARITY & TEST DISTANCE: VERTICAL AT 3 M

NO.	FREQ. (MHz)	EMISSION LEVEL (dBuV/m)	LIMIT (dBuV/m)	MARGIN (dB)	ANTENNA HEIGHT (m)	TABLE ANGLE (Degree)	RAW VALUE (dBuV)	CORRECTION FACTOR (dB/m)
1	2390.00	51.4 PK	74.0	-22.6	1.69 V	262	53.5	-2.1
2	2390.00	38.6 AV	54.0	-15.4	1.69 V	262	40.7	-2.1
3	*2437.00	108.1 PK			1.69 V	262	110.0	-1.9
4	*2437.00	105.7 AV			1.69 V	262	107.6	-1.9
5	2483.50	52.5 PK	74.0	-21.5	1.69 V	262	54.2	-1.7
6	2483.50	39.6 AV	54.0	-14.4	1.69 V	262	41.3	-1.7

REMARKS:

1. Emission Level(dBuV/m) = Raw Value(dBuV) + Correction Factor(dB/m)
2. Correction Factor(dB/m) = Antenna Factor(dB/m) + Cable Factor(dB) – Pre-Amplifier Factor(dB)
3. The other emission levels were very low against the limit.
4. Margin value = Emission Level – Limit value
5. " * ": Fundamental frequency.

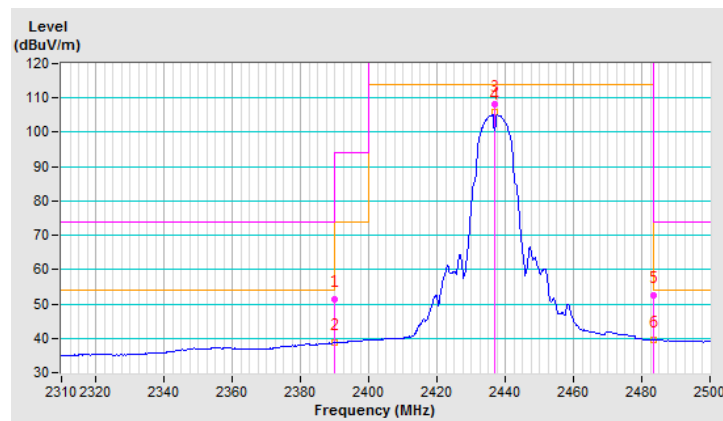

CHANNEL	TX Channel 11	DETECTOR FUNCTION	Peak (PK)
FREQUENCY RANGE	1GHz ~ 25GHz		Average (AV)

ANTENNA POLARITY & TEST DISTANCE: HORIZONTAL AT 3 M

NO.	FREQ. (MHz)	EMISSION LEVEL (dBuV/m)	LIMIT (dBuV/m)	MARGIN (dB)	ANTENNA HEIGHT (m)	TABLE ANGLE (Degree)	RAW VALUE (dBuV)	CORRECTION FACTOR (dB/m)
1	*2462.00	105.9 PK			1.20 H	42	107.7	-1.8
2	*2462.00	103.5 AV			1.20 H	42	105.3	-1.8
3	2483.50	55.4 PK	74.0	-18.6	1.20 H	42	57.1	-1.7
4	2483.50	45.6 AV	54.0	-8.4	1.20 H	42	47.3	-1.7

REMARKS:

1. Emission Level(dBuV/m) = Raw Value(dBuV) + Correction Factor(dB/m)
2. Correction Factor(dB/m) = Antenna Factor(dB/m) + Cable Factor(dB) – Pre-Amplifier Factor(dB)
3. The other emission levels were very low against the limit.
4. Margin value = Emission Level – Limit value
5. " * ": Fundamental frequency.

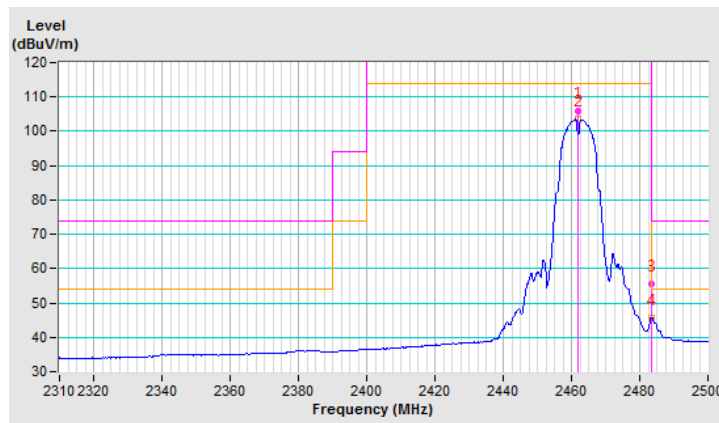

CHANNEL	TX Channel 11	DETECTOR FUNCTION	Peak (PK)
FREQUENCY RANGE	1GHz ~ 25GHz		Average (AV)

ANTENNA POLARITY & TEST DISTANCE: VERTICAL AT 3 M

NO.	FREQ. (MHz)	EMISSION LEVEL (dBuV/m)	LIMIT (dBuV/m)	MARGIN (dB)	ANTENNA HEIGHT (m)	TABLE ANGLE (Degree)	RAW VALUE (dBuV)	CORRECTION FACTOR (dB/m)
1	*2462.00	107.6 PK			1.65 V	264	109.4	-1.8
2	*2462.00	105.0 AV			1.65 V	264	106.8	-1.8
3	2483.50	58.8 PK	74.0	-15.2	1.65 V	N/A	60.5	-1.7
4	2483.50	48.5 AV	54.0	-5.5	1.65 V	N/A	50.2	-1.7

REMARKS:

1. Emission Level(dBuV/m) = Raw Value(dBuV) + Correction Factor(dB/m)
2. Correction Factor(dB/m) = Antenna Factor(dB/m) + Cable Factor(dB) – Pre-Amplifier Factor(dB)
3. The other emission levels were very low against the limit.
4. Margin value = Emission Level – Limit value
5. " * ": Fundamental frequency.

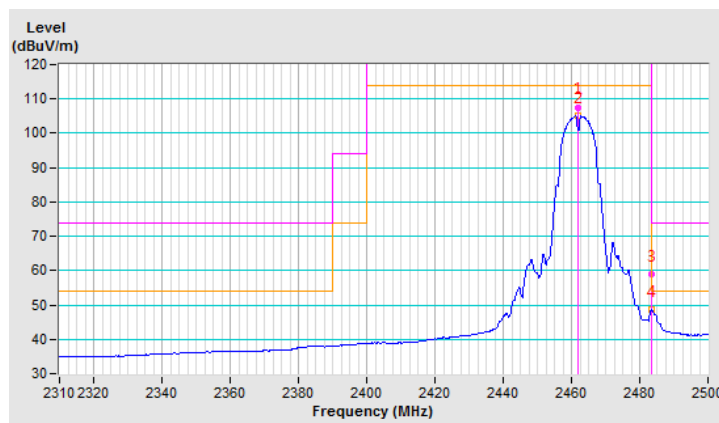

802.11g

CHANNEL	TX Channel 1	DETECTOR FUNCTION	Peak (PK)
FREQUENCY RANGE	1GHz ~ 25GHz		Average (AV)

ANTENNA POLARITY & TEST DISTANCE: HORIZONTAL AT 3 M								
NO.	FREQ. (MHz)	EMISSION LEVEL (dBuV/m)	LIMIT (dBuV/m)	MARGIN (dB)	ANTENNA HEIGHT (m)	TABLE ANGLE (Degree)	RAW VALUE (dBuV)	CORRECTION FACTOR (dB/m)
1	2390.00	67.5 PK	74.0	-6.5	1.34 H	43	69.6	-2.1
2	2390.00	48.8 AV	54.0	-5.2	1.34 H	43	50.9	-2.1
3	*2412.00	107.0 PK			1.34 H	43	109.0	-2.0
4	*2412.00	95.2 AV			1.34 H	43	97.2	-2.0

REMARKS:

1. Emission Level(dBuV/m) = Raw Value(dBuV) + Correction Factor(dB/m)
2. Correction Factor(dB/m) = Antenna Factor(dB/m) + Cable Factor(dB) – Pre-Amplifier Factor(dB)
3. The other emission levels were very low against the limit.
4. Margin value = Emission Level – Limit value
5. " * ": Fundamental frequency.

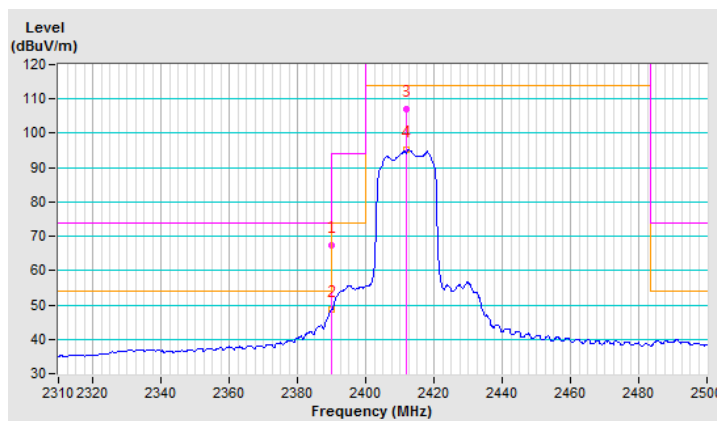

CHANNEL	TX Channel 1	DETECTOR FUNCTION	Peak (PK)
FREQUENCY RANGE	1GHz ~ 25GHz		Average (AV)

ANTENNA POLARITY & TEST DISTANCE: VERTICAL AT 3 M								
NO.	FREQ. (MHz)	EMISSION LEVEL (dBuV/m)	LIMIT (dBuV/m)	MARGIN (dB)	ANTENNA HEIGHT (m)	TABLE ANGLE (Degree)	RAW VALUE (dBuV)	CORRECTION FACTOR (dB/m)
1	2390.00	70.6 PK	74.0	-3.4	1.50 V	273	72.7	-2.1
2	2390.00	49.7 AV	54.0	-4.3	1.50 V	273	51.8	-2.1
3	*2412.00	108.1 PK			1.50 V	273	110.1	-2.0
4	*2412.00	96.2 AV			1.50 V	273	98.2	-2.0

REMARKS:

1. Emission Level(dBuV/m) = Raw Value(dBuV) + Correction Factor(dB/m)
2. Correction Factor(dB/m) = Antenna Factor(dB/m) + Cable Factor(dB) – Pre-Amplifier Factor(dB)
3. The other emission levels were very low against the limit.
4. Margin value = Emission Level – Limit value
5. " * ": Fundamental frequency.

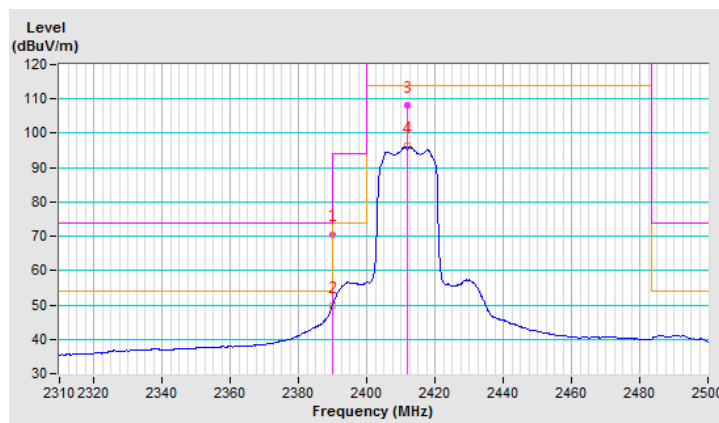

CHANNEL	TX Channel 6	DETECTOR FUNCTION	Peak (PK)
FREQUENCY RANGE	1GHz ~ 25GHz		Average (AV)

ANTENNA POLARITY & TEST DISTANCE: HORIZONTAL AT 3 M

NO.	FREQ. (MHz)	EMISSION LEVEL (dBuV/m)	LIMIT (dBuV/m)	MARGIN (dB)	ANTENNA HEIGHT (m)	TABLE ANGLE (Degree)	RAW VALUE (dBuV)	CORRECTION FACTOR (dB/m)
1	2390.00	67.0 PK	74.0	-7.0	1.04 H	43	69.1	-2.1
2	2390.00	43.3 AV	54.0	-10.7	1.04 H	43	45.4	-2.1
3	*2437.00	111.7 PK			1.04 H	43	113.6	-1.9
4	*2437.00	99.7 AV			1.04 H	43	101.6	-1.9
5	2483.50	63.3 PK	74.0	-10.7	1.04 H	43	65.0	-1.7
6	2483.50	42.1 AV	54.0	-11.9	1.04 H	43	43.8	-1.7

REMARKS:

1. Emission Level(dBuV/m) = Raw Value(dBuV) + Correction Factor(dB/m)
2. Correction Factor(dB/m) = Antenna Factor(dB/m) + Cable Factor(dB) – Pre-Amplifier Factor(dB)
3. The other emission levels were very low against the limit.
4. Margin value = Emission Level – Limit value
5. " * ": Fundamental frequency.

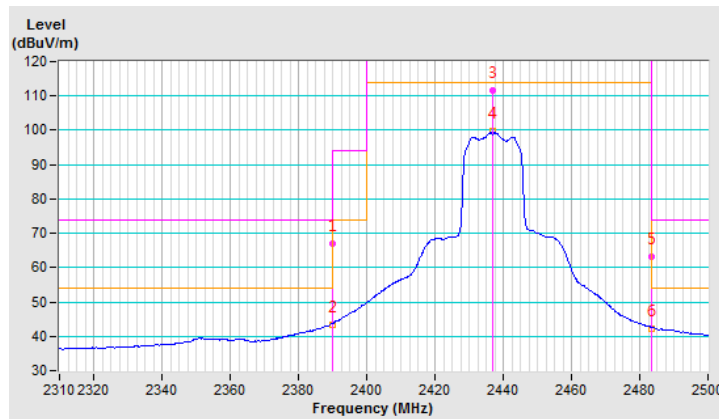

CHANNEL	TX Channel 6	DETECTOR FUNCTION	Peak (PK)
FREQUENCY RANGE	1GHz ~ 25GHz		Average (AV)

ANTENNA POLARITY & TEST DISTANCE: VERTICAL AT 3 M

NO.	FREQ. (MHz)	EMISSION LEVEL (dBuV/m)	LIMIT (dBuV/m)	MARGIN (dB)	ANTENNA HEIGHT (m)	TABLE ANGLE (Degree)	RAW VALUE (dBuV)	CORRECTION FACTOR (dB/m)
1	2390.00	68.1 PK	74.0	-5.9	1.70 V	263	70.2	-2.1
2	2390.00	44.8 AV	54.0	-9.2	1.70 V	263	46.9	-2.1
3	*2437.00	113.8 PK			1.70 V	263	115.7	-1.9
4	*2437.00	102.1 AV			1.70 V	263	104.0	-1.9
5	2483.50	67.5 PK	74.0	-6.5	1.70 V	263	69.2	-1.7
6	2483.50	44.9 AV	54.0	-9.1	1.70 V	263	46.6	-1.7

REMARKS:

1. Emission Level(dBuV/m) = Raw Value(dBuV) + Correction Factor(dB/m)
2. Correction Factor(dB/m) = Antenna Factor(dB/m) + Cable Factor(dB) – Pre-Amplifier Factor(dB)
3. The other emission levels were very low against the limit.
4. Margin value = Emission Level – Limit value
5. " * ": Fundamental frequency.

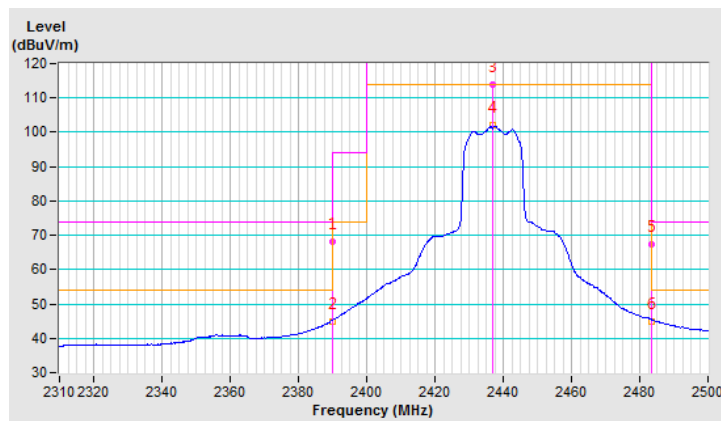

CHANNEL	TX Channel 11	DETECTOR FUNCTION	Peak (PK)
FREQUENCY RANGE	1GHz ~ 25GHz		Average (AV)

ANTENNA POLARITY & TEST DISTANCE: HORIZONTAL AT 3 M

NO.	FREQ. (MHz)	EMISSION LEVEL (dBuV/m)	LIMIT (dBuV/m)	MARGIN (dB)	ANTENNA HEIGHT (m)	TABLE ANGLE (Degree)	RAW VALUE (dBuV)	CORRECTION FACTOR (dB/m)
1	*2462.00	105.5 PK			1.00 H	43	107.3	-1.8
2	*2462.00	94.5 AV			1.00 H	43	96.3	-1.8
3	2483.50	68.7 PK	74.0	-5.3	1.00 H	43	70.4	-1.7
4	2483.50	49.2 AV	54.0	-4.8	1.00 H	43	50.9	-1.7

REMARKS:

1. Emission Level(dBuV/m) = Raw Value(dBuV) + Correction Factor(dB/m)
2. Correction Factor(dB/m) = Antenna Factor(dB/m) + Cable Factor(dB) – Pre-Amplifier Factor(dB)
3. The other emission levels were very low against the limit.
4. Margin value = Emission Level – Limit value
5. " * ": Fundamental frequency.

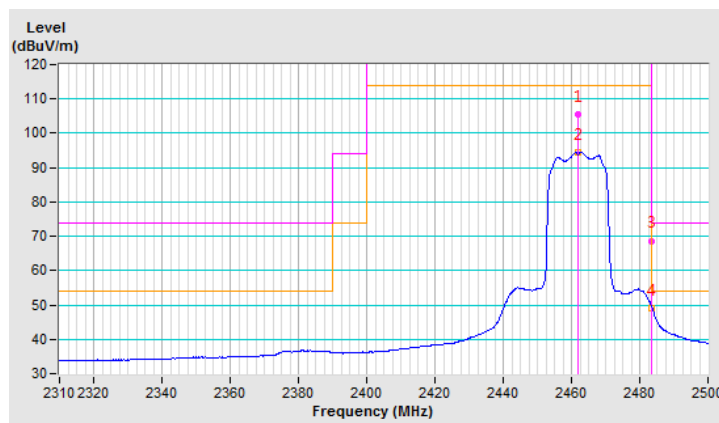

CHANNEL	TX Channel 11	DETECTOR FUNCTION	Peak (PK)
FREQUENCY RANGE	1GHz ~ 25GHz		Average (AV)

ANTENNA POLARITY & TEST DISTANCE: VERTICAL AT 3 M

NO.	FREQ. (MHz)	EMISSION LEVEL (dBuV/m)	LIMIT (dBuV/m)	MARGIN (dB)	ANTENNA HEIGHT (m)	TABLE ANGLE (Degree)	RAW VALUE (dBuV)	CORRECTION FACTOR (dB/m)
1	*2462.00	106.6 PK			1.70 V	263	108.4	-1.8
2	*2462.00	95.8 AV			1.70 V	263	97.6	-1.8
3	2483.50	71.7 PK	74.0	-2.3	1.70 V	263	73.4	-1.7
4	2483.50	51.1 AV	54.0	-2.9	1.70 V	263	52.8	-1.7

REMARKS:

1. Emission Level(dBuV/m) = Raw Value(dBuV) + Correction Factor(dB/m)
2. Correction Factor(dB/m) = Antenna Factor(dB/m) + Cable Factor(dB) – Pre-Amplifier Factor(dB)
3. The other emission levels were very low against the limit.
4. Margin value = Emission Level – Limit value
5. " * ": Fundamental frequency.

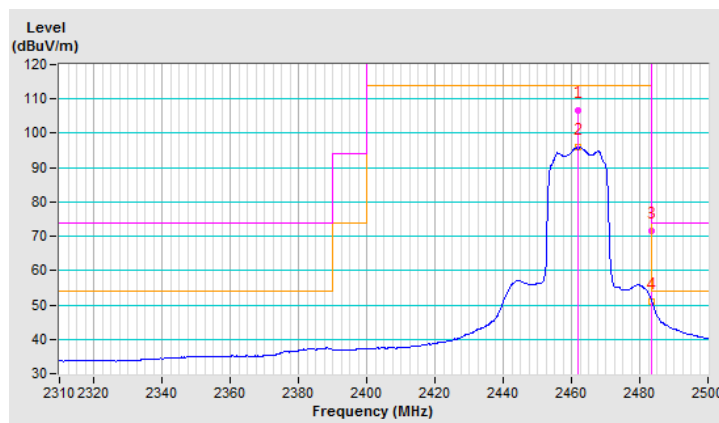

2TX

802.11n (HT20)

CHANNEL	TX Channel 1	DETECTOR FUNCTION	Peak (PK)
FREQUENCY RANGE	1GHz ~ 25GHz		Average (AV)

ANTENNA POLARITY & TEST DISTANCE: HORIZONTAL AT 3 M

NO.	FREQ. (MHz)	EMISSION LEVEL (dBuV/m)	LIMIT (dBuV/m)	MARGIN (dB)	ANTENNA HEIGHT (m)	TABLE ANGLE (Degree)	RAW VALUE (dBuV)	CORRECTION FACTOR (dB/m)
1	2390.00	69.6 PK	74.0	-4.4	2.73 H	31	71.7	-2.1
2	2390.00	50.9 AV	54.0	-3.1	2.73 H	31	53.0	-2.1
3	*2412.00	107.3 PK			2.73 H	31	109.3	-2.0
4	*2412.00	97.2 AV			2.73 H	31	99.2	-2.0

REMARKS:

1. Emission Level(dBuV/m) = Raw Value(dBuV) + Correction Factor(dB/m)
2. Correction Factor(dB/m) = Antenna Factor(dB/m) + Cable Factor(dB) – Pre-Amplifier Factor(dB)
3. The other emission levels were very low against the limit.
4. Margin value = Emission Level – Limit value
5. " * " : Fundamental frequency.

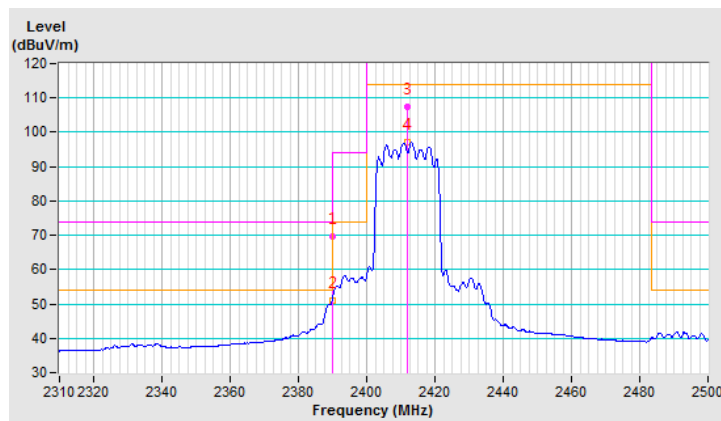

CHANNEL	TX Channel 1	DETECTOR FUNCTION	Peak (PK)
FREQUENCY RANGE	1GHz ~ 25GHz		Average (AV)

ANTENNA POLARITY & TEST DISTANCE: VERTICAL AT 3 M

NO.	FREQ. (MHz)	EMISSION LEVEL (dBuV/m)	LIMIT (dBuV/m)	MARGIN (dB)	ANTENNA HEIGHT (m)	TABLE ANGLE (Degree)	RAW VALUE (dBuV)	CORRECTION FACTOR (dB/m)
1	2390.00	71.2 PK	74.0	-2.8	1.44 V	272	73.3	-2.1
2	2390.00	53.4 AV	54.0	-0.6	1.44 V	272	55.5	-2.1
3	*2412.00	108.8 PK			1.44 V	272	110.8	-2.0
4	*2412.00	99.8 AV			1.44 V	272	101.8	-2.0

REMARKS:

1. Emission Level(dBuV/m) = Raw Value(dBuV) + Correction Factor(dB/m)
2. Correction Factor(dB/m) = Antenna Factor(dB/m) + Cable Factor(dB) – Pre-Amplifier Factor(dB)
3. The other emission levels were very low against the limit.
4. Margin value = Emission Level – Limit value
5. " * ": Fundamental frequency.

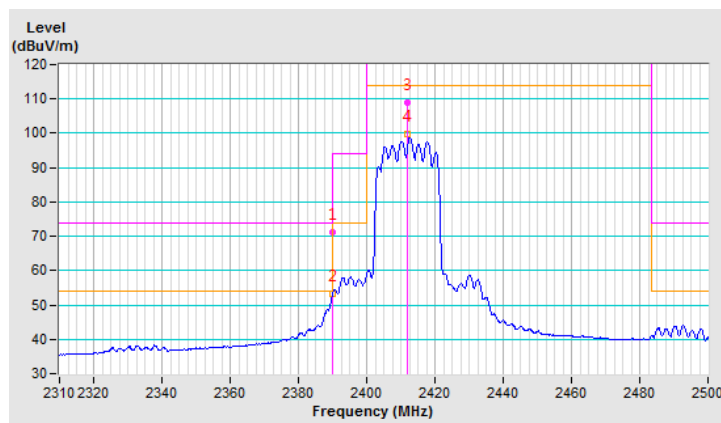

CHANNEL	TX Channel 6	DETECTOR FUNCTION	Peak (PK)
FREQUENCY RANGE	1GHz ~ 25GHz		Average (AV)

ANTENNA POLARITY & TEST DISTANCE: HORIZONTAL AT 3 M

NO.	FREQ. (MHz)	EMISSION LEVEL (dBuV/m)	LIMIT (dBuV/m)	MARGIN (dB)	ANTENNA HEIGHT (m)	TABLE ANGLE (Degree)	RAW VALUE (dBuV)	CORRECTION FACTOR (dB/m)
1	2390.00	65.6 PK	74.0	-8.4	2.71 H	34	67.7	-2.1
2	2390.00	44.0 AV	54.0	-10.0	2.71 H	34	46.1	-2.1
3	*2437.00	111.9 PK			2.71 H	34	113.8	-1.9
4	*2437.00	101.8 AV			2.71 H	34	103.7	-1.9
5	2483.50	66.8 PK	74.0	-7.2	2.71 H	34	68.5	-1.7
6	2483.50	41.8 AV	54.0	-12.2	2.71 H	34	43.5	-1.7

REMARKS:

1. Emission Level(dBuV/m) = Raw Value(dBuV) + Correction Factor(dB/m)
2. Correction Factor(dB/m) = Antenna Factor(dB/m) + Cable Factor(dB) – Pre-Amplifier Factor(dB)
3. The other emission levels were very low against the limit.
4. Margin value = Emission Level – Limit value
5. " * ": Fundamental frequency.

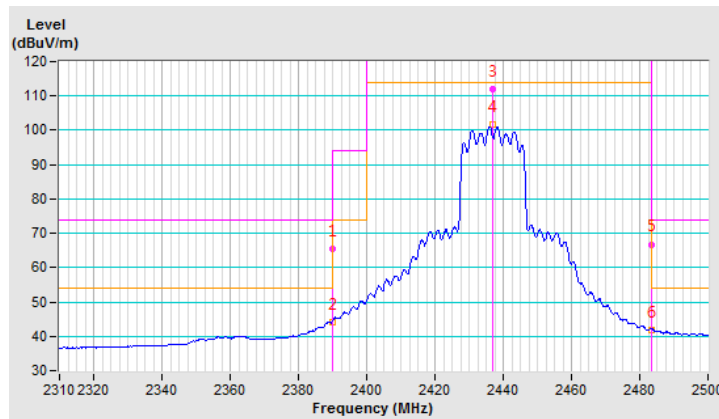

CHANNEL	TX Channel 6	DETECTOR FUNCTION	Peak (PK)
FREQUENCY RANGE	1GHz ~ 25GHz		Average (AV)

ANTENNA POLARITY & TEST DISTANCE: VERTICAL AT 3 M

NO.	FREQ. (MHz)	EMISSION LEVEL (dBuV/m)	LIMIT (dBuV/m)	MARGIN (dB)	ANTENNA HEIGHT (m)	TABLE ANGLE (Degree)	RAW VALUE (dBuV)	CORRECTION FACTOR (dB/m)
1	2390.00	65.8 PK	74.0	-8.2	1.26 V	270	67.9	-2.1
2	2390.00	45.2 AV	54.0	-8.8	1.26 V	270	47.3	-2.1
3	*2437.00	113.9 PK			1.26 V	270	115.8	-1.9
4	*2437.00	104.1 AV			1.26 V	270	106.0	-1.9
5	2483.50	69.3 PK	74.0	-4.7	1.26 V	270	71.0	-1.7
6	2483.50	46.0 AV	54.0	-8.0	1.26 V	270	47.7	-1.7

REMARKS:

1. Emission Level(dBuV/m) = Raw Value(dBuV) + Correction Factor(dB/m)
2. Correction Factor(dB/m) = Antenna Factor(dB/m) + Cable Factor(dB) – Pre-Amplifier Factor(dB)
3. The other emission levels were very low against the limit.
4. Margin value = Emission Level – Limit value
5. " * ": Fundamental frequency.

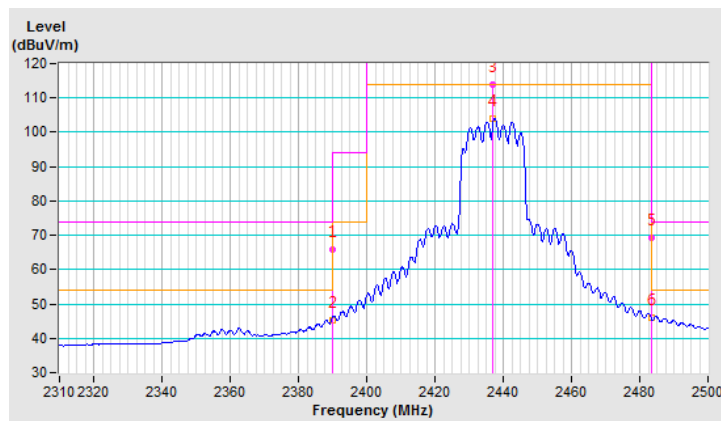

CHANNEL	TX Channel 11	DETECTOR FUNCTION	Peak (PK)
FREQUENCY RANGE	1GHz ~ 25GHz		Average (AV)

ANTENNA POLARITY & TEST DISTANCE: HORIZONTAL AT 3 M

NO.	FREQ. (MHz)	EMISSION LEVEL (dBuV/m)	LIMIT (dBuV/m)	MARGIN (dB)	ANTENNA HEIGHT (m)	TABLE ANGLE (Degree)	RAW VALUE (dBuV)	CORRECTION FACTOR (dB/m)
1	*2462.00	106.5 PK			2.37 H	34	108.3	-1.8
2	*2462.00	96.3 AV			2.37 H	34	98.1	-1.8
3	2483.50	70.7 PK	74.0	-3.3	2.37 H	34	72.4	-1.7
4	2483.50	51.7 AV	54.0	-2.3	2.37 H	34	53.4	-1.7

REMARKS:

1. Emission Level(dBuV/m) = Raw Value(dBuV) + Correction Factor(dB/m)
2. Correction Factor(dB/m) = Antenna Factor(dB/m) + Cable Factor(dB) – Pre-Amplifier Factor(dB)
3. The other emission levels were very low against the limit.
4. Margin value = Emission Level – Limit value
5. " * ": Fundamental frequency.

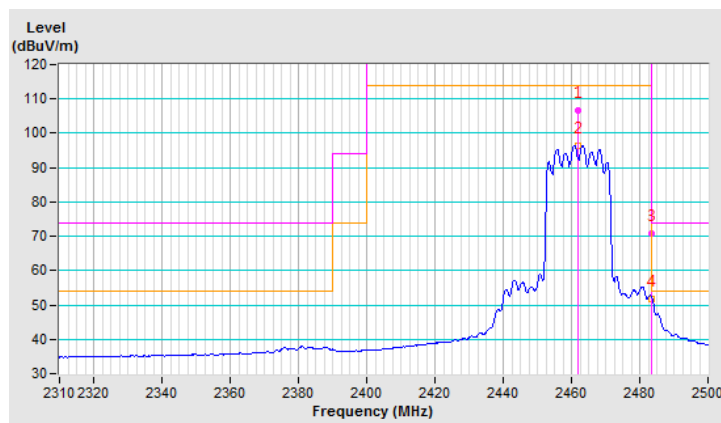

CHANNEL	TX Channel 11	DETECTOR FUNCTION	Peak (PK)
FREQUENCY RANGE	1GHz ~ 25GHz		Average (AV)

ANTENNA POLARITY & TEST DISTANCE: VERTICAL AT 3 M

NO.	FREQ. (MHz)	EMISSION LEVEL (dBuV/m)	LIMIT (dBuV/m)	MARGIN (dB)	ANTENNA HEIGHT (m)	TABLE ANGLE (Degree)	RAW VALUE (dBuV)	CORRECTION FACTOR (dB/m)
1	*2462.00	108.1 PK			1.33 V	303	109.9	-1.8
2	*2462.00	98.1 AV			1.33 V	303	99.9	-1.8
3	2483.50	72.4 PK	74.0	-1.6	1.33 V	303	74.1	-1.7
4	2483.50	53.8 AV	54.0	-0.2	1.33 V	303	55.5	-1.7

REMARKS:

1. Emission Level(dBuV/m) = Raw Value(dBuV) + Correction Factor(dB/m)
2. Correction Factor(dB/m) = Antenna Factor(dB/m) + Cable Factor(dB) – Pre-Amplifier Factor(dB)
3. The other emission levels were very low against the limit.
4. Margin value = Emission Level – Limit value
5. " * ": Fundamental frequency.

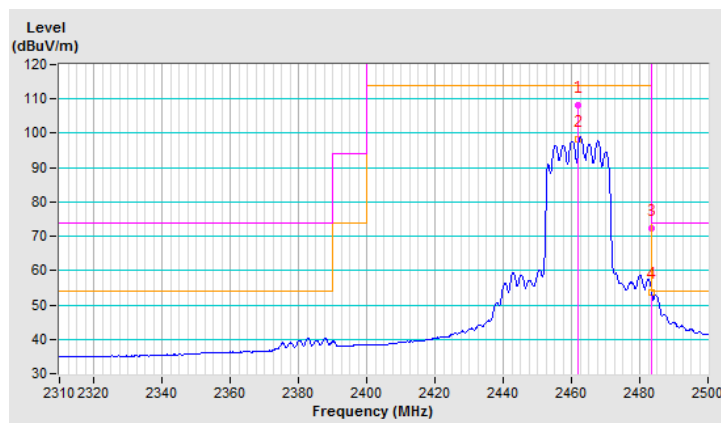

802.11n (HT40)

CHANNEL	TX Channel 3	DETECTOR FUNCTION	Peak (PK)
FREQUENCY RANGE	1GHz ~ 25GHz		Average (AV)

ANTENNA POLARITY & TEST DISTANCE: HORIZONTAL AT 3 M

NO.	FREQ. (MHz)	EMISSION LEVEL (dBuV/m)	LIMIT (dBuV/m)	MARGIN (dB)	ANTENNA HEIGHT (m)	TABLE ANGLE (Degree)	RAW VALUE (dBuV)	CORRECTION FACTOR (dB/m)
1	2390.00	69.3 PK	74.0	-4.7	2.42 H	34	71.4	-2.1
2	2390.00	49.2 AV	54.0	-4.8	2.42 H	34	51.3	-2.1
3	*2422.00	102.0 PK			2.42 H	34	104.1	-2.1
4	*2422.00	91.6 AV			2.42 H	34	93.7	-2.1

REMARKS:

1. Emission Level(dBuV/m) = Raw Value(dBuV) + Correction Factor(dB/m)
2. Correction Factor(dB/m) = Antenna Factor(dB/m) + Cable Factor(dB) – Pre-Amplifier Factor(dB)
3. The other emission levels were very low against the limit.
4. Margin value = Emission Level – Limit value
5. " * ": Fundamental frequency.

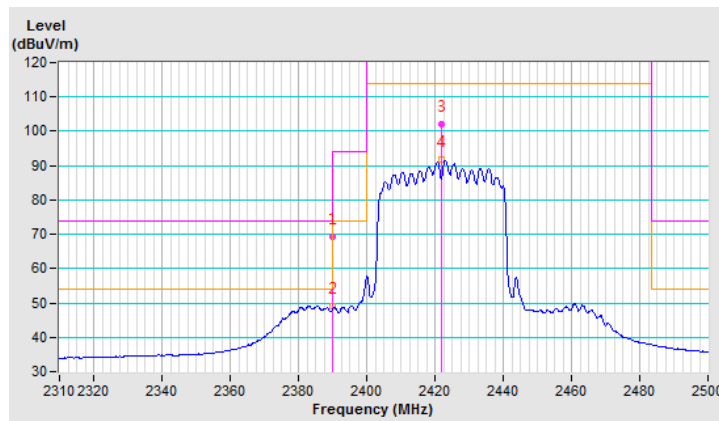

CHANNEL	TX Channel 3	DETECTOR FUNCTION	Peak (PK)
FREQUENCY RANGE	1GHz ~ 25GHz		Average (AV)

ANTENNA POLARITY & TEST DISTANCE: VERTICAL AT 3 M

NO.	FREQ. (MHz)	EMISSION LEVEL (dBuV/m)	LIMIT (dBuV/m)	MARGIN (dB)	ANTENNA HEIGHT (m)	TABLE ANGLE (Degree)	RAW VALUE (dBuV)	CORRECTION FACTOR (dB/m)
1	2390.00	71.0 PK	74.0	-3.0	1.15 V	301	73.1	-2.1
2	2390.00	52.0 AV	54.0	-2.0	1.15 V	301	54.1	-2.1
3	*2422.00	104.5 PK			1.15 V	301	106.6	-2.1
4	*2422.00	93.4 AV			1.15 V	301	95.5	-2.1

REMARKS:

1. Emission Level(dBuV/m) = Raw Value(dBuV) + Correction Factor(dB/m)
2. Correction Factor(dB/m) = Antenna Factor(dB/m) + Cable Factor(dB) – Pre-Amplifier Factor(dB)
3. The other emission levels were very low against the limit.
4. Margin value = Emission Level – Limit value
5. " * ": Fundamental frequency.

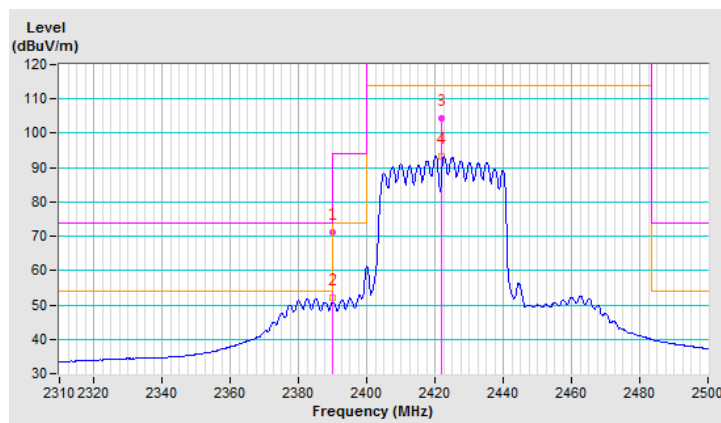

CHANNEL	TX Channel 6	DETECTOR FUNCTION	Peak (PK)
FREQUENCY RANGE	1GHz ~ 25GHz		Average (AV)

ANTENNA POLARITY & TEST DISTANCE: HORIZONTAL AT 3 M

NO.	FREQ. (MHz)	EMISSION LEVEL (dBuV/m)	LIMIT (dBuV/m)	MARGIN (dB)	ANTENNA HEIGHT (m)	TABLE ANGLE (Degree)	RAW VALUE (dBuV)	CORRECTION FACTOR (dB/m)
1	2390.00	67.4 PK	74.0	-6.6	2.42 H	35	69.5	-2.1
2	2390.00	47.3 AV	54.0	-6.7	2.42 H	35	49.4	-2.1
3	*2437.00	104.4 PK			2.42 H	35	106.3	-1.9
4	*2437.00	94.2 AV			2.42 H	35	96.1	-1.9
5	2484.00	68.2 PK	74.0	-5.8	2.42 H	35	69.9	-1.7
6	2484.00	47.7 AV	54.0	-6.3	2.42 H	35	49.4	-1.7

REMARKS:

1. Emission Level(dBuV/m) = Raw Value(dBuV) + Correction Factor(dB/m)
2. Correction Factor(dB/m) = Antenna Factor(dB/m) + Cable Factor(dB) – Pre-Amplifier Factor(dB)
3. The other emission levels were very low against the limit.
4. Margin value = Emission Level – Limit value
5. " * ": Fundamental frequency.

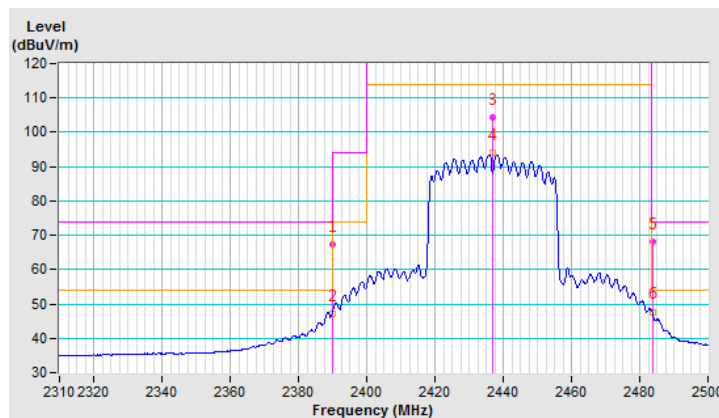

CHANNEL	TX Channel 6	DETECTOR FUNCTION	Peak (PK)
FREQUENCY RANGE	1GHz ~ 25GHz		Average (AV)

ANTENNA POLARITY & TEST DISTANCE: VERTICAL AT 3 M

NO.	FREQ. (MHz)	EMISSION LEVEL (dBuV/m)	LIMIT (dBuV/m)	MARGIN (dB)	ANTENNA HEIGHT (m)	TABLE ANGLE (Degree)	RAW VALUE (dBuV)	CORRECTION FACTOR (dB/m)
1	2390.00	70.6 PK	74.0	-3.4	1.27 V	267	72.7	-2.1
2	2390.00	50.5 AV	54.0	-3.5	1.27 V	267	52.6	-2.1
3	*2437.00	106.5 PK			1.27 V	267	108.4	-1.9
4	*2437.00	96.6 AV			1.27 V	267	98.5	-1.9
5	2484.00	71.4 PK	74.0	-2.6	1.27 V	267	73.1	-1.7
6	2484.00	51.5 AV	54.0	-2.5	1.27 V	267	53.2	-1.7

REMARKS:

1. Emission Level(dBuV/m) = Raw Value(dBuV) + Correction Factor(dB/m)
2. Correction Factor(dB/m) = Antenna Factor(dB/m) + Cable Factor(dB) – Pre-Amplifier Factor(dB)
3. The other emission levels were very low against the limit.
4. Margin value = Emission Level – Limit value
5. " * ": Fundamental frequency.

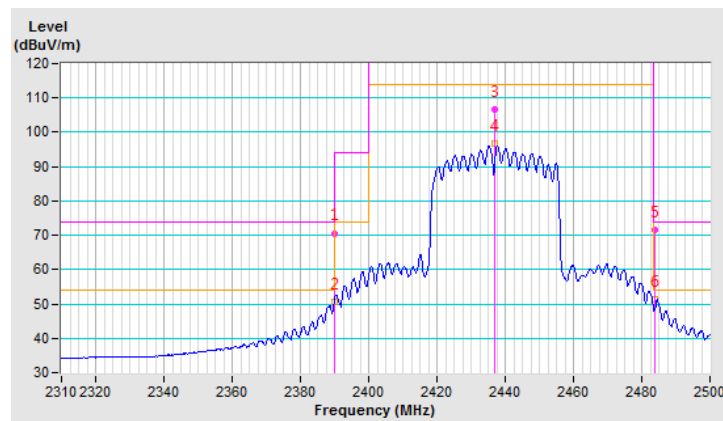

CHANNEL	TX Channel 9	DETECTOR FUNCTION	Peak (PK)
FREQUENCY RANGE	1GHz ~ 25GHz		Average (AV)

ANTENNA POLARITY & TEST DISTANCE: HORIZONTAL AT 3 M

NO.	FREQ. (MHz)	EMISSION LEVEL (dBuV/m)	LIMIT (dBuV/m)	MARGIN (dB)	ANTENNA HEIGHT (m)	TABLE ANGLE (Degree)	RAW VALUE (dBuV)	CORRECTION FACTOR (dB/m)
1	*2452.00	99.9 PK			2.09 H	36	101.7	-1.8
2	*2452.00	89.7 AV			2.09 H	36	91.5	-1.8
3	2483.50	68.8 PK	74.0	-5.2	2.09 H	36	70.5	-1.7
4	2483.50	49.7 AV	54.0	-4.3	2.09 H	36	51.4	-1.7

REMARKS:

1. Emission Level(dBuV/m) = Raw Value(dBuV) + Correction Factor(dB/m)
2. Correction Factor(dB/m) = Antenna Factor(dB/m) + Cable Factor(dB) – Pre-Amplifier Factor(dB)
3. The other emission levels were very low against the limit.
4. Margin value = Emission Level – Limit value
5. " * ": Fundamental frequency.

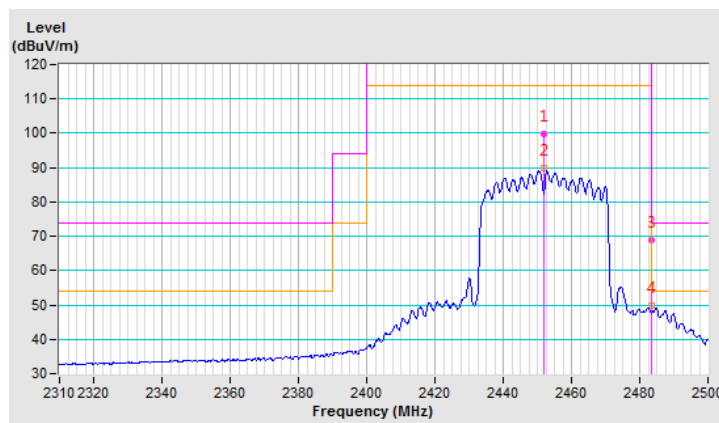

CHANNEL	TX Channel 9	DETECTOR FUNCTION	Peak (PK)
FREQUENCY RANGE	1GHz ~ 25GHz		Average (AV)

ANTENNA POLARITY & TEST DISTANCE: VERTICAL AT 3 M

NO.	FREQ. (MHz)	EMISSION LEVEL (dBuV/m)	LIMIT (dBuV/m)	MARGIN (dB)	ANTENNA HEIGHT (m)	TABLE ANGLE (Degree)	RAW VALUE (dBuV)	CORRECTION FACTOR (dB/m)
1	*2452.00	104.0 PK			1.04 V	269	105.8	-1.8
2	*2452.00	93.1 AV			1.04 V	269	94.9	-1.8
3	2483.50	72.0 PK	74.0	-2.0	1.04 V	269	73.7	-1.7
4	2483.50	53.6 AV	54.0	-0.4	1.04 V	269	55.3	-1.7

REMARKS:

1. Emission Level(dBuV/m) = Raw Value(dBuV) + Correction Factor(dB/m)
2. Correction Factor(dB/m) = Antenna Factor(dB/m) + Cable Factor(dB) – Pre-Amplifier Factor(dB)
3. The other emission levels were very low against the limit.
4. Margin value = Emission Level – Limit value
5. " * ": Fundamental frequency.

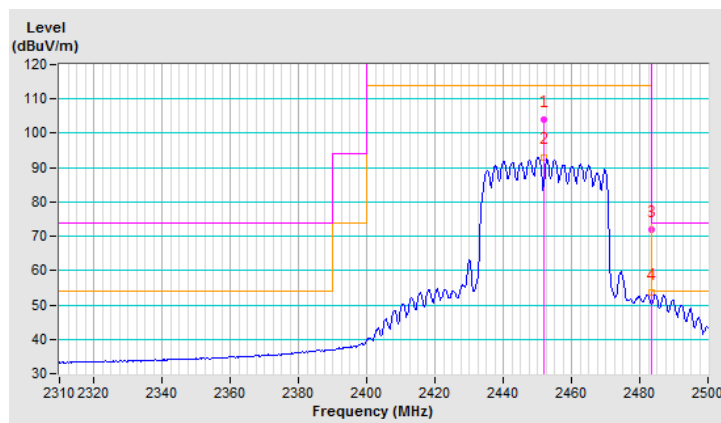

4.7.8 Test Results of Band Edge and Emissions not in Restricted Bands

Below 30dB of the highest emissions level of operating band (in 100kHz Resolution Bandwidth).

802.11b

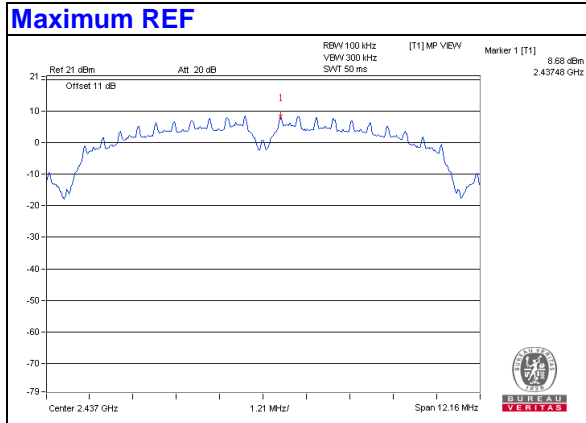

CH 1

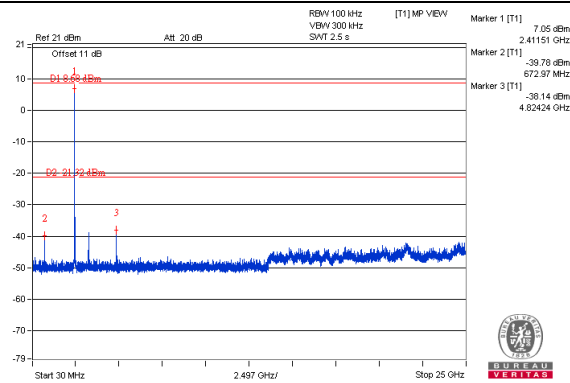

CH 6

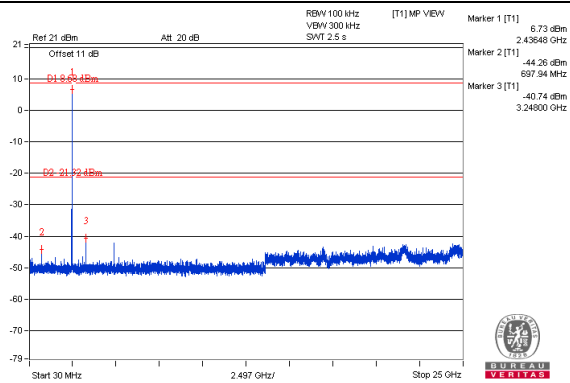

CH 11

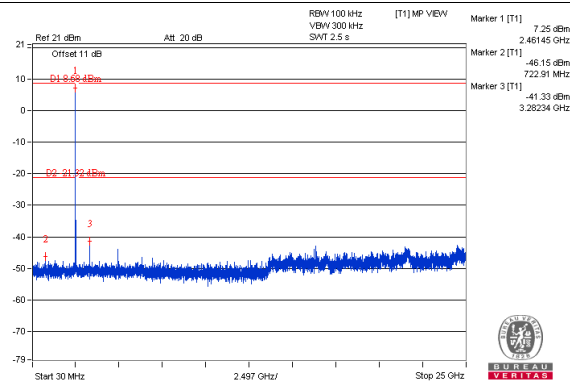

CH 1 Band edge

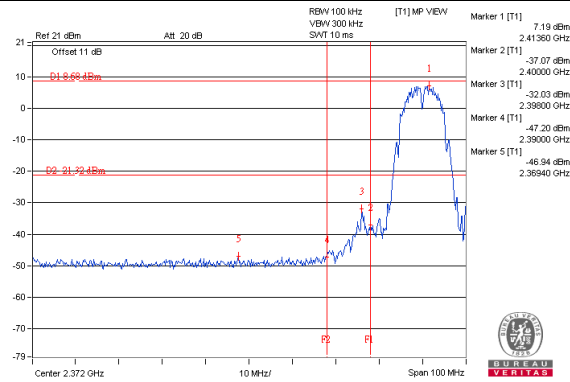

CH 11 Band edge

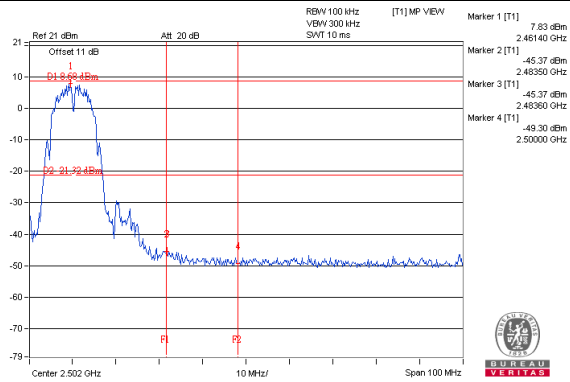

802.11g:

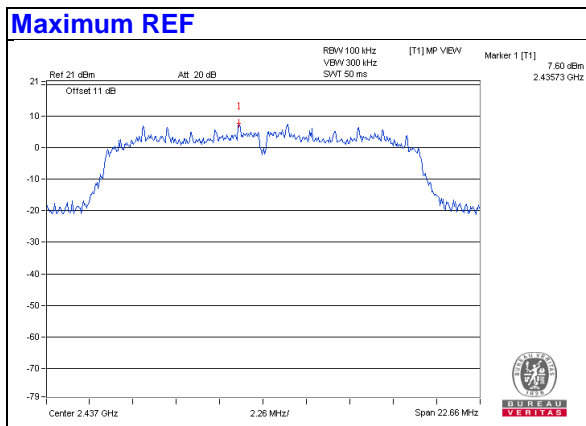

Chain 1

CH 1

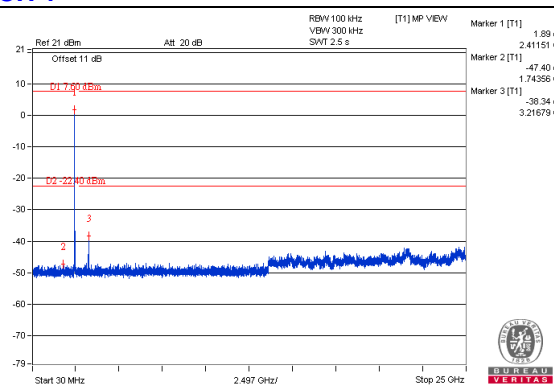

CH 6

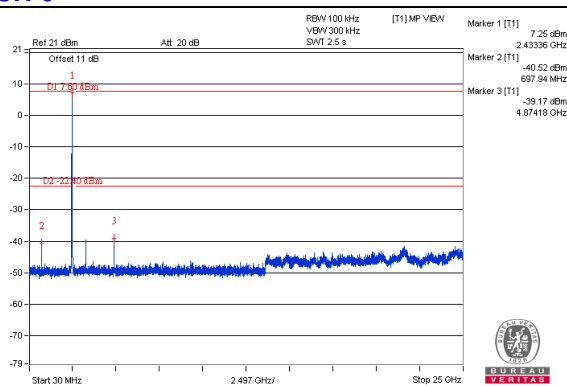

CH 11

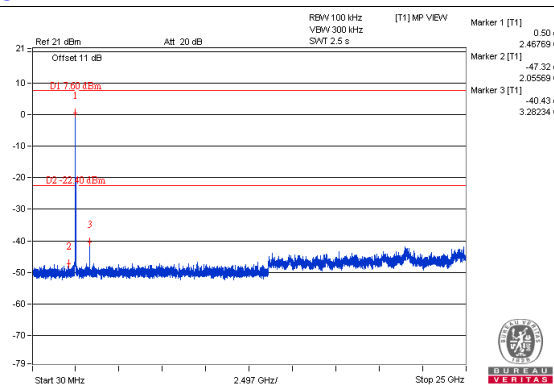

CH 1 Band edge

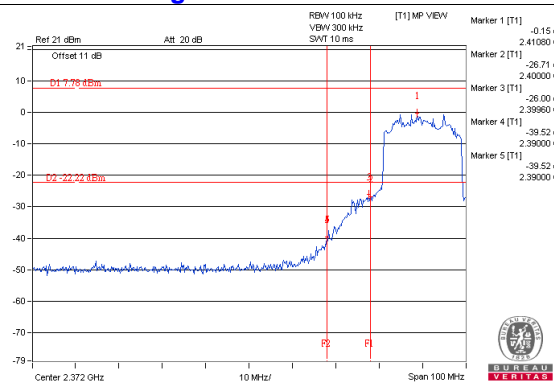

CH 11 Band edge

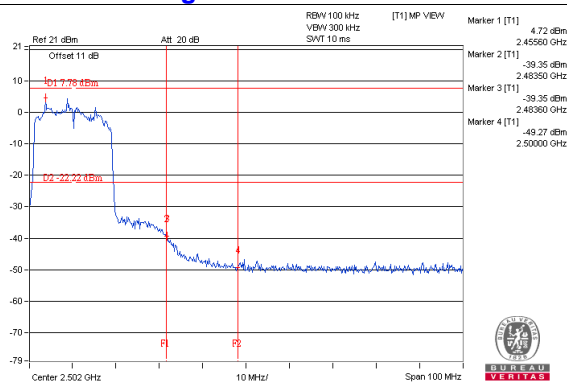

802.11n (20MHz) – 2TX:

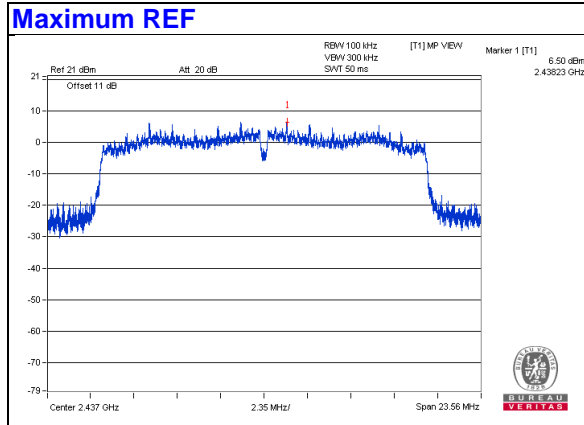

Chain 1

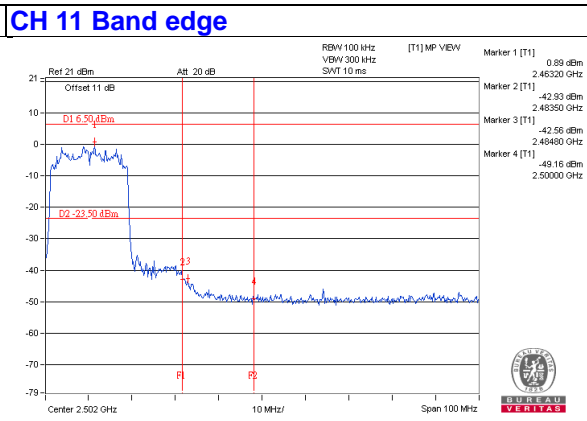
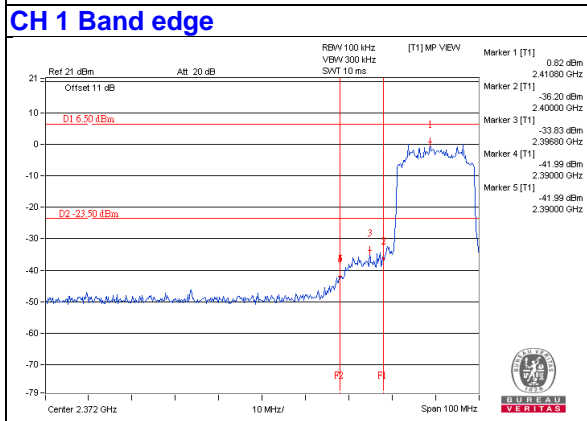
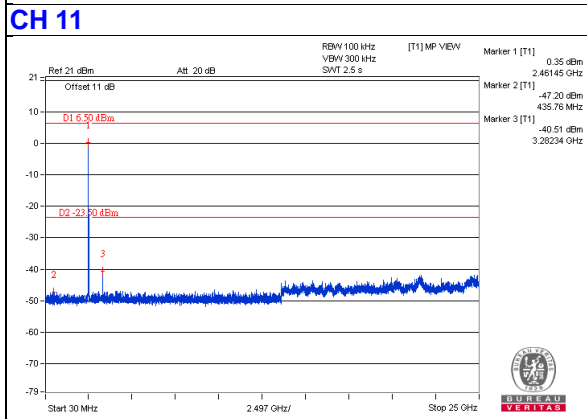
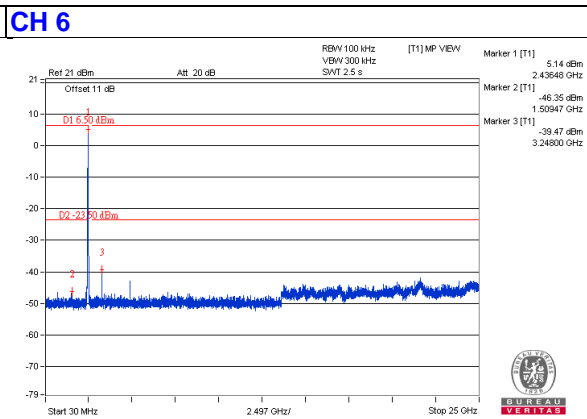
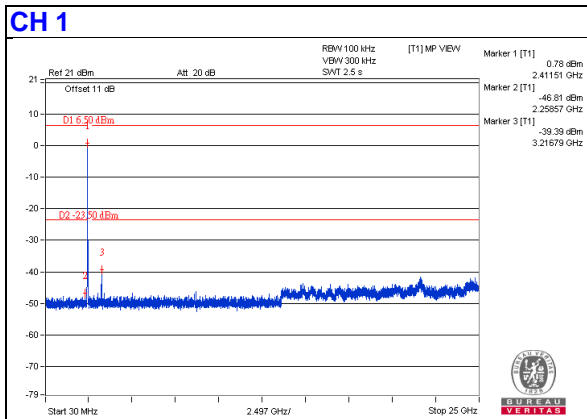

Chain 2

CH 1

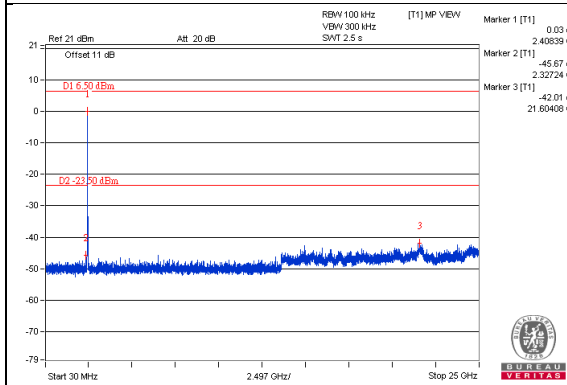

CH 6

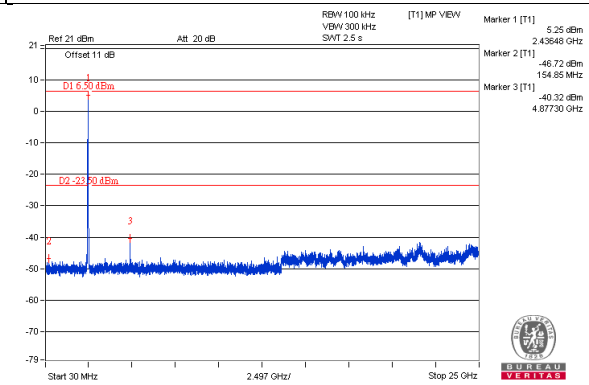

CH 11

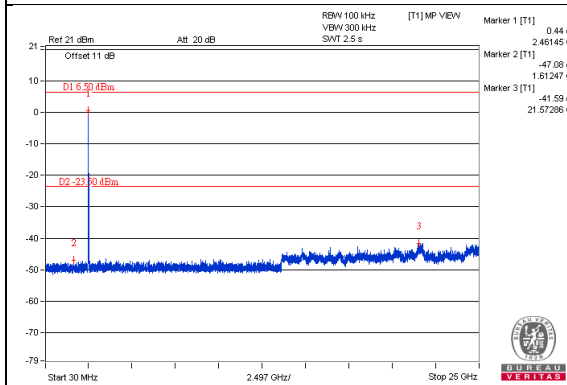

CH 11 Band edge

CH 1 Band edge

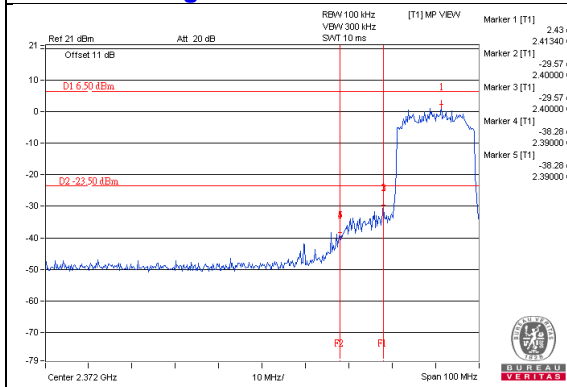

CH 11 Band edge

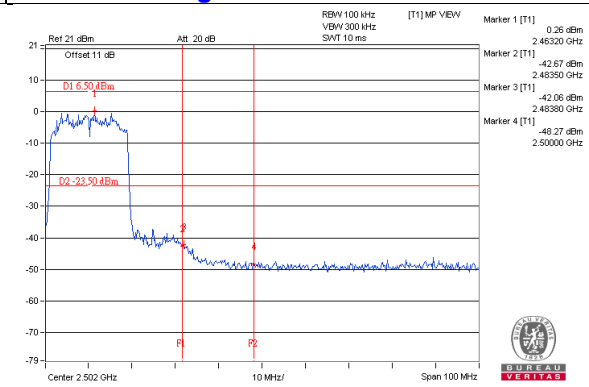

802.11n (40MHz) – 2TX:

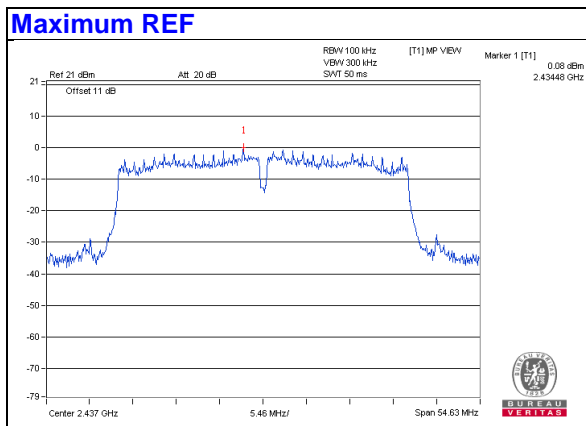

Chain 1

CH 3

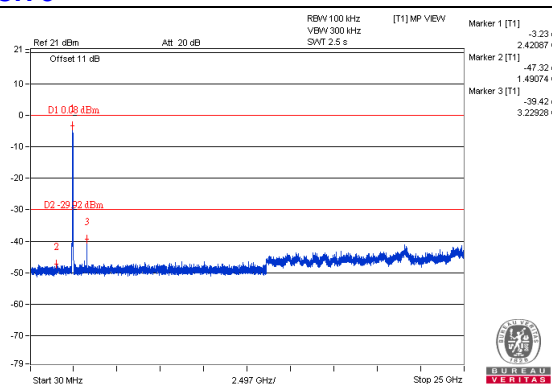

CH 6

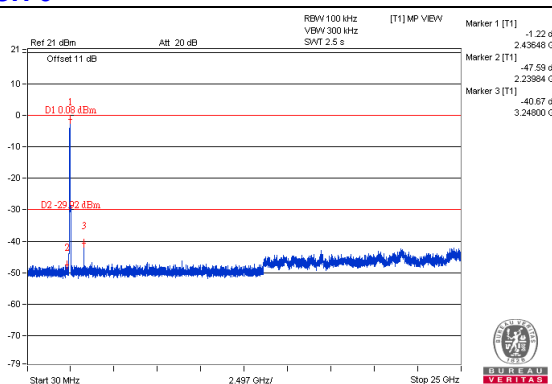

CH 9

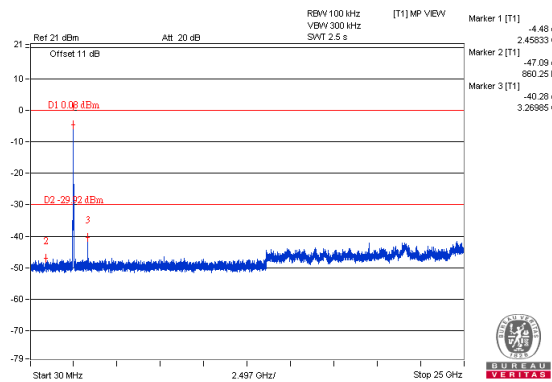

CH 3 Band edge

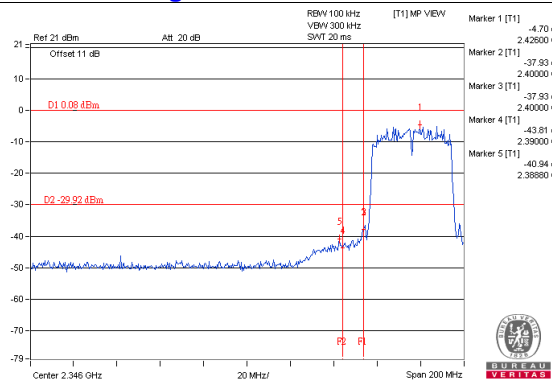

CH 9 Band edge

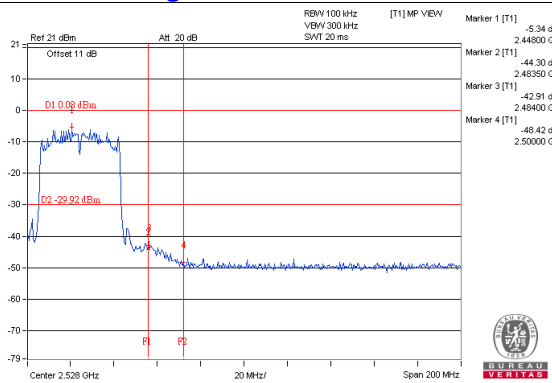

Chain 2

CH 3

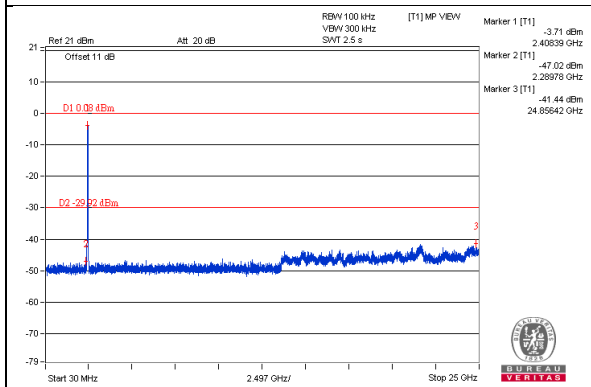

CH 6

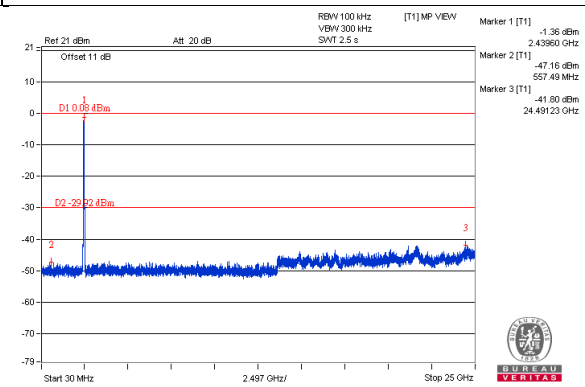

CH 9

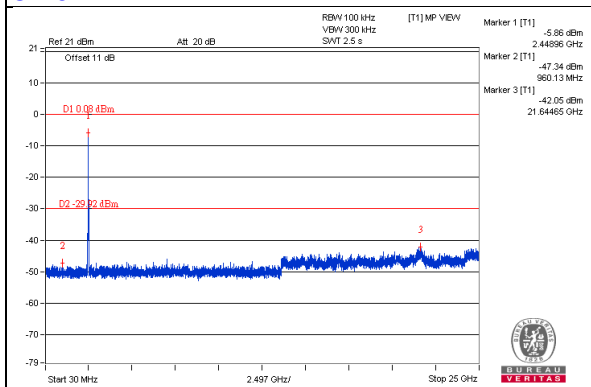

CH 3 Band edge

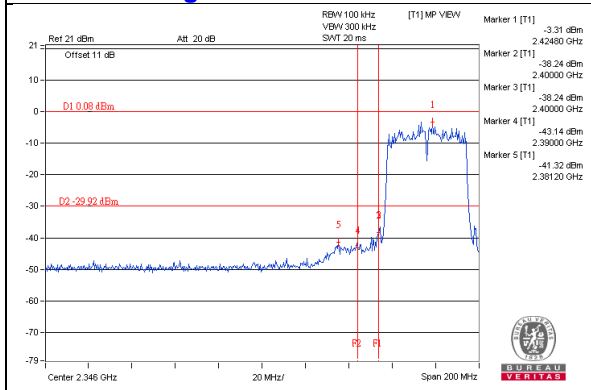

CH 9 Band edge

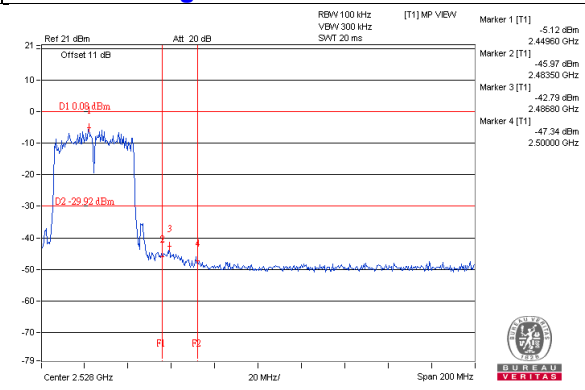

4.8 List of Test Instruments

DESCRIPTION & MANUFACTURER	MODEL NO.	SERIAL NO.	CALIBRATED DATE	CALIBRATED UNTIL
Test Receiver R&S	ESCS 30	847124/029	Oct. 24, 2016	Oct. 23, 2017
Line-Impedance Stabilization Network (for EUT) R&S	ESH3-Z5	848773/004	Oct. 26, 2016	Oct. 25, 2017
RF Cable	5D-FB	COCCAB-001	Sep. 30, 2016	Sep. 29, 2017
10 dB PAD Mini-Circuits	HAT-10+	CONATT-004	June 20, 2016	June 19, 2017
Software BVADT	BVADT_Cond_ V7.3.7.4	NA	NA	NA

Note:

1. The calibration interval of the above test instruments are 12 months and the calibrations are traceable to NML/ROC and NIST/USA.
2. The test was performed in Shielded Room No. 1.
3. Tested Date: Mar. 16, 2017

DESCRIPTION & MANUFACTURER	MODEL NO.	SERIAL NO.	CALIBRATED DATE	CALIBRATED UNTIL
Test Receiver Keysight	N9038A	MY54450088	July 20, 2016	July 19, 2017
Pre-Amplifier ^(*) EMCI	EMC001340	980142	Jan. 20, 2016	Jan. 19, 2018
Loop Antenna ^(*) Electro-Metrics	EM-6879	264	Dec. 16, 2016	Dec. 15, 2018
RF Cable	NA	LOOPCAB-001 LOOPCAB-002	Jan. 17, 2017	Jan. 16, 2018
Pre-Amplifier Mini-Circuits	ZFL-1000VH2B	AMP-ZFL-01	Nov. 10, 2016	Nov. 09, 2017
Trilog Broadband Antenna SCHWARZBECK	VULB 9168	9168-406	Dec. 13, 2016	Dec. 12, 2017
RF Cable	8D	966-4-1 966-4-2 966-4-3	Apr. 02, 2016	Apr. 01, 2017
Fixed attenuator Mini-Circuits	UNAT-5+	PAD-3m-4-01	Oct. 05, 2016	Oct. 04, 2017
Horn_Antenna SCHWARZBECK	BBHA 9120D	9120D-783	Dec. 27, 2016	Dec. 26, 2017
Pre-Amplifier EMCI	EMC12630SE	980385	Feb. 02, 2017	Feb. 01, 2018
RF Cable	EMC104-SM-SM-2000 EMC104-SM-SM-5000 EMC104-SM-SM-5000	160923 150318 150323	Feb. 02, 2017 Mar. 30, 2016 Mar. 30, 2016	Feb. 01, 2018 Mar. 29, 2017 Mar. 29, 2017
Pre-Amplifier EMCI	EMC184045SE	980387	Feb. 02, 2017	Feb. 01, 2018
Horn_Antenna SCHWARZBECK	BBHA 9170	BBHA9170608	Dec. 15, 2016	Dec. 14, 2017
RF Cable	SUCOFLEX 102	36432/2 36433/2	Jan. 15, 2017	Jan. 14, 2018
Software	ADT_Radiated_V8.7.08	NA	NA	NA
Antenna Tower & Turn Table Max-Full	MF-7802	MF780208410	NA	NA
Boresight Antenna Fixture	FBA-01	FBA-SIP02	NA	NA

Note:

1. The calibration interval of the above test instruments is 12 months and the calibrations are traceable to NML/ROC and NIST/USA.
2. *The calibration interval of the above test instruments is 24 months and the calibrations are traceable to NML/ROC and NIST/USA.
3. The test was performed in 966 Chamber No. 4.
4. The FCC Site Registration No. is 292998
5. The CANADA Site Registration No. is 20331-2
6. Tested Date: Mar. 13 to 16, 2017

DESCRIPTION & MANUFACTURER	MODEL NO.	SERIAL NO.	CALIBRATED DATE	CALIBRATED UNTIL
Spectrum Analyzer R&S	FSV40	100964	June 28, 2016	June 27, 2017
Spectrum Analyzer Agilent	E4446A	MY48250253	Dec. 21, 2016	Dec. 20, 2017
Power meter Anritsu	ML2495A	1014008	May 5, 2016	May 4, 2017
Power sensor Anritsu	MA2411B	0917122	May 5, 2016	May 4, 2017
AC Power Source Extech Electronics	6205	1440452	NA	NA
Temperature & Humidity Chamber Giant Force	GTH-150-40-SP-AR	MAA0812-008	Jan. 11, 2017	Jan. 10, 2018
DC Power Supply Topward	6603D	795558	NA	NA
Digital Multimeter FLUKE	87III	73680266	Nov. 10, 2016	Nov. 09, 2017
ESG Vector signal generator Agilent	E4438C	MY45094468/005 506 602 UK6 UNJ	Nov. 25, 2016	Nov. 24, 2017
Mech Switch Absorptive Mini-Circuits	MSP4TA-18+	0140	Mar. 19, 2016	Mar. 18, 2017
FXD ATTEN Mini-Circuits	BW-S3W2+	MN71981	Mar. 19, 2016	Mar. 18, 2017
Software	ADT_RF Test Software V6.6.5.4	NA	NA	NA

- NOTE:**
1. The test was performed in Oven room 2.
 2. The calibration interval of the above test instruments is 12 months and the calibrations are traceable to NML/ROC and NIST/USA.
 3. Tested Date: Mar. 14, 2017

Appendix C. List of test command

Tx

wl -i wl0 up

wl -i wl0 pkteng_stop rx

wl -i wl0 pkteng_stop tx

wl -i wl0 stbc_rx 0

wl -i wl0 mpc 0

wl -i wl0 interference_override 0

wl -i wl0 ssid ""

wl -i wl0 down

wl -i wl0 country MY/3 # setting country code

wl -i wl0 frameburst 1

wl -i wl0 ampdu 1

wl -i wl0 mimo_bw_cap 1

wl -i wl0 bi 65535

wl -i wl0 tempsense_disable 1

wl -i wl0 up

wl -i wl0 down

#wl -i wl0 mimo_txbw 2 # HT20

wl -i wl0 mimo_txbw 4 # HT40

wl -i wl0 band b

wl -i wl0 up

wl -i wl0 isup

wl -i wl0 down

#wl -i wl0 chanspec 11 # HT20 channel 6

wl -i wl0 chanspec 11 # HT40 channel 6 low

wl -i wl0 up

```
#wl -i wl0 nrate -r 1 -s 0      # 11b 1Mbps
#wl -i wl0 nrate -r 11 -s 0     # 11b 11Mbps
#wl -i wl0 nrate -r 6 -s 0     # 11g 54Mbps SISO
#wl -i wl0 nrate -m 0 -s 0     # 11n mcs7 SISO
wl -i wl0 nrate -m 8 -s 0      # 11n mcs0 CDD
wl -i wl0 ssid setRate
wl -i wl0 phy_watchdog 0
wl -i wl0 txchain 3
wl -i wl0 down
#wl -i wl0 rxchain 1          # switch to core 0
#wl -i wl0 rxchain 2          # switch to core 1
#wl -i wl0 rxchain 3          # switch to two streams
wl -i wl0 up
#wl -i wl0 txchain 1          # switch to core 0
#wl -i wl0 txchain 2          # switch to core 1
wl -i wl0 txchain 3          # switch to two streams
#wl -i wl0 txpwr1 -o -q 64    # 64/4=16dBm
wl -i wl0 txpwr1 -1          # reset to default power in SRAM setup
wl -i wl0 ssid txttest
wl -i wl0 isup
wl -i wl0 ssid ""
wl -i wl0 pkteng_start aa:bb:cc:dd:ee:ff tx 50 1868 0
wl -i wl0 curpower
wl -i wl0 phy_forcecal
wl -i wl0 curpower
wl -i wl0 country

##### Rx idle #####
```

```
wl -i wl0 up
wl -i wl0 pkteng_stop rx
wl -i wl0 pkteng_stop tx
wl -i wl0 down
wl -i wl0 country ALL # setting country code
wl -i wl0 ampdu 1
wl -i wl0 mimo_bw_cap 1
wl -i wl0 bi 65535
wl -i wl0 tempsense_disable 1
wl -i wl0 up
wl -i wl0 down
#wl -i wl0 mimo_txbw 2 # HT20
wl -i wl0 mimo_txbw 4 # HT40
wl -i wl0 band b
wl -i wl0 up
wl -i wl0 isup
wl -i wl0 down
#wl -i wl0 chanspec 13 # HT20 channel 6
wl -i wl0 chanspec 9l # HT40 channel 6 low
wl -i wl0 up
#wl -i wl0 nrate -r 1 -s 0 # 11b 1Mbps
#wl -i wl0 nrate -r 11 -s 0 # 11b 11Mbps
#wl -i wl0 nrate -r 54 -s 0 # 11g 54Mbps SISO
#wl -i wl0 nrate -m 7 -s 0 # 11n mcs7 SISO
wl -i wl0 nrate -m 0 -s 1 # 11n mcs7 CDD
wl -i wl0 phy_watchdog 0
wl -i wl0 ssid Rxtest
wl -i wl0 up
```

wl -i wl0 out

wl curpower

root@OpenWrt:~# wl curpower

Power Control: On, HW

Current Channel: 1

BSS Channel: 1

BSS Local Max: 30.0 dBm

BSS Local Constraint: 0.0 dB

Channel Width: 20MHz

User Target: 31.75 dBm

SROM Antgain 2G: 3.25 dB / 3.50 dB

SROM Antgain 5G: 0.0 dB / 0.0 dB

SAR: -

Open loop: Off

Current rate: [MCS15] ht mcs 15 Tx Exp 0 BW 20

Power Adjust: abs 0.0 dB (disabled)

Calibration acc: 0.75 dB

TXChain compensation: txch offset + ch offset

TXChain 1: $1.0 + 0.0 = 1.0$ dB

TXChain 2: $0.50 + 0.25 = 0.75$ dB

NOTE: Regulatory Limits, board limits and target power are for core 0

Use "wl curpower_display_core" to select another one

NOTE: Regulatory limit is conducted -> Antenna gain is ignored

Regulatory Limits:

Rate	Chains 20MHz	
DSSS	1	17.00
OFDM	1	13.25
MCS0_7	1	12.25
VHT8_9SS1	1	12.25
DSSS_MULT11	2	-
OFDM_CDD1	2	12.25
MCS0_7_CDD1	2	12.25
VHT8_9SS1_CDD1	2	12.25
MCS0_7_STBC	2	12.25
VHT8_9SS1_STBC	2	12.25
MCS8_15	2	12.25
VHT8_9SS2	2	12.25
DSSS_MULT12	3	-
OFDM_CDD2	3	-
MCS0_7_CDD2	3	-
VHT8_9SS1_CDD2	3	-
MCS0_7_STBC_SPEXP1	3	-
VHT8_9SS1_STBC_SPEXP1	3	-
MCS8_15_SPEXP1	3	-
VHT8_9SS2_SPEXP1	3	-
MCS16_23	3	-
VHT8_9SS3	3	-

OFDM_TXBF1	2	-
MCS0_7_TXBF1	2	-
VHT8_9SS1_TXBF1	2	-
MCS8_15_TXBF0	2	-
OFDM_TXBF2	3	-
MCS0_7_TXBF2	3	-
VHT8_9SS1_TXBF2	3	-
MCS8_15_TXBF1	3	-
VHT8_9SS2_TXBF1	3	-
MCS16_23_TXBF0	3	-

Core Index: 0

Board Limits:

Rate	Chains 20MHz	
DSSS	1	20.25
OFDM6	1	18.25
OFDM9	1	18.25
OFDM12	1	18.25
OFDM18	1	18.25
OFDM24	1	18.25
OFDM36	1	18.25
OFDM48	1	18.25
OFDM54	1	17.75
MCS0	1	18.25
MCS1	1	18.25
MCS2	1	18.25
MCS3	1	18.25
MCS4	1	18.25

MCS5	1	18.25
MCS6	1	17.75
MCS7	1	17.75
VHT8_9SS1	1	-
DSSS_MULT11	2	20.25
OFDM6_CDD1	2	18.75
OFDM9_CDD1	2	18.75
OFDM12_CDD1	2	18.75
OFDM18_CDD1	2	18.25
OFDM24_CDD1	2	18.25
OFDM36_CDD1	2	18.25
OFDM48_CDD1	2	18.25
OFDM54_CDD1	2	18.25
MCS0_CDD1	2	18.75
MCS1_CDD1	2	18.75
MCS2_CDD1	2	18.25
MCS3_CDD1	2	18.25
MCS4_CDD1	2	18.25
MCS5_CDD1	2	18.25
MCS6_CDD1	2	18.25
MCS7_CDD1	2	17.75
VHT8_9SS1_CDD1	2	-
MCS0_STBC	2	18.75
MCS1_STBC	2	18.75
MCS2_STBC	2	18.25
MCS3_STBC	2	18.25
MCS4_STBC	2	18.25
MCS5_STBC	2	18.25

MCS6_STBC	2	18.25
MCS7_STBC	2	17.75
VHT8_9SS1_STBC	2	-
MCS8	2	18.75
MCS9	2	18.75
MCS10	2	18.25
MCS11	2	18.25
MCS12	2	18.25
MCS13	2	18.25
MCS14	2	18.25
MCS15	2	17.75
VHT8_9SS2	2	-
DSSS_MULT12	3	-
OFDM_CDD2	3	-
MCS0_7_CDD2	3	-
VHT8_9SS1_CDD2	3	-
MCS0_7_STBC_SPEXP1	3	-
VHT8_9SS1_STBC_SPEXP1	3	-
MCS8_15_SPEXP1	3	-
VHT8_9SS2_SPEXP1	3	-
MCS16_23	3	-
VHT8_9SS3	3	-
OFDM_TXBF1	2	-
MCS0_7_TXBF1	2	-
VHT8_9SS1_TXBF1	2	-
MCS8_15_TXBF0	2	-
OFDM_TXBF2	3	-
MCS0_7_TXBF2	3	-

VHT8_9SS1_TXBF2	3	-
MCS8_15_TXBF1	3	-
VHT8_9SS2_TXBF1	3	-
MCS16_23_TXBF0	3	-

Power Targets:

Rate	Chains 20MHz	
DSSS	1	16.25
OFDM	1	11.50
MCS0_7	1	11.50
VHT8_9SS1	1	8.00
DSSS_MULT11	2	8.00
OFDM_CDD1	2	11.50
MCS0_7_CDD1	2	11.50
VHT8_9SS1_CDD1	2	8.00
MCS0_7_STBC	2	11.50
VHT8_9SS1_STBC	2	8.00
MCS8_15	2	11.50
VHT8_9SS2	2	8.00
DSSS_MULT12	3	8.00
OFDM_CDD2	3	8.00
MCS0_7_CDD2	3	8.00
VHT8_9SS1_CDD2	3	8.00
MCS0_7_STBC_SPEXP1	3	8.00
VHT8_9SS1_STBC_SPEXP1	3	8.00
MCS8_15_SPEXP1	3	8.00
VHT8_9SS2_SPEXP1	3	8.00
MCS16_23	3	8.00

VHT8_9SS3	3	8.00
OFDM_TXBF1	2	8.00
MCS0_7_TXBF1	2	8.00
VHT8_9SS1_TXBF1	2	8.00
MCS8_15_TXBF0	2	8.00
OFDM_TXBF2	3	8.00
MCS0_7_TXBF2	3	8.00
VHT8_9SS1_TXBF2	3	8.00
MCS8_15_TXBF1	3	8.00
VHT8_9SS2_TXBF1	3	8.00
MCS16_23_TXBF0	3	8.00

Maximum Power Target among all rates: 16.25 16.25

Last est. power : 0.00 17.00

Power Target for the current rate : 11.50 11.50

Last adjusted est. power : 0.00 17.00

root@OpenWrt:~#

root@OpenWrt:~# wl down

root@OpenWrt:~# wl chanspec 2

Chanspec set to 0x1002

root@OpenWrt:~# wl up

root@OpenWrt:~# wl curpower

Power Control: On, HW

Current Channel: 2

BSS Channel: 2

BSS Local Max: 30.0 dBm

BSS Local Constraint: 0.0 dB

Channel Width: 20MHz

User Target: 31.75 dBm
 SROM Antgain 2G: 3.25 dB / 3.50 dB
 SROM Antgain 5G: 0.0 dB / 0.0 dB
 SAR: -
 Open loop: Off
 Current rate: [MCS15] ht mcs 15 Tx Exp 0 BW 20

 Power Adjust: abs 0.0 dB (disabled)
 Calibration acc: 0.75 dB
 TXChain compensation: txch offset + ch offset

 TXChain 1: 1.0 + 0.0 = 1.0 dB

 TXChain 2: 0.50 + 0.0 = 0.50 dB

NOTE: Regulatory Limits, board limits and target power are for core 0

Use "wl curpower_display_core" to select another one

NOTE: Regulatory limit is conducted -> Antenna gain is ignored

Regulatory Limits:

Rate	Chains 20MHz	
DSSS	1	17.00
OFDM	1	13.25
MCS0_7	1	12.25
VHT8_9SS1	1	12.25
DSSS_MULT11	2	-
OFDM_CDD1	2	12.25

MCS0_7_CDD1	2	12.25
VHT8_9SS1_CDD1	2	12.25
MCS0_7_STBC	2	12.25
VHT8_9SS1_STBC	2	12.25
MCS8_15	2	12.25
VHT8_9SS2	2	12.25
DSSS_MULT12	3	-
OFDM_CDD2	3	-
MCS0_7_CDD2	3	-
VHT8_9SS1_CDD2	3	-
MCS0_7_STBC_SPEXP1	3	-
VHT8_9SS1_STBC_SPEXP1	3	-
MCS8_15_SPEXP1	3	-
VHT8_9SS2_SPEXP1	3	-
MCS16_23	3	-
VHT8_9SS3	3	-
OFDM_TXBF1	2	-
MCS0_7_TXBF1	2	-
VHT8_9SS1_TXBF1	2	-
MCS8_15_TXBF0	2	-
OFDM_TXBF2	3	-
MCS0_7_TXBF2	3	-
VHT8_9SS1_TXBF2	3	-
MCS8_15_TXBF1	3	-
VHT8_9SS2_TXBF1	3	-
MCS16_23_TXBF0	3	-

Core Index: 0

Board Limits:

Rate	Chains 20MHz	
DSSS	1	20.25
OFDM6	1	18.25
OFDM9	1	18.25
OFDM12	1	18.25
OFDM18	1	18.25
OFDM24	1	18.25
OFDM36	1	18.25
OFDM48	1	18.25
OFDM54	1	17.75
MCS0	1	18.25
MCS1	1	18.25
MCS2	1	18.25
MCS3	1	18.25
MCS4	1	18.25
MCS5	1	18.25
MCS6	1	17.75
MCS7	1	17.75
VHT8_9SS1	1	-
DSSS_MULT11	2	20.25
OFDM6_CDD1	2	18.75
OFDM9_CDD1	2	18.75
OFDM12_CDD1	2	18.75
OFDM18_CDD1	2	18.25
OFDM24_CDD1	2	18.25
OFDM36_CDD1	2	18.25
OFDM48_CDD1	2	18.25

OFDM54_CDD1	2	18.25
MCS0_CDD1	2	18.75
MCS1_CDD1	2	18.75
MCS2_CDD1	2	18.25
MCS3_CDD1	2	18.25
MCS4_CDD1	2	18.25
MCS5_CDD1	2	18.25
MCS6_CDD1	2	18.25
MCS7_CDD1	2	17.75
VHT8_9SS1_CDD1	2	-
MCS0_STBC	2	18.75
MCS1_STBC	2	18.75
MCS2_STBC	2	18.25
MCS3_STBC	2	18.25
MCS4_STBC	2	18.25
MCS5_STBC	2	18.25
MCS6_STBC	2	18.25
MCS7_STBC	2	17.75
VHT8_9SS1_STBC	2	-
MCS8	2	18.75
MCS9	2	18.75
MCS10	2	18.25
MCS11	2	18.25
MCS12	2	18.25
MCS13	2	18.25
MCS14	2	18.25
MCS15	2	17.75
VHT8_9SS2	2	-

DSSS_MULT12	3	-
OFDM_CDD2	3	-
MCS0_7_CDD2	3	-
VHT8_9SS1_CDD2	3	-
MCS0_7_STBC_SPEXP1	3	-
VHT8_9SS1_STBC_SPEXP1	3	-
MCS8_15_SPEXP1	3	-
VHT8_9SS2_SPEXP1	3	-
MCS16_23	3	-
VHT8_9SS3	3	-
OFDM_TXBF1	2	-
MCS0_7_TXBF1	2	-
VHT8_9SS1_TXBF1	2	-
MCS8_15_TXBF0	2	-
OFDM_TXBF2	3	-
MCS0_7_TXBF2	3	-
VHT8_9SS1_TXBF2	3	-
MCS8_15_TXBF1	3	-
VHT8_9SS2_TXBF1	3	-
MCS16_23_TXBF0	3	-

Power Targets:

Rate	Chains 20MHz	
DSSS	1	16.25
OFDM	1	11.50
MCS0_7	1	11.50
VHT8_9SS1	1	8.00
DSSS_MULT11	2	8.00

OFDM_CDD1	2	11.50
MCS0_7_CDD1	2	11.50
VHT8_9SS1_CDD1	2	8.00
MCS0_7_STBC	2	11.50
VHT8_9SS1_STBC	2	8.00
MCS8_15	2	11.50
VHT8_9SS2	2	8.00
DSSS_MULT12	3	8.00
OFDM_CDD2	3	8.00
MCS0_7_CDD2	3	8.00
VHT8_9SS1_CDD2	3	8.00
MCS0_7_STBC_SPEXP1	3	8.00
VHT8_9SS1_STBC_SPEXP1	3	8.00
MCS8_15_SPEXP1	3	8.00
VHT8_9SS2_SPEXP1	3	8.00
MCS16_23	3	8.00
VHT8_9SS3	3	8.00
OFDM_TXBF1	2	8.00
MCS0_7_TXBF1	2	8.00
VHT8_9SS1_TXBF1	2	8.00
MCS8_15_TXBF0	2	8.00
OFDM_TXBF2	3	8.00
MCS0_7_TXBF2	3	8.00
VHT8_9SS1_TXBF2	3	8.00
MCS8_15_TXBF1	3	8.00
VHT8_9SS2_TXBF1	3	8.00
MCS16_23_TXBF0	3	8.00

Maximum Power Target among all rates: 16.25 16.25

Last est. power : 17.75 0.00

Power Target for the current rate : 11.50 11.50

Last adjusted est. power : 17.75 0.00

root@OpenWrt:~#

root@OpenWrt:~# wl down

root@OpenWrt:~# wl chanspec 3

Chanspec set to 0x1003

root@OpenWrt:~# wl up

root@OpenWrt:~# wl curpower

Power Control: On, HW

Current Channel: 3

BSS Channel: 3

BSS Local Max: 30.0 dBm

BSS Local Constraint: 0.0 dB

Channel Width: 20MHz

User Target: 31.75 dBm

SROM Antgain 2G: 3.25 dB / 3.50 dB

SROM Antgain 5G: 0.0 dB / 0.0 dB

SAR: -

Open loop: Off

Current rate: [MCS15] ht mcs 15 Tx Exp 0 BW 20

Power Adjust: abs 0.0 dB (disabled)

Calibration acc: 0.75 dB

TXChain compensation: txch offset + ch offset

TXChain 1: 1.0 + 0.25 = 1.25 dB

TXChain 2: 0.50 + 0.0 = 0.50 dB

NOTE: Regulatory Limits, board limits and target power are for core 0

Use "wl curpower_display_core" to select another one

NOTE: Regulatory limit is conducted -> Antenna gain is ignored

Regulatory Limits:

Rate	Chains 20MHz	
DSSS	1	17.00
OFDM	1	18.25
MCS0_7	1	17.75
VHT8_9SS1	1	17.75
DSSS_MULT11	2	-
OFDM_CDD1	2	17.75
MCS0_7_CDD1	2	17.75
VHT8_9SS1_CDD1	2	17.75
MCS0_7_STBC	2	17.75
VHT8_9SS1_STBC	2	17.75
MCS8_15	2	17.75
VHT8_9SS2	2	17.75
DSSS_MULT12	3	-
OFDM_CDD2	3	-
MCS0_7_CDD2	3	-
VHT8_9SS1_CDD2	3	-
MCS0_7_STBC_SPEXP1	3	-
VHT8_9SS1_STBC_SPEXP1	3	-

MCS8_15_SPEXP1	3	-
VHT8_9SS2_SPEXP1	3	-
MCS16_23	3	-
VHT8_9SS3	3	-
OFDM_TXBF1	2	-
MCS0_7_TXBF1	2	-
VHT8_9SS1_TXBF1	2	-
MCS8_15_TXBF0	2	-
OFDM_TXBF2	3	-
MCS0_7_TXBF2	3	-
VHT8_9SS1_TXBF2	3	-
MCS8_15_TXBF1	3	-
VHT8_9SS2_TXBF1	3	-
MCS16_23_TXBF0	3	-

Core Index: 0

Board Limits:

Rate	Chains 20MHz	
DSSS	1	20.25
OFDM6	1	18.25
OFDM9	1	18.25
OFDM12	1	18.25
OFDM18	1	18.25
OFDM24	1	18.25
OFDM36	1	18.25
OFDM48	1	18.25
OFDM54	1	17.75
MCS0	1	18.25

MCS1	1	18.25
MCS2	1	18.25
MCS3	1	18.25
MCS4	1	18.25
MCS5	1	18.25
MCS6	1	17.75
MCS7	1	17.75
VHT8_9SS1	1	-
DSSS_MULT11	2	20.25
OFDM6_CDD1	2	18.75
OFDM9_CDD1	2	18.75
OFDM12_CDD1	2	18.75
OFDM18_CDD1	2	18.25
OFDM24_CDD1	2	18.25
OFDM36_CDD1	2	18.25
OFDM48_CDD1	2	18.25
OFDM54_CDD1	2	18.25
MCS0_CDD1	2	18.75
MCS1_CDD1	2	18.75
MCS2_CDD1	2	18.25
MCS3_CDD1	2	18.25
MCS4_CDD1	2	18.25
MCS5_CDD1	2	18.25
MCS6_CDD1	2	18.25
MCS7_CDD1	2	17.75
VHT8_9SS1_CDD1	2	-
MCS0_STBC	2	18.75
MCS1_STBC	2	18.75

MCS2_STBC	2	18.25
MCS3_STBC	2	18.25
MCS4_STBC	2	18.25
MCS5_STBC	2	18.25
MCS6_STBC	2	18.25
MCS7_STBC	2	17.75
VHT8_9SS1_STBC	2	-
MCS8	2	18.75
MCS9	2	18.75
MCS10	2	18.25
MCS11	2	18.25
MCS12	2	18.25
MCS13	2	18.25
MCS14	2	18.25
MCS15	2	17.75
VHT8_9SS2	2	-
DSSS_MULT12	3	-
OFDM_CDD2	3	-
MCS0_7_CDD2	3	-
VHT8_9SS1_CDD2	3	-
MCS0_7_STBC_SPEXP1	3	-
VHT8_9SS1_STBC_SPEXP1	3	-
MCS8_15_SPEXP1	3	-
VHT8_9SS2_SPEXP1	3	-
MCS16_23	3	-
VHT8_9SS3	3	-
OFDM_TXBF1	2	-
MCS0_7_TXBF1	2	-

VHT8_9SS1_TXBF1	2	-
MCS8_15_TXBF0	2	-
OFDM_TXBF2	3	-
MCS0_7_TXBF2	3	-
VHT8_9SS1_TXBF2	3	-
MCS8_15_TXBF1	3	-
VHT8_9SS2_TXBF1	3	-
MCS16_23_TXBF0	3	-

Power Targets:

Rate	Chains 20MHz	
DSSS	1	16.25
OFDM	1	17.00
MCS0_7	1	17.00
VHT8_9SS1	1	8.00
DSSS_MULT11	2	8.00
OFDM_CDD1	2	17.00
MCS0_7_CDD1	2	17.00
VHT8_9SS1_CDD1	2	8.00
MCS0_7_STBC	2	17.00
VHT8_9SS1_STBC	2	8.00
MCS8_15	2	17.00
VHT8_9SS2	2	8.00
DSSS_MULT12	3	8.00
OFDM_CDD2	3	8.00
MCS0_7_CDD2	3	8.00
VHT8_9SS1_CDD2	3	8.00
MCS0_7_STBC_SPEXP1	3	8.00

VHT8_9SS1_STBC_SPEXP1	3	8.00
MCS8_15_SPEXP1	3	8.00
VHT8_9SS2_SPEXP1	3	8.00
MCS16_23	3	8.00
VHT8_9SS3	3	8.00
OFDM_TXBF1	2	8.00
MCS0_7_TXBF1	2	8.00
VHT8_9SS1_TXBF1	2	8.00
MCS8_15_TXBF0	2	8.00
OFDM_TXBF2	3	8.00
MCS0_7_TXBF2	3	8.00
VHT8_9SS1_TXBF2	3	8.00
MCS8_15_TXBF1	3	8.00
VHT8_9SS2_TXBF1	3	8.00
MCS16_23_TXBF0	3	8.00

Maximum Power Target among all rates: 17.00 17.00

Last est. power : 0.00 17.25

Power Target for the current rate : 17.00 17.00

Last adjusted est. power : 0.00 18.00

root@OpenWrt:~#

root@OpenWrt:~# wl down

root@OpenWrt:~# wl chanspec 6

Chanspec set to 0x1006

root@OpenWrt:~# wl up

root@OpenWrt:~# wl curpower

Power Control: On, HW

Current Channel: 6

BSS Channel: 6
 BSS Local Max: 30.0 dBm
 BSS Local Constraint: 0.0 dB
 Channel Width: 20MHz
 User Target: 31.75 dBm
 SROM Antgain 2G: 3.25 dB / 3.50 dB
 SROM Antgain 5G: 0.0 dB / 0.0 dB
 SAR: -
 Open loop: Off
 Current rate: [MCS15] ht mcs 15 Tx Exp 0 BW 20

Power Adjust: abs 0.0 dB (disabled)

Calibration acc: 0.75 dB

TXChain compensation: txch offset + ch offset

TXChain 1: $1.0 + 0.0 = 1.0$ dB

TXChain 2: $0.50 + 0.0 = 0.50$ dB

NOTE: Regulatory Limits, board limits and target power are for core 0

Use "wl curpower_display_core" to select another one

NOTE: Regulatory limit is conducted -> Antenna gain is ignored

Regulatory Limits:

Rate	Chains 20MHz	
DSSS	1	17.00
OFDM	1	18.25

MCS0_7	1	17.75
VHT8_9SS1	1	17.75
DSSS_MULT11	2	-
OFDM_CDD1	2	17.75
MCS0_7_CDD1	2	17.75
VHT8_9SS1_CDD1	2	17.75
MCS0_7_STBC	2	17.75
VHT8_9SS1_STBC	2	17.75
MCS8_15	2	17.75
VHT8_9SS2	2	17.75
DSSS_MULT12	3	-
OFDM_CDD2	3	-
MCS0_7_CDD2	3	-
VHT8_9SS1_CDD2	3	-
MCS0_7_STBC_SPEXP1	3	-
VHT8_9SS1_STBC_SPEXP1	3	-
MCS8_15_SPEXP1	3	-
VHT8_9SS2_SPEXP1	3	-
MCS16_23	3	-
VHT8_9SS3	3	-
OFDM_TXBF1	2	-
MCS0_7_TXBF1	2	-
VHT8_9SS1_TXBF1	2	-
MCS8_15_TXBF0	2	-
OFDM_TXBF2	3	-
MCS0_7_TXBF2	3	-
VHT8_9SS1_TXBF2	3	-
MCS8_15_TXBF1	3	-

VHT8_9SS2_TXBF1	3	-
MCS16_23_TXBF0	3	-
Core Index:	0	
Board Limits:		
Rate	Chains 20MHz	
DSSS	1	20.25
OFDM6	1	18.25
OFDM9	1	18.25
OFDM12	1	18.25
OFDM18	1	18.25
OFDM24	1	18.25
OFDM36	1	18.25
OFDM48	1	18.25
OFDM54	1	17.75
MCS0	1	18.25
MCS1	1	18.25
MCS2	1	18.25
MCS3	1	18.25
MCS4	1	18.25
MCS5	1	18.25
MCS6	1	17.75
MCS7	1	17.75
VHT8_9SS1	1	-
DSSS_MULT11	2	20.25
OFDM6_CDD1	2	18.75
OFDM9_CDD1	2	18.75
OFDM12_CDD1	2	18.75

OFDM18_CDD1	2	18.25
OFDM24_CDD1	2	18.25
OFDM36_CDD1	2	18.25
OFDM48_CDD1	2	18.25
OFDM54_CDD1	2	18.25
MCS0_CDD1	2	18.75
MCS1_CDD1	2	18.75
MCS2_CDD1	2	18.25
MCS3_CDD1	2	18.25
MCS4_CDD1	2	18.25
MCS5_CDD1	2	18.25
MCS6_CDD1	2	18.25
MCS7_CDD1	2	17.75
VHT8_9SS1_CDD1	2	-
MCS0_STBC	2	18.75
MCS1_STBC	2	18.75
MCS2_STBC	2	18.25
MCS3_STBC	2	18.25
MCS4_STBC	2	18.25
MCS5_STBC	2	18.25
MCS6_STBC	2	18.25
MCS7_STBC	2	17.75
VHT8_9SS1_STBC	2	-
MCS8	2	18.75
MCS9	2	18.75
MCS10	2	18.25
MCS11	2	18.25
MCS12	2	18.25

MCS13	2	18.25
MCS14	2	18.25
MCS15	2	17.75
VHT8_9SS2	2	-
DSSS_MULT12	3	-
OFDM_CDD2	3	-
MCS0_7_CDD2	3	-
VHT8_9SS1_CDD2	3	-
MCS0_7_STBC_SPEXP1	3	-
VHT8_9SS1_STBC_SPEXP1	3	-
MCS8_15_SPEXP1	3	-
VHT8_9SS2_SPEXP1	3	-
MCS16_23	3	-
VHT8_9SS3	3	-
OFDM_TXBF1	2	-
MCS0_7_TXBF1	2	-
VHT8_9SS1_TXBF1	2	-
MCS8_15_TXBF0	2	-
OFDM_TXBF2	3	-
MCS0_7_TXBF2	3	-
VHT8_9SS1_TXBF2	3	-
MCS8_15_TXBF1	3	-
VHT8_9SS2_TXBF1	3	-
MCS16_23_TXBF0	3	-

Power Targets:

Rate	Chains 20MHz	
DSSS	1	16.25

OFDM	1	17.00
MCS0_7	1	17.00
VHT8_9SS1	1	8.00
DSSS_MULT11	2	8.00
OFDM_CDD1	2	17.00
MCS0_7_CDD1	2	17.00
VHT8_9SS1_CDD1	2	8.00
MCS0_7_STBC	2	17.00
VHT8_9SS1_STBC	2	8.00
MCS8_15	2	17.00
VHT8_9SS2	2	8.00
DSSS_MULT12	3	8.00
OFDM_CDD2	3	8.00
MCS0_7_CDD2	3	8.00
VHT8_9SS1_CDD2	3	8.00
MCS0_7_STBC_SPEXP1	3	8.00
VHT8_9SS1_STBC_SPEXP1	3	8.00
MCS8_15_SPEXP1	3	8.00
VHT8_9SS2_SPEXP1	3	8.00
MCS16_23	3	8.00
VHT8_9SS3	3	8.00
OFDM_TXBF1	2	8.00
MCS0_7_TXBF1	2	8.00
VHT8_9SS1_TXBF1	2	8.00
MCS8_15_TXBF0	2	8.00
OFDM_TXBF2	3	8.00
MCS0_7_TXBF2	3	8.00
VHT8_9SS1_TXBF2	3	8.00

```

MCS8_15_TXBF1      3      8.00
VHT8_9SS2_TXBF1    3      8.00
MCS16_23_TXBF0     3      8.00

```

Maximum Power Target among all rates: 17.00 17.00

Last est. power : 18.25 0.00

Power Target for the current rate : 17.00 17.00

Last adjusted est. power : 19.00 0.00

root@OpenWrt:~#

root@OpenWrt:~# wl down

root@OpenWrt:~# wl chanspec 9

Chanspec set to 0x1009

root@OpenWrt:~# wl up

root@OpenWrt:~# wl curpower

Power Control: On, HW

Current Channel: 9

BSS Channel: 9

BSS Local Max: 30.0 dBm

BSS Local Constraint: 0.0 dB

Channel Width: 20MHz

User Target: 31.75 dBm

SROM Antgain 2G: 3.25 dB / 3.50 dB

SROM Antgain 5G: 0.0 dB / 0.0 dB

SAR: -

Open loop: Off

Current rate: [MCS15] ht mcs 15 Tx Exp 0 BW 20

Power Adjust: abs 0.0 dB (disabled)

Calibration acc: 0.75 dB

TXChain compensation: txch offset + ch offset

TXChain 1: 1.0 + 0.0 = 1.0 dB

TXChain 2: 0.50 + 0.0 = 0.50 dB

NOTE: Regulatory Limits, board limits and target power are for core 0

Use "wl curpower_display_core" to select another one

NOTE: Regulatory limit is conducted -> Antenna gain is ignored

Regulatory Limits:

Rate	Chains 20MHz	
DSSS	1	17.00
OFDM	1	18.25
MCS0_7	1	17.75
VHT8_9SS1	1	17.75
DSSS_MULT11	2	-
OFDM_CDD1	2	17.75
MCS0_7_CDD1	2	17.75
VHT8_9SS1_CDD1	2	17.75
MCS0_7_STBC	2	17.75
VHT8_9SS1_STBC	2	17.75
MCS8_15	2	17.75
VHT8_9SS2	2	17.75
DSSS_MULT12	3	-
OFDM_CDD2	3	-

MCS0_7_CDD2	3	-
VHT8_9SS1_CDD2	3	-
MCS0_7_STBC_SPEXP1	3	-
VHT8_9SS1_STBC_SPEXP1	3	-
MCS8_15_SPEXP1	3	-
VHT8_9SS2_SPEXP1	3	-
MCS16_23	3	-
VHT8_9SS3	3	-
OFDM_TXBF1	2	-
MCS0_7_TXBF1	2	-
VHT8_9SS1_TXBF1	2	-
MCS8_15_TXBF0	2	-
OFDM_TXBF2	3	-
MCS0_7_TXBF2	3	-
VHT8_9SS1_TXBF2	3	-
MCS8_15_TXBF1	3	-
VHT8_9SS2_TXBF1	3	-
MCS16_23_TXBF0	3	-

Core Index: 0

Board Limits:

Rate	Chains 20MHz	
DSSS	1	20.25
OFDM6	1	18.25
OFDM9	1	18.25
OFDM12	1	18.25
OFDM18	1	18.25
OFDM24	1	18.25

OFDM36	1	18.25
OFDM48	1	18.25
OFDM54	1	17.75
MCS0	1	18.25
MCS1	1	18.25
MCS2	1	18.25
MCS3	1	18.25
MCS4	1	18.25
MCS5	1	18.25
MCS6	1	17.75
MCS7	1	17.75
VHT8_9SS1	1	-
DSSS_MULT11	2	20.25
OFDM6_CDD1	2	18.75
OFDM9_CDD1	2	18.75
OFDM12_CDD1	2	18.75
OFDM18_CDD1	2	18.25
OFDM24_CDD1	2	18.25
OFDM36_CDD1	2	18.25
OFDM48_CDD1	2	18.25
OFDM54_CDD1	2	18.25
MCS0_CDD1	2	18.75
MCS1_CDD1	2	18.75
MCS2_CDD1	2	18.25
MCS3_CDD1	2	18.25
MCS4_CDD1	2	18.25
MCS5_CDD1	2	18.25
MCS6_CDD1	2	18.25

MCS7_CDD1	2	17.75
VHT8_9SS1_CDD1	2	-
MCS0_STBC	2	18.75
MCS1_STBC	2	18.75
MCS2_STBC	2	18.25
MCS3_STBC	2	18.25
MCS4_STBC	2	18.25
MCS5_STBC	2	18.25
MCS6_STBC	2	18.25
MCS7_STBC	2	17.75
VHT8_9SS1_STBC	2	-
MCS8	2	18.75
MCS9	2	18.75
MCS10	2	18.25
MCS11	2	18.25
MCS12	2	18.25
MCS13	2	18.25
MCS14	2	18.25
MCS15	2	17.75
VHT8_9SS2	2	-
DSSS_MULTI2	3	-
OFDM_CDD2	3	-
MCS0_7_CDD2	3	-
VHT8_9SS1_CDD2	3	-
MCS0_7_STBC_SPEXP1	3	-
VHT8_9SS1_STBC_SPEXP1	3	-
MCS8_15_SPEXP1	3	-
VHT8_9SS2_SPEXP1	3	-

MCS16_23	3	-
VHT8_9SS3	3	-
OFDM_TXBF1	2	-
MCS0_7_TXBF1	2	-
VHT8_9SS1_TXBF1	2	-
MCS8_15_TXBF0	2	-
OFDM_TXBF2	3	-
MCS0_7_TXBF2	3	-
VHT8_9SS1_TXBF2	3	-
MCS8_15_TXBF1	3	-
VHT8_9SS2_TXBF1	3	-
MCS16_23_TXBF0	3	-

Power Targets:

Rate	Chains 20MHz	
DSSS	1	16.25
OFDM	1	17.00
MCS0_7	1	17.00
VHT8_9SS1	1	8.00
DSSS_MULT11	2	8.00
OFDM_CDD1	2	17.00
MCS0_7_CDD1	2	17.00
VHT8_9SS1_CDD1	2	8.00
MCS0_7_STBC	2	17.00
VHT8_9SS1_STBC	2	8.00
MCS8_15	2	17.00
VHT8_9SS2	2	8.00
DSSS_MULT12	3	8.00

OFDM_CDD2	3	8.00
MCS0_7_CDD2	3	8.00
VHT8_9SS1_CDD2	3	8.00
MCS0_7_STBC_SPEXP1	3	8.00
VHT8_9SS1_STBC_SPEXP1	3	8.00
MCS8_15_SPEXP1	3	8.00
VHT8_9SS2_SPEXP1	3	8.00
MCS16_23	3	8.00
VHT8_9SS3	3	8.00
OFDM_TXBF1	2	8.00
MCS0_7_TXBF1	2	8.00
VHT8_9SS1_TXBF1	2	8.00
MCS8_15_TXBF0	2	8.00
OFDM_TXBF2	3	8.00
MCS0_7_TXBF2	3	8.00
VHT8_9SS1_TXBF2	3	8.00
MCS8_15_TXBF1	3	8.00
VHT8_9SS2_TXBF1	3	8.00
MCS16_23_TXBF0	3	8.00

Maximum Power Target among all rates: 17.00 17.00

Last est. power : 18.50 0.00

Power Target for the current rate : 17.00 17.00

Last adjusted est. power : 19.25 0.00

root@OpenWrt:~#

root@OpenWrt:~# wl down

root@OpenWrt:~# wl chanspec 10

Chanspec set to 0x100a

```
root@OpenWrt:~# wl up
```

```
root@OpenWrt:~# wl curpower
```

```
Power Control:      On, HW
```

```
Current Channel:    10
```

```
BSS Channel:        10
```

```
BSS Local Max:      30.0 dBm
```

```
BSS Local Constraint: 0.0 dB
```

```
Channel Width:      20MHz
```

```
User Target:        31.75 dBm
```

```
SROM Antgain 2G:    3.25 dB / 3.50 dB
```

```
SROM Antgain 5G:    0.0 dB / 0.0 dB
```

```
SAR:                 -
```

```
Open loop:          Off
```

```
Current rate:       [MCS15] ht mcs 15 Tx Exp 0 BW 20
```

```
Power Adjust:       abs 0.0 dB (disabled)
```

```
Calibration acc:    0.75 dB
```

```
TXChain compensation: txch offset + ch offset
```

```
TXChain 1:          1.0 + -0.50 = 0.50 dB
```

```
TXChain 2:          0.50 + -0.25 = 0.25 dB
```

NOTE: Regulatory Limits, board limits and target power are for core 0

Use "wl curpower_display_core" to select another one

NOTE: Regulatory limit is conducted -> Antenna gain is ignored

Regulatory Limits:

Rate	Chains 20MHz	
DSSS	1	16.75
OFDM	1	12.25
MCS0_7	1	11.00
VHT8_9SS1	1	11.00
DSSS_MULT11	2	-
OFDM_CDD1	2	11.00
MCS0_7_CDD1	2	11.00
VHT8_9SS1_CDD1	2	11.00
MCS0_7_STBC	2	11.00
VHT8_9SS1_STBC	2	11.00
MCS8_15	2	11.00
VHT8_9SS2	2	11.00
DSSS_MULT12	3	-
OFDM_CDD2	3	-
MCS0_7_CDD2	3	-
VHT8_9SS1_CDD2	3	-
MCS0_7_STBC_SPEXP1	3	-
VHT8_9SS1_STBC_SPEXP1	3	-
MCS8_15_SPEXP1	3	-
VHT8_9SS2_SPEXP1	3	-
MCS16_23	3	-
VHT8_9SS3	3	-
OFDM_TXBF1	2	-
MCS0_7_TXBF1	2	-
VHT8_9SS1_TXBF1	2	-
MCS8_15_TXBF0	2	-

OFDM_TXBF2	3	-
MCS0_7_TXBF2	3	-
VHT8_9SS1_TXBF2	3	-
MCS8_15_TXBF1	3	-
VHT8_9SS2_TXBF1	3	-
MCS16_23_TXBF0	3	-

Core Index: 0

Board Limits:

Rate	Chains 20MHz	
DSSS	1	20.25
OFDM6	1	18.25
OFDM9	1	18.25
OFDM12	1	18.25
OFDM18	1	18.25
OFDM24	1	18.25
OFDM36	1	18.25
OFDM48	1	18.25
OFDM54	1	17.75
MCS0	1	18.25
MCS1	1	18.25
MCS2	1	18.25
MCS3	1	18.25
MCS4	1	18.25
MCS5	1	18.25
MCS6	1	17.75
MCS7	1	17.75
VHT8_9SS1	1	-

DSSS_MULT11	2	20.25
OFDM6_CDD1	2	18.75
OFDM9_CDD1	2	18.75
OFDM12_CDD1	2	18.75
OFDM18_CDD1	2	18.25
OFDM24_CDD1	2	18.25
OFDM36_CDD1	2	18.25
OFDM48_CDD1	2	18.25
OFDM54_CDD1	2	18.25
MCS0_CDD1	2	18.75
MCS1_CDD1	2	18.75
MCS2_CDD1	2	18.25
MCS3_CDD1	2	18.25
MCS4_CDD1	2	18.25
MCS5_CDD1	2	18.25
MCS6_CDD1	2	18.25
MCS7_CDD1	2	17.75
VHT8_9SS1_CDD1	2	-
MCS0_STBC	2	18.75
MCS1_STBC	2	18.75
MCS2_STBC	2	18.25
MCS3_STBC	2	18.25
MCS4_STBC	2	18.25
MCS5_STBC	2	18.25
MCS6_STBC	2	18.25
MCS7_STBC	2	17.75
VHT8_9SS1_STBC	2	-
MCS8	2	18.75

MCS9	2	18.75
MCS10	2	18.25
MCS11	2	18.25
MCS12	2	18.25
MCS13	2	18.25
MCS14	2	18.25
MCS15	2	17.75
VHT8_9SS2	2	-
DSSS_MULT12	3	-
OFDM_CDD2	3	-
MCS0_7_CDD2	3	-
VHT8_9SS1_CDD2	3	-
MCS0_7_STBC_SPEXP1	3	-
VHT8_9SS1_STBC_SPEXP1	3	-
MCS8_15_SPEXP1	3	-
VHT8_9SS2_SPEXP1	3	-
MCS16_23	3	-
VHT8_9SS3	3	-
OFDM_TXBF1	2	-
MCS0_7_TXBF1	2	-
VHT8_9SS1_TXBF1	2	-
MCS8_15_TXBF0	2	-
OFDM_TXBF2	3	-
MCS0_7_TXBF2	3	-
VHT8_9SS1_TXBF2	3	-
MCS8_15_TXBF1	3	-
VHT8_9SS2_TXBF1	3	-
MCS16_23_TXBF0	3	-

Power Targets:

Rate	Chains 20MHz	
DSSS	1	16.00
OFDM	1	10.25
MCS0_7	1	10.25
VHT8_9SS1	1	8.00
DSSS_MULT11	2	8.00
OFDM_CDD1	2	10.25
MCS0_7_CDD1	2	10.25
VHT8_9SS1_CDD1	2	8.00
MCS0_7_STBC	2	10.25
VHT8_9SS1_STBC	2	8.00
MCS8_15	2	10.25
VHT8_9SS2	2	8.00
DSSS_MULT12	3	8.00
OFDM_CDD2	3	8.00
MCS0_7_CDD2	3	8.00
VHT8_9SS1_CDD2	3	8.00
MCS0_7_STBC_SPEXP1	3	8.00
VHT8_9SS1_STBC_SPEXP1	3	8.00
MCS8_15_SPEXP1	3	8.00
VHT8_9SS2_SPEXP1	3	8.00
MCS16_23	3	8.00
VHT8_9SS3	3	8.00
OFDM_TXBF1	2	8.00
MCS0_7_TXBF1	2	8.00
VHT8_9SS1_TXBF1	2	8.00

MCS8_15_TXBF0	2	8.00
OFDM_TXBF2	3	8.00
MCS0_7_TXBF2	3	8.00
VHT8_9SS1_TXBF2	3	8.00
MCS8_15_TXBF1	3	8.00
VHT8_9SS2_TXBF1	3	8.00
MCS16_23_TXBF0	3	8.00

Maximum Power Target among all rates: 16.00 16.00

Last est. power : 0.00 17.00

Power Target for the current rate : 10.25 10.25

Last adjusted est. power : 0.00 17.00

root@OpenWrt:~#

root@OpenWrt:~# wl down

root@OpenWrt:~# wl chanspec 11

Chanspec set to 0x100b

root@OpenWrt:~# wl up

root@OpenWrt:~# wl curpower

Power Control: On, HW

Current Channel: 11

BSS Channel: 11

BSS Local Max: 30.0 dBm

BSS Local Constraint: 0.0 dB

Channel Width: 20MHz

User Target: 31.75 dBm

SROM Antgain 2G: 3.25 dB / 3.50 dB

SROM Antgain 5G: 0.0 dB / 0.0 dB

SAR: -

Open loop: Off

Current rate: [MCS15] ht mcs 15 Tx Exp 0 BW 20

Power Adjust: abs 0.0 dB (disabled)

Calibration acc: 0.75 dB

TXChain compensation: txch offset + ch offset

TXChain 1: $1.0 + 0.0 = 1.0$ dB

TXChain 2: $0.50 + 0.25 = 0.75$ dB

NOTE: Regulatory Limits, board limits and target power are for core 0

Use "wl curpower_display_core" to select another one

NOTE: Regulatory limit is conducted -> Antenna gain is ignored

Regulatory Limits:

Rate	Chains 20MHz	
DSSS	1	16.75
OFDM	1	12.25
MCS0_7	1	11.00
VHT8_9SS1	1	11.00
DSSS_MULT11	2	-
OFDM_CDD1	2	11.00
MCS0_7_CDD1	2	11.00
VHT8_9SS1_CDD1	2	11.00
MCS0_7_STBC	2	11.00
VHT8_9SS1_STBC	2	11.00

MCS8_15	2	11.00
VHT8_9SS2	2	11.00
DSSS_MULT12	3	-
OFDM_CDD2	3	-
MCS0_7_CDD2	3	-
VHT8_9SS1_CDD2	3	-
MCS0_7_STBC_SPEXP1	3	-
VHT8_9SS1_STBC_SPEXP1	3	-
MCS8_15_SPEXP1	3	-
VHT8_9SS2_SPEXP1	3	-
MCS16_23	3	-
VHT8_9SS3	3	-
OFDM_TXBF1	2	-
MCS0_7_TXBF1	2	-
VHT8_9SS1_TXBF1	2	-
MCS8_15_TXBF0	2	-
OFDM_TXBF2	3	-
MCS0_7_TXBF2	3	-
VHT8_9SS1_TXBF2	3	-
MCS8_15_TXBF1	3	-
VHT8_9SS2_TXBF1	3	-
MCS16_23_TXBF0	3	-

Core Index: 0

Board Limits:

Rate Chains 20MHz

DSSS 1 20.25

OFDM6 1 18.25

OFDM9	1	18.25
OFDM12	1	18.25
OFDM18	1	18.25
OFDM24	1	18.25
OFDM36	1	18.25
OFDM48	1	18.25
OFDM54	1	17.75
MCS0	1	18.25
MCS1	1	18.25
MCS2	1	18.25
MCS3	1	18.25
MCS4	1	18.25
MCS5	1	18.25
MCS6	1	17.75
MCS7	1	17.75
VHT8_9SS1	1	-
DSSS_MULT11	2	20.25
OFDM6_CDD1	2	18.75
OFDM9_CDD1	2	18.75
OFDM12_CDD1	2	18.75
OFDM18_CDD1	2	18.25
OFDM24_CDD1	2	18.25
OFDM36_CDD1	2	18.25
OFDM48_CDD1	2	18.25
OFDM54_CDD1	2	18.25
MCS0_CDD1	2	18.75
MCS1_CDD1	2	18.75
MCS2_CDD1	2	18.25

MCS3_CDD1	2	18.25
MCS4_CDD1	2	18.25
MCS5_CDD1	2	18.25
MCS6_CDD1	2	18.25
MCS7_CDD1	2	17.75
VHT8_9SS1_CDD1	2	-
MCS0_STBC	2	18.75
MCS1_STBC	2	18.75
MCS2_STBC	2	18.25
MCS3_STBC	2	18.25
MCS4_STBC	2	18.25
MCS5_STBC	2	18.25
MCS6_STBC	2	18.25
MCS7_STBC	2	17.75
VHT8_9SS1_STBC	2	-
MCS8	2	18.75
MCS9	2	18.75
MCS10	2	18.25
MCS11	2	18.25
MCS12	2	18.25
MCS13	2	18.25
MCS14	2	18.25
MCS15	2	17.75
VHT8_9SS2	2	-
DSSS_MULT12	3	-
OFDM_CDD2	3	-
MCS0_7_CDD2	3	-
VHT8_9SS1_CDD2	3	-

MCS0_7_STBC_SPEXP1	3	-
VHT8_9SS1_STBC_SPEXP1	3	-
MCS8_15_SPEXP1	3	-
VHT8_9SS2_SPEXP1	3	-
MCS16_23	3	-
VHT8_9SS3	3	-
OFDM_TXBF1	2	-
MCS0_7_TXBF1	2	-
VHT8_9SS1_TXBF1	2	-
MCS8_15_TXBF0	2	-
OFDM_TXBF2	3	-
MCS0_7_TXBF2	3	-
VHT8_9SS1_TXBF2	3	-
MCS8_15_TXBF1	3	-
VHT8_9SS2_TXBF1	3	-
MCS16_23_TXBF0	3	-

Power Targets:

Rate	Chains 20MHz	
DSSS	1	16.00
OFDM	1	10.25
MCS0_7	1	10.25
VHT8_9SS1	1	8.00
DSSS_MULT11	2	8.00
OFDM_CDD1	2	10.25
MCS0_7_CDD1	2	10.25
VHT8_9SS1_CDD1	2	8.00
MCS0_7_STBC	2	10.25

VHT8_9SS1_STBC	2	8.00
MCS8_15	2	10.25
VHT8_9SS2	2	8.00
DSSS_MULT12	3	8.00
OFDM_CDD2	3	8.00
MCS0_7_CDD2	3	8.00
VHT8_9SS1_CDD2	3	8.00
MCS0_7_STBC_SPEXP1	3	8.00
VHT8_9SS1_STBC_SPEXP1	3	8.00
MCS8_15_SPEXP1	3	8.00
VHT8_9SS2_SPEXP1	3	8.00
MCS16_23	3	8.00
VHT8_9SS3	3	8.00
OFDM_TXBF1	2	8.00
MCS0_7_TXBF1	2	8.00
VHT8_9SS1_TXBF1	2	8.00
MCS8_15_TXBF0	2	8.00
OFDM_TXBF2	3	8.00
MCS0_7_TXBF2	3	8.00
VHT8_9SS1_TXBF2	3	8.00
MCS8_15_TXBF1	3	8.00
VHT8_9SS2_TXBF1	3	8.00
MCS16_23_TXBF0	3	8.00
Maximum Power Target among all rates: 16.00 16.00		
Last est. power	:	18.00 0.00
Power Target for the current rate	:	10.25 10.25
Last adjusted est. power	:	18.00 0.00

```
root@OpenWrt:~#  
root@OpenWrt:~# wl down  
root@OpenWrt:~# wl mimo_bw_cap 1  
root@OpenWrt:~# wl mimo_txbw 4  
root@OpenWrt:~# wl band b  
root@OpenWrt:~# wl up  
root@OpenWrt:~# wl isup  
1  
root@OpenWrt:~#  
root@OpenWrt:~# wl down  
root@OpenWrt:~# wl chanspec 1l  
Chanspec set to 0x1803  
root@OpenWrt:~# wl up  
root@OpenWrt:~# wl curpower  
Power Control:      On, HW  
Current Channel:    1l  
BSS Channel:        1l  
BSS Local Max:      30.0 dBm  
BSS Local Constraint: 0.0 dB  
Channel Width:      40MHz  
User Target:        31.75 dBm  
SROM Antgain 2G:    3.25 dB / 3.50 dB  
SROM Antgain 5G:    0.0 dB / 0.0 dB  
SAR:                -  
Open loop:          Off  
Current rate:       [MCS15] ht mcs 15 Tx Exp 0 BW 40  
  
Power Adjust:       abs 0.0 dB (disabled)
```

Calibration acc: 0.75 dB

TXChain compensation: txch offset + ch offset

TXChain 1: 1.0 + 0.25 = 1.25 dB

TXChain 2: 0.50 + 0.0 = 0.50 dB

NOTE: Regulatory Limits, board limits and target power are for core 0

Use "wl curpower_display_core" to select another one

NOTE: Regulatory limit is conducted -> Antenna gain is ignored

Regulatory Limits:

Rate	Chains 20in40 40MHz		
DSSS	1	17.00	17.00
OFDM	1	10.00	10.00
MCS0_7	1	10.00	10.00
VHT8_9SS1	1	10.00	10.00
DSSS_MULT11	2	-	-
OFDM_CDD1	2	9.75	9.75
MCS0_7_CDD1	2	9.75	9.75
VHT8_9SS1_CDD1	2	9.75	9.75
MCS0_7_STBC	2	9.75	9.75
VHT8_9SS1_STBC	2	9.75	9.75
MCS8_15	2	9.75	9.75
VHT8_9SS2	2	9.75	9.75
DSSS_MULT12	3	-	-
OFDM_CDD2	3	-	-

MCS0_7_CDD2	3	-	-
VHT8_9SS1_CDD2	3	-	-
MCS0_7_STBC_SPEXP1	3	-	-
VHT8_9SS1_STBC_SPEXP1	3	-	-
MCS8_15_SPEXP1	3	-	-
VHT8_9SS2_SPEXP1	3	-	-
MCS16_23	3	-	-
VHT8_9SS3	3	-	-
OFDM_TXBF1	2	-	-
MCS0_7_TXBF1	2	-	-
VHT8_9SS1_TXBF1	2	-	-
MCS8_15_TXBF0	2	-	-
OFDM_TXBF2	3	-	-
MCS0_7_TXBF2	3	-	-
VHT8_9SS1_TXBF2	3	-	-
MCS8_15_TXBF1	3	-	-
VHT8_9SS2_TXBF1	3	-	-
MCS16_23_TXBF0	3	-	-

Core Index: 0

Board Limits:

Rate	Chains 20in40 40MHz		
DSSS	1	20.25	20.25
OFDM6	1	17.75	17.75
OFDM9	1	17.75	17.75
OFDM12	1	17.75	17.75
OFDM18	1	17.75	17.75
OFDM24	1	17.75	17.75

OFDM36	1	17.75	17.75
OFDM48	1	17.25	17.25
OFDM54	1	17.25	17.25
MCS0	1	17.75	17.75
MCS1	1	17.75	17.75
MCS2	1	17.75	17.75
MCS3	1	17.75	17.75
MCS4	1	17.75	17.75
MCS5	1	17.25	17.25
MCS6	1	17.25	17.25
MCS7	1	16.75	16.75
VHT8_9SS1	1	-	-
DSSS_MULT11	2	20.25	20.25
OFDM6_CDD1	2	17.75	17.75
OFDM9_CDD1	2	17.75	17.75
OFDM12_CDD1	2	17.75	17.75
OFDM18_CDD1	2	17.75	17.75
OFDM24_CDD1	2	17.75	17.75
OFDM36_CDD1	2	17.75	17.75
OFDM48_CDD1	2	17.25	17.25
OFDM54_CDD1	2	17.25	17.25
MCS0_CDD1	2	17.75	17.75
MCS1_CDD1	2	17.75	17.75
MCS2_CDD1	2	17.75	17.75
MCS3_CDD1	2	17.75	17.75
MCS4_CDD1	2	17.75	17.75
MCS5_CDD1	2	17.25	17.25
MCS6_CDD1	2	17.25	17.25

MCS7_CDD1	2	16.75	16.75
VHT8_9SS1_CDD1	2	-	-
MCS0_STBC	2	17.75	17.75
MCS1_STBC	2	17.75	17.75
MCS2_STBC	2	17.75	17.75
MCS3_STBC	2	17.75	17.75
MCS4_STBC	2	17.75	17.75
MCS5_STBC	2	17.25	17.25
MCS6_STBC	2	17.25	17.25
MCS7_STBC	2	16.75	16.75
VHT8_9SS1_STBC	2	-	-
MCS8	2	17.75	17.75
MCS9	2	17.75	17.75
MCS10	2	17.75	17.75
MCS11	2	17.75	17.75
MCS12	2	17.75	17.75
MCS13	2	17.25	17.25
MCS14	2	17.25	17.25
MCS15	2	16.75	16.75
VHT8_9SS2	2	-	-
DSSS_MULTI2	3	-	-
OFDM_CDD2	3	-	-
MCS0_7_CDD2	3	-	-
VHT8_9SS1_CDD2	3	-	-
MCS0_7_STBC_SPEXP1	3	-	-
VHT8_9SS1_STBC_SPEXP1	3	-	-
MCS8_15_SPEXP1	3	-	-
VHT8_9SS2_SPEXP1	3	-	-

MCS16_23	3	-	-
VHT8_9SS3	3	-	-
OFDM_TXBF1	2	-	-
MCS0_7_TXBF1	2	-	-
VHT8_9SS1_TXBF1	2	-	-
MCS8_15_TXBF0	2	-	-
OFDM_TXBF2	3	-	-
MCS0_7_TXBF2	3	-	-
VHT8_9SS1_TXBF2	3	-	-
MCS8_15_TXBF1	3	-	-
VHT8_9SS2_TXBF1	3	-	-
MCS16_23_TXBF0	3	-	-

Power Targets:

Rate	Chains 20in40 40MHz		
DSSS	1	16.25	8.00
OFDM	1	9.25	9.25
MCS0_7	1	9.25	9.25
VHT8_9SS1	1	8.00	8.00
DSSS_MULT11	2	8.00	8.00
OFDM_CDD1	2	9.00	9.00
MCS0_7_CDD1	2	9.00	9.00
VHT8_9SS1_CDD1	2	8.00	8.00
MCS0_7_STBC	2	9.00	9.00
VHT8_9SS1_STBC	2	8.00	8.00
MCS8_15	2	9.00	9.00
VHT8_9SS2	2	8.00	8.00
DSSS_MULT12	3	8.00	8.00

OFDM_CDD2	3	8.00	8.00
MCS0_7_CDD2	3	8.00	8.00
VHT8_9SS1_CDD2	3	8.00	8.00
MCS0_7_STBC_SPEXP1	3	8.00	8.00
VHT8_9SS1_STBC_SPEXP1	3	8.00	8.00
MCS8_15_SPEXP1	3	8.00	8.00
VHT8_9SS2_SPEXP1	3	8.00	8.00
MCS16_23	3	8.00	8.00
VHT8_9SS3	3	8.00	8.00
OFDM_TXBF1	2	8.00	8.00
MCS0_7_TXBF1	2	8.00	8.00
VHT8_9SS1_TXBF1	2	8.00	8.00
MCS8_15_TXBF0	2	8.00	8.00
OFDM_TXBF2	3	8.00	8.00
MCS0_7_TXBF2	3	8.00	8.00
VHT8_9SS1_TXBF2	3	8.00	8.00
MCS8_15_TXBF1	3	8.00	8.00
VHT8_9SS2_TXBF1	3	8.00	8.00
MCS16_23_TXBF0	3	8.00	8.00

Maximum Power Target among all rates: 16.25 16.25

Last est. power : 0.00 17.50

Power Target for the current rate : 9.00 9.00

Last adjusted est. power : 0.00 17.50

root@OpenWrt:~#

root@OpenWrt:~# wl down

root@OpenWrt:~# wl chanspec 2l

Chanspec set to 0x1804

```
root@OpenWrt:~# wl up
```

```
root@OpenWrt:~# wl curpower
```

```
Power Control:      On, HW
```

```
Current Channel:    2I
```

```
BSS Channel:       2I
```

```
BSS Local Max:     30.0 dBm
```

```
BSS Local Constraint: 0.0 dB
```

```
Channel Width:     40MHz
```

```
User Target:       31.75 dBm
```

```
SROM Antgain 2G:   3.25 dB / 3.50 dB
```

```
SROM Antgain 5G:   0.0 dB / 0.0 dB
```

```
SAR:               -
```

```
Open loop:         Off
```

```
Current rate:      [MCS15] ht mcs 15 Tx Exp 0 BW 40
```

```
Power Adjust:      abs 0.0 dB (disabled)
```

```
Calibration acc:   0.75 dB
```

```
TXChain compensation: txch offset + ch offset
```

```
TXChain 1:         1.0 + 0.0 = 1.0 dB
```

```
TXChain 2:         0.50 + 0.0 = 0.50 dB
```

NOTE: Regulatory Limits, board limits and target power are for core 0

Use "wl curpower_display_core" to select another one

NOTE: Regulatory limit is conducted -> Antenna gain is ignored

Regulatory Limits:

Rate	Chains 20in40 40MHz		
DSSS	1	17.00	17.00
OFDM	1	10.00	10.00
MCS0_7	1	10.00	10.00
VHT8_9SS1	1	10.00	10.00
DSSS_MULT11	2	-	-
OFDM_CDD1	2	9.75	9.75
MCS0_7_CDD1	2	9.75	9.75
VHT8_9SS1_CDD1	2	9.75	9.75
MCS0_7_STBC	2	9.75	9.75
VHT8_9SS1_STBC	2	9.75	9.75
MCS8_15	2	9.75	9.75
VHT8_9SS2	2	9.75	9.75
DSSS_MULT12	3	-	-
OFDM_CDD2	3	-	-
MCS0_7_CDD2	3	-	-
VHT8_9SS1_CDD2	3	-	-
MCS0_7_STBC_SPEXP1	3	-	-
VHT8_9SS1_STBC_SPEXP1	3	-	-
MCS8_15_SPEXP1	3	-	-
VHT8_9SS2_SPEXP1	3	-	-
MCS16_23	3	-	-
VHT8_9SS3	3	-	-
OFDM_TXBF1	2	-	-
MCS0_7_TXBF1	2	-	-
VHT8_9SS1_TXBF1	2	-	-
MCS8_15_TXBF0	2	-	-

OFDM_TXBF2	3	-	-
MCS0_7_TXBF2	3	-	-
VHT8_9SS1_TXBF2	3	-	-
MCS8_15_TXBF1	3	-	-
VHT8_9SS2_TXBF1	3	-	-
MCS16_23_TXBF0	3	-	-

Core Index: 0

Board Limits:

Rate	Chains 20in40 40MHz		
DSSS	1	20.25	20.25
OFDM6	1	17.75	17.75
OFDM9	1	17.75	17.75
OFDM12	1	17.75	17.75
OFDM18	1	17.75	17.75
OFDM24	1	17.75	17.75
OFDM36	1	17.75	17.75
OFDM48	1	17.25	17.25
OFDM54	1	17.25	17.25
MCS0	1	17.75	17.75
MCS1	1	17.75	17.75
MCS2	1	17.75	17.75
MCS3	1	17.75	17.75
MCS4	1	17.75	17.75
MCS5	1	17.25	17.25
MCS6	1	17.25	17.25
MCS7	1	16.75	16.75
VHT8_9SS1	1	-	-

DSSS_MULT11	2	20.25	20.25
OFDM6_CDD1	2	17.75	17.75
OFDM9_CDD1	2	17.75	17.75
OFDM12_CDD1	2	17.75	17.75
OFDM18_CDD1	2	17.75	17.75
OFDM24_CDD1	2	17.75	17.75
OFDM36_CDD1	2	17.75	17.75
OFDM48_CDD1	2	17.25	17.25
OFDM54_CDD1	2	17.25	17.25
MCS0_CDD1	2	17.75	17.75
MCS1_CDD1	2	17.75	17.75
MCS2_CDD1	2	17.75	17.75
MCS3_CDD1	2	17.75	17.75
MCS4_CDD1	2	17.75	17.75
MCS5_CDD1	2	17.25	17.25
MCS6_CDD1	2	17.25	17.25
MCS7_CDD1	2	16.75	16.75
VHT8_9SS1_CDD1	2	-	-
MCS0_STBC	2	17.75	17.75
MCS1_STBC	2	17.75	17.75
MCS2_STBC	2	17.75	17.75
MCS3_STBC	2	17.75	17.75
MCS4_STBC	2	17.75	17.75
MCS5_STBC	2	17.25	17.25
MCS6_STBC	2	17.25	17.25
MCS7_STBC	2	16.75	16.75
VHT8_9SS1_STBC	2	-	-
MCS8	2	17.75	17.75

MCS9	2	17.75	17.75
MCS10	2	17.75	17.75
MCS11	2	17.75	17.75
MCS12	2	17.75	17.75
MCS13	2	17.25	17.25
MCS14	2	17.25	17.25
MCS15	2	16.75	16.75
VHT8_9SS2	2	-	-
DSSS_MULT12	3	-	-
OFDM_CDD2	3	-	-
MCS0_7_CDD2	3	-	-
VHT8_9SS1_CDD2	3	-	-
MCS0_7_STBC_SPEXP1	3	-	-
VHT8_9SS1_STBC_SPEXP1	3	-	-
MCS8_15_SPEXP1	3	-	-
VHT8_9SS2_SPEXP1	3	-	-
MCS16_23	3	-	-
VHT8_9SS3	3	-	-
OFDM_TXBF1	2	-	-
MCS0_7_TXBF1	2	-	-
VHT8_9SS1_TXBF1	2	-	-
MCS8_15_TXBF0	2	-	-
OFDM_TXBF2	3	-	-
MCS0_7_TXBF2	3	-	-
VHT8_9SS1_TXBF2	3	-	-
MCS8_15_TXBF1	3	-	-
VHT8_9SS2_TXBF1	3	-	-
MCS16_23_TXBF0	3	-	-

Power Targets:

Rate	Chains 20in40 40MHz		
DSSS	1	16.25	8.00
OFDM	1	9.25	9.25
MCS0_7	1	9.25	9.25
VHT8_9SS1	1	8.00	8.00
DSSS_MULT11	2	8.00	8.00
OFDM_CDD1	2	9.00	9.00
MCS0_7_CDD1	2	9.00	9.00
VHT8_9SS1_CDD1	2	8.00	8.00
MCS0_7_STBC	2	9.00	9.00
VHT8_9SS1_STBC	2	8.00	8.00
MCS8_15	2	9.00	9.00
VHT8_9SS2	2	8.00	8.00
DSSS_MULT12	3	8.00	8.00
OFDM_CDD2	3	8.00	8.00
MCS0_7_CDD2	3	8.00	8.00
VHT8_9SS1_CDD2	3	8.00	8.00
MCS0_7_STBC_SPEXP1	3	8.00	8.00
VHT8_9SS1_STBC_SPEXP1	3	8.00	8.00
MCS8_15_SPEXP1	3	8.00	8.00
VHT8_9SS2_SPEXP1	3	8.00	8.00
MCS16_23	3	8.00	8.00
VHT8_9SS3	3	8.00	8.00
OFDM_TXBF1	2	8.00	8.00
MCS0_7_TXBF1	2	8.00	8.00
VHT8_9SS1_TXBF1	2	8.00	8.00

MCS8_15_TXBF0	2	8.00	8.00
OFDM_TXBF2	3	8.00	8.00
MCS0_7_TXBF2	3	8.00	8.00
VHT8_9SS1_TXBF2	3	8.00	8.00
MCS8_15_TXBF1	3	8.00	8.00
VHT8_9SS2_TXBF1	3	8.00	8.00
MCS16_23_TXBF0	3	8.00	8.00

Maximum Power Target among all rates: 16.25 16.25

Last est. power : 16.00 0.00

Power Target for the current rate : 9.00 9.00

Last adjusted est. power : 16.00 0.00

root@OpenWrt:~#

root@OpenWrt:~# wl down

root@OpenWrt:~# wl chanspec 3l

Chanspec set to 0x1805

root@OpenWrt:~# wl up

root@OpenWrt:~# wl curpower

Power Control: On, HW

Current Channel: 3l

BSS Channel: 3l

BSS Local Max: 30.0 dBm

BSS Local Constraint: 0.0 dB

Channel Width: 40MHz

User Target: 31.75 dBm

SROM Antgain 2G: 3.25 dB / 3.50 dB

SROM Antgain 5G: 0.0 dB / 0.0 dB

SAR: -

Open loop: Off
 Current rate: [MCS15] ht mcs 15 Tx Exp 0 BW 40

Power Adjust: abs 0.0 dB (disabled)

Calibration acc: 0.75 dB

TXChain compensation: txch offset + ch offset

TXChain 1: 1.0 + 0.0 = 1.0 dB

TXChain 2: 0.50 + 0.0 = 0.50 dB

NOTE: Regulatory Limits, board limits and target power are for core 0

Use "wl curpower_display_core" to select another one

NOTE: Regulatory limit is conducted -> Antenna gain is ignored

Regulatory Limits:

Rate	Chains 20in40 40MHz		
DSSS	1	17.00	17.00
OFDM	1	13.25	13.25
MCS0_7	1	13.25	13.25
VHT8_9SS1	1	13.25	13.25
DSSS_MULT11	2	-	-
OFDM_CDD1	2	13.00	13.00
MCS0_7_CDD1	2	13.00	13.00
VHT8_9SS1_CDD1	2	13.00	13.00
MCS0_7_STBC	2	13.00	13.00
VHT8_9SS1_STBC	2	13.00	13.00

MCS8_15	2	13.00	13.00
VHT8_9SS2	2	13.00	13.00
DSSS_MULT12	3	-	-
OFDM_CDD2	3	-	-
MCS0_7_CDD2	3	-	-
VHT8_9SS1_CDD2	3	-	-
MCS0_7_STBC_SPEXP1	3	-	-
VHT8_9SS1_STBC_SPEXP1	3	-	-
MCS8_15_SPEXP1	3	-	-
VHT8_9SS2_SPEXP1	3	-	-
MCS16_23	3	-	-
VHT8_9SS3	3	-	-
OFDM_TXBF1	2	-	-
MCS0_7_TXBF1	2	-	-
VHT8_9SS1_TXBF1	2	-	-
MCS8_15_TXBF0	2	-	-
OFDM_TXBF2	3	-	-
MCS0_7_TXBF2	3	-	-
VHT8_9SS1_TXBF2	3	-	-
MCS8_15_TXBF1	3	-	-
VHT8_9SS2_TXBF1	3	-	-
MCS16_23_TXBF0	3	-	-

Core Index: 0

Board Limits:

Rate Chains 20in40 40MHz

DSSS 1 20.25 20.25

OFDM6 1 17.75 17.75

OFDM9	1	17.75	17.75
OFDM12	1	17.75	17.75
OFDM18	1	17.75	17.75
OFDM24	1	17.75	17.75
OFDM36	1	17.75	17.75
OFDM48	1	17.25	17.25
OFDM54	1	17.25	17.25
MCS0	1	17.75	17.75
MCS1	1	17.75	17.75
MCS2	1	17.75	17.75
MCS3	1	17.75	17.75
MCS4	1	17.75	17.75
MCS5	1	17.25	17.25
MCS6	1	17.25	17.25
MCS7	1	16.75	16.75
VHT8_9SS1	1	-	-
DSSS_MULT11	2	20.25	20.25
OFDM6_CDD1	2	17.75	17.75
OFDM9_CDD1	2	17.75	17.75
OFDM12_CDD1	2	17.75	17.75
OFDM18_CDD1	2	17.75	17.75
OFDM24_CDD1	2	17.75	17.75
OFDM36_CDD1	2	17.75	17.75
OFDM48_CDD1	2	17.25	17.25
OFDM54_CDD1	2	17.25	17.25
MCS0_CDD1	2	17.75	17.75
MCS1_CDD1	2	17.75	17.75
MCS2_CDD1	2	17.75	17.75

MCS3_CDD1	2	17.75	17.75
MCS4_CDD1	2	17.75	17.75
MCS5_CDD1	2	17.25	17.25
MCS6_CDD1	2	17.25	17.25
MCS7_CDD1	2	16.75	16.75
VHT8_9SS1_CDD1	2	-	-
MCS0_STBC	2	17.75	17.75
MCS1_STBC	2	17.75	17.75
MCS2_STBC	2	17.75	17.75
MCS3_STBC	2	17.75	17.75
MCS4_STBC	2	17.75	17.75
MCS5_STBC	2	17.25	17.25
MCS6_STBC	2	17.25	17.25
MCS7_STBC	2	16.75	16.75
VHT8_9SS1_STBC	2	-	-
MCS8	2	17.75	17.75
MCS9	2	17.75	17.75
MCS10	2	17.75	17.75
MCS11	2	17.75	17.75
MCS12	2	17.75	17.75
MCS13	2	17.25	17.25
MCS14	2	17.25	17.25
MCS15	2	16.75	16.75
VHT8_9SS2	2	-	-
DSSS_MULT12	3	-	-
OFDM_CDD2	3	-	-
MCS0_7_CDD2	3	-	-
VHT8_9SS1_CDD2	3	-	-

MCS0_7_STBC_SPEXP1	3	-	-
VHT8_9SS1_STBC_SPEXP1	3	-	-
MCS8_15_SPEXP1	3	-	-
VHT8_9SS2_SPEXP1	3	-	-
MCS16_23	3	-	-
VHT8_9SS3	3	-	-
OFDM_TXBF1	2	-	-
MCS0_7_TXBF1	2	-	-
VHT8_9SS1_TXBF1	2	-	-
MCS8_15_TXBF0	2	-	-
OFDM_TXBF2	3	-	-
MCS0_7_TXBF2	3	-	-
VHT8_9SS1_TXBF2	3	-	-
MCS8_15_TXBF1	3	-	-
VHT8_9SS2_TXBF1	3	-	-
MCS16_23_TXBF0	3	-	-

Power Targets:

Rate	Chains 20in40 40MHz		
DSSS	1	16.25	8.00
OFDM	1	12.50	12.50
MCS0_7	1	12.50	12.50
VHT8_9SS1	1	8.00	8.00
DSSS_MULT11	2	8.00	8.00
OFDM_CDD1	2	12.25	12.25
MCS0_7_CDD1	2	12.25	12.25
VHT8_9SS1_CDD1	2	8.00	8.00
MCS0_7_STBC	2	12.25	12.25

VHT8_9SS1_STBC	2	8.00	8.00
MCS8_15	2	12.25	12.25
VHT8_9SS2	2	8.00	8.00
DSSS_MULT12	3	8.00	8.00
OFDM_CDD2	3	8.00	8.00
MCS0_7_CDD2	3	8.00	8.00
VHT8_9SS1_CDD2	3	8.00	8.00
MCS0_7_STBC_SPEXP1	3	8.00	8.00
VHT8_9SS1_STBC_SPEXP1	3	8.00	8.00
MCS8_15_SPEXP1	3	8.00	8.00
VHT8_9SS2_SPEXP1	3	8.00	8.00
MCS16_23	3	8.00	8.00
VHT8_9SS3	3	8.00	8.00
OFDM_TXBF1	2	8.00	8.00
MCS0_7_TXBF1	2	8.00	8.00
VHT8_9SS1_TXBF1	2	8.00	8.00
MCS8_15_TXBF0	2	8.00	8.00
OFDM_TXBF2	3	8.00	8.00
MCS0_7_TXBF2	3	8.00	8.00
VHT8_9SS1_TXBF2	3	8.00	8.00
MCS8_15_TXBF1	3	8.00	8.00
VHT8_9SS2_TXBF1	3	8.00	8.00
MCS16_23_TXBF0	3	8.00	8.00
Maximum Power Target among all rates: 16.25 16.25			
Last est. power : 0.00 17.25			
Power Target for the current rate : 12.25 12.25			
Last adjusted est. power : 0.00 17.25			

```
root@OpenWrt:~#  
root@OpenWrt:~# wl down  
root@OpenWrt:~# wl chanspec 4l  
Chanspec set to 0x1806  
root@OpenWrt:~# wl up  
root@OpenWrt:~# wl curpower  
Power Control:      On, HW  
Current Channel:    4l  
BSS Channel:       4l  
BSS Local Max:     30.0 dBm  
BSS Local Constraint: 0.0 dB  
Channel Width:     40MHz  
User Target:       31.75 dBm  
SROM Antgain 2G:   3.25 dB / 3.50 dB  
SROM Antgain 5G:   0.0 dB / 0.0 dB  
SAR:               -  
Open loop:         Off  
Current rate:      [MCS15] ht mcs 15 Tx Exp 0 BW 40  
  
Power Adjust:      abs 0.0 dB (disabled)  
Calibration acc:   0.75 dB  
TXChain compensation: txch offset + ch offset  
  
TXChain 1:         1.0 + 0.0 = 1.0 dB  
  
TXChain 2:         0.50 + 0.0 = 0.50 dB
```

NOTE: Regulatory Limits, board limits and target power are for core 0

Use "wl curpower_display_core" to select another one

NOTE: Regulatory limit is conducted -> Antenna gain is ignored

Regulatory Limits:

Rate	Chains 20in40 40MHz		
DSSS	1	17.00	17.00
OFDM	1	13.25	13.25
MCS0_7	1	13.25	13.25
VHT8_9SS1	1	13.25	13.25
DSSS_MULT11	2	-	-
OFDM_CDD1	2	13.00	13.00
MCS0_7_CDD1	2	13.00	13.00
VHT8_9SS1_CDD1	2	13.00	13.00
MCS0_7_STBC	2	13.00	13.00
VHT8_9SS1_STBC	2	13.00	13.00
MCS8_15	2	13.00	13.00
VHT8_9SS2	2	13.00	13.00
DSSS_MULT12	3	-	-
OFDM_CDD2	3	-	-
MCS0_7_CDD2	3	-	-
VHT8_9SS1_CDD2	3	-	-
MCS0_7_STBC_SPEXP1	3	-	-
VHT8_9SS1_STBC_SPEXP1	3	-	-
MCS8_15_SPEXP1	3	-	-
VHT8_9SS2_SPEXP1	3	-	-
MCS16_23	3	-	-
VHT8_9SS3	3	-	-

OFDM_TXBF1	2	-	-
MCS0_7_TXBF1	2	-	-
VHT8_9SS1_TXBF1	2	-	-
MCS8_15_TXBF0	2	-	-
OFDM_TXBF2	3	-	-
MCS0_7_TXBF2	3	-	-
VHT8_9SS1_TXBF2	3	-	-
MCS8_15_TXBF1	3	-	-
VHT8_9SS2_TXBF1	3	-	-
MCS16_23_TXBF0	3	-	-

Core Index: 0

Board Limits:

Rate	Chains 20in40 40MHz		
DSSS	1	20.25	20.25
OFDM6	1	17.75	17.75
OFDM9	1	17.75	17.75
OFDM12	1	17.75	17.75
OFDM18	1	17.75	17.75
OFDM24	1	17.75	17.75
OFDM36	1	17.75	17.75
OFDM48	1	17.25	17.25
OFDM54	1	17.25	17.25
MCS0	1	17.75	17.75
MCS1	1	17.75	17.75
MCS2	1	17.75	17.75
MCS3	1	17.75	17.75
MCS4	1	17.75	17.75

MCS5	1	17.25	17.25
MCS6	1	17.25	17.25
MCS7	1	16.75	16.75
VHT8_9SS1	1	-	-
DSSS_MULT11	2	20.25	20.25
OFDM6_CDD1	2	17.75	17.75
OFDM9_CDD1	2	17.75	17.75
OFDM12_CDD1	2	17.75	17.75
OFDM18_CDD1	2	17.75	17.75
OFDM24_CDD1	2	17.75	17.75
OFDM36_CDD1	2	17.75	17.75
OFDM48_CDD1	2	17.25	17.25
OFDM54_CDD1	2	17.25	17.25
MCS0_CDD1	2	17.75	17.75
MCS1_CDD1	2	17.75	17.75
MCS2_CDD1	2	17.75	17.75
MCS3_CDD1	2	17.75	17.75
MCS4_CDD1	2	17.75	17.75
MCS5_CDD1	2	17.25	17.25
MCS6_CDD1	2	17.25	17.25
MCS7_CDD1	2	16.75	16.75
VHT8_9SS1_CDD1	2	-	-
MCS0_STBC	2	17.75	17.75
MCS1_STBC	2	17.75	17.75
MCS2_STBC	2	17.75	17.75
MCS3_STBC	2	17.75	17.75
MCS4_STBC	2	17.75	17.75
MCS5_STBC	2	17.25	17.25

MCS6_STBC	2	17.25	17.25
MCS7_STBC	2	16.75	16.75
VHT8_9SS1_STBC	2	-	-
MCS8	2	17.75	17.75
MCS9	2	17.75	17.75
MCS10	2	17.75	17.75
MCS11	2	17.75	17.75
MCS12	2	17.75	17.75
MCS13	2	17.25	17.25
MCS14	2	17.25	17.25
MCS15	2	16.75	16.75
VHT8_9SS2	2	-	-
DSSS_MULT12	3	-	-
OFDM_CDD2	3	-	-
MCS0_7_CDD2	3	-	-
VHT8_9SS1_CDD2	3	-	-
MCS0_7_STBC_SPEXP1	3	-	-
VHT8_9SS1_STBC_SPEXP1	3	-	-
MCS8_15_SPEXP1	3	-	-
VHT8_9SS2_SPEXP1	3	-	-
MCS16_23	3	-	-
VHT8_9SS3	3	-	-
OFDM_TXBF1	2	-	-
MCS0_7_TXBF1	2	-	-
VHT8_9SS1_TXBF1	2	-	-
MCS8_15_TXBF0	2	-	-
OFDM_TXBF2	3	-	-
MCS0_7_TXBF2	3	-	-

VHT8_9SS1_TXBF2	3	-	-
MCS8_15_TXBF1	3	-	-
VHT8_9SS2_TXBF1	3	-	-
MCS16_23_TXBF0	3	-	-

Power Targets:

Rate	Chains 20in40 40MHz		
DSSS	1	16.25	8.00
OFDM	1	12.50	12.50
MCS0_7	1	12.50	12.50
VHT8_9SS1	1	8.00	8.00
DSSS_MULT11	2	8.00	8.00
OFDM_CDD1	2	12.25	12.25
MCS0_7_CDD1	2	12.25	12.25
VHT8_9SS1_CDD1	2	8.00	8.00
MCS0_7_STBC	2	12.25	12.25
VHT8_9SS1_STBC	2	8.00	8.00
MCS8_15	2	12.25	12.25
VHT8_9SS2	2	8.00	8.00
DSSS_MULT12	3	8.00	8.00
OFDM_CDD2	3	8.00	8.00
MCS0_7_CDD2	3	8.00	8.00
VHT8_9SS1_CDD2	3	8.00	8.00
MCS0_7_STBC_SPEXP1	3	8.00	8.00
VHT8_9SS1_STBC_SPEXP1	3	8.00	8.00
MCS8_15_SPEXP1	3	8.00	8.00
VHT8_9SS2_SPEXP1	3	8.00	8.00
MCS16_23	3	8.00	8.00

VHT8_9SS3	3	8.00	8.00
OFDM_TXBF1	2	8.00	8.00
MCS0_7_TXBF1	2	8.00	8.00
VHT8_9SS1_TXBF1	2	8.00	8.00
MCS8_15_TXBF0	2	8.00	8.00
OFDM_TXBF2	3	8.00	8.00
MCS0_7_TXBF2	3	8.00	8.00
VHT8_9SS1_TXBF2	3	8.00	8.00
MCS8_15_TXBF1	3	8.00	8.00
VHT8_9SS2_TXBF1	3	8.00	8.00
MCS16_23_TXBF0	3	8.00	8.00

Maximum Power Target among all rates: 16.25 16.25

Last est. power : 0.00 17.50

Power Target for the current rate : 12.25 12.25

Last adjusted est. power : 0.00 17.50

root@OpenWrt:~#

root@OpenWrt:~# wl down

root@OpenWrt:~# wl chanspec 5l

Chanspec set to 0x1807

root@OpenWrt:~# wl up

root@OpenWrt:~# wl curpower

Power Control: On, HW

Current Channel: 5l

BSS Channel: 5l

BSS Local Max: 30.0 dBm

BSS Local Constraint: 0.0 dB

Channel Width: 40MHz

User Target: 31.75 dBm
 SROM Antgain 2G: 3.25 dB / 3.50 dB
 SROM Antgain 5G: 0.0 dB / 0.0 dB
 SAR: -
 Open loop: Off
 Current rate: [MCS15] ht mcs 15 Tx Exp 0 BW 40

 Power Adjust: abs 0.0 dB (disabled)
 Calibration acc: 0.75 dB
 TXChain compensation: txch offset + ch offset

 TXChain 1: $1.0 + -0.25 = 0.75$ dB

 TXChain 2: $0.50 + 0.0 = 0.50$ dB

NOTE: Regulatory Limits, board limits and target power are for core 0

Use "wl curpower_display_core" to select another one

NOTE: Regulatory limit is conducted -> Antenna gain is ignored

Regulatory Limits:

Rate	Chains 20in40 40MHz		
DSSS	1	17.00	17.00
OFDM	1	13.25	13.25
MCS0_7	1	13.25	13.25
VHT8_9SS1	1	13.25	13.25
DSSS_MULT11	2	-	-
OFDM_CDD1	2	13.00	13.00

MCS0_7_CDD1	2	13.00	13.00
VHT8_9SS1_CDD1	2	13.00	13.00
MCS0_7_STBC	2	13.00	13.00
VHT8_9SS1_STBC	2	13.00	13.00
MCS8_15	2	13.00	13.00
VHT8_9SS2	2	13.00	13.00
DSSS_MULT12	3	-	-
OFDM_CDD2	3	-	-
MCS0_7_CDD2	3	-	-
VHT8_9SS1_CDD2	3	-	-
MCS0_7_STBC_SPEXP1	3	-	-
VHT8_9SS1_STBC_SPEXP1	3	-	-
MCS8_15_SPEXP1	3	-	-
VHT8_9SS2_SPEXP1	3	-	-
MCS16_23	3	-	-
VHT8_9SS3	3	-	-
OFDM_TXBF1	2	-	-
MCS0_7_TXBF1	2	-	-
VHT8_9SS1_TXBF1	2	-	-
MCS8_15_TXBF0	2	-	-
OFDM_TXBF2	3	-	-
MCS0_7_TXBF2	3	-	-
VHT8_9SS1_TXBF2	3	-	-
MCS8_15_TXBF1	3	-	-
VHT8_9SS2_TXBF1	3	-	-
MCS16_23_TXBF0	3	-	-

Core Index: 0

Board Limits:

Rate	Chains 20in40 40MHz		
DSSS	1	20.25	20.25
OFDM6	1	17.75	17.75
OFDM9	1	17.75	17.75
OFDM12	1	17.75	17.75
OFDM18	1	17.75	17.75
OFDM24	1	17.75	17.75
OFDM36	1	17.75	17.75
OFDM48	1	17.25	17.25
OFDM54	1	17.25	17.25
MCS0	1	17.75	17.75
MCS1	1	17.75	17.75
MCS2	1	17.75	17.75
MCS3	1	17.75	17.75
MCS4	1	17.75	17.75
MCS5	1	17.25	17.25
MCS6	1	17.25	17.25
MCS7	1	16.75	16.75
VHT8_9SS1	1	-	-
DSSS_MULT11	2	20.25	20.25
OFDM6_CDD1	2	17.75	17.75
OFDM9_CDD1	2	17.75	17.75
OFDM12_CDD1	2	17.75	17.75
OFDM18_CDD1	2	17.75	17.75
OFDM24_CDD1	2	17.75	17.75
OFDM36_CDD1	2	17.75	17.75
OFDM48_CDD1	2	17.25	17.25

OFDM54_CDD1	2	17.25	17.25
MCS0_CDD1	2	17.75	17.75
MCS1_CDD1	2	17.75	17.75
MCS2_CDD1	2	17.75	17.75
MCS3_CDD1	2	17.75	17.75
MCS4_CDD1	2	17.75	17.75
MCS5_CDD1	2	17.25	17.25
MCS6_CDD1	2	17.25	17.25
MCS7_CDD1	2	16.75	16.75
VHT8_9SS1_CDD1	2	-	-
MCS0_STBC	2	17.75	17.75
MCS1_STBC	2	17.75	17.75
MCS2_STBC	2	17.75	17.75
MCS3_STBC	2	17.75	17.75
MCS4_STBC	2	17.75	17.75
MCS5_STBC	2	17.25	17.25
MCS6_STBC	2	17.25	17.25
MCS7_STBC	2	16.75	16.75
VHT8_9SS1_STBC	2	-	-
MCS8	2	17.75	17.75
MCS9	2	17.75	17.75
MCS10	2	17.75	17.75
MCS11	2	17.75	17.75
MCS12	2	17.75	17.75
MCS13	2	17.25	17.25
MCS14	2	17.25	17.25
MCS15	2	16.75	16.75
VHT8_9SS2	2	-	-

DSSS_MULT12	3	-	-
OFDM_CDD2	3	-	-
MCS0_7_CDD2	3	-	-
VHT8_9SS1_CDD2	3	-	-
MCS0_7_STBC_SPEXP1	3	-	-
VHT8_9SS1_STBC_SPEXP1	3	-	-
MCS8_15_SPEXP1	3	-	-
VHT8_9SS2_SPEXP1	3	-	-
MCS16_23	3	-	-
VHT8_9SS3	3	-	-
OFDM_TXBF1	2	-	-
MCS0_7_TXBF1	2	-	-
VHT8_9SS1_TXBF1	2	-	-
MCS8_15_TXBF0	2	-	-
OFDM_TXBF2	3	-	-
MCS0_7_TXBF2	3	-	-
VHT8_9SS1_TXBF2	3	-	-
MCS8_15_TXBF1	3	-	-
VHT8_9SS2_TXBF1	3	-	-
MCS16_23_TXBF0	3	-	-

Power Targets:

Rate	Chains 20in40 40MHz		
DSSS	1	16.25	8.00
OFDM	1	12.50	12.50
MCS0_7	1	12.50	12.50
VHT8_9SS1	1	8.00	8.00
DSSS_MULT11	2	8.00	8.00

OFDM_CDD1	2	12.25	12.25
MCS0_7_CDD1	2	12.25	12.25
VHT8_9SS1_CDD1	2	8.00	8.00
MCS0_7_STBC	2	12.25	12.25
VHT8_9SS1_STBC	2	8.00	8.00
MCS8_15	2	12.25	12.25
VHT8_9SS2	2	8.00	8.00
DSSS_MULTI2	3	8.00	8.00
OFDM_CDD2	3	8.00	8.00
MCS0_7_CDD2	3	8.00	8.00
VHT8_9SS1_CDD2	3	8.00	8.00
MCS0_7_STBC_SPEXP1	3	8.00	8.00
VHT8_9SS1_STBC_SPEXP1	3	8.00	8.00
MCS8_15_SPEXP1	3	8.00	8.00
VHT8_9SS2_SPEXP1	3	8.00	8.00
MCS16_23	3	8.00	8.00
VHT8_9SS3	3	8.00	8.00
OFDM_TXBF1	2	8.00	8.00
MCS0_7_TXBF1	2	8.00	8.00
VHT8_9SS1_TXBF1	2	8.00	8.00
MCS8_15_TXBF0	2	8.00	8.00
OFDM_TXBF2	3	8.00	8.00
MCS0_7_TXBF2	3	8.00	8.00
VHT8_9SS1_TXBF2	3	8.00	8.00
MCS8_15_TXBF1	3	8.00	8.00
VHT8_9SS2_TXBF1	3	8.00	8.00
MCS16_23_TXBF0	3	8.00	8.00

Maximum Power Target among all rates: 16.25 16.25

Last est. power : 0.00 17.50

Power Target for the current rate : 12.25 12.25

Last adjusted est. power : 0.00 17.50

root@OpenWrt:~#

root@OpenWrt:~# wl down

root@OpenWrt:~# wl chanspec 6l

Chanspec set to 0x1808

root@OpenWrt:~# wl up

root@OpenWrt:~# wl curpower

Power Control: On, HW

Current Channel: 6l

BSS Channel: 6l

BSS Local Max: 30.0 dBm

BSS Local Constraint: 0.0 dB

Channel Width: 40MHz

User Target: 31.75 dBm

SROM Antgain 2G: 3.25 dB / 3.50 dB

SROM Antgain 5G: 0.0 dB / 0.0 dB

SAR: -

Open loop: Off

Current rate: [MCS15] ht mcs 15 Tx Exp 0 BW 40

Power Adjust: abs 0.0 dB (disabled)

Calibration acc: 0.75 dB

TXChain compensation: txch offset + ch offset

TXChain 1: 1.0 + 0.0 = 1.0 dB

TXChain 2: 0.50 + 0.0 = 0.50 dB

NOTE: Regulatory Limits, board limits and target power are for core 0

Use "wl curpower_display_core" to select another one

NOTE: Regulatory limit is conducted -> Antenna gain is ignored

Regulatory Limits:

Rate	Chains 20in40 40MHz		
DSSS	1	17.00	17.00
OFDM	1	9.75	9.75
MCS0_7	1	9.75	9.75
VHT8_9SS1	1	9.75	9.75
DSSS_MULT11	2	-	-
OFDM_CDD1	2	8.25	8.25
MCS0_7_CDD1	2	8.25	8.25
VHT8_9SS1_CDD1	2	8.25	8.25
MCS0_7_STBC	2	8.25	8.25
VHT8_9SS1_STBC	2	8.25	8.25
MCS8_15	2	8.25	8.25
VHT8_9SS2	2	8.25	8.25
DSSS_MULT12	3	-	-
OFDM_CDD2	3	-	-
MCS0_7_CDD2	3	-	-
VHT8_9SS1_CDD2	3	-	-
MCS0_7_STBC_SPEXP1	3	-	-
VHT8_9SS1_STBC_SPEXP1	3	-	-

MCS8_15_SPEXP1	3	-	-
VHT8_9SS2_SPEXP1	3	-	-
MCS16_23	3	-	-
VHT8_9SS3	3	-	-
OFDM_TXBF1	2	-	-
MCS0_7_TXBF1	2	-	-
VHT8_9SS1_TXBF1	2	-	-
MCS8_15_TXBF0	2	-	-
OFDM_TXBF2	3	-	-
MCS0_7_TXBF2	3	-	-
VHT8_9SS1_TXBF2	3	-	-
MCS8_15_TXBF1	3	-	-
VHT8_9SS2_TXBF1	3	-	-
MCS16_23_TXBF0	3	-	-

Core Index: 0

Board Limits:

Rate	Chains 20in40 40MHz		
DSSS	1	20.25	20.25
OFDM6	1	17.75	17.75
OFDM9	1	17.75	17.75
OFDM12	1	17.75	17.75
OFDM18	1	17.75	17.75
OFDM24	1	17.75	17.75
OFDM36	1	17.75	17.75
OFDM48	1	17.25	17.25
OFDM54	1	17.25	17.25
MCS0	1	17.75	17.75

MCS1	1	17.75	17.75
MCS2	1	17.75	17.75
MCS3	1	17.75	17.75
MCS4	1	17.75	17.75
MCS5	1	17.25	17.25
MCS6	1	17.25	17.25
MCS7	1	16.75	16.75
VHT8_9SS1	1	-	-
DSSS_MULT11	2	20.25	20.25
OFDM6_CDD1	2	17.75	17.75
OFDM9_CDD1	2	17.75	17.75
OFDM12_CDD1	2	17.75	17.75
OFDM18_CDD1	2	17.75	17.75
OFDM24_CDD1	2	17.75	17.75
OFDM36_CDD1	2	17.75	17.75
OFDM48_CDD1	2	17.25	17.25
OFDM54_CDD1	2	17.25	17.25
MCS0_CDD1	2	17.75	17.75
MCS1_CDD1	2	17.75	17.75
MCS2_CDD1	2	17.75	17.75
MCS3_CDD1	2	17.75	17.75
MCS4_CDD1	2	17.75	17.75
MCS5_CDD1	2	17.25	17.25
MCS6_CDD1	2	17.25	17.25
MCS7_CDD1	2	16.75	16.75
VHT8_9SS1_CDD1	2	-	-
MCS0_STBC	2	17.75	17.75
MCS1_STBC	2	17.75	17.75

MCS2_STBC	2	17.75	17.75
MCS3_STBC	2	17.75	17.75
MCS4_STBC	2	17.75	17.75
MCS5_STBC	2	17.25	17.25
MCS6_STBC	2	17.25	17.25
MCS7_STBC	2	16.75	16.75
VHT8_9SS1_STBC	2	-	-
MCS8	2	17.75	17.75
MCS9	2	17.75	17.75
MCS10	2	17.75	17.75
MCS11	2	17.75	17.75
MCS12	2	17.75	17.75
MCS13	2	17.25	17.25
MCS14	2	17.25	17.25
MCS15	2	16.75	16.75
VHT8_9SS2	2	-	-
DSSS_MULT12	3	-	-
OFDM_CDD2	3	-	-
MCS0_7_CDD2	3	-	-
VHT8_9SS1_CDD2	3	-	-
MCS0_7_STBC_SPEXP1	3	-	-
VHT8_9SS1_STBC_SPEXP1	3	-	-
MCS8_15_SPEXP1	3	-	-
VHT8_9SS2_SPEXP1	3	-	-
MCS16_23	3	-	-
VHT8_9SS3	3	-	-
OFDM_TXBF1	2	-	-
MCS0_7_TXBF1	2	-	-

VHT8_9SS1_TXBF1	2	-	-
MCS8_15_TXBF0	2	-	-
OFDM_TXBF2	3	-	-
MCS0_7_TXBF2	3	-	-
VHT8_9SS1_TXBF2	3	-	-
MCS8_15_TXBF1	3	-	-
VHT8_9SS2_TXBF1	3	-	-
MCS16_23_TXBF0	3	-	-

Power Targets:

Rate	Chains 20in40 40MHz		
DSSS	1	16.25	8.00
OFDM	1	9.00	9.00
MCS0_7	1	9.00	9.00
VHT8_9SS1	1	8.00	8.00
DSSS_MULT11	2	8.00	8.00
OFDM_CDD1	2	8.00	8.00
MCS0_7_CDD1	2	8.00	8.00
VHT8_9SS1_CDD1	2	8.00	8.00
MCS0_7_STBC	2	8.00	8.00
VHT8_9SS1_STBC	2	8.00	8.00
MCS8_15	2	8.00	8.00
VHT8_9SS2	2	8.00	8.00
DSSS_MULT12	3	8.00	8.00
OFDM_CDD2	3	8.00	8.00
MCS0_7_CDD2	3	8.00	8.00
VHT8_9SS1_CDD2	3	8.00	8.00
MCS0_7_STBC_SPEXP1	3	8.00	8.00

VHT8_9SS1_STBC_SPEXP1	3	8.00	8.00
MCS8_15_SPEXP1	3	8.00	8.00
VHT8_9SS2_SPEXP1	3	8.00	8.00
MCS16_23	3	8.00	8.00
VHT8_9SS3	3	8.00	8.00
OFDM_TXBF1	2	8.00	8.00
MCS0_7_TXBF1	2	8.00	8.00
VHT8_9SS1_TXBF1	2	8.00	8.00
MCS8_15_TXBF0	2	8.00	8.00
OFDM_TXBF2	3	8.00	8.00
MCS0_7_TXBF2	3	8.00	8.00
VHT8_9SS1_TXBF2	3	8.00	8.00
MCS8_15_TXBF1	3	8.00	8.00
VHT8_9SS2_TXBF1	3	8.00	8.00
MCS16_23_TXBF0	3	8.00	8.00

Maximum Power Target among all rates: 16.25 16.25

Last est. power : 0.00 17.50

Power Target for the current rate : 8.00 8.00

Last adjusted est. power : 0.00 17.50

root@OpenWrt:~#

root@OpenWrt:~# wl down

root@OpenWrt:~# wl chanspec 7l

Chanspec set to 0x1809

root@OpenWrt:~# wl up

root@OpenWrt:~# wl curpower

Power Control: On, HW

Current Channel: 7l

BSS Channel: 71
 BSS Local Max: 30.0 dBm
 BSS Local Constraint: 0.0 dB
 Channel Width: 40MHz
 User Target: 31.75 dBm
 SROM Antgain 2G: 3.25 dB / 3.50 dB
 SROM Antgain 5G: 0.0 dB / 0.0 dB
 SAR: -
 Open loop: Off
 Current rate: [MCS15] ht mcs 15 Tx Exp 0 BW 40

Power Adjust: abs 0.0 dB (disabled)

Calibration acc: 0.75 dB

TXChain compensation: txch offset + ch offset

TXChain 1: $1.0 + 0.0 = 1.0$ dB

TXChain 2: $0.50 + 0.0 = 0.50$ dB

NOTE: Regulatory Limits, board limits and target power are for core 0

Use "wl curpower_display_core" to select another one

NOTE: Regulatory limit is conducted -> Antenna gain is ignored

Regulatory Limits:

Rate	Chains 20in40 40MHz		
DSSS	1	17.00	17.00
OFDM	1	9.75	9.75

MCS0_7	1	9.75	9.75
VHT8_9SS1	1	9.75	9.75
DSSS_MULT11	2	-	-
OFDM_CDD1	2	8.25	8.25
MCS0_7_CDD1	2	8.25	8.25
VHT8_9SS1_CDD1	2	8.25	8.25
MCS0_7_STBC	2	8.25	8.25
VHT8_9SS1_STBC	2	8.25	8.25
MCS8_15	2	8.25	8.25
VHT8_9SS2	2	8.25	8.25
DSSS_MULT12	3	-	-
OFDM_CDD2	3	-	-
MCS0_7_CDD2	3	-	-
VHT8_9SS1_CDD2	3	-	-
MCS0_7_STBC_SPEXP1	3	-	-
VHT8_9SS1_STBC_SPEXP1	3	-	-
MCS8_15_SPEXP1	3	-	-
VHT8_9SS2_SPEXP1	3	-	-
MCS16_23	3	-	-
VHT8_9SS3	3	-	-
OFDM_TXBF1	2	-	-
MCS0_7_TXBF1	2	-	-
VHT8_9SS1_TXBF1	2	-	-
MCS8_15_TXBF0	2	-	-
OFDM_TXBF2	3	-	-
MCS0_7_TXBF2	3	-	-
VHT8_9SS1_TXBF2	3	-	-
MCS8_15_TXBF1	3	-	-

VHT8_9SS2_TXBF1	3	-	-
MCS16_23_TXBF0	3	-	-
Core Index:	0		
Board Limits:			
Rate	Chains 20in40 40MHz		
DSSS	1	20.25	20.25
OFDM6	1	17.75	17.75
OFDM9	1	17.75	17.75
OFDM12	1	17.75	17.75
OFDM18	1	17.75	17.75
OFDM24	1	17.75	17.75
OFDM36	1	17.75	17.75
OFDM48	1	17.25	17.25
OFDM54	1	17.25	17.25
MCS0	1	17.75	17.75
MCS1	1	17.75	17.75
MCS2	1	17.75	17.75
MCS3	1	17.75	17.75
MCS4	1	17.75	17.75
MCS5	1	17.25	17.25
MCS6	1	17.25	17.25
MCS7	1	16.75	16.75
VHT8_9SS1	1	-	-
DSSS_MULT11	2	20.25	20.25
OFDM6_CDD1	2	17.75	17.75
OFDM9_CDD1	2	17.75	17.75
OFDM12_CDD1	2	17.75	17.75

OFDM18_CDD1	2	17.75	17.75
OFDM24_CDD1	2	17.75	17.75
OFDM36_CDD1	2	17.75	17.75
OFDM48_CDD1	2	17.25	17.25
OFDM54_CDD1	2	17.25	17.25
MCS0_CDD1	2	17.75	17.75
MCS1_CDD1	2	17.75	17.75
MCS2_CDD1	2	17.75	17.75
MCS3_CDD1	2	17.75	17.75
MCS4_CDD1	2	17.75	17.75
MCS5_CDD1	2	17.25	17.25
MCS6_CDD1	2	17.25	17.25
MCS7_CDD1	2	16.75	16.75
VHT8_9SS1_CDD1	2	-	-
MCS0_STBC	2	17.75	17.75
MCS1_STBC	2	17.75	17.75
MCS2_STBC	2	17.75	17.75
MCS3_STBC	2	17.75	17.75
MCS4_STBC	2	17.75	17.75
MCS5_STBC	2	17.25	17.25
MCS6_STBC	2	17.25	17.25
MCS7_STBC	2	16.75	16.75
VHT8_9SS1_STBC	2	-	-
MCS8	2	17.75	17.75
MCS9	2	17.75	17.75
MCS10	2	17.75	17.75
MCS11	2	17.75	17.75
MCS12	2	17.75	17.75

MCS13	2	17.25	17.25
MCS14	2	17.25	17.25
MCS15	2	16.75	16.75
VHT8_9SS2	2	-	-
DSSS_MULT12	3	-	-
OFDM_CDD2	3	-	-
MCS0_7_CDD2	3	-	-
VHT8_9SS1_CDD2	3	-	-
MCS0_7_STBC_SPEXP1	3	-	-
VHT8_9SS1_STBC_SPEXP1	3	-	-
MCS8_15_SPEXP1	3	-	-
VHT8_9SS2_SPEXP1	3	-	-
MCS16_23	3	-	-
VHT8_9SS3	3	-	-
OFDM_TXBF1	2	-	-
MCS0_7_TXBF1	2	-	-
VHT8_9SS1_TXBF1	2	-	-
MCS8_15_TXBF0	2	-	-
OFDM_TXBF2	3	-	-
MCS0_7_TXBF2	3	-	-
VHT8_9SS1_TXBF2	3	-	-
MCS8_15_TXBF1	3	-	-
VHT8_9SS2_TXBF1	3	-	-
MCS16_23_TXBF0	3	-	-

Power Targets:

Rate	Chains 20in40 40MHz		
DSSS	1	16.25	8.00

OFDM	1	9.00	9.00
MCS0_7	1	9.00	9.00
VHT8_9SS1	1	8.00	8.00
DSSS_MULT11	2	8.00	8.00
OFDM_CDD1	2	8.00	8.00
MCS0_7_CDD1	2	8.00	8.00
VHT8_9SS1_CDD1	2	8.00	8.00
MCS0_7_STBC	2	8.00	8.00
VHT8_9SS1_STBC	2	8.00	8.00
MCS8_15	2	8.00	8.00
VHT8_9SS2	2	8.00	8.00
DSSS_MULT12	3	8.00	8.00
OFDM_CDD2	3	8.00	8.00
MCS0_7_CDD2	3	8.00	8.00
VHT8_9SS1_CDD2	3	8.00	8.00
MCS0_7_STBC_SPEXP1	3	8.00	8.00
VHT8_9SS1_STBC_SPEXP1	3	8.00	8.00
MCS8_15_SPEXP1	3	8.00	8.00
VHT8_9SS2_SPEXP1	3	8.00	8.00
MCS16_23	3	8.00	8.00
VHT8_9SS3	3	8.00	8.00
OFDM_TXBF1	2	8.00	8.00
MCS0_7_TXBF1	2	8.00	8.00
VHT8_9SS1_TXBF1	2	8.00	8.00
MCS8_15_TXBF0	2	8.00	8.00
OFDM_TXBF2	3	8.00	8.00
MCS0_7_TXBF2	3	8.00	8.00
VHT8_9SS1_TXBF2	3	8.00	8.00

MCS8_15_TXBF1	3	8.00	8.00
VHT8_9SS2_TXBF1	3	8.00	8.00
MCS16_23_TXBF0	3	8.00	8.00

Maximum Power Target among all rates: 16.25 16.25

Last est. power : 0.00 17.50

Power Target for the current rate : 8.00 8.00

Last adjusted est. power : 0.00 17.50

wireless caldata

root@OpenWrt:~# wireless_caldata.sh -c dump

ERIP Data:

00->0F: BC0103FF 0402FFFF 00000100 00008100

10->1F: 00820081 81FFFFFF FFFFFFFF FFFFFFFF

20->2F: FFFFFFFF FFFFFFFF FFFFFFFF FFFFFFFF

30->3F: 01000000 00000000 00810101 00FFFFFF

40->4F: FFFFFFFF FFFFFFFF FFFFFFFF FFFFFFFF

50->5F: FFFFFFFF FFFFFFFF FFFFFFFF FFFFFFFF

60->6F: FFFFFFFF FFFFFFFF FFFFFFFF FFFFFFFF

70->7F: FFFFFFFF FFFFFFFF FFFFFFFF FFFFFFFF

80->8F: FFFFFFFF FFFFFFFF FFFFFFFF FFFFFFFF

90->9F: FFFFFFFF FFFFFFFF FFFFFFFF FFFFFFFF

A0->AF: FFFFFFFF FFFFFFFF FFFFFFFF FFFFFFFF

B0->BF: FFFFFFFF FFFFFFFF FFFFFFFF FFFFFFFF

C0->CF: FFFFFFFF FFFFFFFF FFFFFFFF FFFFFFFF

D0->DF: FFFFFFFF FFFFFFFF FFFFFFFF FFFFFFFF

E0->EF: FFFFFFFF FFFFFFFF FFFFFFFF FFFFFFFF

F0->FF: FFFFFFFF FFFFFFFF FFFFFFFF FFFFFFFF

Locked: no

SROM Table

root@OpenWrt:~# wl srdump

```
srom[000]: 0x2801 0x0000 0x05e9 0x14e4 0x0070 0xedbe 0x1c00 0x2bc4
srom[008]: 0x2a64 0x2964 0x2c64 0x3ce7 0x46ff 0x47ff 0x0c00 0x0820
srom[016]: 0x0030 0x1002 0x9f28 0x5d44 0x8080 0x1d8f 0x0032 0x0100
srom[024]: 0xdf00 0x71f5 0x8400 0x0083 0x8500 0x2010 0x0001 0x0000
srom[032]: 0x0000 0x0000 0x0000 0x0000 0x0000 0x0000 0x0000 0x0000
srom[040]: 0x0000 0x0000 0x1008 0x0305 0x0000 0x0000 0x0000 0x0000
srom[048]: 0x43a9 0x8000 0x0002 0x0000 0x1f30 0x1800 0x0000 0x0000
srom[056]: 0x0000 0x0000 0x0000 0x0000 0x0000 0x0000 0x0000 0x0000
srom[064]: 0x5372 0x1256 0x0200 0x0000 0x8800 0x0000 0x0090 0x4c0c
srom[072]: 0x0000 0x0000 0x0003 0xffff 0x83ff 0xffff 0x0003 0x4343
srom[080]: 0x8383 0x0033 0x0000 0x0000 0x0000 0x0000 0x0000 0x0415
srom[088]: 0x0000 0x7800 0x0000 0x0000 0x0000 0x0000 0x0000 0x0000
srom[096]: 0x2051 0xfe46 0x15d6 0xfa70 0x0000 0x0000 0x0000 0x0000
```

srom[104]: 0x0000 0x0000 0x0000 0x0000 0x0000 0x0000 0x0000 0x0000
srom[112]: 0x2050 0xfe66 0x1628 0xfa7d 0x0000 0x0000 0x0000 0x0000
srom[120]: 0x0000 0x0000 0x0000 0x0000 0x0000 0x0000 0x0000 0x0000
srom[128]: 0xffff 0xffff 0xffff 0xffff 0xffff 0xffff 0xffff 0xffff
srom[136]: 0xffff 0xffff 0xffff 0xffff 0xffff 0xffff 0xffff 0xffff
srom[144]: 0xffff 0xffff 0xffff 0xffff 0xffff 0xffff 0xffff 0xffff
srom[152]: 0xffff 0xffff 0xffff 0xffff 0xffff 0xffff 0xffff 0xffff
srom[160]: 0x0000 0x4444 0x5444 0x0000 0x0000 0x0000 0x0000 0x0000
srom[168]: 0x0000 0x4433 0x5444 0x4433 0x5444 0x5555 0x7665 0x5555
srom[176]: 0x7665 0x0000 0x0000 0x0000 0x0000 0x0000 0x0000 0x0000
srom[184]: 0x0000 0x0000 0x0000 0x0000 0x0000 0x0000 0x0000 0x0000
srom[192]: 0x0000 0x0000 0x0000 0x0000 0x0000 0x0000 0x0000 0x0000
srom[200]: 0x0000 0x0000 0x0000 0x0000 0x0000 0xffff 0xffff 0xffff
srom[208]: 0xffff 0xffff 0xffff 0xffff 0xffff 0xffff 0xffff 0xffff
srom[216]: 0xffff 0xffff 0xffff 0xb908

Appendix D. Information on the Testing Laboratories

We, Bureau Veritas Consumer Products Services (H.K.) Ltd., Taoyuan Branch, were founded in 1988 to provide our best service in EMC, Radio, Telecom and Safety consultation. Our laboratories are accredited and approved according to ISO/IEC 17025.

If you have any comments, please feel free to contact us at the following:

Linko EMC/RF Lab

Tel: 886-2-26052180

Fax: 886-2-26051924

Hsin Chu EMC/RF/Telecom Lab

Tel: 886-3-6668565

Fax: 886-3-6668323

Hwa Ya EMC/RF/Safety

Tel: 886-3-3183232

Fax: 886-3-3270892

Email: service.adt@tw.bureauveritas.com

Web Site: www.bureauveritas-adt.com

The address and road map of all our labs can be found in our web site also.

--- END ---