

# **RADIO TEST REPORT**

According to

47 CFR FCC Part 15 Subpart C § 15.247

**Equipment** : **Wireless Residential VoIP Gateway**  
**Model No.** : **TG784 DSLVBB845 GG**  
 : **TG782 DSLVBB843 EG**  
**Brand Name** : **THOMSON**  
**Filing Type** : **New Application**  
**Applicant** : **Thomson Telecom Belgium**  
 : Prins Boudewijnlaan 47 B-2650 Edegem Belgium  
**FCC ID** : **RSE-TG784**  
**Manufacturer** : **Thomson Telecom Belgium**  
 : Prins Boudewijnlaan 47 B-2650 Edegem Belgium  
**Received Date** : May 13, 2008  
**Final Test Date** : May 14, 2008

## Statement

**This report is only covering the 802.11b/g modes of operation of the product.**

The test result in this report refers exclusively to the presented test model / sample.

Without written approval of SPORTON International Inc., the test report shall not be reproduced except in full.

The measurements and test results shown in this test report were made in accordance with the procedures and found in compliance with the limit given in **ANSI C63.4-2003** and **47 CFR FCC Part 15 Subpart C**.

The test equipment used to perform the test is calibrated and traceable to NML/ROC.



***SPORTON International Inc.***

*6F, No. 106, Sec. 1, Hsin Tai Wu Rd., Hsi Chih, Taipei Hsien, Taiwan, R.O.C.*

## **Contents**

**1. SUMMARY OF THE TEST RESULTS..... 2**

**2. GENERAL INFORMATION..... 3**

2.1. Product Details ..... 3

2.2. Equipment Under Test ..... 3

2.3. Information of the Power Supply Units ..... 3

2.4. Information of the Antenna ..... 4

2.5. Carrier Frequencies..... 4

2.6. Test Modes..... 4

2.7. Testing Locations ..... 4

2.8. Supporting Units ..... 5

2.9. Test Software ..... 5

2.10. Test Configurations ..... 6

**3. TEST RESULTS..... 8**

3.1. AC Power Line Conducted Emissions Measurement..... 8

3.2. Maximum Peak Output Power Measurement..... 12

3.3. Power Spectral Density Measurement ..... 14

3.4. 6dB Spectrum Bandwidth Measurement..... 22

3.5. Radiated Emissions Measurement..... 31

3.6. Band Edge Emissions Measurement ..... 61

3.7. Antenna Requirements..... 70

**4. LIST OF MEASURING EQUIPMENTS..... 71**

**5. TEST LOCATIONS ..... 72**

**6. TAF CERTIFICATE OF ACCREDITATION..... 73**

**APPENDIX A. TEST PHOTOS ..... A1 ~ A6**

**APPENDIX B. PHOTOGRAPHS OF EUT ..... B1 ~ B10**

**APPENDIX C. MAXIMUM PERMISSIBLE EXPOSURE.....C1 ~ C3**

### History of This Test Report

| <b>Report No.</b> | <b>Issue Date</b> | <b>Description</b> |
|-------------------|-------------------|--------------------|
| FR850822AC        | May 28, 2008      | Original report    |
|                   |                   |                    |
|                   |                   |                    |
|                   |                   |                    |
|                   |                   |                    |
|                   |                   |                    |
|                   |                   |                    |
|                   |                   |                    |
|                   |                   |                    |
|                   |                   |                    |
|                   |                   |                    |
|                   |                   |                    |
|                   |                   |                    |
|                   |                   |                    |
|                   |                   |                    |
|                   |                   |                    |
|                   |                   |                    |
|                   |                   |                    |
|                   |                   |                    |
|                   |                   |                    |
|                   |                   |                    |

# CERTIFICATE OF COMPLIANCE

According to

47 CFR FCC Part 15 Subpart C § 15.247

**Equipment** : **Wireless Residential VoIP Gateway**  
**Model No.** : **TG784 DSLVBB845 GG**  
                   : **TG782 DSLVBB843 EG**  
**Brand Name** : **THOMSON**  
**Filing Type** : **New Application**  
**Applicant** : **Thomson Telecom Belgium**  
                   : Prins Boudewijnlaan 47 B-2650 Edegem Belgium  
**FCC ID** : **RSE-TG784**  
**Manufacturer** : **Thomson Telecom Belgium**  
                   : Prins Boudewijnlaan 47 B-2650 Edegem Belgium  
**Received Date** : May 13, 2008  
**Final Test Date** : May 14, 2008

Sporton International as requested by the applicant to evaluate the EMC performance of the product sample received on May 13, 2008 would like to declare that the tested sample has been evaluated and found to be in compliance with the tested rule parts. The data recorded as well as the test configuration specified is true and accurate for showing the sample's EMC nature.



Wayne Hsu

**SPORTON International Inc.**

6F, No.106, Sec. 1, Hsin Tai Wu Rd., Hsi Chih, Taipei Hsien, Taiwan, R.O.C.

**1. SUMMARY OF THE TEST RESULTS**

| <b>Applied Standard: 47 CFR FCC Part 15 Subpart C</b> |                     |                                     |               |                    |
|-------------------------------------------------------|---------------------|-------------------------------------|---------------|--------------------|
| <b>Part</b>                                           | <b>Rule Section</b> | <b>Description of Test</b>          | <b>Result</b> | <b>Under Limit</b> |
| 3.1                                                   | 15.207              | AC Power Line Conducted Emissions   | Complies      | 10.80 dB           |
| 3.2                                                   | 15.247(b)(3)        | Maximum Peak Conducted Output Power | Complies      | 9.00 dB            |
| 3.3                                                   | 15.247(e)           | Power Spectral Density              | Complies      | 18.33 dB           |
| 3.4                                                   | 15.247(a)(2)        | 6dB Spectrum Bandwidth              | Complies      | -                  |
| 3.5                                                   | 15.247(d)           | Radiated Emissions                  | Complies      | 1.07 dB            |
| 3.6                                                   | 15.247(d)           | Band Edge Emissions                 | Complies      | 3.68 dB            |
| 3.7                                                   | 15.203              | Antenna Requirements                | Complies      | -                  |

| <b>Test Items</b>                           | <b>Uncertainty</b>    | <b>Remark</b>            |
|---------------------------------------------|-----------------------|--------------------------|
| AC Power Line Conducted Emissions           | ±2.3dB                | Confidence levels of 95% |
| Maximum Peak Conducted Output Power         | ±0.8dB                | Confidence levels of 95% |
| Power Spectral Density                      | ±0.5dB                | Confidence levels of 95% |
| 6dB Spectrum Bandwidth                      | ±8.5×10 <sup>-8</sup> | Confidence levels of 95% |
| Radiated Emissions (9kHz~30MHz)             | ±0.8dB                | Confidence levels of 95% |
| Radiated Emissions (30MHz~1000MHz)          | ±1.9dB                | Confidence levels of 95% |
| Radiated / Band Edge Emissions (1GHz~18GHz) | ±1.9dB                | Confidence levels of 95% |
| Radiated Emissions (18GHz~40GHz)            | ±1.9dB                | Confidence levels of 95% |
| Temperature                                 | ±0.7                  | Confidence levels of 95% |
| Humidity                                    | ±3.2%                 | Confidence levels of 95% |
| DC / AC Power Source                        | ±1.4%                 | Confidence levels of 95% |

**2. GENERAL INFORMATION**

**2.1. Product Details**

The EUT is a Wireless Residential VoIP Gateway with IEEE 802.11b/g radio functions. Only the radio details of IEEE 802.11b/g are shown in the table below. For more detailed features description, please refer to the manufacturer’s specifications or user’s manual.

| Items                    | Description                                                   |
|--------------------------|---------------------------------------------------------------|
| Power Type               | 22VDC from adapter                                            |
| Modulation               | DSSS for IEEE 802.11b ; OFDM for IEEE 802.11g                 |
| Data Modulation          | DSSS (BPSK / QPSK / CCK) ; OFDM (BPSK / QPSK / 16QAM / 64QAM) |
| Data Rate (Mbps)         | DSSS (1/ 2/ 5.5/11) ; OFDM (6/9/12/18/24/36/48/54)            |
| Frequency Range          | 2400 ~ 2483.5MHz                                              |
| Number of Channels       | 11                                                            |
| Channel Band Width (99%) | 11b: 12.56 MHz ; 11g: 16.40 MHz (according to section 3.4.7)  |
| Conducted Output Power   | 11b: 20.77 dBm ; 11g: 21.00 dBm (according to section 3.2.7)  |

**2.2. Equipment Under Test**

Trade Name : THOMSON

Hardware Version : PEM1

The table below shows the interface ports that are equipped on the models:

| Equipment | Product code | PWR                                 | DSL                                 | FXO                                 | FXS                                              | Ethernet                                         | WAN                                 | WLAN<br>(IEEE 802.11b/g)            | USB 2.0<br>(host)                   |
|-----------|--------------|-------------------------------------|-------------------------------------|-------------------------------------|--------------------------------------------------|--------------------------------------------------|-------------------------------------|-------------------------------------|-------------------------------------|
| TG782     | DSLVB843 EG  | <input checked="" type="checkbox"/> | <input checked="" type="checkbox"/> | <input checked="" type="checkbox"/> | <input checked="" type="checkbox"/><br>(2-ports) | <input checked="" type="checkbox"/><br>(4-ports) | <input type="checkbox"/>            | <input checked="" type="checkbox"/> | <input checked="" type="checkbox"/> |
| TG784     | DSLVB845 GG  | <input checked="" type="checkbox"/> | <input checked="" type="checkbox"/> | <input checked="" type="checkbox"/> | <input checked="" type="checkbox"/><br>(2-ports) | <input checked="" type="checkbox"/><br>(4-ports) | <input checked="" type="checkbox"/> | <input checked="" type="checkbox"/> | <input checked="" type="checkbox"/> |

: Equipped  
: Not equipped

The EUT is the combination of the modem TG784 DSLVB845 GG and the power supply unit.

**2.3. Information of the Power Supply Unit**

| Trade Name | Product Name     | Input Rating            | Output Rating       | Type                     | Company Info                                                                                                  |
|------------|------------------|-------------------------|---------------------|--------------------------|---------------------------------------------------------------------------------------------------------------|
| OEM        | ADS18B-W B220082 | 100 Vac<br>~<br>240 Vac | 22 Vdc /<br>0.818 A | Switched /<br>Wall mount | Outstanding Electronic<br>Manufacturer Co., Ltd. 3F,<br>No.541 Chung-Cheng Road,<br>Hsin-Tien, Taipei Taiwan. |

**2.4. Information of the Antenna**

| Scenarios | Brand Name | Model Name                | Antenna Type   | Connector | Gain (dBi) |
|-----------|------------|---------------------------|----------------|-----------|------------|
| A         | M-gear     | C407-510497-A (SSR-81173) | Dipole Antenna | NA        | 2.00       |
| B         | -          | -                         | PIFA Antenna   | On board  | 2.557      |

Note: EUT has two identical antennas (Ant. 1 and Ant. 2) and can transmit through both of them.

**2.5. Carrier Frequencies**

| Frequency Band | Channel No. | Frequency | Channel No. | Frequency |
|----------------|-------------|-----------|-------------|-----------|
| 2400~2483.5MHz | 1           | 2412 MHz  | 7           | 2442 MHz  |
|                | 2           | 2417 MHz  | 8           | 2447 MHz  |
|                | 3           | 2422 MHz  | 9           | 2452 MHz  |
|                | 4           | 2427 MHz  | 10          | 2457 MHz  |
|                | 5           | 2432 MHz  | 11          | 2462 MHz  |
|                | 6           | 2437 MHz  |             |           |

**2.6. Test Modes**

Preliminary tests were performed in different data rate to find the worst radiated emission. The data rate shown in the table below is the worst-case data rate with respect to the specific test item. Investigation has been done on all the possible configurations for searching the worst cases. The following table is a list of the test modes shown in this test report.

| Test Items                                                                              | Mode        | Data Rate | Channel | Antenna |
|-----------------------------------------------------------------------------------------|-------------|-----------|---------|---------|
| AC Power Line Conducted Emissions                                                       | Normal Link | -         | -       | -       |
| Maximum Peak Conducted Output Power<br>Power Spectral Density<br>6dB Spectrum Bandwidth | 11b/CCK     | 11 Mbps   | 1/6/11  | 1/2     |
|                                                                                         | 11g/BPSK    | 6 Mbps    | 1/6/11  | 1/2     |
| Radiated Emissions 9kHz~1GHz                                                            | 11g/BPSK    | 6 Mbps    | 6       | 1/2     |
| Radiated Emissions 1GHz~10 <sup>th</sup> Harmonic                                       | 11b/CCK     | 11 Mbps   | 1/6/11  | 1/2     |
|                                                                                         | 11g/BPSK    | 6 Mbps    | 1/6/11  | 1/2     |
| Band Edge Emissions                                                                     | 11b/CCK     | 11 Mbps   | 1/6/11  | 1/2     |
|                                                                                         | 11g/BPSK    | 6 Mbps    | 1/6/11  | 1/2     |

**2.7. Testing Locations**

| Test Site No. | Site Category | Location | FCC Reg. No. | IC File No. | VCCI Reg. No |
|---------------|---------------|----------|--------------|-------------|--------------|
| 03CH02-HY     | SAC           | Hwa Ya   | 101377       | IC 4086B-1  | -            |
| CO04-HY       | Conduction    | Hwa Ya   | 101377       | IC 4086B-1  | -            |
| TH01-HY       | OVEN Room     | Hwa Ya   | -            | -           | -            |

Open Area Test Site (OATS); Semi Anechoic Chamber (SAC); Fully Anechoic Chamber (FAC).

**2.8. Supporting Units**

| <b>Support Unit</b>                 | <b>Brand</b>                | <b>Model</b> | <b>FCC ID</b> |
|-------------------------------------|-----------------------------|--------------|---------------|
| PC                                  | HP                          | DC579AV      | DoC           |
| TELEPHONE x3                        | HTT                         | HTT-806      | DoC           |
| Central Office                      | Easy Switch                 | SMS-4 PLUS   | DoC           |
| Loop Simulator                      | -                           | 458-LM-HD    | DoC           |
| USB Flash                           | A-DATA                      | 4G           | DoC           |
| CO.                                 | Provide by the manufacturer |              |               |
| Notebook x2<br>(Remote Workstation) | DELL                        | D400         | DoC           |

**2.9. Test Software**

During testing, Channel & Power Controlling Software provided by the manufacturer was used to control the operating channel as well as the output power level. The RF output power selection is for the setting of RF output power expected by the manufacturer and is going to be fixed on the firmware of the final end product.

**Power Parameters of IEEE 802.11b/g**

| <b>Test Software Version</b> | <b>TTERMPRO</b> |          |          |
|------------------------------|-----------------|----------|----------|
| Frequency                    | 2412 MHz        | 2437 MHz | 2462 MHz |
| IEEE 802.11b                 | DEFAULT         | DEFAULT  | DEFAULT  |
| IEEE 802.11g                 | DEFAULT         | DEFAULT  | DEFAULT  |



## 2.10. Test Configurations

### 2.10.1. Radiation Emissions Test Configuration

<For radiated emissions 9KHz ~ 1GHz test>

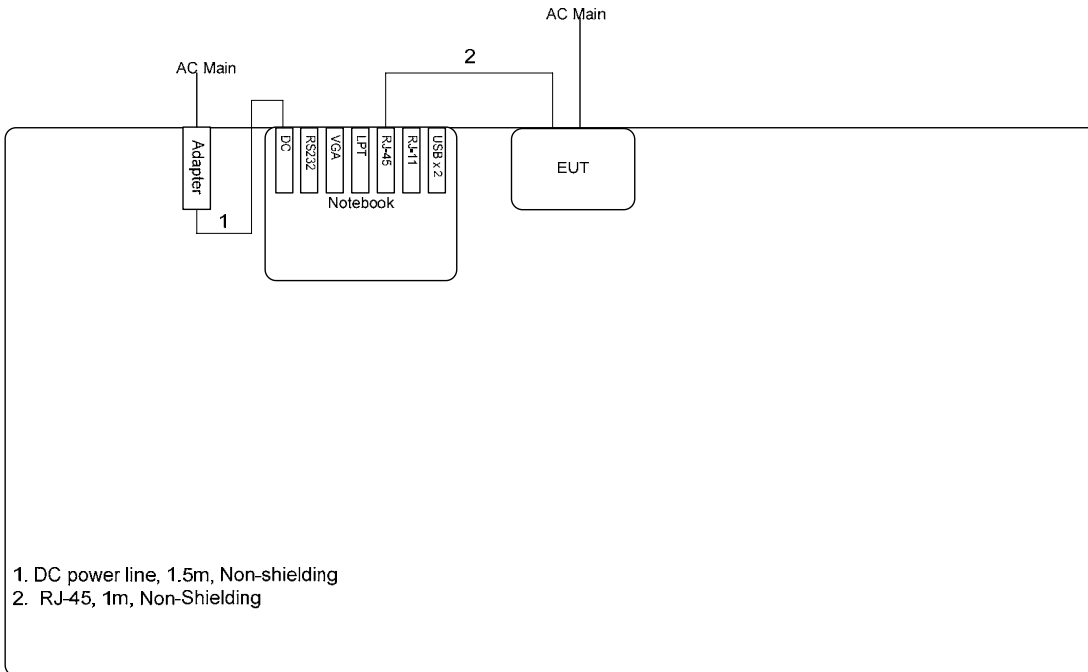

<For radiated emissions above 1GHz test>

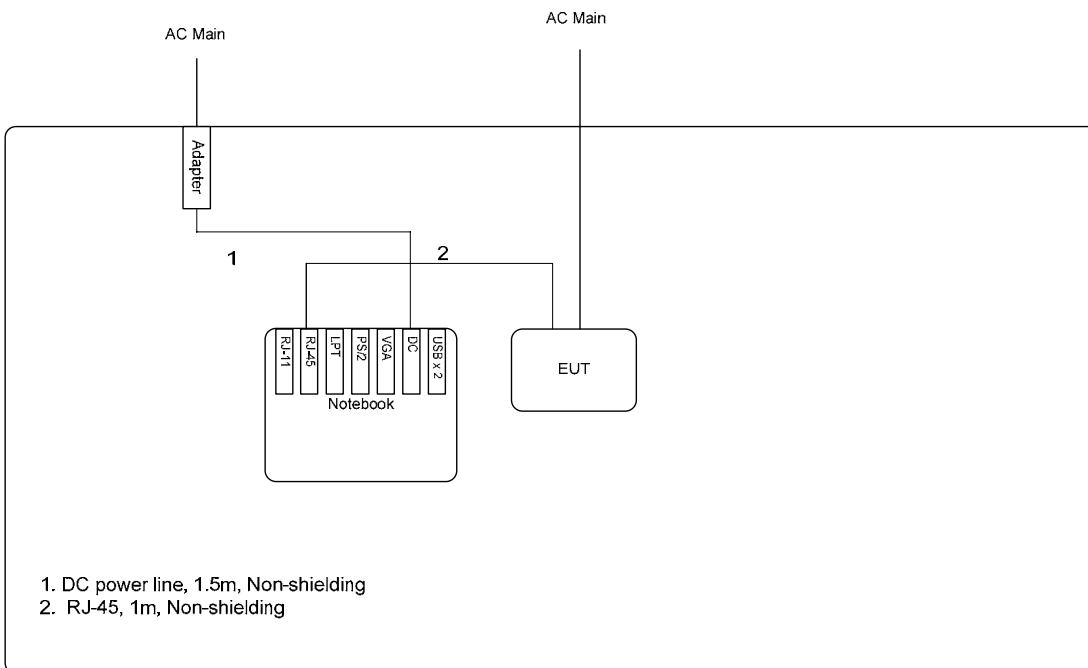

**2.10.2. Conducted Emissions Test Configuration**

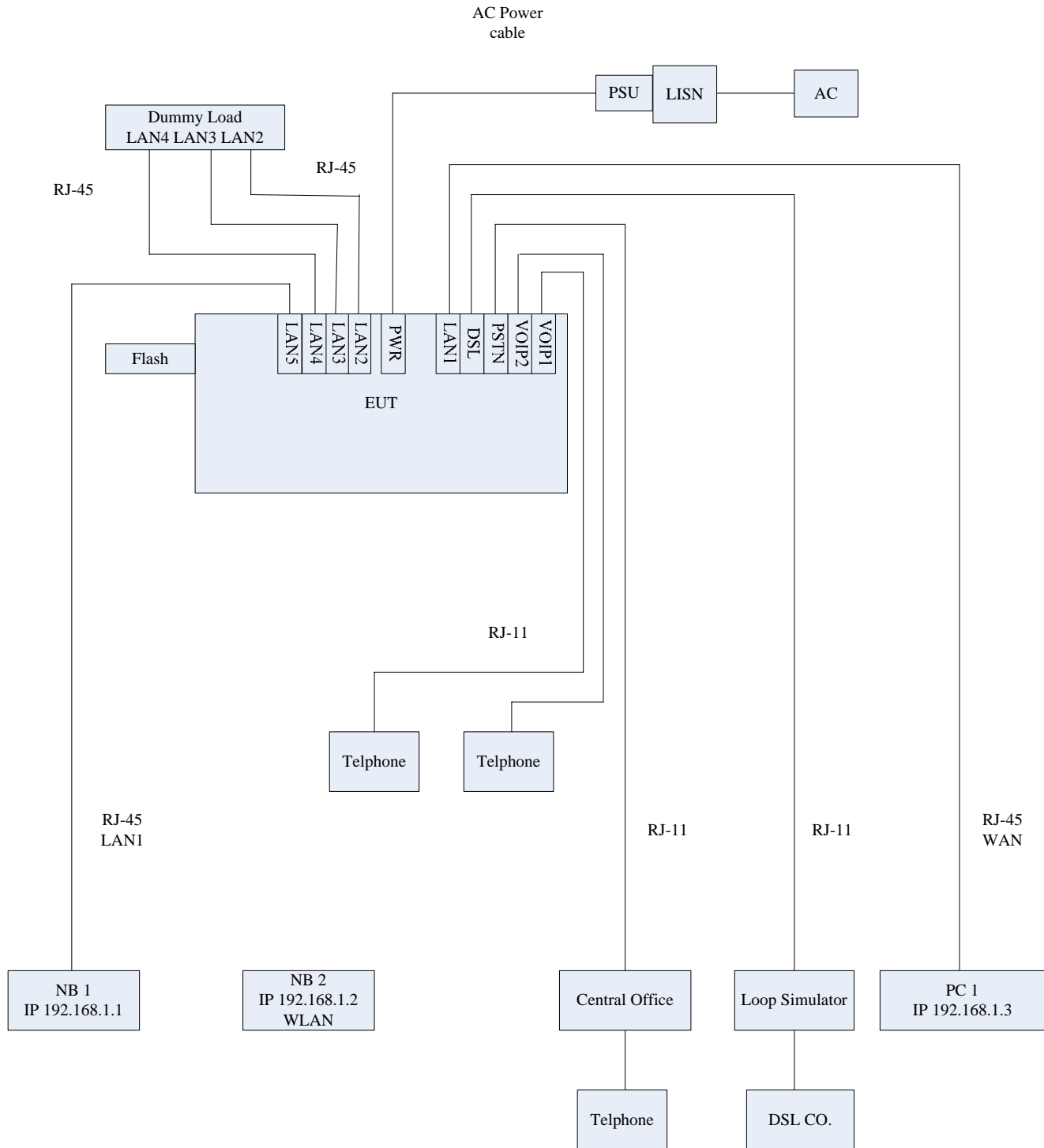

**3. TEST RESULTS**

**3.1. AC Power Line Conducted Emissions Measurement**

**3.1.1. Limit**

For this product which is designed to be connected to the AC power line, the radio frequency voltage that is conducted back onto the AC power line on any frequency or frequencies within the band 150 kHz to 30 MHz shall not exceed below limits table.

| Frequency (MHz) | QP Limit (dBuV) | AV Limit (dBuV) |
|-----------------|-----------------|-----------------|
| 0.15~0.5        | 66~56           | 56~46           |
| 0.5~5           | 56              | 46              |
| 5~30            | 60              | 50              |

**3.1.2. Measuring Instruments and Setting**

Please refer to section 4 of equipments list in this report. The following table is the setting of the receiver.

| Receiver Parameters | Setting  |
|---------------------|----------|
| Attenuation         | 10 dB    |
| Start Frequency     | 0.15 MHz |
| Stop Frequency      | 30 MHz   |
| IF Bandwidth        | 9 KHz    |

**3.1.3. Test Procedures**

1. Configure the EUT according to ANSI C63.4. The EUT or host of EUT has to be placed 0.4 meter far from the conducting wall of the shielding room and at least 80 centimeters from any other grounded conducting surface.
2. Connect EUT or host of EUT to the power mains through a line impedance stabilization network (LISN).
3. All the support units are connected to the other LISNs. The LISN should provide 50uH/50ohms coupling impedance.
4. The frequency range from 150 KHz to 30 MHz was searched.
5. Set the test-receiver system to Peak Detect Function and Specified Bandwidth with Maximum Hold Mode.
6. The measurement has to be done between each power line and ground at the power terminal.

3.1.4. Test Setup Layout

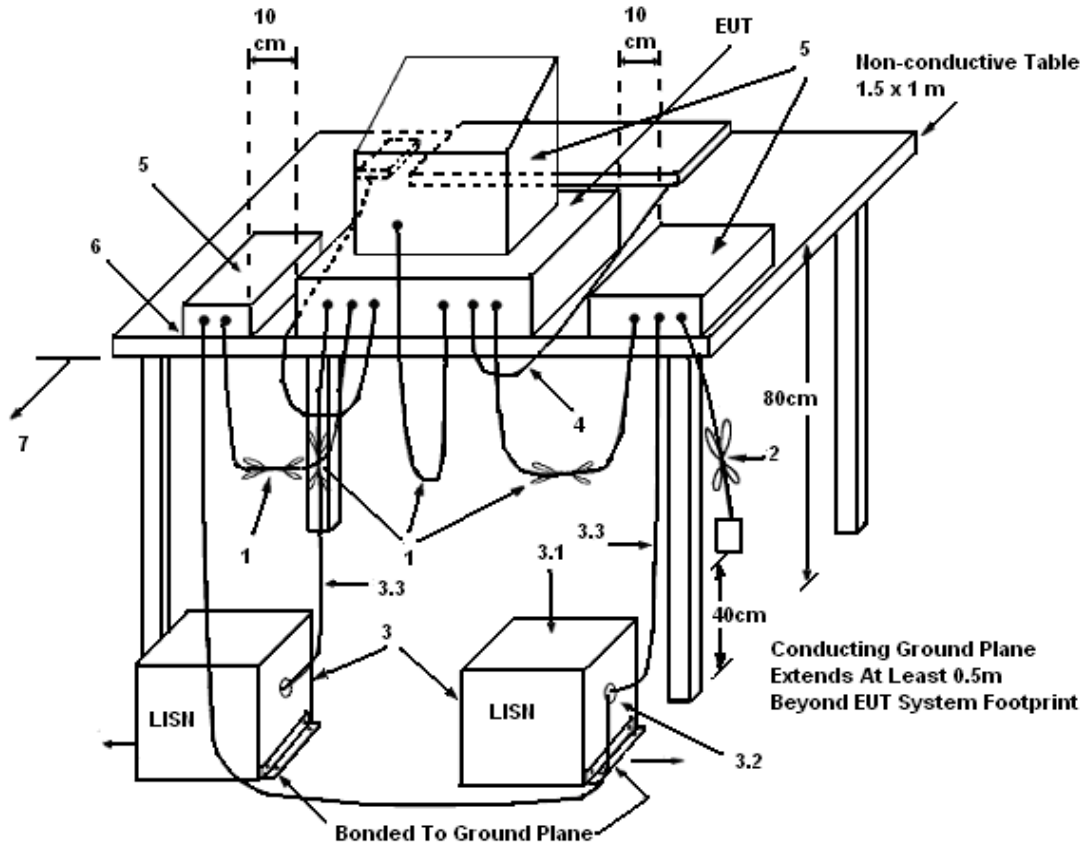

LEGEND:

- (1) Interconnecting cables that hang closer than 40 cm to the ground plane shall be folded back and forth in the center forming a bundle 30 to 40 cm long.
- (2) I/O cables that are not connected to a peripheral shall be bundled in the center. The end of the cable may be terminated, if required, using the correct terminating impedance. The overall length shall not exceed 1 m.
- (3) EUT connected to one LISN. Unused LISN measuring port connectors shall be terminated in 50 Ω. LISN can be placed on top of, or immediately beneath, reference ground plane.
- (3.1) All other equipment powered from additional LISN(s).
- (3.2) Multiple outlet strip can be used for multiple power cords of non-EUT equipment.
- (3.3) LISN at least 80 cm from nearest part of EUT chassis.
- (4) Cables of hand-operated devices, such as keyboards, mice, etc., shall be placed as for normal use.
- (5) Non-EUT components of EUT system being tested.
- (6) Rear of EUT, including peripherals, shall all be aligned and flush with rear of tabletop.
- (7) Rear of tabletop shall be 40 cm removed from a vertical conducting plane that is bonded to the ground plane.

3.1.5. Test Deviation

There is no deviation with the original standard.

3.1.6. EUT Operation during Test

The EUT was placed on the test table and programmed in normal function.

3.1.7. Results of AC Power Line Conducted Emissions Measurement

|               |              |               |         |
|---------------|--------------|---------------|---------|
| Test Date     | May 13, 2008 | Test Site No. | CO04-HY |
| Temperature   | 25           | Humidity      | 55%     |
| Test Engineer | Chris Lin    | Phase         | Line    |
| Configuration | Normal Link  |               |         |

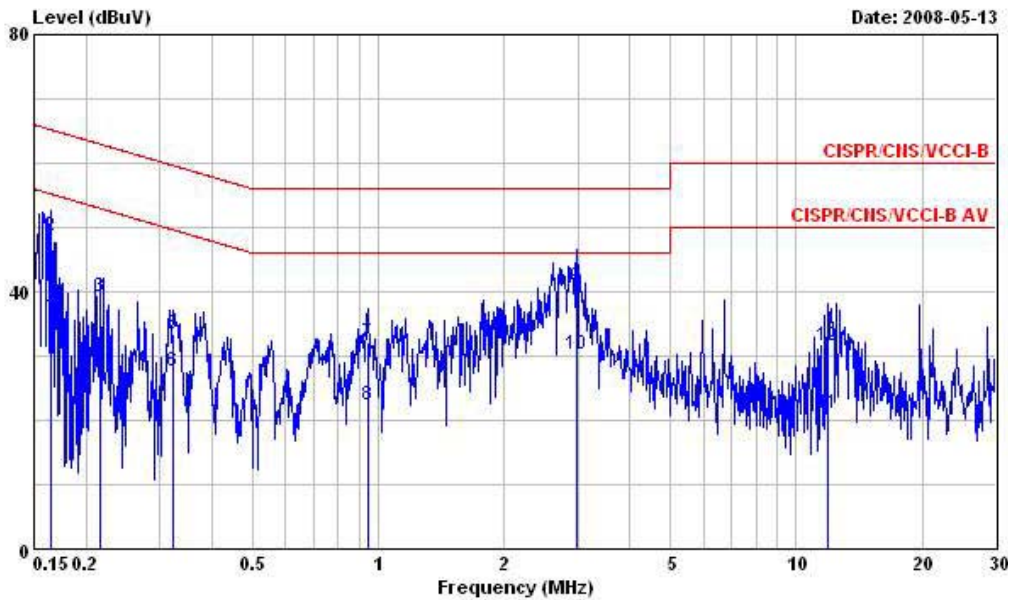

|    | Freq      | Level | Over Limit | Limit Line | Read Level | LISN Factor | Cable Loss | Remark  |
|----|-----------|-------|------------|------------|------------|-------------|------------|---------|
|    | MHz       | dBuV  | dB         | dBuV       | dBuV       | dB          | dB         |         |
| 1  | 0.1641380 | 35.94 | -19.31     | 55.25      | 35.82      | 0.09        | 0.03       | Average |
| 2  | 0.1641380 | 48.60 | -16.65     | 65.25      | 48.48      | 0.09        | 0.03       | QP      |
| 3  | 0.2158470 | 39.23 | -23.75     | 62.98      | 39.12      | 0.09        | 0.02       | QP      |
| 4  | 0.2158470 | 28.40 | -24.58     | 52.98      | 28.29      | 0.09        | 0.02       | Average |
| 5  | 0.3216920 | 33.31 | -26.35     | 59.66      | 33.16      | 0.10        | 0.05       | QP      |
| 6  | 0.3216920 | 27.60 | -22.06     | 49.66      | 27.45      | 0.10        | 0.05       | Average |
| 7  | 0.9480900 | 32.21 | -23.79     | 56.00      | 32.08      | 0.11        | 0.02       | QP      |
| 8  | 0.9480900 | 22.38 | -23.62     | 46.00      | 22.25      | 0.11        | 0.02       | Average |
| 9  | 2.990     | 40.83 | -15.17     | 56.00      | 40.62      | 0.15        | 0.06       | QP      |
| 10 | 2.990     | 30.14 | -15.86     | 46.00      | 29.93      | 0.15        | 0.06       | Average |
| 11 | 11.930    | 21.00 | -29.00     | 50.00      | 20.62      | 0.31        | 0.07       | Average |
| 12 | 11.930    | 31.59 | -28.41     | 60.00      | 31.21      | 0.31        | 0.07       | QP      |

|               |              |               |         |
|---------------|--------------|---------------|---------|
| Test Date     | May 13, 2008 | Test Site No. | CO04-HY |
| Temperature   | 25           | Humidity      | 55%     |
| Test Engineer | Chris Lin    | Phase         | Neutral |
| Configuration | Normal Link  |               |         |

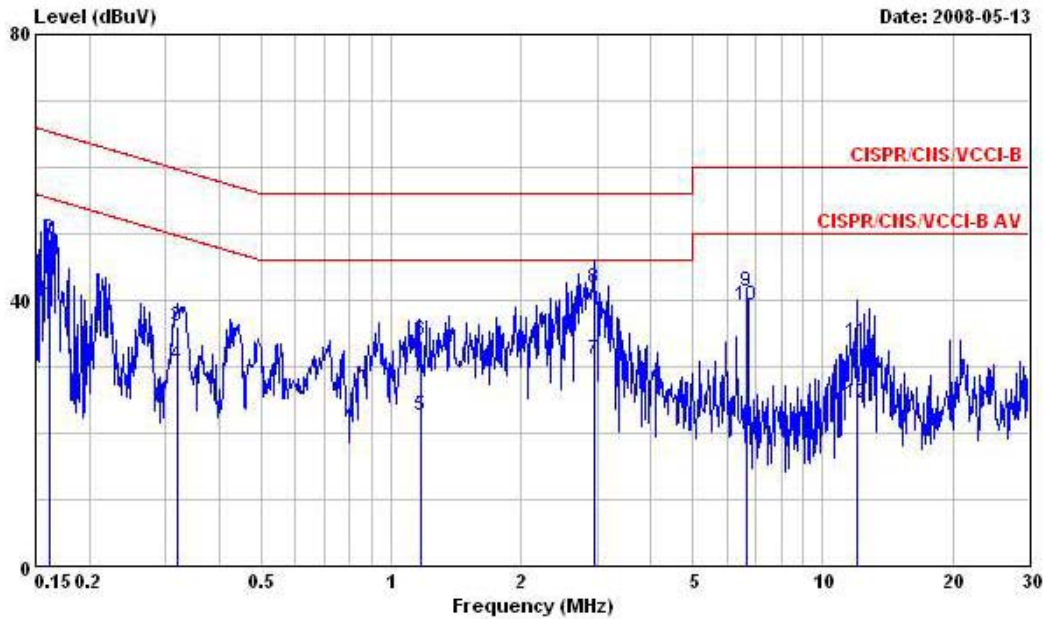

|    | Freq      | Level | Over Limit | Limit Line | Read Level | LISN Factor | Cable Loss | Remark  |
|----|-----------|-------|------------|------------|------------|-------------|------------|---------|
|    | MHz       | dBuV  | dB         | dBuV       | dBuV       | dB          | dB         |         |
| 1  | 0.1615850 | 39.18 | -16.20     | 55.38      | 39.06      | 0.09        | 0.03       | Average |
| 2  | 0.1615850 | 49.17 | -16.21     | 65.38      | 49.05      | 0.09        | 0.03       | QP      |
| 3  | 0.3199920 | 36.04 | -23.67     | 59.71      | 35.90      | 0.09        | 0.05       | QP      |
| 4  | 0.3199920 | 30.28 | -19.43     | 49.71      | 30.14      | 0.09        | 0.05       | Average |
| 5  | 1.170     | 22.66 | -23.34     | 46.00      | 22.53      | 0.11        | 0.02       | Average |
| 6  | 1.170     | 34.05 | -21.95     | 56.00      | 33.92      | 0.11        | 0.02       | QP      |
| 7  | 2.950     | 31.12 | -14.88     | 46.00      | 30.92      | 0.14        | 0.06       | Average |
| 8  | 2.950     | 41.83 | -14.17     | 56.00      | 41.63      | 0.14        | 0.06       | QP      |
| 9  | 6.684     | 41.24 | -18.76     | 60.00      | 40.98      | 0.22        | 0.04       | QP      |
| 10 | 6.684     | 39.20 | -10.80     | 50.00      | 38.94      | 0.22        | 0.04       | Average |
| 11 | 12.000    | 33.68 | -26.32     | 60.00      | 33.30      | 0.30        | 0.08       | QP      |
| 12 | 12.000    | 24.38 | -25.62     | 50.00      | 24.00      | 0.30        | 0.08       | Average |

Note:

Level = Read Level + LISN Factor + Cable Loss.

**3.2. Maximum Peak Output Power Measurement**

**3.2.1. Limit**

For systems using digital modulation in the 2400-2483.5MHz, the limit for peak output power is 30dBm. The limit has to be reduced by the amount in dB that the gain of the antenna exceed 6dBi. In case of point-to-point operation, the limit has to be reduced by 1dB for every 3dB that the directional gain of the antenna exceeds 6dBi.

**3.2.2. Measuring Instruments and Setting**

Please refer to section 4 of equipments list in this report. The following table is the setting of the power meter.

| <b>Power Meter Parameter</b> | <b>Setting</b>     |
|------------------------------|--------------------|
| Filter No.                   | Auto               |
| Measurement time             | 0.135 s ~ 26 s     |
| Used Peak Sensor             | NRV-Z32 (model 04) |

**3.2.3. Test Procedures**

1. The transmitter output (antenna port) was connected to the power meter.
2. Turn on the EUT and power meter and then record the peak power value.
3. Repeat above procedures on all channels needed to be tested.
4. As two antenna that we use in the test, we measured the individual antenna data and plus two data together.

**3.2.4. Test Setup Layout**

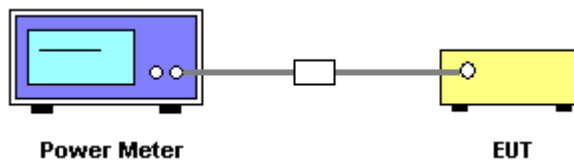

**3.2.5. Test Deviation**

There is no deviation with the original standard.

**3.2.6. EUT Operation during Test**

The EUT was programmed to be in continuously transmitting mode.

**3.2.7. Test Result of Maximum Peak Output Power**

|                      |              |                       |                          |
|----------------------|--------------|-----------------------|--------------------------|
| <b>Test Date</b>     | May 14, 2008 | <b>Test Site No.</b>  | TH01-HY                  |
| <b>Temperature</b>   | 28           | <b>Humidity</b>       | 58%                      |
| <b>Test Engineer</b> | Nan          | <b>Configurations</b> | 802.11b/g (Scenarios. A) |

**Configuration IEEE 802.11b**

| Channel | Frequency | Conducted Power (dBm) | Max. Limit (dBm) | Result          |
|---------|-----------|-----------------------|------------------|-----------------|
| 1       | 2412 MHz  | 20.09                 | 30.00            | <b>Complies</b> |
| 6       | 2437 MHz  | 19.90                 | 30.00            | <b>Complies</b> |
| 11      | 2462 MHz  | 19.64                 | 30.00            | <b>Complies</b> |

**Configuration IEEE 802.11g**

| Channel | Frequency | Conducted Power (dBm) | Max. Limit (dBm) | Result          |
|---------|-----------|-----------------------|------------------|-----------------|
| 1       | 2412 MHz  | 20.17                 | 30.00            | <b>Complies</b> |
| 6       | 2437 MHz  | 20.12                 | 30.00            | <b>Complies</b> |
| 11      | 2462 MHz  | 19.92                 | 30.00            | <b>Complies</b> |

|                      |              |                       |                          |
|----------------------|--------------|-----------------------|--------------------------|
| <b>Test Date</b>     | May 14, 2008 | <b>Test Site No.</b>  | TH01-HY                  |
| <b>Temperature</b>   | 28           | <b>Humidity</b>       | 58%                      |
| <b>Test Engineer</b> | Nan          | <b>Configurations</b> | 802.11b/g (Scenarios. B) |

**Configuration IEEE 802.11b**

| Channel | Frequency | Conducted Power (dBm) | Max. Limit (dBm) | Result          |
|---------|-----------|-----------------------|------------------|-----------------|
| 1       | 2412 MHz  | 20.77                 | 30.00            | <b>Complies</b> |
| 6       | 2437 MHz  | 20.57                 | 30.00            | <b>Complies</b> |
| 11      | 2462 MHz  | 20.52                 | 30.00            | <b>Complies</b> |

**Configuration IEEE 802.11g**

| Channel | Frequency | Conducted Power (dBm) | Max. Limit (dBm) | Result          |
|---------|-----------|-----------------------|------------------|-----------------|
| 1       | 2412 MHz  | 21.00                 | 30.00            | <b>Complies</b> |
| 6       | 2437 MHz  | 20.81                 | 30.00            | <b>Complies</b> |
| 11      | 2462 MHz  | 20.84                 | 30.00            | <b>Complies</b> |



**3.3. Power Spectral Density Measurement**

**3.3.1. Limit**

For digitally modulated systems, the power spectral density conducted from the intentional radiator to the antenna shall not be greater than 8 dBm in any 3 kHz band during any time interval of continuous transmission.

**3.3.2. Measuring Instruments and Setting**

Please refer to section 4 of equipments list in this report. The following table is the setting of the spectrum analyzer.

| Spectrum Parameter | Setting  |
|--------------------|----------|
| Attenuation        | Auto     |
| Span Frequency     | 1.5MHz   |
| RB                 | 3 kHz    |
| VB                 | 30 kHz   |
| Detector           | Peak     |
| Trace              | Max Hold |
| Sweep Time         | 500s     |

**3.3.3. Test Procedures**

1. The transmitter output (antenna port) was connected to the spectrum analyser.
2. Set RBW of spectrum analyzer to 3kHz and VBW to 30kHz. Set Detector to Peak, Trace to Max Hold.
3. Mark the frequency with maximum peak power as the center of the display of the spectrum.
4. Set the span to 1.5MHz and the sweep time to 500s and record the maximum peak value.
5. As two antenna that we use in the test, we measured the individual antenna data and plus two data together.

**3.3.4. Test Setup Layout**

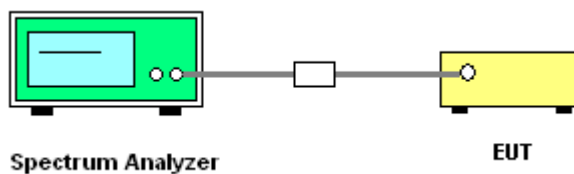

**3.3.5. Test Deviation**

There is no deviation with the original standard.

**3.3.6. EUT Operation during Test**

The EUT was programmed to be in continuously transmitting mode.

**3.3.7. Test Result of Power Spectral Density**

|                      |              |                       |                          |
|----------------------|--------------|-----------------------|--------------------------|
| <b>Test Date</b>     | May 14, 2008 | <b>Test Site No.</b>  | TH01-HY                  |
| <b>Temperature</b>   | 28           | <b>Humidity</b>       | 58%                      |
| <b>Test Engineer</b> | Nan          | <b>Configurations</b> | 802.11b/g (Scenarios. A) |

**Configuration IEEE 802.11b**

| Channel | Frequency | Power Density (dBm) | Max. Limit (dBm) | Result          |
|---------|-----------|---------------------|------------------|-----------------|
| 1       | 2412 MHz  | -10.81              | 8.00             | <b>Complies</b> |
| 6       | 2437 MHz  | -10.51              | 8.00             | <b>Complies</b> |
| 11      | 2462 MHz  | -10.64              | 8.00             | <b>Complies</b> |

**Configuration IEEE 802.11g**

| Channel | Frequency | Power Density (dBm) | Max. Limit (dBm) | Result          |
|---------|-----------|---------------------|------------------|-----------------|
| 1       | 2412 MHz  | -12.78              | 8.00             | <b>Complies</b> |
| 6       | 2437 MHz  | -12.80              | 8.00             | <b>Complies</b> |
| 11      | 2462 MHz  | -12.60              | 8.00             | <b>Complies</b> |

|                      |              |                       |                          |
|----------------------|--------------|-----------------------|--------------------------|
| <b>Test Date</b>     | May 14, 2008 | <b>Test Site No.</b>  | TH01-HY                  |
| <b>Temperature</b>   | 28           | <b>Humidity</b>       | 58%                      |
| <b>Test Engineer</b> | Nan          | <b>Configurations</b> | 802.11b/g (Scenarios. B) |

**Configuration IEEE 802.11b**

| Channel | Frequency | Power Density (dBm) | Max. Limit (dBm) | Result          |
|---------|-----------|---------------------|------------------|-----------------|
| 1       | 2412 MHz  | -10.43              | 8.00             | <b>Complies</b> |
| 6       | 2437 MHz  | -10.33              | 8.00             | <b>Complies</b> |
| 11      | 2462 MHz  | -10.72              | 8.00             | <b>Complies</b> |

**Configuration IEEE 802.11g**

| Channel | Frequency | Power Density (dBm) | Max. Limit (dBm) | Result          |
|---------|-----------|---------------------|------------------|-----------------|
| 1       | 2412 MHz  | -12.06              | 8.00             | <b>Complies</b> |
| 6       | 2437 MHz  | -12.31              | 8.00             | <b>Complies</b> |
| 11      | 2462 MHz  | -12.29              | 8.00             | <b>Complies</b> |

Power Density Plot on Configuration IEEE 802.11b / 2412 MHz / Scenarios. A

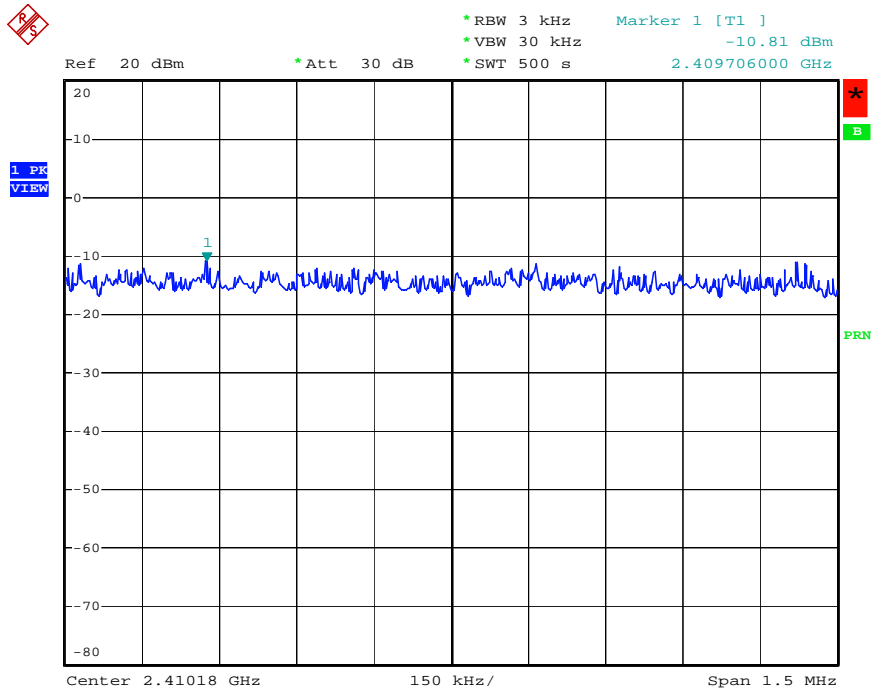

Date: 14.MAY.2008 16:06:15

Power Density Plot on Configuration IEEE 802.11b / 2437 MHz / Scenarios. A

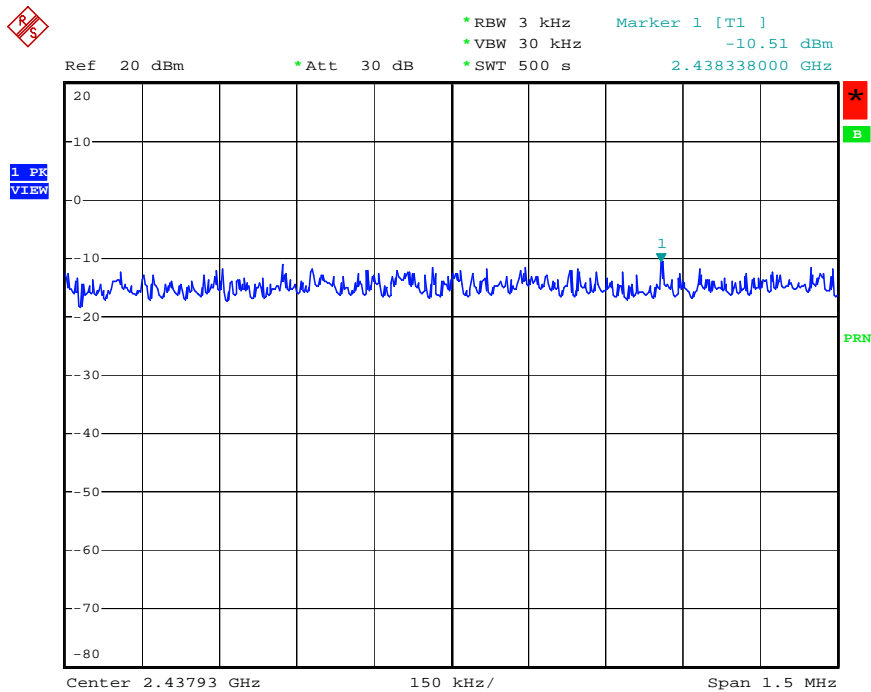

Date: 14.MAY.2008 16:07:46

Power Density Plot on Configuration IEEE 802.11b / 2462 MHz / Scenarios. A

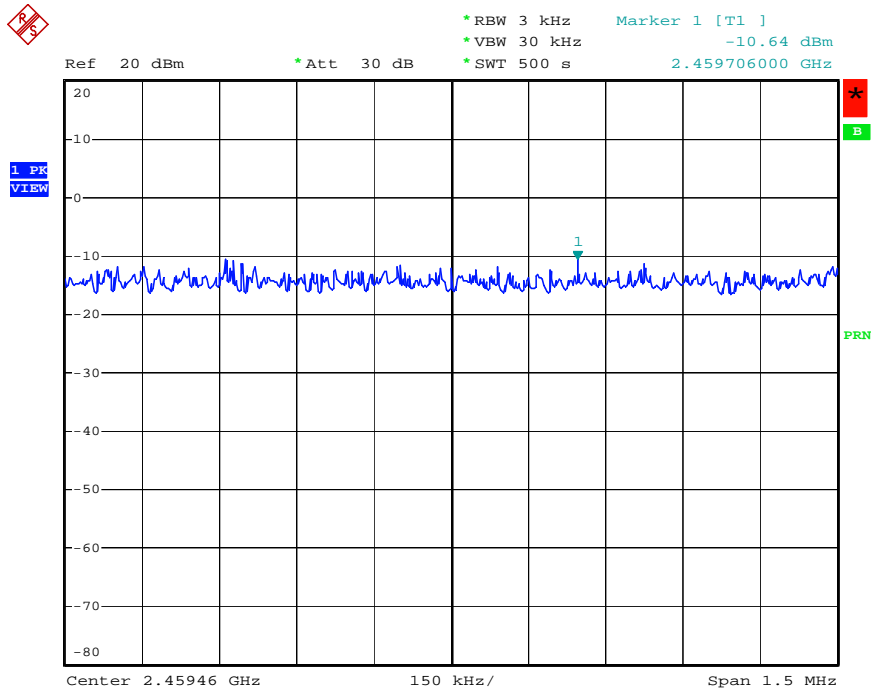

Date: 14.MAY.2008 16:12:46

Power Density Plot on Configuration IEEE 802.11g / 2412 MHz / Scenarios. A

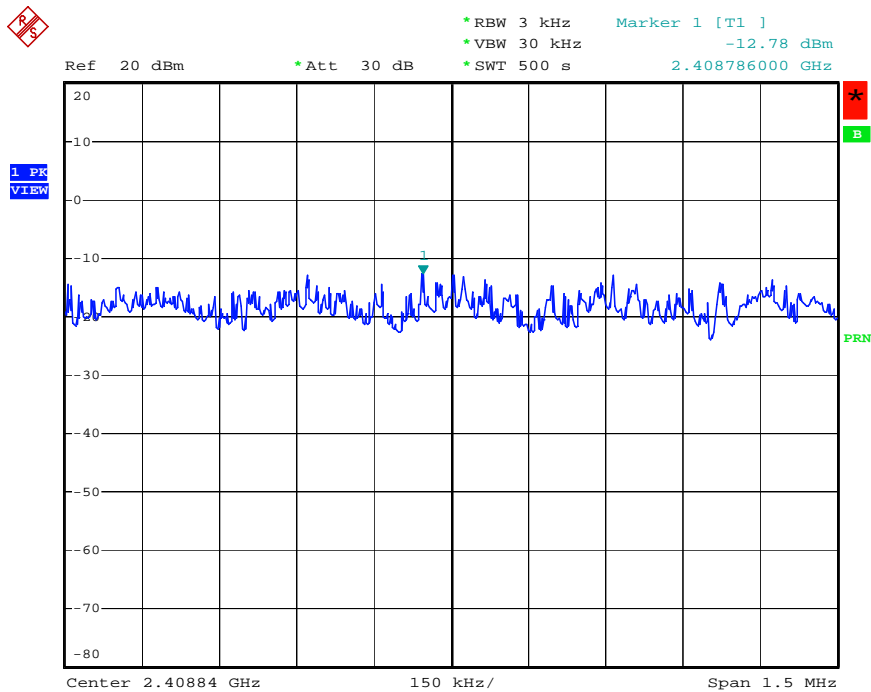

Date: 14.MAY.2008 16:15:48

Power Density Plot on Configuration IEEE 802.11g / 2437 MHz / Scenarios. A

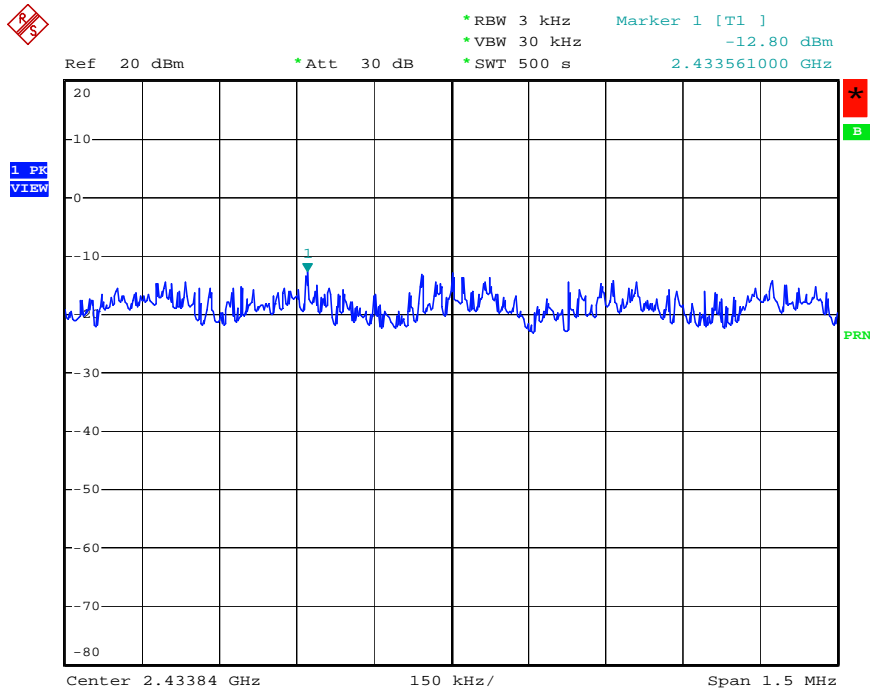

Date: 14.MAY.2008 16:23:38

Power Density Plot on Configuration IEEE 802.11g / 2462 MHz / Scenarios. A

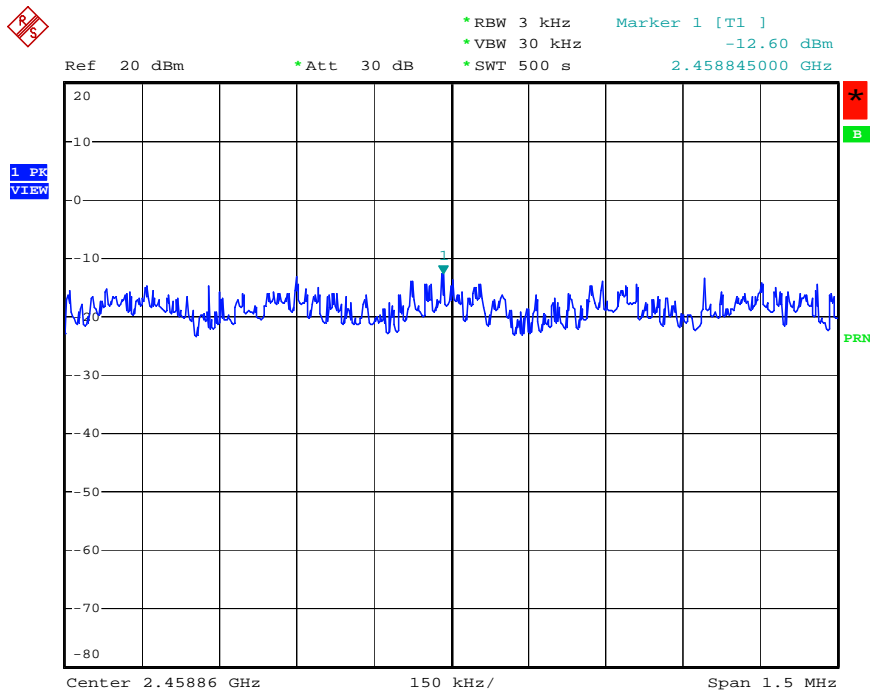

Date: 14.MAY.2008 16:26:08

Power Density Plot on Configuration IEEE 802.11b / 2412 MHz / Scenarios. B

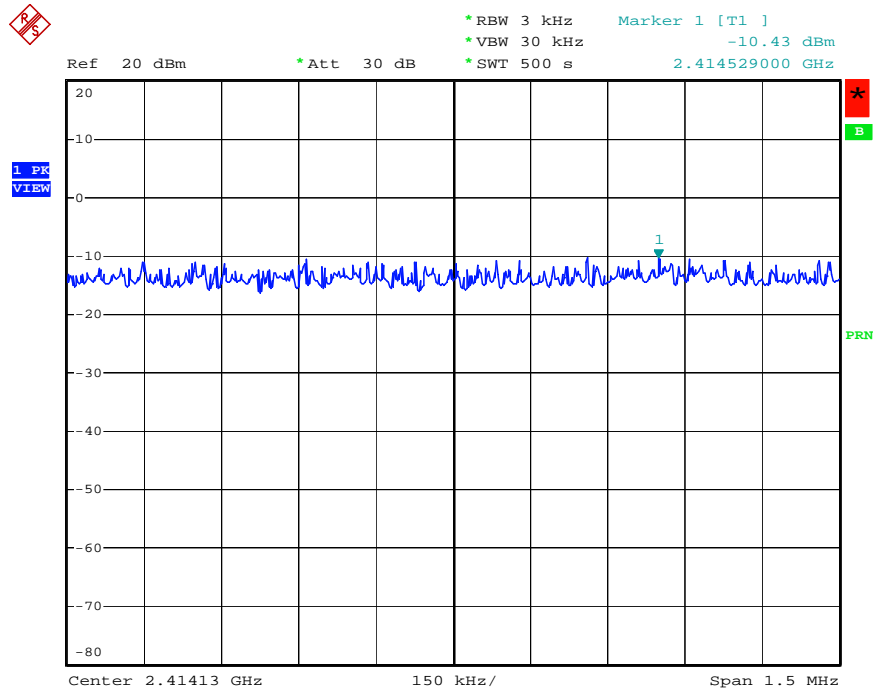

Date: 14.MAY.2008 15:37:10

Power Density Plot on Configuration IEEE 802.11b / 2437 MHz / Scenarios. B

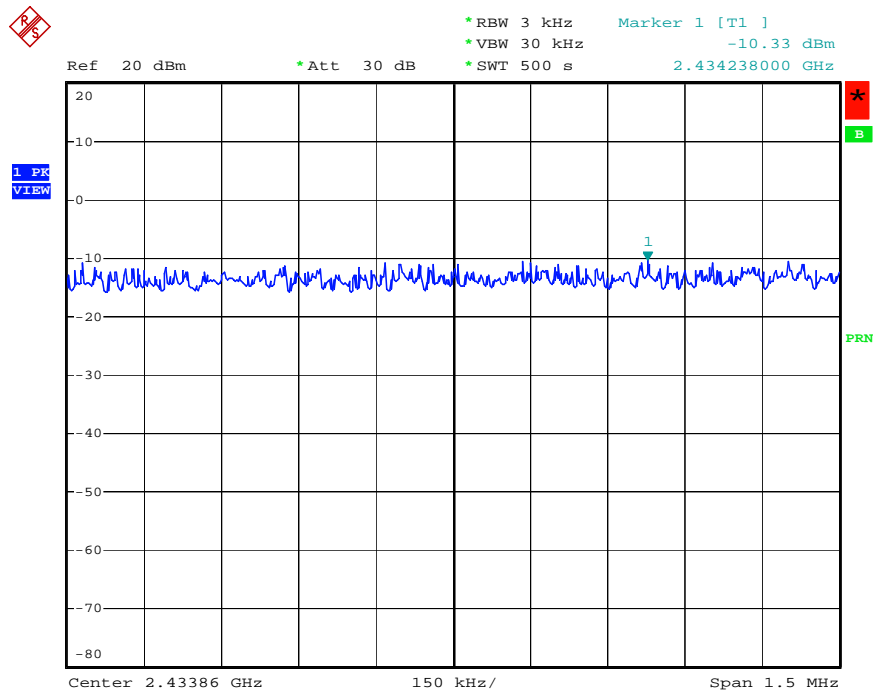

Date: 14.MAY.2008 15:40:30

Power Density Plot on Configuration IEEE 802.11b / 2462 MHz / Scenarios. B

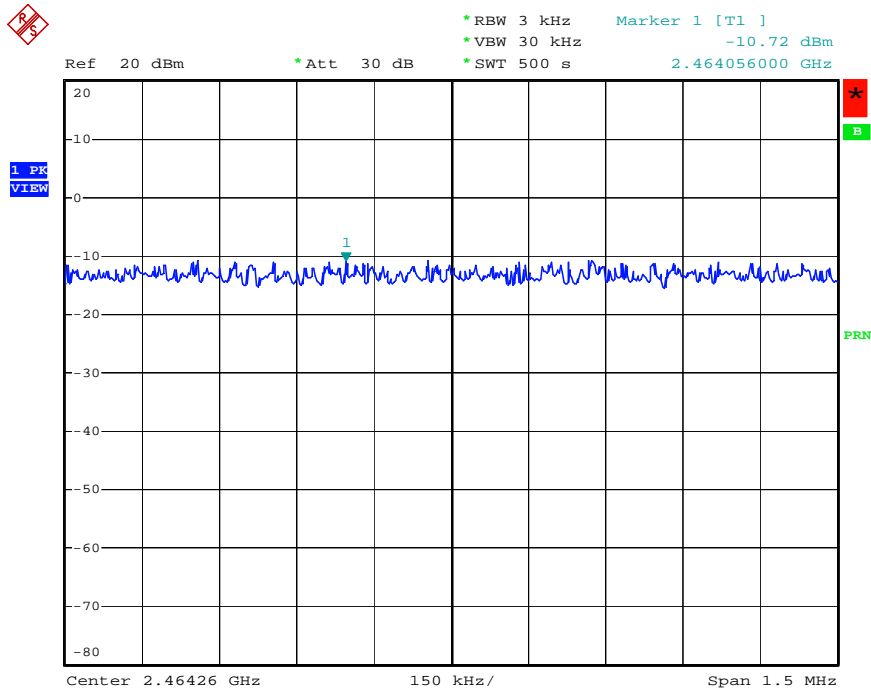

Date: 14.MAY.2008 15:46:53

Power Density Plot on Configuration IEEE 802.11g / 2412 MHz / Scenarios. B

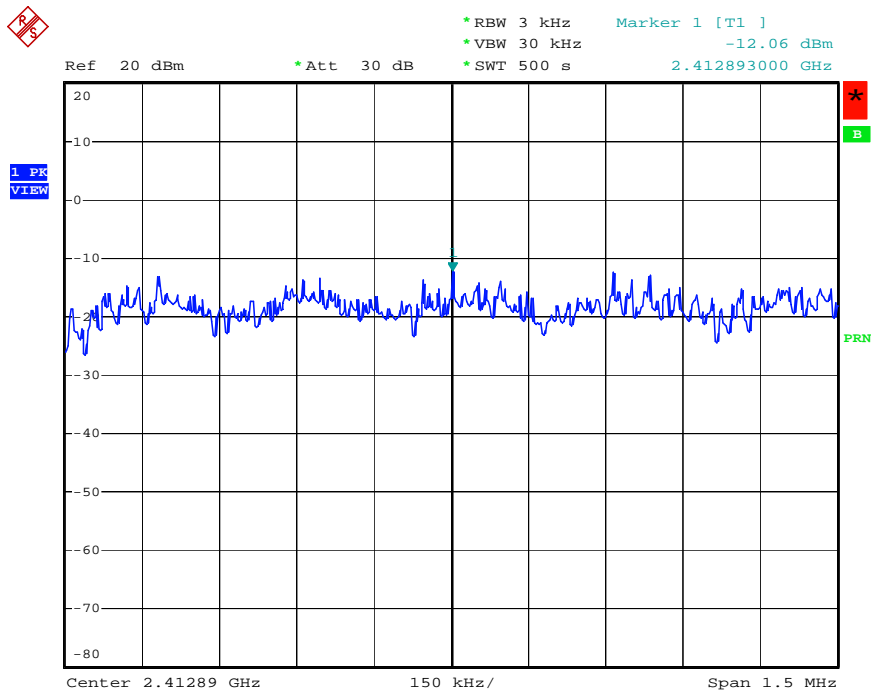

Date: 14.MAY.2008 15:50:48

Power Density Plot on Configuration IEEE 802.11g / 2437 MHz / Scenarios. B

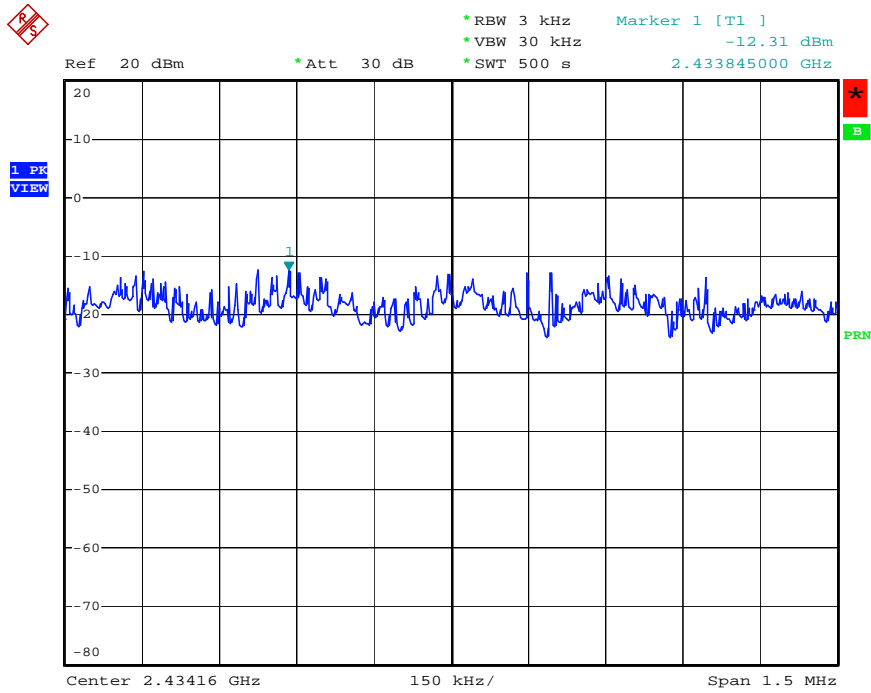

Date: 14.MAY.2008 15:55:48

Power Density Plot on Configuration IEEE 802.11g / 2462 MHz / Scenarios. B

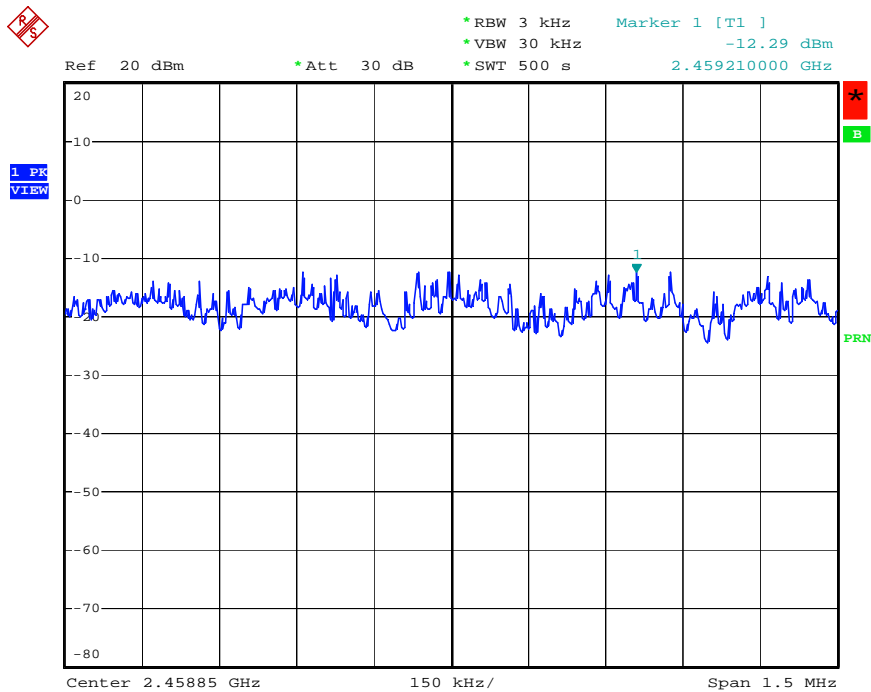

Date: 14.MAY.2008 15:56:47



**3.4. 6dB Spectrum Bandwidth Measurement**

**3.4.1. Limit**

For digital modulation systems, the minimum 6dB bandwidth shall be at least 500 kHz.

**3.4.2. Measuring Instruments and Setting**

Please refer to section 4 of equipments list in this report. The following table is the setting of the spectrum analyzer.

| Spectrum Parameters | Setting         |
|---------------------|-----------------|
| Attenuation         | Auto            |
| Span Frequency      | > 6dB Bandwidth |
| RB                  | 100 kHz         |
| VB                  | 100 kHz         |
| Detector            | Peak            |
| Trace               | Max Hold        |
| Sweep Time          | Auto            |

**3.4.3. Test Procedures**

1. The transmitter output (antenna port) was connected to the spectrum analyser in peak hold mode.
2. The resolution bandwidth of 100 kHz and the video bandwidth of 100 kHz were used.
3. Measured the spectrum width with power higher than 6dB below carrier.
4. In case of conducted measurements on smart antenna systems (devices with multiple transmit chains) a power splitter/combiner shall be used to combine all the transmit chains (antenna outputs) into a single test point. The insertion loss of the power splitter/combiner shall be taken into account.

**3.4.4. Test Setup Layout**

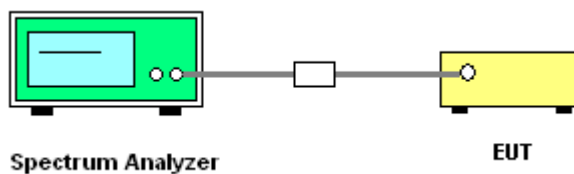

**3.4.5. Test Deviation**

There is no deviation with the original standard.

**3.4.6. EUT Operation during Test**

The EUT was programmed to be in continuously transmitting mode.

**3.4.7. Test Result of 6dB Spectrum Bandwidth**

|                      |              |                       |                          |
|----------------------|--------------|-----------------------|--------------------------|
| <b>Test Date</b>     | May 14, 2008 | <b>Test Site No.</b>  | TH01-HY                  |
| <b>Temperature</b>   | 28           | <b>Humidity</b>       | 58%                      |
| <b>Test Engineer</b> | Nan          | <b>Configurations</b> | 802.11b/g (Scenarios. A) |

**Configuration IEEE 802.11b**

| Channel | Frequency | 6dB Bandwidth (MHz) | 99% Occupied Bandwidth (MHz) | Min. Limit (kHz) | Test Result     |
|---------|-----------|---------------------|------------------------------|------------------|-----------------|
| 1       | 2412 MHz  | 10.68               | 12.56                        | 500              | <b>Complies</b> |
| 6       | 2437 MHz  | 11.04               | 12.56                        | 500              | <b>Complies</b> |
| 11      | 2462 MHz  | 11.08               | 12.56                        | 500              | <b>Complies</b> |

**Configuration IEEE 802.11g**

| Channel | Frequency | 6dB Bandwidth (MHz) | 99% Occupied Bandwidth (MHz) | Min. Limit (kHz) | Test Result     |
|---------|-----------|---------------------|------------------------------|------------------|-----------------|
| 1       | 2412 MHz  | 16.28               | 16.40                        | 500              | <b>Complies</b> |
| 6       | 2437 MHz  | 16.44               | 16.40                        | 500              | <b>Complies</b> |
| 11      | 2462 MHz  | 16.36               | 16.36                        | 500              | <b>Complies</b> |

|                      |              |                       |                          |
|----------------------|--------------|-----------------------|--------------------------|
| <b>Test Date</b>     | May 14, 2008 | <b>Test Site No.</b>  | TH01-HY                  |
| <b>Temperature</b>   | 28           | <b>Humidity</b>       | 58%                      |
| <b>Test Engineer</b> | Nan          | <b>Configurations</b> | 802.11b/g (Scenarios. B) |

**Configuration IEEE 802.11b**

| Channel | Frequency | 6dB Bandwidth (MHz) | 99% Occupied Bandwidth (MHz) | Min. Limit (kHz) | Test Result     |
|---------|-----------|---------------------|------------------------------|------------------|-----------------|
| 1       | 2412 MHz  | 11.08               | 12.56                        | 500              | <b>Complies</b> |
| 6       | 2437 MHz  | 11.08               | 12.56                        | 500              | <b>Complies</b> |
| 11      | 2462 MHz  | 11.04               | 12.56                        | 500              | <b>Complies</b> |

**Configuration IEEE 802.11g**

| Channel | Frequency | 6dB Bandwidth (MHz) | 99% Occupied Bandwidth (MHz) | Min. Limit (kHz) | Test Result     |
|---------|-----------|---------------------|------------------------------|------------------|-----------------|
| 1       | 2412 MHz  | 16.36               | 16.40                        | 500              | <b>Complies</b> |
| 6       | 2437 MHz  | 16.36               | 16.36                        | 500              | <b>Complies</b> |
| 11      | 2462 MHz  | 16.44               | 16.36                        | 500              | <b>Complies</b> |

6 dB Bandwidth Plot on Configuration IEEE 802.11b / 2412 MHz / Scenarios. A

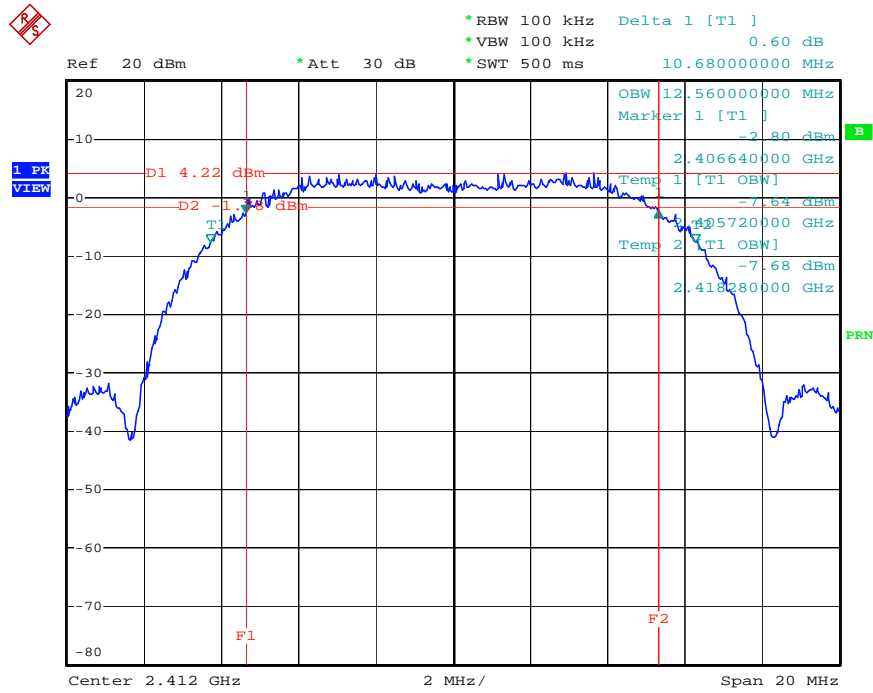

Date: 14.MAY.2008 16:04:48

6 dB Bandwidth Plot on Configuration IEEE 802.11b / 2437 MHz / Scenarios. A

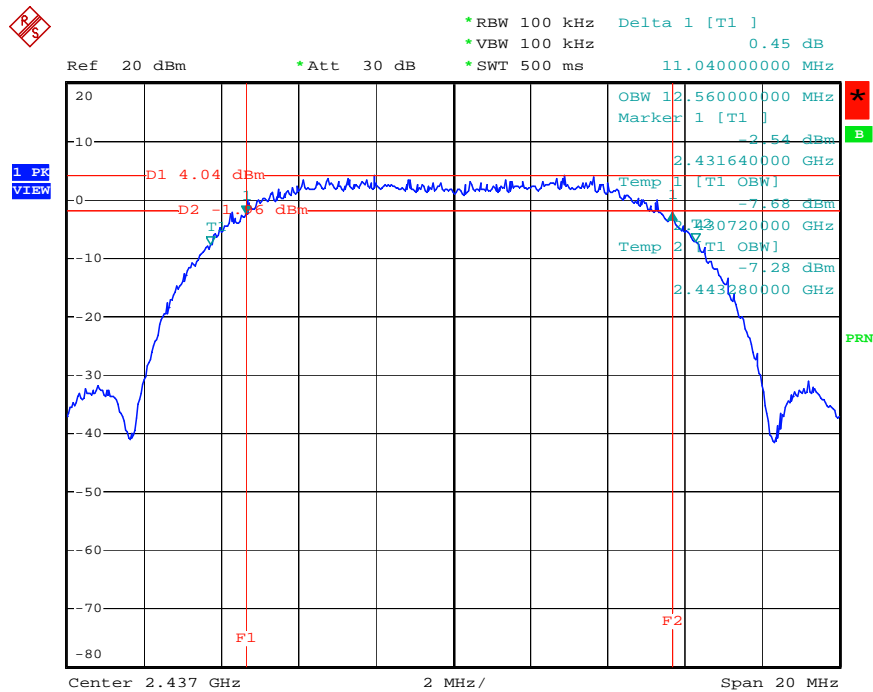

Date: 14.MAY.2008 16:09:06

6 dB Bandwidth Plot on Configuration IEEE 802.11b / 2462 MHz / Scenarios. A

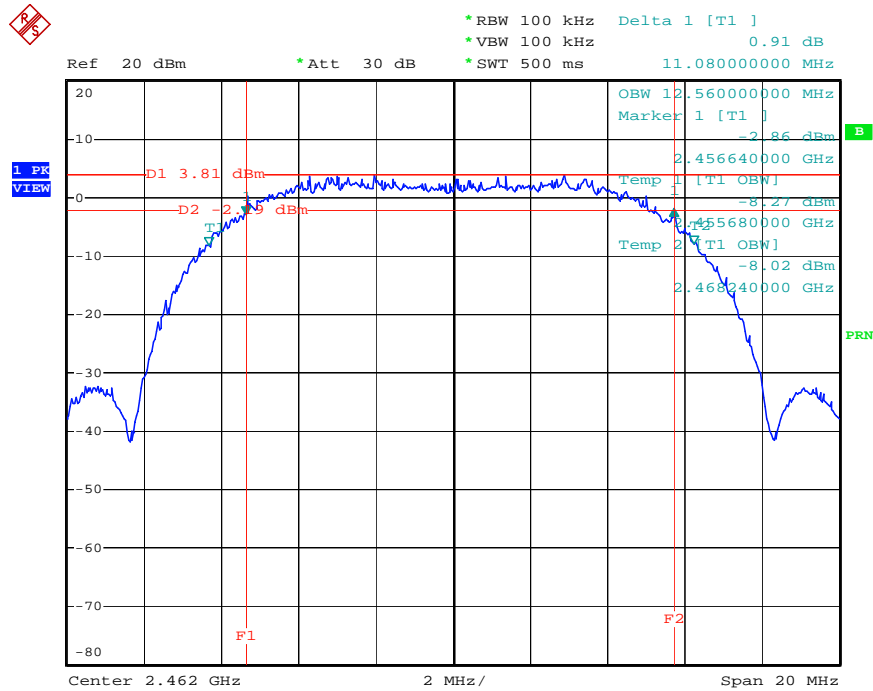

Date: 14.MAY.2008 16:11:00

6 dB Bandwidth Plot on Configuration IEEE 802.11g / 2412 MHz / Scenarios. A

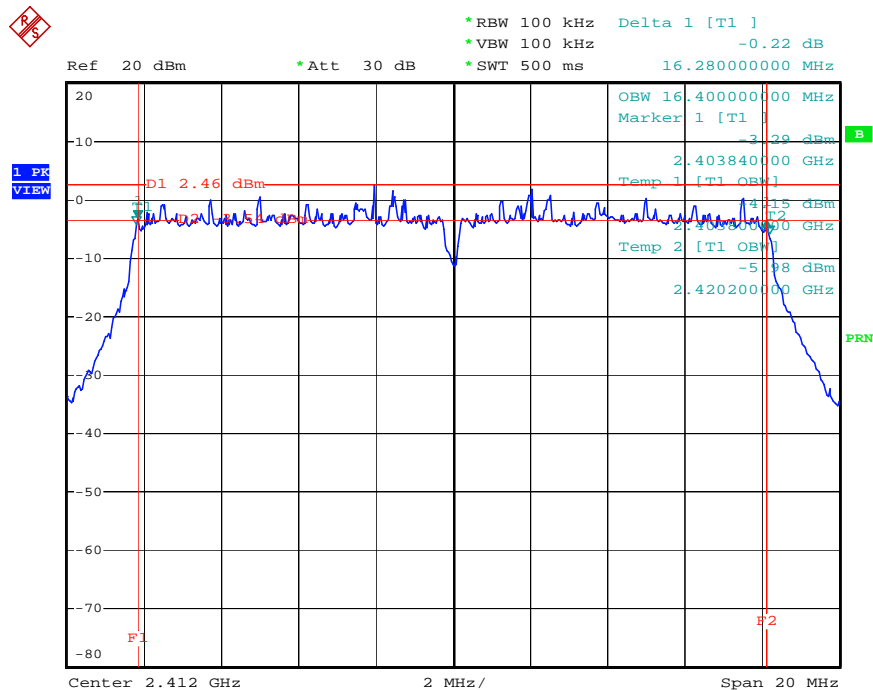

Date: 14.MAY.2008 16:17:38

6 dB Bandwidth Plot on Configuration IEEE 802.11g / 2437 MHz / Scenarios. A

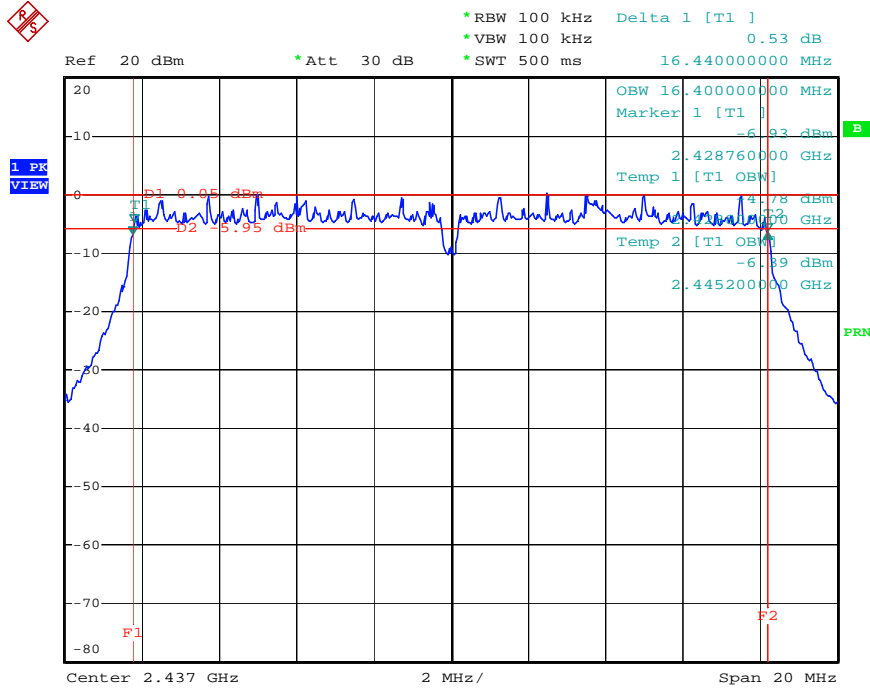

Date: 14.MAY.2008 16:20:47

6 dB Bandwidth Plot on Configuration IEEE 802.11g / 2462 MHz / Scenarios. A

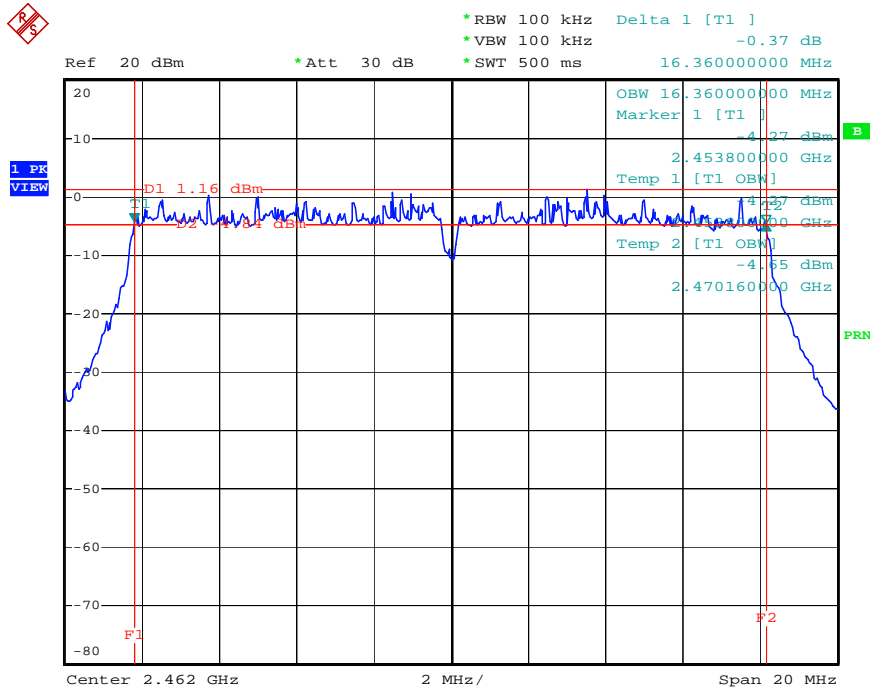

Date: 14.MAY.2008 16:28:21

6 dB Bandwidth Plot on Configuration IEEE 802.11b / 2412 MHz / Scenarios. B

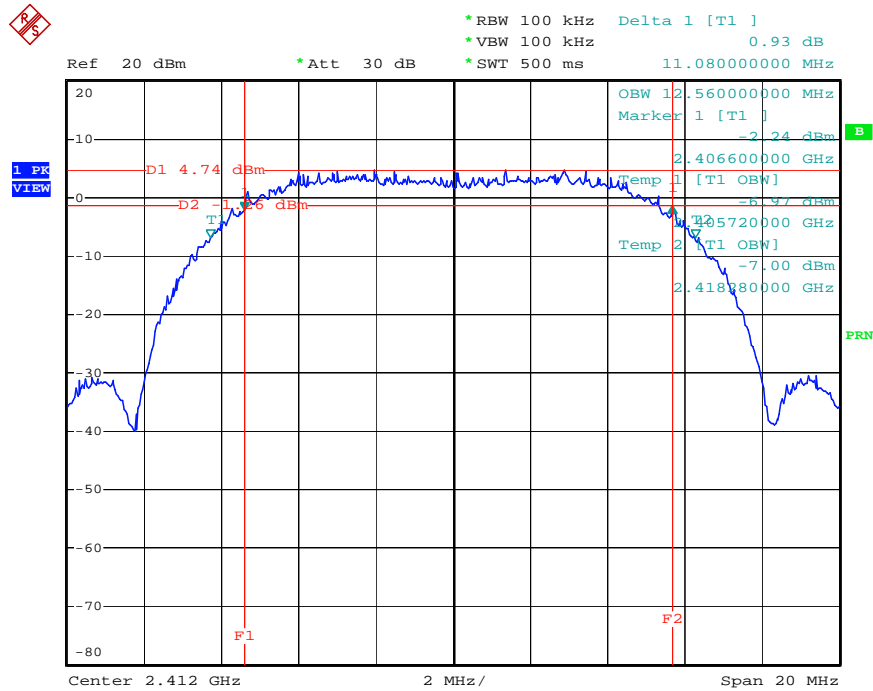

Date: 14.MAY.2008 15:35:15

6 dB Bandwidth Plot on Configuration IEEE 802.11b / 2437 MHz / Scenarios. B

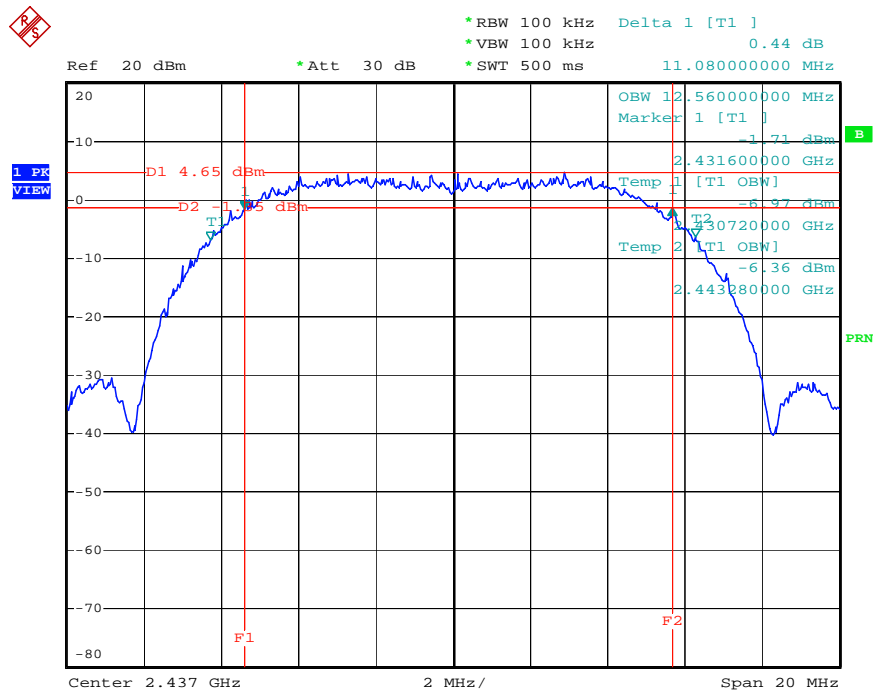

Date: 14.MAY.2008 15:41:56

6 dB Bandwidth Plot on Configuration IEEE 802.11b / 2462 MHz / Scenarios. B

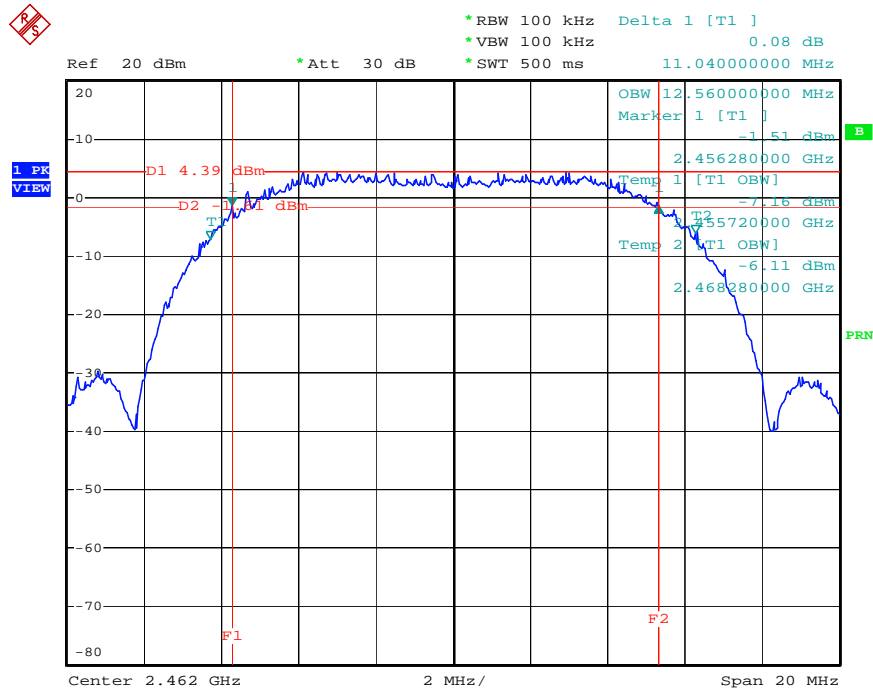

Date: 14.MAY.2008 15:44:19

6 dB Bandwidth Plot on Configuration IEEE 802.11g / 2412 MHz / Scenarios. B

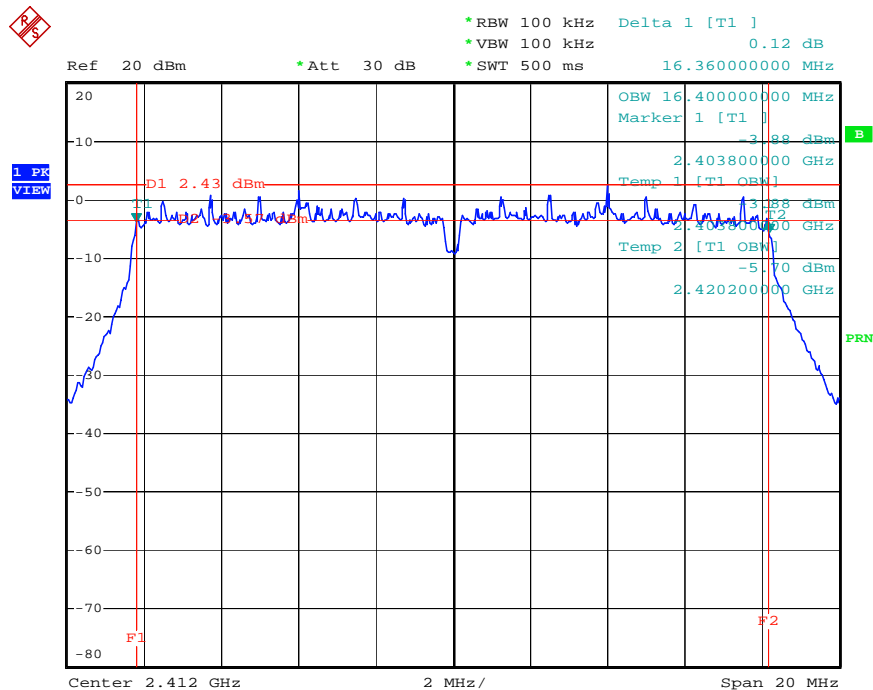

Date: 14.MAY.2008 15:52:59



6 dB Bandwidth Plot on Configuration IEEE 802.11g / 2437 MHz / Scenarios. B

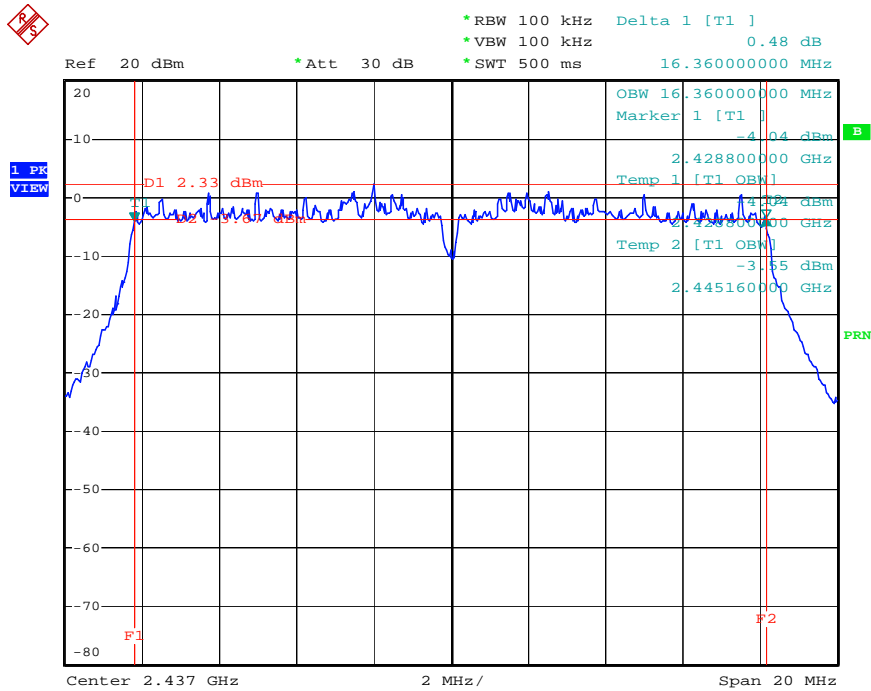

Date: 14.MAY.2008 15:54:59

6 dB Bandwidth Plot on Configuration IEEE 802.11g / 2462 MHz / Scenarios. B

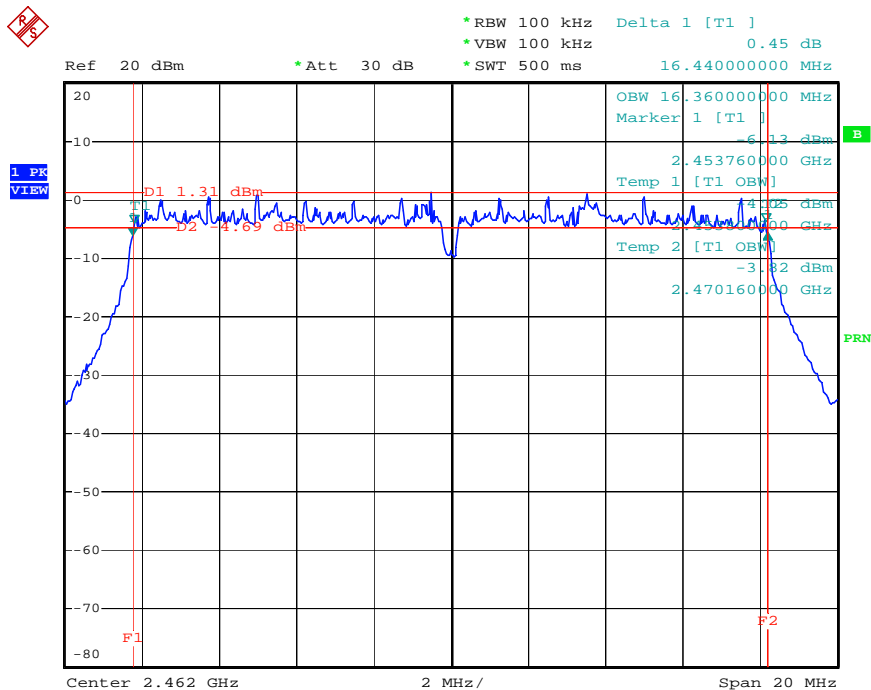

Date: 14.MAY.2008 15:58:51

**3.5. Radiated Emissions Measurement**

**3.5.1. Limit**

20dBc in any 100 kHz bandwidth outside the operating frequency band. In case the emissions fall within the restricted band specified on 15.205(a), then the 15.209(a) limit in the table below has to be followed.

| <b>Frequencies (MHz)</b> | <b>Field Strength (micorvolts/meter)</b> | <b>Measurement Distance (meters)</b> |
|--------------------------|------------------------------------------|--------------------------------------|
| 0.009~0.490              | 2400/F(KHz)                              | 300                                  |
| 0.490~1.705              | 24000/F(KHz)                             | 30                                   |
| 1.705~30.0               | 30                                       | 30                                   |
| 30~88                    | 100                                      | 3                                    |
| 88~216                   | 150                                      | 3                                    |
| 216~960                  | 200                                      | 3                                    |
| Above 960                | 500                                      | 3                                    |

**3.5.2. Measuring Instruments and Settings**

Please refer to section 4 of equipments list in this report. The following table is the setting of spectrum analyzer and receiver.

| <b>Spectrum Parameter</b>                 | <b>Setting</b>                                 |
|-------------------------------------------|------------------------------------------------|
| Attenuation                               | Auto                                           |
| Start Frequency                           | 1000 MHz                                       |
| Stop Frequency                            | 10th carrier harmonic                          |
| RB / VB (Emission in restricted band)     | 1MHz / 1MHz for Peak, 1 MHz / 10Hz for Average |
| RB / VB (Emission in non-restricted band) | 100KHz / 100KHz for peak                       |

| <b>Receiver Parameter</b> | <b>Setting</b>                   |
|---------------------------|----------------------------------|
| Attenuation               | Auto                             |
| Start ~ Stop Frequency    | 9kHz~150kHz / RB 200Hz for QP    |
| Start ~ Stop Frequency    | 150kHz~30MHz / RB 9kHz for QP    |
| Start ~ Stop Frequency    | 30MHz~1000MHz / RB 120kHz for QP |

**3.5.3. Test Procedures**

1. Configure the EUT according to ANSI C63.4. The EUT was placed on the top of the turntable 0.8 meter above ground. The phase center of the receiving antenna mounted on the top of a height-variable antenna tower was placed 3 meters far away from the turntable.
2. Power on the EUT and all the supporting units. The turntable was rotated by 360 degrees to determine the position of the highest radiation.
3. The height of the broadband receiving antenna was varied between one meter and four meters above ground to find the maximum emissions field strength of both horizontal and vertical polarization.
4. For each suspected emissions, the antenna tower was scan (from 1 M to 4 M) and then the turntable was rotated (from 0 degree to 360 degrees) to find the maximum reading.
5. Set the test-receiver system to Peak or CISPR quasi-peak Detect Function with specified bandwidth under Maximum Hold Mode.
6. For emissions above 1GHz, use 1MHz VBW and RBW for peak reading. Then 1MHz RBW and 10Hz VBW for average reading in spectrum analyzer.
7. When the radiated emissions limits are expressed in terms of the average value of the emissions, and pulsed operation is employed, the measurement field strength shall be determined by averaging over one complete pulse train, including blanking intervals, as long as the pulse train does not exceed 0.1 seconds. As an alternative (provided the transmitter operates for longer than 0.1 seconds) or in cases where the pulse train exceeds 0.1 seconds, the measured field strength shall be determined from the average absolute voltage during a 0.1 second interval during which the field strength is at its maximum value.
8. If the emissions level of the EUT in peak mode was 3 dB lower than the average limit specified, then testing will be stopped and peak values of EUT will be reported, otherwise, the emissions which do not have 3 dB margin will be repeated one by one using the quasi-peak method for below 1GHz.
9. For testing above 1GHz, the emissions level of the EUT in peak mode was lower than average limit (that means the emissions level in peak mode also complies with the limit in average mode), then testing will be stopped and peak values of EUT will be reported, otherwise, the emissions will be measured in average mode again and reported.
10. In case the emission is lower than 30MHz, loop antenna has to be used for measurement and the recorded data should be QP measured by receiver. High – Low scan is not required in this case.

3.5.4. Test Setup Layout

For radiated emissions below 30MHz

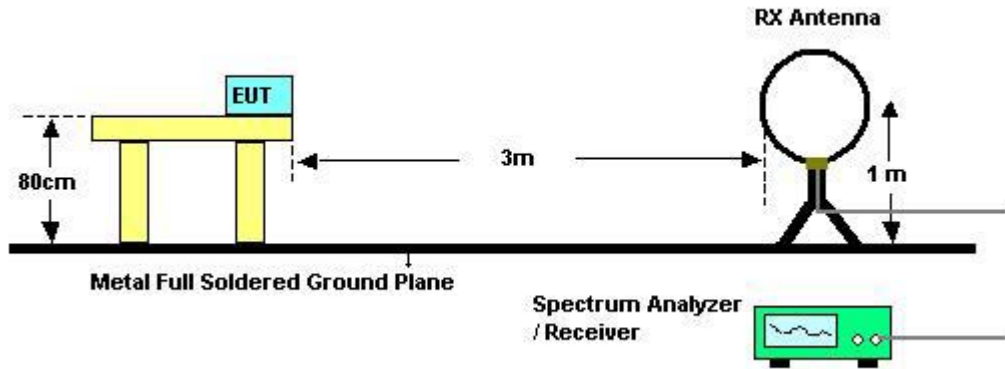

For radiated emissions above 30MHz

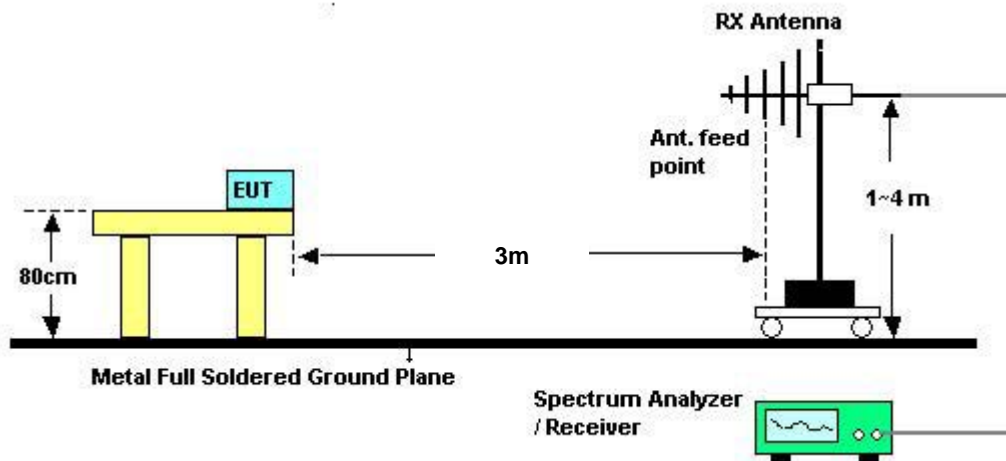

Above 10 GHz shall be extrapolated to the specified distance using an extrapolation factor of 20 dB/decade from 3m to 1m.

Distance extrapolation factor =  $20 \log (\text{specific distance [3m]} / \text{test distance [1m]})$  (dB);

Limit line = specific limits (dBuV) + distance extrapolation factor [9.54 dB].

3.5.5. Test Deviation

There is no deviation with the original standard.

3.5.6. EUT Operation during Test

The EUT was programmed to be in continuously transmitting mode.

**3.5.7. Results of Radiated Emissions (9kHz~30MHz)**

|                      |              |                      |           |
|----------------------|--------------|----------------------|-----------|
| <b>Test Date</b>     | May 13, 2008 | <b>Test Site No.</b> | 03CH02-HY |
| <b>Temperature</b>   | 27           | <b>Humidity</b>      | 58%       |
| <b>Test Engineer</b> | Murphy       |                      |           |

| <b>Freq.<br/>(MHz)</b> | <b>Level<br/>(dBuV)</b> | <b>Over Limit<br/>(dB)</b> | <b>Limit Line<br/>(dBuV)</b> | <b>Remark</b> |
|------------------------|-------------------------|----------------------------|------------------------------|---------------|
| -                      | -                       | -                          | -                            | See Note      |

Note:

The amplitude of spurious emissions that are attenuated by more than 20 dB below the permissible value has no need to be reported.

3.5.8. Results of Radiated Emissions (30MHz~1GHz)

|               |              |                |              |
|---------------|--------------|----------------|--------------|
| Test Date     | May 13, 2008 | Test Site No.  | 03CH02-HY    |
| Temperature   | 27           | Humidity       | 58%          |
| Test Engineer | Murphy       | Configurations | 802.11g CH 6 |

Horizontal

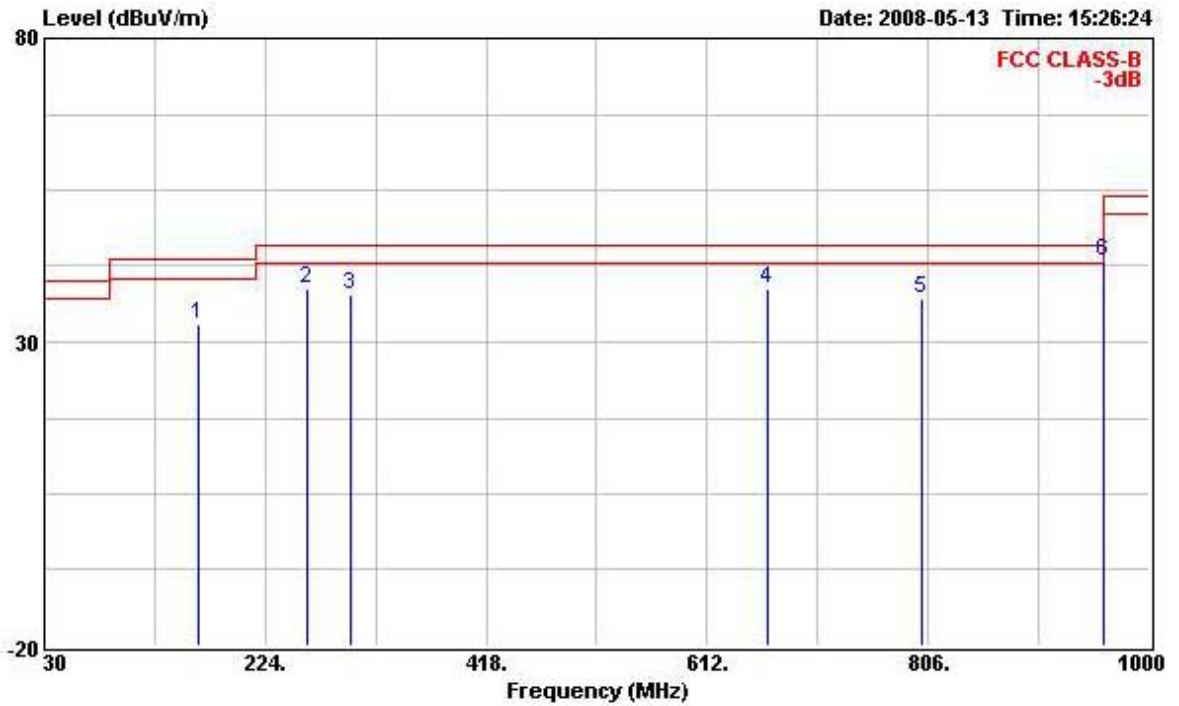

|   | Freq    | Level  | Over Limit | Limit Line | Read Level | Probe Factor | Cable Loss | Preamp Factor | Remark | Ant Pos | Table Pos |
|---|---------|--------|------------|------------|------------|--------------|------------|---------------|--------|---------|-----------|
|   | MHz     | dBUV/m | dB         | dBUV/m     | dBuV       | dB           | dB         | dB            |        | cm      | deg       |
| 1 | 164.830 | 32.99  | -10.51     | 43.50      | 50.75      | 10.34        | 2.57       | 30.67         | Peak   | ---     | ---       |
| 2 | 260.860 | 38.71  | -7.29      | 46.00      | 52.84      | 13.15        | 3.20       | 30.48         | Peak   | ---     | ---       |
| 3 | 299.660 | 37.85  | -8.15      | 46.00      | 51.07      | 13.70        | 3.48       | 30.40         | Peak   | ---     | ---       |
| 4 | 664.380 | 38.66  | -7.34      | 46.00      | 43.53      | 19.32        | 5.15       | 29.34         | Peak   | ---     | ---       |
| 5 | 800.180 | 37.19  | -8.81      | 46.00      | 40.42      | 20.27        | 5.50       | 29.00         | Peak   | ---     | ---       |
| 6 | 960.230 | 43.26  | -10.74     | 54.00      | 44.11      | 21.52        | 6.09       | 28.46         | Peak   | ---     | ---       |

Vertical

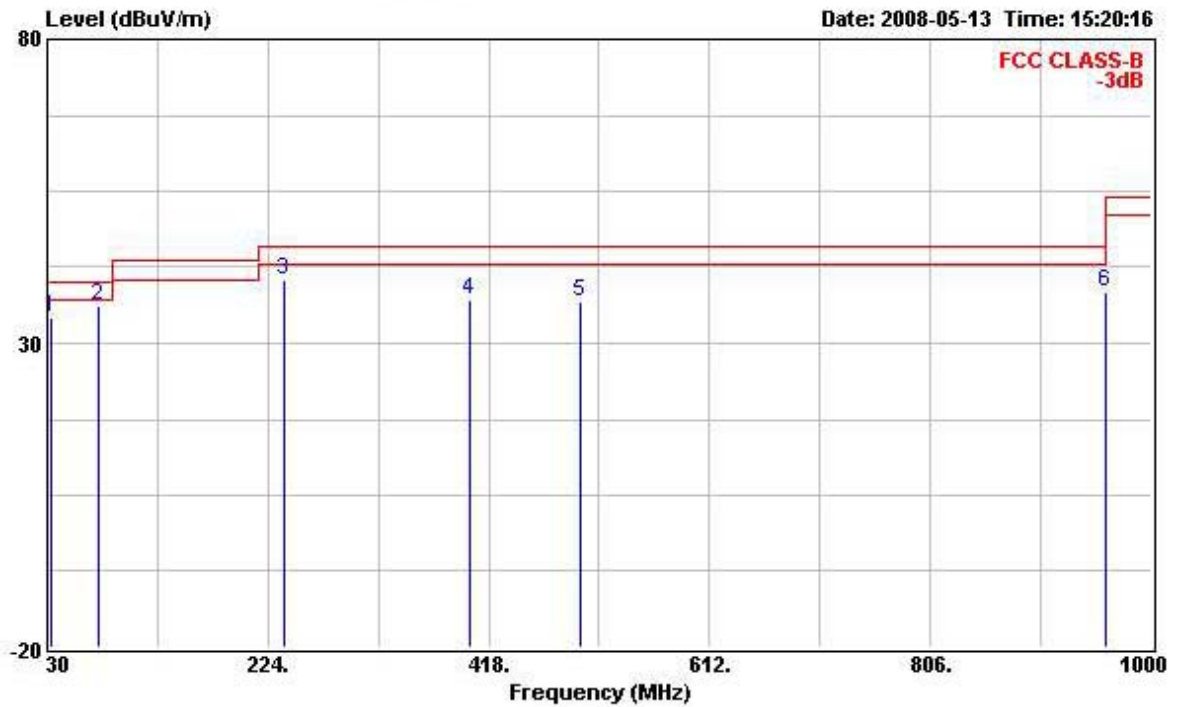

|   | Freq    | Level  | Over Limit | Limit Line | Read Level | Probe Factor | Cable Loss | Preamp Factor | Remark | Ant Pos | Table Pos |
|---|---------|--------|------------|------------|------------|--------------|------------|---------------|--------|---------|-----------|
|   | MHz     | dBuV/m | dB         | dBuV/m     | dBuV       | dB           | dB         | dB            |        | cm      | deg       |
| 1 | 32.910  | 34.22  | -5.78      | 40.00      | 48.72      | 15.11        | 1.26       | 30.87         | Peak   | ---     | ---       |
| 2 | 75.590  | 36.15  | -3.85      | 40.00      | 58.07      | 7.11         | 1.77       | 30.80         | Peak   | ---     | ---       |
| 3 | 238.550 | 40.43  | -5.57      | 46.00      | 55.33      | 12.62        | 3.00       | 30.52         | Peak   | ---     | ---       |
| 4 | 400.540 | 37.07  | -8.93      | 46.00      | 48.09      | 15.27        | 3.91       | 30.20         | Peak   | ---     | ---       |
| 5 | 498.510 | 36.81  | -9.19      | 46.00      | 45.19      | 17.26        | 4.26       | 29.90         | Peak   | ---     | ---       |
| 6 | 960.230 | 38.59  | -15.41     | 54.00      | 39.44      | 21.52        | 6.09       | 28.46         | Peak   | ---     | ---       |

Note:

The amplitude of spurious emissions that are attenuated by more than 20dB below the permissible value has no need to be reported.

Emission level (dBuV/m) = 20 log Emission level (uV/m).

Corrected Reading: Antenna Factor + Cable Loss + Read Level - Preamp Factor = Level.

3.5.9. Results for Radiated Emissions (1GHz~10<sup>th</sup> Harmonic)

|               |              |                |                             |
|---------------|--------------|----------------|-----------------------------|
| Test Date     | May 13, 2008 | Test Site No.  | 03CH02-HY                   |
| Temperature   | 27           | Humidity       | 58%                         |
| Test Engineer | Murphy       | Configurations | 802.11b CH 1 (Scenarios. A) |

Horizontal

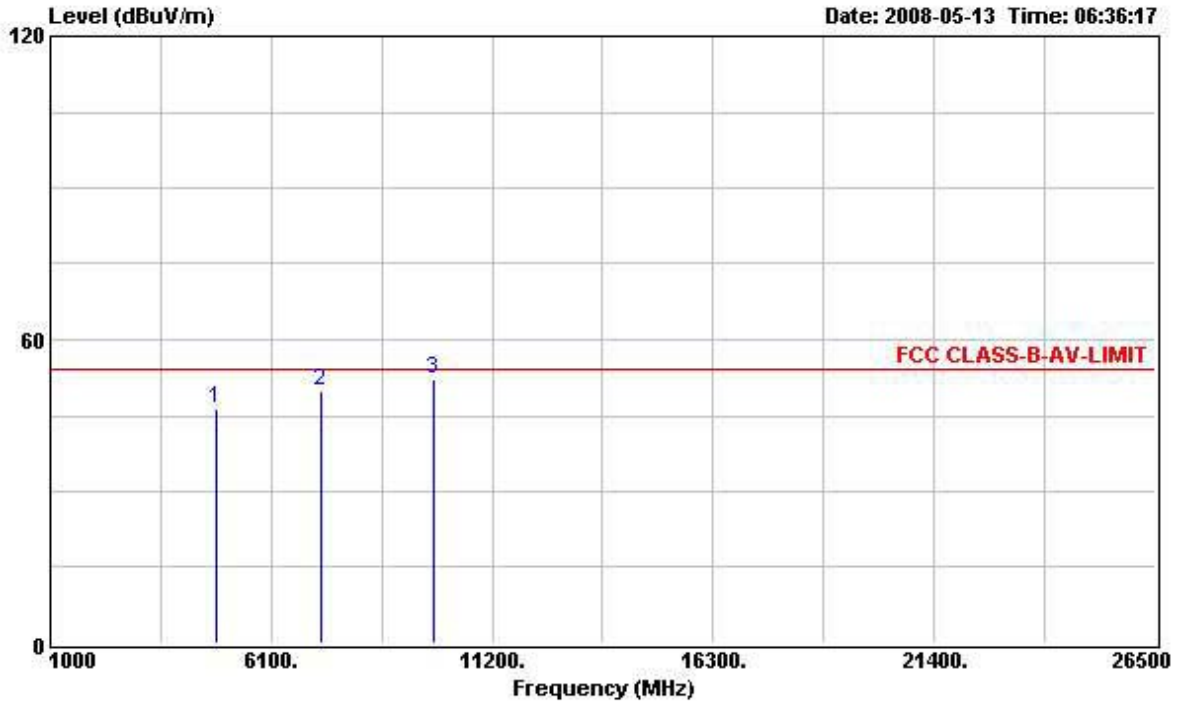

|   | Freq     | Level  | Over Limit | Limit Line | Read Level | Probe Factor | Cable Loss | Preamp Factor | Remark | Ant Pos | Table Pos |
|---|----------|--------|------------|------------|------------|--------------|------------|---------------|--------|---------|-----------|
|   | MHz      | dBuV/m | dB         | dBuV/m     | dBuV       | dB           | dB         | dB            |        | cm      | deg       |
| 1 | 4824.000 | 46.45  | -7.55      | 54.00      | 43.78      | 33.02        | 4.59       | 34.94         | Peak   | ---     | ---       |
| 2 | 7240.000 | 49.81  | -4.19      | 54.00      | 43.40      | 36.03        | 5.63       | 35.25         | Peak   | ---     | ---       |
| 3 | 9852.000 | 52.20  | -1.80      | 54.00      | 43.48      | 38.04        | 6.38       | 35.70         | Peak   | ---     | ---       |



Vertical

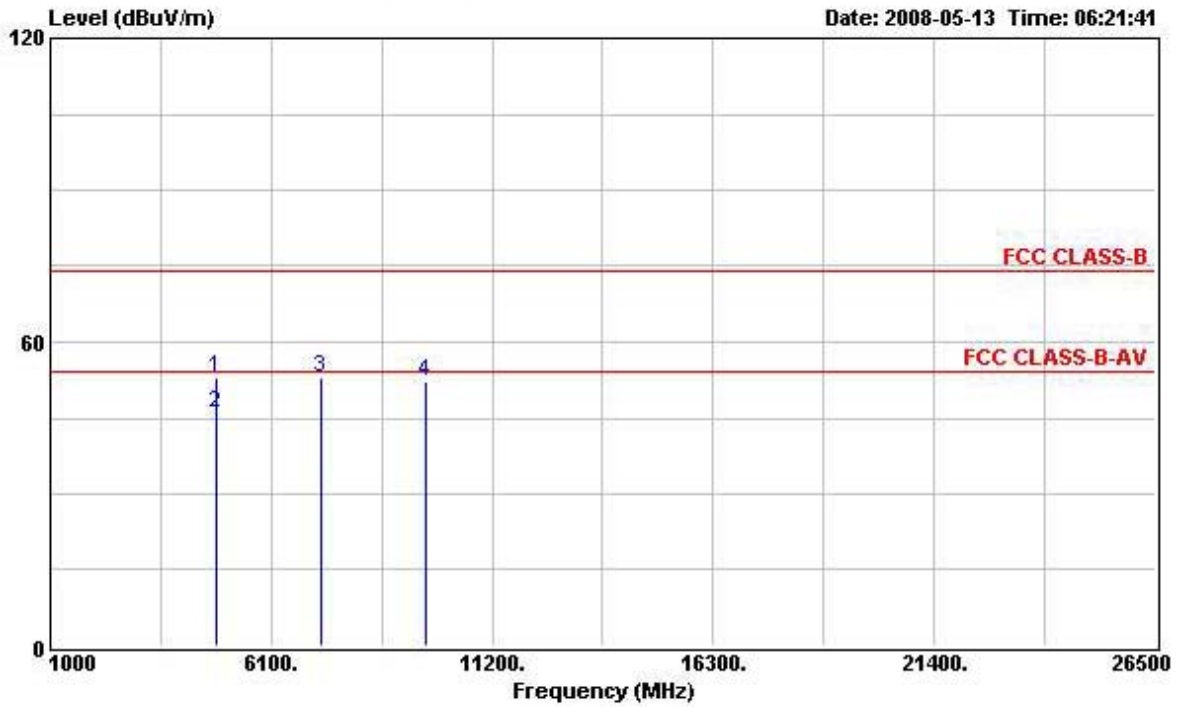

|   | Freq     | Level  | Over Limit | Limit Line | Read Level | Probe Factor | Cable Loss | Preamp Factor | Remark  | Ant Pos | Table Pos |
|---|----------|--------|------------|------------|------------|--------------|------------|---------------|---------|---------|-----------|
|   | MHz      | dBuV/m | dB         | dBuV/m     | dBuV       | dB           | dB         | dB            |         | cm      | deg       |
| 1 | 4824.000 | 52.86  | -21.14     | 74.00      | 50.19      | 33.02        | 4.59       | 34.94         | Peak    | ---     | ---       |
| 2 | 4824.000 | 45.80  | -8.20      | 54.00      | 43.13      | 33.02        | 4.59       | 34.94         | Average | ---     | ---       |
| 3 | 7232.000 | 52.93  | -1.07      | 54.00      | 46.51      | 36.03        | 5.63       | 35.24         | Average | ---     | ---       |
| 4 | 9648.000 | 52.13  | -1.87      | 54.00      | 43.53      | 37.96        | 6.34       | 35.70         | Peak    | ---     | ---       |

|               |              |                |                             |
|---------------|--------------|----------------|-----------------------------|
| Test Date     | May 13, 2008 | Test Site No.  | 03CH02-HY                   |
| Temperature   | 27           | Humidity       | 58%                         |
| Test Engineer | Murphy       | Configurations | 802.11b CH 6 (Scenarios. A) |

Horizontal

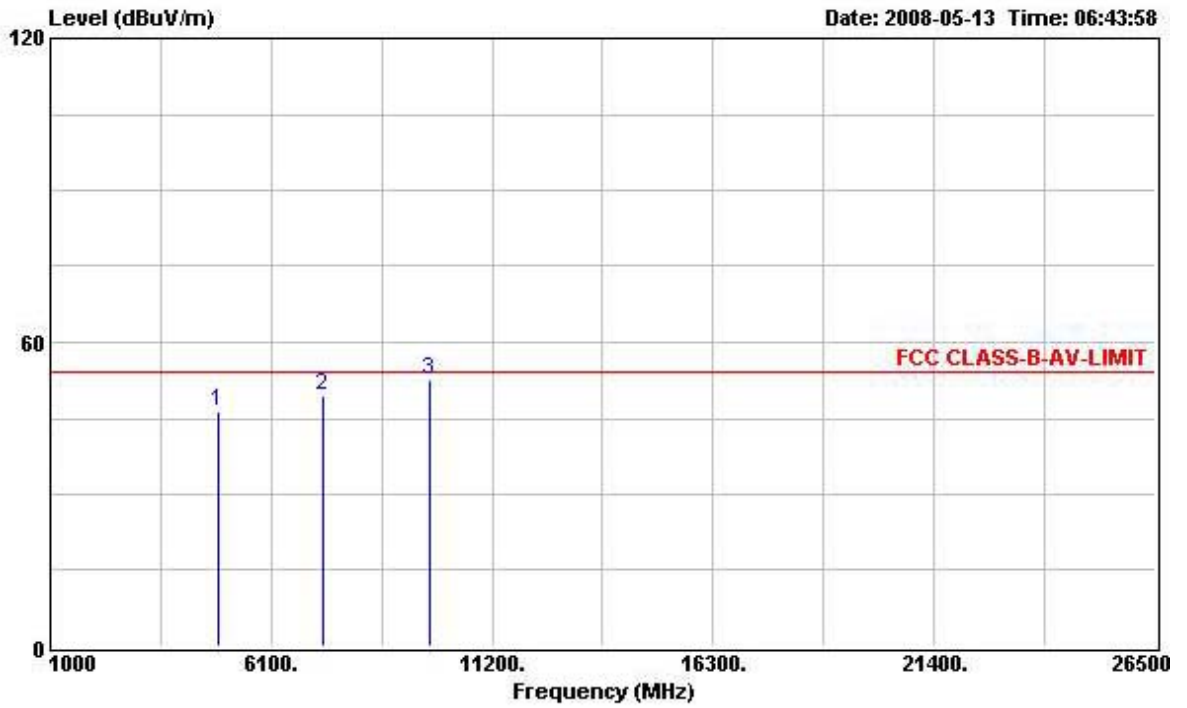

|   | Freq     | Level  | Over Limit | Limit Line | Read Level | Probe Factor | Cable Loss | Preamp Factor | Remark | Ant Pos | Table Pos |
|---|----------|--------|------------|------------|------------|--------------|------------|---------------|--------|---------|-----------|
|   | MHz      | dBUV/m | dB         | dBUV/m     | dBuV       | dB           | dB         | dB            |        | cm      | deg       |
| 1 | 4874.000 | 46.23  | -7.77      | 54.00      | 43.41      | 33.11        | 4.64       | 34.93         | Peak   | ---     | ---       |
| 2 | 7307.000 | 49.51  | -4.49      | 54.00      | 42.92      | 36.21        | 5.64       | 35.26         | Peak   | ---     | ---       |
| 3 | 9748.000 | 52.49  | -1.51      | 54.00      | 43.83      | 38.00        | 6.36       | 35.70         | Peak   | ---     | ---       |

Vertical

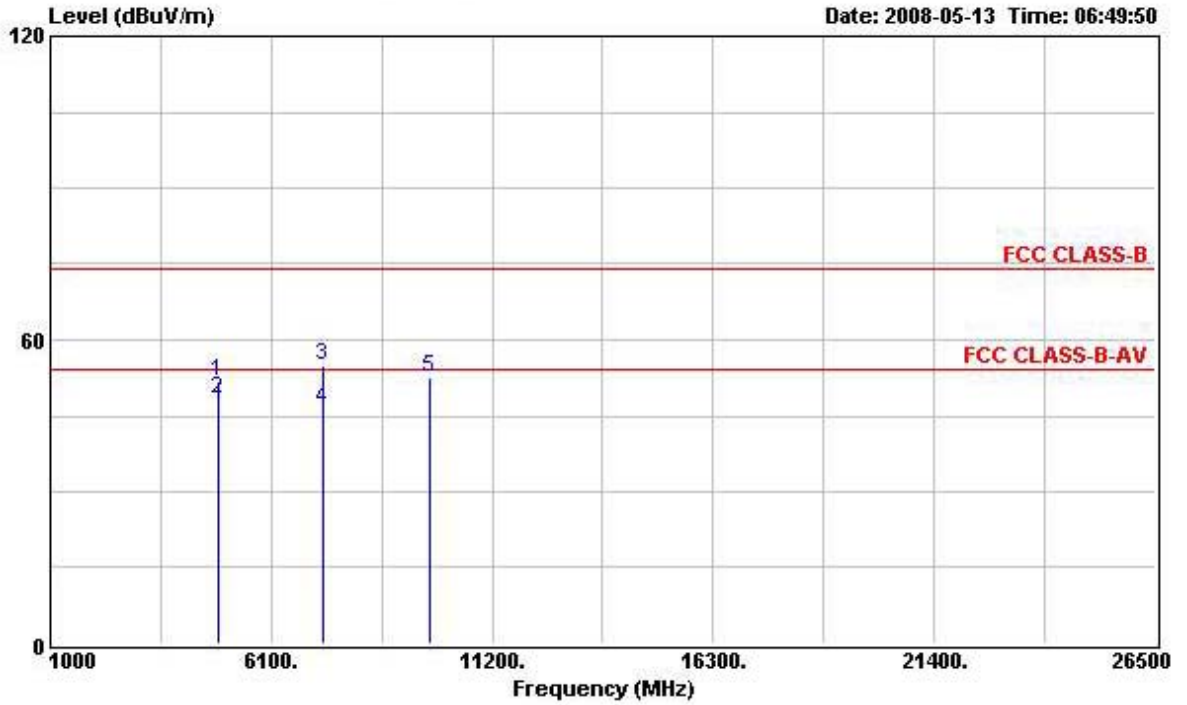

|   | Freq     | Level  | Over Limit | Limit Line | Read Level | Probe Factor | Cable Loss | Preamp Factor | Remark  | Ant Pos | Table Pos |
|---|----------|--------|------------|------------|------------|--------------|------------|---------------|---------|---------|-----------|
|   | MHz      | dBuV/m | dB         | dBuV/m     | dBuV       | dB           | dB         | dB            |         | cm      | deg       |
| 1 | 4876.000 | 51.67  | -22.33     | 74.00      | 48.85      | 33.11        | 4.64       | 34.93         | Peak    | ---     | ---       |
| 2 | 4876.000 | 48.17  | -5.83      | 54.00      | 45.35      | 33.11        | 4.64       | 34.93         | Average | ---     | ---       |
| 3 | 7312.000 | 55.03  | -18.97     | 74.00      | 48.44      | 36.21        | 5.64       | 35.26         | Peak    | ---     | ---       |
| 4 | 7312.000 | 46.21  | -7.79      | 54.00      | 39.62      | 36.21        | 5.64       | 35.26         | Average | ---     | ---       |
| 5 | 9752.000 | 52.64  | -1.36      | 54.00      | 43.98      | 38.00        | 6.36       | 35.70         | Peak    | ---     | ---       |

|               |              |                |                              |
|---------------|--------------|----------------|------------------------------|
| Test Date     | May 13, 2008 | Test Site No.  | 03CH02-HY                    |
| Temperature   | 27           | Humidity       | 58%                          |
| Test Engineer | Murphy       | Configurations | 802.11b CH 11 (Scenarios. A) |

Horizontal

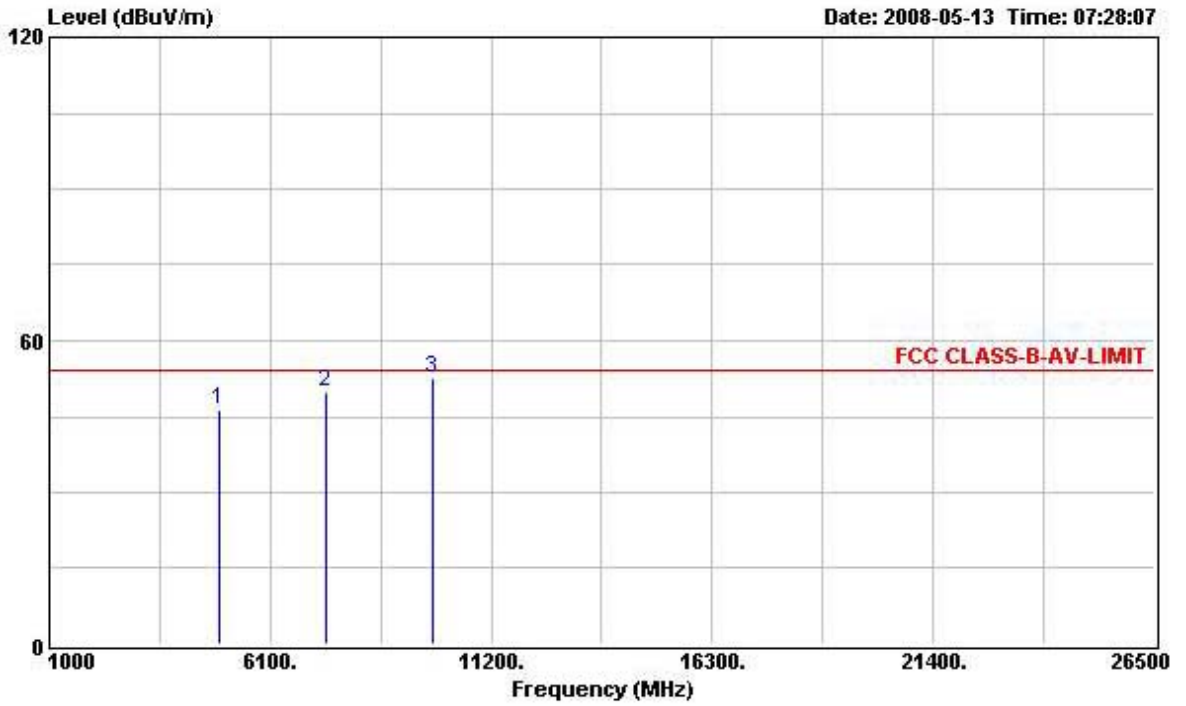

|   | Freq     | Level  | Over Limit | Limit Line | Read Level | Probe Factor | Cable Loss | Preamp Factor | Remark | Ant Pos | Table Pos |
|---|----------|--------|------------|------------|------------|--------------|------------|---------------|--------|---------|-----------|
|   | MHz      | dBuV/m | dB         | dBuV/m     | dBuV       | dB           | dB         | dB            |        | cm      | deg       |
| 1 | 4924.000 | 46.47  | -7.53      | 54.00      | 43.53      | 33.19        | 4.67       | 34.92         | Peak   | ---     | ---       |
| 2 | 7386.000 | 50.01  | -3.99      | 54.00      | 43.21      | 36.43        | 5.65       | 35.28         | Peak   | ---     | ---       |
| 3 | 9848.000 | 52.46  | -1.54      | 54.00      | 43.74      | 38.04        | 6.38       | 35.70         | Peak   | ---     | ---       |

Vertical

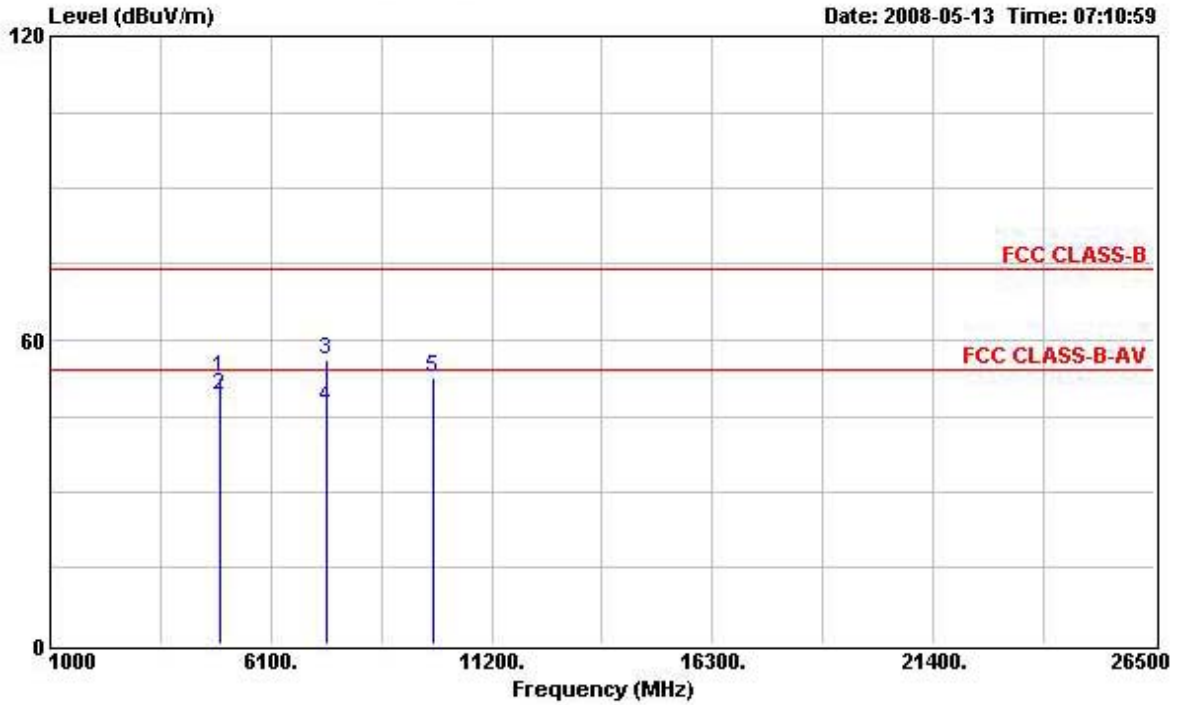

|   | Freq     | Level  | Over Limit | Limit Line | Read Level | Probe Factor | Cable Loss | Preamp Factor | Remark  | Ant Pos | Table Pos |
|---|----------|--------|------------|------------|------------|--------------|------------|---------------|---------|---------|-----------|
|   | MHz      | dBUV/m | dB         | dBUV/m     | dBuV       | dB           | dB         | dB            |         | cm      | deg       |
| 1 | 4924.000 | 52.57  | -21.43     | 74.00      | 49.63      | 33.19        | 4.67       | 34.92         | Peak    | ---     | ---       |
| 2 | 4924.000 | 49.07  | -4.93      | 54.00      | 46.13      | 33.19        | 4.67       | 34.92         | Average | ---     | ---       |
| 3 | 7384.000 | 56.08  | -17.92     | 74.00      | 49.28      | 36.43        | 5.65       | 35.28         | Peak    | ---     | ---       |
| 4 | 7384.000 | 46.78  | -7.22      | 54.00      | 39.98      | 36.43        | 5.65       | 35.28         | Average | ---     | ---       |
| 5 | 9848.000 | 52.77  | -1.23      | 54.00      | 44.05      | 38.04        | 6.38       | 35.70         | Peak    | ---     | ---       |

|               |              |                |                             |
|---------------|--------------|----------------|-----------------------------|
| Test Date     | May 13, 2008 | Test Site No.  | 03CH02-HY                   |
| Temperature   | 27           | Humidity       | 58%                         |
| Test Engineer | Murphy       | Configurations | 802.11g CH 1 (Scenarios. A) |

Horizontal

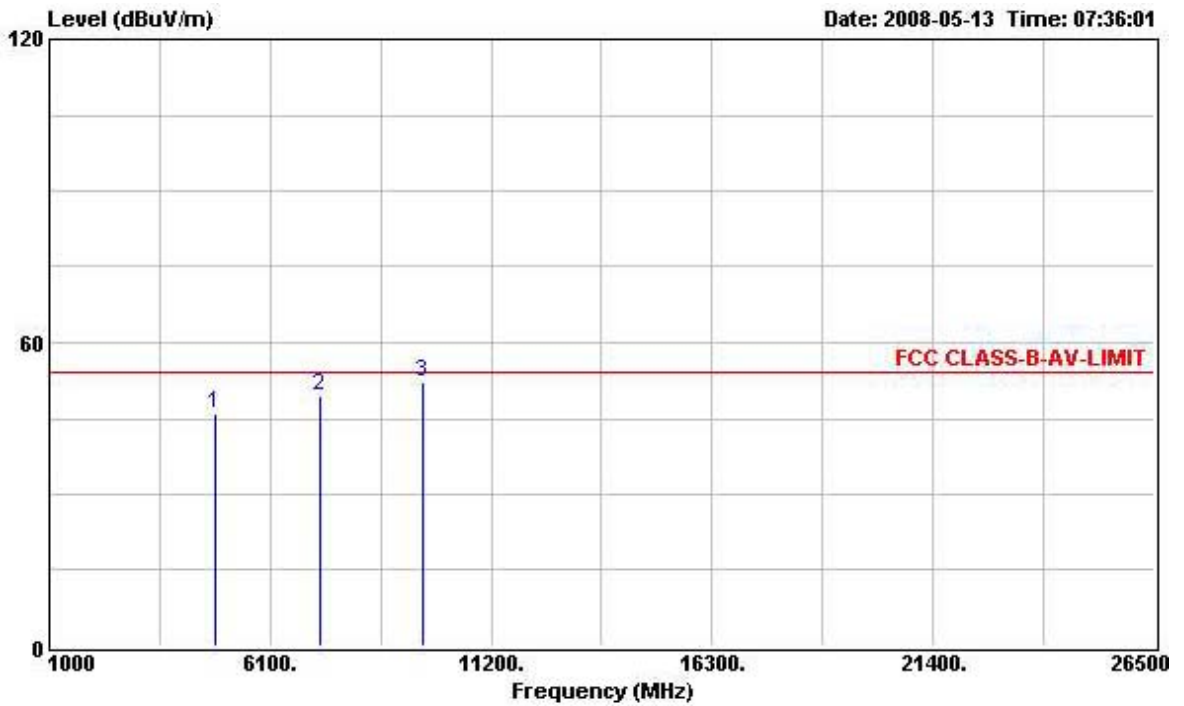

|   | Freq     | Level  | Over Limit | Limit Line | Read Level | Probe Factor | Cable Loss | Preamp Factor | Remark | Ant Pos | Table Pos |
|---|----------|--------|------------|------------|------------|--------------|------------|---------------|--------|---------|-----------|
|   | MHz      | dBUV/m | dB         | dBUV/m     | dBuV       | dB           | dB         | dB            |        | cm      | deg       |
| 1 | 4824.000 | 46.03  | -7.97      | 54.00      | 43.36      | 33.02        | 4.59       | 34.94         | Peak   | ---     | ---       |
| 2 | 7232.000 | 49.43  | -4.57      | 54.00      | 43.01      | 36.03        | 5.63       | 35.24         | Peak   | ---     | ---       |
| 3 | 9644.000 | 52.39  | -1.61      | 54.00      | 43.79      | 37.96        | 6.34       | 35.70         | Peak   | ---     | ---       |

Vertical

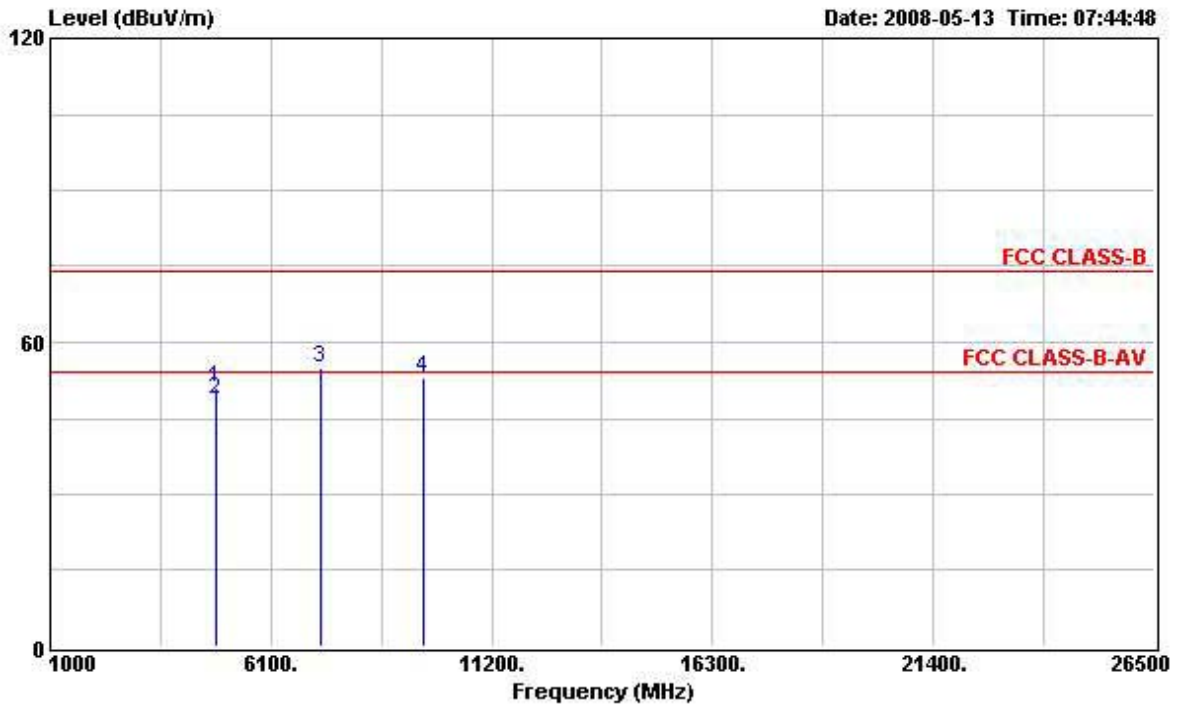

|   | Freq     | Level  | Over Limit | Limit Line | Read Level | Probe Factor | Cable Loss | Preamp Factor | Remark  | Ant Pos | Table Pos |
|---|----------|--------|------------|------------|------------|--------------|------------|---------------|---------|---------|-----------|
|   | MHz      | dBuV/m | dB         | dBuV/m     | dBuV       | dB           | dB         | dB            |         | cm      | deg       |
| 1 | 4824.000 | 51.22  | -22.78     | 74.00      | 48.55      | 33.02        | 4.59       | 34.94         | Peak    | ---     | ---       |
| 2 | 4824.000 | 48.76  | -5.24      | 54.00      | 46.09      | 33.02        | 4.59       | 34.94         | Average | ---     | ---       |
| 3 | 7240.000 | 54.81  |            |            | 48.40      | 36.03        | 5.63       | 35.25         | Peak    | ---     | ---       |
| 4 | 9644.000 | 52.81  | -1.19      | 54.00      | 44.21      | 37.96        | 6.34       | 35.70         | Peak    | ---     | ---       |

Note: Item 3 is on un-restricted band, so the limit is -20dBc for the field strength of the fundamental emissions(see section 3.6.7).

|               |              |                |                             |
|---------------|--------------|----------------|-----------------------------|
| Test Date     | May 13, 2008 | Test Site No.  | 03CH02-HY                   |
| Temperature   | 27           | Humidity       | 58%                         |
| Test Engineer | Murphy       | Configurations | 802.11g CH 6 (Scenarios. A) |

Horizontal

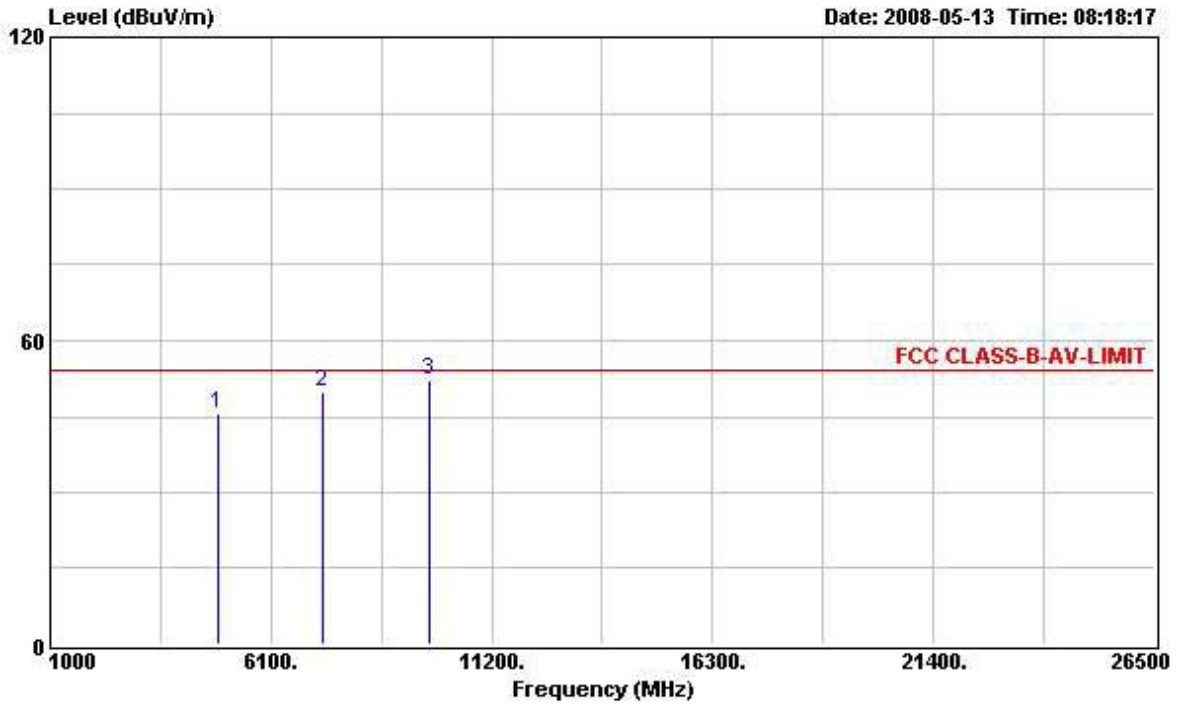

|   | Freq     | Level  | Over Limit | Limit Line | Read Level | Probe Factor | Cable Loss | Preamp Factor | Remark | Ant Pos | Table Pos |
|---|----------|--------|------------|------------|------------|--------------|------------|---------------|--------|---------|-----------|
|   | MHz      | dBuV/m | dB         | dBuV/m     | dBuV       | dB           | dB         | dB            |        | cm      | deg       |
| 1 | 4870.000 | 45.56  | -8.44      | 54.00      | 42.76      | 33.11        | 4.62       | 34.93         | Peak   | ---     | ---       |
| 2 | 7311.000 | 49.76  | -4.24      | 54.00      | 43.17      | 36.21        | 5.64       | 35.26         | Peak   | ---     | ---       |
| 3 | 9748.000 | 52.23  | -1.77      | 54.00      | 43.57      | 38.00        | 6.36       | 35.70         | Peak   | ---     | ---       |



Vertical

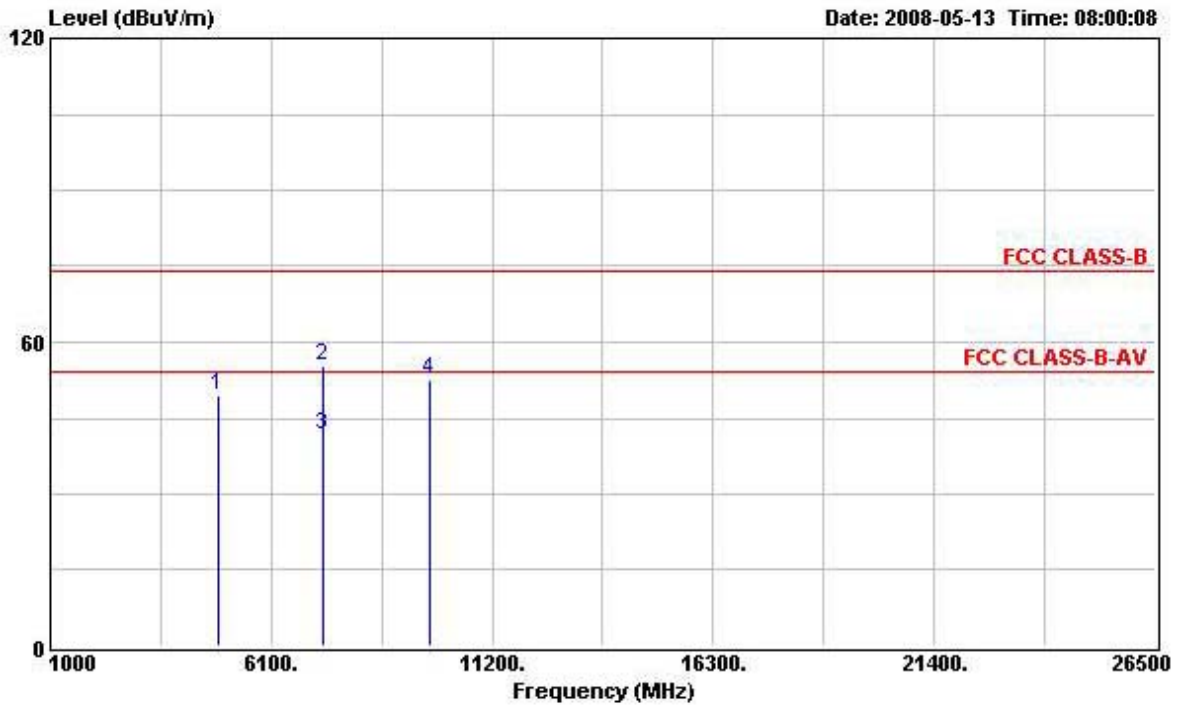

|   | Freq     | Level  | Over Limit | Limit Line | Read Level | Probe Factor | Cable Loss | Preamp Factor | Remark  | Ant Pos | Table Pos |
|---|----------|--------|------------|------------|------------|--------------|------------|---------------|---------|---------|-----------|
|   | MHz      | dBuV/m | dB         | dBuV/m     | dBuV       | dB           | dB         | dB            |         | cm      | deg       |
| 1 | 4876.000 | 49.61  | -4.39      | 54.00      | 46.79      | 33.11        | 4.64       | 34.93         | Peak    | ---     | ---       |
| 2 | 7316.000 | 55.51  | -18.49     | 74.00      | 48.88      | 36.25        | 5.64       | 35.26         | Peak    | ---     | ---       |
| 3 | 7316.000 | 41.76  | -12.24     | 54.00      | 35.13      | 36.25        | 5.64       | 35.26         | Average | ---     | ---       |
| 4 | 9752.000 | 52.47  | -1.53      | 54.00      | 43.81      | 38.00        | 6.36       | 35.70         | Peak    | ---     | ---       |

|               |              |                |                              |
|---------------|--------------|----------------|------------------------------|
| Test Date     | May 13, 2008 | Test Site No.  | 03CH02-HY                    |
| Temperature   | 27           | Humidity       | 58%                          |
| Test Engineer | Murphy       | Configurations | 802.11g CH 11 (Scenarios. A) |

Horizontal

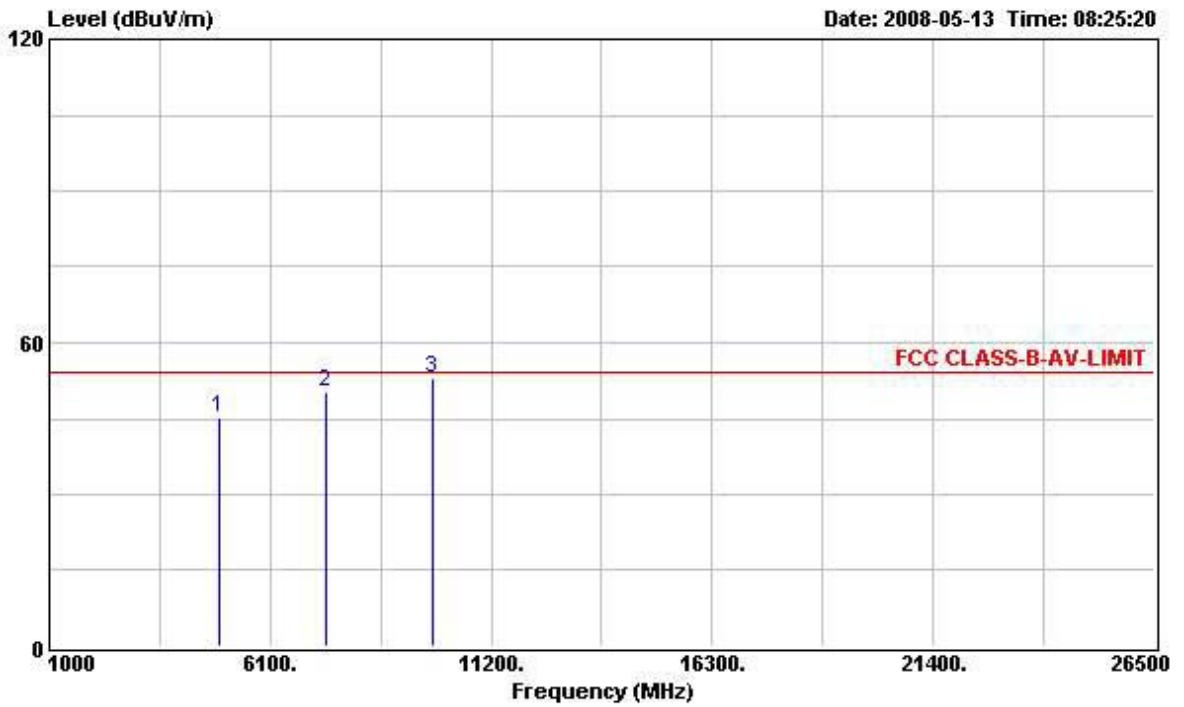

|   | Freq     | Level  | Over Limit | Limit Line | Read Level | Probe Factor | Cable Loss | Preamp Factor | Remark | Ant Pos | Table Pos |
|---|----------|--------|------------|------------|------------|--------------|------------|---------------|--------|---------|-----------|
|   | MHz      | dBuV/m | dB         | dBuV/m     | dBuV       | dB           | dB         | dB            |        | cm      | deg       |
| 1 | 4920.000 | 45.32  | -8.68      | 54.00      | 42.38      | 33.19        | 4.67       | 34.92         | Peak   | ---     | ---       |
| 2 | 7382.000 | 50.37  | -3.63      | 54.00      | 43.61      | 36.39        | 5.65       | 35.28         | Peak   | ---     | ---       |
| 3 | 9848.000 | 52.90  | -1.10      | 54.00      | 44.18      | 38.04        | 6.38       | 35.70         | Peak   | ---     | ---       |

Vertical

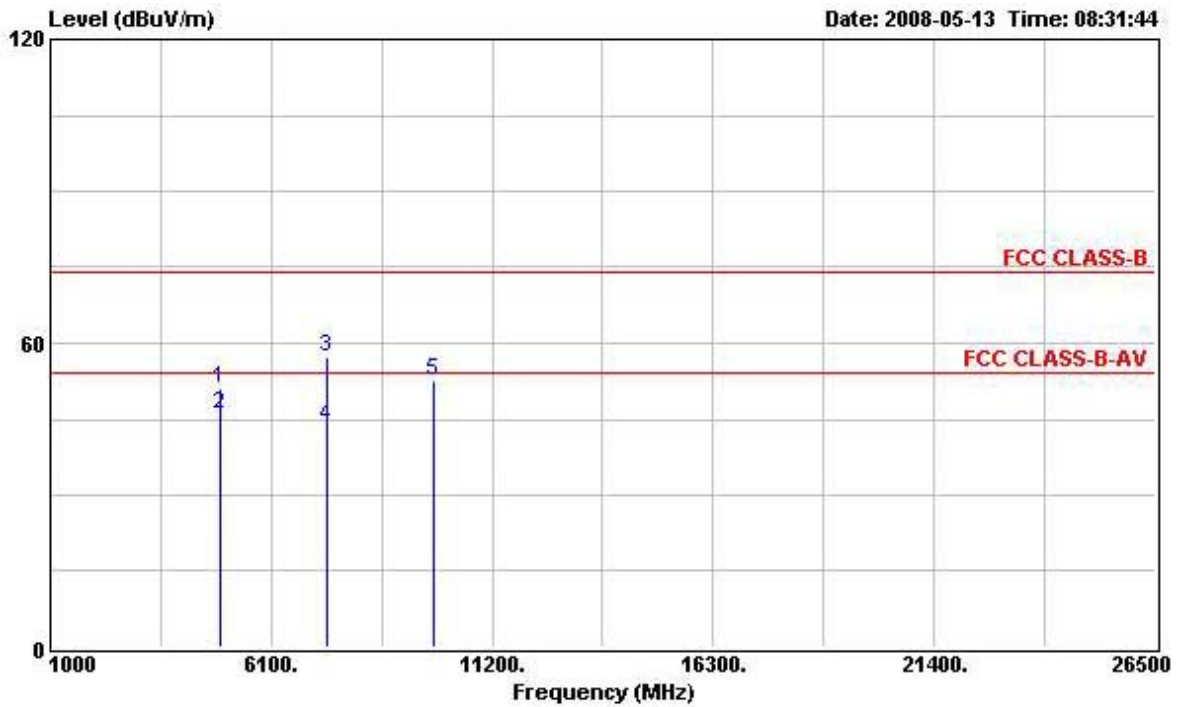

|   | Freq     | Level  | Over Limit | Limit Line | Read Level | Probe Factor | Cable Loss | Preamp Factor | Remark  | Ant Pos | Table Pos |
|---|----------|--------|------------|------------|------------|--------------|------------|---------------|---------|---------|-----------|
|   | MHz      | dBuV/m | dB         | dBuV/m     | dBuV       | dB           | dB         | dB            |         | cm      | deg       |
| 1 | 4924.000 | 51.12  | -22.88     | 74.00      | 48.18      | 33.19        | 4.67       | 34.92         | Peak    | ---     | ---       |
| 2 | 4924.000 | 45.93  | -8.07      | 54.00      | 42.99      | 33.19        | 4.67       | 34.92         | Average | ---     | ---       |
| 3 | 7388.000 | 57.47  | -16.53     | 74.00      | 50.67      | 36.43        | 5.65       | 35.28         | Peak    | ---     | ---       |
| 4 | 7388.000 | 43.66  | -10.34     | 54.00      | 36.86      | 36.43        | 5.65       | 35.28         | Average | ---     | ---       |
| 5 | 9852.000 | 52.66  | -1.34      | 54.00      | 43.94      | 38.04        | 6.38       | 35.70         | Peak    | ---     | ---       |

Note:

The amplitude of spurious emissions that are attenuated by more than 20dB below the permissible value has no need to be reported.

Emission level (dBuV/m) = 20 log Emission level (uV/m).

Corrected Reading: Antenna Factor + Cable Loss + Read Level - Preamp Factor = Level.

|               |              |                |                             |
|---------------|--------------|----------------|-----------------------------|
| Test Date     | May 13, 2008 | Test Site No.  | 03CH02-HY                   |
| Temperature   | 27           | Humidity       | 58%                         |
| Test Engineer | Murphy       | Configurations | 802.11b CH 1 (Scenarios. B) |

Horizontal

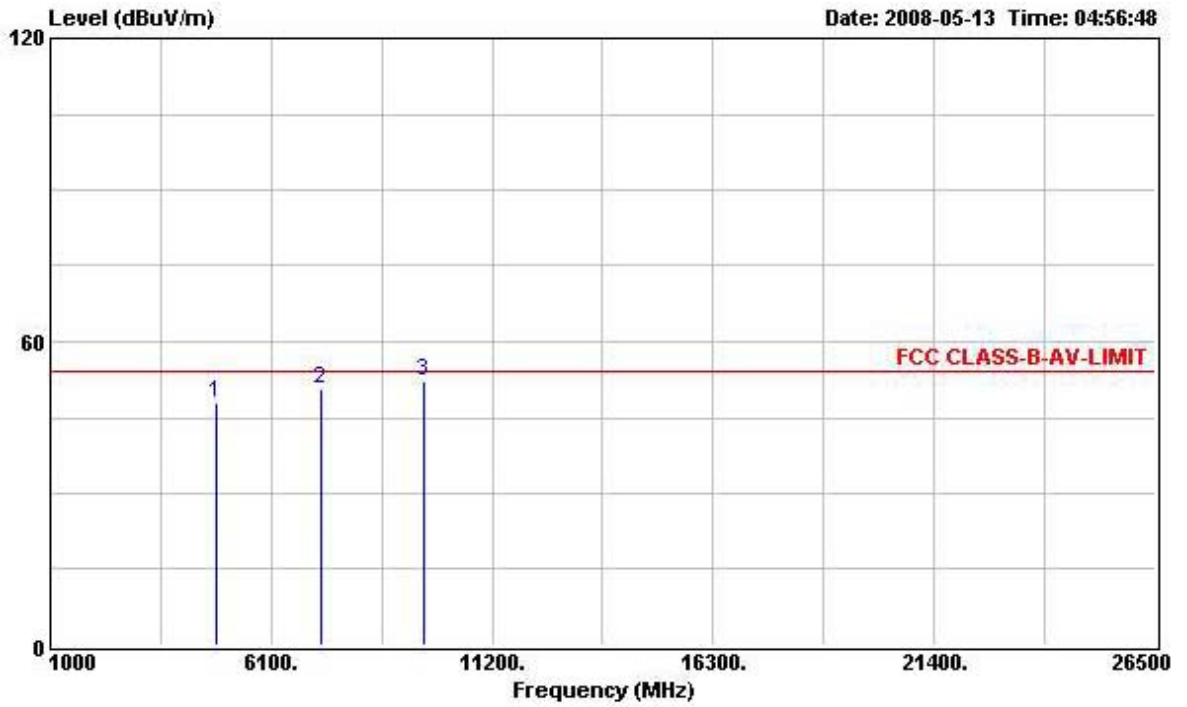

|   | Freq     | Level  | Over Limit | Limit Line | Read Level | Probe Factor | Cable Loss | Preamp Factor | Remark | Ant Pos | Table Pos |
|---|----------|--------|------------|------------|------------|--------------|------------|---------------|--------|---------|-----------|
|   | MHz      | dBuV/m | dB         | dBuV/m     | dBuV       | dB           | dB         | dB            |        | cm      | deg       |
| 1 | 4824.000 | 47.86  | -6.14      | 54.00      | 45.19      | 33.02        | 4.59       | 34.94         | Peak   | ---     | ---       |
| 2 | 7232.000 | 50.55  | -3.45      | 54.00      | 44.13      | 36.03        | 5.63       | 35.24         | Peak   | ---     | ---       |
| 3 | 9644.000 | 52.04  | -1.96      | 54.00      | 43.44      | 37.96        | 6.34       | 35.70         | Peak   | ---     | ---       |

Vertical

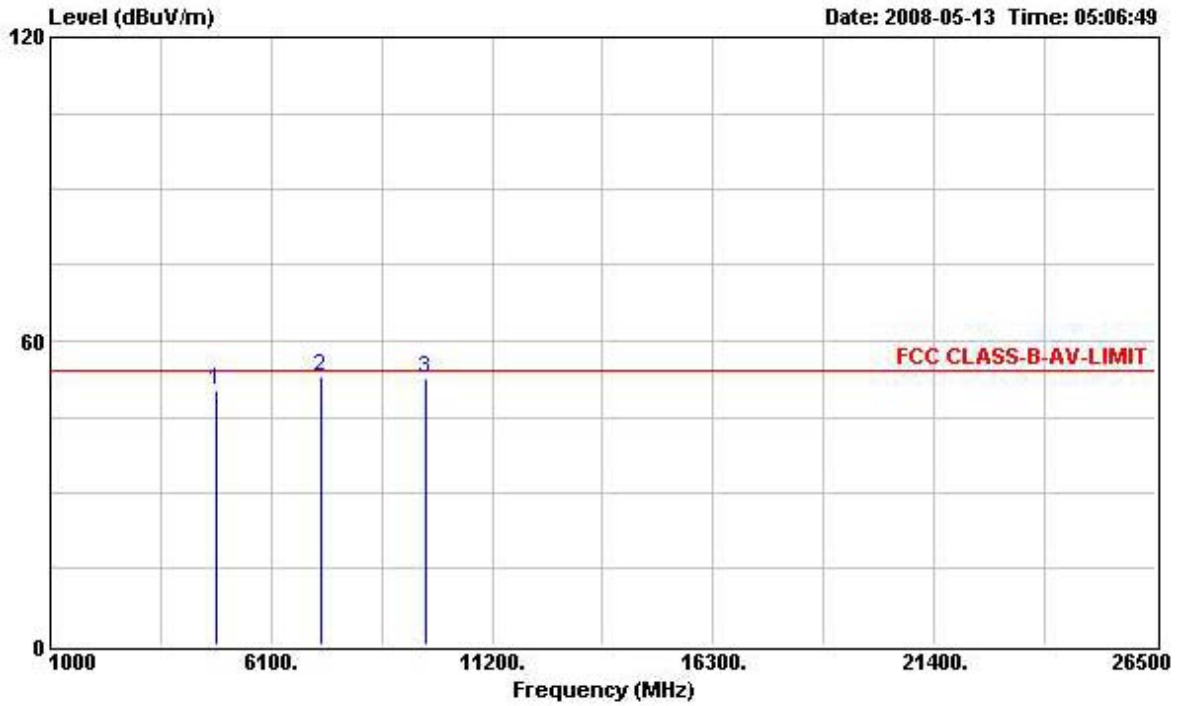

|   | Freq     | Level  | Over Limit | Limit Line | Read Level | Probe Factor | Cable Loss | Preamp Factor | Remark | Ant Pos | Table Pos |
|---|----------|--------|------------|------------|------------|--------------|------------|---------------|--------|---------|-----------|
|   | MHz      | dBuV/m | dB         | dBuV/m     | dBuV       | dB           | dB         | dB            |        | cm      | deg       |
| 1 | 4824.000 | 50.21  | -3.79      | 54.00      | 47.54      | 33.02        | 4.59       | 34.94         | Peak   | ---     | ---       |
| 2 | 7232.000 | 52.89  | -1.11      | 54.00      | 46.47      | 36.03        | 5.63       | 35.24         | Peak   | ---     | ---       |
| 3 | 9648.000 | 52.71  | -1.29      | 54.00      | 44.11      | 37.96        | 6.34       | 35.70         | Peak   | ---     | ---       |

|               |              |                |                             |
|---------------|--------------|----------------|-----------------------------|
| Test Date     | May 13, 2008 | Test Site No.  | 03CH02-HY                   |
| Temperature   | 27           | Humidity       | 58%                         |
| Test Engineer | Murphy       | Configurations | 802.11b CH 6 (Scenarios. B) |

Horizontal

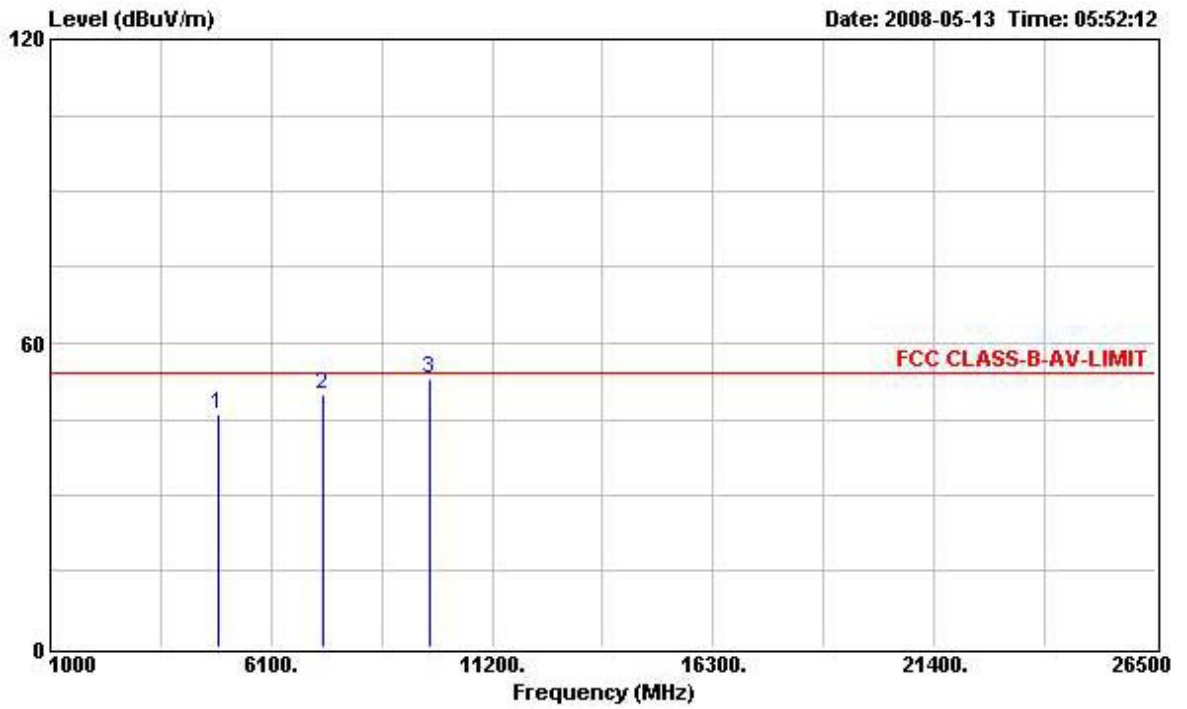

|   | Freq     | Level  | Over Limit | Limit Line | Read Level | Probe Factor | Cable Loss | Preamp Factor | Remark | Ant Pos | Table Pos |
|---|----------|--------|------------|------------|------------|--------------|------------|---------------|--------|---------|-----------|
|   | MHz      | dBuV/m | dB         | dBuV/m     | dBuV       | dB           | dB         | dB            |        | cm      | deg       |
| 1 | 4870.000 | 45.92  | -8.08      | 54.00      | 43.12      | 33.11        | 4.62       | 34.93         | Peak   | ---     | ---       |
| 2 | 7311.000 | 49.76  | -4.24      | 54.00      | 43.17      | 36.21        | 5.64       | 35.26         | Peak   | ---     | ---       |
| 3 | 9744.000 | 52.80  | -1.20      | 54.00      | 44.14      | 38.00        | 6.36       | 35.70         | Peak   | ---     | ---       |

Vertical

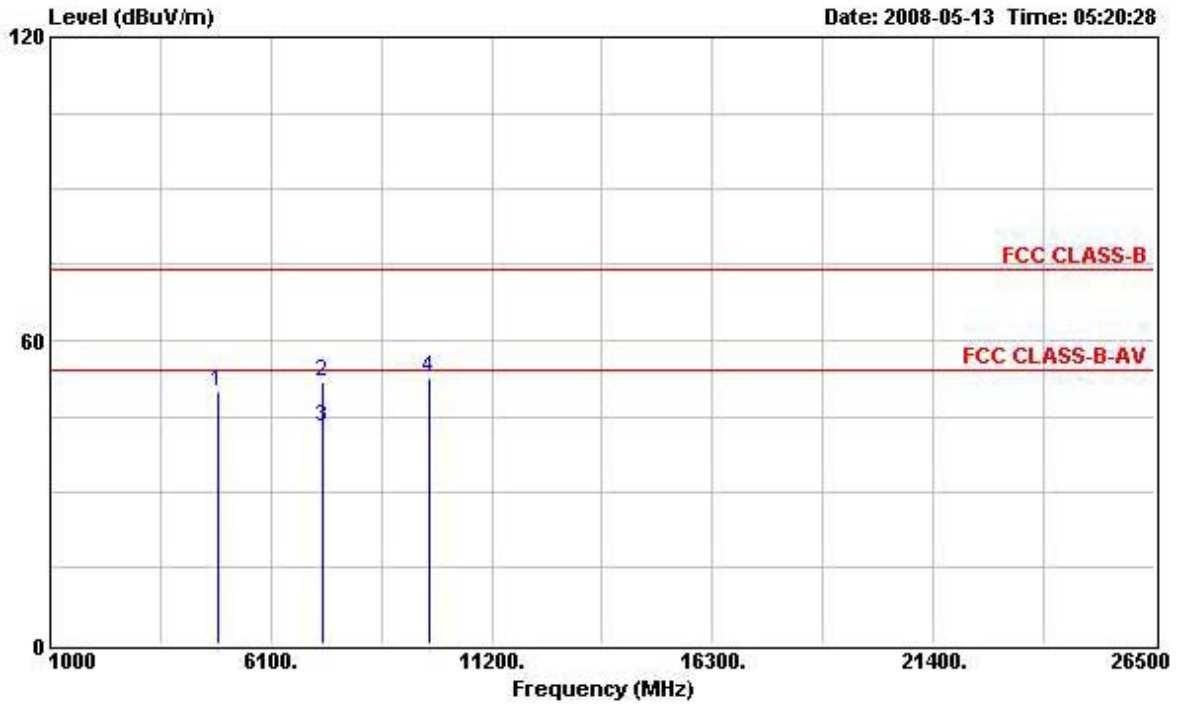

|   | Freq     | Level  | Over Limit | Limit Line | Read Level | Probe Factor | Cable Loss | Preamp Factor | Remark  | Ant Pos | Table Pos |
|---|----------|--------|------------|------------|------------|--------------|------------|---------------|---------|---------|-----------|
|   | MHz      | dBuV/m | dB         | dBuV/m     | dBuV       | dB           | dB         | dB            |         | cm      | deg       |
| 1 | 4876.000 | 49.89  | -4.11      | 54.00      | 47.07      | 33.11        | 4.64       | 34.93         | Peak    | ---     | ---       |
| 2 | 7308.000 | 51.96  | -22.04     | 74.00      | 45.37      | 36.21        | 5.64       | 35.26         | Peak    | ---     | ---       |
| 3 | 7308.000 | 42.86  | -11.14     | 54.00      | 36.27      | 36.21        | 5.64       | 35.26         | Average | ---     | ---       |
| 4 | 9748.000 | 52.49  | -1.51      | 54.00      | 43.83      | 38.00        | 6.36       | 35.70         | Peak    | ---     | ---       |

|               |              |                |                              |
|---------------|--------------|----------------|------------------------------|
| Test Date     | May 13, 2008 | Test Site No.  | 03CH02-HY                    |
| Temperature   | 27           | Humidity       | 58%                          |
| Test Engineer | Murphy       | Configurations | 802.11b CH 11 (Scenarios. B) |

Horizontal

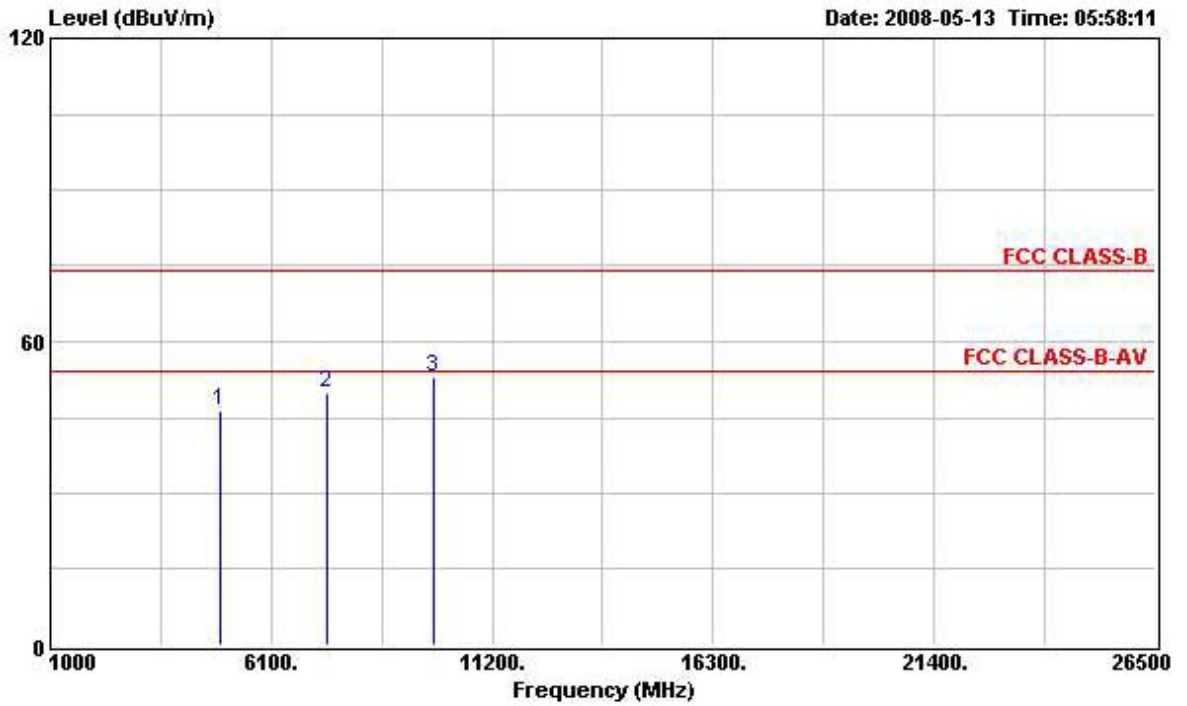

|   | Freq     | Level  | Over Limit | Limit Line | Read Level | Probe Factor | Cable Loss | Preamp Factor | Remark | Ant Pos | Table Pos |
|---|----------|--------|------------|------------|------------|--------------|------------|---------------|--------|---------|-----------|
|   | MHz      | dBuV/m | dB         | dBuV/m     | dBuV       | dB           | dB         | dB            |        | cm      | deg       |
| 1 | 4928.000 | 46.25  | -7.75      | 54.00      | 43.31      | 33.19        | 4.67       | 34.92         | Peak   | ---     | ---       |
| 2 | 7386.000 | 49.86  | -4.14      | 54.00      | 43.06      | 36.43        | 5.65       | 35.28         | Peak   | ---     | ---       |
| 3 | 9852.000 | 53.02  |            |            | 44.30      | 38.04        | 6.38       | 35.70         | Peak   | ---     | ---       |

Note: Item 3 is on un-restricted band, so the limit is -20dBc for the field strength of the fundamental emissions(see section 3.6.7).



Vertical

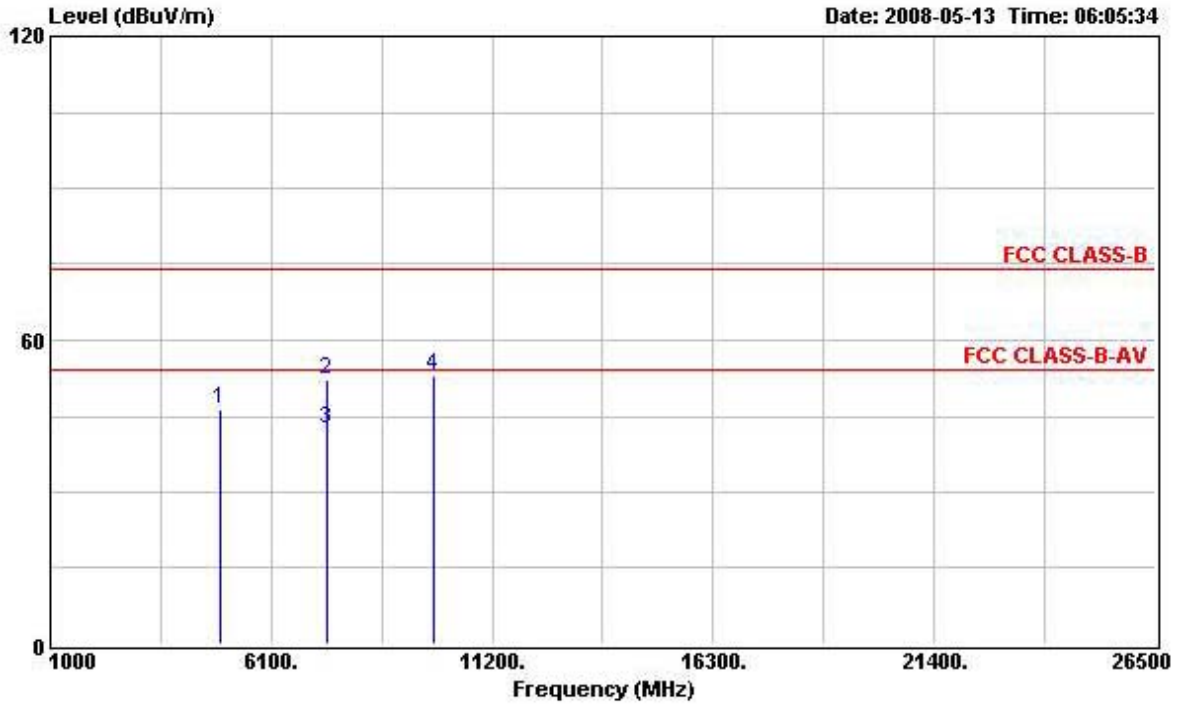

|   | Freq     | Level  | Over Limit | Limit Line | Read Level | Probe Factor | Cable Loss | Preamp Factor | Remark  | Ant Pos | Table Pos |
|---|----------|--------|------------|------------|------------|--------------|------------|---------------|---------|---------|-----------|
|   | MHz      | dBuV/m | dB         | dBuV/m     | dBuV       | dB           | dB         | dB            |         | cm      | deg       |
| 1 | 4924.000 | 46.36  | -7.64      | 54.00      | 43.42      | 33.19        | 4.67       | 34.92         | Peak    | ---     | ---       |
| 2 | 7380.000 | 52.24  | -21.76     | 74.00      | 45.48      | 36.39        | 5.65       | 35.28         | Peak    | ---     | ---       |
| 3 | 7380.000 | 42.63  | -11.37     | 54.00      | 35.87      | 36.39        | 5.65       | 35.28         | Average | ---     | ---       |
| 4 | 9848.000 | 53.09  |            |            | 44.37      | 38.04        | 6.38       | 35.70         | Peak    | ---     | ---       |

Note: Item 4 is on un-restricted band, so the limit is -20dBc for the field strength of the fundamental emissions(see section 3.6.7).

|               |              |                |                             |
|---------------|--------------|----------------|-----------------------------|
| Test Date     | May 13, 2008 | Test Site No.  | 03CH02-HY                   |
| Temperature   | 27           | Humidity       | 58%                         |
| Test Engineer | Murphy       | Configurations | 802.11g CH 1 (Scenarios. B) |

Horizontal

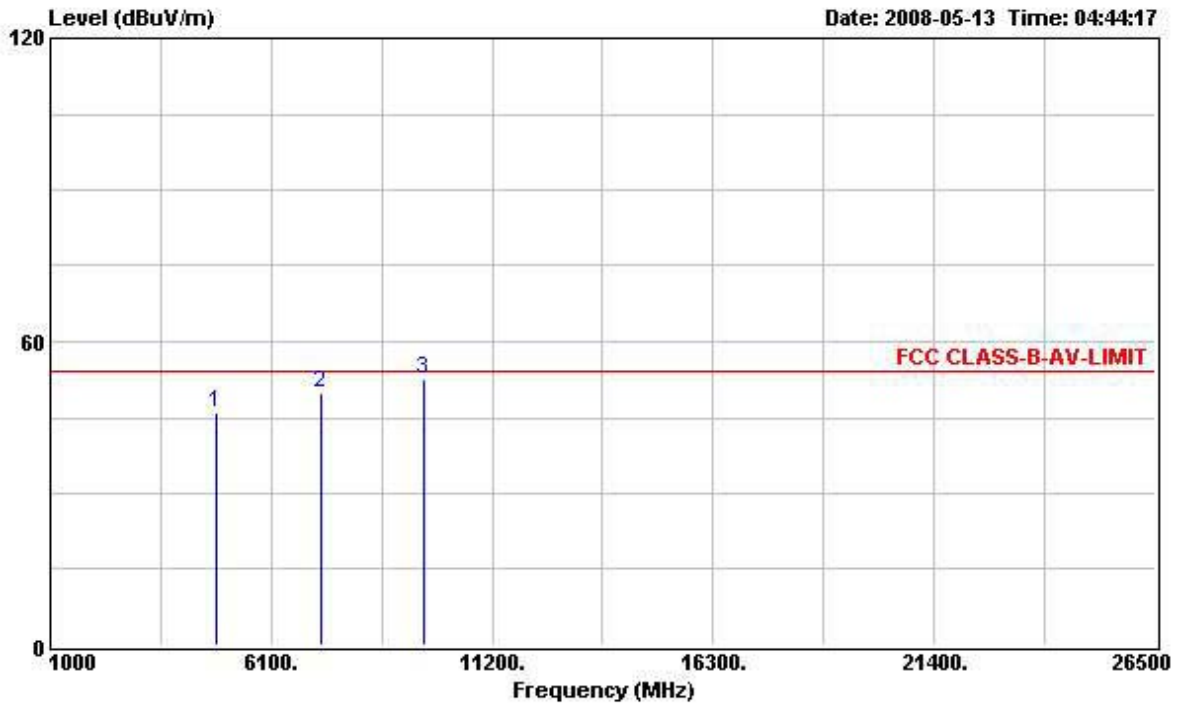

|   | Freq     | Level  | Over Limit | Limit Line | Read Level | Probe Factor | Cable Loss | Preamp Factor | Remark | Ant Pos | Table Pos |
|---|----------|--------|------------|------------|------------|--------------|------------|---------------|--------|---------|-----------|
|   | MHz      | dBuV/m | dB         | dBuV/m     | dBuV       | dB           | dB         | dB            |        | cm      | deg       |
| 1 | 4824.000 | 46.03  | -7.97      | 54.00      | 43.36      | 33.02        | 4.59       | 34.94         | Peak   | ---     | ---       |
| 2 | 7236.000 | 49.82  | -4.18      | 54.00      | 43.41      | 36.03        | 5.63       | 35.25         | Peak   | ---     | ---       |
| 3 | 9644.000 | 52.60  | -1.40      | 54.00      | 44.00      | 37.96        | 6.34       | 35.70         | Peak   | ---     | ---       |

Vertical

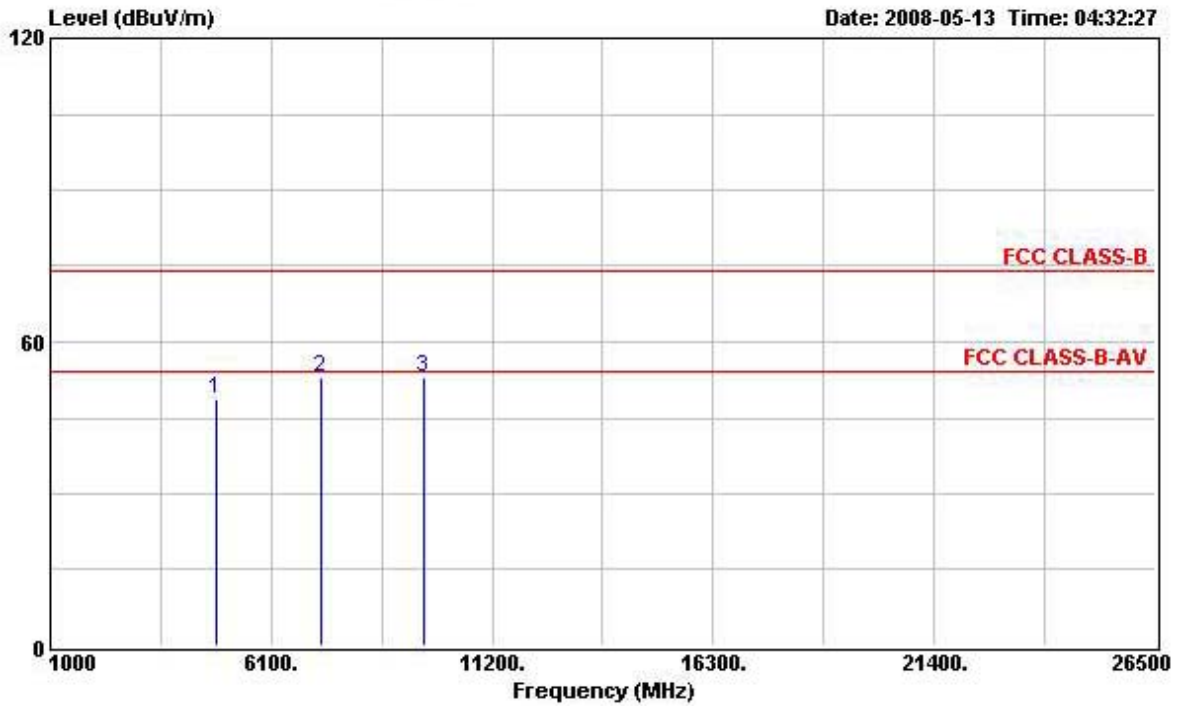

|   | Freq     | Level  | Over Limit | Limit Line | Read Level | Probe Factor | Cable Loss | Preamp Factor | Remark | Ant Pos | Table Pos |
|---|----------|--------|------------|------------|------------|--------------|------------|---------------|--------|---------|-----------|
|   | MHz      | dBuV/m | dB         | dBuV/m     | dBuV       | dB           | dB         | dB            |        | cm      | deg       |
| 1 | 4828.000 | 48.51  | -5.49      | 54.00      | 45.84      | 33.02        | 4.59       | 34.94         | Peak   | ---     | ---       |
| 2 | 7240.000 | 53.15  |            | 54.00      | 46.74      | 36.03        | 5.63       | 35.25         | Peak   | ---     | ---       |
| 3 | 9644.000 | 52.80  | -1.20      | 54.00      | 44.20      | 37.96        | 6.34       | 35.70         | Peak   | ---     | ---       |

Note: Item 2 is on un-restricted band, so the limit is -20dBc for the field strength of the fundamental emissions(see section 3.6.7).

|               |              |                |                             |
|---------------|--------------|----------------|-----------------------------|
| Test Date     | May 13, 2008 | Test Site No.  | 03CH02-HY                   |
| Temperature   | 27           | Humidity       | 58%                         |
| Test Engineer | Murphy       | Configurations | 802.11g CH 6 (Scenarios. B) |

Horizontal

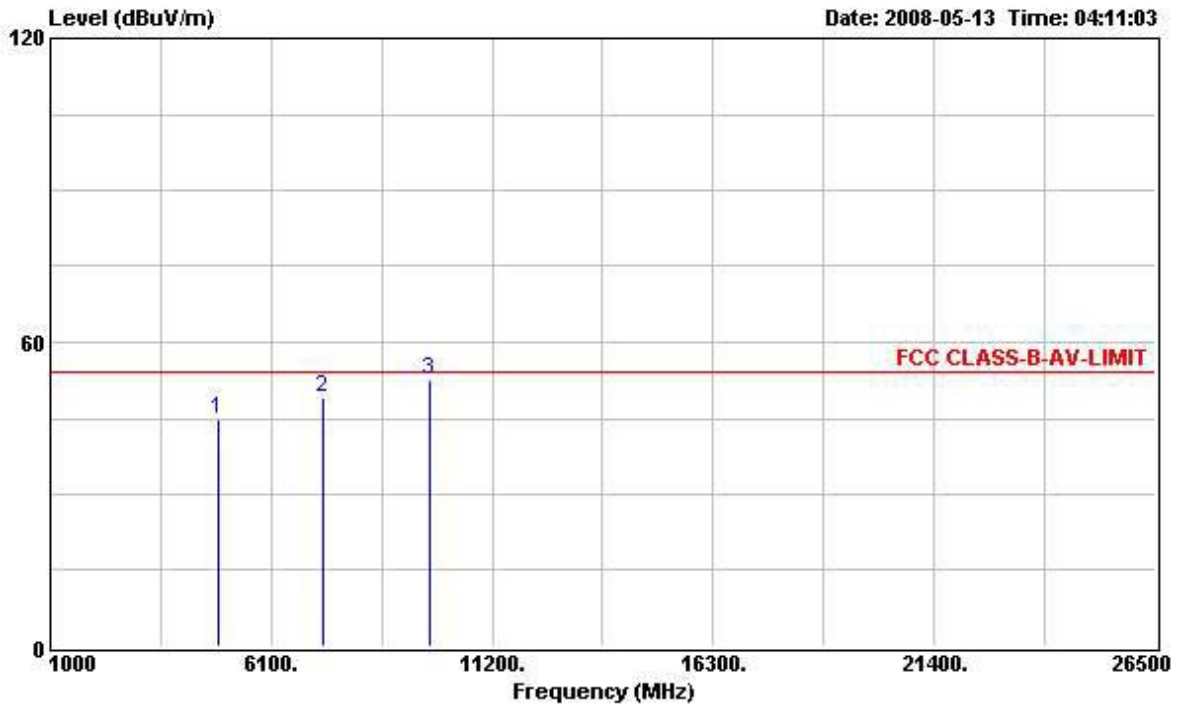

|   | Freq     | Level  | Over Limit | Limit Line | Read Level | Probe Factor | Cable Loss | Preamp Factor | Remark | Ant Pos | Table Pos |
|---|----------|--------|------------|------------|------------|--------------|------------|---------------|--------|---------|-----------|
|   | MHz      | dBuV/m | dB         | dBuV/m     | dBuV       | dB           | dB         | dB            |        | cm      | deg       |
| 1 | 4870.000 | 44.84  | -9.16      | 54.00      | 42.04      | 33.11        | 4.62       | 34.93         | Peak   | ---     | ---       |
| 2 | 7307.000 | 49.19  | -4.81      | 54.00      | 42.60      | 36.21        | 5.64       | 35.26         | Peak   | ---     | ---       |
| 3 | 9744.000 | 52.48  | -1.52      | 54.00      | 43.82      | 38.00        | 6.36       | 35.70         | Peak   | ---     | ---       |

Vertical

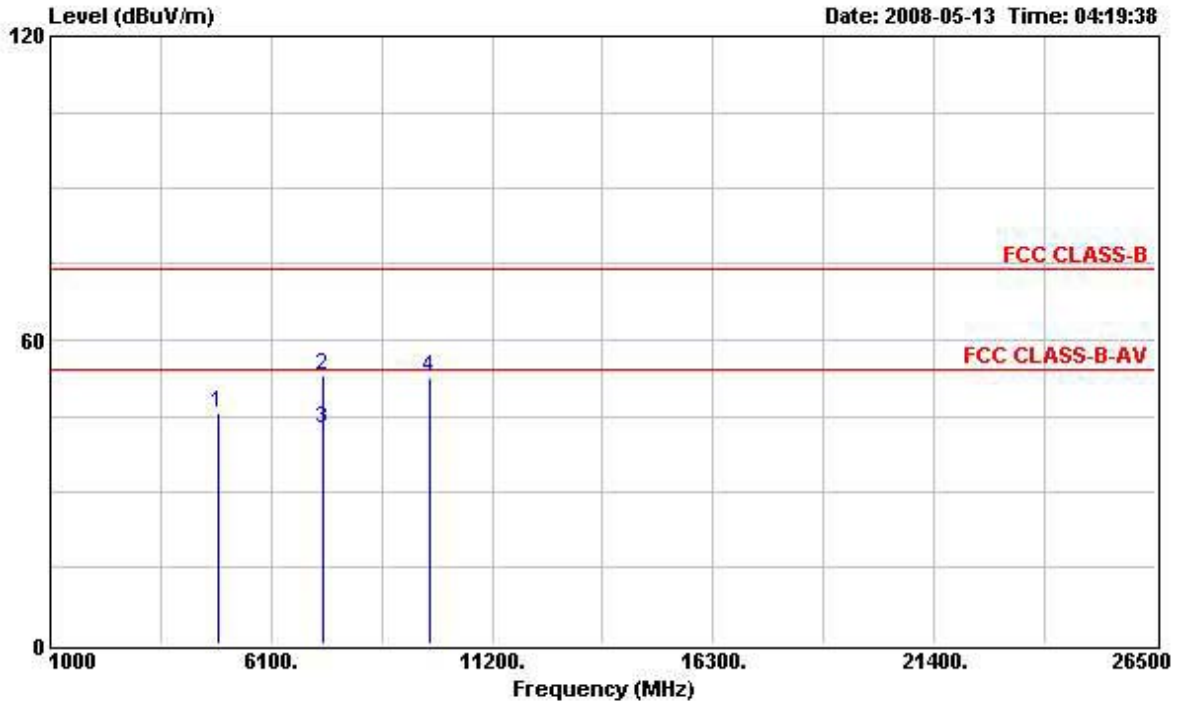

|   | Freq     | Level  | Over Limit | Limit Line | Read Level | Probe Factor | Cable Loss | Preamp Factor | Remark  | Ant Pos | Table Pos |
|---|----------|--------|------------|------------|------------|--------------|------------|---------------|---------|---------|-----------|
|   | MHz      | dBuV/m | dB         | dBuV/m     | dBuV       | dB           | dB         | dB            |         | cm      | deg       |
| 1 | 4874.000 | 45.73  | -8.27      | 54.00      | 42.91      | 33.11        | 4.64       | 34.93         | Peak    | ---     | ---       |
| 2 | 7304.000 | 53.06  | -20.94     | 74.00      | 46.47      | 36.21        | 5.64       | 35.26         | Peak    | ---     | ---       |
| 3 | 7304.000 | 42.43  | -11.57     | 54.00      | 35.84      | 36.21        | 5.64       | 35.26         | Average | ---     | ---       |
| 4 | 9744.000 | 52.67  | -1.33      | 54.00      | 44.01      | 38.00        | 6.36       | 35.70         | Peak    | ---     | ---       |

|               |              |                |                              |
|---------------|--------------|----------------|------------------------------|
| Test Date     | May 13, 2008 | Test Site No.  | 03CH02-HY                    |
| Temperature   | 27           | Humidity       | 58%                          |
| Test Engineer | Murphy       | Configurations | 802.11g CH 11 (Scenarios. B) |

Horizontal

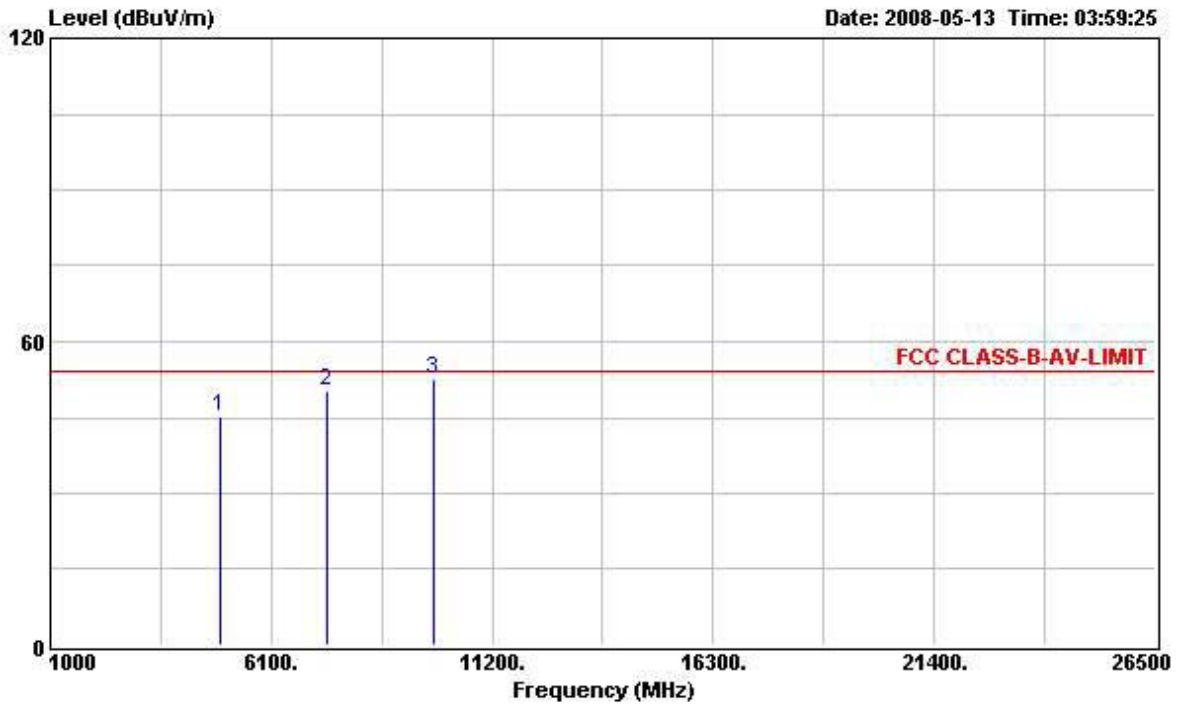

|   | Freq     | Level  | Over Limit | Limit Line | Read Level | Probe Factor | Cable Loss | Preamp Factor | Remark | Ant Pos | Table Pos |
|---|----------|--------|------------|------------|------------|--------------|------------|---------------|--------|---------|-----------|
|   | MHz      | dBuV/m | dB         | dBuV/m     | dBuV       | dB           | dB         | dB            |        | cm      | deg       |
| 1 | 4928.000 | 45.38  | -8.62      | 54.00      | 42.44      | 33.19        | 4.67       | 34.92         | Peak   | ---     | ---       |
| 2 | 7382.000 | 50.41  | -3.59      | 54.00      | 43.65      | 36.39        | 5.65       | 35.28         | Peak   | ---     | ---       |
| 3 | 9848.000 | 52.63  | -1.37      | 54.00      | 43.91      | 38.04        | 6.38       | 35.70         | Peak   | ---     | ---       |

Vertical

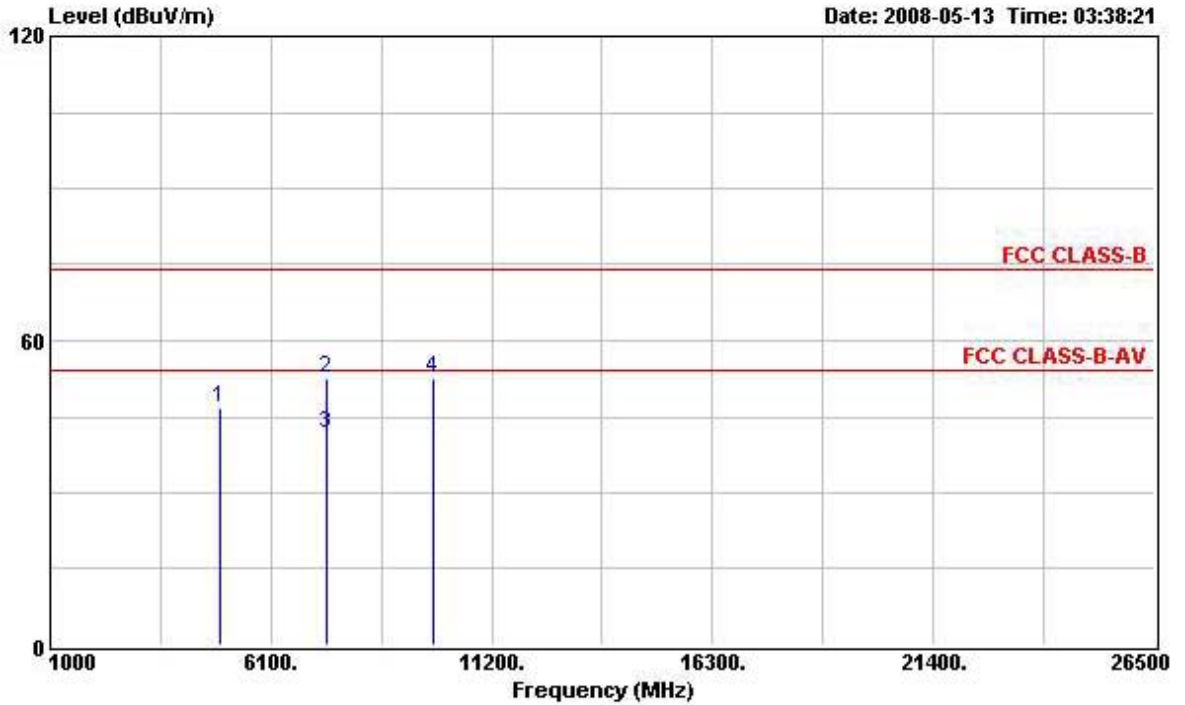

|   | Freq     | Level  | Over Limit | Limit Line | Read Level | Probe Factor | Cable Loss | Preamp Factor | Remark  | Ant Pos | Table Pos |
|---|----------|--------|------------|------------|------------|--------------|------------|---------------|---------|---------|-----------|
|   | MHz      | dBUV/m | dB         | dBUV/m     | dBuV       | dB           | dB         | dB            |         | cm      | deg       |
| 1 | 4924.000 | 46.59  | -7.41      | 54.00      | 43.65      | 33.19        | 4.67       | 34.92         | Peak    | ---     | ---       |
| 2 | 7388.000 | 52.68  | -21.32     | 74.00      | 45.88      | 36.43        | 5.65       | 35.28         | Peak    | ---     | ---       |
| 3 | 7388.000 | 41.65  | -12.35     | 54.00      | 34.85      | 36.43        | 5.65       | 35.28         | Average | ---     | ---       |
| 4 | 9852.000 | 52.50  | -1.50      | 54.00      | 43.78      | 38.04        | 6.38       | 35.70         | Peak    | ---     | ---       |

Note:

The amplitude of spurious emissions that are attenuated by more than 20dB below the permissible value has no need to be reported.

Emission level (dBUV/m) = 20 log Emission level (uV/m).

Corrected Reading: Antenna Factor + Cable Loss + Read Level - Preamp Factor = Level.

**3.6. Band Edge Emissions Measurement**

**3.6.1. Limit**

20dBc in any 100 kHz bandwidth outside the operating frequency band. In case the emission fall within the restricted band specified on 15.205(a), then the 15.209(a) limit in the table below has to be followed.

| <b>Frequencies<br/>(MHz)</b> | <b>Field Strength<br/>(micorvolts/meter)</b> | <b>Measurement Distance<br/>(meters)</b> |
|------------------------------|----------------------------------------------|------------------------------------------|
| 0.009~0.490                  | 2400/F(KHz)                                  | 300                                      |
| 0.490~1.705                  | 24000/F(KHz)                                 | 30                                       |
| 1.705~30.0                   | 30                                           | 30                                       |
| 30~88                        | 100                                          | 3                                        |
| 88~216                       | 150                                          | 3                                        |
| 216~960                      | 200                                          | 3                                        |
| Above 960                    | 500                                          | 3                                        |

**3.6.2. Measuring Instruments and Setting**

Please refer to section 4 of equipments list in this report. The following table is the setting of the spectrum analyzer.

| <b>Spectrum Parameter</b>                 | <b>Setting</b>                                 |
|-------------------------------------------|------------------------------------------------|
| Attenuation                               | Auto                                           |
| Span Frequency                            | 100 MHz                                        |
| RB / VB (Emission in restricted band)     | 1MHz / 1MHz for Peak, 1 MHz / 10Hz for Average |
| RB / VB (Emission in non-restricted band) | 100 KHz /100 KHz for Peak                      |

**3.6.3. Test Procedures**

1. The test procedure is the same as section 3.5.3, only the frequency range investigated is limited to 100MHz around bandedges.
2. In case the emission is fail due to the used RB/VB is too wide, marker-delta method of FCC Public Notice DA00-705 will be followed.

**3.6.4. Test Setup Layout**

This test setup layout is the same as that shown in section 3.5.4.

**3.6.5. Test Deviation**

There is no deviation with the original standard.

**3.6.6. EUT Operation during Test**

The EUT was programmed to be in continuously transmitting mode.



**3.6.7. Test Result of Band Edge Emissions**

|                      |              |                       |                                       |
|----------------------|--------------|-----------------------|---------------------------------------|
| <b>Test Date</b>     | May 13, 2008 | <b>Test Site No.</b>  | 03CH02-HY                             |
| <b>Temperature</b>   | 27           | <b>Humidity</b>       | 58%                                   |
| <b>Test Engineer</b> | Murphy       | <b>Configurations</b> | 802.11b CH 1, 6, 11<br>(Scenarios. A) |

**Channel 1**

|            | <b>Freq</b>     | <b>Level</b>  | <b>Over Limit</b> | <b>Limit Line</b> | <b>Read Level</b> | <b>Probe Factor</b> | <b>Cable Loss</b> | <b>Preamp Factor</b> | <b>Remark</b>  | <b>Ant Pos</b> | <b>Table Pos</b> |
|------------|-----------------|---------------|-------------------|-------------------|-------------------|---------------------|-------------------|----------------------|----------------|----------------|------------------|
|            | <b>MHz</b>      | <b>dBuV/m</b> | <b>dB</b>         | <b>dBuV/m</b>     | <b>dBuV</b>       | <b>dB</b>           | <b>dB</b>         | <b>dB</b>            |                | <b>cm</b>      | <b>deg</b>       |
| <b>1</b>   | <b>2389.420</b> | <b>58.12</b>  | <b>-15.88</b>     | <b>74.00</b>      | <b>26.91</b>      | <b>28.21</b>        | <b>3.00</b>       | <b>0.00</b>          | <b>Peak</b>    | ---            | ---              |
| <b>2 X</b> | <b>2409.370</b> | <b>112.12</b> |                   |                   | <b>80.84</b>      | <b>28.26</b>        | <b>3.02</b>       | <b>0.00</b>          | <b>Peak</b>    | ---            | ---              |
| <b>1</b>   | <b>2389.610</b> | <b>48.43</b>  | <b>-5.57</b>      | <b>54.00</b>      | <b>17.22</b>      | <b>28.21</b>        | <b>3.00</b>       | <b>0.00</b>          | <b>Average</b> | ---            | ---              |
| <b>2 X</b> | <b>2409.370</b> | <b>105.27</b> |                   |                   | <b>73.99</b>      | <b>28.26</b>        | <b>3.02</b>       | <b>0.00</b>          | <b>Average</b> | ---            | ---              |

**Channel 6**

|            | <b>Freq</b>     | <b>Level</b>  | <b>Over Limit</b> | <b>Limit Line</b> | <b>Read Level</b> | <b>Probe Factor</b> | <b>Cable Loss</b> | <b>Preamp Factor</b> | <b>Remark</b>  | <b>Ant Pos</b> | <b>Table Pos</b> |
|------------|-----------------|---------------|-------------------|-------------------|-------------------|---------------------|-------------------|----------------------|----------------|----------------|------------------|
|            | <b>MHz</b>      | <b>dBuV/m</b> | <b>dB</b>         | <b>dBuV/m</b>     | <b>dBuV</b>       | <b>dB</b>           | <b>dB</b>         | <b>dB</b>            |                | <b>cm</b>      | <b>deg</b>       |
| <b>1 X</b> | <b>2434.450</b> | <b>112.05</b> |                   |                   | <b>80.72</b>      | <b>28.31</b>        | <b>3.02</b>       | <b>0.00</b>          | <b>Peak</b>    | ---            | ---              |
| <b>1 X</b> | <b>2434.450</b> | <b>105.70</b> |                   |                   | <b>74.37</b>      | <b>28.31</b>        | <b>3.02</b>       | <b>0.00</b>          | <b>Average</b> | ---            | ---              |

**Channel 11**

|            | <b>Freq</b>     | <b>Level</b>  | <b>Over Limit</b> | <b>Limit Line</b> | <b>Read Level</b> | <b>Probe Factor</b> | <b>Cable Loss</b> | <b>Preamp Factor</b> | <b>Remark</b>  | <b>Ant Pos</b> | <b>Table Pos</b> |
|------------|-----------------|---------------|-------------------|-------------------|-------------------|---------------------|-------------------|----------------------|----------------|----------------|------------------|
|            | <b>MHz</b>      | <b>dBuV/m</b> | <b>dB</b>         | <b>dBuV/m</b>     | <b>dBuV</b>       | <b>dB</b>           | <b>dB</b>         | <b>dB</b>            |                | <b>cm</b>      | <b>deg</b>       |
| <b>1 X</b> | <b>2464.660</b> | <b>109.61</b> |                   |                   | <b>78.15</b>      | <b>28.40</b>        | <b>3.06</b>       | <b>0.00</b>          | <b>Peak</b>    | ---            | ---              |
| <b>2</b>   | <b>2486.130</b> | <b>56.65</b>  | <b>-17.35</b>     | <b>74.00</b>      | <b>25.14</b>      | <b>28.45</b>        | <b>3.06</b>       | <b>0.00</b>          | <b>Peak</b>    | ---            | ---              |
| <b>1 X</b> | <b>2464.660</b> | <b>102.94</b> |                   |                   | <b>71.48</b>      | <b>28.40</b>        | <b>3.06</b>       | <b>0.00</b>          | <b>Average</b> | ---            | ---              |
| <b>2</b>   | <b>2483.850</b> | <b>47.03</b>  | <b>-6.97</b>      | <b>54.00</b>      | <b>15.52</b>      | <b>28.45</b>        | <b>3.06</b>       | <b>0.00</b>          | <b>Average</b> | ---            | ---              |

|                      |              |                       |                                       |
|----------------------|--------------|-----------------------|---------------------------------------|
| <b>Test Date</b>     | May 13, 2008 | <b>Test Site No.</b>  | 03CH02-HY                             |
| <b>Temperature</b>   | 27           | <b>Humidity</b>       | 58%                                   |
| <b>Test Engineer</b> | Murphy       | <b>Configurations</b> | 802.11g CH 1, 6, 11<br>(Scenarios. A) |

Channel 1

|     | Freq     | Level  | Over Limit | Limit Line | Read Level | Probe Factor | Cable Loss | Preamp Factor | Remark  | Ant Pos | Table Pos |
|-----|----------|--------|------------|------------|------------|--------------|------------|---------------|---------|---------|-----------|
|     | MHz      | dBuV/m | dB         | dBuV/m     | dBuV       | dB           | dB         | dB            |         | cm      | deg       |
| 1   | 2390.000 | 68.51  | -5.49      | 74.00      | 37.30      | 28.21        | 3.00       | 0.00          | Peak    | ---     | ---       |
| 2 X | 2406.900 | 110.87 |            |            | 79.59      | 28.26        | 3.02       | 0.00          | Peak    | ---     | ---       |
| 1   | 2390.000 | 50.32  | -3.68      | 54.00      | 19.11      | 28.21        | 3.00       | 0.00          | Average | ---     | ---       |
| 2 X | 2408.420 | 103.66 |            |            | 72.38      | 28.26        | 3.02       | 0.00          | Average | ---     | ---       |

Channel 6

|     | Freq     | Level  | Over Limit | Limit Line | Read Level | Probe Factor | Cable Loss | Preamp Factor | Remark  | Ant Pos | Table Pos |
|-----|----------|--------|------------|------------|------------|--------------|------------|---------------|---------|---------|-----------|
|     | MHz      | dBuV/m | dB         | dBuV/m     | dBuV       | dB           | dB         | dB            |         | cm      | deg       |
| 1 X | 2431.980 | 109.72 |            |            | 78.39      | 28.31        | 3.02       | 0.00          | Peak    | ---     | ---       |
| 1 X | 2431.980 | 101.27 |            |            | 69.94      | 28.31        | 3.02       | 0.00          | Average | ---     | ---       |

Channel 11

|     | Freq     | Level  | Over Limit | Limit Line | Read Level | Probe Factor | Cable Loss | Preamp Factor | Remark  | Ant Pos | Table Pos |
|-----|----------|--------|------------|------------|------------|--------------|------------|---------------|---------|---------|-----------|
|     | MHz      | dBuV/m | dB         | dBuV/m     | dBuV       | dB           | dB         | dB            |         | cm      | deg       |
| 1 X | 2457.060 | 108.36 |            |            | 76.92      | 28.40        | 3.04       | 0.00          | Peak    | ---     | ---       |
| 2   | 2483.500 | 65.20  | -8.80      | 74.00      | 33.69      | 28.45        | 3.06       | 0.00          | Peak    | ---     | ---       |
| 1 X | 2464.850 | 101.88 |            |            | 70.42      | 28.40        | 3.06       | 0.00          | Average | ---     | ---       |
| 2   | 2483.500 | 48.57  | -5.43      | 54.00      | 17.06      | 28.45        | 3.06       | 0.00          | Average | ---     | ---       |

Note:

Emission level (dBuV/m) = 20 log Emission level (uV/m).

Corrected Reading: Antenna Factor + Cable Loss + Read Level - Preamp Factor = Level.

|                      |              |                       |                                       |
|----------------------|--------------|-----------------------|---------------------------------------|
| <b>Test Date</b>     | May 13, 2008 | <b>Test Site No.</b>  | 03CH02-HY                             |
| <b>Temperature</b>   | 27           | <b>Humidity</b>       | 58%                                   |
| <b>Test Engineer</b> | Murphy       | <b>Configurations</b> | 802.11b CH 1, 6, 11<br>(Scenarios. B) |

Channel 1

|     | Freq     | Level  | Over Limit | Limit Line | Read Level | Probe Factor | Cable Loss | Preamp Factor | Remark  | Ant Pos | Table Pos |
|-----|----------|--------|------------|------------|------------|--------------|------------|---------------|---------|---------|-----------|
|     | MHz      | dBuV/m | dB         | dBuV/m     | dBuV       | dB           | dB         | dB            |         | cm      | deg       |
| 1   | 2385.810 | 56.38  | -17.62     | 74.00      | 25.17      | 28.21        | 3.00       | 0.00          | Peak    | ---     | ---       |
| 2 X | 2415.260 | 109.55 |            |            | 78.27      | 28.26        | 3.02       | 0.00          | Peak    | ---     | ---       |
| 1   | 2390.000 | 46.42  | -7.58      | 54.00      | 15.21      | 28.21        | 3.00       | 0.00          | Average | ---     | ---       |
| 2 X | 2415.260 | 102.67 |            |            | 71.39      | 28.26        | 3.02       | 0.00          | Average | ---     | ---       |

Channel 6

|     | Freq     | Level  | Over Limit | Limit Line | Read Level | Probe Factor | Cable Loss | Preamp Factor | Remark  | Ant Pos | Table Pos |
|-----|----------|--------|------------|------------|------------|--------------|------------|---------------|---------|---------|-----------|
|     | MHz      | dBuV/m | dB         | dBuV/m     | dBuV       | dB           | dB         | dB            |         | cm      | deg       |
| 1 X | 2434.260 | 108.88 |            |            | 77.55      | 28.31        | 3.02       | 0.00          | Peak    | ---     | ---       |
| 1 X | 2434.260 | 102.22 |            |            | 70.89      | 28.31        | 3.02       | 0.00          | Average | ---     | ---       |

Channel 11

|     | Freq     | Level  | Over Limit | Limit Line | Read Level | Probe Factor | Cable Loss | Preamp Factor | Remark  | Ant Pos | Table Pos |
|-----|----------|--------|------------|------------|------------|--------------|------------|---------------|---------|---------|-----------|
|     | MHz      | dBuV/m | dB         | dBuV/m     | dBuV       | dB           | dB         | dB            |         | cm      | deg       |
| 1 X | 2464.660 | 108.74 |            |            | 77.28      | 28.40        | 3.06       | 0.00          | Peak    | ---     | ---       |
| 2   | 2486.700 | 56.54  | -17.46     | 74.00      | 25.03      | 28.45        | 3.06       | 0.00          | Peak    | ---     | ---       |
| 1 X | 2464.660 | 102.11 |            |            | 70.65      | 28.40        | 3.06       | 0.00          | Average | ---     | ---       |
| 2   | 2484.420 | 46.14  | -7.86      | 54.00      | 14.63      | 28.45        | 3.06       | 0.00          | Average | ---     | ---       |

|                      |              |                       |                                       |
|----------------------|--------------|-----------------------|---------------------------------------|
| <b>Test Date</b>     | May 13, 2008 | <b>Test Site No.</b>  | 03CH02-HY                             |
| <b>Temperature</b>   | 27           | <b>Humidity</b>       | 58%                                   |
| <b>Test Engineer</b> | Murphy       | <b>Configurations</b> | 802.11g CH 1, 6, 11<br>(Scenarios. B) |

Channel 1

|     | Freq     | Level  | Over Limit | Limit Line | Read Level | Probe Factor | Cable Loss | Preamp Factor | Remark  | Ant Pos | Table Pos |
|-----|----------|--------|------------|------------|------------|--------------|------------|---------------|---------|---------|-----------|
|     | MHz      | dBuV/m | dB         | dBuV/m     | dBuV       | dB           | dB         | dB            |         | cm      | deg       |
| 1   | 2390.000 | 64.20  | -9.80      | 74.00      | 32.99      | 28.21        | 3.00       | 0.00          | Peak    | ---     | ---       |
| 2 X | 2416.020 | 106.45 |            |            | 75.17      | 28.26        | 3.02       | 0.00          | Peak    | ---     | ---       |
| 1   | 2390.000 | 47.46  | -6.54      | 54.00      | 16.25      | 28.21        | 3.00       | 0.00          | Average | ---     | ---       |
| 2 X | 2413.930 | 100.05 |            |            | 68.77      | 28.26        | 3.02       | 0.00          | Average | ---     | ---       |

Channel 6

|     | Freq     | Level  | Over Limit | Limit Line | Read Level | Probe Factor | Cable Loss | Preamp Factor | Remark  | Ant Pos | Table Pos |
|-----|----------|--------|------------|------------|------------|--------------|------------|---------------|---------|---------|-----------|
|     | MHz      | dBuV/m | dB         | dBuV/m     | dBuV       | dB           | dB         | dB            |         | cm      | deg       |
| 1 X | 2431.980 | 107.23 |            |            | 75.90      | 28.31        | 3.02       | 0.00          | Peak    | ---     | ---       |
| 1 X | 2435.210 | 100.54 |            |            | 69.21      | 28.31        | 3.02       | 0.00          | Average | ---     | ---       |

Channel 11

|     | Freq     | Level  | Over Limit | Limit Line | Read Level | Probe Factor | Cable Loss | Preamp Factor | Remark  | Ant Pos | Table Pos |
|-----|----------|--------|------------|------------|------------|--------------|------------|---------------|---------|---------|-----------|
|     | MHz      | dBuV/m | dB         | dBuV/m     | dBuV       | dB           | dB         | dB            |         | cm      | deg       |
| 1 X | 2466.180 | 106.44 |            |            | 74.98      | 28.40        | 3.06       | 0.00          | Peak    | ---     | ---       |
| 2   | 2484.420 | 65.00  | -9.00      | 74.00      | 33.49      | 28.45        | 3.06       | 0.00          | Peak    | ---     | ---       |
| 1 X | 2466.180 | 98.28  |            |            | 66.82      | 28.40        | 3.06       | 0.00          | Average | ---     | ---       |
| 2   | 2483.500 | 46.94  | -7.06      | 54.00      | 15.43      | 28.45        | 3.06       | 0.00          | Average | ---     | ---       |

Note:

Emission level (dBuV/m) = 20 log Emission level (uV/m).

Corrected Reading: Antenna Factor + Cable Loss + Read Level - Preamp Factor = Level.

For Emission not in Restricted Band

Low Band Edge Plot on Configuration IEEE 802.11b / 2412 MHz / Scenarios. A

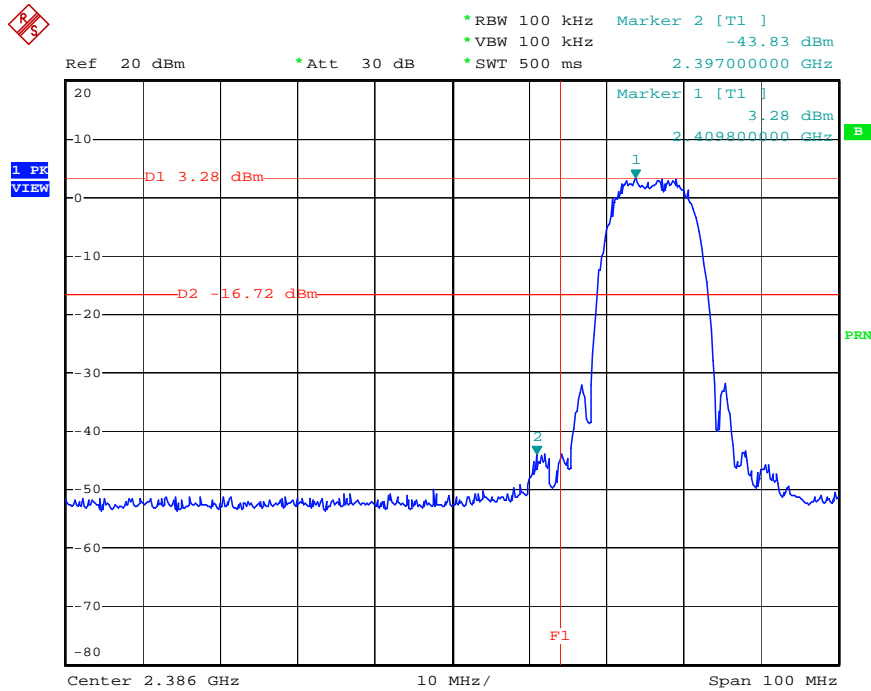

Date: 14.MAY.2008 16:05:29

High Band Edge Plot on Configuration IEEE 802.11b / 2462 MHz / Scenarios. A

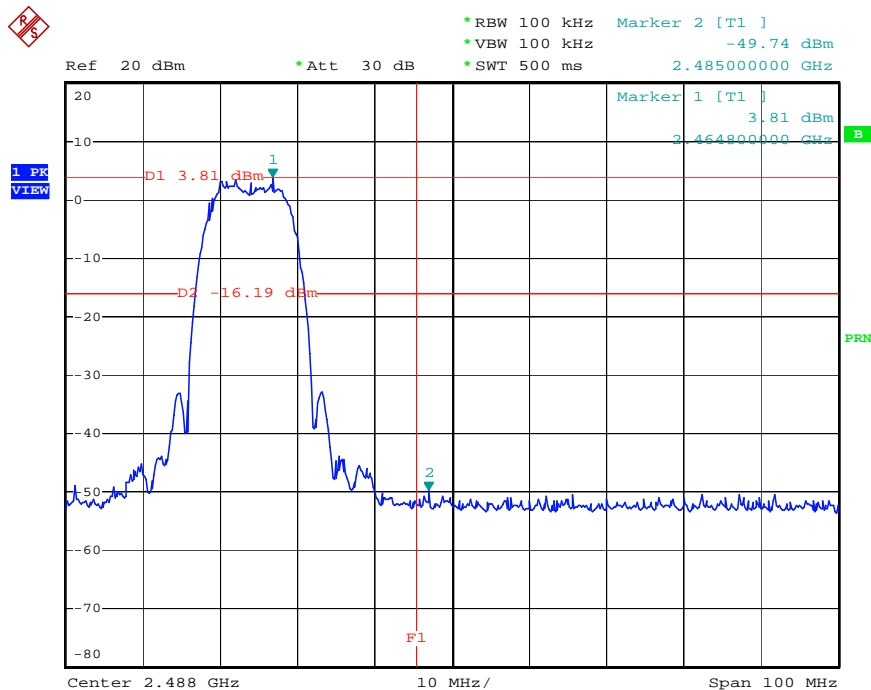

Date: 14.MAY.2008 16:11:50

Low Band Edge Plot on Configuration IEEE 802.11g / 2412 MHz / Scenarios. A

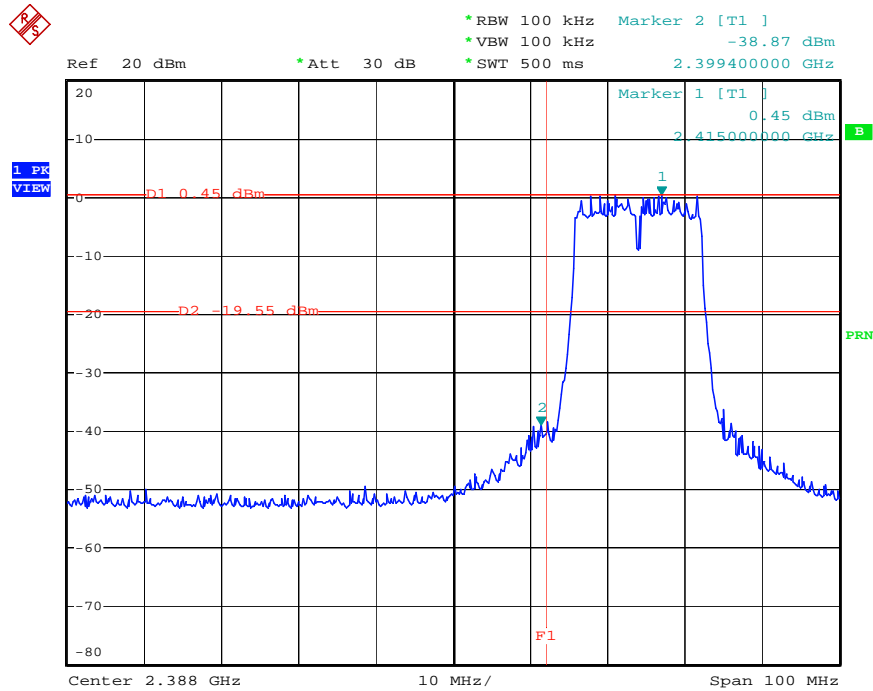

Date: 14.MAY.2008 16:16:47

High Band Edge Plot on Configuration IEEE 802.11g / 2462 MHz / Scenarios. A

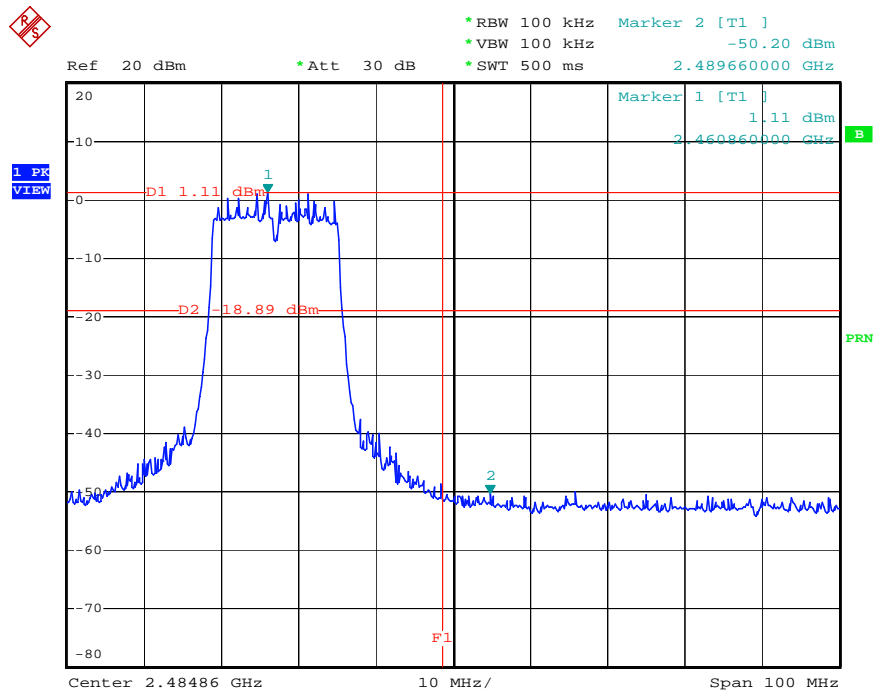

Date: 14.MAY.2008 16:27:21

Low Band Edge Plot on Configuration IEEE 802.11b / 2412 MHz / Scenarios. B

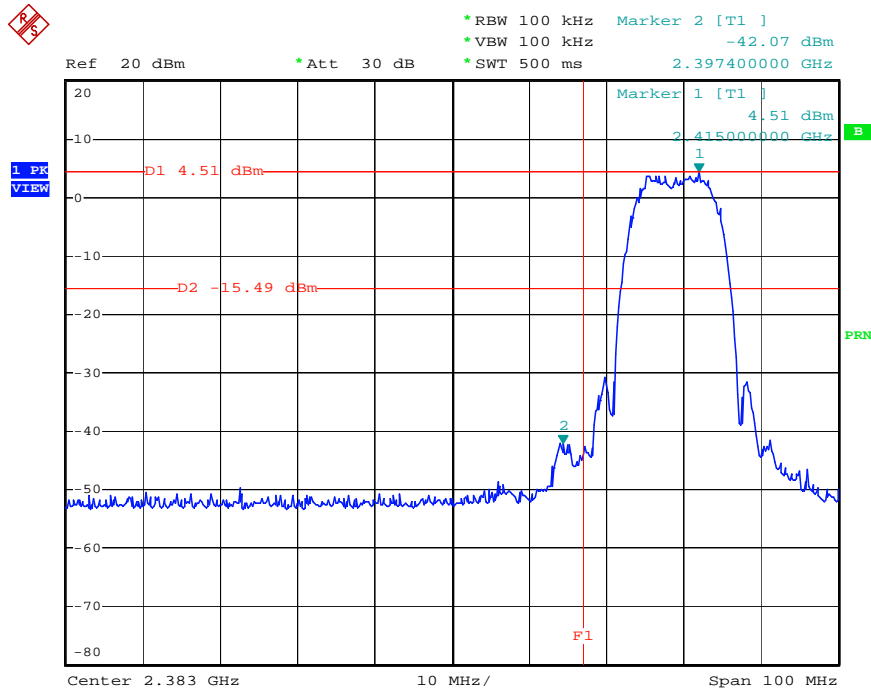

Date: 14.MAY.2008 15:36:07

High Band Edge Plot on Configuration IEEE 802.11b / 2462 MHz / Scenarios. B

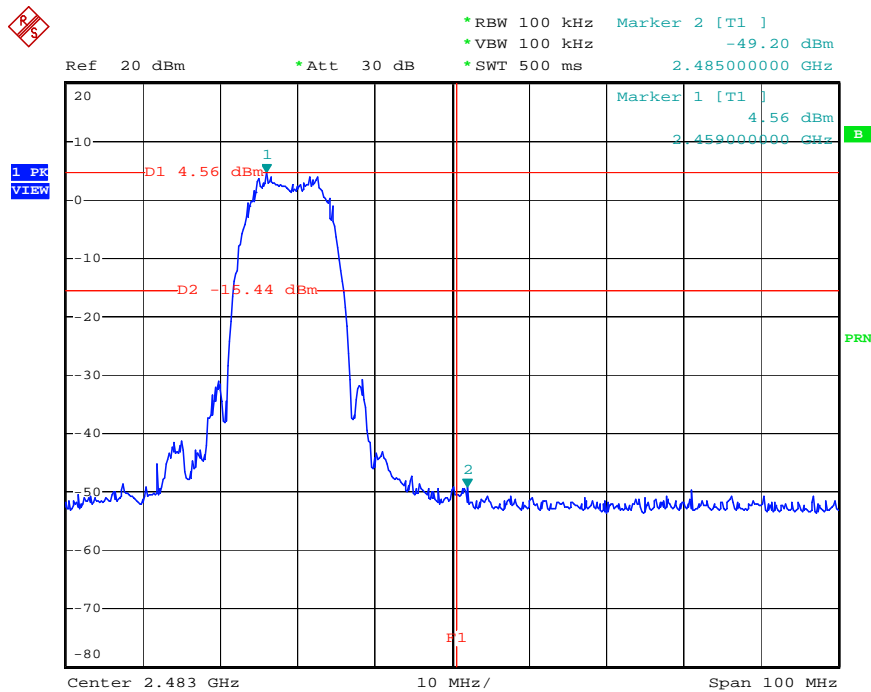

Date: 14.MAY.2008 15:45:03

Low Band Edge Plot on Configuration IEEE 802.11g / 2412 MHz / Scenarios. B

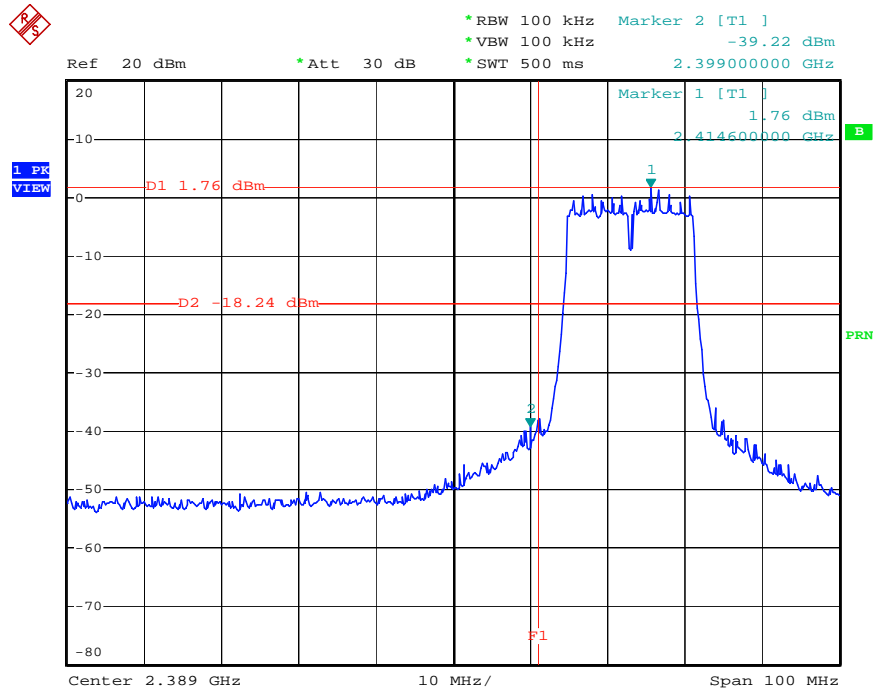

Date: 14.MAY.2008 15:51:56

High Band Edge Plot on Configuration IEEE 802.11g / 2462 MHz / Scenarios. B

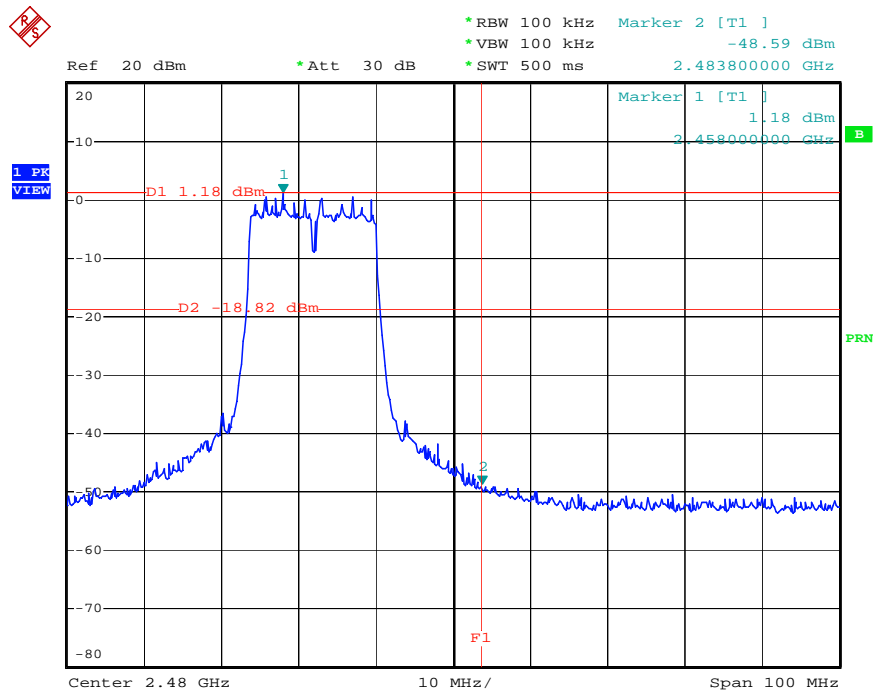

Date: 14.MAY.2008 15:57:40



### **3.7. Antenna Requirements**

#### **3.7.1. Limit**

Except for special regulations, the Low-power Radio-frequency Devices must not be equipped with any jacket for installing an antenna with extension cable. An intentional radiator shall be designed to ensure that no antenna other than that furnished by the responsible party shall be used with the device. The use of a permanently attached antenna or of an antenna that uses a unique coupling to the intentional radiator shall be considered sufficient to comply with the provisions of this Section. The manufacturer may design the unit so that the user can replace a broken antenna, but the use of a standard antenna jack or electrical connector is prohibited. Further, this requirement does not apply to intentional radiators that must be professionally installed.

#### **3.7.2. Antenna Connector Construction**

Please refer to section 2.4 in this test report; antenna connector complied with the requirements.

**4. LIST OF MEASURING EQUIPMENTS**

| Instrument                 | Manufacturer      | Model No.      | Serial No. | Characteristics   | Calibration Date | Remark                |
|----------------------------|-------------------|----------------|------------|-------------------|------------------|-----------------------|
| EMC Receiver               | R&S               | ESCS 30        | 100359     | 9kHz – 2.75GHz    | Mar. 03, 2008    | Conduction (CO04-HY)  |
| LISN                       | MessTec           | NNB-2/16Z      | 99079      | 9kHz – 30MHz      | Mar. 31, 2008    | Conduction (CO04-HY)  |
| LISN (Support Unit)        | EMCO              | 3810/2NM       | 9703-1839  | 9kHz – 30MHz      | Mar. 22, 2008    | Conduction (CO04-HY)  |
| RF Cable-CON               | UTIFLEX           | 3102-26886-4   | CB049      | 9kHz – 30MHz      | Dec. 03, 2007    | Conduction (CO04-HY)  |
| ISN                        | SCHAFFNER         | ISN T400       | 21653      | 9kHz –30MHz       | Mar. 27, 2008    | Conduction (CO04-HY)  |
| EMI Filter                 | LINDGREN          | LRE-2030       | 2651       | < 450 Hz          | N/A              | Conduction (CO04-HY)  |
| Isolation Transformer      | Erika Fiedler OHG | D-65396 Walluf | 58         | 45MHz-2.15GHz     | N/A              | Conduction (CO04-HY)  |
| 3m Semi Anechoic Chamber   | SIDT FRANKONIA    | SAC-3M         | 03CH03-HY  | 30 MHz - 1 GHz 3m | Jun. 14, 2007    | Radiation (03CH02-HY) |
| Amplifier                  | ADVANTEST         | BB525C         | CH300001   | 9 kHz - 2 GHz     | Dec. 05, 2007    | Radiation (03CH02-HY) |
| Spectrum Analyzer          | R&S               | FSP40          | 100305/040 | 9 kHz - 40GHz     | Jan. 10, 2008    | Radiation (03CH02-HY) |
| Bilog Antenna              | SCHAFFNER         | CBL61128       | 2723       | 30 MHz - 2 GHz    | Dec. 22, 2007    | Radiation (03CH02-HY) |
| Turn Table                 | HD                | DS 420         | 420/649/00 | 0 - 360 degree    | N/A              | Radiation (03CH02-HY) |
| Antenna Mast               | HD                | MA 240         | 240/559/00 | 1 m - 4 m         | N/A              | Radiation (03CH02-HY) |
| RF Cable-R03m              | Jye Bao           | RG142          | CB020      | 30 MHz - 1 GHz    | Dec. 08, 2007    | Radiation (03CH02-HY) |
| Amplifier                  | Agilent           | 8449B          | 3008A20373 | 1GHz – 26.5 GHz   | Jul. 09, 2007    | Radiation (03CH02-HY) |
| Horn Antenna               | EMCO              | 3115           | 6903       | 1GHz~18GHz        | Apr. 21, 2008    | Radiation (03CH02-HY) |
| RF Cable-HIGH              | SUHNER            | SUCOFLEX106    | 03CH02-HY  | 1GHz~40GHz        | Dec. 12, 2007    | Radiation (03CH02-HY) |
| Spectrum Analyzer          | R&S               | FSP30          | 100023     | 9kHz ~ 30GHz      | Jan. 10, 2008    | Conducted (TH01-HY)   |
| Power Meter                | R&S               | NRVS           | 100444     | DC ~ 40GHz        | Jun. 27, 2007    | Conducted (TH01-HY)   |
| Power Sensor               | R&S               | NRV-Z51        | 100458     | DC ~ 30GHz        | Jun. 27, 2007    | Conducted (TH01-HY)   |
| Power Sensor               | R&S               | NRV-Z32        | 100057     | 30MHz ~ 6GHz      | Jun. 27, 2007    | Conducted (TH01-HY)   |
| DC Power Source            | G.W.              | GPC-6030D      | C671845    | DC 1V ~ 60V       | Mar. 13, 2008    | Conducted (TH01-HY)   |
| Temp. and Humidity Chamber | KSON              | THS-C3L        | 612        | N/A               | Oct. 01, 2007    | Conducted (TH01-HY)   |
| RF CABLE-1m                | Jye Bao           | RG142          | CB034-1m   | 20MHz ~ 7GHz      | Dec. 01, 2007    | Conducted (TH01-HY)   |
| RF CABLE-2m                | Jye Bao           | RG142          | CB035-2m   | 20MHz ~ 1GHz      | Dec. 01, 2007    | Conducted (TH01-HY)   |
| Vector Signal Generator    | R&S               | SMU200A        | 102098     | 100kHz ~ 6GHz     | Nov. 14, 2007    | Conducted (TH01-HY)   |
| Signal Generator           | R&S               | SMR40          | 100116     | 10MHz ~ 40GHz     | Mar. 10, 2008    | Conducted (TH01-HY)   |

Note: Calibration Interval of instruments listed above is one year. NCR: Non-Calibration required.

| Instrument      | Manufacturer | Model No. | Serial No.  | Characteristics | Calibration Date | Remark              |
|-----------------|--------------|-----------|-------------|-----------------|------------------|---------------------|
| AC Power Source | HPC          | HPA-500W  | HPA-9100024 | AC 0 ~ 300V     | May 04, 2007*    | Conducted (TH01-HY) |

Note: Calibration Interval of instruments listed above is two year.

## 5. TEST LOCATIONS

|        |                                                                                                                                        |
|--------|----------------------------------------------------------------------------------------------------------------------------------------|
| SHIJR  | ADD : 6Fl., No. 106, Sec. 1, Shintai 5th Rd., Shijr City, Taipei, Taiwan 221, R.O.C.<br>TEL : 886-2-2696-2468<br>FAX : 886-2-2696-2255 |
| HWA YA | ADD : No. 52, Hwa Ya 1st Rd., Kwei-Shan Hsiang, Tao Yuan Hsien, Taiwan, R.O.C.<br>TEL : 886-3-327-3456<br>FAX : 886-3-318-0055         |
| LINKOU | ADD : No. 30-2, Dingfu Tsuen, Linkou Shiang, Taipei, Taiwan 244, R.O.C<br>TEL : 886-2-2601-1640<br>FAX : 886-2-2601-1695               |
| DUNGHU | ADD : No. 3, Lane 238, Kangle St., Neihu Chiu, Taipei, Taiwan 114, R.O.C.<br>TEL : 886-2-2631-4739<br>FAX : 886-2-2631-9740            |
| JUNGHE | ADD : 7Fl., No. 758, Jungjeng Rd., Junghe City, Taipei, Taiwan 235, R.O.C.<br>TEL : 886-2-8227-2020<br>FAX : 886-2-8227-2626           |
| NEIHU  | ADD : 4Fl., No. 339, Hsin Hu 2 <sup>nd</sup> Rd., Taipei 114, Taiwan, R.O.C.<br>TEL : 886-2-2794-8886<br>FAX : 886-2-2794-9777         |
| JHUBEI | ADD : No.8, Lane 724, Bo-ai St., Jhubei City, HsinChu County 302, Taiwan, R.O.C.<br>TEL : 886-3-656-9065<br>FAX : 886-3-656-9085       |

6. TAF CERTIFICATE OF ACCREDITATION



Certificate No. : L1190-070110

財團法人全國認證基金會  
Taiwan Accreditation Foundation

### Certificate of Accreditation

This is to certify that

**Sporton International Inc.**  
**EMC & Wireless Communications Laboratory**  
 No.52, Hwa Ya 1st Rd., Hwa Ya Technology Park, Kwei-Shan Hsiang, Tao Yuan Hsien,  
 Taiwan, R.O.C.

**is accredited in respect of laboratory**

|                                       |                                                                                                                                                                        |
|---------------------------------------|------------------------------------------------------------------------------------------------------------------------------------------------------------------------|
| <b>Accreditation Criteria</b>         | : ISO/IEC 17025:2005                                                                                                                                                   |
| <b>Accreditation Number</b>           | : 1190                                                                                                                                                                 |
| <b>Originally Accredited</b>          | : December 15, 2003                                                                                                                                                    |
| <b>Effective Period</b>               | : January 10, 2007 to January 09, 2010                                                                                                                                 |
| <b>Accredited Scope</b>               | : Testing Field, see described in the Appendix                                                                                                                         |
| <b>Specific Accreditation Program</b> | : Accreditation Program for Designated Testing Laboratory<br>for Commodities Inspection<br>Accreditation Program for Telecommunication Equipment<br>Testing Laboratory |

  
 Jay-San Chen  
 President, Taiwan Accreditation Foundation  
 Date : January 10, 2007

PI, total 9 pages

The Appendix forms an integral part of this Certificate, which shall be invalid when used without the Appendix.