



A D T

FCC TEST REPORT (15.247)

REPORT NO.: RF110816C04

MODEL NO.: TD5136

BRAND NAME: Technicolor

FCC ID: RSE-TD5136

RECEIVED: Aug. 16, 2011

TESTED: Sep. 6 ~ 9, 2011

ISSUED: Feb. 15, 2012

APPLICANT: Thomson Telecom Belgium

ADDRESS: Prins Boudewijnlaan 47 B-2650 Edegem - Belgium

ISSUED BY: Bureau Veritas Consumer Products Services (H.K.)
Ltd., Taoyuan Branch

LAB LOCATION : No. 47, 14th Ling, Chia Pau Vil., Lin Kou Dist., New
Taipei City 244, Taiwan

This test report consists of 81 pages in total. It may be duplicated completely for legal use with the approval of the applicant. It should not be reproduced except in full, without the written approval of our laboratory. The client should not use it to claim product, certification, approval or endorsement by TAF or any government agency. The test results in the report only apply to the tested sample.





A D T

TABLE OF CONTENTS

RELEASE CONTROL RECORD.....	4
1. CERTIFICATION	5
2. SUMMARY OF TEST RESULTS.....	6
2.1 MEASUREMENT UNCERTAINTY	6
3. GENERAL INFORMATION	7
3.1 GENERAL DESCRIPTION OF EUT.....	7
3.2 DESCRIPTION OF TEST MODES.....	9
3.2.1 CONFIGURATION OF SYSTEM UNDER TEST	9
3.2.2 TEST MODE APPLICABILITY AND TESTED CHANNEL DETAIL	10
3.3 GENERAL DESCRIPTION OF APPLIED STANDARDS	13
3.4 DESCRIPTION OF SUPPORT UNITS.....	13
4. TEST TYPES AND RESULTS	14
4.1 CONDUCTED EMISSION MEASUREMENT	14
4.1.1 LIMITS OF CONDUCTED EMISSION MEASUREMENT.....	14
4.1.2 TEST INSTRUMENTS	14
4.1.3 TEST PROCEDURES.....	15
4.1.4 DEVIATION FROM TEST STANDARD	15
4.1.5 TEST SETUP	16
4.1.6 EUT OPERATING CONDITIONS.....	16
4.1.7 TEST RESULTS.....	17
4.2 RADIATED EMISSION MEASUREMENT	19
4.2.1 LIMITS OF RADIATED EMISSION MEASUREMENT.....	19
4.2.2 TEST INSTRUMENTS	20
4.2.3 TEST PROCEDURES.....	21
4.2.4 DEVIATION FROM TEST STANDARD	21
4.2.5 TEST SETUP	22
4.2.6 EUT OPERATING CONDITIONS.....	22
4.2.7 TEST RESULTS.....	23
4.3 6dB BANDWIDTH MEASUREMENT	36
4.3.1 LIMITS OF 6dB BANDWIDTH MEASUREMENT.....	36
4.3.2 TEST INSTRUMENTS	36
4.3.3 TEST PROCEDURE	36
4.3.4 DEVIATION FROM TEST STANDARD	36
4.3.5 TEST SETUP	37
4.3.6 EUT OPERATING CONDITIONS.....	37
4.3.7 TEST RESULTS.....	38
4.4 MAXIMUM OUTPUT POWER.....	42
4.4.1 LIMITS OF MAXIMUM OUTPUT POWER MEASUREMENT.....	42
4.4.2 INSTRUMENTS	42
4.4.3 TEST PROCEDURES.....	42
4.4.4 DEVIATION FROM TEST STANDARD	43
4.4.5 TEST SETUP	43
4.4.6 EUT OPERATING CONDITIONS.....	43
4.4.7 TEST RESULTS.....	44



A D T

4.5	POWER SPECTRAL DENSITY MEASUREMENT	45
4.5.1	LIMITS OF POWER SPECTRAL DENSITY MEASUREMENT	45
4.5.2	TEST INSTRUMENTS	45
4.5.3	TEST PROCEDURE	45
4.5.4	DEVIATION FROM TEST STANDARD	46
4.5.5	TEST SETUP	46
4.5.6	EUT OPERATING CONDITION	46
4.5.7	TEST RESULTS	47
4.6	BAND EDGES MEASUREMENT	51
4.6.1	LIMITS OF BAND EDGES MEASUREMENT	51
4.6.2	TEST INSTRUMENTS	51
4.6.3	TEST PROCEDURE	52
4.6.4	DEVIATION FROM TEST STANDARD	52
4.6.5	EUT OPERATING CONDITION	52
4.6.6	TEST RESULTS	53
5.	PHOTOGRAPHS OF THE TEST CONFIGURATION.....	79
6.	INFORMATION ON THE TESTING LABORATORIES	80
7.	APPENDIX A - MODIFICATIONS RECORDERS FOR ENGINEERING CHANGES TO THE EUT BY THE LAB	81



A D T

RELEASE CONTROL RECORD

ISSUE NO.	REASON FOR CHANGE	DATE ISSUED
RF110816C04	Original release	Feb. 15, 2012



A D T

1. CERTIFICATION

PRODUCT: ADSL MODEM
BRAND NAME: Technicolor
MODEL NO.: TD5136
APPLICANT: Thomson Telecom Belgium
TEST ITEM: PEM2
TESTED: Sep. 6 ~ 9, 2011
STANDARDS: **FCC Part 15, Subpart C (Section 15.247)**
ANSI C63.10-2009

The above equipment has been tested by **Bureau Veritas Consumer Products Services (H.K.) Ltd., Taoyuan Branch**, and found compliance with the requirement of the above standards. The test record, data evaluation & Equipment Under Test (EUT) configurations represented herein are true and accurate accounts of the measurements of the sample's EMC characteristics under the conditions specified in this report.

PREPARED BY : Annie Chang , **DATE:** Feb 15, 2012
(Annie Chang / Senior Specialist)

APPROVED BY : Ken Liu , **DATE:** Feb. 15, 2012
(Ken Liu / Manager)



A D T

2. SUMMARY OF TEST RESULTS

The EUT has been tested according to the following specifications:

APPLIED STANDARD: FCC PART 15, SUBPART C (SECTION 15.247)			
STANDARD SECTION	TEST TYPE AND LIMIT	RESULT	REMARK
15.207	AC Power Conducted Emission	PASS	Meet the requirement of limit. Minimum passing margin is -7.64dB at 0.158MHz
15.247(a)(2)	Spectrum Bandwidth of a Direct Sequence Spread Spectrum System Limit: min. 500kHz	PASS	Meet the requirement of limit.
15.247(b)	Maximum Output Power Limit: max. 30dBm	PASS	Meet the requirement of limit.
15.247(d)	Radiated Emissions Limit: Table 15.209	PASS	Meet the requirement of limit. Minimum passing margin is -1.0dB at 2483.50MHz
15.247(e)	Power Spectral Density Limit: max. 8dBm	PASS	Meet the requirement of limit.
15.247(d)	Band Edge Measurement Limit: 20dB less than the peak value of fundamental frequency	PASS	Meet the requirement of limit.
15.203	Antenna Requirement	PASS	No antenna connector is used.

2.1 MEASUREMENT UNCERTAINTY

Where relevant, the following measurement uncertainty levels have been estimated for tests performed on the EUT as specified in CISPR 16-4-2:

This uncertainty represents an expanded uncertainty expressed at approximately the 95% confidence level using a coverage factor of $k = 2$.

MEASUREMENT	FREQUENCY	UNCERTAINTY
Conducted emissions	150kHz~30MHz	2.41 dB
Radiated emissions	30MHz ~ 1GHz	3.87 dB
	Above 1GHz	3.36 dB



3. GENERAL INFORMATION

3.1 GENERAL DESCRIPTION OF EUT

PRODUCT	ADSL MODEM
MODEL NO.	TD5136
FCC ID	RSE-TD5136
NOMINAL VOLTAGE	12Vdc
MODULATION TYPE	CCK, DQPSK, DBPSK for DSSS 64QAM, 16QAM, QPSK, BPSK for OFDM
MODULATION TECHNOLOGY	DSSS, OFDM
TRANSFER RATE	802.11b:11.0/ 5.5/ 2.0/ 1.0Mbps 802.11g: 54.0/ 48.0/ 36.0/ 24.0/ 18.0/ 12.0/ 9.0/ 6.0Mbps 802.11n: up to 150.0Mbps
OPERATING FREQUENCY	2412.0 ~ 2462.0MHz
NUMBER OF CHANNEL	11 for 802.11b, 802.11g, 802.11n (20MHz) 7 for 802.11n (40MHz)
OUTPUT POWER	279.7mW
ANTENNA TYPE	Printed Antenna with 4dBi gain
ANTENNA CONNECTOR	NA
DATA CABLE	NA
I/O PORTS	RJ45/ RJ11/ USB
ACCESSORY DEVICES	Adapter

NOTE:

1. The EUT is an ADSL MODEM.
2. The EUT consumes power from the following AC adapter:

BRAND	MODEL NO.	SPEC.
A-tech OEM	ADS012K-W 120100	AC I/P: 100-240V, 50-60Hz, 0.5A DC O/P: 12V, 1.0A AC 2-pin, Non-shielded DC cable (1.5m).



A D T

3. The EUT incorporates a MIMO function. Physically, the EUT provides two completed transmitters and two receivers.

MODULATION MODE	TX FUNCTION
802.11b	1TX
802.11g	1TX
802.11n (20MHz) MCS 0-7	1TX
802.11n (20MHz) MCS 8-15	2TX
802.11n (40MHz) MCS 0-7	1TX
802.11n (40MHz) MCS 8-15	2TX

4. The collocated with typical 3G device has been evaluated and no non-compliance found.
5. The above EUT information is declared by manufacturer and for more detailed features description, please refer to the manufacturer's specifications or user's manual.

3.2 DESCRIPTION OF TEST MODES

11 channels are provided for 802.11b, 802.11g and 802.11n (20MHz):

CHANNEL	FREQUENCY	CHANNEL	FREQUENCY
1	2412MHz	7	2442MHz
2	2417MHz	8	2447MHz
3	2422MHz	9	2452MHz
4	2427MHz	10	2457MHz
5	2432MHz	11	2462MHz
6	2437MHz		

7 channels are provided for 802.11n (40MHz):

CHANNEL	FREQUENCY	CHANNEL	FREQUENCY
1	2422MHz	5	2442MHz
2	2427MHz	6	2447MHz
3	2432MHz	7	2452MHz
4	2437MHz		

3.2.1 CONFIGURATION OF SYSTEM UNDER TEST

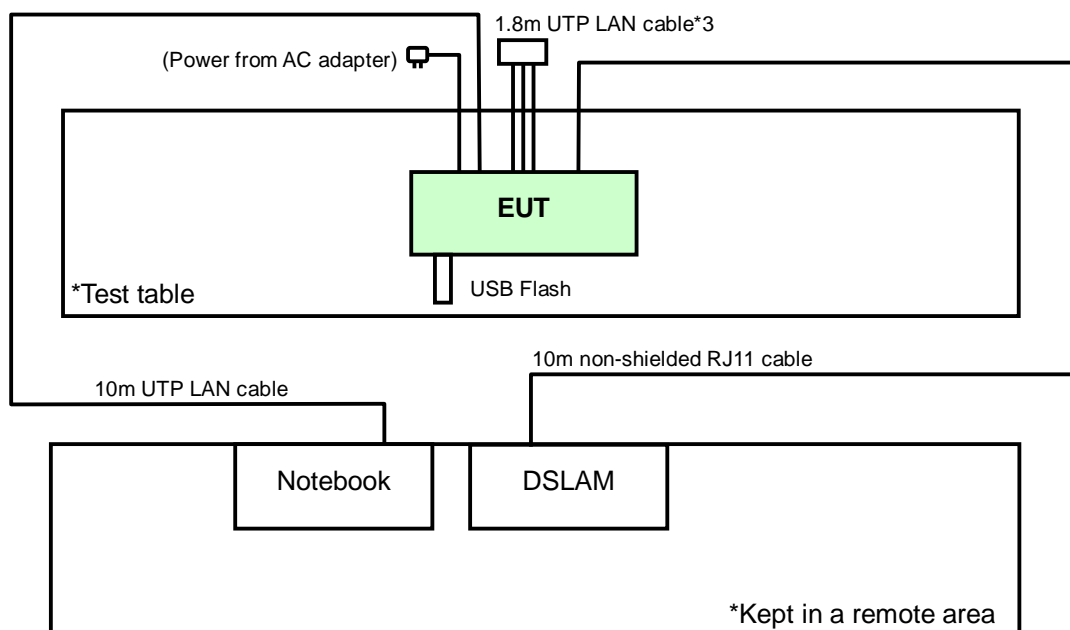



3.2.2 TEST MODE APPLICABILITY AND TESTED CHANNEL DETAIL

EUT CONFIGURE MODE	APPLICABLE TO				DESCRIPTION
	PLC	RE [≥] 1G	RE<1G	APCM	
-	√	√	√	√	-

Where **PLC**: Power Line Conducted Emission **RE[≥]1G**: Radiated Emission above 1GHz
RE<1G: Radiated Emission below 1GHz **APCM**: Antenna Port Conducted Measurement

POWER LINE CONDUCTED EMISSION TEST:

- Pre-Scan has been conducted to determine the worst-case mode from all possible combinations between available modulations, data rates and antenna ports (if EUT with antenna diversity architecture).
- Following channel(s) was (were) selected for the final test as listed below.

MODE	AVAILABLE CHANNEL	TESTED CHANNEL	MODULATION TECHNOLOGY	MODULATION TYPE	DATA RATE (Mbps)
802.11g	1 to 11	1	OFDM	BPSK	6.0

RADIATED EMISSION TEST (ABOVE 1GHz):

- Pre-Scan has been conducted to determine the worst-case mode from all possible combinations between available modulations, data rates, XZ Axis and antenna ports (if EUT with antenna diversity architecture).
- Following channel(s) was (were) selected for the final test as listed below.

MODE	AVAILABLE CHANNEL	TESTED CHANNEL	MODULATION TECHNOLOGY	MODULATION TYPE	DATA RATE (Mbps)	AXIS
802.11b	1 to 11	1, 6, 11	DSSS	DBPSK	1.0	Z
802.11g	1 to 11	1, 6, 11	OFDM	BPSK	6.0	Z
802.11n (20MHz)	1 to 11	1, 6, 11	OFDM	BPSK	6.5	Z
802.11n (40MHz)	1 to 7	1, 4, 7	OFDM	BPSK	13.5	Z



RADIATED EMISSION TEST (BELOW 1GHz):

- Pre-Scan has been conducted to determine the worst-case mode from all possible combinations between available modulations, data rates, XZ Axis and antenna ports (if EUT with antenna diversity architecture).
- Following channel(s) was (were) selected for the final test as listed below.

MODE	AVAILABLE CHANNEL	TESTED CHANNEL	MODULATION TECHNOLOGY	MODULATION TYPE	DATA RATE (Mbps)	AXIS
802.11g	1 to 11	1	OFDM	BPSK	6.0	Z

BANDEDGE MEASUREMENT:

- Pre-Scan has been conducted to determine the worst-case mode from all possible combinations between available modulations, data rates and antenna ports (if EUT with antenna diversity architecture).
- Following channel(s) was (were) selected for the final test as listed below.

MODE	AVAILABLE CHANNEL	TESTED CHANNEL	MODULATION TECHNOLOGY	MODULATION TYPE	DATA RATE (Mbps)
802.11b	1 to 11	1, 11	DSSS	DBPSK	1.0
802.11g	1 to 11	1, 11	OFDM	BPSK	6.0
802.11n (20MHz)	1 to 11	1, 11	OFDM	BPSK	6.5
802.11n (40MHz)	1 to 7	1, 7	OFDM	BPSK	13.5

ANTENNA PORT CONDUCTED MEASUREMENT:

- This item includes all test value of each mode, but only includes spectrum plot of worst value of each mode.
- Pre-Scan has been conducted to determine the worst-case mode from all possible combinations between available modulations, data rates and antenna ports (if EUT with antenna diversity architecture).
- Following channel(s) was (were) selected for the final test as listed below.

MODE	AVAILABLE CHANNEL	TESTED CHANNEL	MODULATION TECHNOLOGY	MODULATION TYPE	DATA RATE (Mbps)
802.11b	1 to 11	1, 6, 11	DSSS	DBPSK	1.0
802.11g	1 to 11	1, 6, 11	OFDM	BPSK	6.0
802.11n (20MHz)	1 to 11	1, 6, 11	OFDM	BPSK	6.5
802.11n (40MHz)	1 to 7	1, 4, 7	OFDM	BPSK	13.5



A D T

TEST CONDITION:

APPLICABLE TO	ENVIRONMENTAL CONDITIONS	INPUT POWER	TESTED BY
PLC	25deg. C, 68% RH	120Vac, 60Hz	Jun Wu
RE ³ 1G	26deg. C, 72% RH	120Vac, 60Hz	Chad Lee
RE <1G	26deg. C, 65% RH	120Vac, 60Hz	Chad Lee
APCM	25deg. C, 70% RH	120Vac, 60Hz	Jun Wu



A D T

3.3 GENERAL DESCRIPTION OF APPLIED STANDARDS

The EUT is a RF Product. According to the specifications of the manufacturer, it must comply with the requirements of the following standards:

FCC Part 15, Subpart C (15.247)

ANSI C63.10-2009

All test items have been performed and recorded as per the above standards.

NOTE: The EUT is also considered as a kind of computer peripheral, because the connection to computer is necessary for typical use. It has been verified to comply with the requirements of FCC Part 15, Subpart B, Class B (DoC). The test report has been issued separately.

3.4 DESCRIPTION OF SUPPORT UNITS

The EUT has been tested as an independent unit together with other necessary accessories or support units. The following support units or accessories were used to form a representative test configuration during the tests.

NO.	PRODUCT	BRAND	MODEL NO.	SERIAL NO.	FCC ID
1	NOTEBOOK COMPUTER	DELL	PP05L	19227741184	FCC DoC Approved
2	USB Flash Drive	SanDisk	Cruzer Micro Skin	NA	FCC DoC Approved
3	DSLAM	Alcatel	7300ASAM	N/A	N/A

NO.	SIGNAL CABLE DESCRIPTION OF THE ABOVE SUPPORT UNITS
1	10m UTP LAN
2	N/A
3	10m non-shielded RJ11 cable

NOTE: (1) All power cords of the above support units are non-shielded (1.5m).

(2) Three UTP LAN cables (1.8m each) were connected to EUT to form open loop cable, which was terminated with 100ohm resistor load.

(3) The support unit 3 was provided by client.



4. TEST TYPES AND RESULTS

4.1 CONDUCTED EMISSION MEASUREMENT

4.1.1 LIMITS OF CONDUCTED EMISSION MEASUREMENT

FREQUENCY OF EMISSION (MHz)	CONDUCTED LIMIT (dBµV)	
	Quasi-peak	Average
0.15 ~ 0.5	66 to 56	56 to 46
0.5 ~ 5	56	46
5 ~ 30	60	50

- NOTE:**
1. The lower limit shall apply at the transition frequencies.
 2. The limit decreases in line with the logarithm of the frequency in the range of 0.15 to 0.50MHz.
 3. All emanations from a class A/B digital device or system, including any network of conductors and apparatus connected thereto, shall not exceed the level of field strengths specified above.

4.1.2 TEST INSTRUMENTS

DESCRIPTION & MANUFACTURER	MODEL NO.	SERIAL NO.	CALIBRATED DATE	CALIBRATED UNTIL
ROHDE & SCHWARZ Test Receiver	ESCS 30	100276	Dec. 31, 2010	Dec. 30, 2011
ROHDE & SCHWARZ Artificial Mains Network (for EUT)	ESH3-Z5	100219	Nov. 24, 2010	Nov. 23, 2011
LISN With Adapter (for EUT)	AD10	C10Ada-001	Nov. 24, 2010	Nov. 23, 2011
ROHDE & SCHWARZ Artificial Mains Network (for peripherals)	ESH3-Z5	100218	Nov. 24, 2010	Nov. 23, 2011
Software	ADT_Cond_V7.3.7	NA	NA	NA
Software	ADT_ISN_V7.3.7	NA	NA	NA
RF cable (JYEBAO)	5D-FB	Cable-C10.01	Feb. 22, 2011	Feb. 21, 2012
SUHNER Terminator (For ROHDE & SCHWARZ LISN)	65BNC-5001	E1-010773	Feb. 26, 2011	Feb. 25, 2012

- NOTE:**
1. The calibration interval of the above test instruments is 12 months and the calibrations are traceable to NML/ROC and NIST/USA.
 2. The test was performed in Shielded Room No. 10.
 3. The VCCI Site Registration No. C-1852.



A D T

4.1.3 TEST PROCEDURES

- a. The EUT was placed 0.4 meters from the conducting wall of the shielded room with EUT being connected to the power mains through a line impedance stabilization network (LISN). Other support units were connected to the power mains through another LISN. The two LISNs provide 50 ohm/ 50uH of coupling impedance for the measuring instrument.
- b. Both lines of the power mains connected to the EUT were checked for maximum conducted interference.
- c. The frequency range from 150kHz to 30MHz was searched. Emission levels under (Limit - 20dB) was not recorded.

NOTE: All modes of operation were investigated and the worst-case emissions are reported.

4.1.4 DEVIATION FROM TEST STANDARD

No deviation.

4.1.5 TEST SETUP

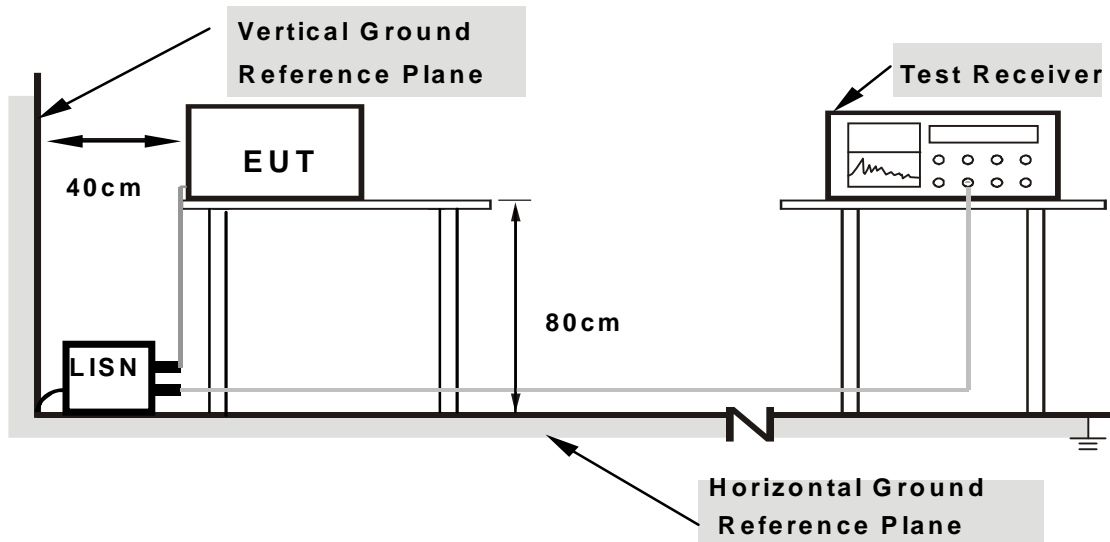

- Note:**
1. Support units were connected to second LISN.
 2. Both of LISNs (AMN) are 80 cm from EUT and at least 80 from other units and other metal planes

For the actual test configuration, please refer to the attached file (Test Setup Photo).

4.1.6 EUT OPERATING CONDITIONS

- a. Turn on the power of all equipment.
- b. Notebook PC ran a test program (provided by manufacture) to enable.
- c. Connect DSLAM and EUT via non-shielded RJ11 cable.
- d. Set the EUT under transmission condition continuously at specific channel frequency.



A D T

4.1.7 TEST RESULTS

CONDUCTED WORST-CASE DATA : 802.11g

CHANNEL	Channel 1		
PHASE	Line 1	6dB BANDWIDTH	9kHz

No	Freq. [MHz]	Corr. Factor (dB)	Reading Value		Emission Level		Limit		Margin	
			[dB (uV)]		[dB (uV)]		[dB (uV)]		(dB)	
			Q.P.	AV.	Q.P.	AV.	Q.P.	AV.	Q.P.	AV.
1	0.150	0.18	57.94	43.83	58.12	44.01	66.00	56.00	-7.88	-11.99
2	0.181	0.18	54.08	-	54.26	-	64.43	54.43	-10.17	-
3	0.591	0.26	25.76	-	26.02	-	56.00	46.00	-29.98	-
4	0.818	0.28	24.05	-	24.33	-	56.00	46.00	-31.67	-
5	11.094	0.95	27.79	-	28.74	-	60.00	50.00	-31.26	-
6	26.035	1.76	14.91	-	16.67	-	60.00	50.00	-43.33	-

- REMARKS:**
1. Q.P. and AV. are abbreviations of quasi-peak and average individually.
 2. "-": The Quasi-peak reading value also meets average limit and measurement with the average detector is unnecessary.
 3. The emission levels of other frequencies were very low against the limit.
 4. Margin value = Emission level - Limit value
 5. Correction factor = Insertion loss + Cable loss
 6. Emission Level = Correction Factor + Reading Value.

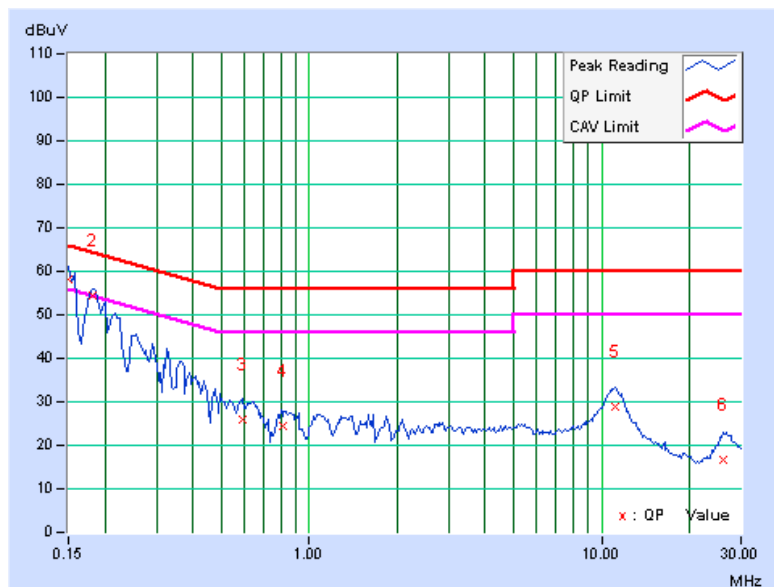



A D T

CHANNEL	Channel 1		
PHASE	Line 2	6dB BANDWIDTH	9kHz

No	Freq. [MHz]	Corr. Factor (dB)	Reading Value		Emission Level		Limit		Margin	
			[dB (uV)]		[dB (uV)]		[dB (uV)]		(dB)	
			Q.P.	AV.	Q.P.	AV.	Q.P.	AV.	Q.P.	AV.
1	0.158	0.19	57.75	46.08	57.94	46.27	65.58	55.58	-7.64	-9.31
2	0.193	0.19	52.24	-	52.43	-	63.91	53.91	-11.48	-
3	1.145	0.33	23.43	-	23.76	-	56.00	46.00	-32.24	-
4	1.930	0.41	23.29	-	23.70	-	56.00	46.00	-32.30	-
5	5.469	0.65	21.33	-	21.98	-	60.00	50.00	-38.02	-
6	10.961	0.84	26.91	-	27.75	-	60.00	50.00	-32.25	-

- REMARKS:**
1. Q.P. and AV. are abbreviations of quasi-peak and average individually.
 2. "-": The Quasi-peak reading value also meets average limit and measurement with the average detector is unnecessary.
 3. The emission levels of other frequencies were very low against the limit.
 4. Margin value = Emission level - Limit value
 5. Correction factor = Insertion loss + Cable loss
 6. Emission Level = Correction Factor + Reading Value.

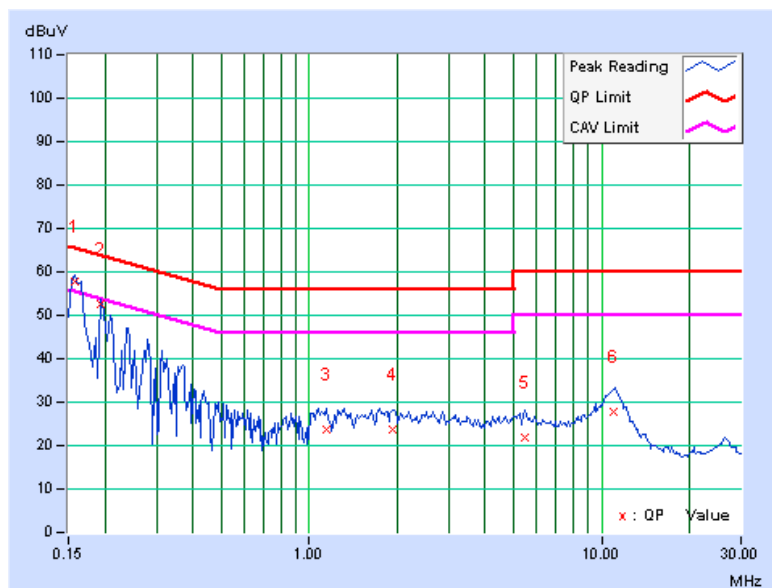



A D T

4.2 RADIATED EMISSION MEASUREMENT

4.2.1 LIMITS OF RADIATED EMISSION MEASUREMENT

Emissions radiated outside of the specified bands, shall be according to the general radiated limits in 15.209 as following:

FREQUENCIES (MHz)	FIELD STRENGTH (microvolts/meter)	MEASUREMENT DISTANCE (meters)
0.009 ~ 0.490	2400/F(kHz)	300
0.490 ~ 1.705	24000/F(kHz)	30
1.705 ~ 30.0	30	30
30 ~ 88	100	3
88 ~ 216	150	3
216 ~ 960	200	3
Above 960	500	3

NOTE:

1. The lower limit shall apply at the transition frequencies.
2. Emission level (dBuV/m) = 20 log Emission level (uV/m).
3. As shown in 15.35(b), for frequencies above 1000MHz, the field strength limits are based on average detector, however, the peak field strength of any emission shall not exceed the maximum permitted average limits, specified above by more than 20dB under any condition of modulation.



A D T

4.2.2 TEST INSTRUMENTS

DESCRIPTION & MANUFACTURER	MODEL NO.	SERIAL NO.	CALIBRATED DATE	CALIBRATED UNTIL
HP Preamplifier	8447D	2432A03504	Mar. 04, 2011	Mar. 03, 2012
HP Preamplifier	8449B	3008A01924	Mar. 04, 2011	Mar. 03, 2012
HP Preamplifier	8449B	3008A01292	Mar. 04, 2011	Mar. 03, 2012
Agilent Spectrum Analyzer	E4446A	MY46180403	Jun. 22, 2011	Jun. 21, 2012
ROHDE & SCHWARZ TEST RECEIVER	ESCS30	838251/021	Oct. 01, 2010	Sep. 30, 2011
Schwarzbeck Antenna	VULB 9168	137	Apr. 12, 2011	Apr. 11, 2012
Schwarzbeck Antenna	VHBA 9123	480	May 06, 2011	May 05, 2012
ADT. Turn Table	TT100	0306	NA	NA
ADT. Tower	AT100	0306	NA	NA
Software	ADT_Radiated_V 7.6.15.9.2	NA	NA	NA
SUHNER RF cable	SF102	CABLE-CH6	Aug. 19, 2011	Aug. 18, 2012
EMCO Horn Antenna	3115	6714	Oct. 26, 2010	Oct. 25, 2011
EMCO Horn Antenna	3115	9312-4192	Apr. 22, 2011	Apr. 21, 2012
Highpass filter Wainwright Instruments	WHK 3.1/18G-10SS	SN 8	NA	NA

- NOTE:** 1. The calibration interval of the above test instruments is 12/24 months. And the calibrations are traceable to NML/ROC and NIST/USA.
2. The horn antenna and HP preamplifier (model: 8449B) are used only for the measurement of emission frequency above 1GHz if tested.
3. The test was performed in Chamber No. 6.
4. The Industry Canada Reference No. IC 7450E-6.
5. The FCC Site Registration No. is 447212.



A D T

4.2.3 TEST PROCEDURES

- a. The EUT was placed on the top of a rotating table 0.8 meters above the ground at a 3 meters semi-anechoic chamber room. The table was rotated 360 degrees to determine the position of the highest radiation.
- b. The EUT was set 3 meters away from the interference-receiving antenna, which was mounted on the top of a variable-height antenna tower.
- c. The antenna is a broadband antenna, and its height is varied from one meter to four meters above the ground to determine the maximum value of the field strength. Both horizontal and vertical polarizations of the antenna are set to make the measurement.
- d. For each suspected emission, the EUT was arranged to its worst case and then the antenna was tuned to heights from 1 meter to 4 meters and the rotatable table was turned from 0 degrees to 360 degrees to find the maximum reading.
- e. The test-receiver system was set to Peak Detect Function and Specified Bandwidth with Maximum Hold Mode.
- f. If the emission level of the EUT in peak mode was lower than the limit specified, then testing could be stopped and the peak values of the EUT would be reported. Otherwise the emissions would be re-tested one by one using peak, quasi-peak or average method as specified and then reported in a data sheet.

NOTE:

1. The resolution bandwidth and video bandwidth of test receiver/spectrum analyzer is 120kHz for Quasi-peak detection at frequency below 1GHz.
2. The resolution bandwidth of test receiver/spectrum analyzer is 100kHz and video bandwidth is 300kHz for Peak detection at frequency above 1GHz.
3. The resolution bandwidth of test receiver/spectrum analyzer is 1MHz and the video bandwidth is 10Hz for Average detection (AV) at frequency above 1GHz.
4. All modes of operation were investigated and the worst-case emissions are reported.

4.2.4 DEVIATION FROM TEST STANDARD

No deviation

4.2.5 TEST SETUP

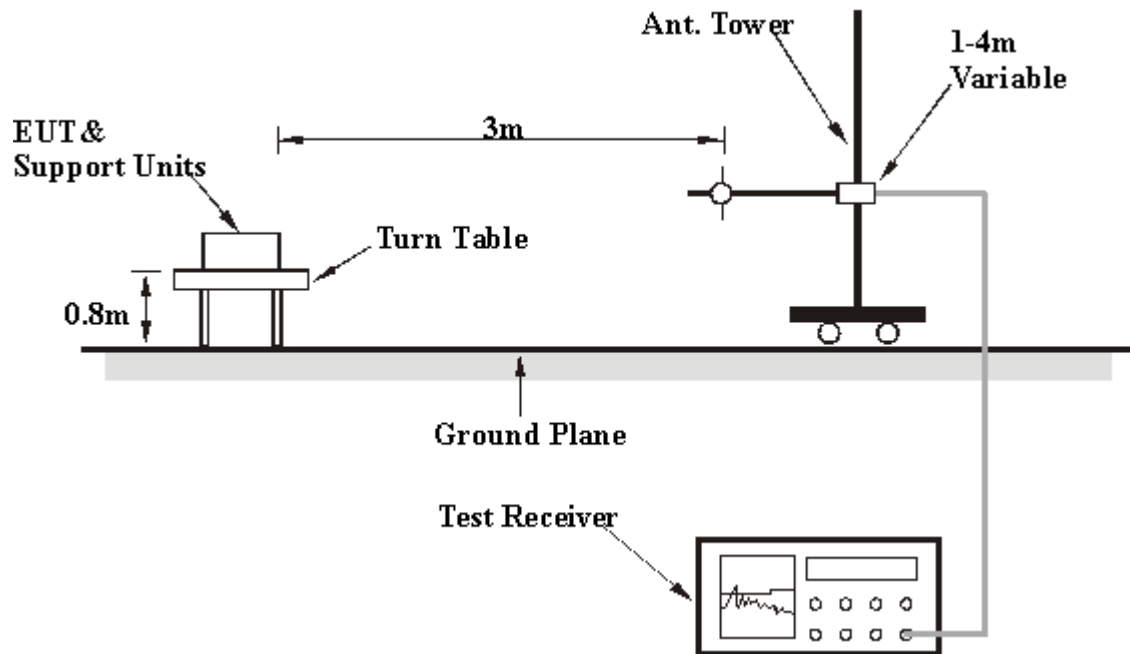

For the actual test configuration, please refer to the attached file (Test Setup Photo).

4.2.6 EUT OPERATING CONDITIONS

Same as item 4.1.6.



A D T

4.2.7 TEST RESULTS

802.11b

EUT TEST CONDITION		MEASUREMENT DETAIL	
CHANNEL	Channel 1	FREQUENCY RANGE	1 ~ 25GHz
INPUT POWER	120Vac, 60Hz	DETECTOR FUNCTION	Peak (PK) Average (AV)
ENVIRONMENTAL CONDITIONS	25deg. C, 68%RH	TESTED BY	Chad Lee

ANTENNA POLARITY & TEST DISTANCE: HORIZONTAL AT 3 M								
NO.	FREQ. (MHz)	EMISSION LEVEL (dBuV/m)	LIMIT (dBuV/m)	MARGIN (dB)	ANTENNA HEIGHT (m)	TABLE ANGLE (Degree)	RAW VALUE (dBuV)	CORRECTION FACTOR (dB/m)
1	2390.00	60.7 PK	74.0	-13.3	1.00 H	240	28.59	32.15
2	2390.00	46.5 AV	54.0	-7.5	1.00 H	240	14.36	32.15
3	*2412.00	115.5 PK			1.00 H	240	83.30	32.24
4	*2412.00	111.6 AV			1.00 H	240	79.36	32.24
5	4824.00	46.6 PK	74.0	-27.4	1.00 H	24	7.92	38.66
6	4824.00	33.9 AV	54.0	-20.1	1.00 H	24	-4.77	38.66
ANTENNA POLARITY & TEST DISTANCE: VERTICAL AT 3 M								
NO.	FREQ. (MHz)	EMISSION LEVEL (dBuV/m)	LIMIT (dBuV/m)	MARGIN (dB)	ANTENNA HEIGHT (m)	TABLE ANGLE (Degree)	RAW VALUE (dBuV)	CORRECTION FACTOR (dB/m)
1	2390.00	56.3 PK	74.0	-17.7	1.00 V	203	24.14	32.15
2	2390.00	46.3 AV	54.0	-7.7	1.00 V	203	14.12	32.15
3	*2412.00	106.3 PK			1.00 V	203	74.07	32.24
4	*2412.00	102.4 AV			1.00 V	203	70.13	32.24
5	4824.00	53.4 PK	74.0	-20.6	1.00 V	267	14.71	38.66
6	4824.00	46.8 AV	54.0	-7.2	1.00 V	267	8.17	38.66

- REMARKS:**
1. Emission level (dBuV/m) = Raw Value (dBuV) + Correction Factor (dB/m).
 2. Correction Factor (dB/m) = Antenna Factor (dB/m) + Cable Factor (dB).
 3. The other emission levels were very low against the limit.
 4. Margin value = Emission level – Limit value.
 5. “ * “: Fundamental frequency.



A D T

EUT TEST CONDITION		MEASUREMENT DETAIL	
CHANNEL	Channel 6	FREQUENCY RANGE	1 ~ 25GHz
INPUT POWER	120Vac, 60Hz	DETECTOR FUNCTION	Peak (PK) Average (AV)
ENVIRONMENTAL CONDITIONS	25deg. C, 68%RH	TESTED BY	Chad Lee

ANTENNA POLARITY & TEST DISTANCE: HORIZONTAL AT 3 M								
NO.	FREQ. (MHz)	EMISSION LEVEL (dBuV/m)	LIMIT (dBuV/m)	MARGIN (dB)	ANTENNA HEIGHT (m)	TABLE ANGLE (Degree)	RAW VALUE (dBuV)	CORRECTION FACTOR (dB/m)
1	*2437.00	114.5 PK			1.00 H	242	82.13	32.33
2	*2437.00	111.4 AV			1.00 H	242	79.05	32.33
3	4874.00	46.7 PK	74.0	-27.3	1.00 H	16	7.94	38.78
4	4874.00	34.0 AV	54.0	-20.1	1.00 H	16	-4.83	38.78
ANTENNA POLARITY & TEST DISTANCE: VERTICAL AT 3 M								
NO.	FREQ. (MHz)	EMISSION LEVEL (dBuV/m)	LIMIT (dBuV/m)	MARGIN (dB)	ANTENNA HEIGHT (m)	TABLE ANGLE (Degree)	RAW VALUE (dBuV)	CORRECTION FACTOR (dB/m)
1	*2437.00	105.4 PK			1.00 V	203	73.08	32.33
2	*2437.00	102.6 AV			1.00 V	203	70.25	32.33
3	4874.00	56.1 PK	74.0	-17.9	1.00 V	283	17.33	38.78
4	4874.00	49.2 AV	54.0	-4.8	1.00 V	283	10.39	38.78

- REMARKS:**
1. Emission level (dBuV/m) = Raw Value (dBuV) + Correction Factor (dB/m).
 2. Correction Factor (dB/m) = Antenna Factor (dB/m) + Cable Factor (dB).
 3. The other emission levels were very low against the limit.
 4. Margin value = Emission level – Limit value.
 5. “ * “: Fundamental frequency.



A D T

EUT TEST CONDITION		MEASUREMENT DETAIL	
CHANNEL	Channel 11	FREQUENCY RANGE	1 ~ 25GHz
INPUT POWER	120Vac, 60Hz	DETECTOR FUNCTION	Peak (PK) Average (AV)
ENVIRONMENTAL CONDITIONS	25deg. C, 68%RH	TESTED BY	Chad Lee

ANTENNA POLARITY & TEST DISTANCE: HORIZONTAL AT 3 M								
NO.	FREQ. (MHz)	EMISSION LEVEL (dBuV/m)	LIMIT (dBuV/m)	MARGIN (dB)	ANTENNA HEIGHT (m)	TABLE ANGLE (Degree)	RAW VALUE (dBuV)	CORRECTION FACTOR (dB/m)
1	*2462.00	113.8 PK			1.37 H	69	81.41	32.43
2	*2462.00	109.8 AV			1.37 H	69	77.40	32.43
3	2483.50	63.9 PK	74.0	-10.1	1.37 H	69	31.40	32.51
4	2483.50	52.4 AV	54.0	-1.7	1.37 H	69	19.84	32.51
5	4924.00	49.0 PK	74.0	-25.0	1.29 H	114	10.09	38.90
6	4924.00	37.5 AV	54.0	-16.5	1.29 H	114	-1.39	38.90
ANTENNA POLARITY & TEST DISTANCE: VERTICAL AT 3 M								
NO.	FREQ. (MHz)	EMISSION LEVEL (dBuV/m)	LIMIT (dBuV/m)	MARGIN (dB)	ANTENNA HEIGHT (m)	TABLE ANGLE (Degree)	RAW VALUE (dBuV)	CORRECTION FACTOR (dB/m)
1	*2462.00	104.7 PK			1.00 V	203	72.29	32.43
2	*2462.00	101.5 AV			1.00 V	203	69.10	32.43
3	2483.50	59.8 PK	74.0	-14.2	1.00 V	203	27.25	32.51
4	2483.50	46.9 AV	54.0	-7.1	1.00 V	203	14.36	32.51
5	4924.00	54.8 PK	74.0	-19.2	1.09 V	276	15.94	38.90
6	4924.00	52.0 AV	54.0	-2.0	1.09 V	276	13.11	38.90

- REMARKS:**
1. Emission level (dBuV/m) = Raw Value (dBuV) + Correction Factor (dB/m).
 2. Correction Factor (dB/m) = Antenna Factor (dB/m) + Cable Factor (dB).
 3. The other emission levels were very low against the limit.
 4. Margin value = Emission level – Limit value.
 5. “ * “: Fundamental frequency.



A D T

802.11g

EUT TEST CONDITION		MEASUREMENT DETAIL	
CHANNEL	Channel 1	FREQUENCY RANGE	1 ~ 25GHz
INPUT POWER	120Vac, 60Hz	DETECTOR FUNCTION	Peak (PK) Average (AV)
ENVIRONMENTAL CONDITIONS	25deg. C, 68%RH	TESTED BY	Chad Lee

ANTENNA POLARITY & TEST DISTANCE: HORIZONTAL AT 3 M								
NO.	FREQ. (MHz)	EMISSION LEVEL (dBuV/m)	LIMIT (dBuV/m)	MARGIN (dB)	ANTENNA HEIGHT (m)	TABLE ANGLE (Degree)	RAW VALUE (dBuV)	CORRECTION FACTOR (dB/m)
1	2390.00	72.4 PK	74.0	-1.6	1.00 H	238	40.22	32.15
2	2390.00	52.6 AV	54.0	-1.4	1.00 H	238	20.43	32.15
3	*2412.00	115.7 PK			1.00 H	238	83.42	32.24
4	*2412.00	105.3 AV			1.00 H	238	73.03	32.24
5	4824.00	58.4 PK	74.0	-15.6	1.00 H	233	19.74	38.66
6	4824.00	43.8 AV	54.0	-10.2	1.00 H	233	5.14	38.66
ANTENNA POLARITY & TEST DISTANCE: VERTICAL AT 3 M								
NO.	FREQ. (MHz)	EMISSION LEVEL (dBuV/m)	LIMIT (dBuV/m)	MARGIN (dB)	ANTENNA HEIGHT (m)	TABLE ANGLE (Degree)	RAW VALUE (dBuV)	CORRECTION FACTOR (dB/m)
1	2390.00	69.6 PK	74.0	-4.4	1.00 V	148	37.45	32.15
2	2390.00	51.6 AV	54.0	-2.4	1.00 V	148	19.45	32.15
3	*2412.00	105.6 PK			1.00 V	148	73.36	32.24
4	*2412.00	96.6 AV			1.00 V	148	64.36	32.24
5	4824.00	56.3 PK	74.0	-17.7	1.00 V	168	17.64	38.66
6	4824.00	42.1 AV	54.0	-11.9	1.00 V	168	3.44	38.66

- REMARKS:**
1. Emission level (dBuV/m) = Raw Value (dBuV) + Correction Factor (dB/m).
 2. Correction Factor (dB/m) = Antenna Factor (dB/m) + Cable Factor (dB).
 3. The other emission levels were very low against the limit.
 4. Margin value = Emission level – Limit value.
 5. “ * “: Fundamental frequency.



A D T

EUT TEST CONDITION		MEASUREMENT DETAIL	
CHANNEL	Channel 6	FREQUENCY RANGE	1 ~ 25GHz
INPUT POWER	120Vac, 60Hz	DETECTOR FUNCTION	Peak (PK) Average (AV)
ENVIRONMENTAL CONDITIONS	25deg. C, 68%RH	TESTED BY	Chad Lee

ANTENNA POLARITY & TEST DISTANCE: HORIZONTAL AT 3 M								
NO.	FREQ. (MHz)	EMISSION LEVEL (dBuV/m)	LIMIT (dBuV/m)	MARGIN (dB)	ANTENNA HEIGHT (m)	TABLE ANGLE (Degree)	RAW VALUE (dBuV)	CORRECTION FACTOR (dB/m)
1	*2437.00	116.0 PK			1.00 H	240	83.64	32.33
2	*2437.00	105.4 AV			1.00 H	240	73.03	32.33
3	4874.00	52.9 PK	74.0	-21.1	1.00 H	6	14.12	38.78
4	4874.00	34.1 AV	54.0	-19.9	1.00 H	6	-4.67	38.78
ANTENNA POLARITY & TEST DISTANCE: VERTICAL AT 3 M								
NO.	FREQ. (MHz)	EMISSION LEVEL (dBuV/m)	LIMIT (dBuV/m)	MARGIN (dB)	ANTENNA HEIGHT (m)	TABLE ANGLE (Degree)	RAW VALUE (dBuV)	CORRECTION FACTOR (dB/m)
1	*2437.00	106.7 PK			1.00 V	203	74.36	32.33
2	*2437.00	97.1 AV			1.00 V	203	64.73	32.33
3	4874.00	51.9 PK	74.0	-22.1	1.00 V	284	13.13	38.78
4	4874.00	36.5 AV	54.0	-17.5	1.00 V	284	-2.25	38.78

- REMARKS:**
1. Emission level (dBuV/m) = Raw Value (dBuV) + Correction Factor (dB/m).
 2. Correction Factor (dB/m) = Antenna Factor (dB/m) + Cable Factor (dB).
 3. The other emission levels were very low against the limit.
 4. Margin value = Emission level – Limit value.
 5. “ * “: Fundamental frequency.



A D T

EUT TEST CONDITION		MEASUREMENT DETAIL	
CHANNEL	Channel 11	FREQUENCY RANGE	1 ~ 25GHz
INPUT POWER	120Vac, 60Hz	DETECTOR FUNCTION	Peak (PK) Average (AV)
ENVIRONMENTAL CONDITIONS	25deg. C, 68%RH	TESTED BY	Chad Lee

ANTENNA POLARITY & TEST DISTANCE: HORIZONTAL AT 3 M								
NO.	FREQ. (MHz)	EMISSION LEVEL (dBuV/m)	LIMIT (dBuV/m)	MARGIN (dB)	ANTENNA HEIGHT (m)	TABLE ANGLE (Degree)	RAW VALUE (dBuV)	CORRECTION FACTOR (dB/m)
1	*2462.00	114.6 PK			1.00 H	243	82.17	32.43
2	*2462.00	104.5 AV			1.00 H	243	72.03	32.43
3	2483.50	71.1 PK	74.0	-3.0	1.00 H	243	38.54	32.51
4	2483.50	52.5 AV	54.0	-1.5	1.00 H	243	20.00	32.51
5	4924.00	54.9 PK	74.0	-19.1	1.05 H	226	16.00	38.90
6	4924.00	38.9 AV	54.0	-15.1	1.05 H	226	0.00	38.90
ANTENNA POLARITY & TEST DISTANCE: VERTICAL AT 3 M								
NO.	FREQ. (MHz)	EMISSION LEVEL (dBuV/m)	LIMIT (dBuV/m)	MARGIN (dB)	ANTENNA HEIGHT (m)	TABLE ANGLE (Degree)	RAW VALUE (dBuV)	CORRECTION FACTOR (dB/m)
1	*2462.00	104.3 PK			1.01 V	150	71.87	32.43
2	*2462.00	94.4 AV			1.01 V	150	61.97	32.43
3	2483.50	65.4 PK	74.0	-8.6	1.01 V	150	32.89	32.51
4	2483.50	49.2 AV	54.0	-4.8	1.01 V	150	16.69	32.51
5	4924.00	53.9 PK	74.0	-20.1	1.07 V	175	15.00	38.90
6	4924.00	39.5 AV	54.0	-14.5	1.07 V	175	0.60	38.90

- REMARKS:**
1. Emission level (dBuV/m) = Raw Value (dBuV) + Correction Factor (dB/m).
 2. Correction Factor (dB/m) = Antenna Factor (dB/m) + Cable Factor (dB).
 3. The other emission levels were very low against the limit.
 4. Margin value = Emission level – Limit value.
 5. “ * “: Fundamental frequency.



A D T

802.11n (20MHz)

EUT TEST CONDITION		MEASUREMENT DETAIL	
CHANNEL	Channel 1	FREQUENCY RANGE	1 ~ 25GHz
INPUT POWER	120Vac, 60Hz	DETECTOR FUNCTION	Peak (PK) Average (AV)
ENVIRONMENTAL CONDITIONS	25deg. C, 68%RH	TESTED BY	Chad Lee

ANTENNA POLARITY & TEST DISTANCE: HORIZONTAL AT 3 M								
NO.	FREQ. (MHz)	EMISSION LEVEL (dBuV/m)	LIMIT (dBuV/m)	MARGIN (dB)	ANTENNA HEIGHT (m)	TABLE ANGLE (Degree)	RAW VALUE (dBuV)	CORRECTION FACTOR (dB/m)
1	2390.00	72.1 PK	74.0	-1.9	1.00 H	238	39.94	32.15
2	2390.00	52.8 AV	54.0	-1.2	1.00 H	238	20.61	32.15
3	*2412.00	113.6 PK			1.00 H	238	81.38	32.24
4	*2412.00	103.3 AV			1.00 H	238	71.09	32.24
5	4824.00	57.6 PK	74.0	-16.4	1.30 H	238	18.94	38.66
6	4824.00	42.0 AV	54.0	-12.0	1.30 H	238	3.34	38.66
ANTENNA POLARITY & TEST DISTANCE: VERTICAL AT 3 M								
NO.	FREQ. (MHz)	EMISSION LEVEL (dBuV/m)	LIMIT (dBuV/m)	MARGIN (dB)	ANTENNA HEIGHT (m)	TABLE ANGLE (Degree)	RAW VALUE (dBuV)	CORRECTION FACTOR (dB/m)
1	2390.00	70.9 PK	74.0	-3.1	1.11 V	256	38.75	32.15
2	2390.00	51.2 AV	54.0	-2.8	1.11 V	256	19.05	32.15
3	*2412.00	105.4 PK			1.11 V	256	73.16	32.24
4	*2412.00	95.0 AV			1.11 V	256	62.76	32.24
5	4824.00	56.1 PK	74.0	-17.9	1.08 V	195	17.44	38.66
6	4824.00	44.4 AV	54.0	-9.6	1.08 V	195	5.74	38.66

- REMARKS:**
1. Emission level (dBuV/m) = Raw Value (dBuV) + Correction Factor (dB/m).
 2. Correction Factor (dB/m) = Antenna Factor (dB/m) + Cable Factor (dB).
 3. The other emission levels were very low against the limit.
 4. Margin value = Emission level – Limit value.
 5. “ * “: Fundamental frequency.



A D T

EUT TEST CONDITION		MEASUREMENT DETAIL	
CHANNEL	Channel 6	FREQUENCY RANGE	1 ~ 25GHz
INPUT POWER	120Vac, 60Hz	DETECTOR FUNCTION	Peak (PK) Average (AV)
ENVIRONMENTAL CONDITIONS	25deg. C, 68%RH	TESTED BY	Chad Lee

ANTENNA POLARITY & TEST DISTANCE: HORIZONTAL AT 3 M								
NO.	FREQ. (MHz)	EMISSION LEVEL (dBuV/m)	LIMIT (dBuV/m)	MARGIN (dB)	ANTENNA HEIGHT (m)	TABLE ANGLE (Degree)	RAW VALUE (dBuV)	CORRECTION FACTOR (dB/m)
1	*2437.00	115.5 PK			1.00 H	241	83.20	32.33
2	*2437.00	105.4 AV			1.00 H	241	73.06	32.33
3	4874.00	54.0 PK	74.0	-20.0	1.00 H	6	15.23	38.78
4	4874.00	36.9 AV	54.0	-17.1	1.00 H	6	-1.85	38.78
ANTENNA POLARITY & TEST DISTANCE: VERTICAL AT 3 M								
NO.	FREQ. (MHz)	EMISSION LEVEL (dBuV/m)	LIMIT (dBuV/m)	MARGIN (dB)	ANTENNA HEIGHT (m)	TABLE ANGLE (Degree)	RAW VALUE (dBuV)	CORRECTION FACTOR (dB/m)
1	*2437.00	108.0 PK			1.00 V	202	75.62	32.33
2	*2437.00	97.4 AV			1.00 V	202	65.03	32.33
3	4874.00	52.5 PK	74.0	-21.6	1.00 V	278	13.67	38.78
4	4874.00	37.9 AV	54.0	-16.1	1.00 V	278	-0.84	38.78

- REMARKS:**
1. Emission level (dBuV/m) = Raw Value (dBuV) + Correction Factor (dB/m).
 2. Correction Factor (dB/m) = Antenna Factor (dB/m) + Cable Factor (dB).
 3. The other emission levels were very low against the limit.
 4. Margin value = Emission level – Limit value.
 5. “ * “: Fundamental frequency.



A D T

EUT TEST CONDITION		MEASUREMENT DETAIL	
CHANNEL	Channel 11	FREQUENCY RANGE	1 ~ 25GHz
INPUT POWER	120Vac, 60Hz	DETECTOR FUNCTION	Peak (PK) Average (AV)
ENVIRONMENTAL CONDITIONS	25deg. C, 68%RH	TESTED BY	Chad Lee

ANTENNA POLARITY & TEST DISTANCE: HORIZONTAL AT 3 M								
NO.	FREQ. (MHz)	EMISSION LEVEL (dBuV/m)	LIMIT (dBuV/m)	MARGIN (dB)	ANTENNA HEIGHT (m)	TABLE ANGLE (Degree)	RAW VALUE (dBuV)	CORRECTION FACTOR (dB/m)
1	*2462.00	115.7 PK			1.00 H	240	83.27	32.43
2	*2462.00	105.5 AV			1.00 H	240	73.08	32.43
3	2483.50	67.7 PK	74.0	-6.3	1.00 H	240	35.21	32.51
4	2483.50	53.0 AV	54.0	-1.0	1.00 H	240	20.47	32.51
5	4924.00	58.4 PK	74.0	-15.6	1.09 H	116	19.50	38.90
6	4924.00	42.8 AV	54.0	-11.2	1.09 H	116	3.90	38.90
ANTENNA POLARITY & TEST DISTANCE: VERTICAL AT 3 M								
NO.	FREQ. (MHz)	EMISSION LEVEL (dBuV/m)	LIMIT (dBuV/m)	MARGIN (dB)	ANTENNA HEIGHT (m)	TABLE ANGLE (Degree)	RAW VALUE (dBuV)	CORRECTION FACTOR (dB/m)
1	*2462.00	106.6 PK			1.10 V	258	74.17	32.43
2	*2462.00	96.1 AV			1.10 V	258	63.67	32.43
3	2483.50	70.2 PK	74.0	-3.8	1.10 V	258	37.69	32.51
4	2483.50	51.0 AV	54.0	-3.0	1.10 V	258	18.49	32.51
5	4924.00	56.4 PK	74.0	-17.6	1.05 V	113	17.50	38.90
6	4924.00	44.6 AV	54.0	-9.4	1.05 V	113	5.70	38.90

- REMARKS:**
1. Emission level (dBuV/m) = Raw Value (dBuV) + Correction Factor (dB/m).
 2. Correction Factor (dB/m) = Antenna Factor (dB/m) + Cable Factor (dB).
 3. The other emission levels were very low against the limit.
 4. Margin value = Emission level – Limit value.
 5. “ * “: Fundamental frequency.



A D T

802.11n (40MHz)

EUT TEST CONDITION		MEASUREMENT DETAIL	
CHANNEL	Channel 1	FREQUENCY RANGE	1 ~ 25GHz
INPUT POWER	120Vac, 60Hz	DETECTOR FUNCTION	Peak (PK) Average (AV)
ENVIRONMENTAL CONDITIONS	25deg. C, 68%RH	TESTED BY	Chad Lee

ANTENNA POLARITY & TEST DISTANCE: HORIZONTAL AT 3 M								
NO.	FREQ. (MHz)	EMISSION LEVEL (dBuV/m)	LIMIT (dBuV/m)	MARGIN (dB)	ANTENNA HEIGHT (m)	TABLE ANGLE (Degree)	RAW VALUE (dBuV)	CORRECTION FACTOR (dB/m)
1	2390.00	72.5 PK	74.0	-1.5	1.00 H	238	40.31	32.15
2	2390.00	52.4 AV	54.0	-1.6	1.00 H	238	20.21	32.15
3	*2422.00	110.8 PK			1.00 H	238	78.53	32.27
4	*2422.00	96.7 AV			1.00 H	238	64.43	32.27
5	4844.00	51.6 PK	74.0	-22.4	1.09 H	55	12.91	38.71
6	4844.00	38.9 AV	54.0	-15.1	1.09 H	55	0.19	38.71
ANTENNA POLARITY & TEST DISTANCE: VERTICAL AT 3 M								
NO.	FREQ. (MHz)	EMISSION LEVEL (dBuV/m)	LIMIT (dBuV/m)	MARGIN (dB)	ANTENNA HEIGHT (m)	TABLE ANGLE (Degree)	RAW VALUE (dBuV)	CORRECTION FACTOR (dB/m)
1	2390.00	62.3 PK	74.0	-11.7	1.00 V	203	30.16	32.15
2	2390.00	47.5 AV	54.0	-6.5	1.00 V	203	15.39	32.15
3	*2422.00	103.0 PK			1.00 V	203	70.77	32.27
4	*2422.00	88.7 AV			1.00 V	203	56.45	32.27
5	4844.00	49.8 PK	74.0	-24.2	1.00 V	23	11.12	38.71
6	4844.00	36.2 AV	54.0	-17.8	1.00 V	23	-2.47	38.71

- REMARKS:**
1. Emission level (dBuV/m) = Raw Value (dBuV) + Correction Factor (dB/m).
 2. Correction Factor (dB/m) = Antenna Factor (dB/m) + Cable Factor (dB).
 3. The other emission levels were very low against the limit.
 4. Margin value = Emission level – Limit value.
 5. “ * “: Fundamental frequency.



A D T

EUT TEST CONDITION		MEASUREMENT DETAIL	
CHANNEL	Channel 4	FREQUENCY RANGE	1 ~ 25GHz
INPUT POWER	120Vac, 60Hz	DETECTOR FUNCTION	Peak (PK) Average (AV)
ENVIRONMENTAL CONDITIONS	25deg. C, 68%RH	TESTED BY	Chad Lee

ANTENNA POLARITY & TEST DISTANCE: HORIZONTAL AT 3 M								
NO.	FREQ. (MHz)	EMISSION LEVEL (dBuV/m)	LIMIT (dBuV/m)	MARGIN (dB)	ANTENNA HEIGHT (m)	TABLE ANGLE (Degree)	RAW VALUE (dBuV)	CORRECTION FACTOR (dB/m)
1	*2437.00	112.5 PK			1.00 H	293	80.15	32.33
2	*2437.00	98.4 AV			1.00 H	293	66.03	32.33
3	4874.00	51.3 PK	74.0	-22.7	1.00 H	142	12.55	38.78
4	4874.00	38.5 AV	54.0	-15.5	1.00 H	142	-0.24	38.78
ANTENNA POLARITY & TEST DISTANCE: VERTICAL AT 3 M								
NO.	FREQ. (MHz)	EMISSION LEVEL (dBuV/m)	LIMIT (dBuV/m)	MARGIN (dB)	ANTENNA HEIGHT (m)	TABLE ANGLE (Degree)	RAW VALUE (dBuV)	CORRECTION FACTOR (dB/m)
1	*2437.00	104.2 PK			1.00 V	203	71.83	32.33
2	*2437.00	89.7 AV			1.00 V	203	57.36	32.33
3	4874.00	49.3 PK	74.0	-24.7	1.00 V	19	10.48	38.78
4	4874.00	36.2 AV	54.0	-17.8	1.00 V	19	-2.60	38.78

- REMARKS:**
1. Emission level (dBuV/m) = Raw Value (dBuV) + Correction Factor (dB/m).
 2. Correction Factor (dB/m) = Antenna Factor (dB/m) + Cable Factor (dB).
 3. The other emission levels were very low against the limit.
 4. Margin value = Emission level – Limit value.
 5. “ * “: Fundamental frequency.



A D T

EUT TEST CONDITION		MEASUREMENT DETAIL	
CHANNEL	Channel 7	FREQUENCY RANGE	1 ~ 25GHz
INPUT POWER	120Vac, 60Hz	DETECTOR FUNCTION	Peak (PK) Average (AV)
ENVIRONMENTAL CONDITIONS	25deg. C, 68%RH	TESTED BY	Chad Lee

ANTENNA POLARITY & TEST DISTANCE: HORIZONTAL AT 3 M								
NO.	FREQ. (MHz)	EMISSION LEVEL (dBuV/m)	LIMIT (dBuV/m)	MARGIN (dB)	ANTENNA HEIGHT (m)	TABLE ANGLE (Degree)	RAW VALUE (dBuV)	CORRECTION FACTOR (dB/m)
1	*2452.00	112.0 PK			1.00 H	238	79.65	32.39
2	*2452.00	97.8 AV			1.00 H	238	65.36	32.39
3	2483.50	72.7 PK	74.0	-1.3	1.00 H	238	40.22	32.51
4	2483.50	52.7 AV	54.0	-1.3	1.00 H	238	20.15	32.51
5	4904.00	51.6 PK	74.0	-22.5	1.00 H	42	12.69	38.86
6	4904.00	38.5 AV	54.0	-15.5	1.00 H	42	-0.38	38.86
ANTENNA POLARITY & TEST DISTANCE: VERTICAL AT 3 M								
NO.	FREQ. (MHz)	EMISSION LEVEL (dBuV/m)	LIMIT (dBuV/m)	MARGIN (dB)	ANTENNA HEIGHT (m)	TABLE ANGLE (Degree)	RAW VALUE (dBuV)	CORRECTION FACTOR (dB/m)
1	*2452.00	104.3 PK			1.00 V	209	71.86	32.39
2	*2452.00	90.0 AV			1.00 V	209	57.62	32.39
3	2483.50	63.9 PK	74.0	-10.1	1.00 V	209	31.43	32.51
4	2483.50	49.0 AV	54.0	-5.0	1.00 V	209	16.45	32.51
5	4904.00	49.7 PK	74.0	-24.3	1.00 V	159	10.88	38.86
6	4904.00	36.2 AV	54.0	-17.8	1.00 V	159	-2.62	38.86

- REMARKS:**
1. Emission level (dBuV/m) = Raw Value (dBuV) + Correction Factor (dB/m).
 2. Correction Factor (dB/m) = Antenna Factor (dB/m) + Cable Factor (dB).
 3. The other emission levels were very low against the limit.
 4. Margin value = Emission level – Limit value.
 5. “ * “: Fundamental frequency.



A D T

BELOW 1GHz WORST-CASE DATA : 802.11g

EUT TEST CONDITION		MEASUREMENT DETAIL	
CHANNEL	Channel 1	FREQUENCY RANGE	Below 1000MHz
INPUT POWER	120Vac, 60Hz	DETECTOR FUNCTION	Quasi-Peak
ENVIRONMENTAL CONDITIONS	26deg. C, 65%RH	TESTED BY	Chad Lee

ANTENNA POLARITY & TEST DISTANCE: HORIZONTAL AT 3 M								
NO.	FREQ. (MHz)	EMISSION LEVEL (dBuV/m)	LIMIT (dBuV/m)	MARGIN (dB)	ANTENNA HEIGHT (m)	TABLE ANGLE (Degree)	RAW VALUE (dBuV)	CORRECTION FACTOR (dB/m)
1	101.01	35.2 QP	43.5	-8.3	1.42 H	109	25.56	9.62
2	264.03	39.0 QP	46.0	-7.1	1.00 H	127	24.82	14.13
3	670.75	37.1 QP	46.0	-8.9	1.61 H	22	13.12	23.97
4	740.15	34.6 QP	46.0	-11.4	1.30 H	358	9.41	25.18
5	924.14	37.3 QP	46.0	-8.7	1.46 H	61	9.21	28.10
6	938.67	37.7 QP	46.0	-8.3	1.50 H	67	9.44	28.29

ANTENNA POLARITY & TEST DISTANCE: VERTICAL AT 3 M								
NO.	FREQ. (MHz)	EMISSION LEVEL (dBuV/m)	LIMIT (dBuV/m)	MARGIN (dB)	ANTENNA HEIGHT (m)	TABLE ANGLE (Degree)	RAW VALUE (dBuV)	CORRECTION FACTOR (dB/m)
1	50.98	34.6 QP	40.0	-5.4	1.00 V	79	20.82	13.82
2	76.81	32.3 QP	40.0	-7.7	1.00 V	10	21.33	11.00
3	101.01	34.1 QP	43.5	-9.4	1.50 V	28	24.47	9.62
4	264.03	37.5 QP	46.0	-8.6	1.50 V	190	23.32	14.13
5	924.14	33.4 QP	46.0	-12.6	1.00 V	223	5.34	28.10
6	938.67	35.0 QP	46.0	-11.0	1.00 V	226	6.70	28.29

- REMARKS:**
1. Emission level (dBuV/m) = Raw Value (dBuV) + Correction Factor (dB/m).
 2. Correction Factor (dB/m) = Antenna Factor (dB/m) + Cable Factor (dB).
 3. The other emission levels were very low against the limit.
 4. Margin value = Emission level – Limit value.



A D T

4.3 6dB BANDWIDTH MEASUREMENT

4.3.1 LIMITS OF 6dB BANDWIDTH MEASUREMENT

The minimum of 6dB Bandwidth Measurement is 0.5 MHz.

4.3.2 TEST INSTRUMENTS

DESCRIPTION & MANUFACTURER	MODEL NO.	SERIAL NO.	DATE OF CALIBRATION	DUE DATE OF CALIBRATION
R&S SPECTRUM ANALYZER	FSP40	100036	Apr. 29, 2011	Apr. 28, 2012

NOTE: The calibration interval of the above test instruments is 12 months and the calibrations are traceable to NML/ROC and NIST/USA.

4.3.3 TEST PROCEDURE

The transmitter output was connected to the spectrum analyzer through an attenuator. The bandwidth of the fundamental frequency was measured by spectrum analyzer with 100kHz RBW and 300kHz VBW. The 6dB bandwidth is defined as the total spectrum the power of which is higher than peak power minus 6dB.

4.3.4 DEVIATION FROM TEST STANDARD

No deviation.



4.3.5 TEST SETUP

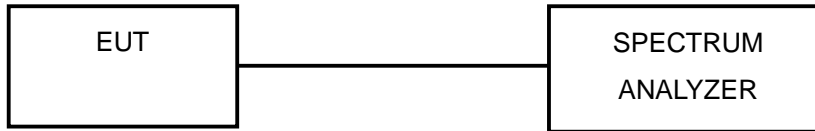

4.3.6 EUT OPERATING CONDITIONS

The software provided by client to enable the EUT under transmission condition continuously at lowest, middle and highest channel frequencies individually.



A D T

802.11g

CHANNEL	CHANNEL FREQUENCY (MHz)	6dB BANDWIDTH (MHz)	MINIMUM LIMIT (MHz)	PASS / FAIL
1	2412	16.59	0.5	PASS
6	2437	16.60	0.5	PASS
11	2462	16.55	0.5	PASS

CH 6

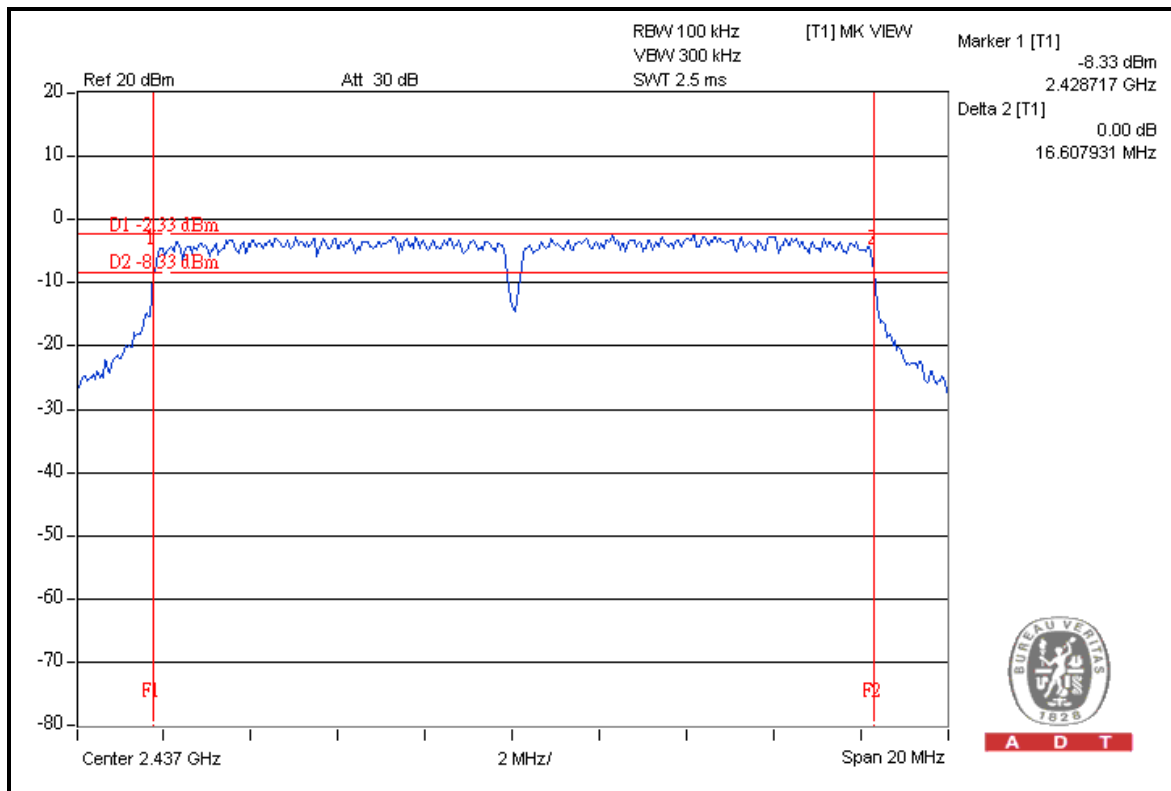



A D T

802.11n (20MHz)

CHANNEL	CHANNEL FREQUENCY (MHz)	6dB BANDWIDTH (MHz)		MINIMUM LIMIT (MHz)	PASS / FAIL
		Ant 1	Ant 2		
1	2412	17.82	17.75	0.5	PASS
6	2437	17.84	17.73	0.5	PASS
11	2462	17.85	17.71	0.5	PASS

FOR Ant 1: CH 11

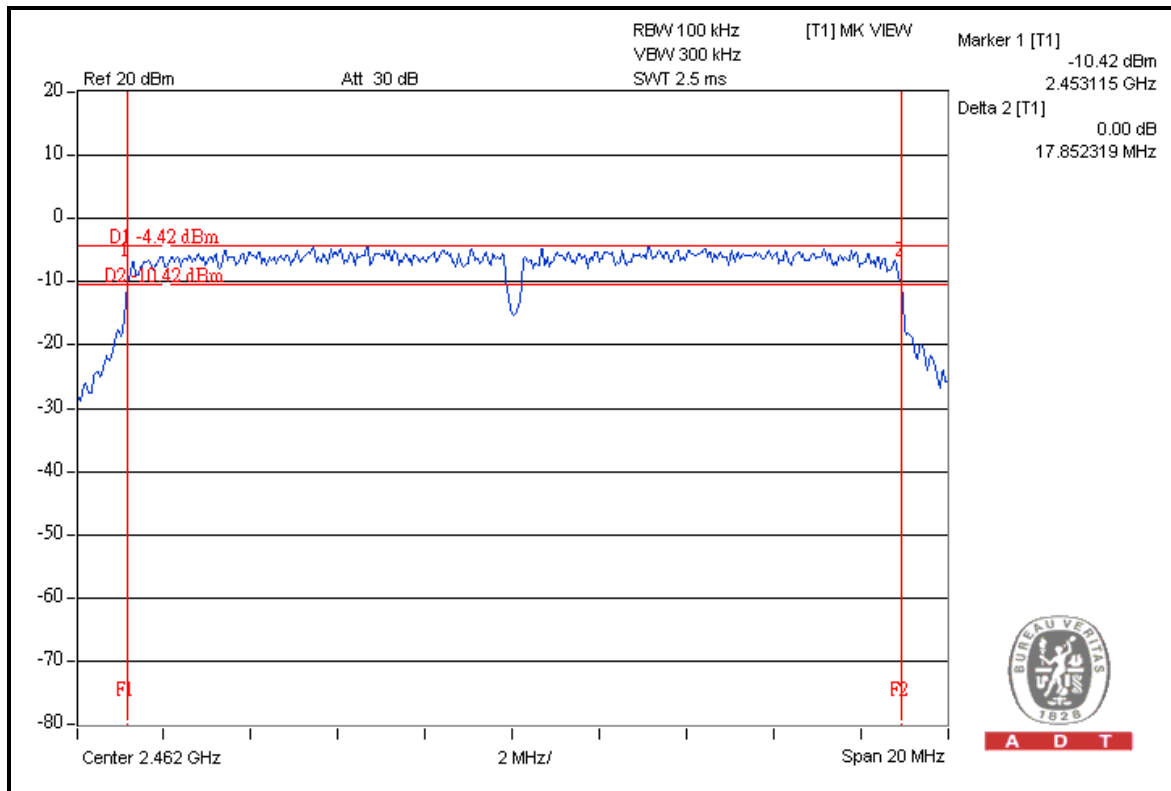



A D T

802.11n (40MHz)

CHANNEL	CHANNEL FREQUENCY (MHz)	6dB BANDWIDTH (MHz)		MINIMUM LIMIT (MHz)	PASS / FAIL
		Ant 1	Ant 2		
1	2422	36.46	36.47	0.5	PASS
4	2437	36.49	36.47	0.5	PASS
7	2452	36.54	36.50	0.5	PASS

FOR Ant 1: CH 7

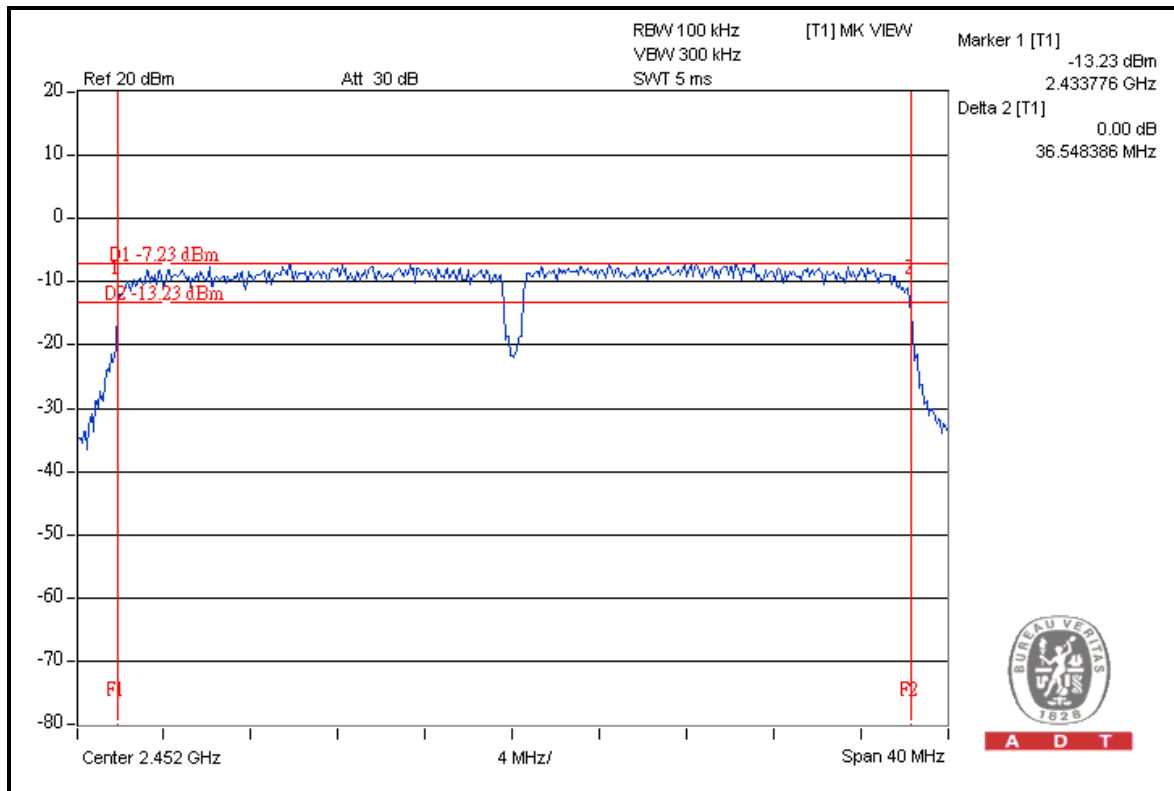



A D T

4.4 MAXIMUM OUTPUT POWER

4.4.1 LIMITS OF MAXIMUM OUTPUT POWER MEASUREMENT

The Maximum Output Power Measurement is 30dBm.

4.4.2 INSTRUMENTS

DESCRIPTION & MANUFACTURER	MODEL NO.	SERIAL NO.	DATE OF CALIBRATION	DUE DATE OF CALIBRATION
Anritsu Power Sensor	MA2411B	0738404	Apr. 26, 2011	Apr. 25, 2012
Anritsu Power Meter	ML2495A	0842014	Apr. 26, 2011	Apr. 25, 2012

Note:

1. The calibration interval of the above test instruments is 12 months and the calibrations are traceable to NML/ROC and NIST/USA.
2. Measurement Bandwidth of ML2495A is 65MHz greater than 6dB bandwidth of emission.

4.4.3 TEST PROCEDURES

A power sensor was used on the output port of the EUT. A power meter was used to read the response of the power sensor. Record the power level.

4.4.4 DEVIATION FROM TEST STANDARD

No deviation.

4.4.5 TEST SETUP

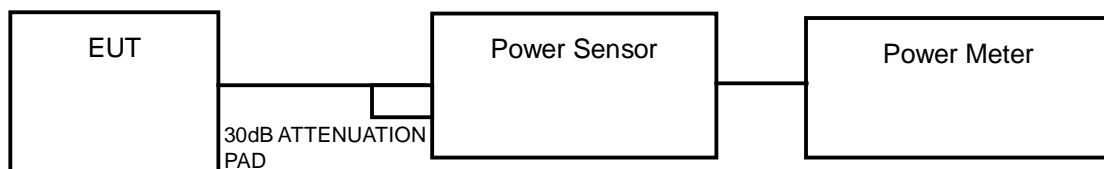

4.4.6 EUT OPERATING CONDITIONS

Same as Item 4.3.6.



4.4.7 TEST RESULTS

802.11b

CHAN.	CHAN. FREQ. (MHz)	POWER OUTPUT (dBm)	POWER OUTPUT (mW)	POWER LIMIT (dBm)	PASS / FAIL
1	2412	17.4	55.0	30	PASS
6	2437	17.9	61.7	30	PASS
11	2462	16.6	45.7	30	PASS

802.11g

CHAN.	CHAN. FREQ. (MHz)	POWER OUTPUT (dBm)	POWER OUTPUT (mW)	POWER LIMIT (dBm)	PASS / FAIL
1	2412	23.3	213.8	30	PASS
6	2437	23.8	239.9	30	PASS
11	2462	21.9	154.9	30	PASS

802.11n (20MHz)

CHAN.	CHAN. FREQ. (MHz)	PEAK POWER OUTPUT (dBm)		TOTAL PEAK POWER (mW)	TOTAL PEAK POWER (dBm)	POWER LIMIT (dBm)	PASS / FAIL
		Ant 1	Ant 2				
1	2412	21.2	20.8	252.1	21.0	30	PASS
6	2437	21.7	21.2	279.7	24.5	30	PASS
11	2462	21.7	20.8	268.1	24.3	30	PASS

802.11n (40MHz)

CHAN.	CHAN. FREQ. (MHz)	PEAK POWER OUTPUT (dBm)		TOTAL PEAK POWER (mW)	TOTAL PEAK POWER (dBm)	POWER LIMIT (dBm)	PASS / FAIL
		Ant 1	Ant 2				
1	2422	20.1	19.5	191.5	22.8	30	PASS
4	2437	20.6	19.8	210.3	23.2	30	PASS
7	2452	20.7	19.4	204.6	23.1	30	PASS



A D T

4.5 POWER SPECTRAL DENSITY MEASUREMENT

4.5.1 LIMITS OF POWER SPECTRAL DENSITY MEASUREMENT

The Maximum of Power Spectral Density Measurement is 8dBm.

4.5.2 TEST INSTRUMENTS

DESCRIPTION & MANUFACTURER	MODEL NO.	SERIAL NO.	DATE OF CALIBRATION	DUE DATE OF CALIBRATION
R&S SPECTRUM ANALYZER	FSP40	100036	Apr. 29, 2011	Apr. 28, 2012

NOTE: The calibration interval of the above test instruments is 12 months and the calibrations are traceable to NML/ROC and NIST/USA.

4.5.3 TEST PROCEDURE

The transmitter output was connected to the spectrum analyzer through an attenuator, the bandwidth of the fundamental frequency was measured with the spectrum analyzer using 3kHz RBW and 30kHz VBW, set sweep time = span/3kHz. The power spectral density was measured and recorded.

The sweep time is allowed to be longer than span/3kHz for a full response of the mixer in the spectrum analyzer.

Follow method 2 of KDB 662911 D01 Multiple Transmitter Output v01 to calculate total power density of 2 TX port.



A D T

4.5.4 DEVIATION FROM TEST STANDARD

No deviation.

4.5.5 TEST SETUP

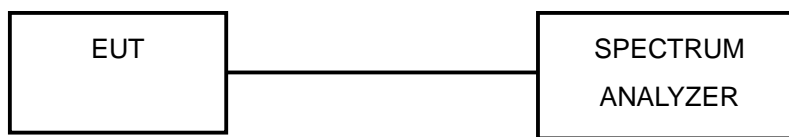

4.5.6 EUT OPERATING CONDITION

Same as Item 4.3.6



A D T

4.5.7 TEST RESULTS

802.11b

CHANNEL	CHAN. FREQ. (MHz)	RF POWER LEVEL IN 3kHz BW (dBm)	MAX. LIMIT (dBm)	PASS / FAIL
1	2412	-16.9	8	PASS
6	2437	-16.5	8	PASS
11	2462	-18.5	8	PASS

CH 6

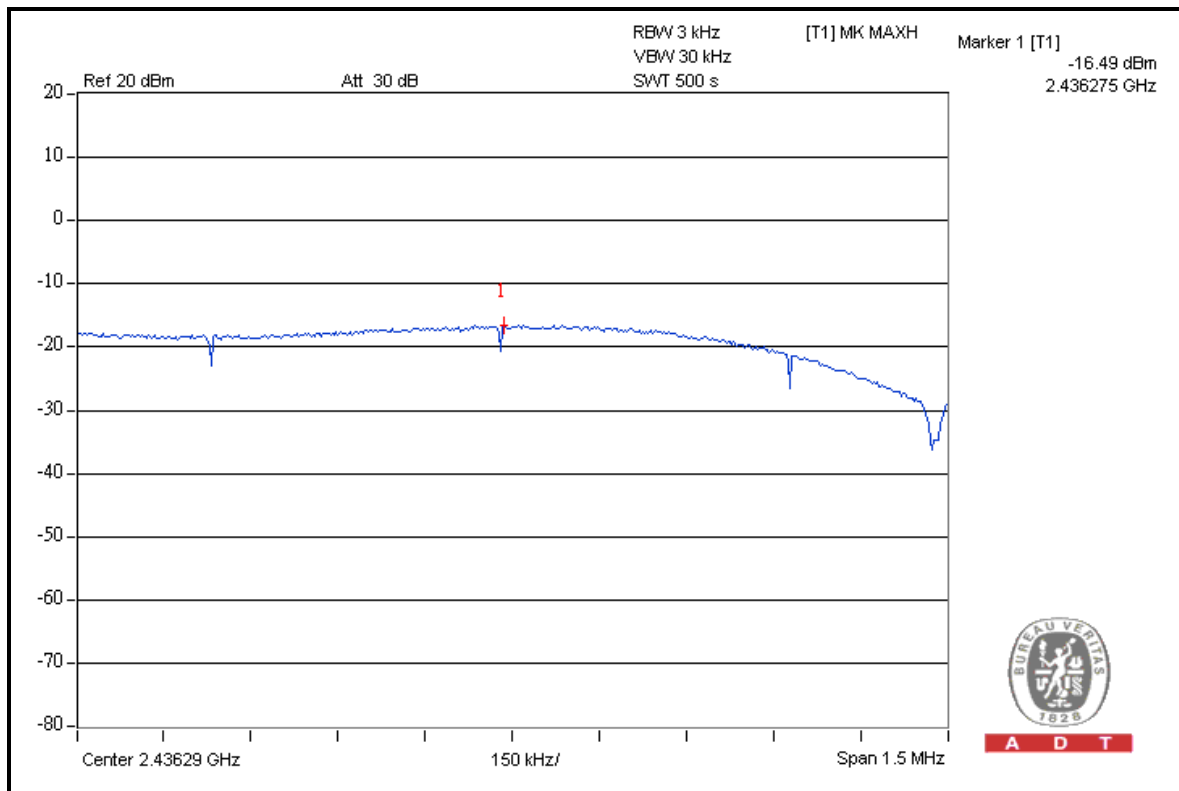

A D T



A D T

802.11g

CHANNEL	CHAN. FREQ. (MHz)	RF POWER LEVEL IN 3kHz BW (dBm)	MAX. LIMIT (dBm)	PASS / FAIL
1	2412	-17.1	8	PASS
6	2437	-16.6	8	PASS
11	2462	-18.4	8	PASS

CH 6

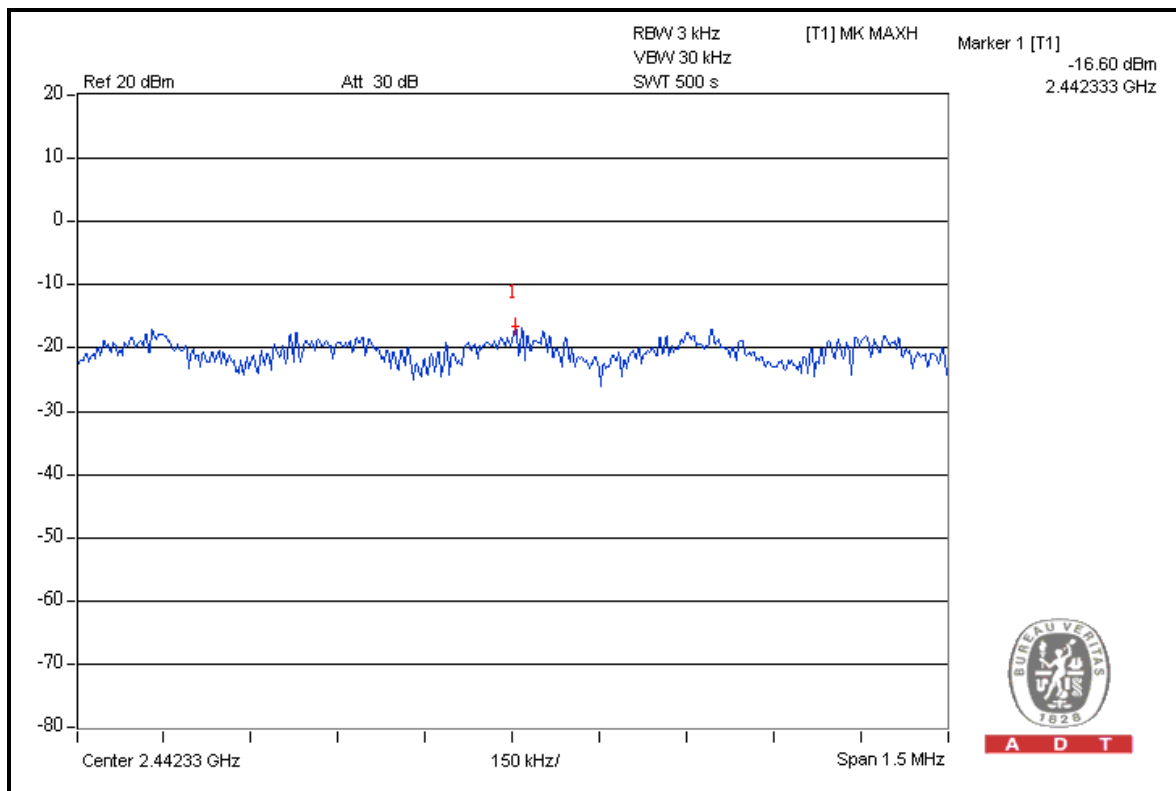



A D T

802.11n (20MHz)

Ant	CHAN.	CHAN. FREQ. (MHz)	RF POWER LEVEL IN 3kHz BW (dBm)		TOTAL POWER DENSITY (dBm)	MAX. LIMIT (dBm)	PASS / FAIL
			MEASURED	10 log (N=2) dB			
1	1	2412	-16.8	3.01	-13.8	8	PASS
	6	2437	-17.0	3.01	-14.0	8	PASS
	11	2462	-16.6	3.01	-13.6	8	PASS
2	1	2412	-17.5	3.01	-14.5	8	PASS
	6	2437	-16.9	3.01	-13.9	8	PASS
	11	2462	-18.3	3.01	-15.3	8	PASS

FOR Ant 1: CH 11

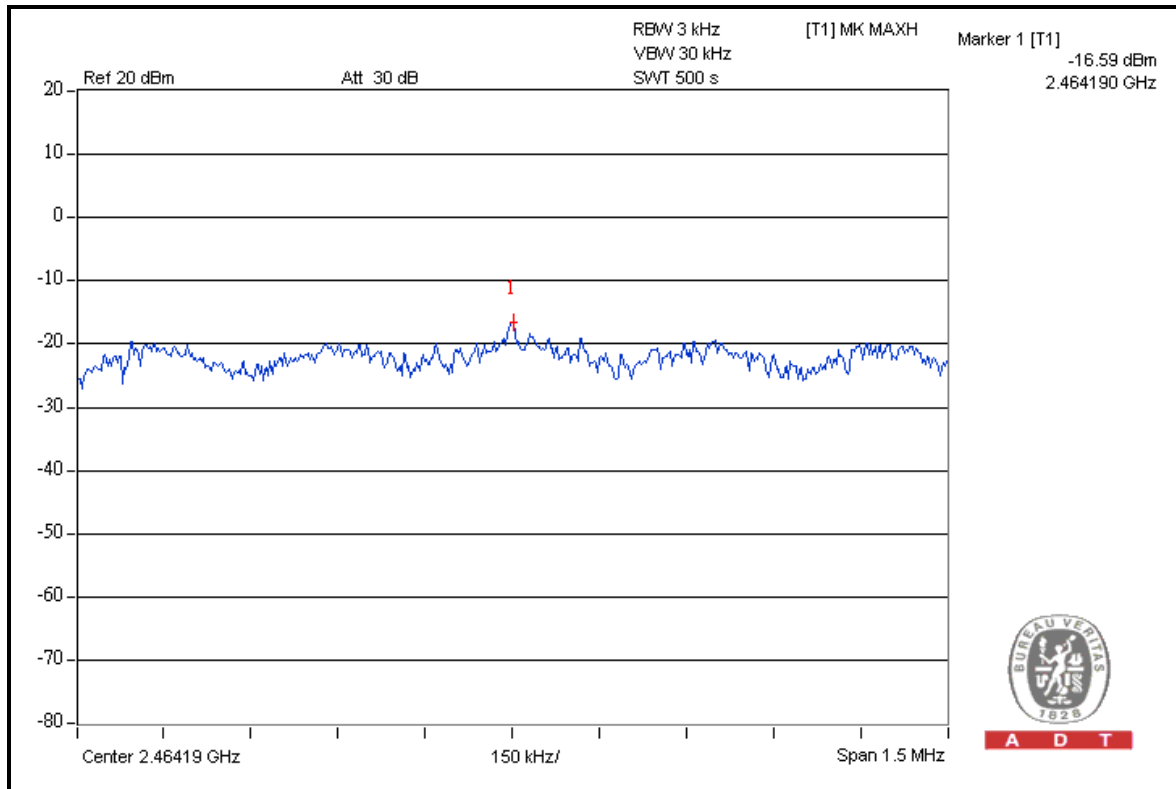

A D T



A D T

802.11n (40MHz)

Ant	CHAN.	CHAN. FREQ. (MHz)	RF POWER LEVEL IN 3kHz BW (dBm)		TOTAL POWER DENSITY (dBm)	MAX. LIMIT (dBm)	PASS / FAIL
			MEASURED	10 log (N=2) dB			
1	1	2422	-19.7	3.01	-16.7	8	PASS
	4	2437	-18.0	3.01	-15.0	8	PASS
	7	2452	-21.3	3.01	-18.3	8	PASS
2	1	2422	-21.2	3.01	-18.2	8	PASS
	4	2437	-19.6	3.01	-16.6	8	PASS
	7	2452	-21.0	3.01	-18.0	8	PASS

FOR Ant 1: CH 4

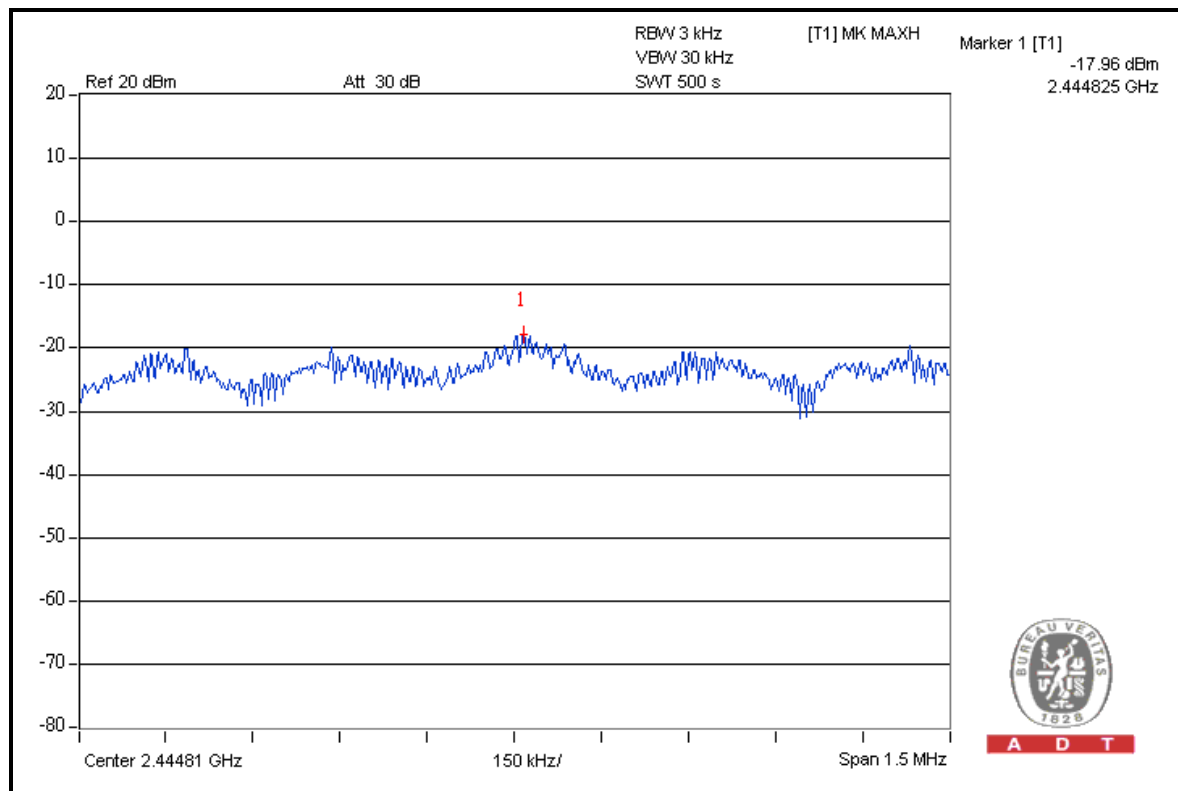

A D T



A D T

4.6 BAND EDGES MEASUREMENT

4.6.1 LIMITS OF BAND EDGES MEASUREMENT

Below -20dB of the highest emission level of operating band (in 100kHz Resolution Bandwidth).

4.6.2 TEST INSTRUMENTS

DESCRIPTION & MANUFACTURER	MODEL NO.	SERIAL NO.	DATE OF CALIBRATION	CALIBRATED UNTIL
FOR CONDUCTED MEASUREMENT:				
R&S SPECTRUM ANALYZER	FSP 40	100036	Apr. 29, 2011	Apr. 28, 2012
FOR RADIATED MEASUREMENT:				
HP Preamplifier	8447D	2432A03504	Mar. 04, 2011	Mar. 03, 2012
HP Preamplifier	8449B	3008A01924	Mar. 04, 2011	Mar. 03, 2012
HP Preamplifier	8449B	3008A01292	Mar. 04, 2011	Mar. 03, 2012
Agilent Spectrum Analyzer	E4446A	MY46180403	Jun. 22, 2011	Jun. 21, 2012
ROHDE & SCHWARZ TEST RECEIVER	ESCS30	838251/021	Oct. 01, 2010	Sep. 30, 2011
Schwarzbeck Antenna	VULB 9168	137	Apr. 12, 2011	Apr. 11, 2012
Schwarzbeck Antenna	VHBA 9123	480	May 06, 2011	May 05, 2012
ADT. Turn Table	TT100	0306	NA	NA
ADT. Tower	AT100	0306	NA	NA
Software	ADT_Radiated_V7.6.15.9.2	NA	NA	NA
SUHNER RF cable	SF102	CABLE-CH6	Aug. 19, 2011	Aug. 18, 2012
EMCO Horn Antenna	3115	6714	Oct. 26, 2010	Oct. 25, 2011
EMCO Horn Antenna	3115	9312-4192	Apr. 22, 2011	Apr. 21, 2012
Highpass filter Wainwright Instruments	WHK 3.1/18G-10SS	SN 8	NA	NA

NOTE: The calibration interval of the above test instruments is 12 months. And the calibrations are traceable to NML/ROC and NIST/USA.



A D T

4.6.3 TEST PROCEDURE

FOR CONDUCTED MEASUREMENT:

The transmitter output was connected to the spectrum analyzer via a low loss cable. Set both RBW and VBW of spectrum analyzer to 100kHz and 300kHz with suitable frequency span including 100MHz bandwidth from band edge. The band edges was measured and recorded.

The spectrum plots (Peak RBW =100kHz, VBW = 300kHz; Average RBW = 1MHz, VBW = 10Hz) are attached on the following pages.

FOR RADIATED MEASUREMENT:

- a. The EUT was placed on the top of a rotating table 0.8 meters above the ground at a 3 meter semi-anechoic chamber. The table was rotated 360 degrees to determine the position of the highest radiation.
- b. The EUT was set 3 meters away from the interference-receiving antenna, which was mounted on the top of a variable-height antenna tower.
- c. The height of antenna is varied from one meter to four meters above the ground to determine the maximum value of the field strength. Both horizontal and vertical polarizations of the antenna are set to make the measurement.
- d. For each suspected emission, the EUT was arranged to its worst case and then the antenna was tuned to heights from 1 meter to 4 meters and the rotatable table was turned from 0 degrees to 360 degrees to find the maximum reading.
- e. Set both RBW and VBW of spectrum analyzer to 100kHz and 300kHz with suitable frequency span including 100MHz bandwidth from band edge. The band edges was measured and recorded.

The spectrum plots (Peak RBW =100kHz, VBW = 300kHz; Average RBW = 1MHz, VBW = 10Hz) are attached on the following pages.

NOTE: The resolution bandwidth of test receiver/spectrum analyzer is 1MHz and the video bandwidth is 10Hz for Average detection (AV) at frequency above 1GHz.

4.6.4 DEVIATION FROM TEST STANDARD

No deviation.

4.6.5 EUT OPERATING CONDITION

Same as Item 4.3.6.



A D T

4.6.6 TEST RESULTS

The spectrum plots are attached on the following pages. D1 line indicates the highest level, and D2 line indicates the 20dB offset below D1. It shows compliance with the requirement in part 15.247(d).

802.11b

RESTRICT BAND (2310 ~ 2390 MHz)

FREQUENCY (MHz)	FUNDAMENTAL EMISSION (dBuV/m)	DELTA (dB)	MAXIMUM FIELD STRENGTH IN RESTRICT BAND (dBuV/m)	LIMIT (dBuV/m)
2412.00 (PK)	115.5	49.9	65.6	74.0
2412.00 (AV)	111.6	57.8	53.8	54.0

RESTRICT BAND (2483.5 ~ 2500 MHz)

FREQUENCY (MHz)	FUNDAMENTAL EMISSION (dBuV/m)	DELTA (dB)	MAXIMUM FIELD STRENGTH IN RESTRICT BAND (dBuV/m)	LIMIT (dBuV/m)
2462.00 (PK)	113.8	49.3	64.5	74.0
2462.00 (AV)	109.8	56.0	53.8	54.0

NOTE:

1. Delta = Amplitude between the peak of the fundamental and the peak of the band edge emission. Please check following 3 pages.
2. Maximum field strength in restrict band = Fundamental emission – Delta.



A D T

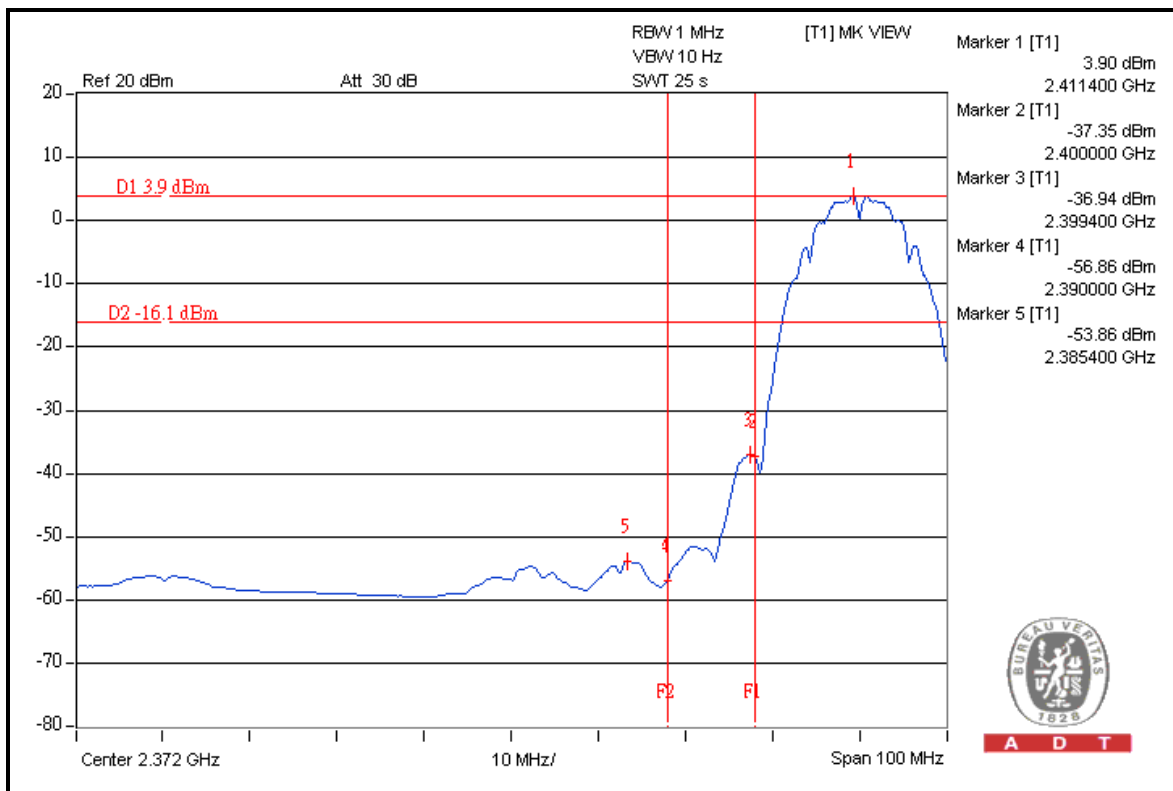
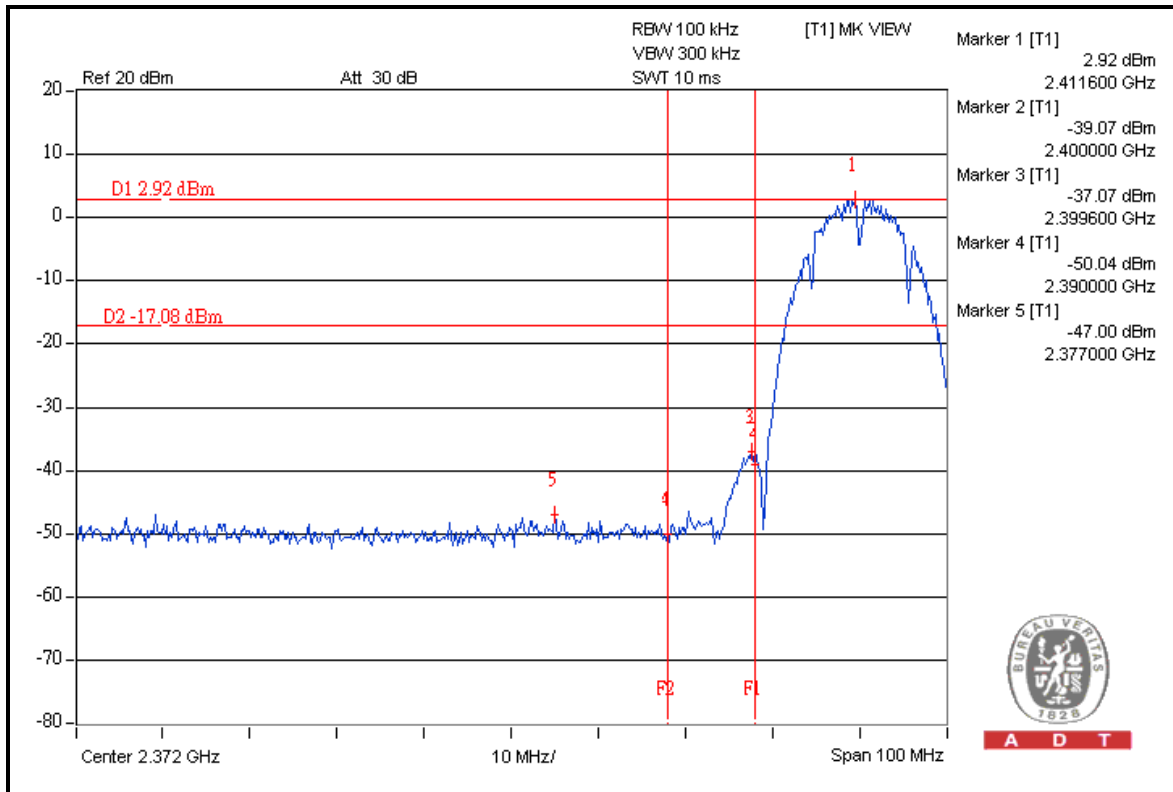



A D T

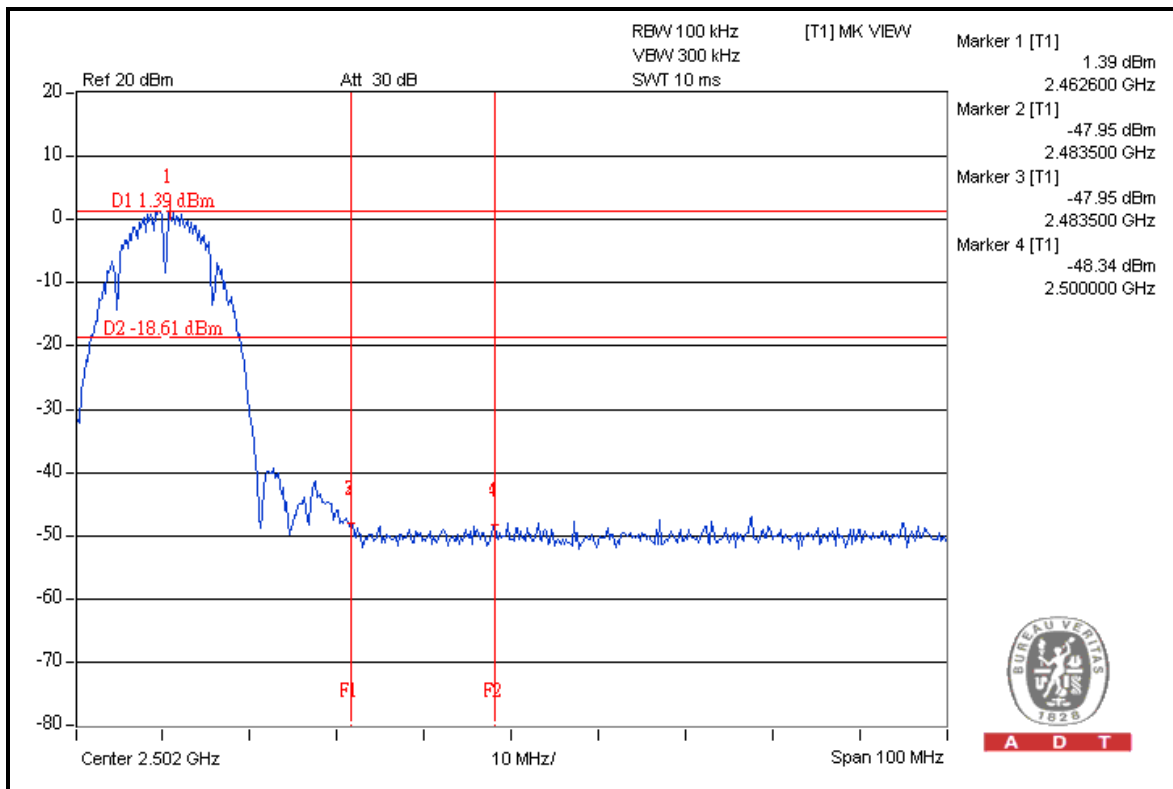
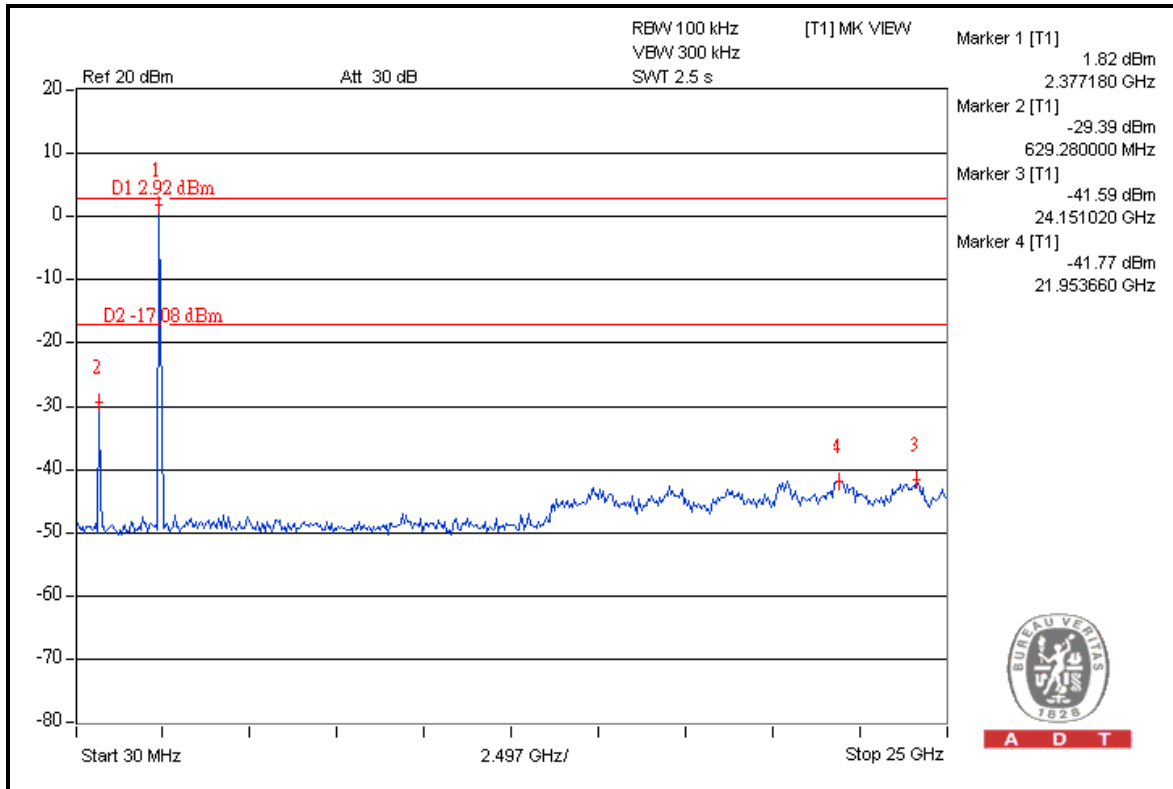



A D T

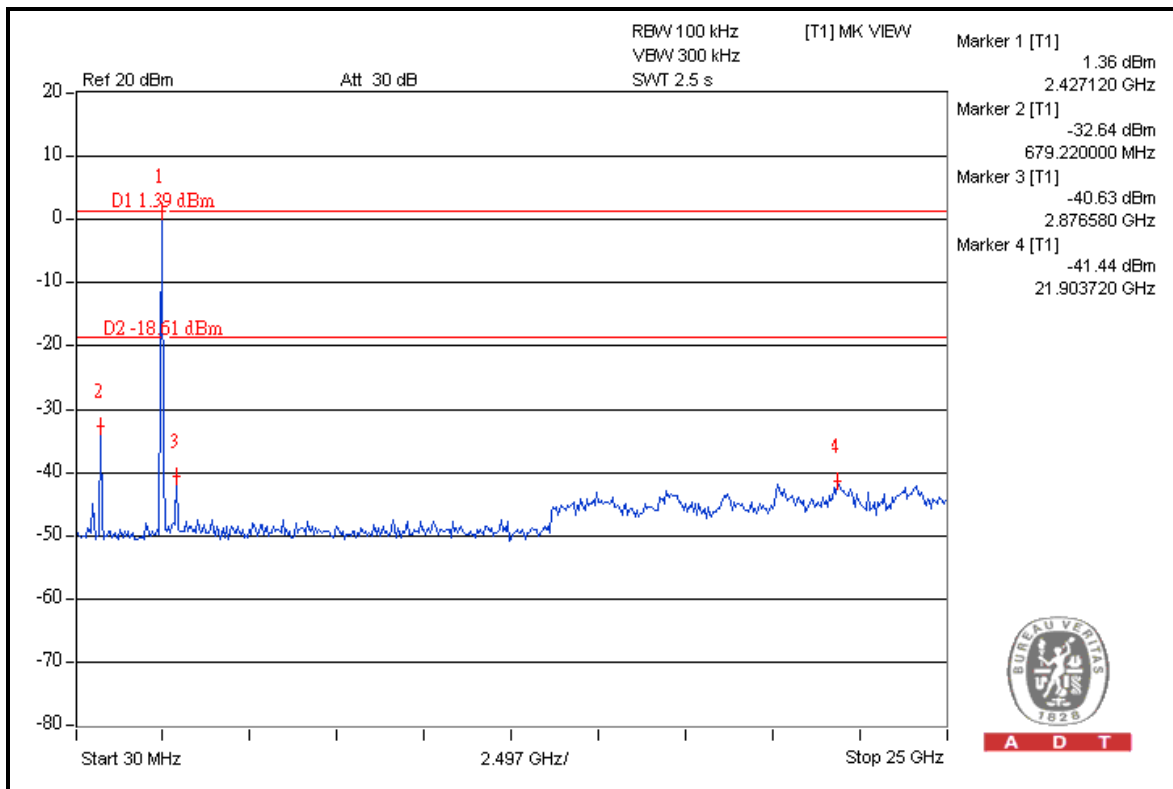
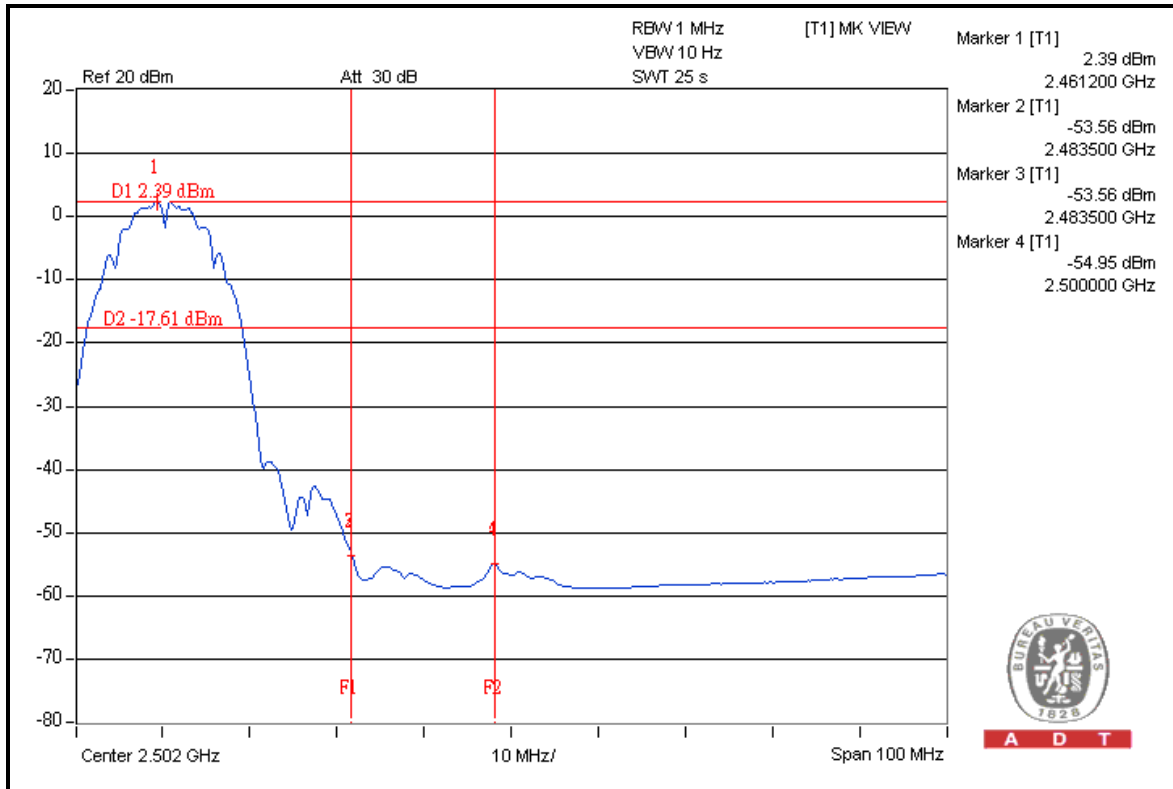



A D T

802.11g

RESTRICT BAND (2310 ~ 2390 MHz)

FREQUENCY (MHz)	FUNDAMENTAL EMISSION (dBuV/m)	DELTA (dB)	MAXIMUM FIELD STRENGTH IN RESTRICT BAND (dBuV/m)	LIMIT (dBuV/m)
2412.00 (PK)	115.7	44.5	71.2	74.0
2412.00 (AV)	105.3	51.9	53.4	54.0

RESTRICT BAND (2483.5 ~ 2500 MHz)

FREQUENCY (MHz)	FUNDAMENTAL EMISSION (dBuV/m)	DELTA (dB)	MAXIMUM FIELD STRENGTH IN RESTRICT BAND (dBuV/m)	LIMIT (dBuV/m)
2462.00 (PK)	114.6	43.5	71.1	74.0
2462.00 (AV)	104.5	51.8	52.7	54.0

NOTE:

1. Delta = Amplitude between the peak of the fundamental and the peak of the band edge emission. Please check following 3 pages.
2. Maximum field strength in restrict band = Fundamental emission – Delta.



A D T

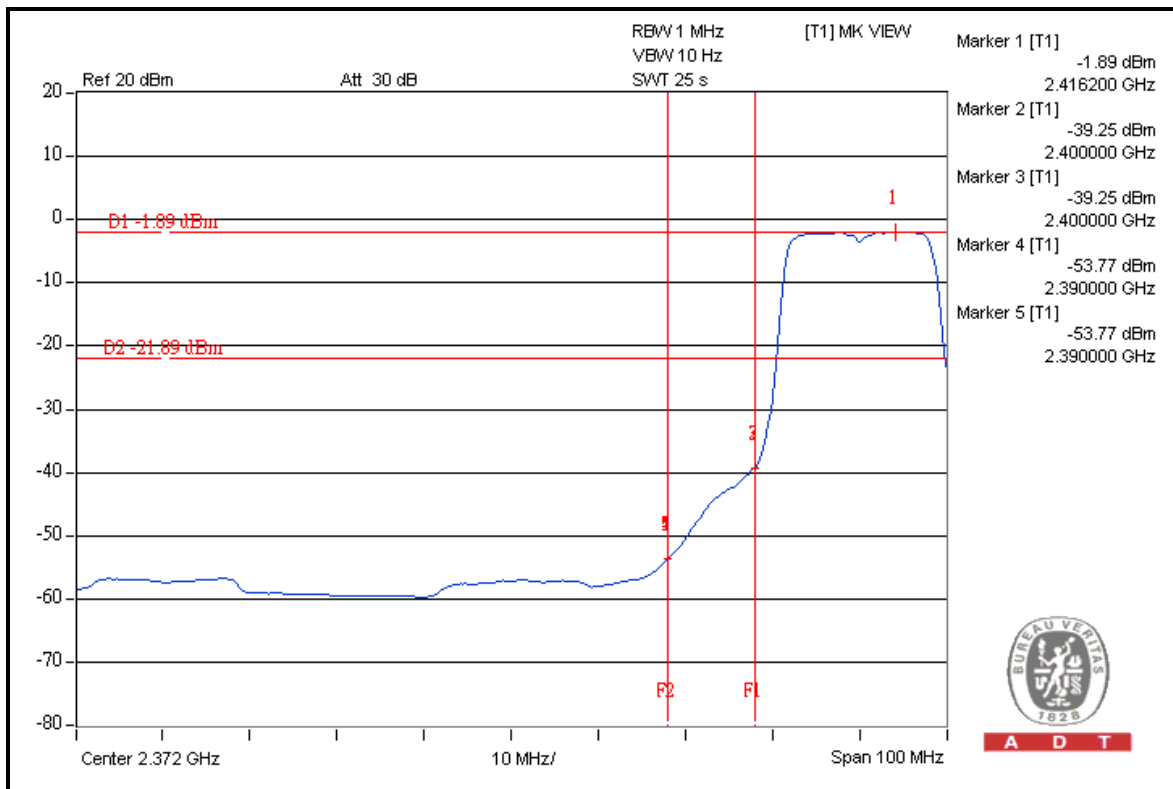
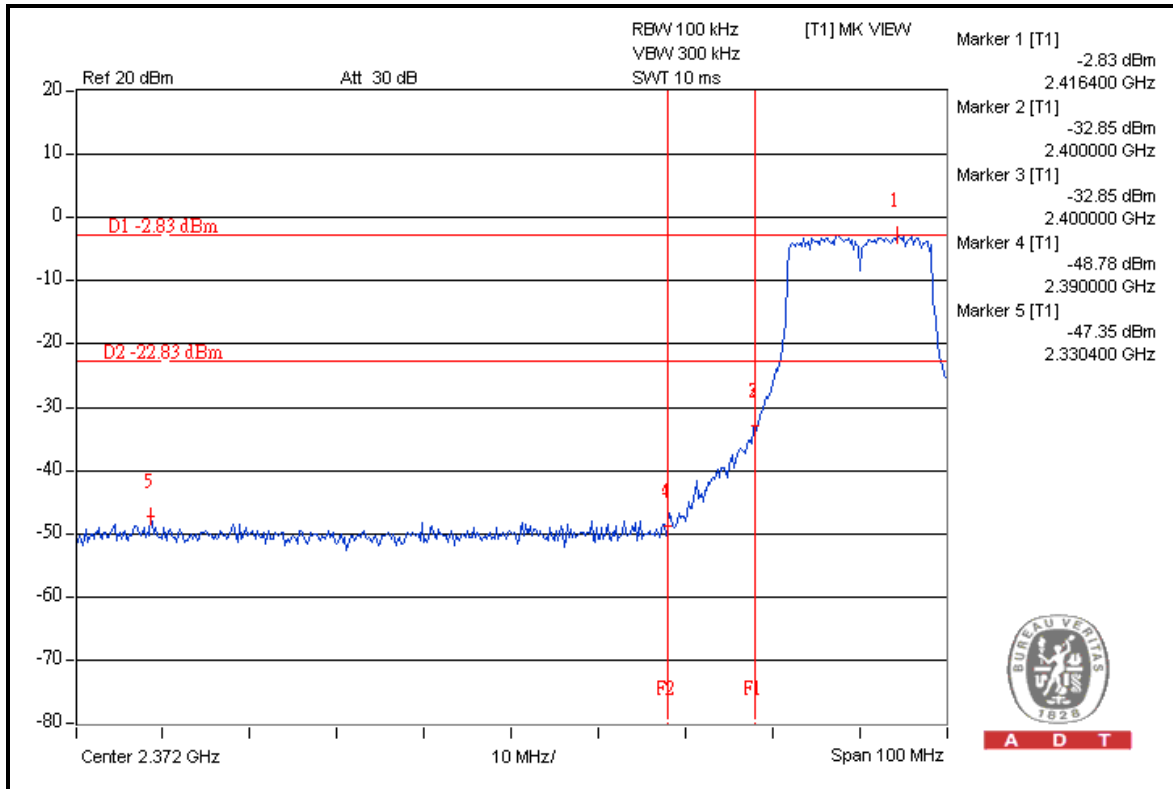



A D T

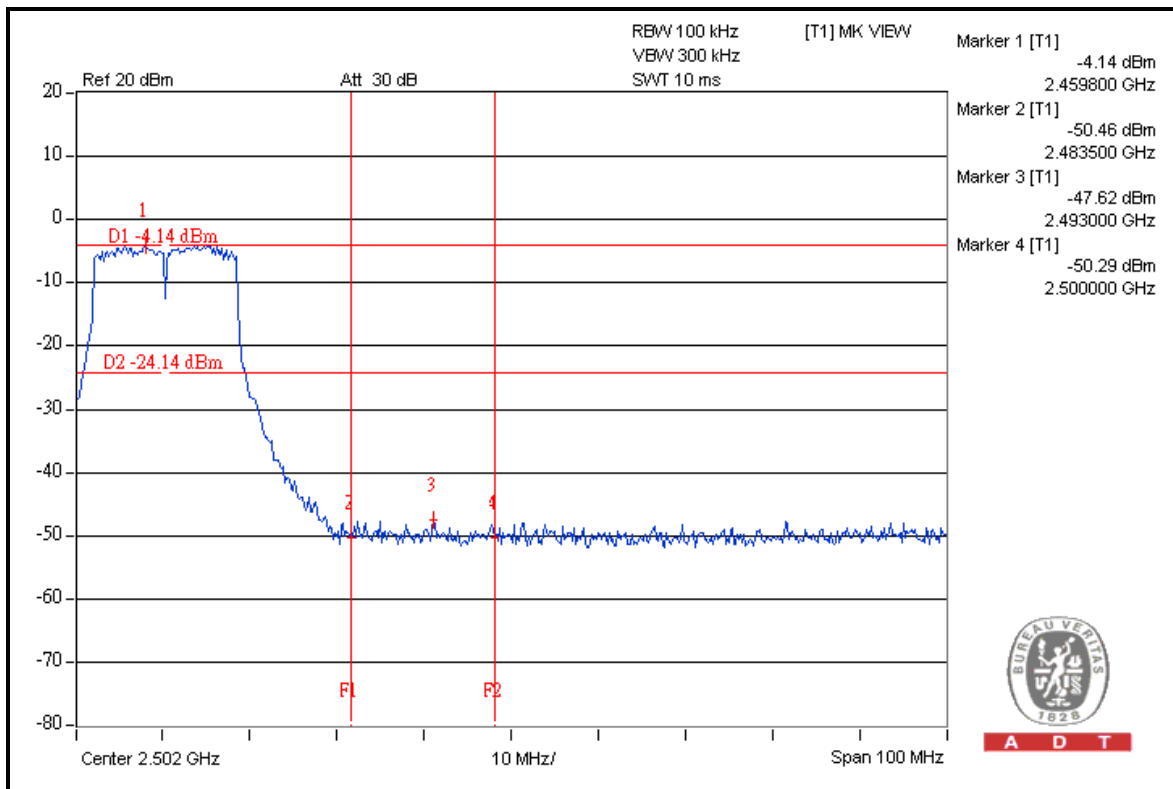
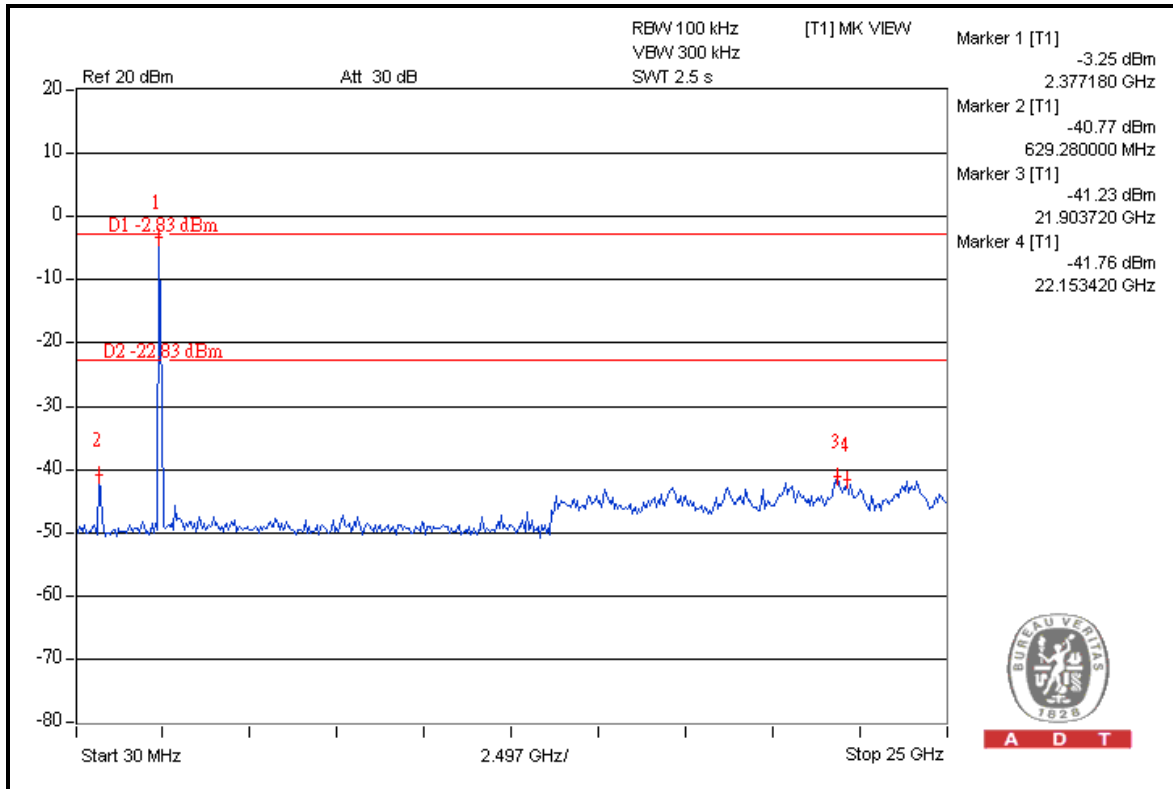



A D T

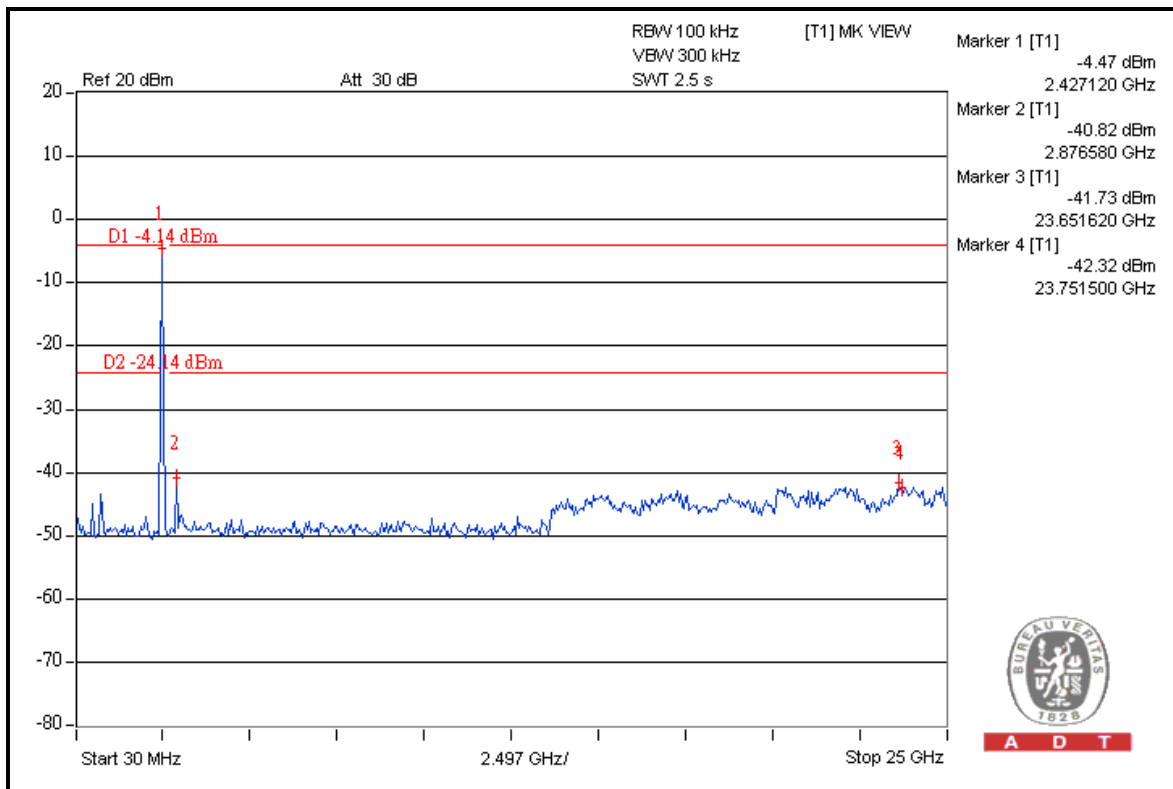
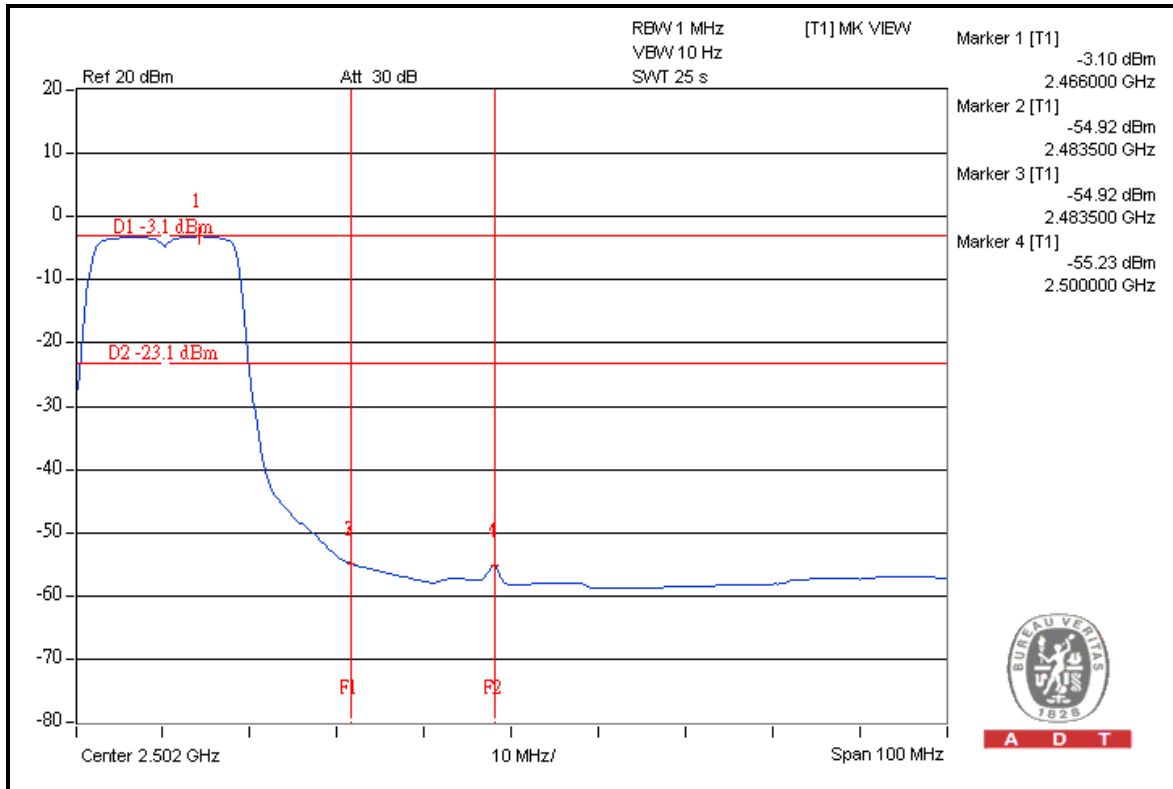



A D T

802.11n (20MHz)

RESTRICT BAND (2310 ~ 2390 MHz)

FREQUENCY (MHz)	FUNDAMENTAL EMISSION (dBuV/m)	DELTA (dB)	MAXIMUM FIELD STRENGTH IN RESTRICT BAND (dBuV/m)	LIMIT (dBuV/m)
2412.00 (PK)	113.6	47.2	66.4	74.0
2412.00 (AV)	103.3	50.9	52.4	54.0

RESTRICT BAND (2483.5 ~ 2500 MHz)

FREQUENCY (MHz)	FUNDAMENTAL EMISSION (dBuV/m)	DELTA (dB)	MAXIMUM FIELD STRENGTH IN RESTRICT BAND (dBuV/m)	LIMIT (dBuV/m)
2462.00 (PK)	115.7	45.5	70.2	74.0
2462.00 (AV)	105.5	53.3	52.2	54.0

NOTE:

1. Delta = Amplitude between the peak of the fundamental and the peak of the band edge emission. Please check following 2 pages.
2. Maximum field strength in restrict band = Fundamental emission – Delta.



A D T

FOR RADIATED MEASURED (TWO CHAINS ON)

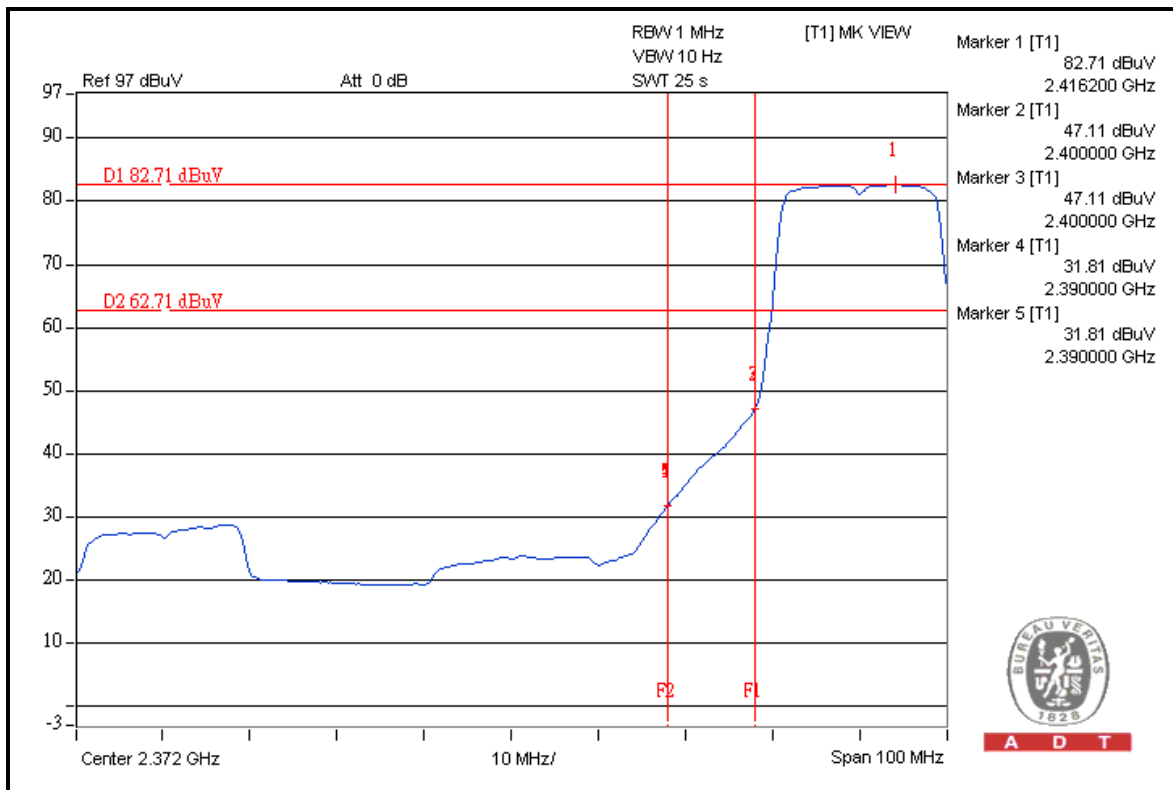
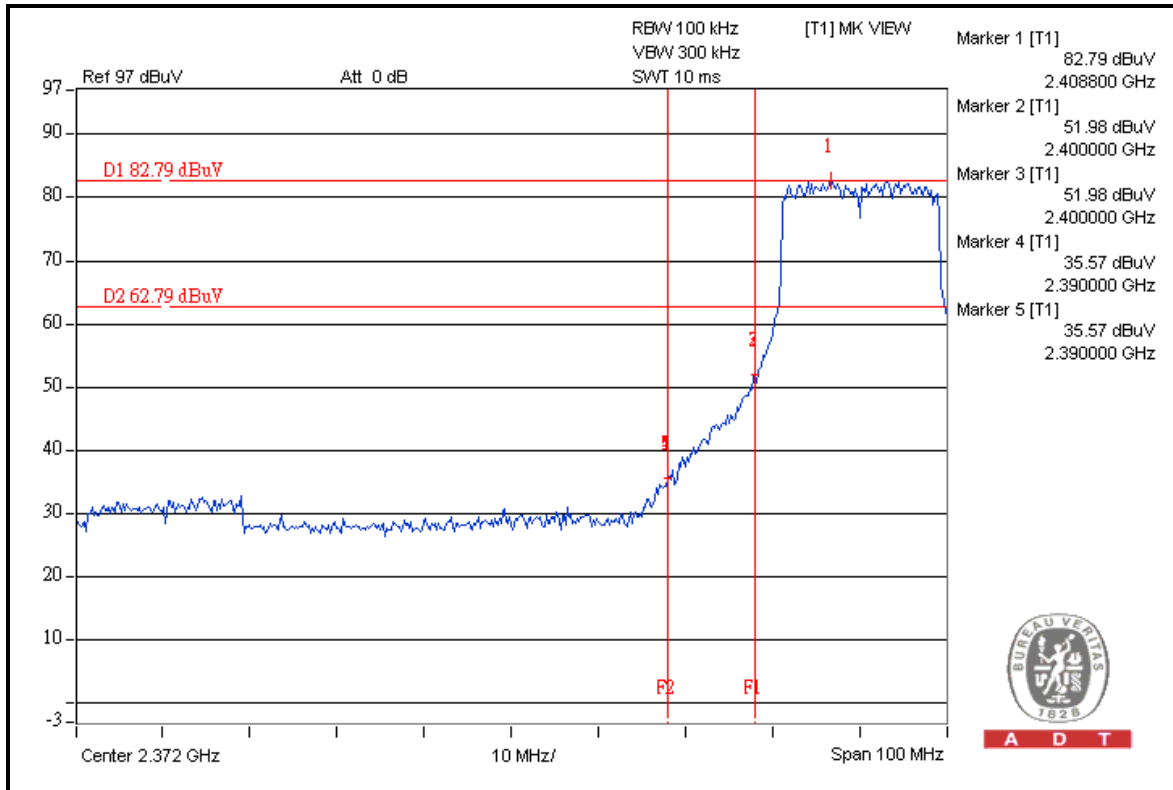



A D T

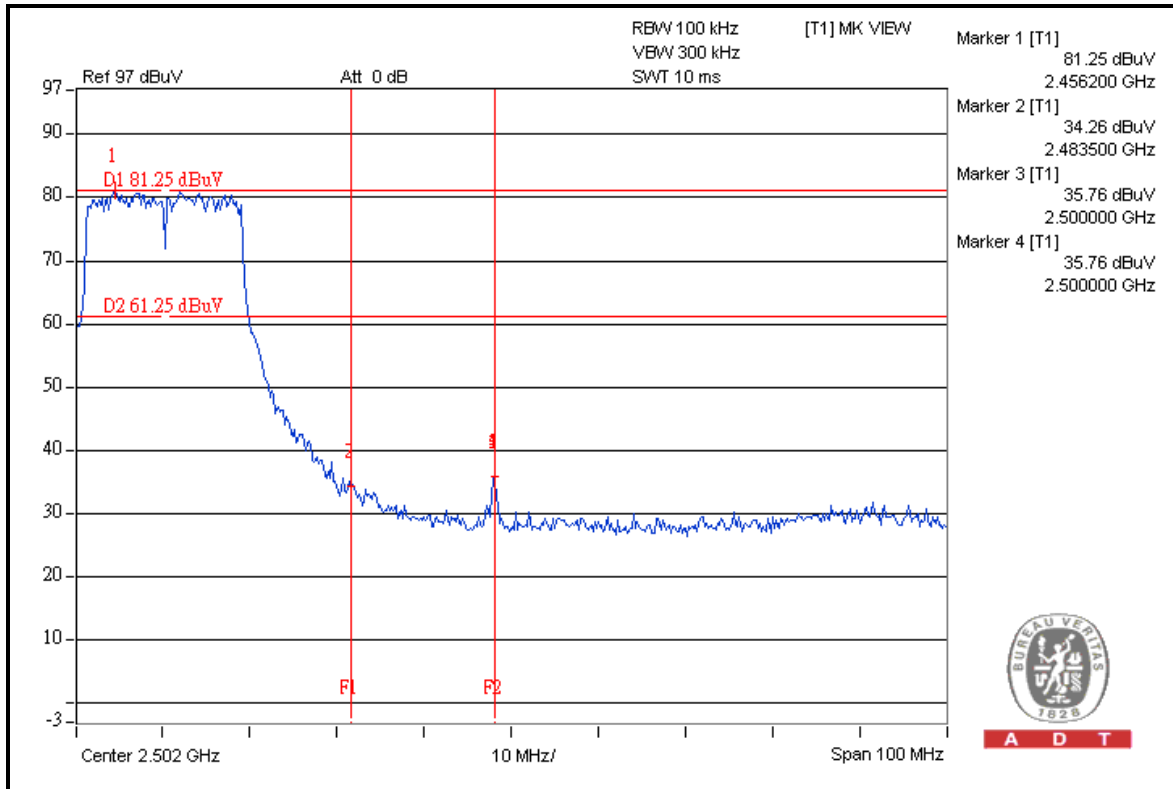

A D T

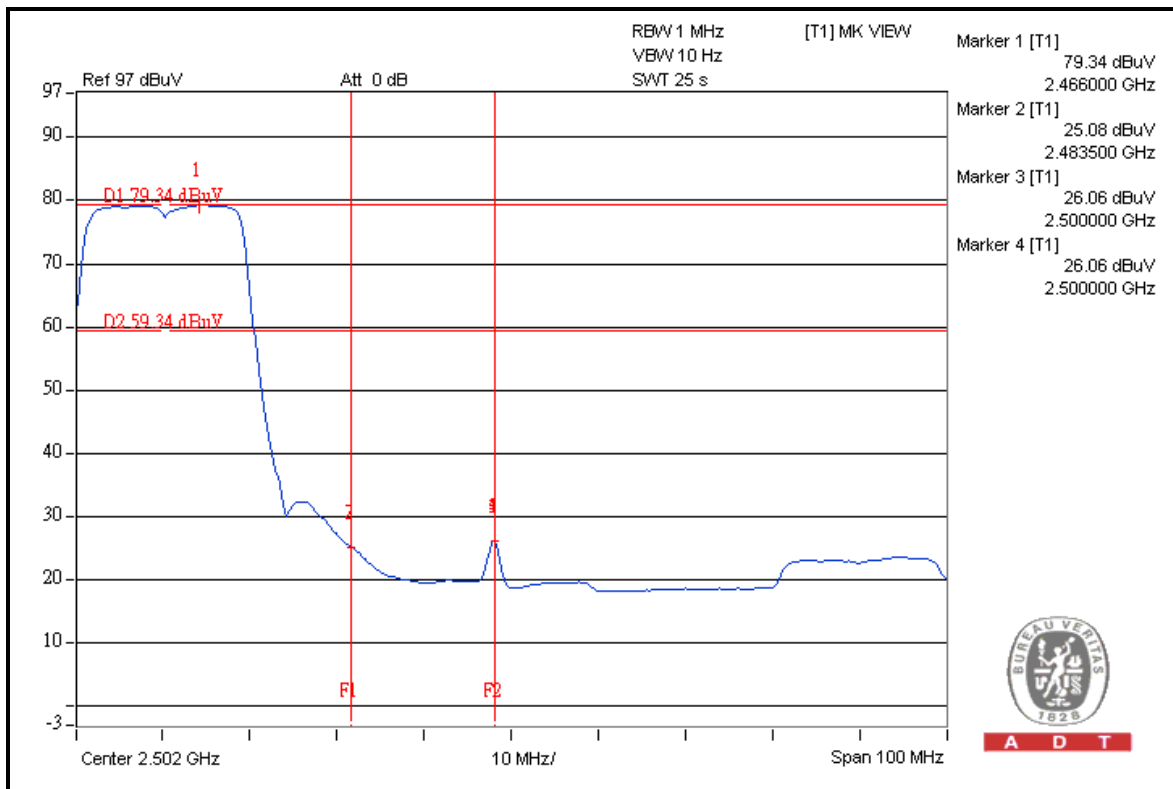

A D T



A D T

FOR CONDUCTED MEASURED

CHAIN 0

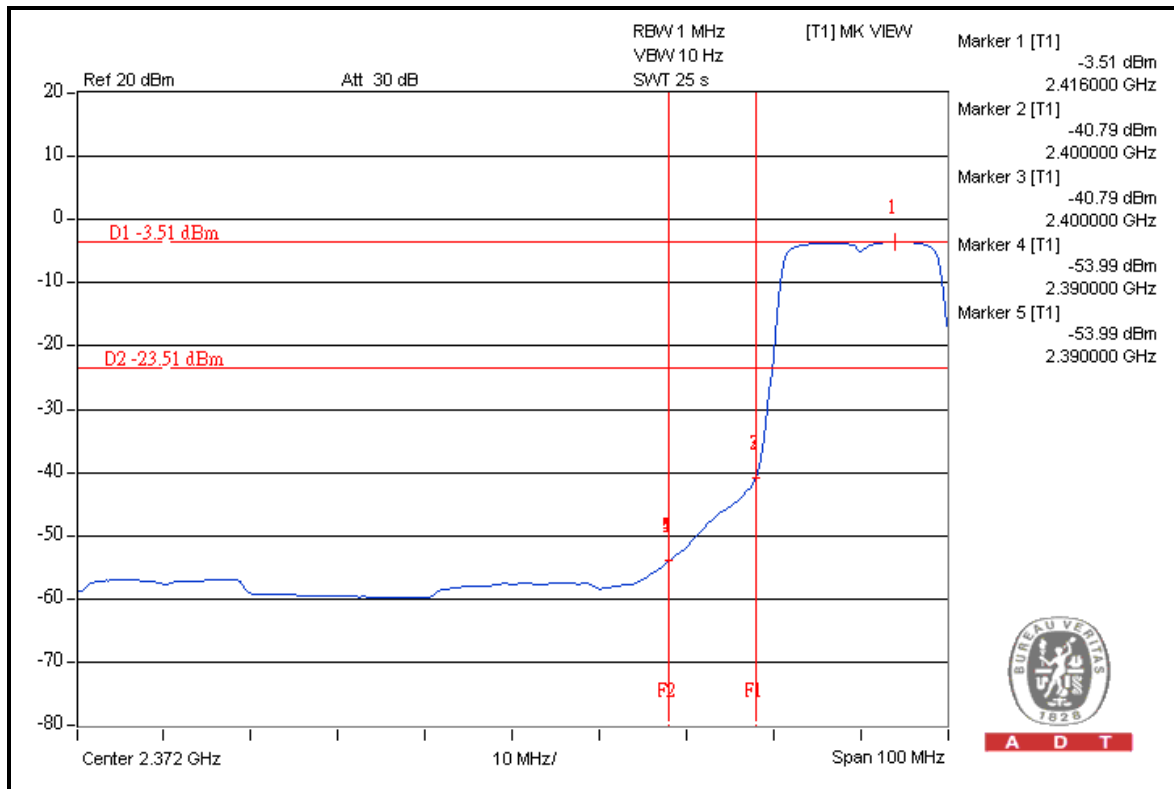
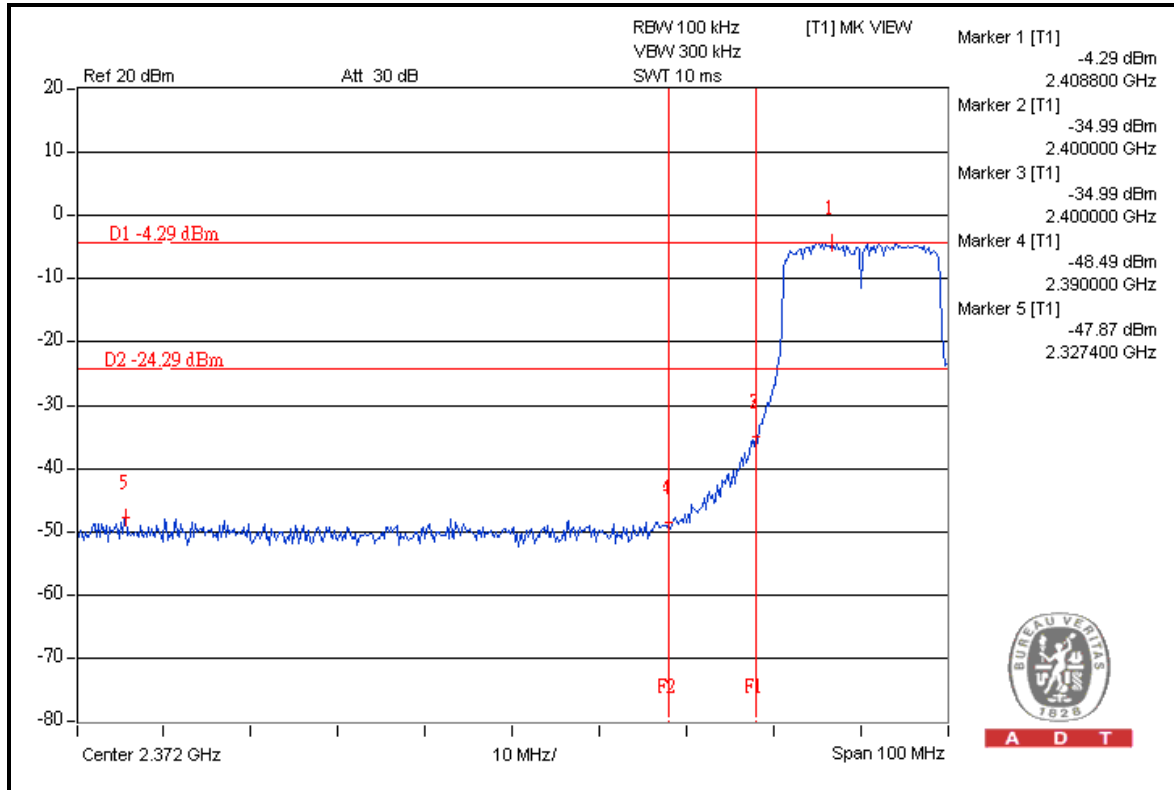



A D T

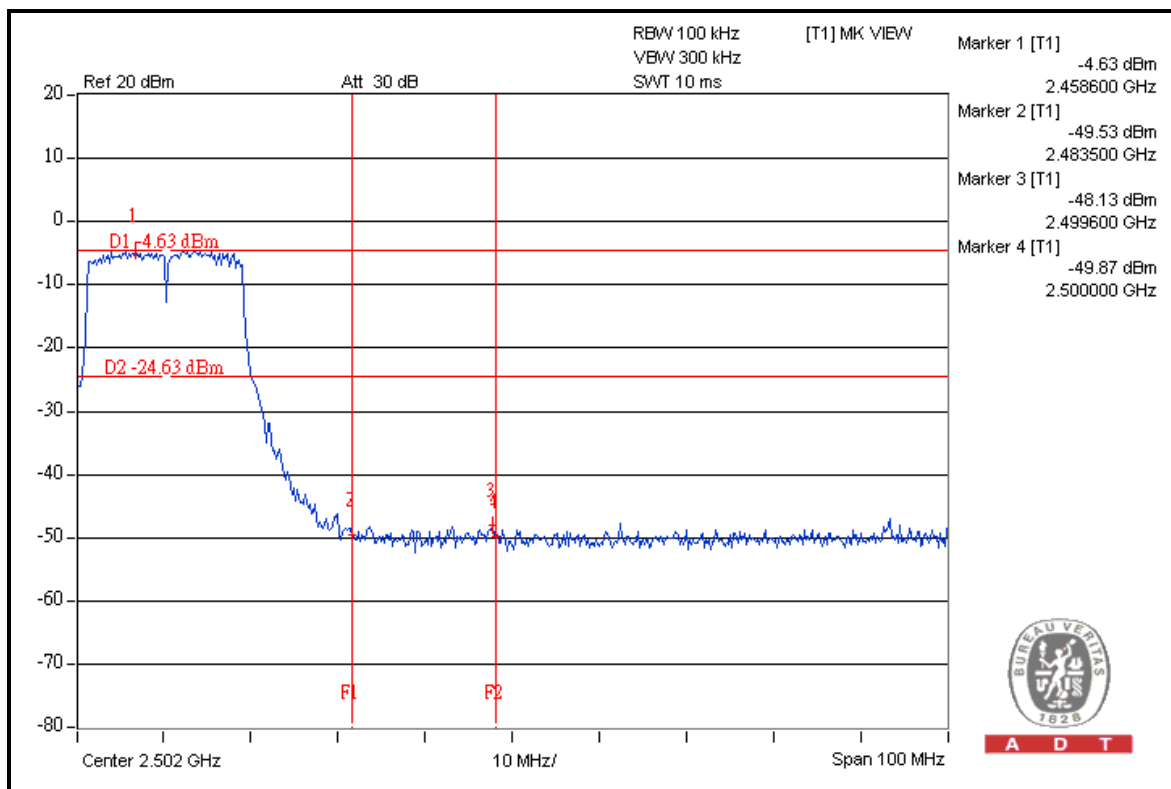
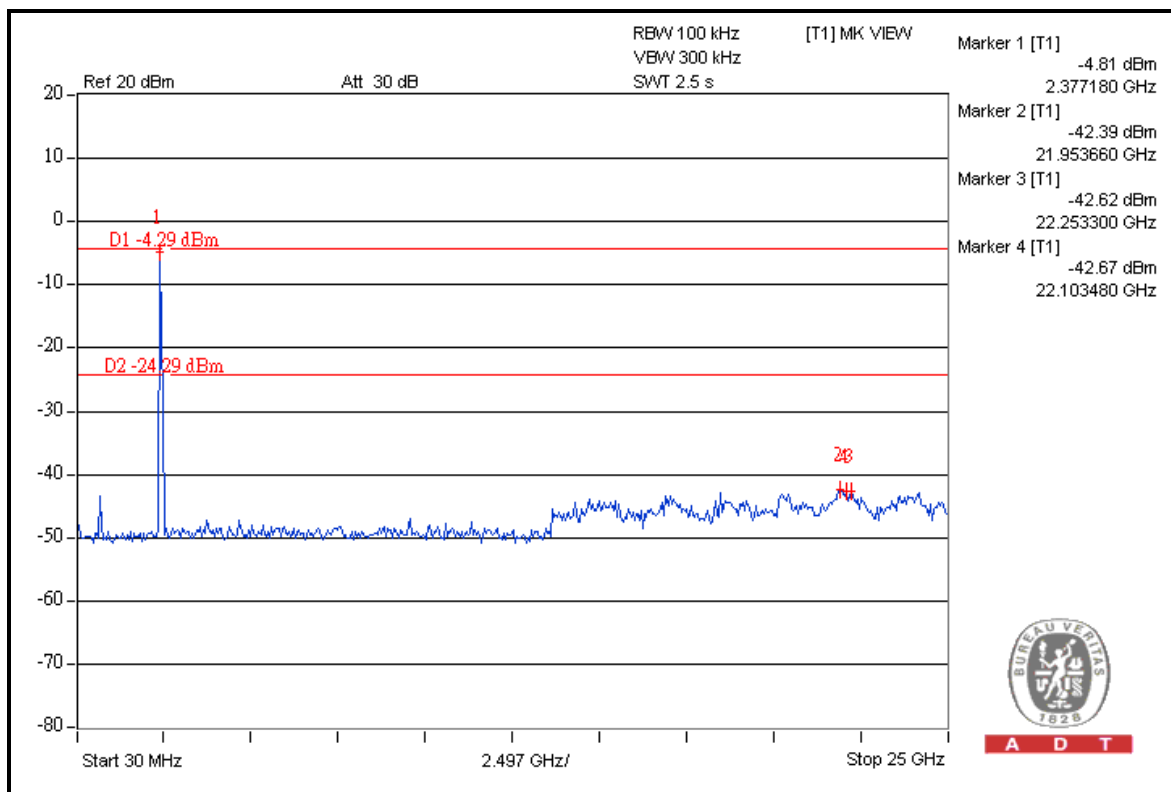



A D T

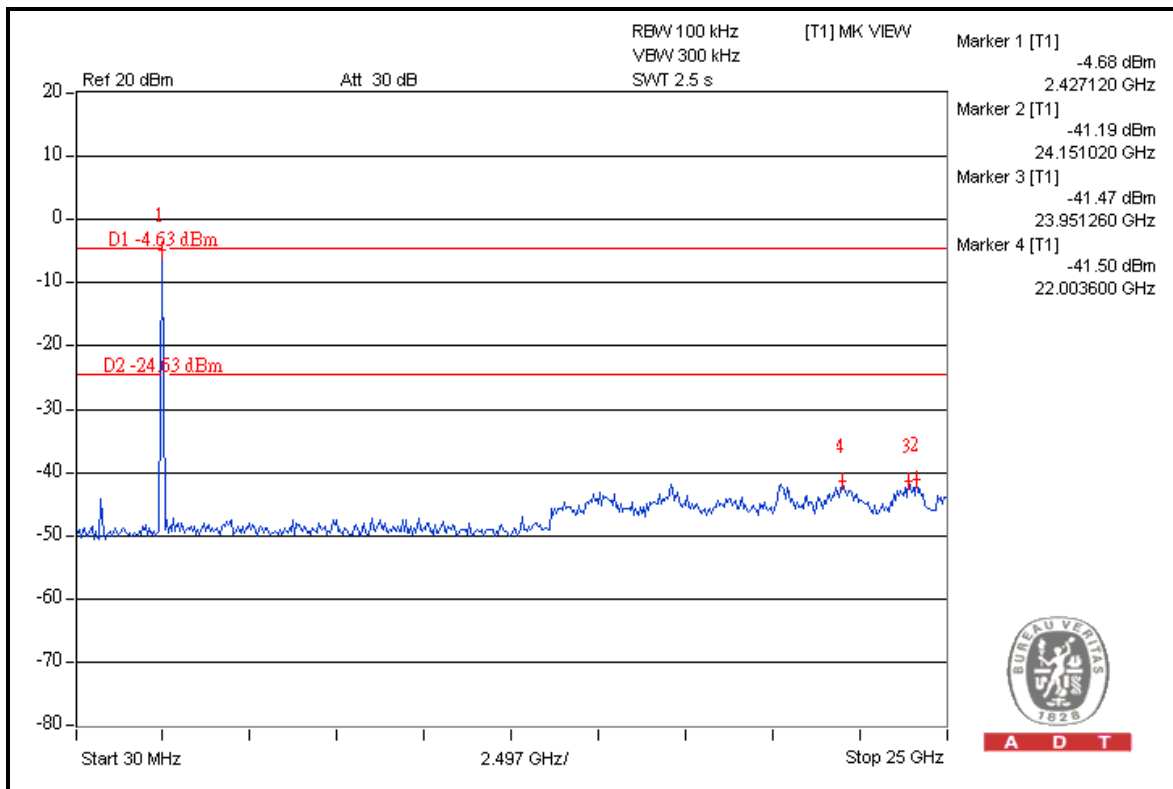
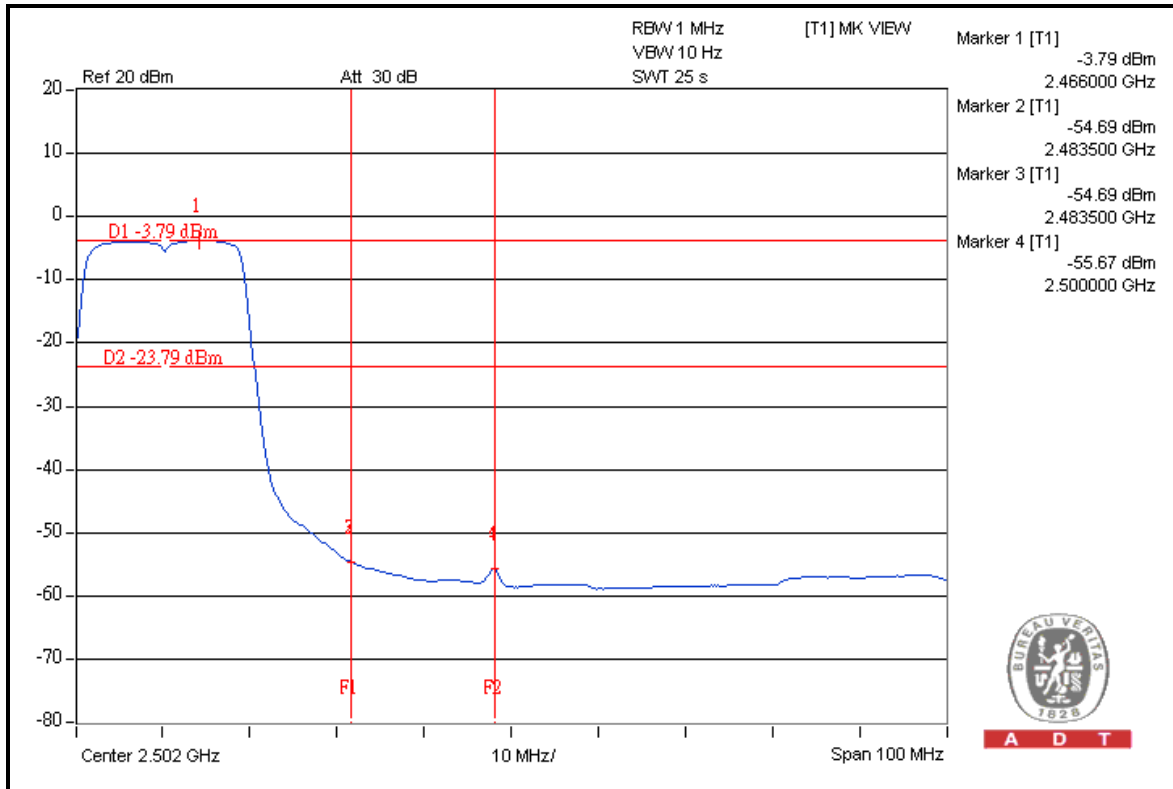



A D T

CHAIN 1

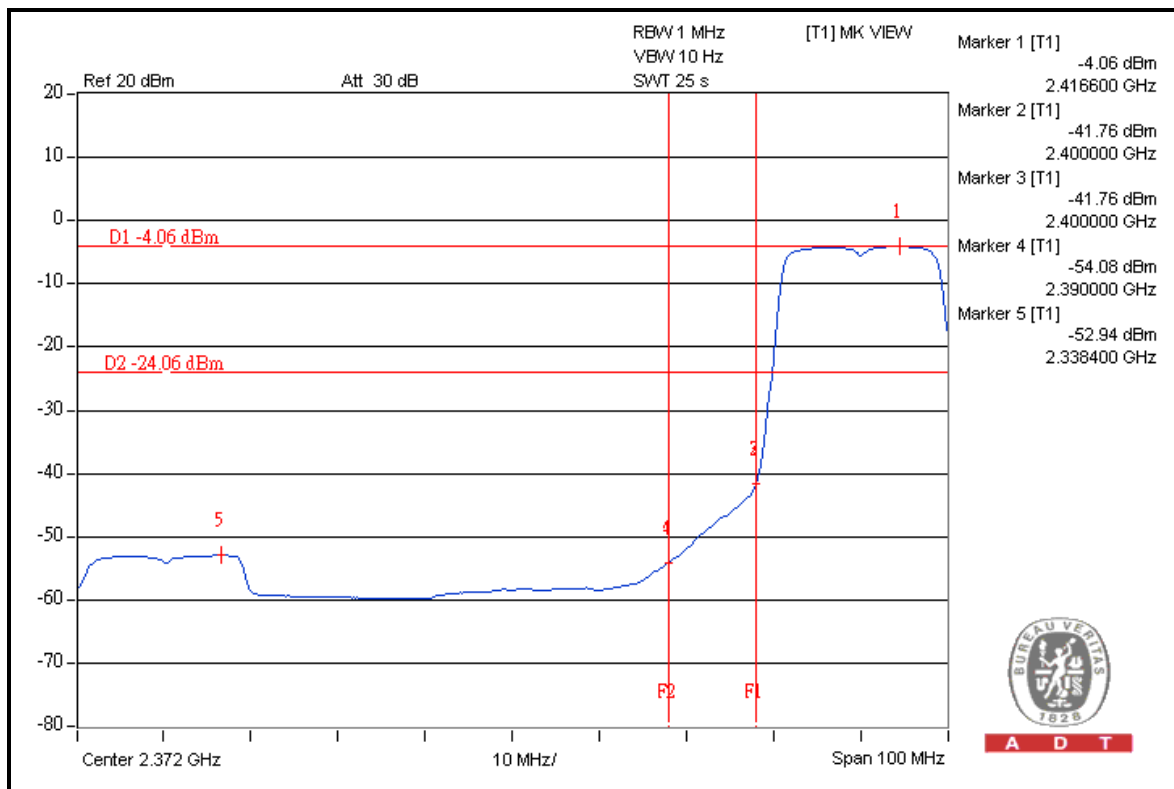
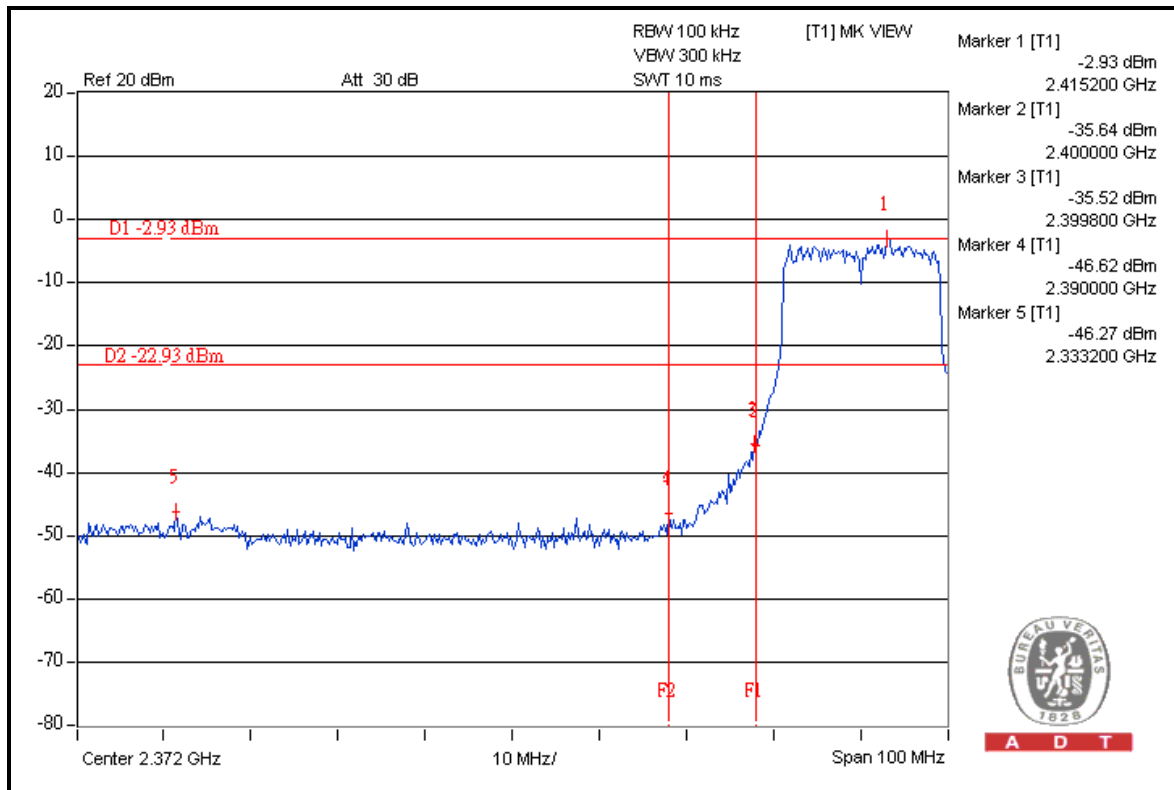



A D T

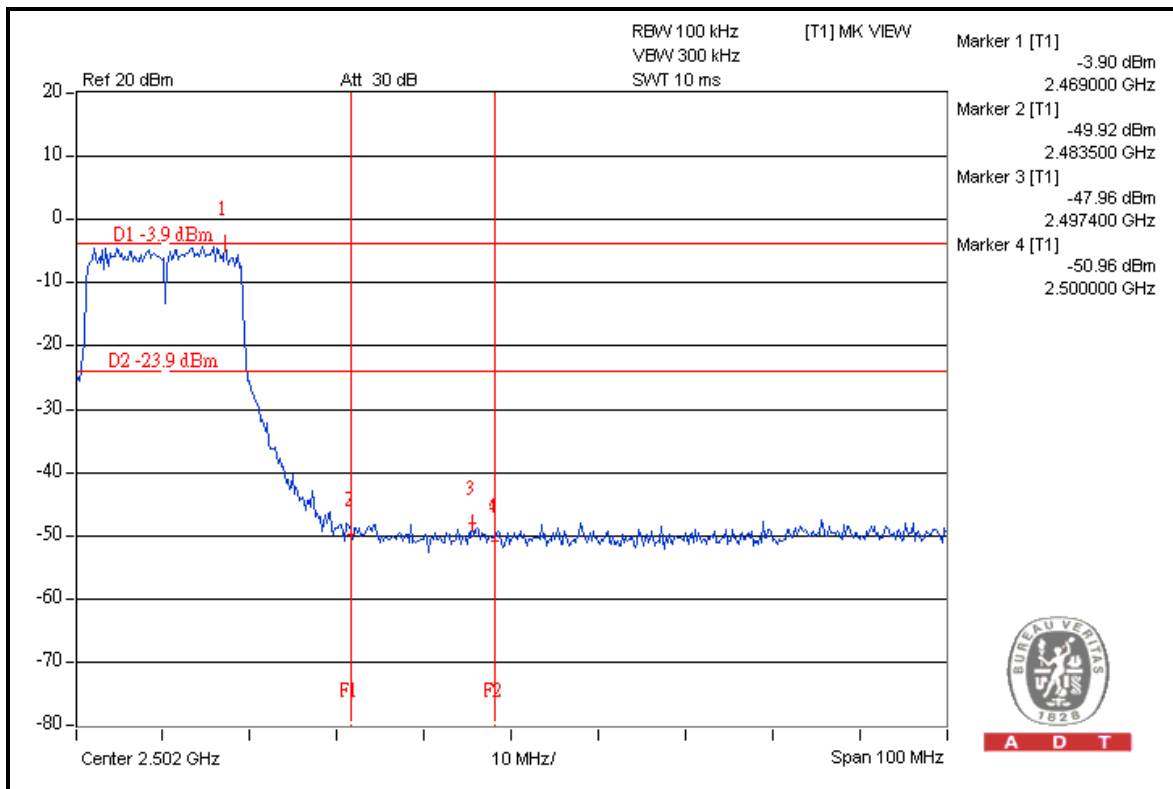
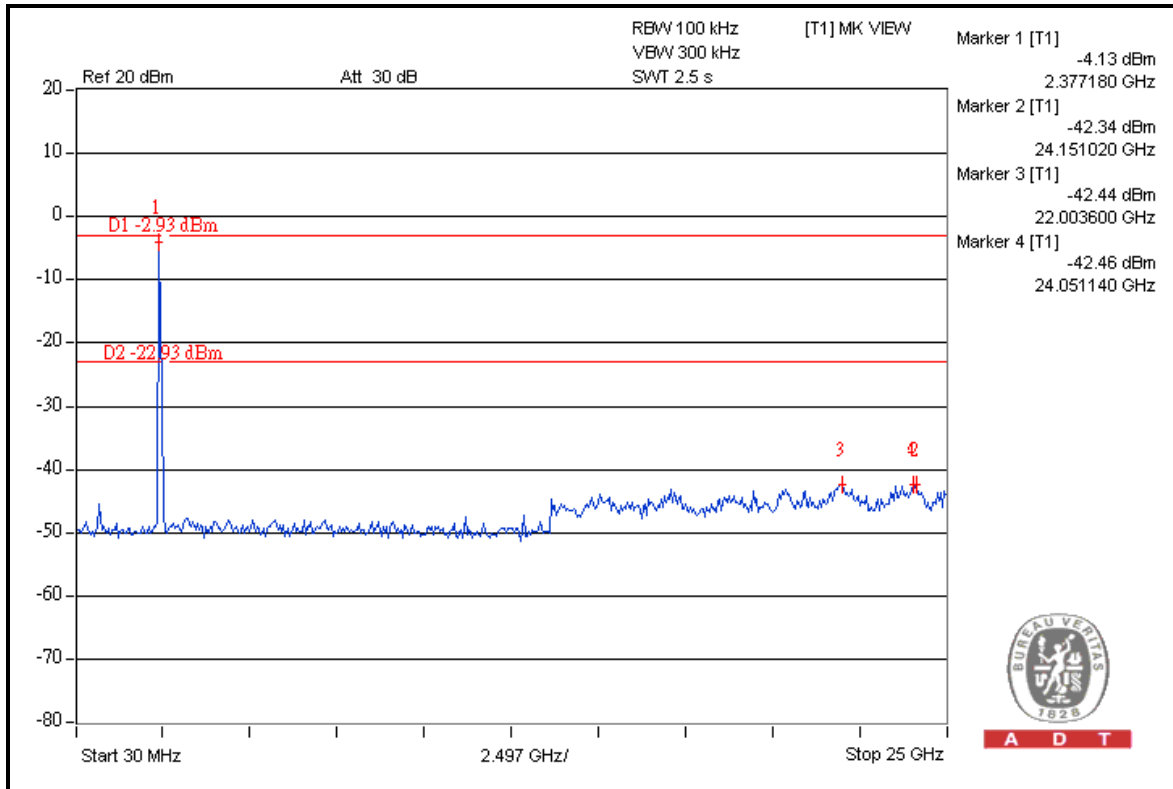



A D T

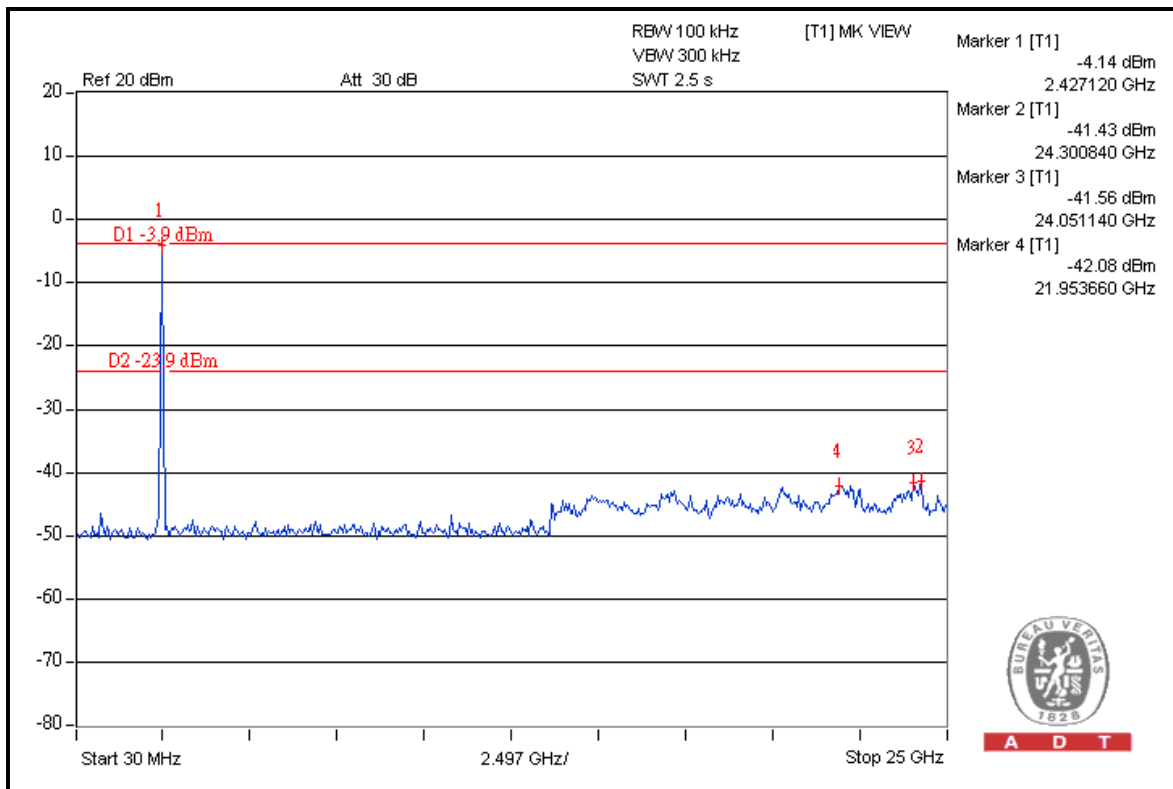
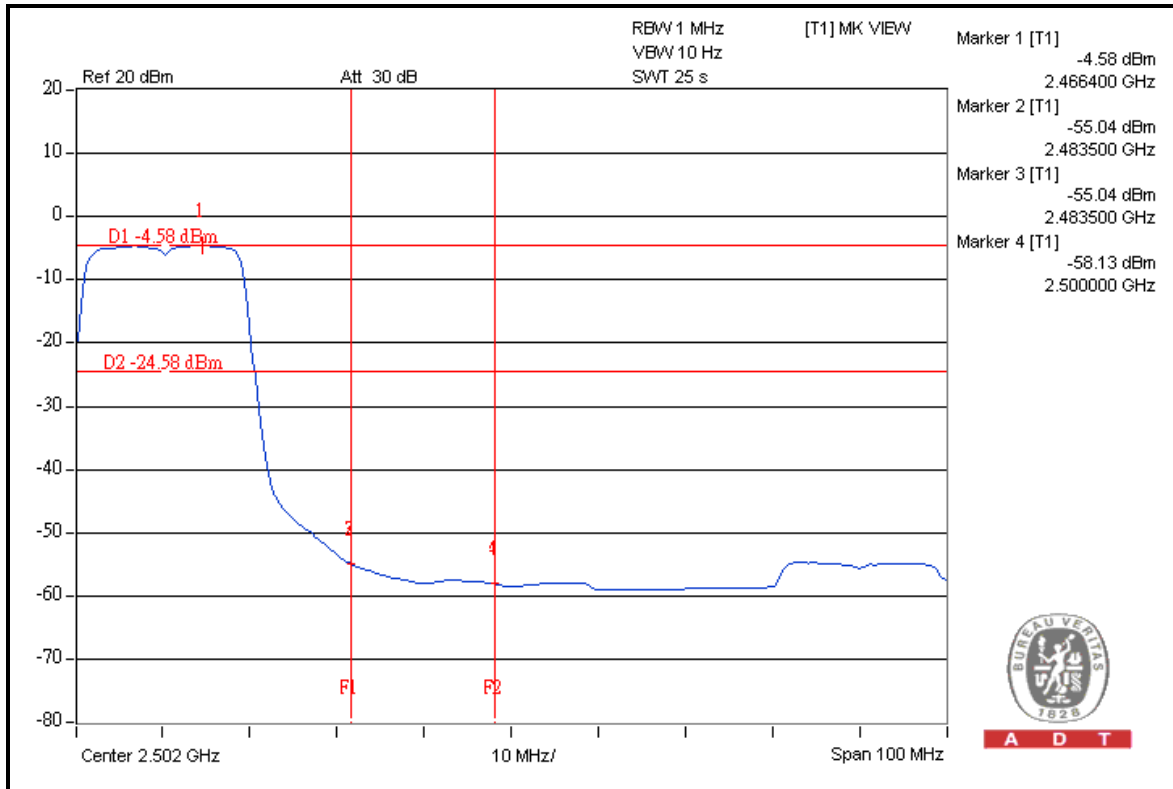



802.11n (40MHz)

RESTRICT BAND (2310 ~ 2390 MHz)

FREQUENCY (MHz)	FUNDAMENTAL EMISSION (dBuV/m)	DELTA (dB)	MAXIMUM FIELD STRENGTH IN RESTRICT BAND (dBuV/m)	LIMIT (dBuV/m)
2422.00 (PK)	110.8	38.1	72.7	74.0
2422.00 (AV)	96.7	51.9	44.8	54.0

RESTRICT BAND (2483.5 ~ 2500 MHz)

FREQUENCY (MHz)	FUNDAMENTAL EMISSION (dBuV/m)	DELTA (dB)	MAXIMUM FIELD STRENGTH IN RESTRICT BAND (dBuV/m)	LIMIT (dBuV/m)
2452.00 (PK)	112.0	41.6	70.4	74.0
2452.00 (AV)	97.8	51.0	46.8	54.0

NOTE:

1. Delta = Amplitude between the peak of the fundamental and the peak of the band edge emission. Please check following 2 pages.
2. Maximum field strength in restrict band = Fundamental emission – Delta.



A D T

FOR RADIATED MEASURED (TWO CHAINS ON)

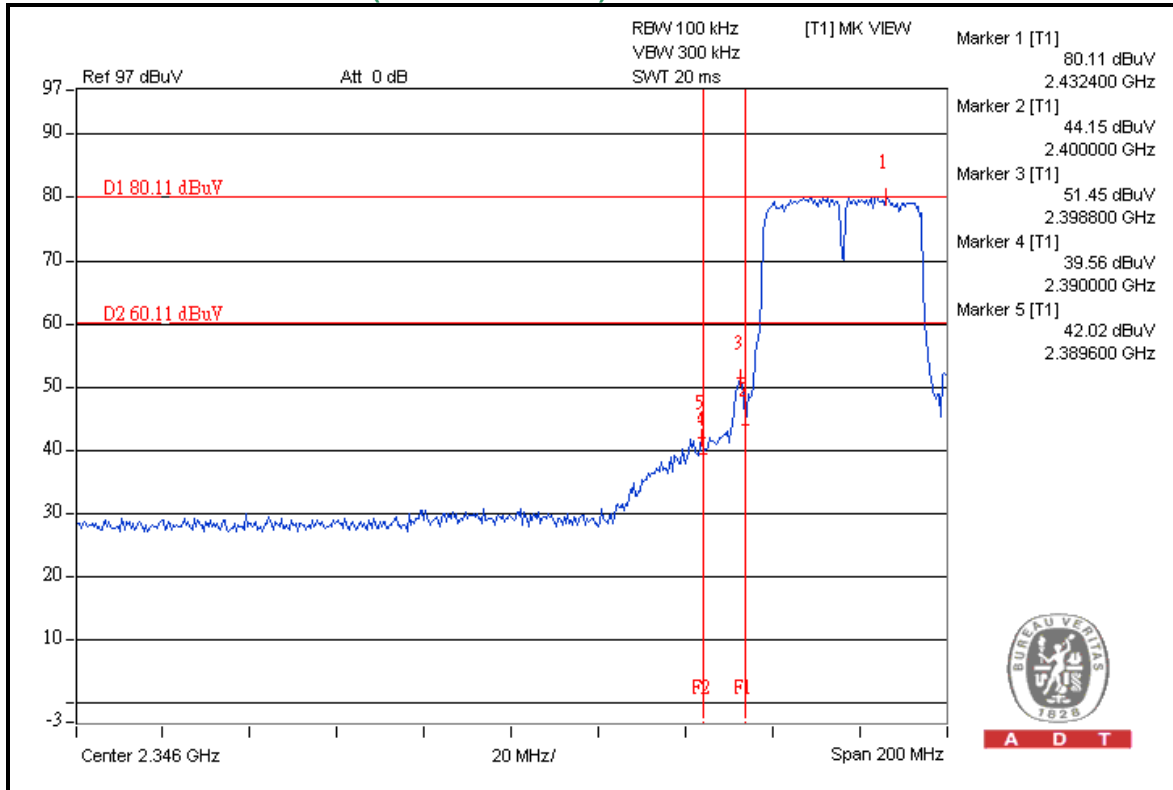

A D T

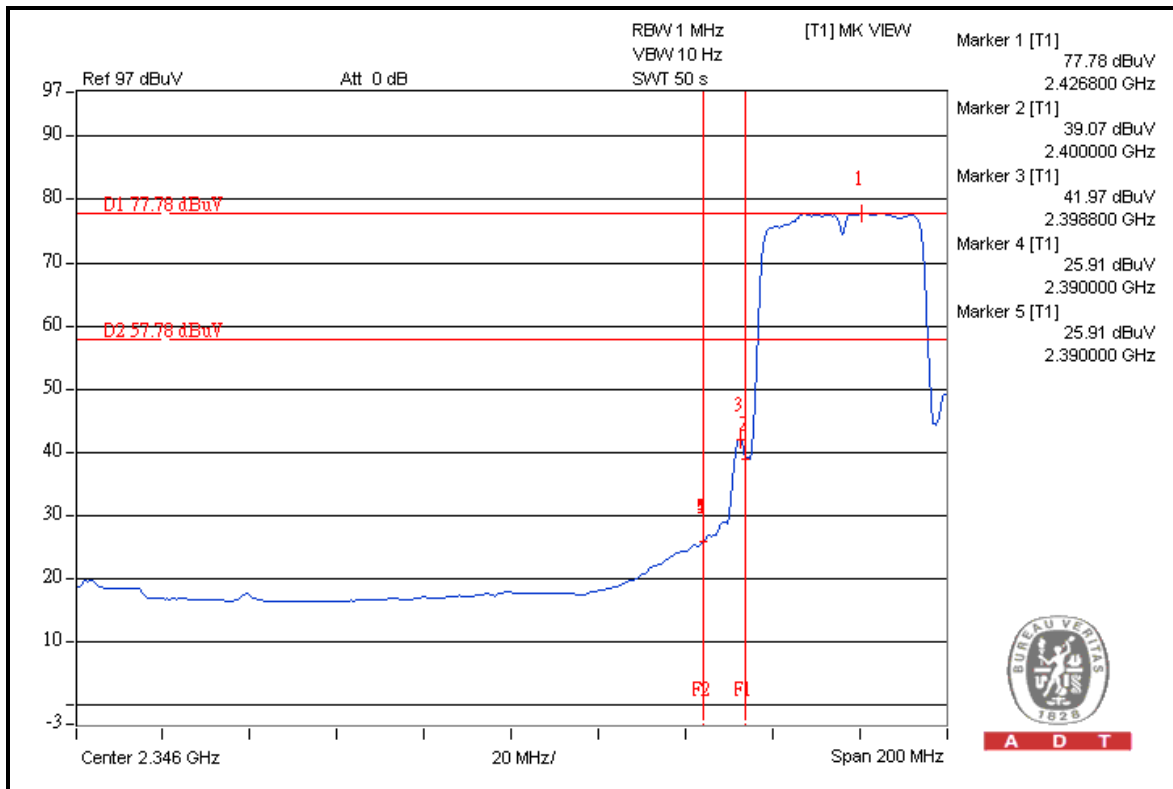

A D T



A D T

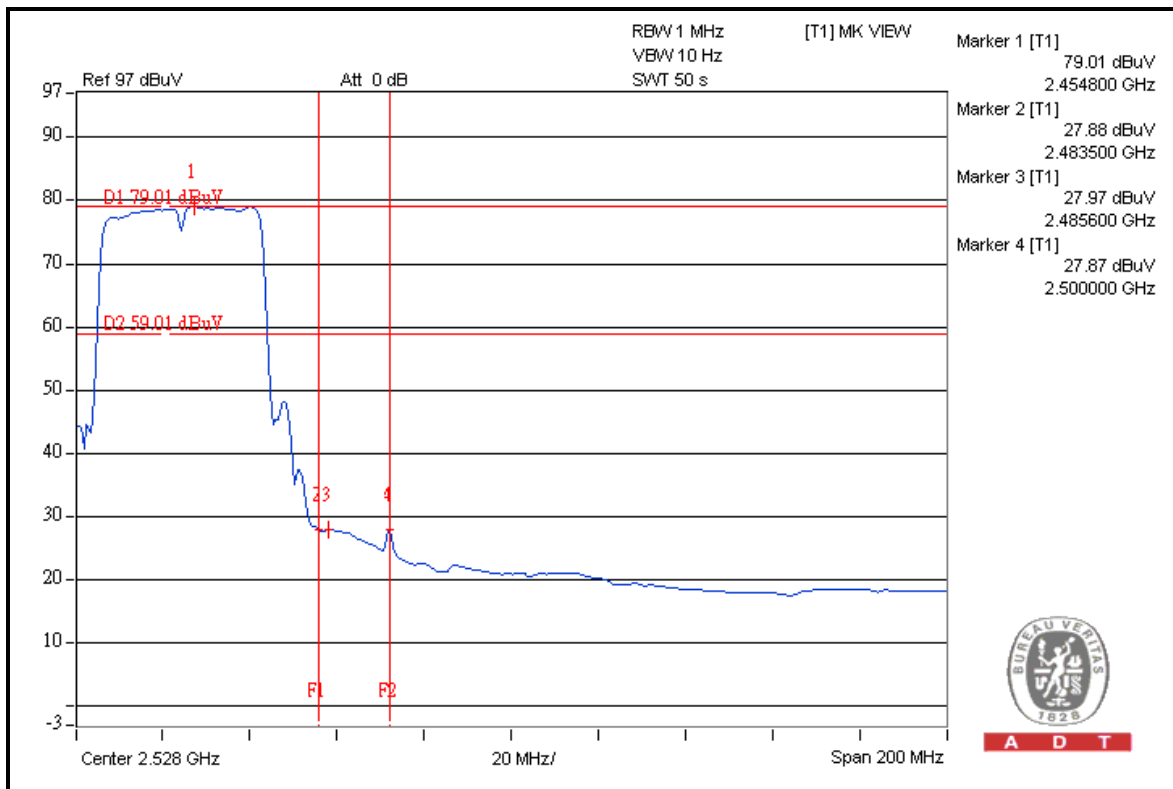
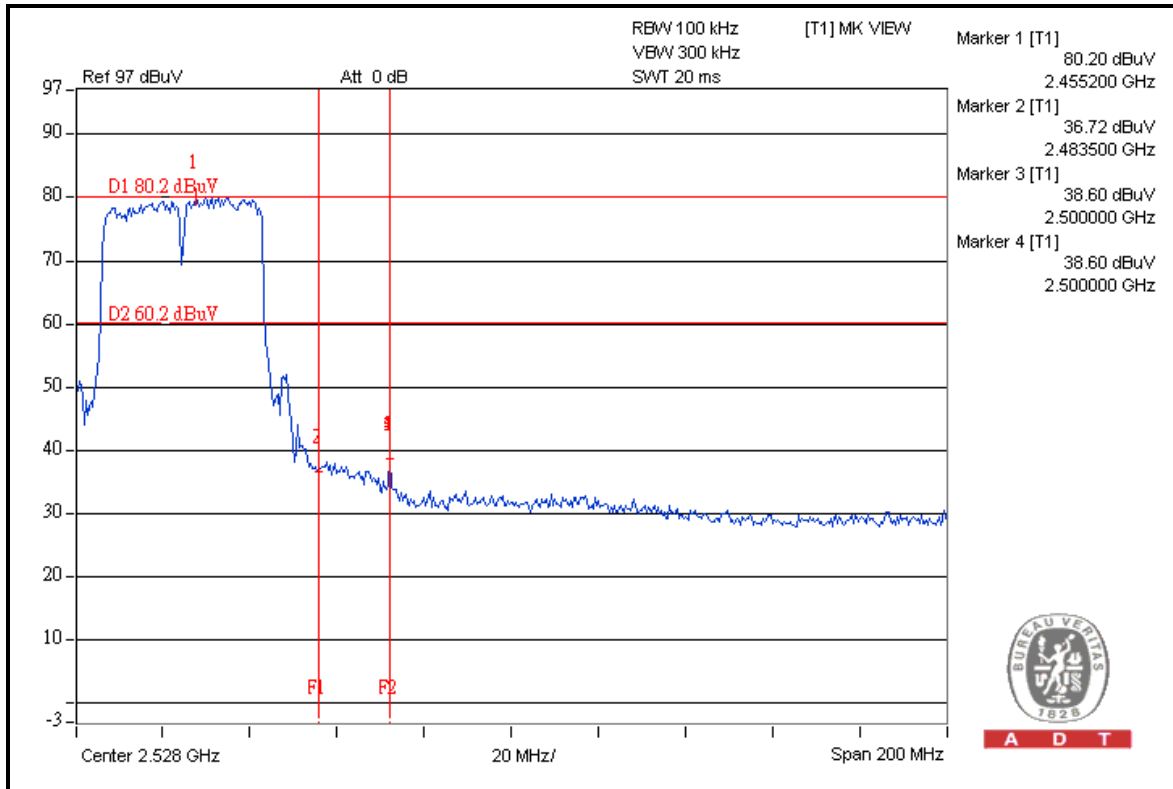



A D T

FOR CONDUCTED MEASURED

CHAIN 0

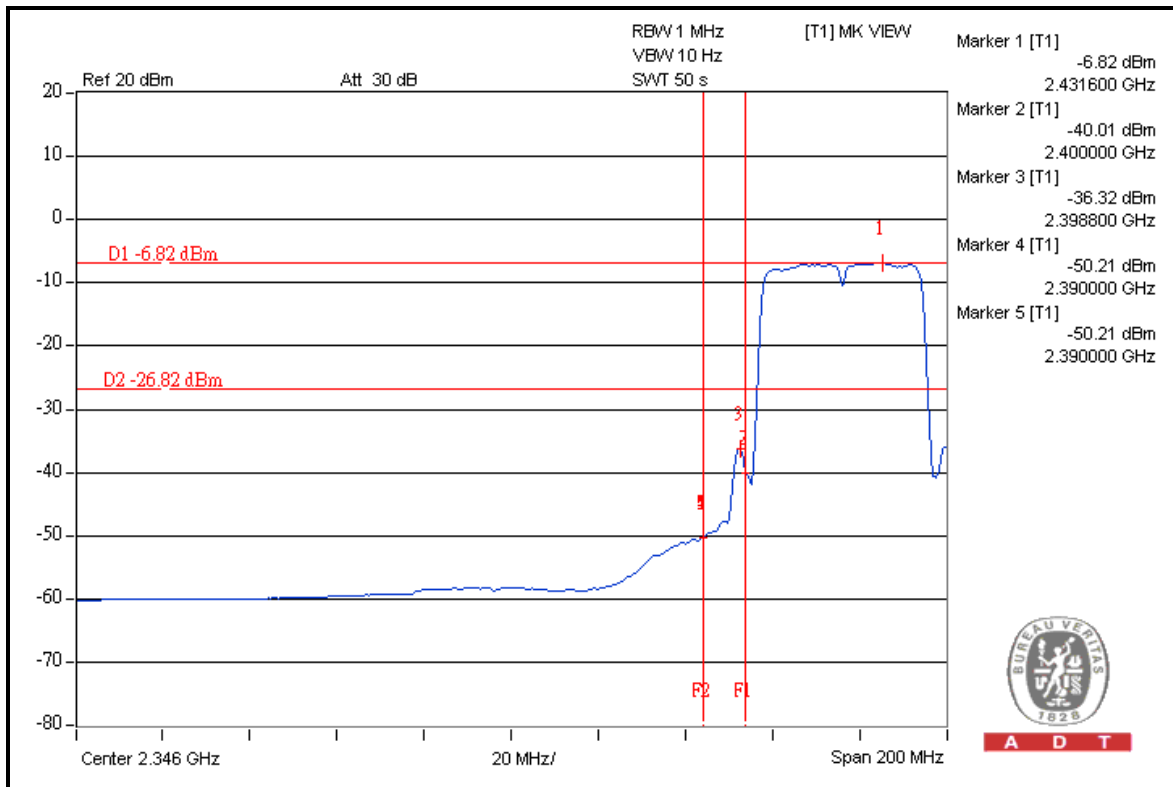
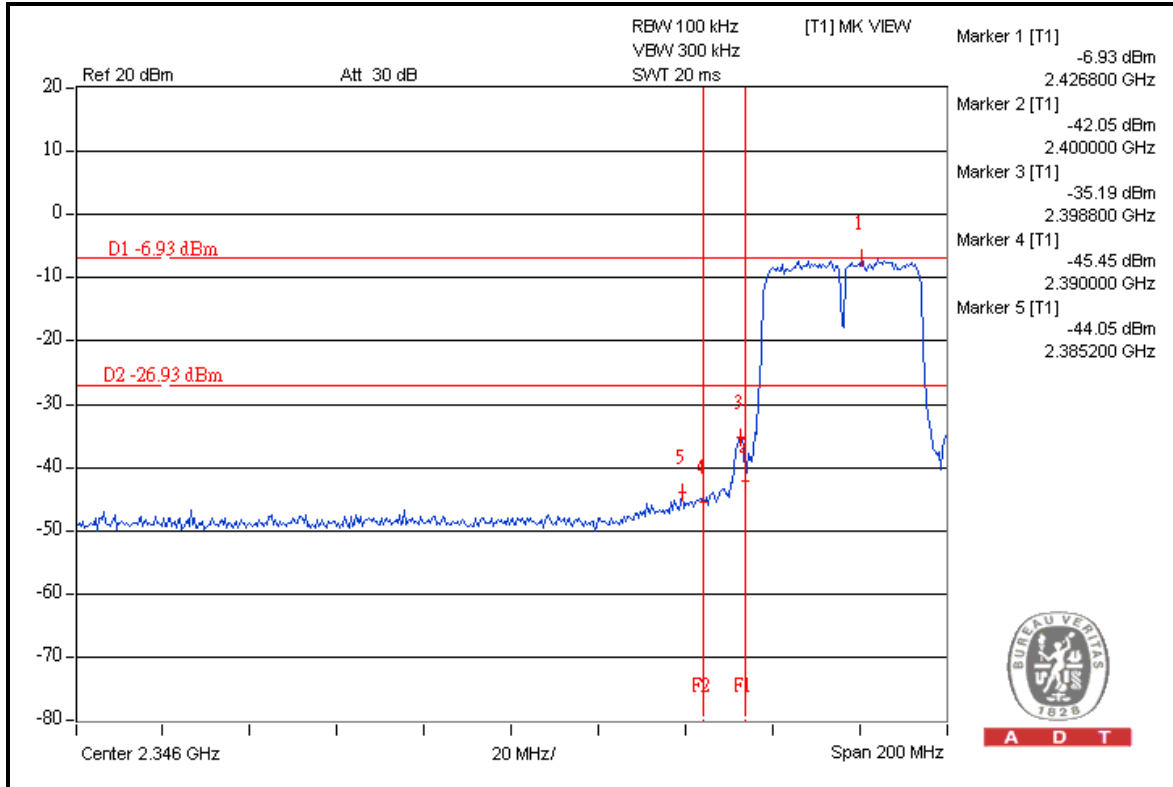



A D T

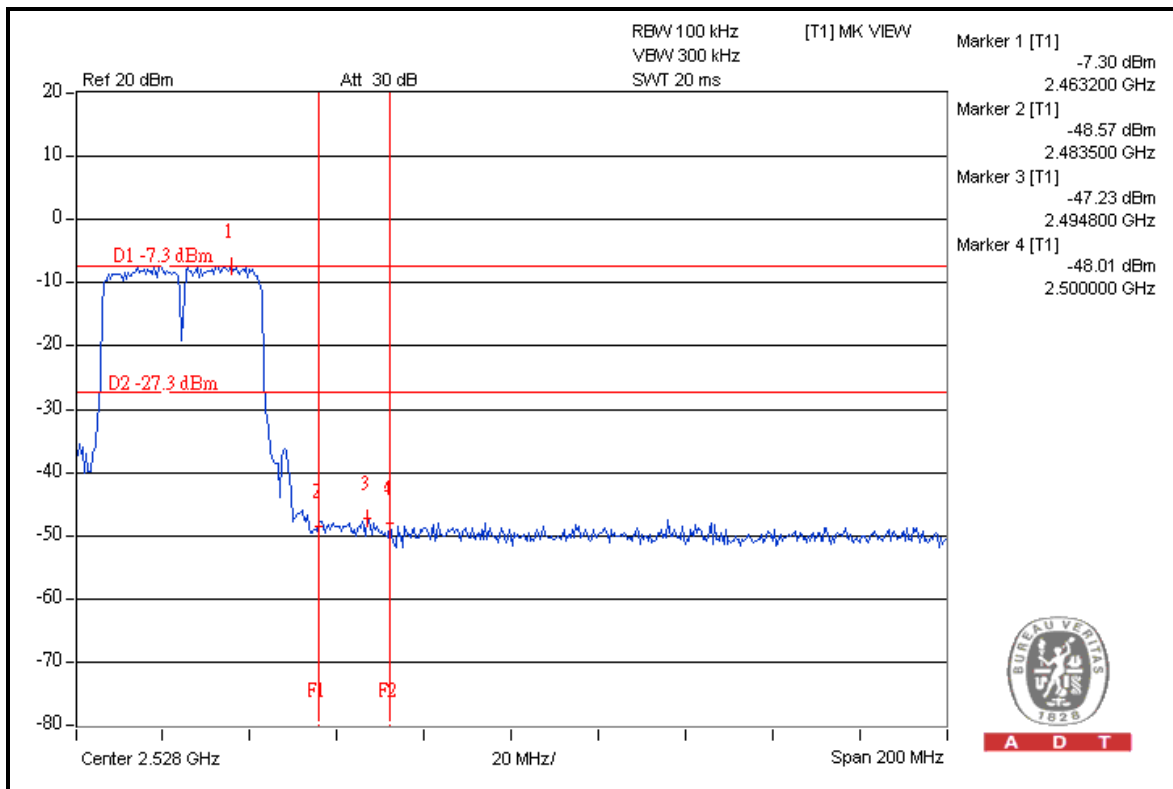
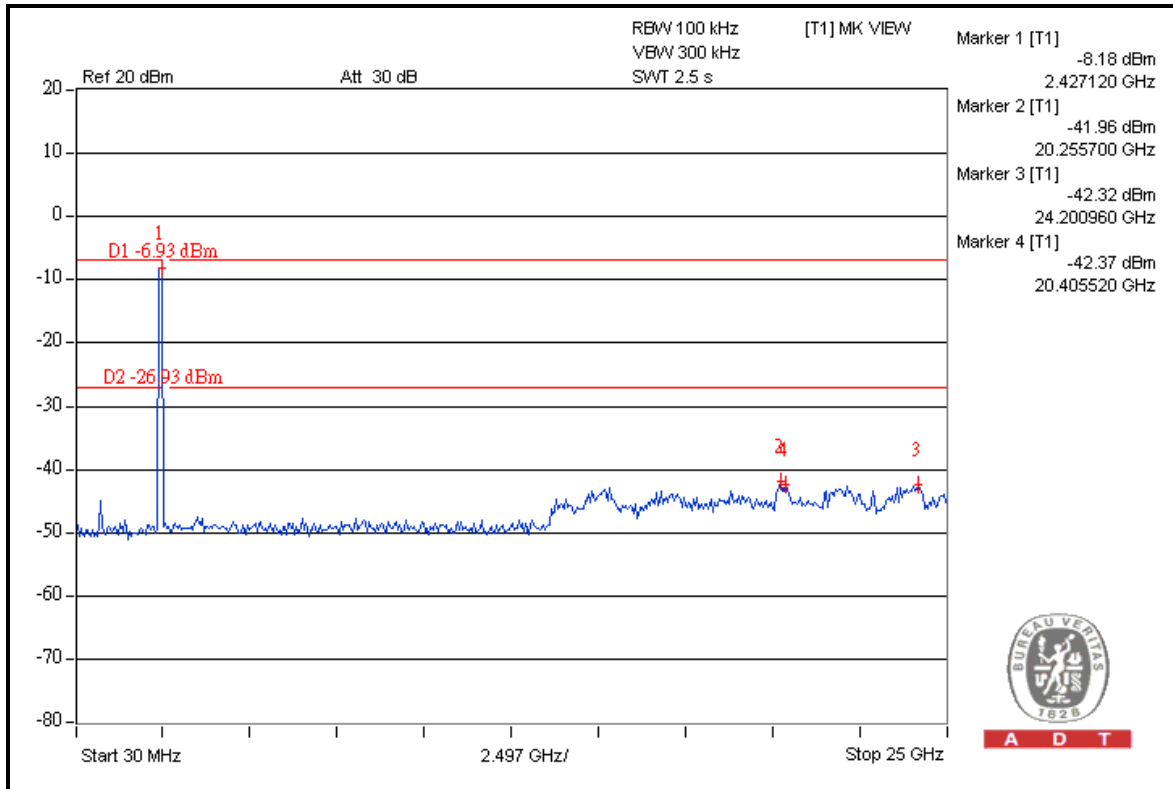



A D T

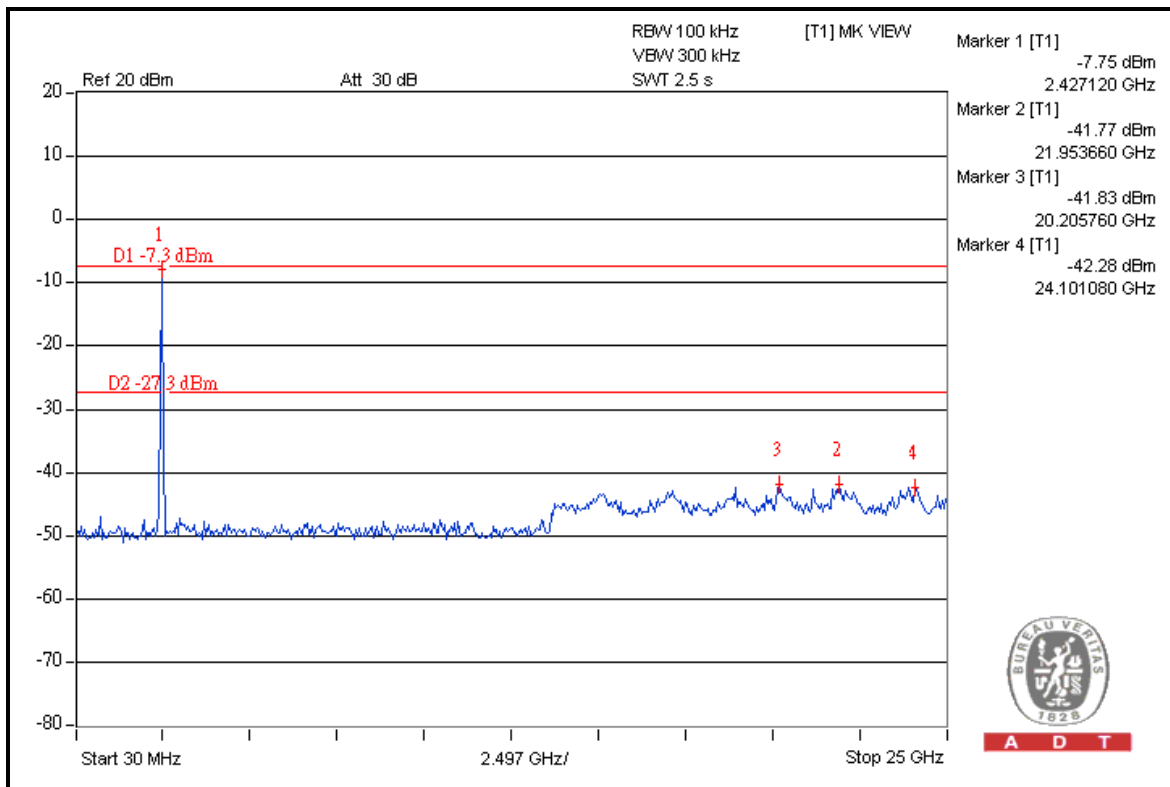
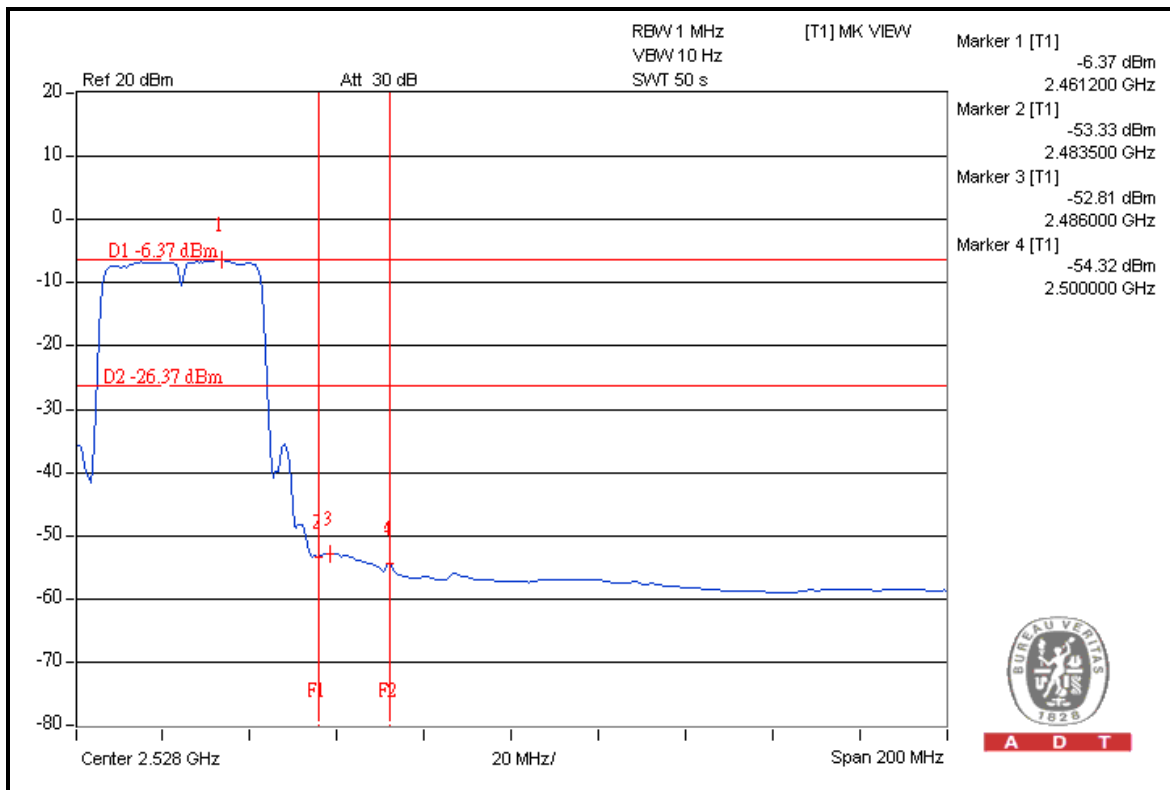



A D T

CHAIN 1

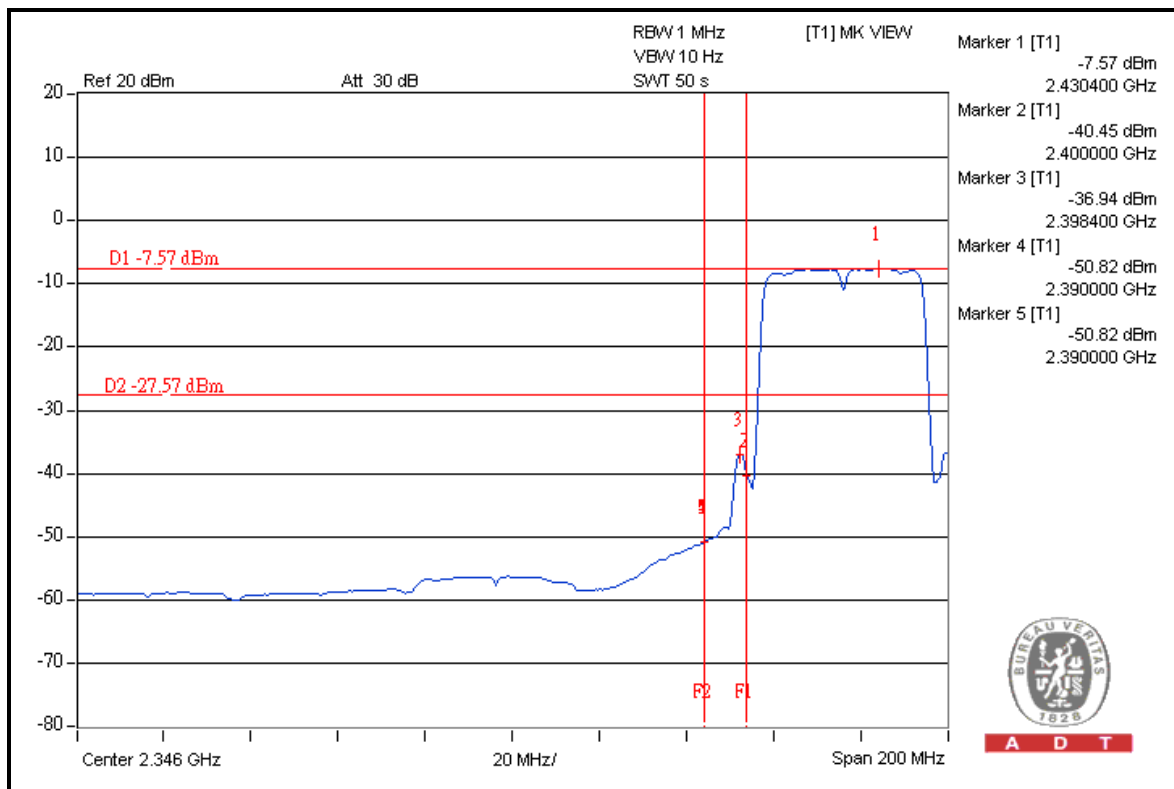
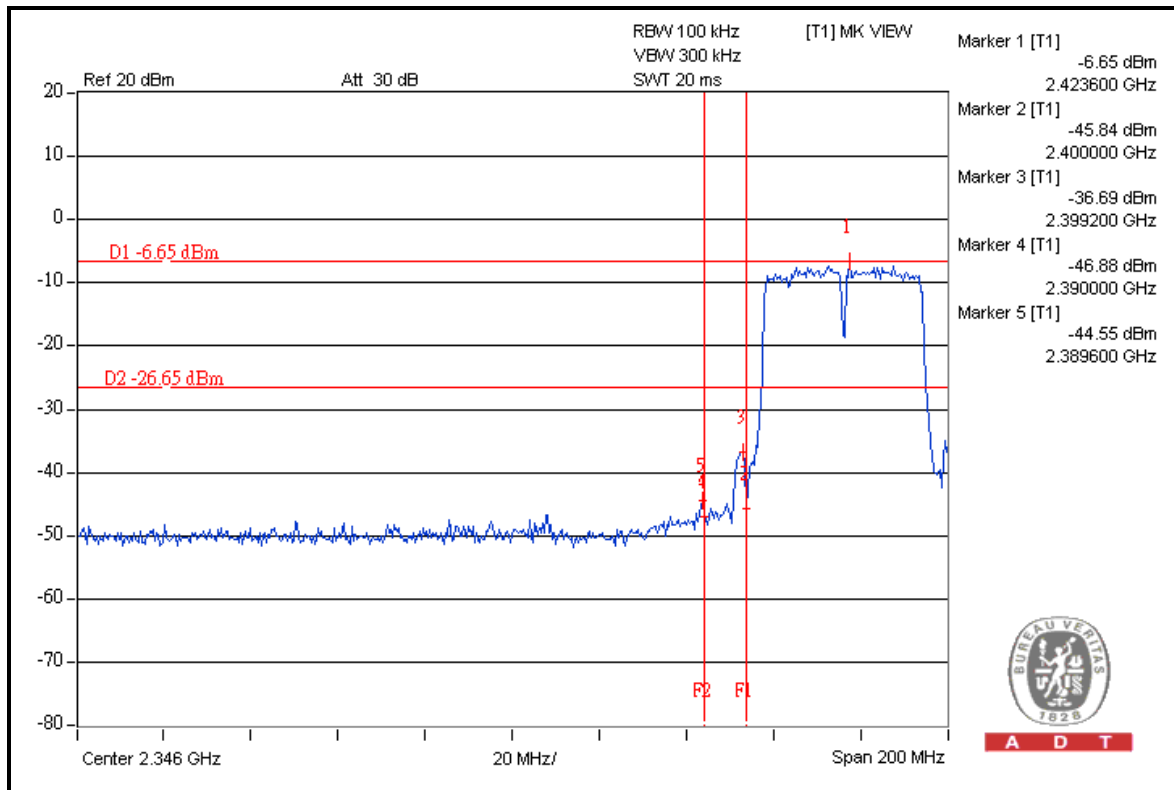



A D T

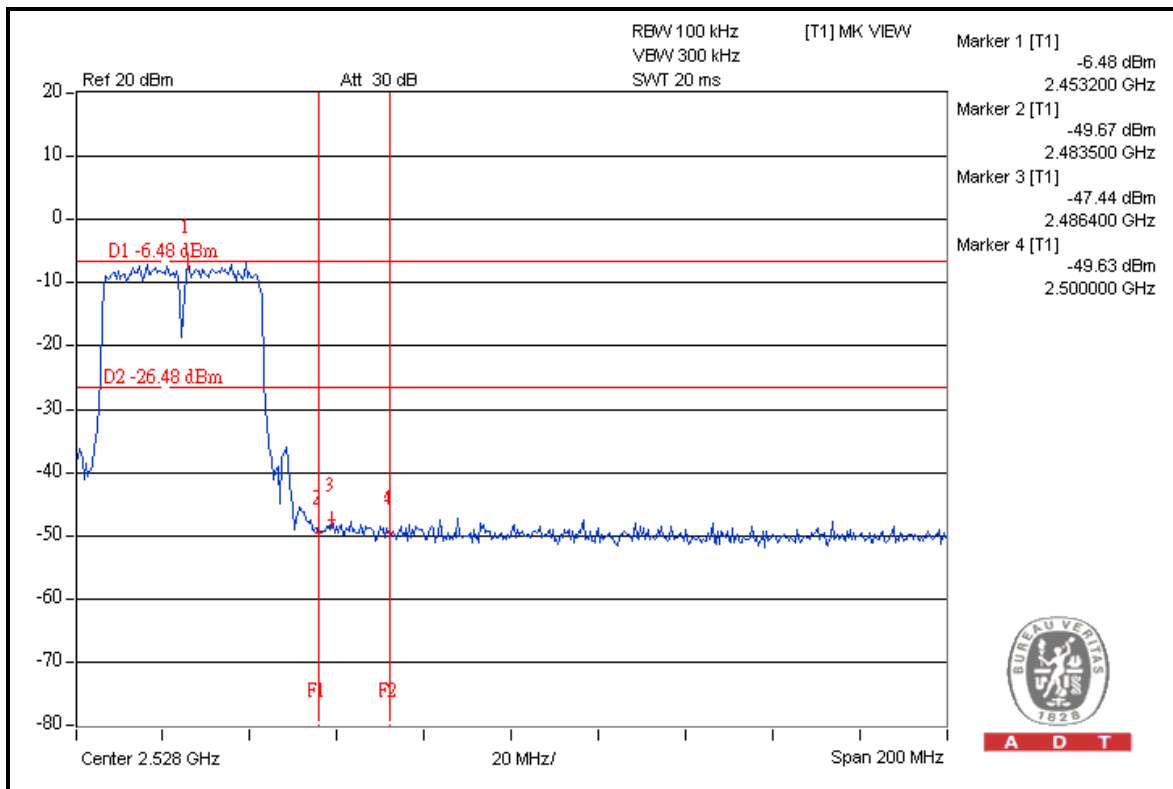
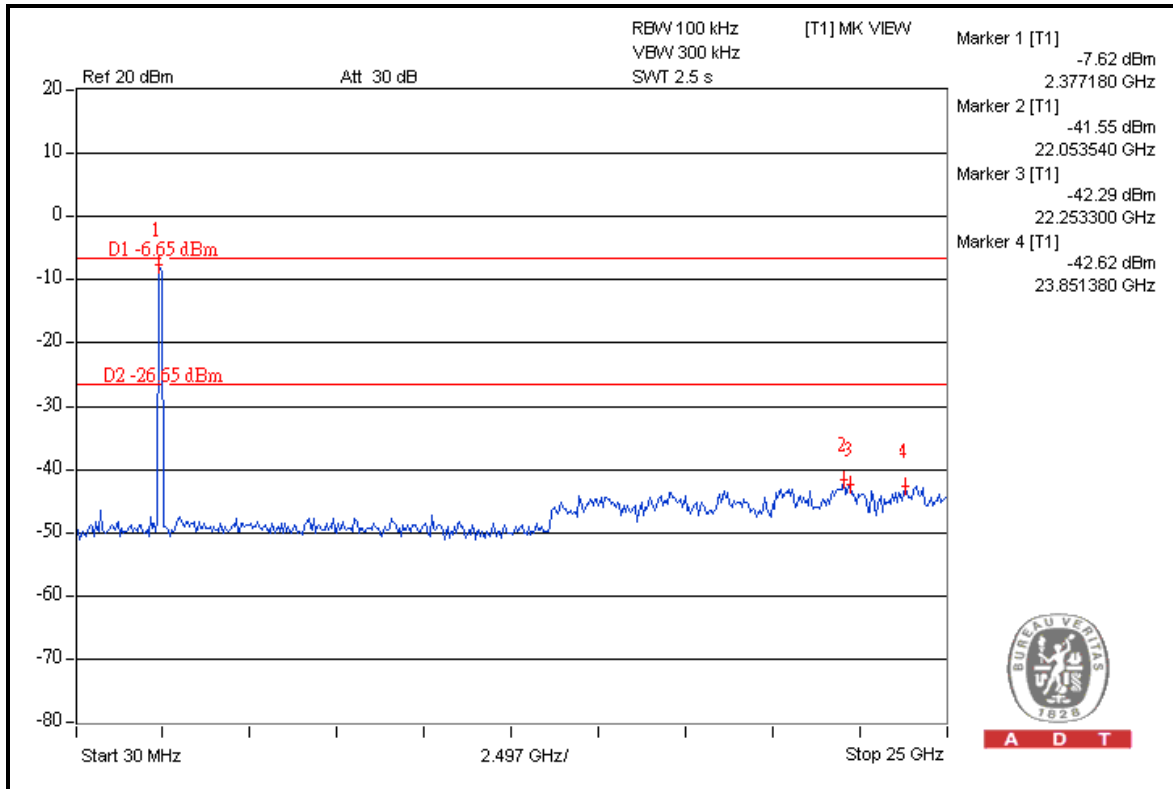



A D T

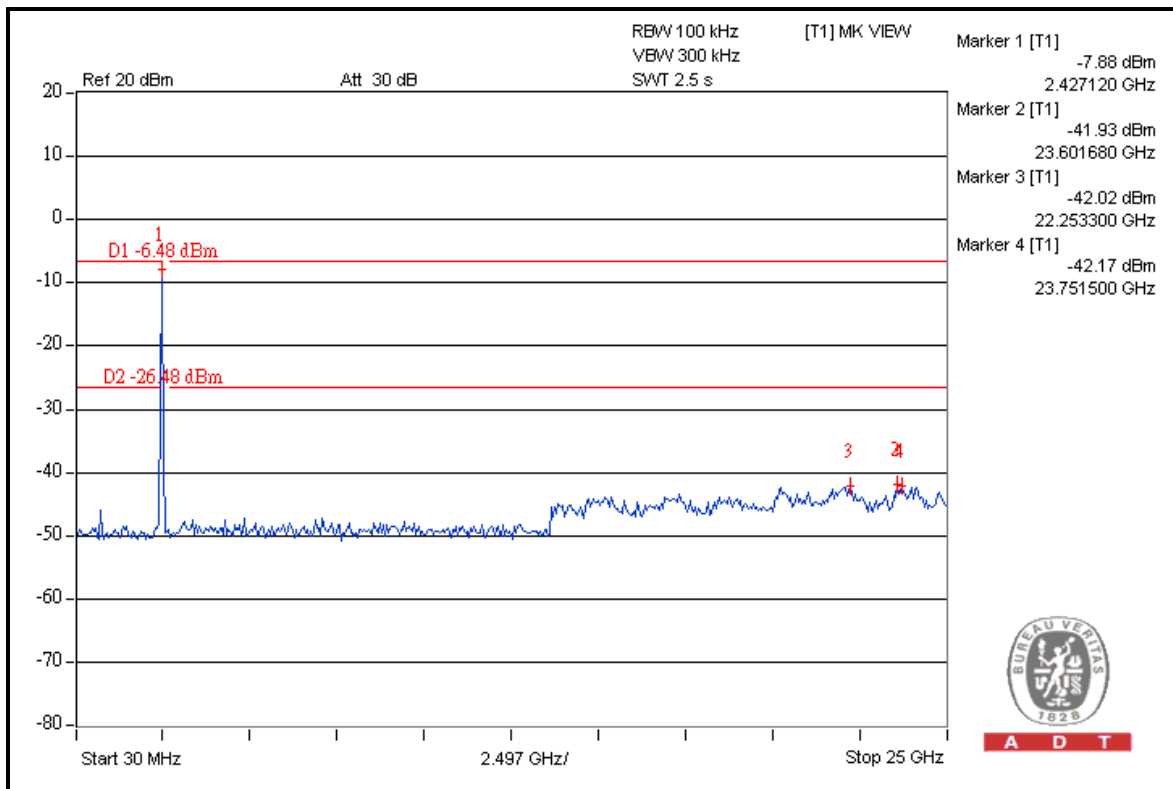
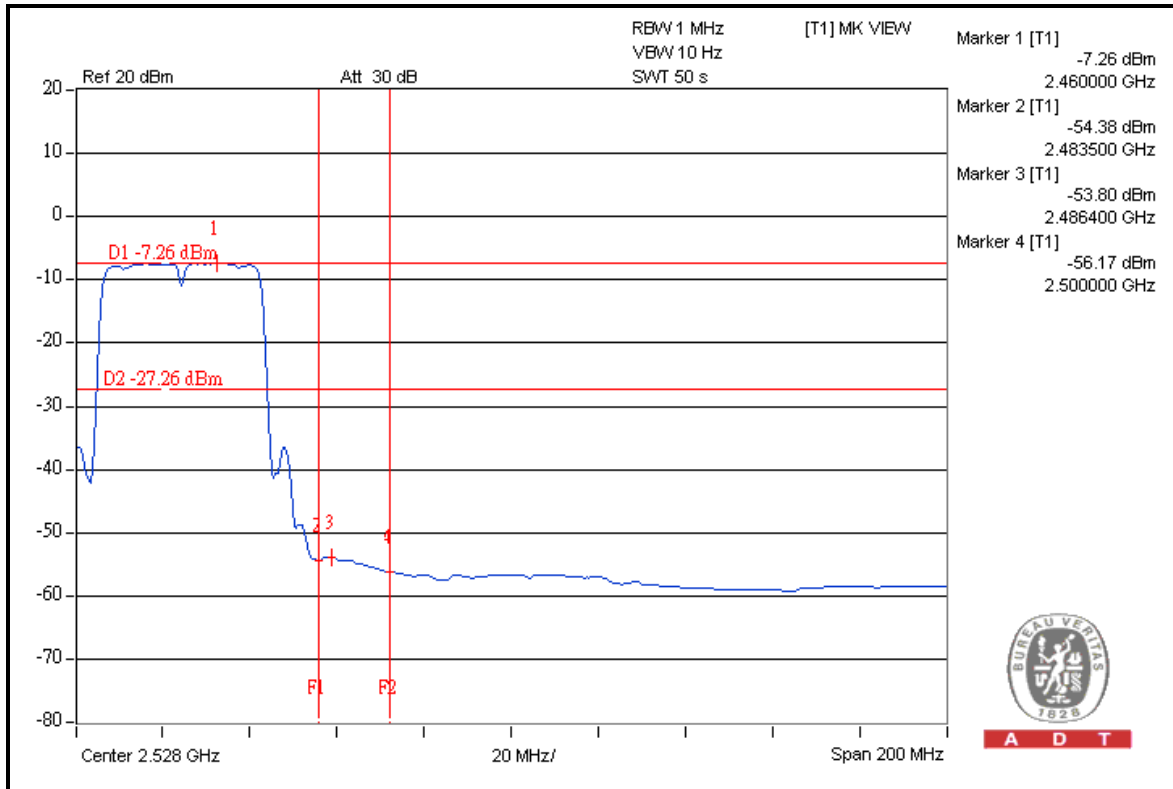



A D T

5. PHOTOGRAPHS OF THE TEST CONFIGURATION

Please refer to the attached file (Test Setup Photo).



A D T

6. INFORMATION ON THE TESTING LABORATORIES

We, Bureau Veritas Consumer Products Services (H.K.) Ltd., Taoyuan Branch, were founded in 1988 to provide our best service in EMC, Radio, Telecom and Safety consultation. Our laboratories are accredited and approved according to ISO/IEC 17025.

Copies of accreditation and authorization certificates of our laboratories obtained from approval agencies can be downloaded from our web site: www.adt.com.tw/index.5.phtml. If you have any comments, please feel free to contact us at the following:

Linko EMC/RF Lab:

Tel: 886-2-26052180

Fax: 886-2-26051924

Hsin Chu EMC/RF Lab:

Tel: 886-3-5935343

Fax: 886-3-5935342

Hwa Ya EMC/RF/Safety Telecom Lab:

Tel: 886-3-3183232

Fax: 886-3-3185050

Email: service.adt@tw.bureauveritas.com

Web Site: www.adt.com.tw

The address and road map of all our labs can be found in our web site also.



A D T

7. APPENDIX A - MODIFICATIONS RECORDERS FOR ENGINEERING CHANGES TO THE EUT BY THE LAB

No any modifications are made to the EUT by the lab during the test.

---END---