



# FCC TEST REPORT

**REPORT NO.:** RF930908H01B  
**MODEL NO.:** SpeedTouch 121g  
**RECEIVED:** Sep. 17, 2004  
**TESTED:** Oct. 04 to 05, 2004

**APPLICANT:** Thomson Telecom Belgium  
**ADDRESS:** Prins Boudewijnlaan 47, B-2650 Edegem, Belgium

**ISSUED BY:** Advance Data Technology Corporation  
**LAB LOCATION:** No. 81-1, Lu Liao Keng, 9 Ling, Wu Lung Tsuen,  
Chiung Lin Hsiang, Hsin Chu Hsien, Taiwan,  
R.O.C.

This test report consists of 59 pages in total. It may be duplicated completely for legal use with the approval of the applicant. It should not be reproduced except in full, without the written approval of our laboratory. The client should not use it to claim product endorsement by CNLA, A2LA or any government agencies. The test results in the report only apply to the tested sample. The test results in this report are traceable to the national or international standards.



0536  
ILAC MRA



No. 2177-01



## Table of Contents

1	CERTIFICATION .....	4
2	SUMMARY OF TEST RESULTS.....	5
3	GENERAL INFORMATION .....	6
3.1	GENERAL DESCRIPTION OF EUT.....	6
3.2	DESCRIPTION OF TEST MODES.....	7
3.3	GENERAL DESCRIPTION OF APPLIED STANDARDS .....	7
3.4	DESCRIPTION OF SUPPORT UNITS.....	8
3.5	CONFIGURATION OF SYSTEM UNDER TEST .....	8
4	TEST TYPES AND RESULTS.....	9
4.1	CONDUCTED EMISSION MEASUREMENT .....	9
4.1.1	LIMITS OF CONDUCTED EMISSION MEASUREMENT .....	9
4.1.2	TEST INSTRUMENTS .....	9
4.1.3	TEST PROCEDURES.....	10
4.1.4	TEST SETUP .....	10
4.1.5	EUT OPERATING CONDITIONS.....	11
4.1.6	TEST RESULTS.....	12
4.2	RADIATED EMISSION MEASUREMENT .....	14
4.2.1	LIMITS OF RADIATED EMISSION MEASUREMENT .....	14
4.2.2	TEST INSTRUMENTS .....	15
4.2.3	TEST PROCEDURES.....	16
4.2.4	TEST SETUP .....	17
4.2.5	EUT OPERATING CONDITIONS.....	17
4.2.6	TEST RESULTS.....	18
4.2.7	TEST RESULTS - DSSS.....	19
4.2.8	TEST RESULTS -OFDM .....	22
4.3	6DB BANDWIDTH MEASUREMENT .....	25
4.3.1	LIMITS OF 6DB BANDWIDTH MEASUREMENT .....	25
4.3.2	TEST INSTRUMENTS .....	25
4.3.3	TEST PROCEDURE .....	26
4.3.4	TEST SETUP .....	26
4.3.5	EUT OPERATING CONDITIONS.....	26
4.3.6	TEST RESULTS-DSSS.....	27
4.3.7	TEST RESULTS-OFDM .....	31
4.4	MAXIMUM PEAK OUTPUT POWER .....	35
4.4.1	LIMITS OF MAXIMUM PEAK OUTPUT POWER MEASUREMENT .....	35



4.4.2 TEST INSTRUMENTS ..... 35

4.4.3 TEST PROCEDURES..... 36

4.4.4 TEST SETUP ..... 36

4.4.5 EUT OPERATING CONDITIONS..... 36

4.4.6 TEST RESULTS- DSSS..... 37

4.4.7 TEST RESULTS- OFDM ..... 38

4.5 POWER SPECTRAL DENSITY MEASUREMENT..... 39

4.5.1 LIMITS OF POWER SPECTRAL DENSITY MEASUREMENT ..... 39

4.5.2 TEST INSTRUMENTS ..... 39

4.5.3 TEST PROCEDURE ..... 40

4.5.4 TEST SETUP ..... 40

4.5.5 EUT OPERATING CONDITIONS..... 40

4.5.6 TEST RESULTS-DSSS..... 41

4.5.7 TEST RESULTS-OFDM ..... 45

4.6 BAND EDGES MEASUREMENT ..... 49

4.6.1 LIMITS OF BAND EDGES MEASUREMENT ..... 49

4.6.2 TEST INSTRUMENTS ..... 49

4.6.3 TEST PROCEDURE ..... 49

4.6.4 EUT OPERATING CONDITION ..... 49

4.6.5 TEST RESULTS - DSSS..... 50

4.6.6 TEST RESULTS-OFDM ..... 53

4.7 ANTENNA REQUIREMENT..... 56

4.7.1 STANDARD APPLICABLE ..... 56

4.7.2 ANTENNA CONNECTED CONSTRUCTION..... 56

5 PHOTOGRAPHS OF THE TEST CONFIGURATION..... 57

6 INFORMATION ON THE TESTING LABORATORIES ..... 59



## 1 CERTIFICATION

**PRODUCT :** Wireless USB Adapter  
**TRADEMARK :** THOMSON  
**MODEL NO. :** SpeedTouch 121g  
**TESTED:** Oct. 04 to 05, 2004  
**APPLICANT :** Thomson Telecom Belgium  
**TEST ITEM:** ENGINEERING SAMPLE  
**STANDARDS :** 47 CFR Part 15, Subpart C (Section 15.247),  
ANSI C63.4- 2001

The above equipment (Model: SpeedTouch 121g) has been tested by **Advance Data Technology Corporation**, and found compliance with the requirement of the above standards. The test record, data evaluation & Equipment Under Test (EUT) configurations represented herein are true and accurate accounts of the measurements of the sample's EMC characteristics under the conditions specified in this report.

**PREPARED BY :** Carol Liao , **DATE:** Oct. 06, 2004  
( Carol Liao )

**TECHNICAL ACCEPTANCE :** Hank Chung , **DATE:** Oct. 06, 2004  
Responsible for RF ( Hank Chung )

**APPROVED BY :** Eric Lin , **DATE:** Oct. 06, 2004  
( Eric Lin, Manager )



## 2 SUMMARY OF TEST RESULTS

The EUT has been tested according to the following specifications:

<b>APPLIED STANDARD: 47 CFR Part 15, Subpart C</b>			
<b>Standard Section</b>	<b>Test Type and Limit</b>	<b>Result</b>	<b>REMARK</b>
15.207	AC Power Conducted Emission	PASS	Meet the requirement of limit Minimum passing margin is -15.03 dBuV at 0.177 MHz
15.247(a)(2)	Spectrum Bandwidth of a Direct Sequence Spread Spectrum System Limit: min. 500kHz	PASS	Meet the requirement of limit
15.247(b)	Maximum Peak Output Power Limit: max. 30dBm	PASS	Meet the requirement of limit
15.247(c)	Transmitter Radiated Emissions Limit: Table 15.209	PASS	Meet the requirement of limit Minimum passing margin is -4.10 dBuV at 2483.50MHz
15.247(d)	Power Spectral Density Limit: max. 8dBm	PASS	Meet the requirement of limit
15.247(c)	Band Edge Measurement Limit: 20 dB less than the peak value of fundamental frequency	PASS	Meet the requirement of limit



### 3 GENERAL INFORMATION

#### 3.1 GENERAL DESCRIPTION OF EUT

<b>PRODUCT</b>	Wireless USB Adapter
<b>MODEL NO.</b>	SpeedTouch 121g
<b>POWER SUPPLY</b>	DC 4.75 V ~ 5.25 V from host equipment
<b>MODULATION TYPE</b>	CCK, OFDM
<b>RADIO TECHNOLOGY</b>	DSSS, OFDM
<b>TRANSFER RATE</b>	1/2/5.5/6/9/11/12/18/24/36/48/54Mbps
<b>FREQUENCY RANGE</b>	2412MHz ~ 2462MHz
<b>NUMBER OF CHANNEL</b>	11
<b>OUTPUT POWER</b>	17.22dBm
<b>ANTENNA TYPE</b>	PCB antenna
<b>DATA CABLE</b>	NA
<b>I/O PORTS</b>	USB Port x 1
<b>ASSOCIATED DEVICES</b>	NA

**NOTE:**

1. The EUT operates in the 2.4GHz frequency spectrum with throughput of up to 54Mbps.
2. The EUT complies with IEEE 802.11g draft standards, and backwards compatible with IEEE 802.11b products.
3. The above EUT information was declared by the manufacturer and for more detailed features description, please refer to the manufacturer's specifications or User's Manual.



### 3.2 DESCRIPTION OF TEST MODES

Eleven channels are provided in this EUT.

Channel	Frequency	Channel	Frequency
1	2412 MHz	7	2442 MHz
2	2417 MHz	8	2447 MHz
3	2422 MHz	9	2452 MHz
4	2427 MHz	10	2457 MHz
5	2432 MHz	11	2462 MHz
6	2437 MHz		

**NOTE:**

1. Below 1 GHz, the channel 1, 6, and 11 were pre-tested in chamber. The channel 11, worst case one, was chosen for final test.
2. Above 1 GHz, the channel 1, 6, and 11 were tested individually.
3. Transfer rate, 11Mbps with CCK technique and 6Mbps with OFDM technique, the worst case, were chosen for final test.

### 3.3 GENERAL DESCRIPTION OF APPLIED STANDARDS

The EUT is a Wireless USB Adapter. According to the specifications of the manufacturer, it must comply with the requirements of the following standards:

**47 CFR Part 15, Subpart C. (15.247)**  
**ANSI C63.4 : 2001**

All tests have been performed and recorded as per the above standards.

**NOTE:** The EUT is also considered as a kind of computer peripheral, because the connection to computer is necessary for typical use. It has been verified to comply with the requirements of 47 CFR Part 15, Subpart B, Class B (DoC). The test report has been issued separately.



### 3.4 DESCRIPTION OF SUPPORT UNITS

The EUT has been tested as an independent unit together with other necessary accessories or support units. The following support units or accessories were used to form a representative test configuration during the tests.

NO.	PRODUCT	BRAND	MODEL NO.	SERIAL NO.	FCC ID
1	Notebook Computer	DELL	C600	6DRV601	FCC DoC
2	PRINTER	HP	C2642A	MY79F1C3MZ	B94C2642X
3	MODEM	ACEEX	1414	0206026776	IFAXDM1414

NO.	SIGNAL CABLE DESCRIPTION OF THE ABOVE SUPPORT UNITS
1	NA
2	1.8m braid shielded wire, terminated with DB25 and Centronics connector via metallic frame, w/o core
3	1.0 m braid shielded wire, terminated with DB25 and DB9 connector via metallic frame, w/o core.

**NOTE:** All power cords of the above support units are non-shielded (1.8m).

### 3.5 CONFIGURATION OF SYSTEM UNDER TEST

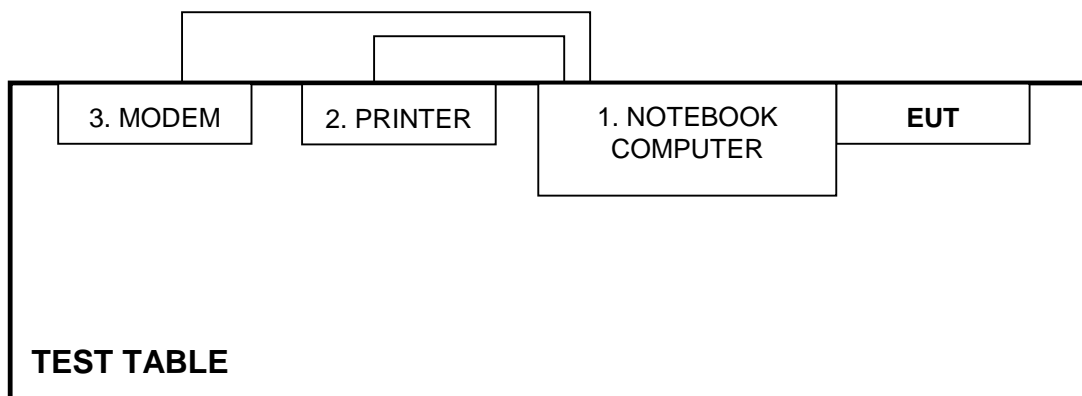

**NOTE:** 1. Please refer to the photos of test configuration in Item 5 also.





## 4 TEST TYPES AND RESULTS

### 4.1 CONDUCTED EMISSION MEASUREMENT

#### 4.1.1 LIMITS OF CONDUCTED EMISSION MEASUREMENT

FREQUENCY OF EMISSION (MHz)	CONDUCTED LIMIT (dB $\mu$ V)	
	Quasi-peak	Average
0.15-0.5	66 to 56	56 to 46
0.5-5	56	46
5-30	60	50

**NOTE:**

1. The lower limit shall apply at the transition frequencies.
2. All emanations from a class B digital device or system, including any network of conductors and apparatus connected thereto, shall not exceed the level of field strengths specified above.

#### 4.1.2 TEST INSTRUMENTS

DESCRIPTION & MANUFACTURER	MODEL NO.	SERIAL NO.	CALIBRATED UNTIL
ROHDE & SCHWARZ Test Receiver	ESCS 30	847124/029	Dec. 04, 2004
ROHDE & SCHWARZ LISN (for EUT)	ESHS-Z5	848773/004	Nov. 04, 2004
KYORITSU LISN (for peripheral)	KNW-407	8/1395/12	Jul. 23, 2005
RF Cable (JETBAO)	RG233/U	Cable_CA_01	Jul. 02, 2005
Terminator(for KYORITSU)	50	3	May 10, 2005
Software	Cond-V2e	NA	NA

**NOTE:**

1. The calibration interval of the above test instruments is 12 months and the calibrations are traceable to NML/ROC and NIST/USA.
2. The test was performed in ADT Shielded Room No. A.
3. The VCCI Con A Registration No. is C-817.
4. \* = These equipment are used for the final measurement.
5. The measurement uncertainty is 2.53 dB, which is calculated as per the document CISPR 16-4

#### 4.1.3 TEST PROCEDURES

- a. The EUT/HOST was placed 0.4 meters from the conducting wall of the shielded room with EUT/HOST being connected to the power mains through a line impedance stabilization network (LISN). Other support units were connected to the power mains through another LISN. The two LISNs provide 50 ohm/ 50uH of coupling impedance for the measuring instrument.
- b. Both lines of the power mains connected to the EUT/HOST were checked for maximum conducted interference.
- c. The frequency range from 150 kHz to 30 MHz was searched. Emission levels over 10dB under the prescribed limits could not be reported

#### 4.1.4 TEST SETUP

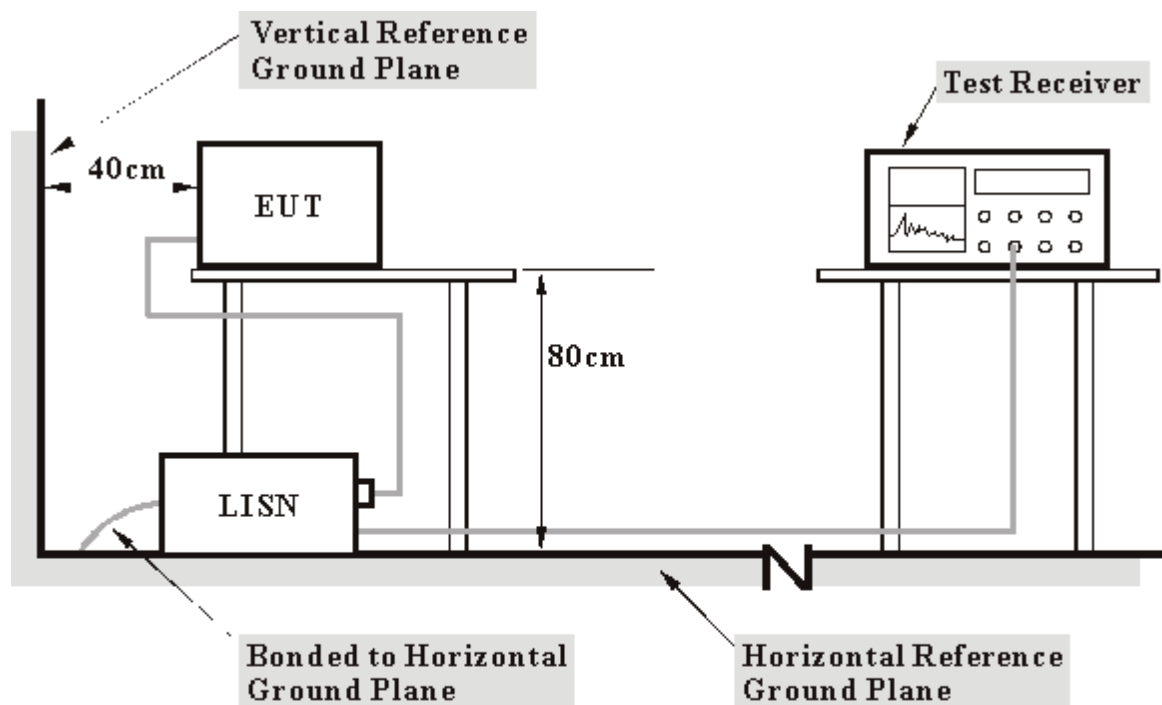

- Note:**
1. Support units were connected to second LISN.
  2. Both of LISNs (AMN) 80 cm from EUT and at the least 80 cm from other units and other metal planes support units.

For the actual test configuration, please refer to the related item – Photographs of the Test Configuration.



#### 4.1.5 EUT OPERATING CONDITIONS

- a. Plug the EUT into support unit 1 (Notebook computer) which placed on a testing table.
- b. The support unit 1 (Notebook computer) ran a test program "CTxRx 2.1.0.0" to enable EUT under transmission condition continuously at specific channel frequency.
- c. Notebook computer sends "H" messages to modem.
- d. Notebook computer sends "H" messages to printer, and the printer prints them on paper.



### 4.1.6 TEST RESULTS

The EUT was pre-tested under CCK & OFDM modulation type. The OFDM modulation type, worst case one, was chosen for final test.

<b>EUT</b>	Wireless USB Adapter	<b>MODEL</b>	SpeedTouch 121g
<b>MODE</b>	Channel 11	<b>6dB BANDWIDTH</b>	9 kHz
<b>INPUT POWER (SYSTEM)</b>	120Vac, 60 Hz	<b>PHASE</b>	Line (L)
<b>ENVIRONMENTAL CONDITIONS</b>	27 deg. C, 59%RH, 978 hPa	<b>TESTED BY</b>	Tony Chen

No	Freq. [MHz]	Corr. Factor (dB)	Reading Value [dB (uV)]		Emission Level [dB (uV)]		Limit [dB (uV)]		Margin (dB)	
			Q.P.	AV.	Q.P.	AV.	Q.P.	AV.	Q.P.	AV.
1	0.154	0.21	47.71	-	47.92	-	65.79	55.79	-17.87	-
<b>2</b>	<b>0.177</b>	<b>0.25</b>	<b>49.32</b>	-	<b>49.57</b>	-	<b>64.61</b>	<b>54.61</b>	<b>-15.03</b>	-
3	0.232	0.28	42.40	-	42.68	-	62.38	52.38	-19.69	-
4	0.349	0.23	36.56	-	36.79	-	58.98	48.98	-22.20	-
5	0.466	0.21	36.25	-	36.46	-	56.58	46.58	-20.12	-
6	0.841	0.27	35.59	-	35.86	-	56.00	46.00	-20.14	-

- NOTES:** (1) "\*\*": Undetectable  
 (2) Q.P. and AV. are abbreviations of quasi-peak and average.  
 (3) "-": The Quasi-peak reading value also meets an average limit, thus measurement with the average detector is unnecessary.  
 (4) The emission levels of other frequencies were very low against the limit.  
 (5) Correction Factor = Insertion loss + Cable loss  
 (6) Margin value = Emission level - Limit value

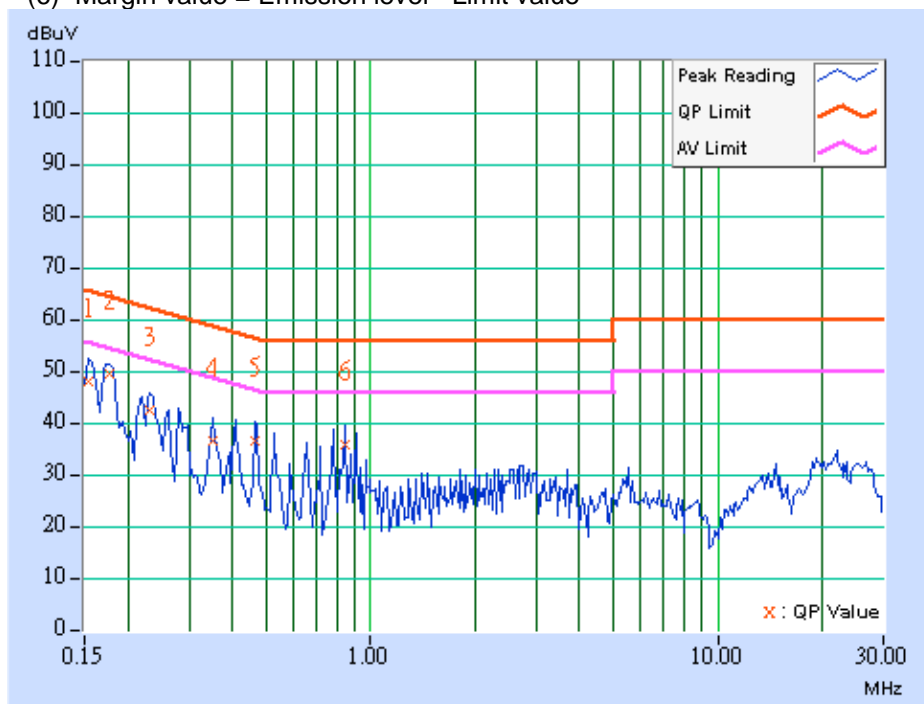



<b>EUT</b>	Wireless USB Adapter	<b>MODEL</b>	SpeedTouch 121g
<b>MODE</b>	Channel 11	<b>6dB BANDWIDTH</b>	9 kHz
<b>INPUT POWER (SYSTEM)</b>	120Vac, 60 Hz	<b>PHASE</b>	Neutral (N)
<b>ENVIRONMENTAL CONDITIONS</b>	27 deg. C, 59%RH, 978 hPa	<b>TESTED BY</b>	Tony Chen

No	Freq. [MHz]	Corr. Factor (dB)	Reading Value [dB (uV)]		Emission Level [dB (uV)]		Limit [dB (uV)]		Margin (dB)	
			Q.P.	AV.	Q.P.	AV.	Q.P.	AV.	Q.P.	AV.
1	0.158	0.22	47.43	-	47.65	-	65.58	55.58	-17.93	-
2	0.177	0.25	48.42	-	48.67	-	64.61	54.61	-15.93	-
3	0.236	0.28	41.87	-	42.15	-	62.24	52.24	-20.09	-
4	0.408	0.20	34.58	-	34.78	-	57.69	47.69	-22.91	-
5	0.779	0.26	34.13	-	34.39	-	56.00	46.00	-21.61	-
6	21.707	1.20	27.01	-	28.21	-	60.00	50.00	-31.79	-

- NOTES:**
- (1) "": Undetectable
  - (2) Q.P. and AV. are abbreviations of quasi-peak and average.
  - (3) "-": The Quasi-peak reading value also meets an average limit, thus measurement with the average detector is unnecessary.
  - (4) The emission levels of other frequencies were very low against the limit.
  - (5) Correction Factor = Insertion loss + Cable loss
  - (6) Margin value = Emission level - Limit value

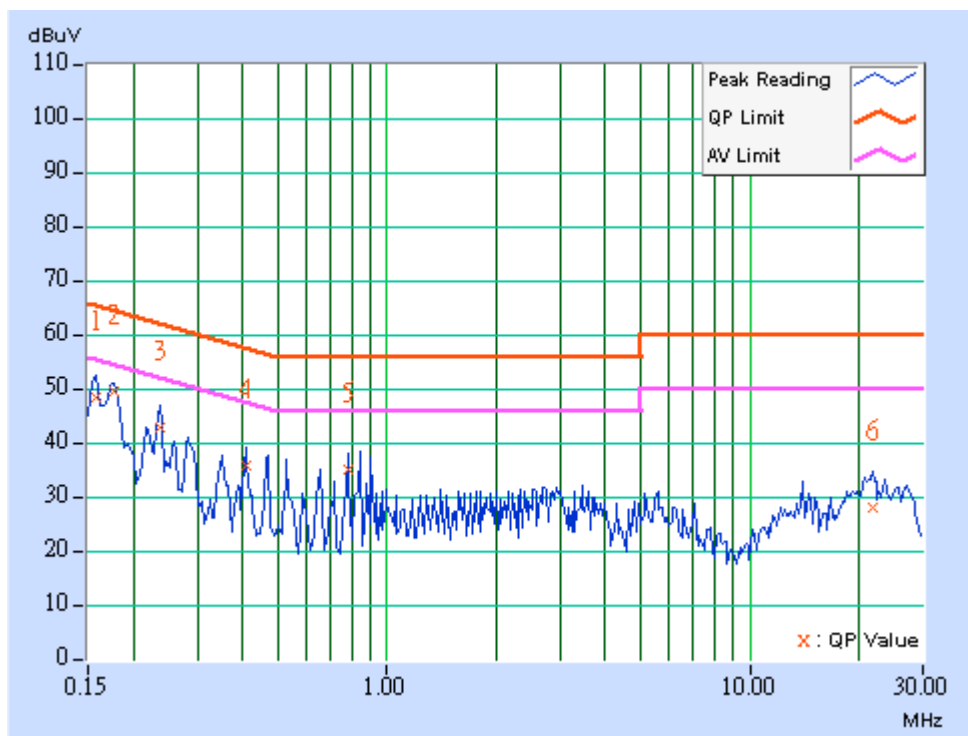



## 4.2 RADIATED EMISSION MEASUREMENT

### 4.2.1 LIMITS OF RADIATED EMISSION MEASUREMENT

Field strength limits are at the distance of 3 meters, emissions radiated outside of the specified bands, shall be according to the general radiated limits in 15.209 as following:

Frequencies (MHz)	Field strength (microvolts/meter)	Measurement distance (meters)
0.009-0.490	2400/F(kHz)	300
0.490-1.705	24000/F(kHz)	30
1.705-30.0	30	30
30-88	100	3
88-216	150	3
216-960	200	3
Above 960	500	3

**NOTE:**

1. The lower limit shall apply at the transition frequencies.
2. Emission level (dBuV/m) = 20 log Emission level (uV/m).
3. As shown in 15.35(b), for frequencies above 1000MHz, the field strength limits are based on average detector, however, the peak field strength of any emission shall not exceed the maximum permitted average limits, specified above by more than 20dB under any condition of modulation.



#### 4.2.2 TEST INSTRUMENTS

DESCRIPTION & MANUFACTURER	MODEL NO.	SERIAL NO.	CALIBRATED UNTIL
HP Spectrum Analyzer	8594ER	3829U04676	Sep. 01, 2005
ADVANTEST Spectrum Analyzer	R3271A	85060311	Jun. 16, 2005
CHASE RF Pre_Amplifier	CPA9232	1057	May 10, 2005
HP Pre_Amplifier	8449B	3008A01922	Oct. 13, 2004
ROHDE & SCHWARZ Test Receiver	ESVS 10	849231 /019	Oct. 31, 2004
CHASE Broadband Antenna	VULB9168	138	May 22, 2005
Schwarzbeck Horn_Antenna	3115	5619	Jun. 16, 2005
Schwarzbeck Horn_Antenna	BBHA 9170	BBHA9170192	Feb. 16, 2005
SCHWARZBECK Tunable Dipole Antenna	UHAP	897	Mar. 07, 2005
SCHWARZBECK Tunable Dipole Antenna	VHAP	880	Mar. 07, 2005
RF Switches (ARNITSU)	CS-201	1565157	Dec. 01, 2004
RF CABLE (Chaintek) 1GHz-20GHz	SF102	22054-2	Feb. 10, 2005
RF Cable(RICHTEC)	9913-30M	STCCAB-30M- 1GHz-021	Dec. 01, 2004
Software	AS60P8	NA	NA
CHANCE MOST Antenna Tower	AT-100	0203	NA
CHANCE MOST Turn Table	TT-100	0203	NA

- Note: 1. The calibration interval of the above test instruments is 12 months (36 months for Tunable Dipole Antenna) and the calibrations are traceable to NML/ROC and NIST/USA.
2. The horn antenna and HP preamplifier (model: 8449B) are used only for the measurement of emission frequency above 1GHz if tested.
3. The test was performed in ADT Open Site No. C.
4. The FCC Site Registration No. is 656396.
5. The VCCI Site Registration No. is R-1626.
6. The CANADA Site Registration No. is IC 4824-3.
7. The measurement uncertainty is 3.56 dB, which is calculated as per the document CISPR 16-4



#### 4.2.3 TEST PROCEDURES

- a. The EUT was placed on the top of a rotating table 0.8 meters above the ground at a 10 meter open area test site. The table was rotated 360 degrees to determine the position of the highest radiation.
- b. The EUT was set 3 meters away from the interference-receiving antenna, which was mounted on the top of a variable-height antenna tower.
- c. The antenna is a broadband antenna, and its height is varied from one meter to four meters above the ground to determine the maximum value of the field strength. Both horizontal and vertical polarizations of the antenna are set to make the measurement.
- d. For each suspected emission, the EUT was arranged to its worst case and then the antenna was tuned to heights from 1 meter to 4 meters and the rotatable table was turned from 0 degrees to 360 degrees to find the maximum reading.
- e. The test-receiver system was set to Peak Detect Function and Specified Bandwidth with Maximum Hold Mode.
- f. If the emission level of the EUT in peak mode was 10 dB lower than the limit specified, then testing could be stopped and the peak values of the EUT would be reported. Otherwise the emissions that did not have 10 dB margin would be re-tested one by one using peak, quasi-peak or average method as specified and then reported in a data sheet.

**NOTE:**

1. The resolution bandwidth and video bandwidth of test receiver/spectrum analyzer is 120kHz for Peak detection (PK) and Quasi-peak detection (QP) at frequency below 1GHz.
2. The resolution bandwidth and video bandwidth of test receiver/spectrum analyzer is 1 MHz for Peak detection at frequency above 1GHz.
3. The resolution bandwidth of test receiver/spectrum analyzer is 1 MHz and the video bandwidth is 300 Hz for Average detection (AV) at frequency above 1GHz.



#### 4.2.4 TEST SETUP

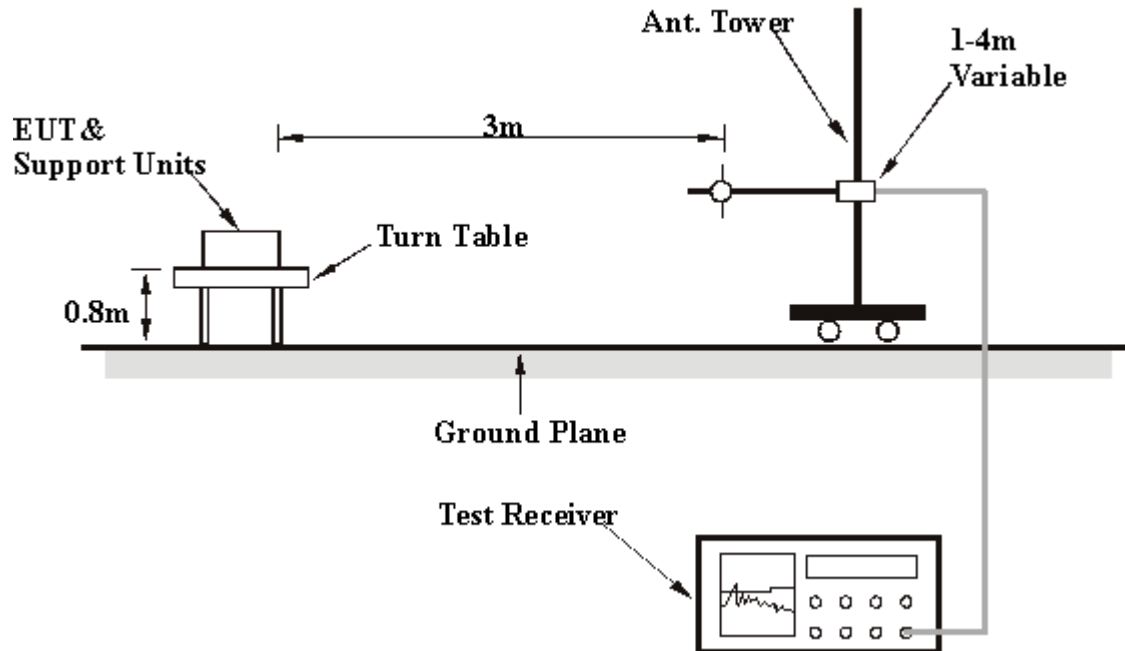

For the actual test configuration, please refer to the related item – Photographs of the Test Configuration.

#### 4.2.5 EUT OPERATING CONDITIONS

Same as 4.1.5.



#### 4.2.6 TEST RESULTS

The EUT was pre-tested under CCK & OFDM modulation type. The OFDM modulation type, worst case one, was chosen for final test.

<b>EUT</b>	Wireless USB Adapter	<b>MODEL</b>	SpeedTouch 121g
<b>MODE</b>	Channel 11	<b>FREQUENCY RANGE</b>	30-1000 MHz
<b>INPUT POWER (SYSTEM)</b>	120Vac, 60 Hz	<b>DETECTOR FUNCTION &amp; BANDWIDTH</b>	Quasi-Peak, 120kHz
<b>ENVIRONMENTAL CONDITIONS</b>	24 deg. C, 69 %RH, 978 hPa	<b>TESTED BY</b>	Sky Liao

#### ANTENNA POLARITY & TEST DISTANCE: HORIZONTAL AT 3 M

No.	Freq. (MHz)	Emission Level (dBuV/m)	Limit (dBuV/m)	Margin (dB)	Antenna Height (m)	Table Angle (Degree)	Raw Value (dBuV)	Correction Factor (dB/m)
1	240.00	26.80 QP	46.00	-19.20	1.00 H	3	14.00	12.80
2	360.01	28.90 QP	46.00	-17.10	1.01 H	134	11.80	17.10
3	400.00	30.30 QP	46.00	-15.70	1.00 H	270	11.90	18.40
4	440.00	27.10 QP	46.00	-18.90	1.00 H	142	7.80	19.30
5	480.00	31.50 QP	46.00	-14.50	1.00 H	140	11.30	20.20
6	600.00	27.70 QP	46.00	-18.30	1.25 H	3	5.40	22.30
7	680.00	26.80 QP	46.00	-19.20	1.20 H	242	3.00	23.70

#### ANTENNA POLARITY & TEST DISTANCE: VERTICAL AT 3 M

No.	Freq. (MHz)	Emission Level (dBuV/m)	Limit (dBuV/m)	Margin (dB)	Antenna Height (m)	Table Angle (Degree)	Raw Value (dBuV)	Correction Factor (dB/m)
1	240.03	22.60 QP	46.00	-23.40	1.13 V	8	9.80	12.80
2	360.00	25.00 QP	46.00	-21.00	1.16 V	3	7.90	17.10
3	400.00	30.50 QP	46.00	-15.50	1.08 V	7	12.10	18.40
4	440.00	25.30 QP	46.00	-20.70	1.00 V	7	6.00	19.30
5	520.00	26.30 QP	46.00	-19.70	1.01 V	359	4.70	21.50
6	560.00	27.60 QP	46.00	-18.40	1.00 V	22	4.90	22.70
7	600.00	25.10 QP	46.00	-20.90	1.44 V	83	2.80	22.30

- REMARKS:**
1. Emission level(dBuV/m)=Raw Value(dBuV) + Correction Factor(dB)
  2. Correction Factor(dB/m) = Antenna Factor (dB/m) + Cable Factor (dB)
  3. The other emission levels were very low against the limit.
  4. Margin value = Emission level – Limit value.



## 4.2.7 TEST RESULTS - DSSS

<b>EUT</b>	Wireless USB Adapter	<b>MODEL</b>	SpeedTouch 121g
<b>MODE</b>	Channel 1	<b>FREQUENCY RANGE</b>	1000~25000MHz
<b>INPUT POWER (SYSTEM)</b>	120Vac, 60 Hz	<b>DETECTOR FUNCTION &amp; BANDWIDTH</b>	Peak (PK) Average (AV) 1 MHz
<b>ENVIRONMENTAL CONDITIONS</b>	27 deg. C, 63%RH, 978 hPa	<b>TESTED BY</b>	Sky Liao

**ANTENNA POLARITY & TEST DISTANCE: HORIZONTAL AT 3 M**

No.	Freq. (MHz)	Emission Level (dBuV/m)	Limit (dBuV/m)	Margin (dB)	Antenna Height (m)	Table Angle (Degree)	Raw Value (dBuV)	Correction Factor (dB/m)
1	2387.00	54.40 PK	74.00	-19.60	1.20 H	332	21.50	32.90
1	2387.00	42.90 AV	54.00	-11.10	1.20 H	332	10.00	32.90
2	2390.00	47.70 PK	74.00	-26.30	1.75 H	256	13.90	33.80
3	*2412.00	102.60 PK			1.75 H	256	72.70	29.90
3	*2412.00	95.90 AV			1.75 H	256	66.00	29.90
4	4824.00	43.80 PK	74.00	-30.20	1.80 H	158	7.60	36.20
5	7236.00	48.30 PK	74.00	-25.70	1.27 H	345	6.70	41.70

**ANTENNA POLARITY & TEST DISTANCE: VERTICAL AT 3 M**

No.	Freq. (MHz)	Emission Level (dBuV/m)	Limit (dBuV/m)	Margin (dB)	Antenna Height (m)	Table Angle (Degree)	Raw Value (dBuV)	Correction Factor (dB/m)
1	2387.00	58.70 PK	74.00	-15.30	1.23 V	10	25.80	32.90
1	2387.00	48.30 AV	54.00	-5.70	1.23 V	10	15.40	32.90
2	2390.00	56.30 PK	74.00	-17.70	1.20 V	349	22.50	33.80
2	2390.00	48.90 AV	54.00	-5.10	1.20 V	349	15.10	33.80
3	*2412.00	112.60 PK			1.20 V	349	82.70	29.90
3	*2412.00	105.50 AV			1.20 V	349	75.60	29.90
4	4824.00	44.60 PK	74.00	-29.40	1.00 V	299	8.40	36.20
5	7236.00	48.30 PK	74.00	-25.70	1.51 V	97	6.60	41.70

- REMARKS:**
1. Emission level(dBuV/m)=Raw Value(dBuV) + Correction Factor(dB)
  2. Correction Factor(dB/m) = Antenna Factor (dB/m) + Cable Factor (dB)
  3. The other emission levels were very low against the limit.
  4. Margin value = Emission level – Limit value.
  5. The limit value is defined as per 15.247
  6. “ \* “ : Fundamental frequency



<b>EUT</b>	Wireless USB Adapter	<b>MODEL</b>	SpeedTouch 121g
<b>MODE</b>	Channel 6	<b>FREQUENCY RANGE</b>	1000~25000MHz
<b>INPUT POWER (SYSTEM)</b>	120Vac, 60 Hz	<b>DETECTOR FUNCTION &amp; BANDWIDTH</b>	Peak (PK) Average (AV) 1 MHz
<b>ENVIRONMENTAL CONDITIONS</b>	27 deg. C, 63%RH, 978 hPa	<b>TESTED BY</b>	Sky Liao

#### ANTENNA POLARITY & TEST DISTANCE: HORIZONTAL AT 3 M

No.	Freq. (MHz)	Emission Level (dBuV/m)	Limit (dBuV/m)	Margin (dB)	Antenna Height (m)	Table Angle (Degree)	Raw Value (dBuV)	Correction Factor (dB/m)
1	*2437.00	106.40 PK			1.09 H	137	76.40	30.00
1	*2437.00	99.30 AV			1.09 H	137	69.30	30.00
2	4874.00	46.80 PK	74.00	-27.20	1.98 H	14	10.30	36.50
3	7311.00	48.00 PK	74.00	-26.00	1.48 H	275	6.20	41.80

#### ANTENNA POLARITY & TEST DISTANCE: VERTICAL AT 3 M

No.	Freq. (MHz)	Emission Level (dBuV/m)	Limit (dBuV/m)	Margin (dB)	Antenna Height (m)	Table Angle (Degree)	Raw Value (dBuV)	Correction Factor (dB/m)
1	*2437.00	114.20 PK			1.00 V	346	84.20	30.00
1	*2437.00	107.50 AV			1.00 V	346	77.50	30.00
2	4874.00	48.10 PK	74.00	-25.90	1.50 V	169	11.70	36.50
3	7311.00	48.10 PK	74.00	-25.90	1.69 V	228	6.30	41.80

- REMARKS:**
1. Emission level(dBuV/m)=Raw Value(dBuV) + Correction Factor(dB)
  2. Correction Factor(dB/m) = Antenna Factor (dB/m) + Cable Factor (dB)
  3. The other emission levels were very low against the limit.
  4. Margin value = Emission level – Limit value.
  5. The limit value is defined as per 15.247
  6. “ \* “ : Fundamental frequency



<b>EUT</b>	Wireless USB Adapter	<b>MODEL</b>	SpeedTouch 121g
<b>MODE</b>	Channel 11	<b>FREQUENCY RANGE</b>	1000~25000MHz
<b>INPUT POWER (SYSTEM)</b>	120Vac, 60 Hz	<b>DETECTOR FUNCTION &amp; BANDWIDTH</b>	Peak (PK) Average (AV) 1 MHz
<b>ENVIRONMENTAL CONDITIONS</b>	27 deg. C, 63%RH, 978 hPa	<b>TESTED BY</b>	Sky Liao

#### ANTENNA POLARITY & TEST DISTANCE: HORIZONTAL AT 3 M

No.	Freq. (MHz)	Emission Level (dBuV/m)	Limit (dBuV/m)	Margin (dB)	Antenna Height (m)	Table Angle (Degree)	Raw Value (dBuV)	Correction Factor (dB/m)
1	*2462.00	105.70 PK			1.48 H	246	75.60	30.10
1	*2462.00	98.50 AV			1.48 H	246	68.40	30.10
2	2483.50	48.20 PK	74.00	-25.80	1.48 H	246	18.10	30.10
3	2486.80	49.20 PK	74.00	-24.80	1.44 H	242	19.00	30.10
4	4924.00	47.10 PK	74.00	-26.90	1.96 H	180	10.40	36.70
5	7386.00	48.90 PK	74.00	-25.10	1.59 H	278	7.10	41.80

#### ANTENNA POLARITY & TEST DISTANCE: VERTICAL AT 3 M

No.	Freq. (MHz)	Emission Level (dBuV/m)	Limit (dBuV/m)	Margin (dB)	Antenna Height (m)	Table Angle (Degree)	Raw Value (dBuV)	Correction Factor (dB/m)
1	*2462.00	110.10 PK			1.37 V	256	80.00	30.10
1	*2462.00	103.80 AV			1.37 V	256	73.70	30.10
2	2483.50	53.70 PK	74.00	-20.30	1.37 V	256	23.60	30.10
2	2483.50	45.30 AV	54.00	-8.70	1.37 V	256	15.20	30.10
3	2486.80	54.30 PK	74.00	-19.70	1.39 V	10	24.10	30.10
3	2486.80	42.90 AV	54.00	-11.10	1.39 V	10	12.70	30.10
4	4924.00	49.90 PK	74.00	-24.10	1.41 V	212	13.20	36.70
5	7386.00	49.20 PK	74.00	-24.80	1.28 V	177	7.30	41.80

- REMARKS:**
1. Emission level(dBuV/m)=Raw Value(dBuV) + Correction Factor(dB)
  2. Correction Factor(dB/m) = Antenna Factor (dB/m) + Cable Factor (dB)
  3. The other emission levels were very low against the limit.
  4. Margin value = Emission level – Limit value.
  5. The limit value is defined as per 15.247
  6. “ \* “ : Fundamental frequency



## 4.2.8 TEST RESULTS -OFDM

<b>EUT</b>	Wireless USB Adapter	<b>MODEL</b>	SpeedTouch 121g
<b>MODE</b>	Channel 1	<b>FREQUENCY RANGE</b>	1000~25000MHz
<b>INPUT POWER (SYSTEM)</b>	120Vac, 60 Hz	<b>DETECTOR FUNCTION &amp; BANDWIDTH</b>	Peak (PK) Average (AV) 1 MHz
<b>ENVIRONMENTAL CONDITIONS</b>	27 deg. C, 63%RH, 978 hPa	<b>TESTED BY</b>	Sky Liao

**ANTENNA POLARITY & TEST DISTANCE: HORIZONTAL AT 3 M**

No.	Freq. (MHz)	Emission Level (dBuV/m)	Limit (dBuV/m)	Margin (dB)	Antenna Height (m)	Table Angle (Degree)	Raw Value (dBuV)	Correction Factor (dB/m)
1	2375.00	49.50 PK	74.00	-24.50	1.17 H	337	18.80	30.70
2	2390.00	45.30 PK	74.00	-28.70	1.64 H	313	11.50	33.80
3	*2412.00	100.60 PK			1.64 H	313	70.70	29.90
3	*2412.00	92.60 AV			1.64 H	313	62.70	29.90
4	4824.00	43.60 PK	74.00	-30.40	1.65 H	204	7.40	36.20
5	7236.00	49.10 PK	74.00	-24.90	1.37 H	177	7.50	41.70

**ANTENNA POLARITY & TEST DISTANCE: VERTICAL AT 3 M**

No.	Freq. (MHz)	Emission Level (dBuV/m)	Limit (dBuV/m)	Margin (dB)	Antenna Height (m)	Table Angle (Degree)	Raw Value (dBuV)	Correction Factor (dB/m)
1	2375.00	53.30 PK	74.00	-20.70	1.48 V	343	22.60	30.70
1	2375.00	44.20 AV	54.00	-9.80	1.48 V	343	13.50	30.70
2	2390.00	51.70 PK	74.00	-22.30	1.25 V	313	17.90	33.80
2	2390.00	43.50 AV	54.00	-10.50	1.25 V	313	9.70	33.80
3	*2412.00	106.60 PK			1.25 V	313	76.70	29.90
3	*2412.00	98.80 AV			1.25 V	313	68.90	29.90
4	4824.00	44.40 PK	74.00	-29.60	1.29 V	126	8.10	36.20
5	7236.00	48.20 PK	74.00	-25.80	1.57 V	203	6.50	41.70

- REMARKS:**
1. Emission level(dBuV/m)=Raw Value(dBuV) + Correction Factor(dB)
  2. Correction Factor(dB/m) = Antenna Factor (dB/m) + Cable Factor (dB)
  3. The other emission levels were very low against the limit.
  4. Margin value = Emission level – Limit value.
  5. The limit value is defined as per 15.247
  6. “ \* “ : Fundamental frequency



<b>EUT</b>	Wireless USB Adapter	<b>MODEL</b>	SpeedTouch 121g
<b>MODE</b>	Channel 6	<b>FREQUENCY RANGE</b>	1000~25000MHz
<b>INPUT POWER (SYSTEM)</b>	120Vac, 60 Hz	<b>DETECTOR FUNCTION &amp; BANDWIDTH</b>	Peak (PK) Average (AV) 1 MHz
<b>ENVIRONMENTAL CONDITIONS</b>	27 deg. C, 63%RH, 978 hPa	<b>TESTED BY</b>	Sky Liao

#### ANTENNA POLARITY & TEST DISTANCE: HORIZONTAL AT 3 M

No.	Freq. (MHz)	Emission Level (dBuV/m)	Limit (dBuV/m)	Margin (dB)	Antenna Height (m)	Table Angle (Degree)	Raw Value (dBuV)	Correction Factor (dB/m)
1	*2437.00	100.70 PK			1.13 H	334	70.70	30.00
1	*2437.00	92.90 AV			1.13 H	334	62.90	30.00
2	4874.00	44.10 PK	74.00	-29.90	2.00 H	0	7.70	36.50
3	7311.00	48.40 PK	74.00	-25.60	1.12 H	94	6.70	41.80

#### ANTENNA POLARITY & TEST DISTANCE: VERTICAL AT 3 M

No.	Freq. (MHz)	Emission Level (dBuV/m)	Limit (dBuV/m)	Margin (dB)	Antenna Height (m)	Table Angle (Degree)	Raw Value (dBuV)	Correction Factor (dB/m)
1	*2437.00	108.30 PK			1.00 V	346	78.30	30.00
1	*2437.00	100.60 AV			1.00 V	346	70.60	30.00
2	4874.00	45.50 PK	74.00	-28.50	1.39 V	189	9.00	36.50
3	7311.00	49.00 PK	74.00	-25.00	1.55 V	333	7.20	41.80

- REMARKS:**
1. Emission level(dBuV/m)=Raw Value(dBuV) + Correction Factor(dB)
  2. Correction Factor(dB/m) = Antenna Factor (dB/m) + Cable Factor (dB)
  3. The other emission levels were very low against the limit.
  4. Margin value = Emission level – Limit value.
  5. The limit value is defined as per 15.247
  6. “ \* “ : Fundamental frequency



<b>EUT</b>	Wireless USB Adapter	<b>MODEL</b>	SpeedTouch 121g
<b>MODE</b>	Channel 11	<b>FREQUENCY RANGE</b>	1000~25000MHz
<b>INPUT POWER (SYSTEM)</b>	120Vac, 60 Hz	<b>DETECTOR FUNCTION &amp; BANDWIDTH</b>	Peak (PK) Average (AV) 1 MHz
<b>ENVIRONMENTAL CONDITIONS</b>	27 deg. C, 63%RH, 978 hPa	<b>TESTED BY</b>	Sky Liao

#### ANTENNA POLARITY & TEST DISTANCE: HORIZONTAL AT 3 M

No.	Freq. (MHz)	Emission Level (dBuV/m)	Limit (dBuV/m)	Margin (dB)	Antenna Height (m)	Table Angle (Degree)	Raw Value (dBuV)	Correction Factor (dB/m)
1	*2462.00	101.60 PK			1.48 H	241	71.50	30.10
1	*2462.00	94.00 AV			1.48 H	241	63.90	30.10
2	2483.50	51.40 PK	74.00	-22.60	1.48 H	241	21.30	30.10
2	2483.50	43.70 AV	54.00	-10.30	1.48 H	241	13.60	30.10
3	2498.00	49.30 PK	74.00	-24.70	1.69 H	144	17.70	31.60
4	4924.00	45.20 PK	74.00	-28.80	1.51 H	345	8.50	36.70
5	7386.00	49.60 PK	74.00	-24.40	1.29 H	155	7.80	41.80

#### ANTENNA POLARITY & TEST DISTANCE: VERTICAL AT 3 M

No.	Freq. (MHz)	Emission Level (dBuV/m)	Limit (dBuV/m)	Margin (dB)	Antenna Height (m)	Table Angle (Degree)	Raw Value (dBuV)	Correction Factor (dB/m)
1	*2462.00	108.30 PK			1.00 V	345	78.20	30.10
1	*2462.00	100.20 AV			1.00 V	345	70.10	30.10
2	2483.50	57.50 PK	74.00	-16.50	1.00 V	345	27.40	30.10
<b>2</b>	<b>2483.50</b>	<b>49.90 AV</b>	<b>54.00</b>	<b>-4.10</b>	<b>1.00 V</b>	<b>345</b>	<b>19.80</b>	<b>30.10</b>
3	2498.00	56.30 PK	74.00	-17.70	1.05 V	137	24.60	31.60
3	2498.00	48.10 AV	54.00	-5.90	1.05 V	137	16.50	31.60
4	4924.00	47.30 PK	74.00	-26.70	1.00 V	96	10.60	36.70
5	7386.00	49.20 PK	74.00	-24.80	1.45 V	154	7.30	41.80

- REMARKS:**
1. Emission level(dBuV/m)=Raw Value(dBuV) + Correction Factor(dB)
  2. Correction Factor(dB/m) = Antenna Factor (dB/m) + Cable Factor (dB)
  3. The other emission levels were very low against the limit.
  4. Margin value = Emission level – Limit value.
  5. The limit value is defined as per 15.247
  6. " \* " : Fundamental frequency





### 4.3 6dB BANDWIDTH MEASUREMENT

#### 4.3.1 LIMITS OF 6dB BANDWIDTH MEASUREMENT

The minimum of 6dB Bandwidth Measurement is 0.5 MHz.

#### 4.3.2 TEST INSTRUMENTS

Description & Manufacturer	Model No.	Serial No.	Calibrated Until
R&S SPECTRUM ANALYZER	FSP40	100036	Nov. 27, 2004

**NOTE:**

- 1.The measurement uncertainty is less than +/- 2.6dB, which is calculated as per the NAMAS document NIS81.
- 2.The calibration interval of the above test instruments is 12 months and the calibrations are traceable to NML/ROC and NIST/USA.

#### 4.3.3 TEST PROCEDURE

The transmitter output was connected to the spectrum analyzer through an attenuator. The bandwidth of the fundamental frequency was measured by spectrum analyzer with 100 kHz RBW and 100 kHz VBW. The 6 dB bandwidth is defined as the total spectrum the power of which is higher than peak power minus 6 dB.

#### 4.3.4 TEST SETUP



For the actual test configuration, please refer to the related Item – Photographs of the Test Configuration.

#### 4.3.5 EUT OPERATING CONDITIONS

The software provided by client to enable the EUT under transmission condition continuously at lowest, middle and highest channel frequencies individually.



## 4.3.6 TEST RESULTS-DSSS

<b>EUT</b>	Wireless USB Adapter		
<b>MODEL</b>	SpeedTouch 121g	<b>ENVIRONMENTAL CONDITIONS</b>	24 deg. C, 64%RH, 978 hPa
<b>INPUT POWER (SYSTEM)</b>	120Vac, 60 Hz	<b>TESTED BY</b>	Wen Yu

<b>CHANNEL</b>	<b>CHANNEL FREQUENCY (MHz)</b>	<b>6 dB BANDWIDTH (MHz)</b>	<b>MINIMUM LIMIT (MHz)</b>	<b>PASS/FAIL</b>
1	2412	11.52	0.5	PASS
6	2437	11.52	0.5	PASS
11	2462	11.58	0.5	PASS

CH1

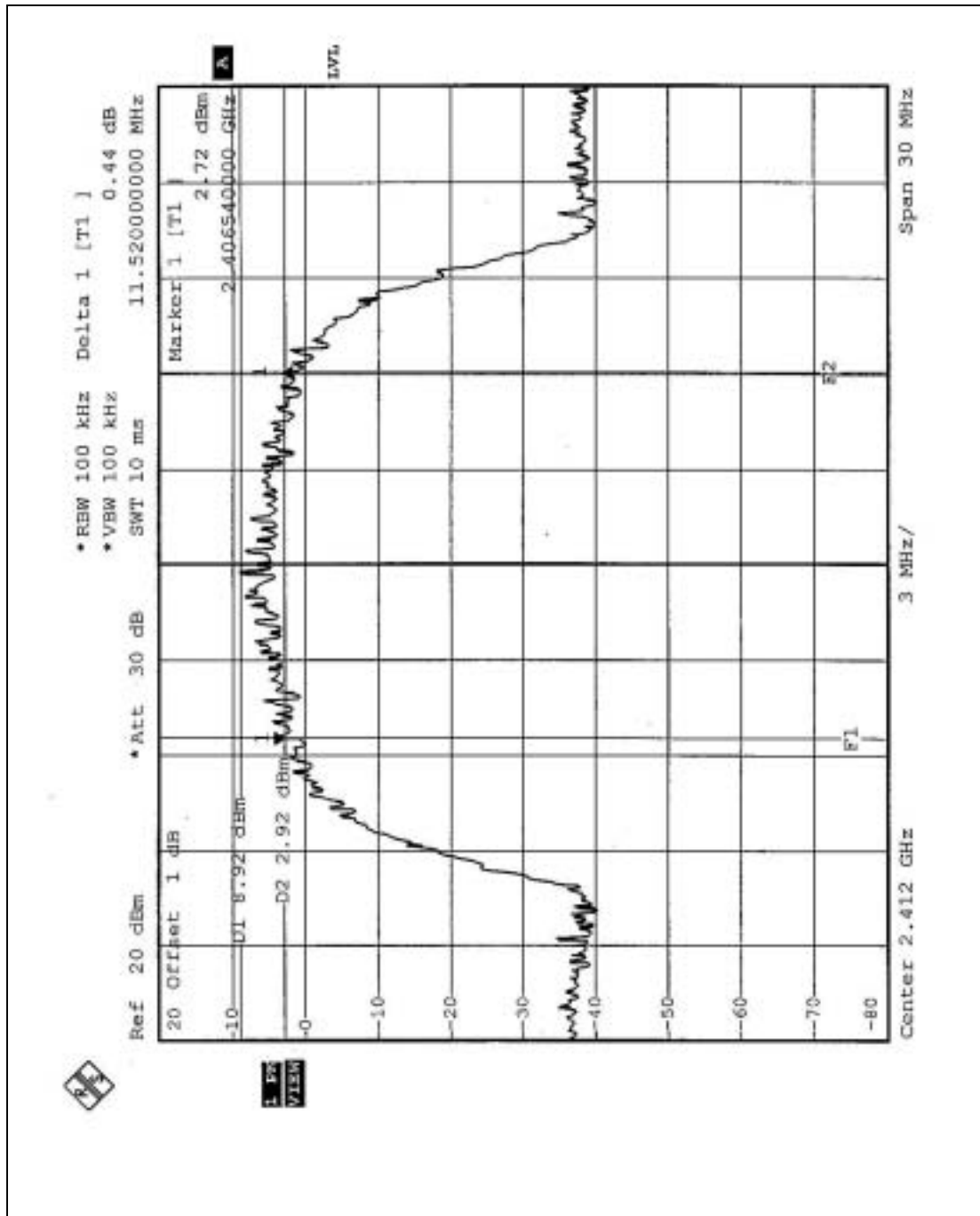



CH6

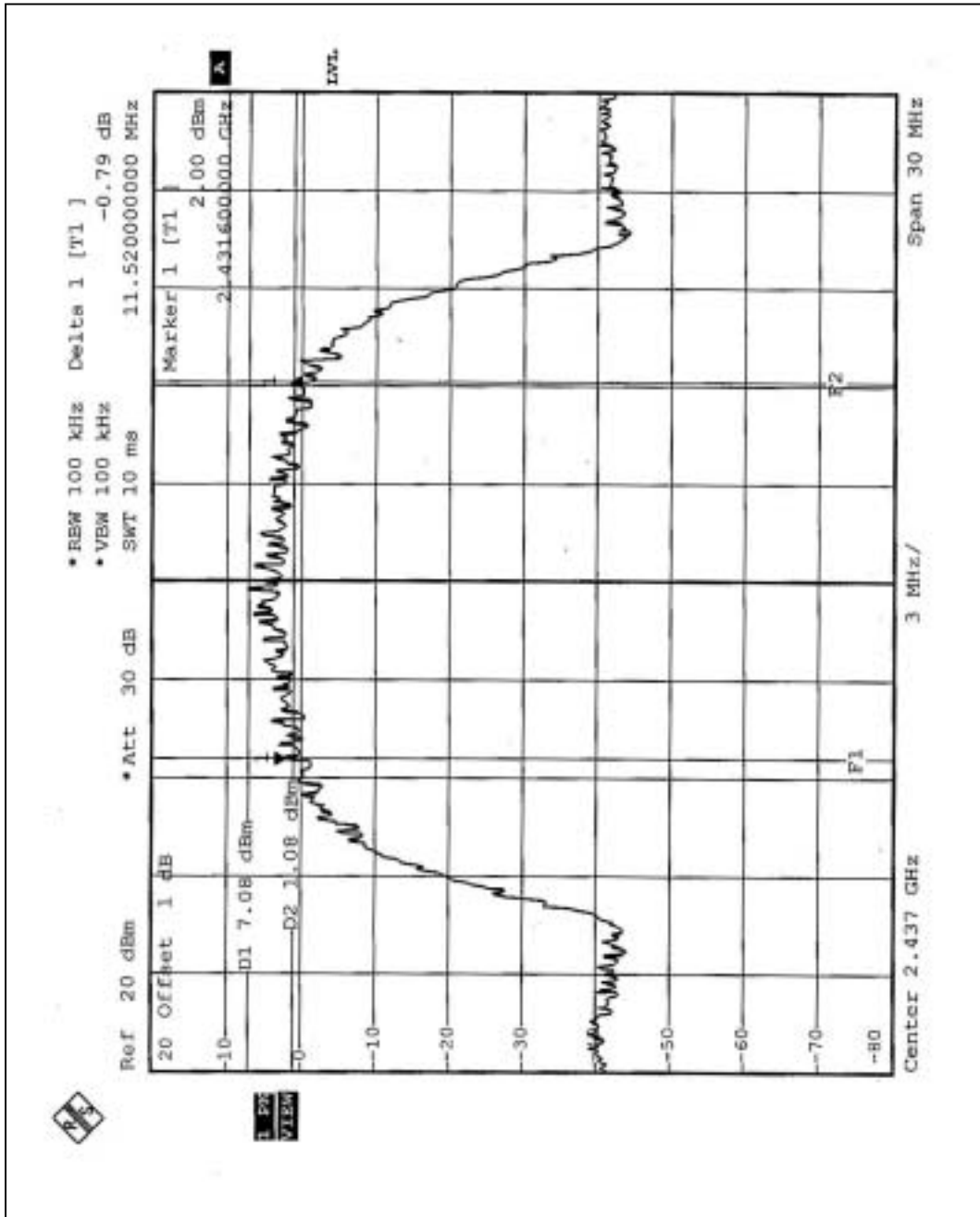



CH11

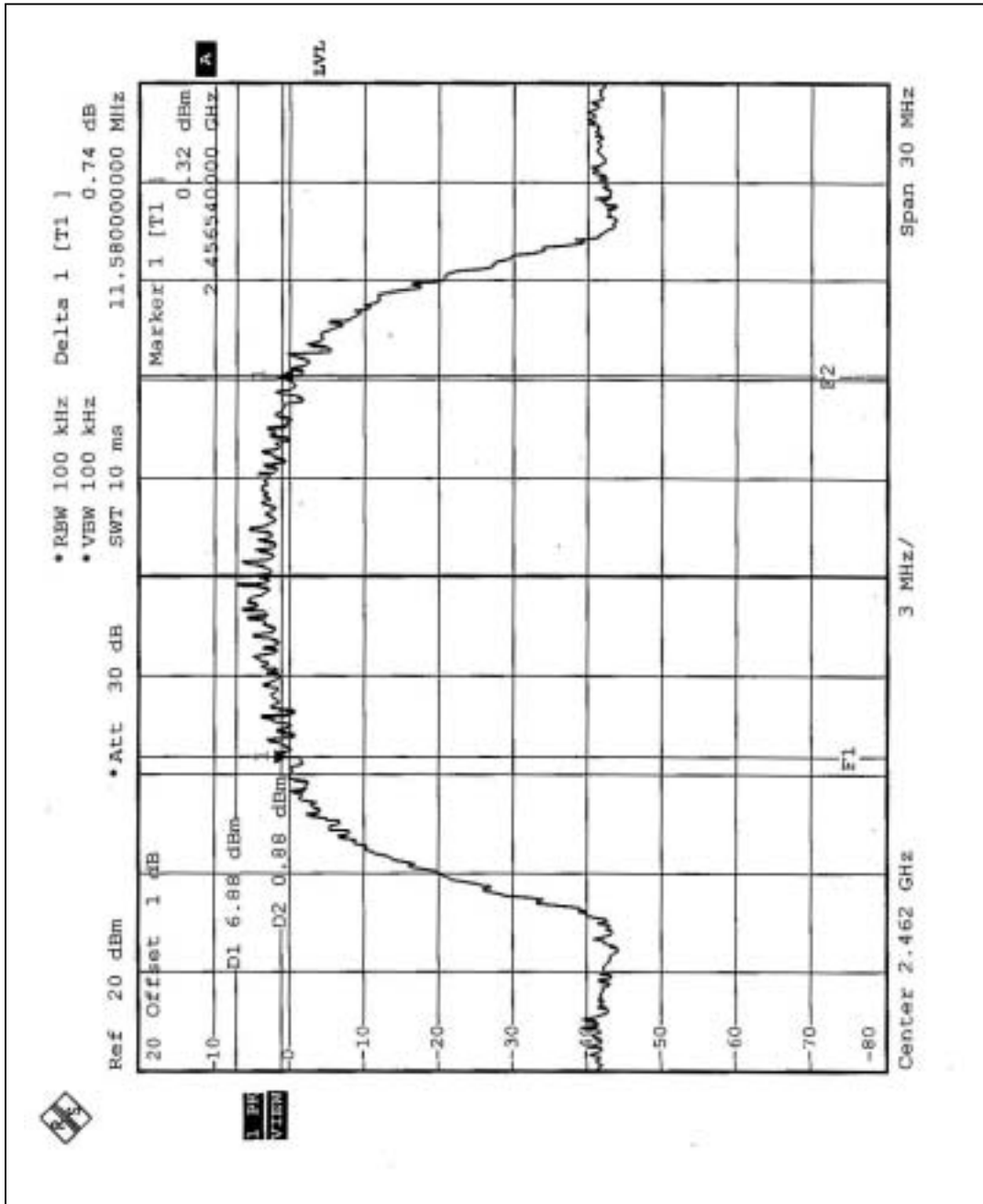



## 4.3.7 TEST RESULTS-OFDM

<b>EUT</b>	Wireless USB Adapter		
<b>MODEL</b>	SpeedTouch 121g	<b>ENVIRONMENTAL CONDITIONS</b>	24 deg. C, 64%RH, 978 hPa
<b>INPUT POWER (SYSTEM)</b>	120Vac, 60 Hz	<b>TESTED BY</b>	Wen Yu

<b>CHANNEL</b>	<b>CHANNEL FREQUENCY (MHz)</b>	<b>6 dB BANDWIDTH (MHz)</b>	<b>MINIMUM LIMIT (MHz)</b>	<b>PASS/FAIL</b>
1	2412	16.50	0.5	PASS
6	2437	16.50	0.5	PASS
11	2462	16.50	0.5	PASS



CH1

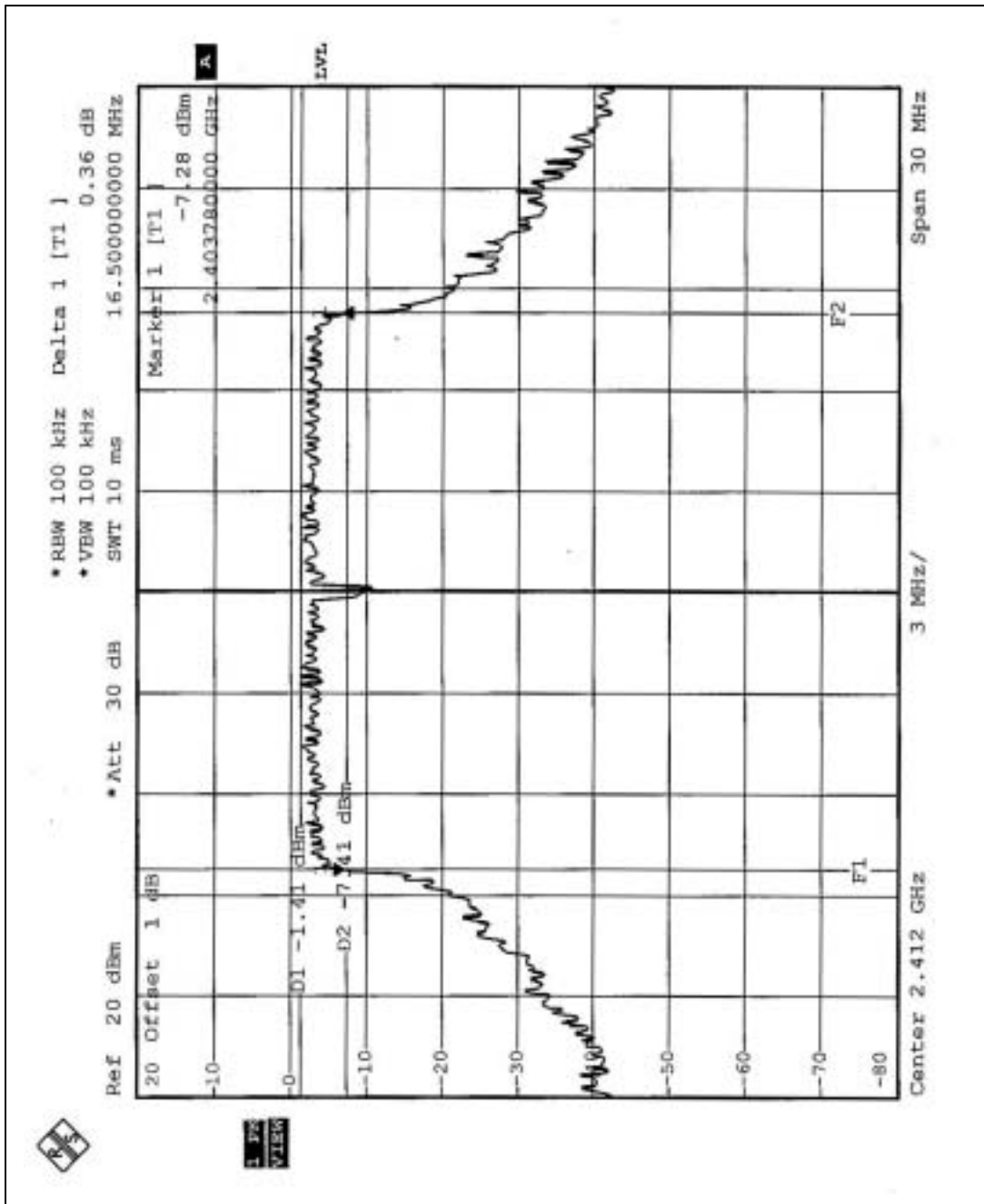





CH6

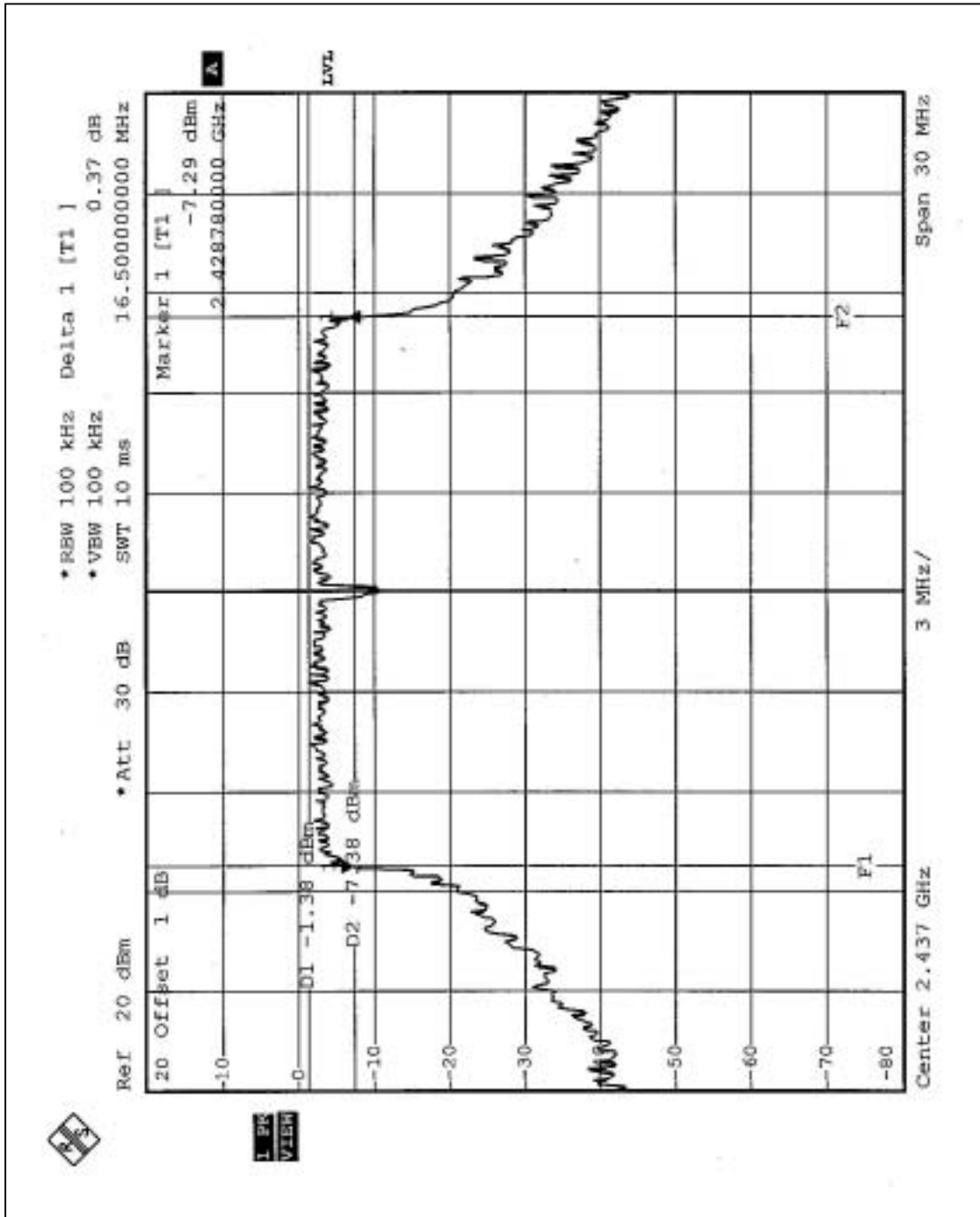



CH11

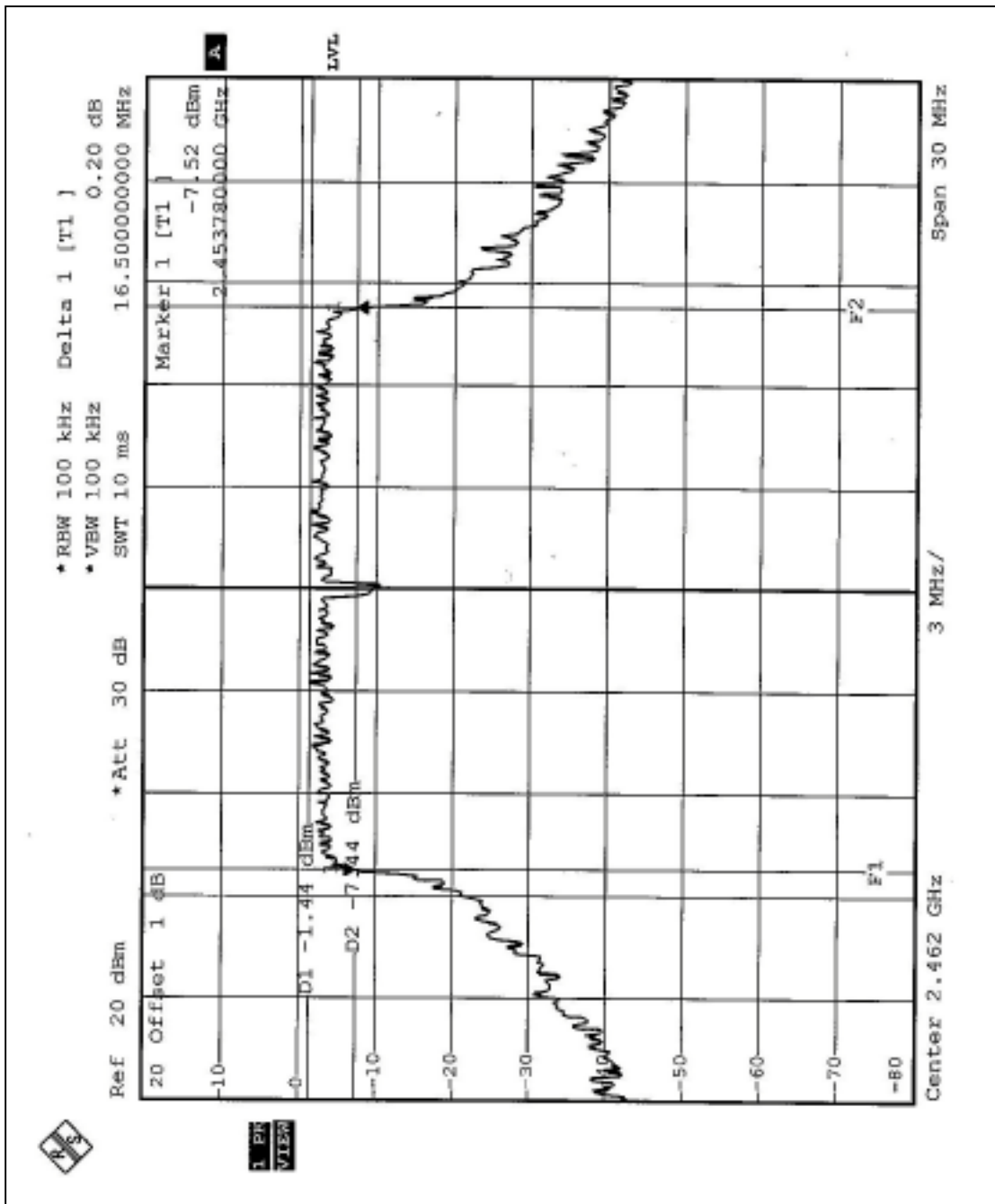



#### 4.4 MAXIMUM PEAK OUTPUT POWER

##### 4.4.1 LIMITS OF MAXIMUM PEAK OUTPUT POWER MEASUREMENT

The Maximum Peak Output Power Measurement is 30dBm.

##### 4.4.2 TEST INSTRUMENTS

Description & Manufacturer	Model No.	Serial No.	Calibrated Until
R&S SPECTRUM ANALYZER	FSP40	100036	Nov. 27, 2004
Agilent SIGNAL GENERATOR	E8257C	MY43320668	Jan. 1, 2005
TEKTRONIX OSCILLOSCOPE	TDS 220	B027241	Jun. 30, 2005
NARDA DETECTOR	4503A	FSCM99899	NA

**NOTE:**

The calibration interval of the above test instruments is 12 months and the calibrations are traceable to NML/ROC and NIST/USA.

#### 4.4.3 TEST PROCEDURES

1. A detector was used on the output port of the EUT. An oscilloscope was used to read the peak response of the detector.
2. Replaced the EUT by the signal generator. The center frequency of the S.G was adjusted to the center frequency of the measured channel.
3. Adjusted the power to have the same peak reading on oscilloscope.  
Record the power level.

#### 4.4.4 TEST SETUP

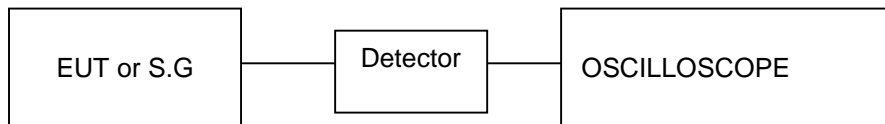

#### 4.4.5 EUT OPERATING CONDITIONS

Same as Item 4.3.5



## 4.4.6 TEST RESULTS- DSSS

<b>EUT</b>	Wireless USB Adapter		
<b>MODEL</b>	SpeedTouch 121g	<b>ENVIRONMENTAL CONDITIONS</b>	24 deg. C, 64%RH, 978 hPa
<b>INPUT POWER (SYSTEM)</b>	120Vac, 60 Hz	<b>TESTED BY</b>	Wen Yu

<b>CHANNEL</b>	<b>CHANNEL FREQUENCY (MHz)</b>	<b>PEAK POWER OUTPUT (dBm)</b>	<b>PEAK POWER LIMIT (dBm)</b>	<b>PASS/FAIL</b>
1	2412	17.22	30	PASS
6	2437	17.14	30	PASS
11	2462	17.11	30	PASS



## 4.4.7 TEST RESULTS- OFDM

<b>EUT</b>	Wireless USB Adapter		
<b>MODEL</b>	SpeedTouch 121g	<b>ENVIRONMENTAL CONDITIONS</b>	24 deg. C, 64%RH, 978 hPa
<b>INPUT POWER (SYSTEM)</b>	120Vac, 60 Hz	<b>TESTED BY</b>	Wen Yu

<b>CHANNEL</b>	<b>CHANNEL FREQUENCY (MHz)</b>	<b>PEAK POWER OUTPUT (dBm)</b>	<b>PEAK POWER LIMIT (dBm)</b>	<b>PASS/FAIL</b>
1	2412	16.30	30	PASS
6	2437	16.31	30	PASS
11	2462	16.25	30	PASS



## 4.5 POWER SPECTRAL DENSITY MEASUREMENT

### 4.5.1 LIMITS OF POWER SPECTRAL DENSITY MEASUREMENT

The Maximum of Power Spectral Density Measurement is 8dBm.

### 4.5.2 TEST INSTRUMENTS

Description & Manufacturer	Model No.	Serial No.	Calibrated Until
R&S SPECTRUM ANALYZER	FSP40	100036	Nov. 27, 2004

**NOTE:**

- 1.The measurement uncertainty is less than +/- 2.6dB, which is calculated as per the NAMAS document NIS81.
- 2.The calibration interval of the above test instruments is 12 months and the calibrations are traceable to NML/ROC and NIST/USA.

#### 4.5.3 TEST PROCEDURE

The transmitter output was connected to the spectrum analyzer through an attenuator, the bandwidth of the fundamental frequency was measured with the spectrum analyzer using 3 kHz RBW and 30 kHz VBW, set sweep time=span/3kHz. The power spectral density was measured and recorded. The sweep time is allowed to be longer than span/3KHz for a full response of the mixer in the spectrum analyzer.

#### 4.5.4 TEST SETUP

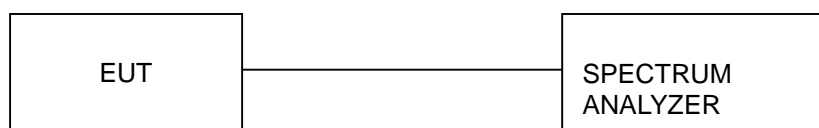

#### 4.5.5 EUT OPERATING CONDITIONS

Same as 4.3.5





## 4.5.6 TEST RESULTS-DSSS

<b>EUT</b>	Wireless USB Adapter		
<b>MODEL</b>	SpeedTouch 121g	<b>ENVIRONMENTAL CONDITIONS</b>	24 deg. C, 64%RH, 978 hPa
<b>INPUT POWER (SYSTEM)</b>	120Vac, 60 Hz	<b>TESTED BY</b>	Wen Yu

<b>CHANNEL NUMBER</b>	<b>CHANNEL FREQUENCY (MHz)</b>	<b>RF POWER LEVEL IN 3 KHz BW (dBm)</b>	<b>MAXIMUM LIMIT (dBm)</b>	<b>PASS/FAIL</b>
1	2412	-5.79	8	PASS
6	2437	-6.89	8	PASS
11	2462	-6.32	8	PASS

CH1

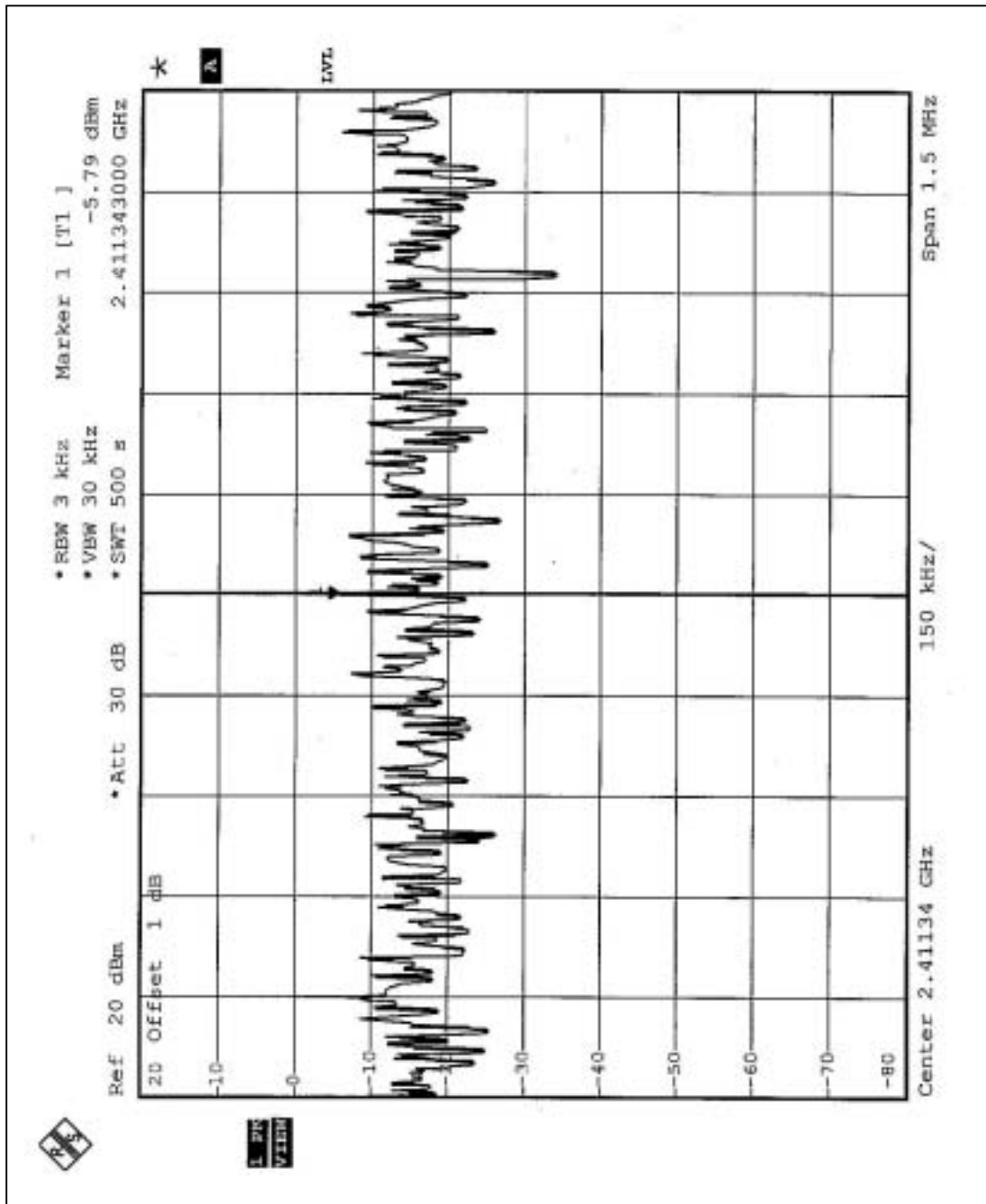

CH6

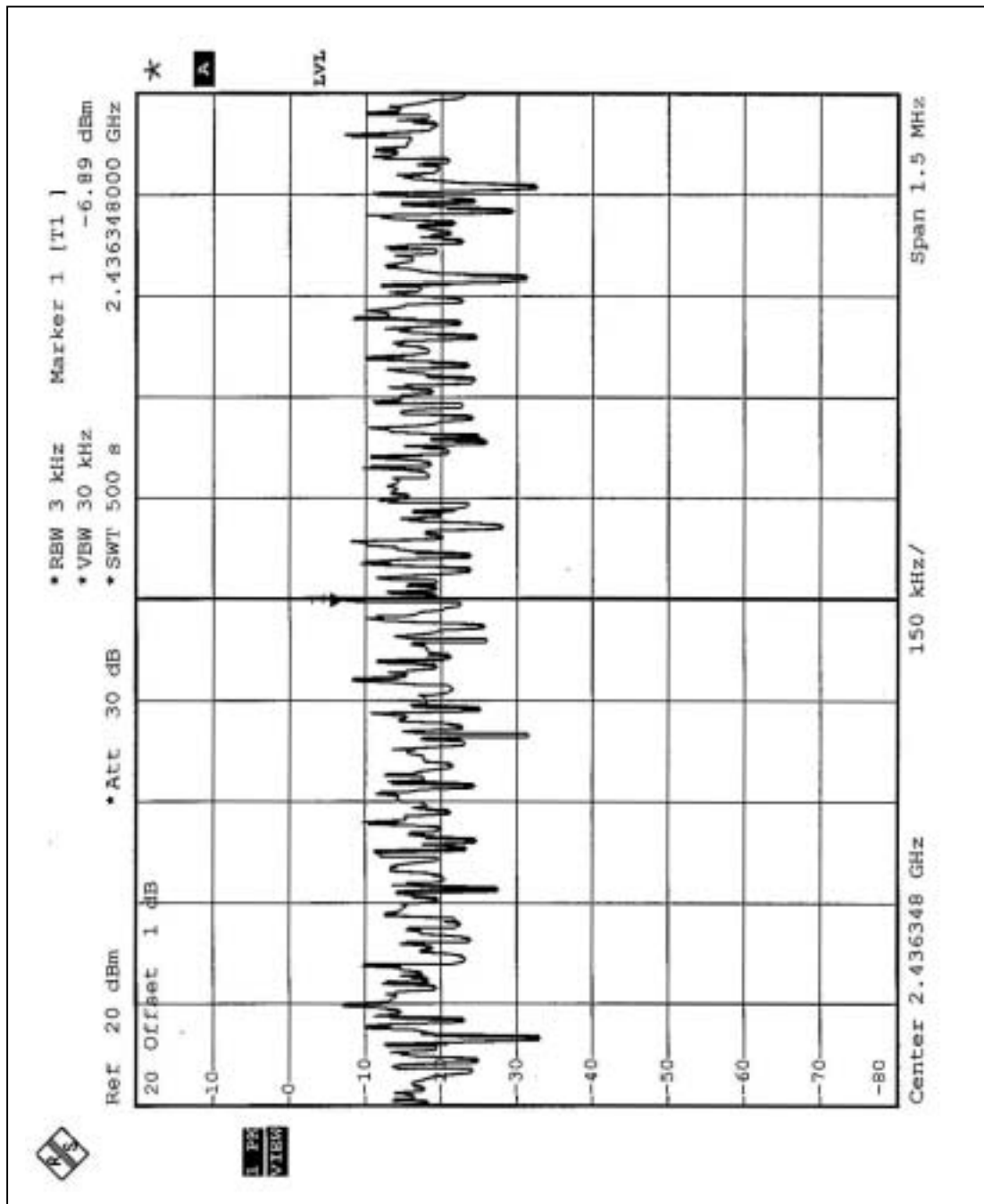



CH11

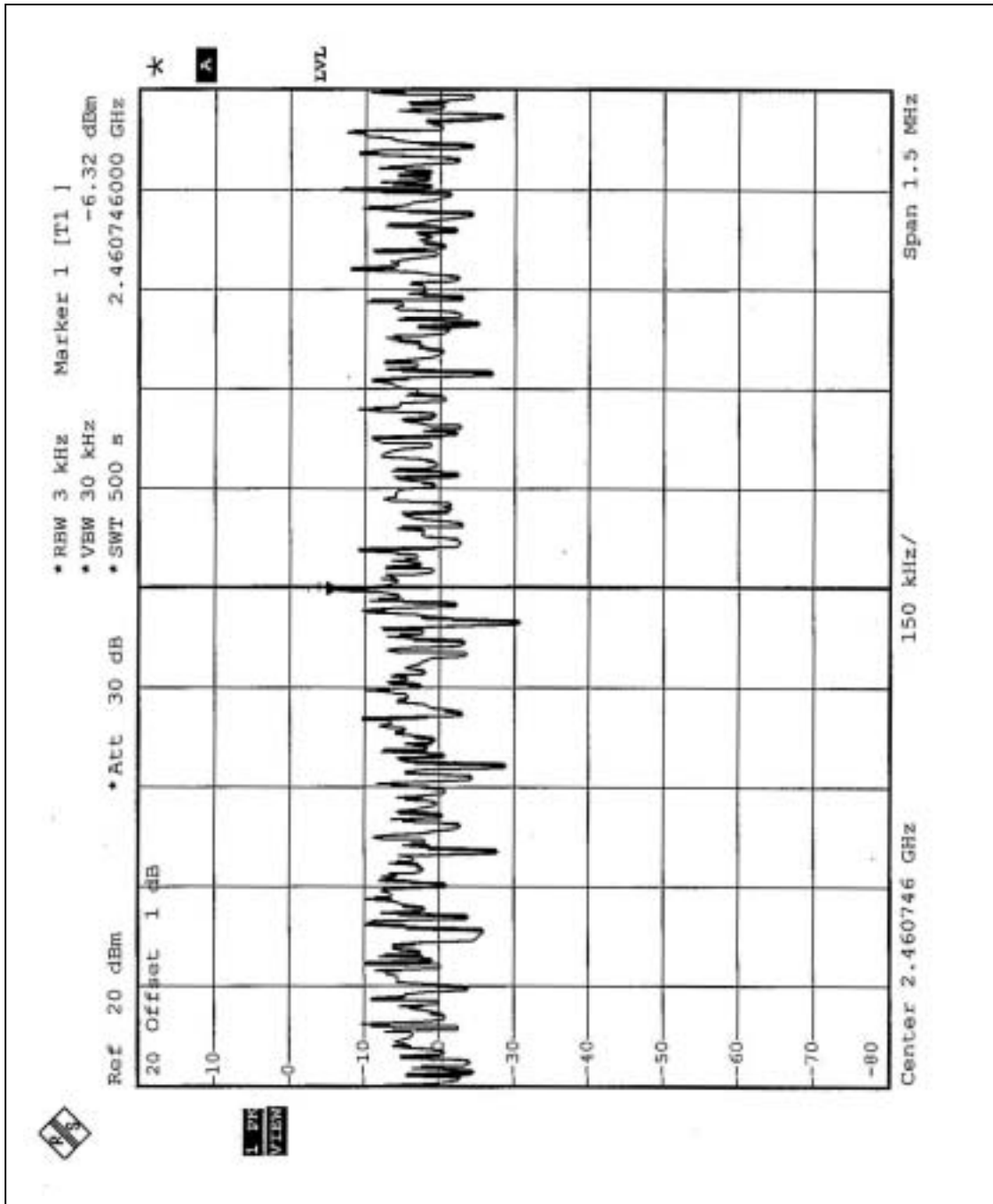



## 4.5.7 TEST RESULTS-OFDM

<b>EUT</b>	Wireless USB Adapter		
<b>MODEL</b>	SpeedTouch 121g	<b>ENVIRONMENTAL CONDITIONS</b>	24 deg. C, 64%RH, 978 hPa
<b>INPUT POWER (SYSTEM)</b>	120Vac, 60 Hz	<b>TESTED BY</b>	Wen Yu

<b>CHANNEL NUMBER</b>	<b>CHANNEL FREQUENCY (MHz)</b>	<b>RF POWER LEVEL IN 3 KHz BW (dBm)</b>	<b>MAXIMUM LIMIT (dBm)</b>	<b>PASS/FAIL</b>
1	2412	-14.98	8	PASS
6	2437	-14.56	8	PASS
11	2462	-15.30	8	PASS



CH1

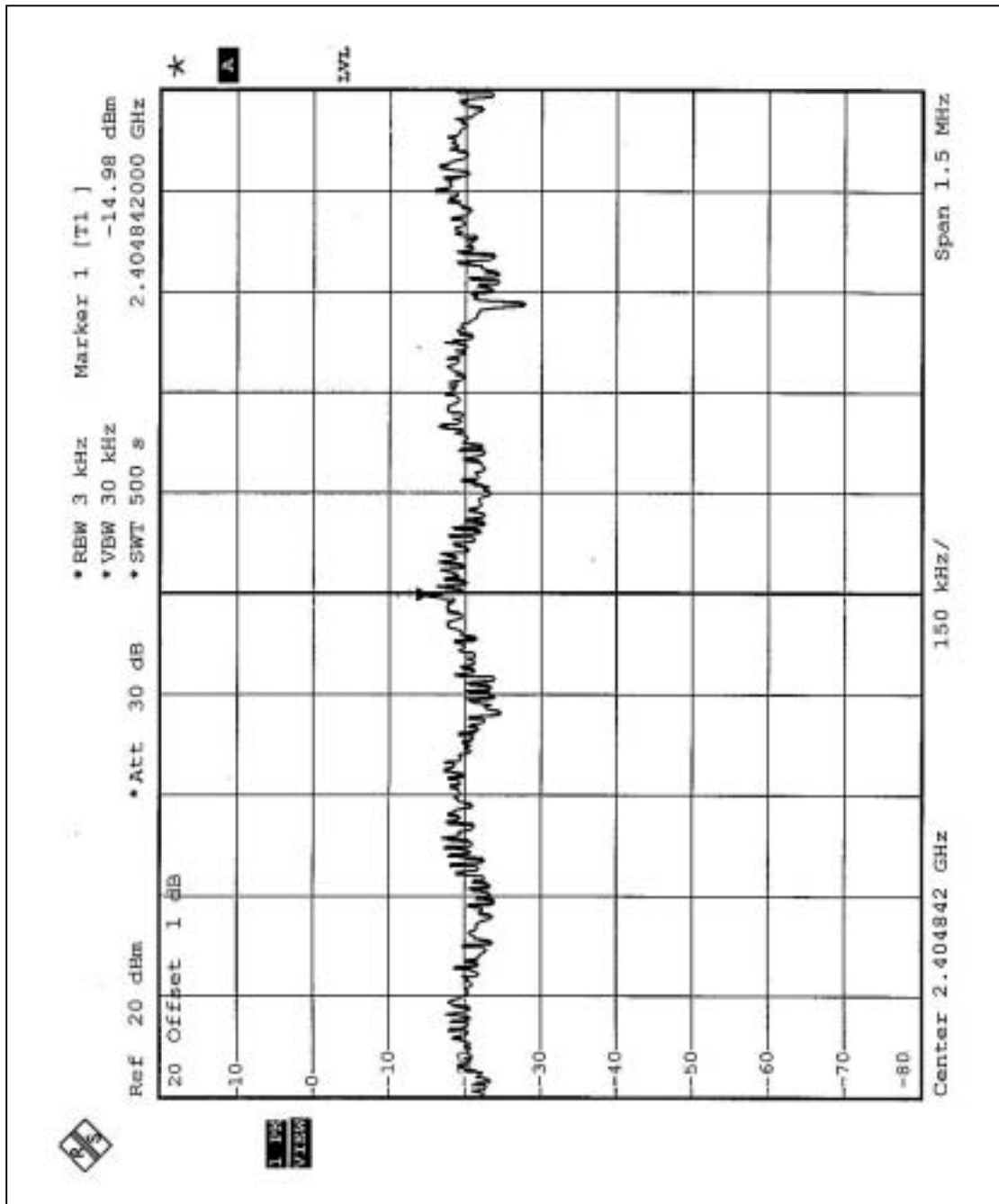



CH6

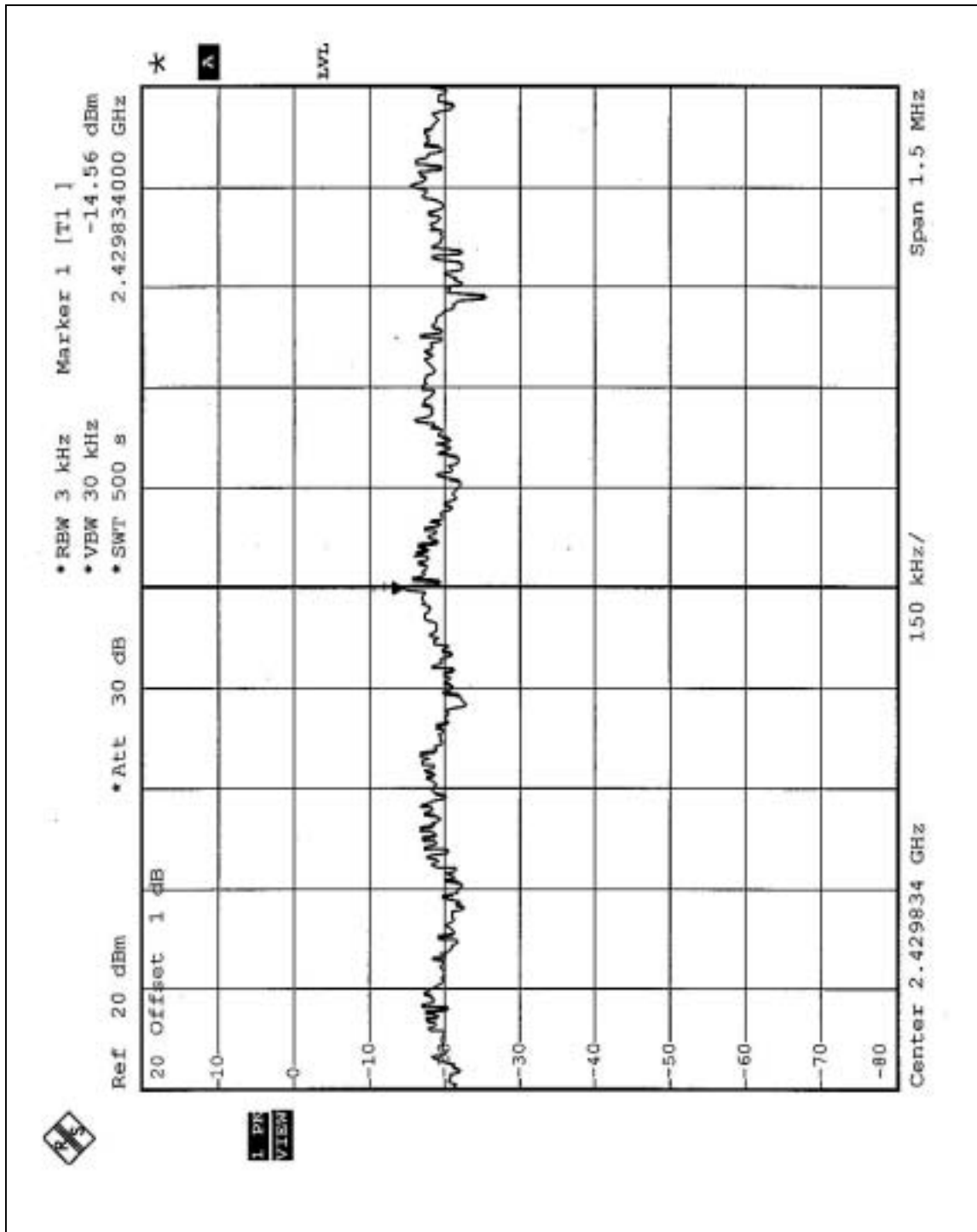



CH11

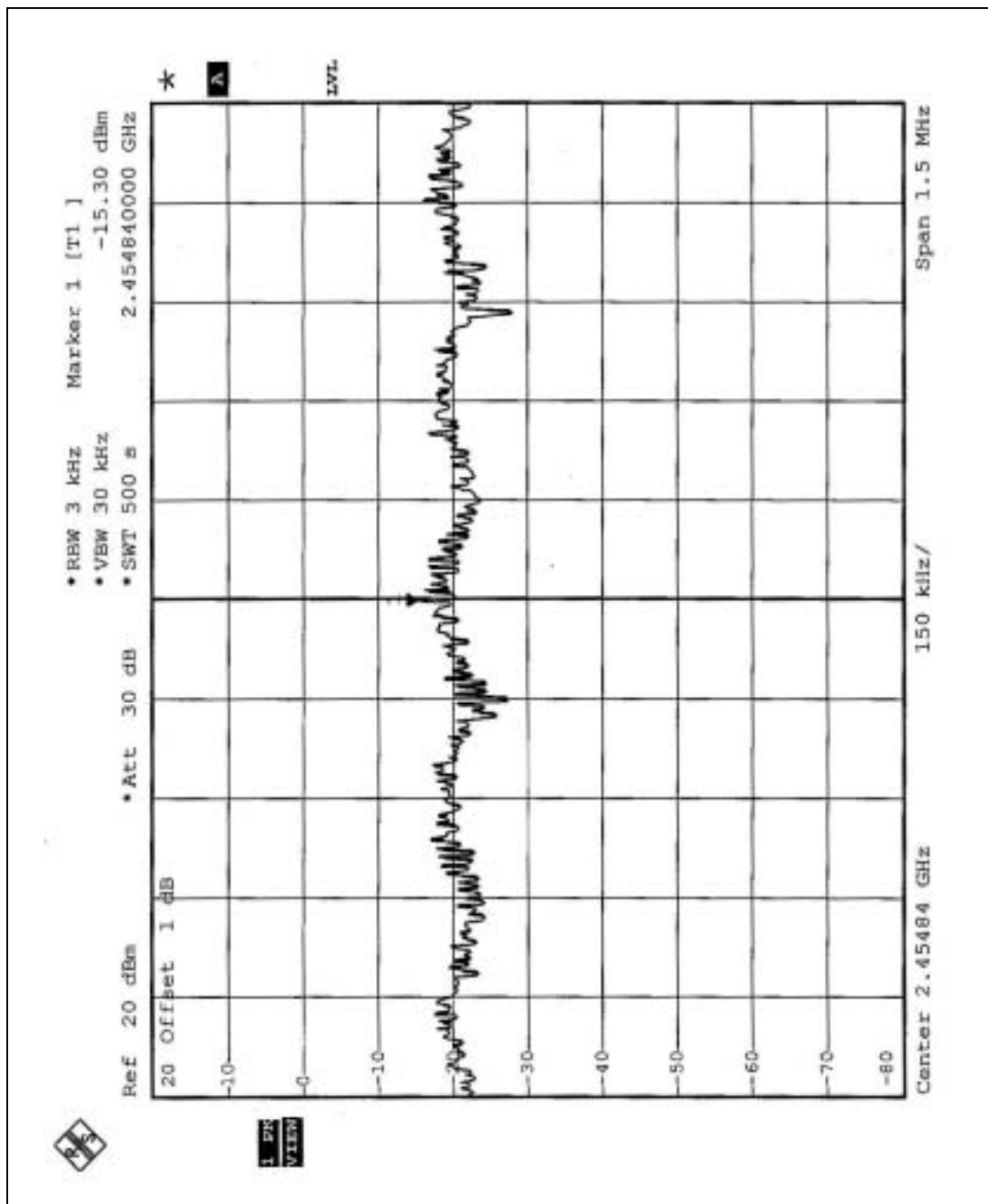





## 4.6 BAND EDGES MEASUREMENT

### 4.6.1 LIMITS OF BAND EDGES MEASUREMENT

Below  $-20\text{dB}$  of the highest emission level of operating band (in 1 MHz Resolution Bandwidth).

### 4.6.2 TEST INSTRUMENTS

Description & Manufacturer	Model No.	Serial No.	Calibrated Until
R&S SPECTRUM ANALYZER	FSP40	100036	Nov. 27, 2004

**NOTE:**

- 1.The measurement uncertainty is less than  $\pm 2.6\text{dB}$ , which is calculated as per the NAMAS document NIS81.
- 2.The calibration interval of the above test instruments is 12 months and the calibrations are traceable to NML/ROC and NIST/USA.

### 4.6.3 TEST PROCEDURE

The transmitter output was connected to the spectrum analyzer via a low lose cable. Set RBW spectrum analyzer to 1 MHz and set VBW spectrum analyzer to 10 Hz with suitable frequency span including 1 MHz bandwidth from band edge. The band edges was measured and recorded.

### 4.6.4 EUT OPERATING CONDITION

Same as Item 4.3.5



#### 4.6.5 TEST RESULTS - DSSS

The spectrum plots are attached on the following 2 pages. D1 line indicates the highest level, D2 line indicates the 20dB offset below D1. It shows compliance with the requirement in part 15.247(C).

Note - The delta method is only used up to 2 MHz away from the restricted bandage, The radiated emissions which located in other restricted frequency band, the result, please refer to 4.2.

**NOTE (1):** The band edge emission plot on the following first page shows 59.23dB delta between carrier maximum power and local maximum emission in restrict band (2.3900GHz). The emission of carrier strength list in the test result of channel 1 at the item 4.2 is 105.5dBuV/m, so the maximum field strength in restrict band is  $105.5-59.23=46.27$ dBuV/m which is under 54 dBuV/m limit.

**NOTE (2):** The band edge emission plot on the following second page shows 58.58dB delta between carrier maximum power and local maximum emission in restrict band (2.4835GHz). The emission of carrier strength list in the test result of channel 11 at the item 4.2. is 103.8dBuV/m, so the maximum field strength in restrict band is  $103.8-58.58=45.22$ dBuV/m which is under 54 dBuV/m limit.

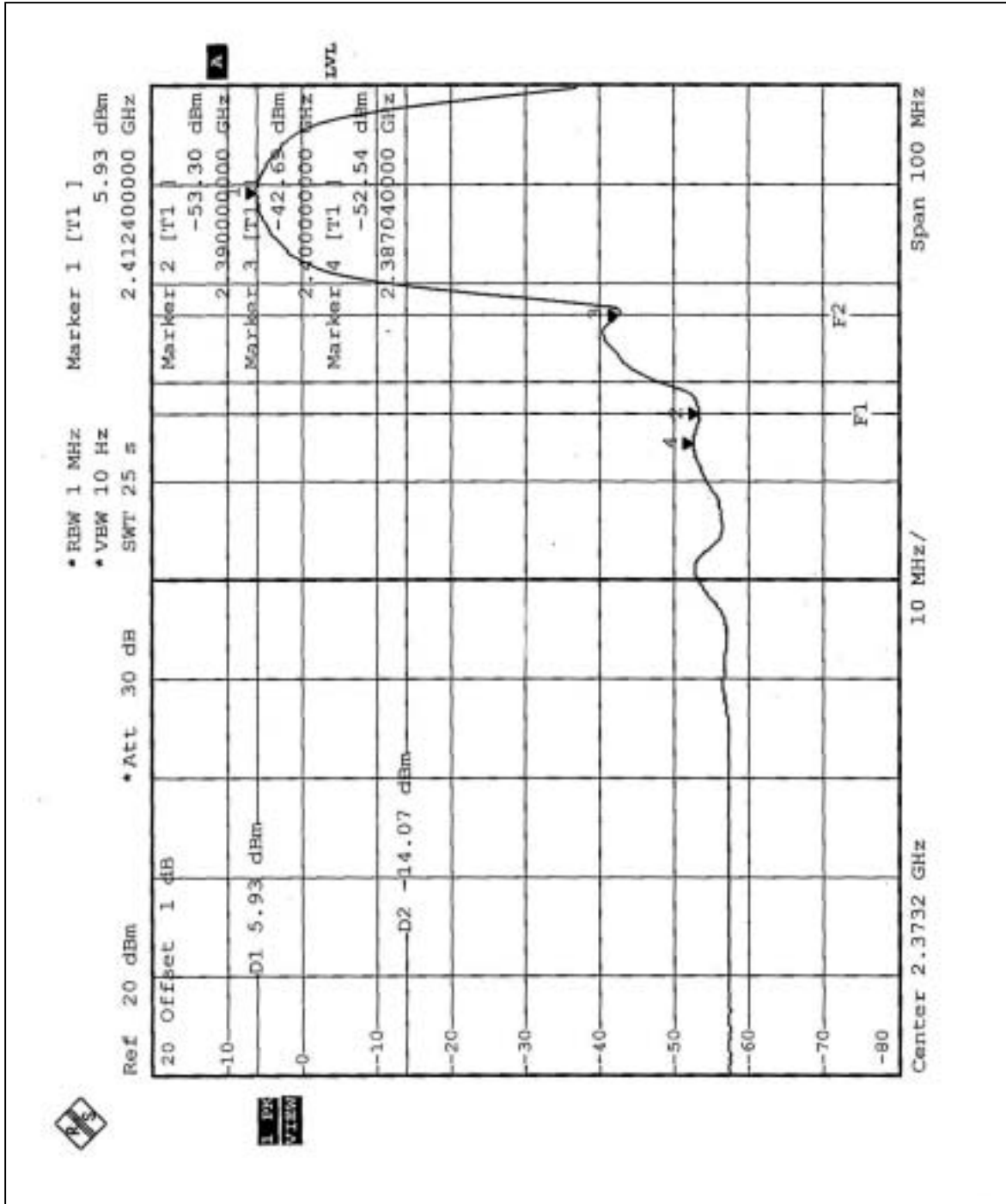

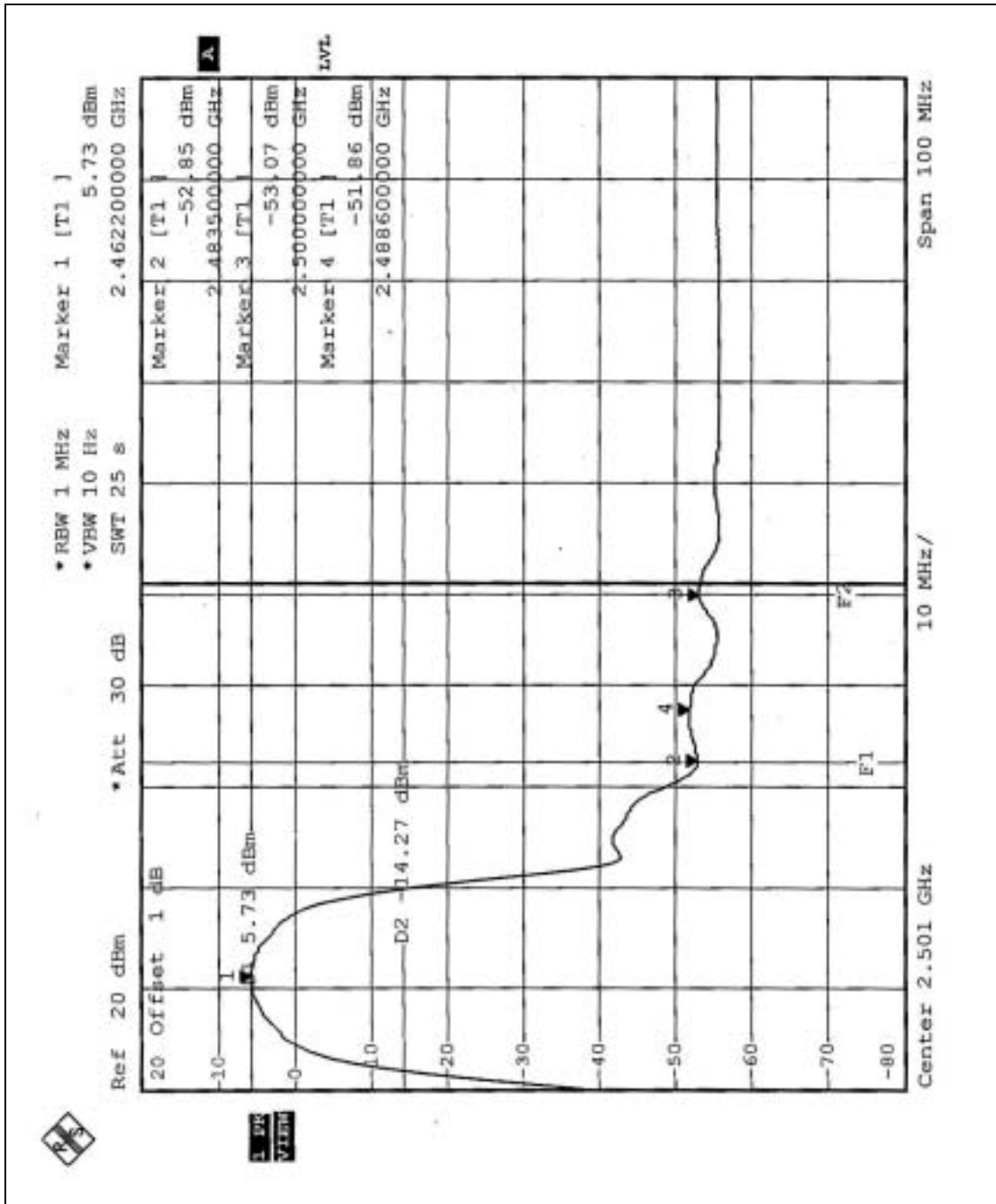



#### 4.6.6 TEST RESULTS-OFDM

The spectrum plots are attached on the following 2 pages. D1 line indicates the highest level, D2 line indicates the 20dB offset below D1. It shows compliance with the requirement in part 15.247(C).

Note - The delta method is only used up to 2 MHz away from the restricted bandage, The radiated emissions which located in other restricted frequency band, the result, please refer to 4.2.

**NOTE (1):** The band edge emission plot on the following first page shows 52.76dB delta between carrier maximum power and local maximum emission in restrict band (2.3900GHz). The emission of carrier strength list in the test result of channel 1 at the item 4.2. is 98.80dBuV/m, so the maximum field strength in restrict band is  $98.80-52.76=46.04$ dBuV/m which is under 54 dBuV/m limit.

**NOTE (2):** The band edge emission plot on the following second page shows 50.45dB delta between carrier maximum power and local maximum emission in restrict band (2.4835GHz). The emission of carrier strength list in the test result of channel 11 at the item 4.2. is 100.20dBuV/m, so the maximum field strength in restrict band is  $100.20-50.45=49.75$ dBuV/m which is under 54 dBuV/m limit.

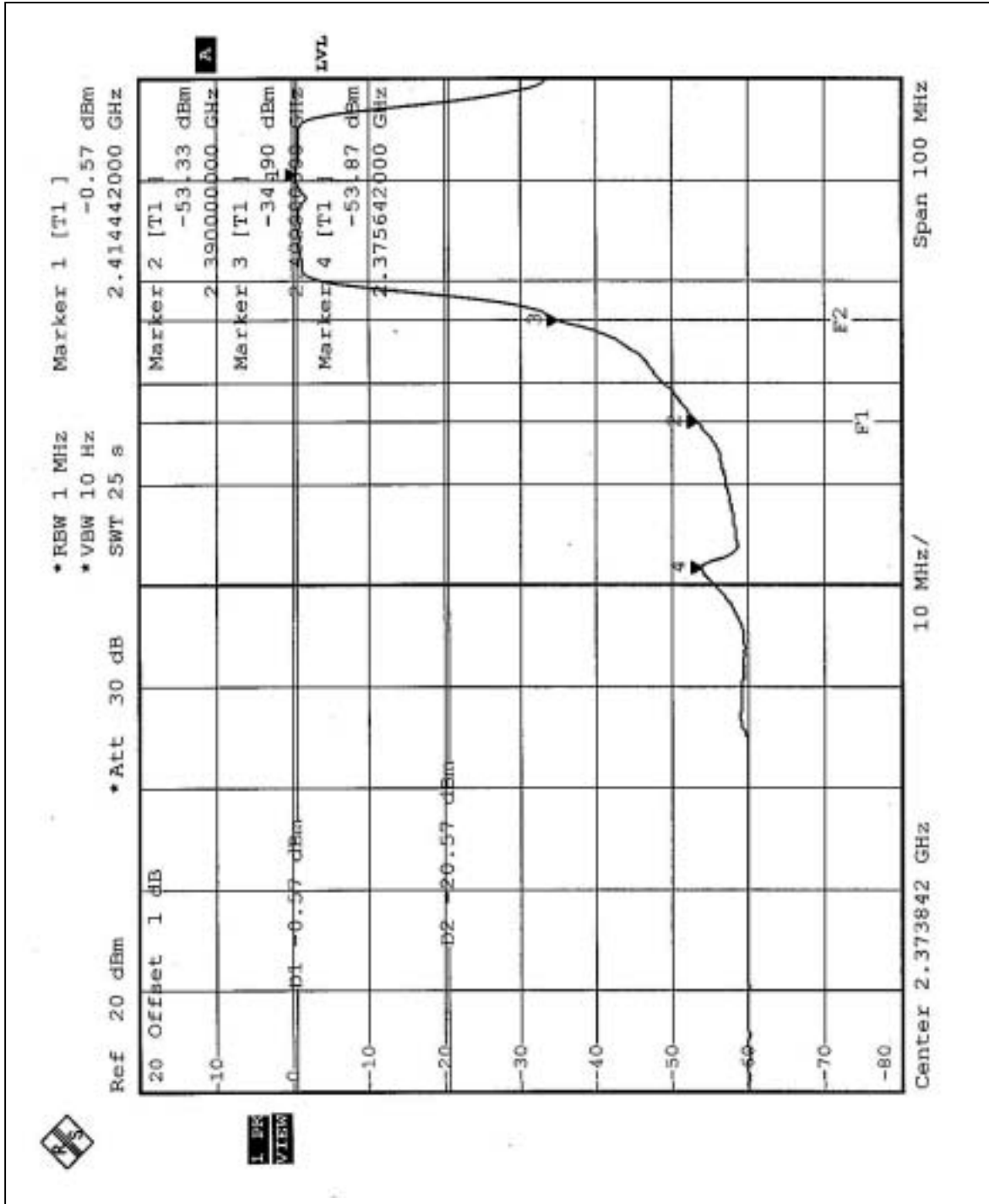

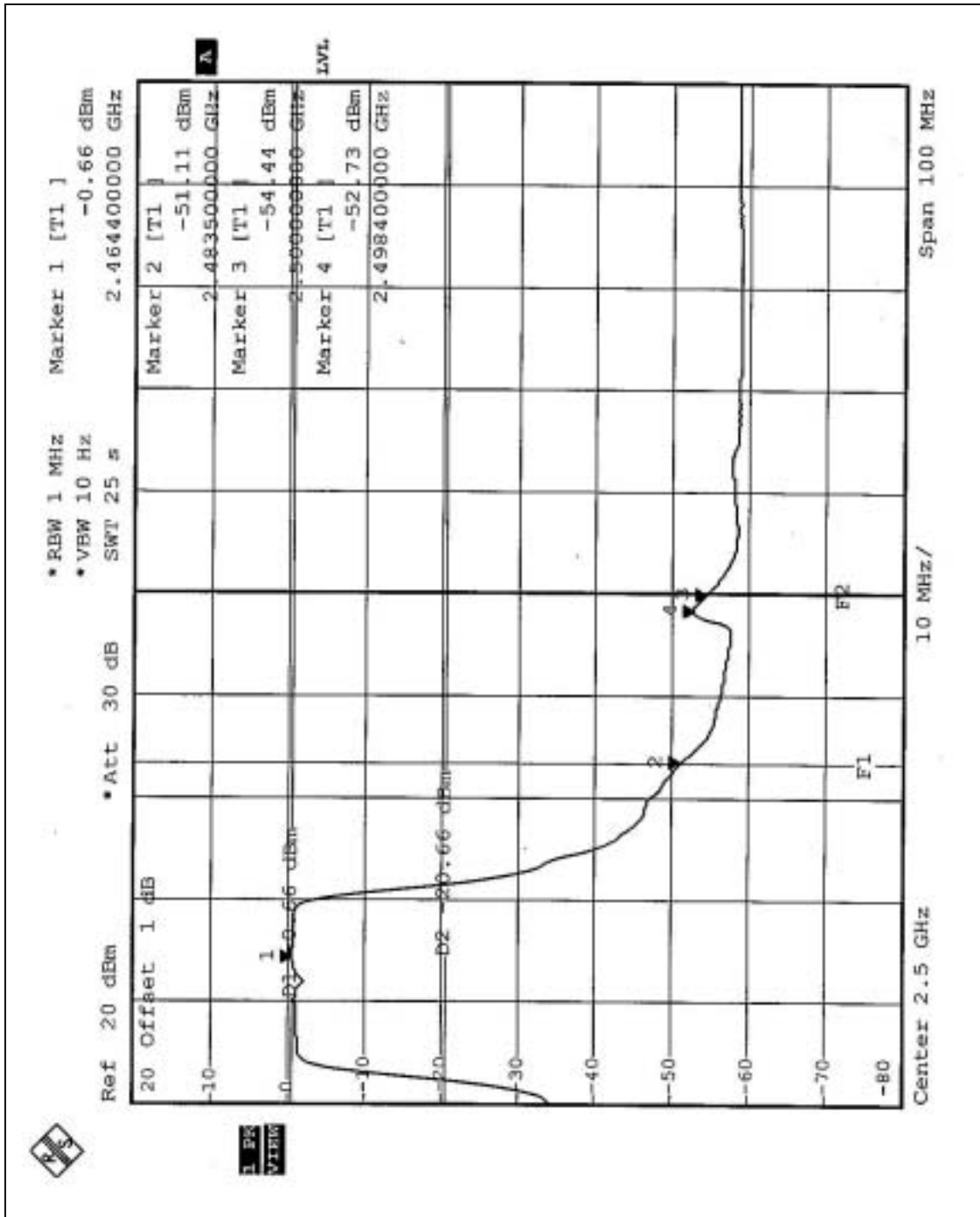



## **4.7 ANTENNA REQUIREMENT**

### **4.7.1 STANDARD APPLICABLE**

For intentional device, according to FCC 47 CFR Section 15.203, an intentional radiator shall be designed to ensure that no antenna other than that furnished by the responsible party shall be used with the device.

And according to FCC 47 CFR Section 15.247 (b), if transmitting antennas of directional gain greater than 6dBi are used, the power shall be reduced by the amount in dB that the directional gain of the antenna exceeds 6dBi.

### **4.7.2 ANTENNA CONNECTED CONSTRUCTION**

The antenna used in this product is PCB antenna without connector. The maximum Gain of the antenna is 1.43dBi.



## 5 PHOTOGRAPHS OF THE TEST CONFIGURATION CONDUCTED EMISSION TEST



### RADIATED EMISSION TEST





## 6 INFORMATION ON THE TESTING LABORATORIES

We, ADT Corp., were founded in 1988 to provide our best service in EMC, Radio, Telecom and Safety consultation. Our laboratories are accredited and approved by the following approval agencies according to ISO/IEC 17025, Guide 25 or EN 45001:

<b>USA</b>	FCC, NVLAP, UL, A2LA
<b>Germany</b>	TUV Rheinland
<b>Japan</b>	VCCI
<b>Norway</b>	NEMKO
<b>Canada</b>	INDUSTRY CANADA , CSA
<b>R.O.C.</b>	CNLA, BSMI, DGT
<b>Netherlands</b>	Telefication
<b>Singapore</b>	PSB , GOST-ASIA(MOU)
<b>Russia</b>	CERTIS(MOU)

Copies of accreditation certificates of our laboratories obtained from approval agencies can be downloaded from our web site: [www.adt.com.tw/index.5/phtml](http://www.adt.com.tw/index.5/phtml). If you have any comments, please feel free to contact us at the following:

**Linko EMC/RF Lab:**

Tel: 886-2-26052180

Fax: 886-2-26052943

**Hsin Chu EMC/RF Lab:**

Tel: 886-3-5935343

Fax: 886-3-5935342

**Hwa Ya EMC/RF/Safety/Telecom Lab:**

Tel: 886-3-3183232

Fax: 886-3-3185050

**Linko RF Lab.**

Tel: 886-3-3270910

Fax: 886-3-3270892

**Email:** [service@mail.adt.com.tw](mailto:service@mail.adt.com.tw)

**Web Site:** [www.adt.com.tw](http://www.adt.com.tw)

The address and road map of all our labs can be found in our web site also.

Report Format Version 1.3