



DFS TEST REPORT

FCC ID : RSE-OWA3111
Equipment : MESH Extender
Trade Name : Technicolor
Model Number : OWA3111, GFEX310
Product Code : MESH Extender
Applicant : Technicolor Delivery Technologies Belgium
Prins Boudewijnlaan 47 Edegem B-2650 Belgium
Standard : 47 CFR FCC Part 15.407

The product was received on Jun. 08, 2020, and testing was started from Mar. 05, 2021 and completed on Mar. 15, 2021. We, Sporton International Inc. Hsinchu Laboratory, would like to declare that the tested sample has been evaluated in accordance with the procedures given in FCC KDB 905462 D02 UNII DFS Compliance Procedures New Rules v02 and shown compliance with the applicable technical standards.

The test results in this variant report apply exclusively to the tested model / sample. Without written approval of Sporton International Inc. Hsinchu Laboratory, the test report shall not be reproduced except in full.

Approved by: Sam Chen

Sporton International Inc. Hsinchu Laboratory

No.8, Ln. 724, Bo'ai St., Zhubei City, Hsinchu County 302010, Taiwan (R.O.C.)



Table of Contents

History of this test report.....3

Summary of Test Result.....4

1 General Description5

1.1 Information.....5

1.2 Accessories15

1.3 Information Provided by the Manufacturer15

1.4 Testing Applied Standards15

1.5 Cabling Attached to the Equipment.....16

1.6 Table for Multiple Listing16

1.7 Table for Class II Change.....16

1.8 Panel Drawing17

1.9 Transmit Operating Modes.....18

1.10 Antenna Requirement20

1.11 Table for Filed Antenna20

1.12 Table for Carrier Frequencies25

1.13 Table for Master Test Modes26

1.14 List of measurements for Master mode.....27

1.15 Support Equipment.....32

1.16 Testing Location Information32

2 Dynamic Frequency Selection (DFS) Test Result33

2.1 General DFS Information33

2.2 Test limits and radar signal parameters35

2.3 UNII Detection Bandwidth83

2.4 Initial Channel Availability Check Time Measurement91

2.5 Channel Shutdown and Non-Occupancy Period for Master mode103

2.6 Statistical Performance Check112

3 Test Equipment and Calibration Data299

4 Measurement Uncertainty300

Appendix A. Test Photos

Photographs of EUT v01



Summary of Test Result

Report Clause	Ref Std. Clause	Test Items	Result (PASS/FAIL)	Remark
2.3	FCC KDB 905462 7.8.1	DFS: UNII Detection Bandwidth Measurement	PASS	-
2.4	FCC KDB 905462 7.8.2.1	DFS: Initial Channel Availability Check Time	PASS	-
2.4	FCC KDB 905462 7.8.2.2	DFS: Radar Burst at the Beginning of the Channel Availability Check Time	PASS	-
2.4	FCC KDB 905462 7.8.2.3	DFS: Radar Burst at the End of the Channel Availability Check Time	PASS	-
2.5	FCC KDB 905462 7.8.3	DFS: In-Service Monitoring for Channel Move Time (CMT)	PASS	-
2.5	FCC KDB 905462 7.8.3	DFS: In-Service Monitoring for Channel Closing Transmission Time (CCTT)	PASS	-
2.5	FCC KDB 905462 7.8.3	DFS: In-Service Monitoring for Non-Occupancy Period (NOP)	PASS	-
2.6	FCC KDB 905462 7.8.4	DFS: Statistical Performance Check	PASS	-
2.1.1	FCC KDB 905462 8.1	User Access Restrictions	N/A	Manufacturer attestation NOT accessible to user

Declaration of Conformity:

The test results with all measurement uncertainty excluded are presented in accordance with the regulation limits or requirements declared by manufacturers.

Comments and Explanations:

1. The test configuration, test mode and test software were written in this test report are declared by the manufacturer.
2. The declared of product specification for EUT presented in the report are provided by the manufacturer, and the manufacturer takes all the responsibilities for the accuracy of product specification.

Reviewed by: Sam Chen

Report Producer: Wendy Pan



1 General Description

1.1 Information

1.1.1 RF General Information

Specification Items	Description	
Equipment Name	MESH Extender	
Trade Name	Technicolor	
Model Number	OWA3111, GFEX310	
Product Code	MESH Extender	
FCC ID	RSE-OWA3111	
Power Type	From power adapter	
Antenna Type	Please see Section 1.10	
EUT Stage	<input checked="" type="checkbox"/> Product Unit	<input type="checkbox"/> Pre-Sample
Operating Band, Conducted Output Power	U-NII-2A 5250~5350MHz	<input checked="" type="checkbox"/> IEEE 802.11a: 23.68 dBm
		<input checked="" type="checkbox"/> IEEE 802.11ax (20MHz): 23.87 dBm
		<input checked="" type="checkbox"/> IEEE 802.11ax (40MHz): 23.94 dBm
		<input checked="" type="checkbox"/> IEEE 802.11ax (80MHz): 22.62 dBm
	U-NII-2C 5470~5725MHz	<input checked="" type="checkbox"/> IEEE 802.11a: 23.49 dBm
		<input checked="" type="checkbox"/> IEEE 802.11ax (20MHz): 23.96 dBm
		<input checked="" type="checkbox"/> IEEE 802.11ax (40MHz): 23.94 dBm
		<input checked="" type="checkbox"/> IEEE 802.11ax (80MHz): 23.95 dBm
		<input checked="" type="checkbox"/> IEEE 802.11ax (160MHz): 23.78 dBm
	Product Type	U-NII-2A 5250~5350MHz
U-NII-2C 5470~5725MHz		For IEEE 802.11a: WLAN (4TX, 4RX) For IEEE 802.11n: WLAN (4TX, 4RX) For IEEE 802.11ac: WLAN (4TX, 4RX) For IEEE 802.11ax: WLAN (4TX, 4RX)
Nominal Channel Bandwidth	20MHz/40MHz/80MHz/160MHz	



Modulation	802.11a: OFDM (BPSK / QPSK / 16QAM / 64QAM) 802.11n: OFDM (BPSK / QPSK / 16QAM / 64QAM) See the below table. 802.11ac: OFDM (BPSK / QPSK / 16QAM / 64QAM/ 256QAM) See the below table 802.11ax: OFDMA(BPSK / QPSK / 16QAM / 64QAM/ 256QAM/1024QAM) See the below table		
Data Rate (Mbps)	U-NII-2A 5250~5350MHz	11a mode: OFDM (6/9/12/18/24/36/48/54) 11n(20MHz) mode: MCS0~MCS15 11n(40MHz) mode: MCS0~MCS15 11ac(20MHz) mode: MCS0~MCS9 for Nss1~Nss2 See the below table 11ac(40MHz) mode: MCS0~MCS9 for Nss1~Nss2 See the below table 11ac(80MHz) mode: MCS0~MCS9 for Nss1~Nss2 See the below table 11ax(20MHz) mode: MCS0~MCS11 for Nss1~Nss2 See the below table 11ax(40MHz) mode: MCS0~MCS11 for Nss1~Nss2 See the below table 11ax(80MHz) mode: MCS0~MCS11 for Nss1~Nss2 See the below table	
	U-NII-2C 5470~5725MHz	11a mode: OFDM (6/9/12/18/24/36/48/54) 11n(20MHz) mode: MCS0~MCS31 11n(40MHz) mode: MCS0~MCS31 11ac(20MHz) mode: MCS0~MCS9 for Nss1~Nss4 See the below table 11ac(40MHz) mode: MCS0~MCS9 for Nss1~Nss4 See the below table 11ac(80MHz) mode: MCS0~MCS9 for Nss1~Nss4 See the below table 11ac(160MHz) mode: MCS0~MCS9 for Nss1~Nss4 See the below table 11ax(20MHz) mode: MCS0~MCS11 for Nss1~Nss4 See the below table 11ax(40MHz) mode: MCS0~MCS11 for Nss1~Nss4 See the below table 11ax(80MHz) mode: MCS0~MCS11 for Nss1~Nss4 See the below table 11ax(160MHz) mode: MCS0~MCS11 for Nss1~Nss4 See the below table	
Operating Mode	<input checked="" type="checkbox"/>	Master	
	<input checked="" type="checkbox"/>	Extender	
	<input type="checkbox"/>	Client with radar detection	
	<input type="checkbox"/>	Client without radar detection	
TPC Function	<input checked="" type="checkbox"/>	With TPC	<input type="checkbox"/> Without TPC
Beam forming Function	<input checked="" type="checkbox"/>	With Beam forming	<input type="checkbox"/> Without Beam forming



DFS Function	<input checked="" type="checkbox"/>	5250~5350MHz
	<input checked="" type="checkbox"/>	5470~5725MHz
	<input checked="" type="checkbox"/>	5600~5650MHz
Off Channel CAC Feature Implemented	<input checked="" type="checkbox"/>	No
Ad-hoc/Hotspot Mode	<input checked="" type="checkbox"/>	No Ad-hoc/Hotspot operation in 5250-5350 MHz and 5470-5725 MHz.
User Access Restrictions	<input checked="" type="checkbox"/>	DFS controls (hardware or software) related to radar detection are NOT accessible to the user.
I/O Ports		LAN Port x 1 WAN Port x 1 USB Port x 1
Hardware Version		BETA 2
Software Version		19.4.e.0362-4849011-20210226114831-3edd5d00a36577b785710c6964ed7592db3f3310

Note: The above information was declared by manufacturer.



802.11n Data Rate spec

Standard	INDEX	Data Rate (Mbps)		Standard	INDEX	Data Rate (Mbps)	
		LGI (800ns)	SGL (400ns)			LGI (800ns)	SGL (400ns)
11n 20MHz Nss=1	MCS0	6.5	7.2	11n 40MHz Nss=1	MCS0	13.5	15
	MCS1	13	14.4		MCS1	27	30
	MCS2	19.5	21.7		MCS2	40.5	45
	MCS3	26	28.9		MCS3	54	60
	MCS4	39	43.3		MCS4	81	90
	MCS5	52	57.8		MCS5	108	120
	MCS6	58.5	65		MCS6	121.5	135
11n 20MHz Nss=2	MCS7	65	72.2	MCS7	135	150	
	MCS8	13	14.4	11n 40MHz Nss=2	MCS8	27	30
	MCS9	26	28.9		MCS9	54	60
	MCS10	39	43.3		MCS10	81	90
	MCS11	52	57.8		MCS11	108	120
	MCS12	78	86.7		MCS12	162	180
	MCS13	104	115.6		MCS13	216	240
MCS14	117	130	MCS14		243	270	
11n 20MHz Nss=3	MCS15	130	144.4	MCS15	270	300	
	MCS16	19.5	21.7	11n 40MHz Nss=3	MCS16	40.5	45
	MCS17	39	43.3		MCS17	81	90
	MCS18	58.5	65		MCS18	121.5	135
	MCS19	78	86.7		MCS19	162	180
	MCS20	117	130		MCS20	243	270
	MCS21	156	173.3		MCS21	324	360
MCS22	175.5	195	MCS22		364.5	405	
11n 20MHz Nss=4	MCS23	195	216.7	MCS23	405	450	
	MCS24	26	28.9	11n 40MHz Nss=4	MCS24	54	60
	MCS25	52	57.8		MCS25	108	120
	MCS26	78	86.7		MCS26	162	180
	MCS27	104	115.6		MCS27	216	240
	MCS28	156	173.3		MCS28	324	360
	MCS29	208	231.1		MCS29	432	480
MCS30	234	260	MCS30		486	540	
MCS31	260	288.9	MCS31	540	600		



802.11ac Data Rate spec

Standard	INDEX	Data Rate (Mbps)		Standard	INDEX	Data Rate (Mbps)		Standard	INDEX	Data Rate (Mbps)	
		LGI (800ns)	SGI (400ns)			LGI (800ns)	SGI (400ns)			LGI (800ns)	SGI (400ns)
11ac 20MHz Nss=1	MCS0	6.5	7.2	11ac 40MHz Nss=1	MCS0	13.5	15.0	11ac 80MHz Nss=1	MCS0	29.3	32.5
	MCS1	13.0	14.4		MCS1	27	30.0		MCS1	58.5	65.0
	MCS2	19.5	21.7		MCS2	40.5	45.0		MCS2	87.8	97.5
	MCS3	26	28.9		MCS3	54	60.0		MCS3	117.0	130.0
	MCS4	39	43.3		MCS4	81	90.0		MCS4	175.5	195.0
	MCS5	52	57.8		MCS5	108	120.0		MCS5	234.0	260.0
	MCS6	58.5	65		MCS6	121.5	135.0		MCS6	263.3	292.5
	MCS7	65	72.2		MCS7	135.0	150.0		MCS7	292.5	325.0
	MCS8	78	86.7		MCS8	162.0	180.0		MCS8	351.0	390.0
	MCS9	Note	Note		MCS9	180.0	200.0		MCS9	390.0	433.3

NOTE: MCS 9 is invalid due to mod(NCBPS/NES, DR) not being equal to 0.

Standard	INDEX	Data Rate (Mbps)		Standard	INDEX	Data Rate (Mbps)		Standard	INDEX	Data Rate (Mbps)	
		LGI (800ns)	SGI (400ns)			LGI (800ns)	SGI (400ns)			LGI (800ns)	SGI (400ns)
11ac 20MHz Nss=2	MCS0	13.0	14.4	11ac 40MHz Nss=2	MCS0	27.0	30.0	11ac 80MHz Nss=2	MCS0	58.5	65.0
	MCS1	26.0	28.9		MCS1	54.0	60.0		MCS1	117.0	130.0
	MCS2	39.0	43.3		MCS2	81.0	90.0		MCS2	175.5	195.0
	MCS3	52.0	57.8		MCS3	108.0	120.0		MCS3	234.0	260.0
	MCS4	78.0	86.7		MCS4	162.0	180.0		MCS4	351.0	390.0
	MCS5	104.0	115.6		MCS5	216.0	240.0		MCS5	468.0	520.0
	MCS6	117.0	130.0		MCS6	243.0	270.0		MCS6	526.5	585.0
	MCS7	130.0	144.4		MCS7	270.0	300.0		MCS7	585.0	650.0
	MCS8	156.0	173.3		MCS8	324.0	360.0		MCS8	702.0	780.0
	MCS9	13.0	14.4		MCS9	360.0	400.0		MCS9	780.0	866.7



Standard	INDEX	Data Rate (Mbps)		Standard	INDEX	Data Rate (Mbps)		Standard	INDEX	Data Rate (Mbps)	
		LGI (800ns)	SGI (400ns)			LGI (800ns)	SGI (400ns)			LGI (800ns)	SGI (400ns)
11ac 20MHz Nss=3	MCS0	19.5	21.7	11ac 40MHz Nss=3	MCS0	40.5	45.0	11ac 80MHz Nss=3	MCS0	87.8	97.5
	MCS1	39.0	43.3		MCS1	81.0	90.0		MCS1	175.5	195.0
	MCS2	58.5	65.0		MCS2	121.5	135.0		MCS2	263.3	292.5
	MCS3	78.0	86.7		MCS3	162.0	180.0		MCS3	351.0	190.0
	MCS4	117.0	130		MCS4	243.0	270.0		MCS4	526.5	585.0
	MCS5	156.0	173.3		MCS5	324.0	360.0		MCS5	702.0	780.0
	MCS6	175.5	195.0		MCS6	364.5	405.0		MCS6	Note	Note
	MCS7	195.0	216.7		MCS7	405.0	450.0		MCS7	877.5	975.0
	MCS8	234.0	260.0		MCS8	486.0	540.0		MCS8	1053.0	1170.0
	MCS9	260.0	228.9		MCS9	540.0	600.0		MCS9	1170.0	1300.0

NOTE: MCS 6 is invalid due to mod(NCBPS/NES, DR) not being equal to 0.

Standard	INDEX	Data Rate (Mbps)		Standard	INDEX	Data Rate (Mbps)		Standard	INDEX	Data Rate (Mbps)	
		LGI (800ns)	SGI (400ns)			LGI (800ns)	SGI (400ns)			LGI (800ns)	SGI (400ns)
11ac 20MHz Nss=4	MCS0	26.0	28.9	11ac 40MHz Nss=4	MCS0	54.0	60.0	11ac 80MHz Nss=4	MCS0	117.0	130.0
	MCS1	52.0	57.8		MCS1	108.0	120.0		MCS1	234.0	260.0
	MCS2	78.0	86.7		MCS2	162.0	180.0		MCS2	351.0	390.0
	MCS3	104.0	115.6		MCS3	216.0	240.0		MCS3	468.0	520.0
	MCS4	156.0	173.3		MCS4	324.0	360.0		MCS4	702.0	780.0
	MCS5	208.0	231.1		MCS5	432.0	480.0		MCS5	936.0	1040.0
	MCS6	234.0	260.0		MCS6	486.0	540.0		MCS6	1053.0	1170.0
	MCS7	260.0	288.9		MCS7	540.0	600.0		MCS7	1170.0	1300.0
	MCS8	312.0	346.7		MCS8	648.0	720.0		MCS8	1404.0	1560.0
	MCS9	Note	Note		MCS9	720.0	800.0		MCS9	1560.0	1733.3

NOTE: MCS 9 is invalid due to mod(NCBPS/NES, DR) not being equal to 0.



Standard	Index	Data Rate (Mbps)		Standard	Index	Data Rate (Mbps)	
		LGI (800ns)	Sgi (400ns)			LGI (800ns)	Sgi (400ns)
11ac 160MHz NSS = 1	MCS0	58.5	65	11ac 160MHz NSS = 2	MCS0	117	130
	MCS1	117	130		MCS1	234	260
	MCS2	175.5	195		MCS2	351	390
	MCS3	234	260		MCS3	468	520
	MCS4	351	390		MCS4	702	780
	MCS5	468	520		MCS5	936	1040
	MCS6	526.5	585		MCS6	1053	1170
	MCS7	585	650		MCS7	1170	1300
	MCS8	702	780		MCS8	1404	1560
	MCS9	780	866.7		MCS9	1560	1733.3
Standard	Index	Data Rate (Mbps)		Standard	Index	Data Rate (Mbps)	
		LGI (800ns)	Sgi (400ns)			LGI (800ns)	Sgi (400ns)
11ac 160MHz NSS = 3	MCS0	175.5	195	11ac 160MHz NSS = 4	MCS0	234	260
	MCS1	351	390		MCS1	468	520
	MCS2	526.5	585		MCS2	702	780
	MCS3	702	780		MCS3	936	1040
	MCS4	1053	1170		MCS4	1404	1560
	MCS5	1404	1560		MCS5	1872	2080
	MCS6	1579.5	1755		MCS6	2106	2340
	MCS7	1755	1950		MCS7	2340	2600
	MCS8	2106	2340		MCS8	2808	3120
	MCS9	N/A	N/A		MCS9	3120	3466.7

Note: MCS 9 is invalid due to mod (NCBPS/NES, DR) not being equal to 0.



802.11ax Data Rate spec

Standard	Index	Data Rate (Mbps)			Standard	Index	Data Rate (Mbps)			Standard	Index	Data Rate (Mbps)		
		SGI (0.8us)	MGI (1.6us)	LGI (3.2us)			SGI (0.8us)	MGI (1.6us)	LGI (3.2us)			SGI (0.8us)	MGI (1.6us)	LGI (3.2us)
11ax 20MH NSS=1	MCS0	8.6	8.1	7.3	11ax 40MHz NSS=1	MCS0	17.2	16.3	14.6	11ax 80MHz NSS=1	MCS0	36	34	30.6
	MCS1	17.2	16.3	14.6		MCS1	34.4	32.5	29.3		MCS1	72.1	68.1	61.3
	MCS2	25.8	24.4	21.9		MCS2	51.6	48.8	43.9		MCS2	108.1	102.1	91.9
	MCS3	34.4	32.5	29.3		MCS3	68.8	65	58.5		MCS3	144.1	136.1	122.5
	MCS4	51.6	48.8	43.9		MCS4	103.2	97.5	87.8		MCS4	216.2	204.2	183.8
	MCS5	68.8	65	58.5		MCS5	137.6	130	117		MCS5	288.2	272.2	245
	MCS6	77.4	73.1	65.8		MCS6	154.9	146.3	131.6		MCS6	324.3	306.3	275.6
	MCS7	86	81.3	73.1		MCS7	172.1	162.5	146.3		MCS7	360.3	340.3	306.3
	MCS8	103.2	97.5	87.8		MCS8	206.5	195	175.5		MCS8	432.4	408.3	367.5
	MCS9	114.7	108.3	97.5		MCS9	229.4	216.7	195		MCS9	480.4	453.7	408.3
	MCS10	129	121.9	109.7		MCS10	258.1	243.8	219.4		MCS10	540.4	510.4	459.4
MCS11	143.4	135.4	121.9	MCS11	286.8	270.8	243.8	MCS11	600.5	567.1	510.4			
Standard	Index	Data Rate (Mbps)			Standard	Index	Data Rate (Mbps)			Standard	Index	Data Rate (Mbps)		
		SGI (0.8us)	MGI (1.6us)	LGI (3.2us)			SGI (0.8us)	MGI (1.6us)	LGI (3.2us)			SGI (0.8us)	MGI (1.6us)	LGI (3.2us)
11ax 20MHz NSS=2	MCS0	17.2	16.3	14.6	11ax 40MHz NSS=2	MCS0	34.4	32.5	29.3	11ax 80MHz NSS=2	MCS0	72.1	68.1	61.3
	MCS1	34.4	32.5	29.3		MCS1	68.8	65	58.5		MCS1	144.1	136.1	122.5
	MCS2	51.6	48.8	43.9		MCS2	103.2	97.5	87.8		MCS2	216.2	204.2	183.8
	MCS3	68.8	65	58.5		MCS3	137.6	130	117		MCS3	288.2	272.2	245
	MCS4	103.2	97.5	87.8		MCS4	206.5	195	175.5		MCS4	432.4	408.3	367.5
	MCS5	137.6	130	117		MCS5	275.3	260	234		MCS5	576.5	544.4	490
	MCS6	154.9	146.3	131.6		MCS6	309.7	292.5	263.3		MCS6	648.5	612.5	551.3
	MCS7	172.1	162.5	146.3		MCS7	344.1	325	292.5		MCS7	720.6	680.6	612.5
	MCS8	206.5	195	175.5		MCS8	412.9	390	351		MCS8	864.7	816.7	735
	MCS9	229.4	216.7	195		MCS9	458.8	433.3	390		MCS9	960.8	907.4	816.7
	MCS10	258.1	243.8	219.4		MCS10	516.2	487.5	438.8		MCS10	1080.9	1020.8	918.8
MCS11	286.8	270.8	243.8	MCS11	573.5	541.7	487.5	MCS11	1201	1134.3	1020.8			



Standard	Index	Data Rate (Mbps)			Standard	Index	Data Rate (Mbps)			Standard	Index	Data Rate (Mbps)		
		SGI (0.8us)	MGI (1.6us)	LGI (3.2us)			SGI (0.8us)	MGI (1.6us)	LGI (3.2us)			SGI (0.8us)	MGI (1.6us)	LGI (3.2us)
11ax 20MHz NSS=3	MCS0	25.8	24.4	21.9	11ax 40MHz NSS=3	MCS0	51.6	48.8	43.9	11ax 80MHz NSS=3	MCS0	108.1	102.1	91.9
	MCS1	51.6	48.8	43.9		MCS1	103.2	97.5	87.8		MCS1	216.2	204.2	183.8
	MCS2	77.4	73.1	65.8		MCS2	154.9	146.3	131.6		MCS2	324.3	306.3	275.6
	MCS3	103.2	97.5	87.8		MCS3	206.5	195	175.5		MCS3	432.4	408.3	367.5
	MCS4	154.9	146.3	131.6		MCS4	309.7	292.5	263.3		MCS4	648.5	612.5	551.3
	MCS5	206.5	195	175.5		MCS5	412.9	390	351		MCS5	864.7	816.7	735
	MCS6	232.3	219.4	197.4		MCS6	464.6	438.8	394.9		MCS6	972.8	918.8	826.9
	MCS7	258.1	243.8	219.4		MCS7	516.2	487.5	438.8		MCS7	1080.9	1020.8	918.8
	MCS8	309.7	292.5	263.3		MCS8	619.4	585	526.5		MCS8	1297.1	1225	1102.5
	MCS9	344.1	325	292.5		MCS9	688.2	650	585		MCS9	1441.2	1361.1	1225
	MCS10	387.1	365.6	329.1		MCS10	774.3	731.3	658.1		MCS10	1621.3	1531.3	1378.1
MCS11	430.1	406.3	365.6	MCS11	860.3	812.5	731.3	MCS11	1801.5	1701.4	1531.3			
11ax 20MHz NSS=4	MCS0	34.4	32.5	29.3	11ax 40MHz NSS=4	MCS0	68.8	65	58.5	11ax 80MHz NSS=4	MCS0	144.1	136.1	122.5
	MCS1	68.8	65	58.5		MCS1	137.6	130	117		MCS1	288.2	272.2	245
	MCS2	103.2	97.5	87.8		MCS2	206.5	195	175.5		MCS2	432.4	408.3	367.5
	MCS3	137.6	130	117		MCS3	275.3	260	234		MCS3	576.5	544.4	490
	MCS4	206.5	195	175.5		MCS4	412.9	390	351		MCS4	864.7	816.7	735
	MCS5	275.3	260	234		MCS5	550.6	520	468		MCS5	1152.9	1088.9	980
	MCS6	309.7	292.5	263.3		MCS6	619.4	585	526.5		MCS6	1297.1	1225	1102.5
	MCS7	344.1	325	292.5		MCS7	688.2	650	585		MCS7	1441.2	1361.1	1225
	MCS8	412.9	390	351		MCS8	825.9	780	702		MCS8	1729.4	1633.3	1470
	MCS9	458.8	433.3	390		MCS9	917.6	866.7	780		MCS9	1921.6	1814.8	1633.3
	MCS10	516.2	487.5	438.8		MCS10	1032.4	975	877.5		MCS10	2161.8	2041.7	1837.5
MCS11	573.5	541.7	487.5	MCS11	1147.1	1083.3	975	MCS11	2401.9	2268.5	2041.7			



Standard	Index	Data Rate (Mbps)			Standard	Index	Data Rate (Mbps)		
		SGI (0.8us)	MGI (1.6us)	LGI (3.2us)			SGI (0.8us)	MGI (1.6us)	LGI (3.2us)
11ax 160MHz NSS = 1	MCS0	72.1	68.1	61.3	11ax 160MHz NSS = 2	MCS0	144.1	136.1	122.5
	MCS1	144.1	136.1	122.5		MCS1	288.2	272.2	245
	MCS2	216.2	204.2	183.8		MCS2	432.4	408.3	367.5
	MCS3	288.2	272.2	245		MCS3	576.5	544.4	490
	MCS4	432.4	408.3	367.5		MCS4	864.7	816.7	735
	MCS5	576.5	544.4	490		MCS5	1152.9	1088.9	980
	MCS6	648.5	612.5	551.3		MCS6	1297.1	1225	1102.5
	MCS7	720.6	680.6	612.5		MCS7	1441.2	1361.1	1225
	MCS8	864.7	816.7	735		MCS8	1729.4	1633.3	1470
	MCS9	960.8	907.4	816.7		MCS9	1921.6	1814.8	1633.3
	MCS10	1080.9	1020.8	918.8		MCS10	2161.8	2041.7	1837.5
	MCS11	1201	1134.3	1020.8		MCS11	2402	2268.5	2041.7
Standard	Index	Data Rate (Mbps)			Standard	Index	Data Rate (Mbps)		
		SGI (0.8us)	MGI (1.6us)	LGI (3.2us)			SGI (0.8us)	MGI (1.6us)	LGI (3.2us)
11ax 160MHz NSS = 3	MCS0	216.2	204.2	183.8	11ax 160MHz NSS = 4	MCS0	288.2	272.2	245
	MCS1	432.4	408.3	367.5		MCS1	576.5	544.4	490
	MCS2	648.5	612.5	551.3		MCS2	864.7	816.7	735
	MCS3	864.7	816.7	735		MCS3	1152.9	1088.9	980
	MCS4	1297.1	1225	1102.5		MCS4	1729.4	1633.3	1470
	MCS5	1729.4	1633.3	1470		MCS5	2305.9	2177.8	1960
	MCS6	1945.6	1837.5	1653.8		MCS6	2594.1	2450	2205
	MCS7	2161.8	2041.7	1837.5		MCS7	2882.4	2722.2	2450
	MCS8	2594.1	2450	2205		MCS8	3458.8	3266.7	2940
	MCS9	2882.4	2722.2	2450		MCS9	3843.1	3629.6	3266.7
	MCS10	3242.6	3062.5	2756.3		MCS10	4323.5	4083.3	3675
	MCS11	3602.9	3402.8	3062.5		MCS11	4803.9	4537	4083.3



1.2 Accessories

Adapter

Model	ADS-24FUA-12 12024EPCU
Technicolor P/N	6265293A
ID	01
Manufacturer	HONOR
Input Power	100-240V~50/60Hz, MAX. 0.7A
Output Power	12V, 2.0A
Cable Length	Non-shielded 1.2m

RJ-45 cable

Cable Length	Non-shielded 1.5m
--------------	-------------------

1.3 Information Provided by the Manufacturer

Interface Availability

Interface	Internal AC~DC Power Input:100~240V output: DC 12Vdc 2A	LAN 10/100/1000 Mbps	LAN 10/100/1000 Mbps	USB 2.0	WLAN IEEE 802.11a/b/g/n/ac/ax (2.4GHz 2*2) (5GHz H 2*2 ax) (5GHz L 4*4 ax)
Model Number					
OWA3111, GFEX310	● (2A)	● (1 port)	● (1 port)	● (1 port)	●

Note:

- : Equipped
- : Not Equipped

1.4 Testing Applied Standards

According to the specifications of the manufacturer, the EUT must comply with the requirements of the following standards:

47 CFR FCC Part 15.407

ANSI C63.10-2013

FCC KDB 905462 D02 UNII DFS Compliance Procedures New Rules v02

All test items have been performed and recorded as per the above standards.



1.5 Cabling Attached to the Equipment

Table 1- Cable and Interconnection

Interface	Cable type	Cable length delivered with the modem	“Real life” Cable length that can be attached to this type of interface	Cable length to be used for testing	Internal/External connection
WAN	UTP Cat 5	1 meter	> 10 meter	10 meter	External
LAN	UTP Cat 5	1 meter	> 10 meter	10 meter	Internal
USB	STP	1 meter	< 3meter	1 meter	Internal
AC power	-	-	-	-	External

1.6 Table for Multiple Listing

The model numbers in the following table are all refer to the identical product.

Model Number	Description
OWA3111	For marketing reason the same product will be covered by different name.
GFEX310	

From the above model numbers, model number: OWA3111 was selected as representative model for the test and its data was recorded in this report.

1.7 Table for Class II Change

This product is an extension of original one reported under Sporton project number: 071024

Below is the table for the change of the product with respect to the original one.

Modifications	Performance Checking
1. Adding Band 2 and Band 3 (5250~5350 MHz, 5470~5725 MHz) 2. Adding the 160MHz (5570 MHz).	DFS test.

1.8 Panel Drawing



Reset
DC-Power Jack
USB 2.0
LAN
WAN



1.9 Transmit Operating Modes

<For 5250~5350MHz>

Transmit Operating Mode				Transmit Multiple Antennas						
■	Operating mode 1 (single antenna)			■	1TX					
■	Operating mode 2 (multiple antenna, no beam forming)			■	2TX	<input type="checkbox"/>	3TX	<input type="checkbox"/>	4TX	
■	Operating mode 3 (multiple antenna, with beam forming)			■	2TX	<input type="checkbox"/>	3TX	<input type="checkbox"/>	4TX	
■	802.11a	Operating mode	■	1TX	■	2TX	<input type="checkbox"/>	3TX	<input type="checkbox"/>	4TX
■	802.11n(20MHz)	Operating mode	■	1TX	■	2TX	<input type="checkbox"/>	3TX	<input type="checkbox"/>	4TX
■	802.11n(40MHz)	Operating mode	■	1TX	■	2TX	<input type="checkbox"/>	3TX	<input type="checkbox"/>	4TX
■	802.11ac(20MHz)	Operating mode	■	1TX	■	2TX	<input type="checkbox"/>	3TX	<input type="checkbox"/>	4TX
■	802.11ac(40MHz)	Operating mode	■	1TX	■	2TX	<input type="checkbox"/>	3TX	<input type="checkbox"/>	4TX
■	802.11ac(80MHz)	Operating mode	■	1TX	■	2TX	<input type="checkbox"/>	3TX	<input type="checkbox"/>	4TX
■	802.11ax(20MHz)	Operating mode	■	1TX	■	2TX	<input type="checkbox"/>	3TX	<input type="checkbox"/>	4TX
■	802.11ax(40MHz)	Operating mode	■	1TX	■	2TX	<input type="checkbox"/>	3TX	<input type="checkbox"/>	4TX
■	802.11ax(80MHz)	Operating mode	■	1TX	■	2TX	<input type="checkbox"/>	3TX	<input type="checkbox"/>	4TX

For IEEE802.11a,

6Mbps~54Mbps: 1TX; 2TX;

For IEEE802.11n,

MCS0~MCS7: 1 Stream 1TX, 1 Stream 2TX;

MCS8~MCS15: 2 Stream 2TX;

For IEEE802.11ac 20MHz,

Nss1 MCS0~Nss1 MCS8: 1 Stream 1TX, 1 Stream 2TX;

Nss2 MCS0~Nss2 MCS9: 2 Stream 2TX;

For IEEE802.11ac 40/80MHz,

Nss1 MCS0~Nss1 MCS9: 1 Stream 1TX, 1 Stream 2TX;

Nss2 MCS0~Nss2 MCS9: 2 Stream 2TX;

For IEEE802.11ax 20/40/80MHz,

Nss1 MCS0~Nss1 MCS11: 1 Stream 1TX, 1 Stream 2TX;

Nss2 MCS0~Nss2 MCS11: 2 Stream 2TX;

<For 5470~5725MHz>

Transmit Operating Mode					Transmit Multiple Antennas					
■	Operating mode 1 (single antenna)				■	1TX				
■	Operating mode 2 (multiple antenna, no beam forming)				■	2TX	■	3TX	■	4TX
■	Operating mode 3 (multiple antenna, with beam forming)				■	2TX	■	3TX	■	4TX
■	802.11a	Operating mode	■	1TX	■	2TX	■	3TX	■	4TX
■	802.11n(20MHz)	Operating mode	■	1TX	■	2TX	■	3TX	■	4TX
■	802.11n(40MHz)	Operating mode	■	1TX	■	2TX	■	3TX	■	4TX
■	802.11ac(20MHz)	Operating mode	■	1TX	■	2TX	■	3TX	■	4TX
■	802.11ac(40MHz)	Operating mode	■	1TX	■	2TX	■	3TX	■	4TX
■	802.11ac(80MHz)	Operating mode	■	1TX	■	2TX	■	3TX	■	4TX
■	802.11ac(160MHz)	Operating mode	■	1TX	■	2TX	■	3TX	■	4TX
■	802.11ax(20MHz)	Operating mode	■	1TX	■	2TX	■	3TX	■	4TX
■	802.11ax(40MHz)	Operating mode	■	1TX	■	2TX	■	3TX	■	4TX
■	802.11ax(80MHz)	Operating mode	■	1TX	■	2TX	■	3TX	■	4TX
■	802.11ax(160MHz)	Operating mode	■	1TX	■	2TX	■	3TX	■	4TX

For IEEE802.11a,

6Mbps~54Mbps: 1TX; 2TX; 3TX; 4TX

For IEEE802.11n,

MCS0~MCS7: 1 Stream 1TX, 1 Stream 2TX, 1 Stream 3TX, 1 Stream 4TX;

MCS8~MCS15: 2 Stream 2TX, 2 Stream 3TX, 2 Stream 4TX;

MCS16~MCS23: 3 Stream 3TX, 3 Stream 4TX;

MCS24~MCS31: 4 Stream 4TX.

For IEEE802.11ac 20MHz,

Nss1 MCS0~Nss1 MCS8: 1 Stream 1TX, 1 Stream 2TX, 1 Stream 3TX, 1 Stream 4TX;

Nss2 MCS0~Nss2 MCS9: 2 Stream 2TX, 2 Stream 3TX, 2 Stream 4TX;

Nss3 MCS0~Nss3 MCS9: 3 Stream 3TX, 3 Stream 4TX;

Nss4 MCS0~Nss4 MCS9: 4 Stream 4TX.

For IEEE802.11ac 40/80/160MHz,

Nss1 MCS0~Nss1 MCS9: 1 Stream 1TX, 1 Stream 2TX, 1 Stream 3TX, 1 Stream 4TX;

Nss2 MCS0~Nss2 MCS9: 2 Stream 2TX, 2 Stream 3TX, 2 Stream 4TX;

Nss3 MCS0~Nss3 MCS9: 3 Stream 3TX, 3 Stream 4TX;

Nss4 MCS0~Nss4 MCS9: 4 Stream 4TX.

For IEEE802.11ax 20/40/80/160MHz,

Nss1 MCS0~Nss1 MCS11: 1 Stream 1TX, 1 Stream 2TX, 1 Stream 3TX, 1 Stream 4TX;

Nss2 MCS0~Nss2 MCS11: 2 Stream 2TX, 2 Stream 3TX, 2 Stream 4TX;

Nss3 MCS0~Nss3 MCS11: 3 Stream 3TX, 3 Stream 4TX;

Nss4 MCS0~Nss4 MCS11: 4 Stream 4TX.

1.10 Antenna Requirement

Except for special regulations, the Low-power Radio-frequency Devices must not be equipped with any jacket for installing an antenna with extension cable. An intentional radiator shall be designed to ensure that no antenna other than that furnished by the responsible party shall be used with the device. The use of a permanently attached antenna or of an antenna that uses a unique coupling to the intentional radiator shall be considered sufficient to comply with the provisions of this Section. The manufacturer may design the unit so that the user can replace a broken antenna, but the use of a standard antenna jack or electrical connector is prohibited. Further, this requirement does not apply to intentional radiators that must be professionally installed.

1.11 Table for Filed Antenna

Ant.	Brand	Model Name	Antenna Type	Connector	Support	Cable Length
5GHz-Ant. 1	WALSIN	RFPCA291205IMLB303	PCB Antenna	I-PEX	5150~5250MHz	50mm
5GHz-Ant. 2	WALSIN	RFPCA291203IMLB302	PCB Antenna	I-PEX	5150~5250MHz	30mm
5GHz-Ant. 3	WALSIN	RFPCA160905IM5B302	PCB Antenna	I-PEX	5725~5850MHz	55mm
5GHz-Ant. 4	WALSIN	RFPCA160906IM5B303	PCB Antenna	I-PEX	5725~5850MHz	65mm
5GHz-Ant. 5	SUNRISE	02081S4-001	Metal Antenna	N/A	5725~5850MHz	-
5GHz-Ant. 6	WALSIN	RFPCA160904IM5B303	PCB Antenna	I-PEX	5725~5850MHz	40mm

Antenna Photo:

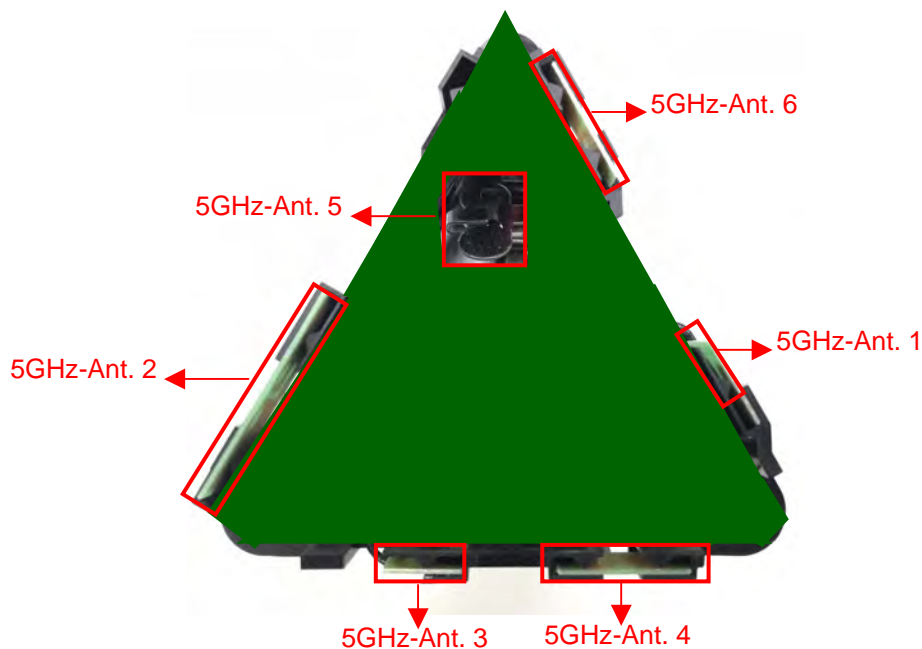



Number of Transmitter Antennas & Bandwidth

<For 5250~5350MHz>

Number of Transmitter Antennas	1TX			2TX		
	20 MHz	40 MHz	80 MHz	20 MHz	40 MHz	80 MHz
802.11a	V	X	X	V	X	X
802.11n	V	V	X	V	V	X
802.11ac	V	V	V	V	V	V
802.11ax	V	V	V	V	V	V

<For 5470~5725MHz>

Number of Transmitter Antennas	1TX				2TX				3TX				4TX			
	20 MHz	40 MHz	80 MHz	160 MHz	20 MHz	40 MHz	80 MHz	160 MHz	20 MHz	40 MHz	80 MHz	160 MHz	20 MHz	40 MHz	80 MHz	160 MHz
802.11a	V	X	X	X	V	X	X	X	V	X	X	X	V	X	X	X
802.11n	V	V	X	X	V	V	X	X	V	V	X	X	V	V	X	X
802.11ac	V	V	V	V	V	V	V	V	V	V	V	V	V	V	V	V
802.11ax	V	V	V	V	V	V	V	V	V	V	V	V	V	V	V	V



Frequency	Maximum Gain (dBi) for CDD mode					
	CDD mode (1 Stream 2 TX) for Power Gain (KDB 662911 Option 1)			CDD mode (1 Stream 2 TX) for PSD Gain (KDB 662911 Option 2)		
	20 MHz	40 MHz	80MHz	20 MHz	40 MHz	80MHz
5260MHz	4.61	-	-	5.79	-	-
5270MHz	-	4.67	-	-	5.73	-
5290MHz	-	-	4.73	-	-	5.80
5300MHz	4.70	-	-	5.81	-	-
5310MHz	-	4.68	-	-	5.72	-
5320MHz	4.62	-	-	5.58	-	-

Frequency	Maximum Gain (dBi) for CDD mode							
	CDD mode (1 Stream 4 TX) for Power Gain (KDB 662911 Option 1)				CDD mode (1 Stream 4 TX) for PSD Gain (KDB 662911 Option 2)			
	20 MHz	40 MHz	80MHz	160MHz	20 MHz	40 MHz	80MHz	160MHz
5500MHz	3.58	-	-	-	6.69	-	-	-
5510MHz	-	3.50	-	-	-	6.67	-	-
5530MHz	-	-	3.73	-	-	-	6.91	-
5550MHz	-	3.88	-	-	-	6.88	-	-
5570MHz	-	-	-	3.88	-	-	-	6.75
5580MHz	3.79	-	-	-	6.66	-	-	-
5610MHz	-	-	3.72	-	-	-	6.59	-
5670MHz	-	4.16	-	-	-	6.77	-	-
5690MHz	-	-	4.23	-	-	-	6.67	-
5700MHz	4.38	-	-	-	6.71	-	-	-
5710MHz	-	4.58	-	-	-	6.80	-	-
5720MHz	4.74	-	-	-	6.85	-	-	-



Frequency	Maximum Gain (dBi) for TXBF mode		
	TXBF mode (1 Stream 2 TX) for Power Gain and PSD Gain (KDB 662911 Option 2)		
	20 MHz	40 MHz	80MHz
5260MHz	5.79	-	-
5270MHz	-	5.73	-
5290MHz	-	-	5.80
5300MHz	5.81	-	-
5310MHz	-	5.72	-
5320MHz	5.58	-	-

Frequency	Maximum Gain (dBi) for TXBF mode			
	TXBF mode (1 Stream 4 TX) for Power Gain and PSD Gain (KDB 662911 Option 2)			
	20 MHz	40 MHz	80MHz	160MHz
5500MHz	6.69	-	-	-
5510MHz	-	6.67	-	-
5530MHz	-	-	6.91	-
5550MHz	-	6.88	-	-
5570MHz	-	-	-	6.75
5580MHz	6.66	-	-	-
5610MHz	-	-	6.59	-
5670MHz	-	6.77	-	-
5690MHz	-	-	6.67	-
5700MHz	6.71	-	-	-
5710MHz	-	6.80	-	-
5720MHz	6.85	-	-	-

Frequency	Maximum Gain (dBi) for TXBF mode			
	TXBF mode (2 Stream 4 TX) for Power Gain and PSD Gain (KDB 662911 Option 2)			
	20 MHz	40 MHz	80MHz	160MHz
5500MHz	4.96	-	-	-
5510MHz	-	4.95	-	-
5530MHz	-	-	5.20	-
5550MHz	-	5.22	-	-
5570MHz	-	-	-	5.10
5580MHz	5.01	-	-	-
5610MHz	-	-	4.91	-
5670MHz	-	5.01	-	-
5690MHz	-	-	4.96	-
5700MHz	5.01	-	-	-
5710MHz	-	5.08	-	-
5720MHz	5.17	-	-	-



Frequency	Maximum Gain (dBi) for TXBF mode			
	TXBF mode (3 Stream 4 TX) for Power Gain and PSD Gain (KDB 662911 Option 2)			
	20 MHz	40 MHz	80MHz	160MHz
5500MHz	3.04	-	-	-
5510MHz	-	3.03	-	-
5530MHz	-	-	3.33	-
5550MHz	-	3.31	-	-
5570MHz	-	-	-	3.26
5580MHz	3.22	-	-	-
5610MHz	-	-	3.00	-
5670MHz	-	3.15	-	-
5690MHz	-	-	3.06	-
5700MHz	3.12	-	-	-
5710MHz	-	3.20	-	-
5720MHz	3.33	-	-	-

Note:

1. Antenna Gain refer to “OWA3111_NAM_Directional_Gain_20200120” files

2. Maximum Correlated Directional Gain = $Directional\ Gain = 10 \cdot \log \left[\frac{\sum_{j=1}^{N_{SI}} \left\{ \sum_{k=1}^{N_{ANT}} g_{j,k} \right\}^2}{N_{ANT}} \right]$

3. Maximum Uncorrelated Directional Gain = $Directional\ Gain = 10 \cdot \log \left[\frac{\sum_{j=1}^{N_{SI}} \left\{ \sum_{k=1}^{N_{ANT}} g_{j,k} \right\}^2}{N_{ANT}} \right]$

1.12 Table for Carrier Frequencies

16 channels are provided for 802.11a / 802.11n / 802.11ac / 802.11ax (20MHz):

Frequency Band	Channel No.	Frequency	Channel No.	Frequency
5250~5350MHz	52	5260 MHz	60	5300 MHz
	56	5280 MHz	64	5320 MHz
5470~5725MHz	100	5500 MHz	124	5620 MHz
	104	5520 MHz	128	5640 MHz
	108	5540 MHz	132	5660 MHz
	112	5560 MHz	136	5680 MHz
	116	5580 MHz	140	5700 MHz
	120	5600 MHz	144	5720 MHz

8 channels are provided for 802.11n / 802.11ac / 802.11ax (40MHz):

Frequency Band	Channel No.	Frequency	Channel No.	Frequency
5250~5350MHz	54	5270 MHz	62	5310 MHz
5470~5725MHz	102	5510 MHz	126	5630 MHz
	110	5550 MHz	134	5670 MHz
	118	5590 MHz	142	5710 MHz

4 channels are provided for 802.11ac / 802.11ax (80MHz):

Frequency Band	Channel No.	Frequency	Channel No.	Frequency
5250~5350MHz	58	5290 MHz	-	-
5470~5725MHz	106	5530 MHz	138	5690 MHz
	122	5610 MHz	-	-

1 channel is provided for 802.11ac / 802.11ax (160MHz):

Frequency Band	Channel No.	Frequency	Channel No.	Frequency
5470~5725MHz	114	5570 MHz	-	-



1.13 Table for Master Test Modes

Investigation has been done on all the possible configurations for searching the worst cases. The following table is a list of the test modes shown in this test report.

<AP mode>

Test Items	Mode	Note	Channel	Data Rate	Ant.	
UNII Detection Bandwidth Measurement and Statistical Performance Check (Radiated)	802.11ax(20MHz)	U-NII-2A /BPSK	60	Nss1MCS0	1+2	
	802.11ax(40MHz)		62	Nss1MCS0	1+2	
	802.11ax(80MHz)		58	Nss1MCS0	1+2	
	Channel Availability Check Time (Radiated)	802.11ax(20MHz)	U-NII-2C /BPSK	100	Nss1MCS0	1+2+3+4
		802.11ax(40MHz)		102	Nss1MCS0	1+2+3+4
		802.11ax(80MHz)		106	Nss1MCS0	1+2+3+4
		802.11ax(160MHz)		114	Nss1MCS0	1+2+3+4
Channel Move Time and Channel Closing Transmission Time (Radiated)	802.11ax(80MHz)	U-NII-2A /BPSK	58	Nss1MCS0	1+2	
	802.11ax(160MHz)	U-NII-2C /BPSK	114	Nss1MCS0	1+2+3+4	
Non-Occupancy Period (Radiated)	802.11ax(80MHz)	U-NII-2A /BPSK	58	Nss1MCS0	1+2	
	802.11ax(160MHz)	U-NII-2C /BPSK	114	Nss1MCS0	1+2+3+4	

<Extender mode>

Test Items	Mode	Note	Channel	Data Rate	Ant.
UNII Detection Bandwidth Measurement and Statistical Performance Check (Radiated)	802.11ax(80MHz)	U-NII-2A /BPSK	58	Nss1MCS0	1+2
	802.11ax(160MHz)	U-NII-2C /BPSK	114	Nss1MCS0	1+2+3+4

Note: Test mode refer to "FCC KDB 905462 D02 UNII DFS Compliance Procedures New Rules v02", Table 2 04/08/2016.



1.14 List of measurements for Master mode

AP mode

<For 5250~5350MHz>

Nominal Channel Bandwidth 802.11ax(20MHz) / CH60

<input checked="" type="checkbox"/>	EIRP ≥ 200 mW, DFS Detection Threshold =-64dBm	
<input type="checkbox"/>	EIRP < 200mW and PSD < 10 dBm/MHz, DFS Detection Threshold =-62dBm	
<input type="checkbox"/>	EIRP < 200mW, that do not meet the PSD requirement, DFS Detection Threshold =-64dBm	
Parameter	Test Value	Test Result
U-NII Detection Bandwidth (Minimum 100% of the U-NII 99% transmission power bandwidth)	Type 0 Radar Detection >90%	Complied
Statistical Performance Check (In-Service Monitoring)	30 time Type1~4 & 5 Radar Detection >80% Type 6 Radar Detection >70%	Complied
Security features	country code, frequency range, modulation type, maximum output power can not be changed by unauthorized parties	

Nominal Channel Bandwidth 802.11ax(40MHz) / CH62

<input checked="" type="checkbox"/>	EIRP ≥ 200 mW, DFS Detection Threshold =-64dBm	
<input type="checkbox"/>	EIRP < 200mW and PSD < 10 dBm/MHz, DFS Detection Threshold =-62dBm	
<input type="checkbox"/>	EIRP < 200mW, that do not meet the PSD requirement, DFS Detection Threshold =-64dBm	
Parameter	Test Value	Test Result
U-NII Detection Bandwidth (Minimum 100% of the U-NII 99% transmission power bandwidth)	Type 0 Radar Detection >90%	Complied
Statistical Performance Check (In-Service Monitoring)	30 time Type1~4 & 5 Radar Detection >80% Type 6 Radar Detection >70%	Complied
Security features	country code, frequency range, modulation type, maximum output power can not be changed by unauthorized parties	



Nominal Channel Bandwidth 802.11ax(80MHz) / CH58

<input checked="" type="checkbox"/>	EIRP \geq 200 mW, DFS Detection Threshold =-64dBm	
<input type="checkbox"/>	EIRP < 200mW and PSD < 10 dBm/MHz, DFS Detection Threshold =-62dBm	
<input type="checkbox"/>	EIRP < 200mW, that do not meet the PSD requirement, DFS Detection Threshold =-64dBm	
Parameter	Test Value	Test Result
U-NII Detection Bandwidth (Minimum 100% of the U-NII 99% transmission power bandwidth)	Type 0 Radar Detection >90%	Complied
Statistical Performance Check (In-Service Monitoring)	30 time Type1~4 & 5 Radar Detection >80% Type 6 Radar Detection >70%	Complied
Channel Move Time	Type 0 < 10s	Complied
Channel Closing Transmission Time	Type 0 < 260ms	Complied
Non-Occupancy Period	Type 0 \geq 30 min	Complied
Security features	country code, frequency range, modulation type, maximum output power can not be changed by unauthorized parties	



<For 5470~5725MHz>

Nominal Channel Bandwidth 802.11ax(20MHz) / CH100

<input checked="" type="checkbox"/>	EIRP ≥ 200 mW, DFS Detection Threshold =-64dBm	
<input type="checkbox"/>	EIRP < 200mW and PSD < 10 dBm/MHz, DFS Detection Threshold =-62dBm	
<input type="checkbox"/>	EIRP < 200mW, that do not meet the PSD requirement, DFS Detection Threshold =-64dBm	
Parameter	Test Value	Test Result
U-NII Detection Bandwidth (Minimum 100% of the U-NII 99% transmission power bandwidth)	Type 0 Radar Detection >90%	Complied
Statistical Performance Check (In-Service Monitoring)	30 time Type1~4 & 5 Radar Detection >80% Type 6 Radar Detection >70%	Complied
Security features	country code, frequency range, modulation type, maximum output power can not be changed by unauthorized parties	

Nominal Channel Bandwidth 802.11ax(40MHz) / CH102

<input checked="" type="checkbox"/>	EIRP ≥ 200 mW, DFS Detection Threshold =-64dBm	
<input type="checkbox"/>	EIRP < 200mW and PSD < 10 dBm/MHz, DFS Detection Threshold =-62dBm	
<input type="checkbox"/>	EIRP < 200mW, that do not meet the PSD requirement, DFS Detection Threshold =-64dBm	
Parameter	Test Value	Test Result
U-NII Detection Bandwidth (Minimum 100% of the U-NII 99% transmission power bandwidth)	Type 0 Radar Detection >90%	Complied
Statistical Performance Check (In-Service Monitoring)	30 time Type1~4 & 5 Radar Detection >80% Type 6 Radar Detection >70%	Complied
Security features	country code, frequency range, modulation type, maximum output power can not be changed by unauthorized parties	



Nominal Channel Bandwidth 802.11ax(80MHz) / CH106

<input checked="" type="checkbox"/>	EIRP ≥ 200 mW, DFS Detection Threshold =-64dBm	
<input type="checkbox"/>	EIRP < 200mW and PSD < 10 dBm/MHz, DFS Detection Threshold =-62dBm	
<input type="checkbox"/>	EIRP < 200mW, that do not meet the PSD requirement, DFS Detection Threshold =-64dBm	
Parameter	Test Value	Test Result
U-NII Detection Bandwidth (Minimum 100% of the U-NII 99% transmission power bandwidth)	Type 0 Radar Detection >90%	Complied
Statistical Performance Check (In-Service Monitoring)	30 time Type1~4 & 5 Radar Detection >80% Type 6 Radar Detection >70%	Complied
Security features	country code, frequency range, modulation type, maximum output power can not be changed by unauthorized parties	

Nominal Channel Bandwidth 802.11ax(160MHz) / CH114

<input checked="" type="checkbox"/>	EIRP ≥ 200 mW, DFS Detection Threshold =-64dBm	
<input type="checkbox"/>	EIRP < 200mW and PSD < 10 dBm/MHz, DFS Detection Threshold =-62dBm	
<input type="checkbox"/>	EIRP < 200mW, that do not meet the PSD requirement, DFS Detection Threshold =-64dBm	
Parameter	Test Value	Test Result
U-NII Detection Bandwidth (Minimum 100% of the U-NII 99% transmission power bandwidth)	Type 0 Radar Detection >90%	Complied
Statistical Performance Check (In-Service Monitoring)	30 time Type1~4 & 5 Radar Detection >80% Type 6 Radar Detection >70%	Complied
Channel Move Time	Type 0 < 10s	Complied
Channel Closing Transmission Time	Type 0 < 260ms	Complied
Non-Occupancy Period	Type 0 ≥ 30 min	Complied
Security features	country code, frequency range, modulation type, maximum output power can not be changed by unauthorized parties	



Extender mode

Nominal Channel Bandwidth 802.11ax(160MHz) / CH114

<input checked="" type="checkbox"/>	EIRP ≥ 200 mW, DFS Detection Threshold =-64dBm	
<input type="checkbox"/>	EIRP < 200mW and PSD < 10 dBm/MHz, DFS Detection Threshold =-62dBm	
<input type="checkbox"/>	EIRP < 200mW, that do not meet the PSD requirement, DFS Detection Threshold =-64dBm	
Parameter	Test Value	Test Result
U-NII Detection Bandwidth (Minimum 100% of the U-NII 99% transmission power bandwidth)	Type 0 Radar Detection >90%	Complied
Statistical Performance Check (In-Service Monitoring)	30 time Type1~4 & 5 Radar Detection >80% Type 6 Radar Detection >70% (Only test one radar types)	Complied
Security features	country code, frequency range, modulation type, maximum output power can not be changed by unauthorized parties	



1.15 Support Equipment

AP Mode

Support Equipment				
No.	Equipment	Brand Name	Model Name	FCC ID
A	Notebook	DELL	E4300	N/A
B	Notebook	DELL	E4300	N/A
C	WLAN module	Intel	AX200NGW	PD9AX200NG

Extender Mode

Support Equipment				
No.	Equipment	Brand Name	Model Name	FCC ID
A	Notebook	DELL	E4300	N/A
B	Notebook	DELL	E4300	N/A
C	Notebook	DELL	E4300	N/A
D	WLAN AP	Technicolor	FGA5330	RSE-FGA5330
E	WLAN module	Intel	AX200NGW	PD9AX200NG

1.16 Testing Location Information

Testing Location Information	
Test Lab. : Sporton International Inc. Hsinchu Laboratory	
Hsinchu (TAF: 3787)	ADD: No.8, Ln. 724, Bo'ai St., Zhubei City, Hsinchu County 302010, Taiwan (R.O.C.) TEL: 886-3-656-9065 FAX: 886-3-656-9085 Test site Designation No. TW3787 with FCC. Conformity Assessment Body Identifier (CABID) TW3787 with ISED.

Test Condition	Test Site No.	Test Engineer	Test Environment (°C / %)	Test Date
DFS	DF01-CB	Mason Chen	22.8-24.7 / 55-60	Mar. 05, 2021~ Mar. 15, 2021



2 Dynamic Frequency Selection (DFS) Test Result

2.1 General DFS Information

U-NII devices operating in the 5.25-5.35 GHz band and the 5.47-5.725 GHz band shall employ a TPC mechanism. The U-NII device is required to have the capability to operate at least 6 dB below the mean EIRP value of 30 dBm. A TPC mechanism is not required for systems with an e.i.r.p. of less than 500 mW.

U-NII devices operating in the 5.25-5.35 GHz and 5.47-5.725 GHz bands shall employ a DFS radar detection mechanism to detect the presence of radar systems and to avoid co-channel operation with radar systems.

Master Device Requirements:

- (1) Before initiating a network on a channel, which has not been identified as an Available Channel, the master device shall perform a Channel Availability Check to ensure that there is no radar operating on the channel.
- (2) During normal operation, the master device shall monitor the Operating Channel (In-Service Monitoring) to ensure that there is no radar operating on the channel. When the master device has detected a radar signal during In-Service Monitoring, the Operating Channel is made unavailable. The master device shall instruct all its associated slave devices to stop transmitting on this (to become unavailable) channel.
- (3) The master device shall not resume any transmissions on this Unavailable Channel during a period of time after a radar signal was detected. This period is referred as the Non-Occupancy Period.

Table 1: Applicability of DFS requirements Prior to Use a Channel

Requirement	DFS Operational mode		
	Master	Client without radar detection	Client with radar detection
Non-Occupancy Period	V	Not required	V
DFS Detection Threshold	V	Not required	V
Channel Availability Check Time	V	Not required	Not required
U-NII Detection Bandwidth	V	Not required	V



Table 2: Applicability of DFS requirements during normal operation.

Requirement	DFS Operational mode	
	Master Device or Client with radar detection	Client without radar detection
DFS Detection Threshold	V	Not required
Channel Closing Transmission Time	V	V
Channel Move Time	V	V
U-NII Detection Bandwidth	V	Not required

Additional requirements for devices with multiple bandwidth modes	Master Device or Client with Radar Detection	Client Without Radar Detection
U-NII Detection Bandwidth and Statistical Performance Check	All BW modes must be tested	Not required
Channel Move Time and Channel Closing Transmission Time	Test using widest BW mode available	Test using the widest BW mode available for the link
All other tests	Any single BW mode	Not required

Note: Frequencies selected for statistical performance check (Section 7.8.4) should include several frequencies within the radar detection bandwidth and frequencies near the edge of the radar detection bandwidth. For 802.11 devices it is suggested to select frequencies in each of the bonded 20 MHz channels and the channel center frequency.

2.1.1 User Access Restrictions

User Access Restrictions
<input checked="" type="checkbox"/> DFS controls (hardware or software) related to radar detection are NOT accessible to the user. Manufacturer statement confirming that information regarding the parameters of the detected Radar Waveforms is not available to the end user.



2.2 Test limits and radar signal parameters

2.2.1 Detection threshold values

Table 3: DFS detection thresholds for master and client devices with radar detection

Maximum Transmit Power	Value (see note)
EIRP ≥ 200 milliwatt	-64 dBm
EIRP < 200 milliwatt and power spectral density < 10 dBm/MHz	-62 dBm
EIRP < 200 milliwatt, that do not meet the power spectral density requirement	-64 dBm

Note 1: This is the level at the input of the receiver assuming a 0 dBi receive antenna.
 Note 2: Throughout these test procedures an additional 1 dB has been added to the amplitude of the test transmission waveforms to account for variations in measurement equipment. This will ensure that the test signal is at or above the detection threshold level to trigger a DFS response.
 Note 3: EIRP is based on the highest antenna gain. For MIMO devices refer to KDB Publication 662911D01.

Table 4: DFS response requirement values

Table D.1: DFS requirement values	
Parameter	Value
Non-occupancy period	Minimum 30 minutes
Channel Availability Check Time	60 seconds
Channel Move Time	10 seconds (Note 1).
Channel Closing Transmission Time	200 milliseconds + an aggregate of 60 milliseconds over remaining 10 second periods. (Notes 1 and 2).
U-NII Detection Bandwidth	Minimum 100% of the 99% power bandwidth (Note 3).

Note 1: Channel Move Time and the Channel Closing Transmission Time should be performed with Radar Type 0. The measurement timing begins at the end of the Radar Type 0 burst.
 Note 2: The Channel Closing Transmission Time is comprised of 200 milliseconds starting at the beginning of the Channel Move Time plus any additional intermittent control signals required to facilitate Channel changes (an aggregate of 60 milliseconds) during the remainder of the 10 second period. The aggregate duration of control signals will not count quiet periods in between transmissions.
 Note 3: During the U-NII Detection Bandwidth detection test, radar type 0 is used and for each frequency step the minimum percentage of detection is 90%. Measurements are performed with no data traffic.



2.2.2 Radar Test Waveforms Minimum Step

Step intervals of 0.1 microsecond for Pulse Width, 1 microsecond for PRI, 1 MHz for chirp width and 1 for the number of pulses will be utilized for the random determination of specific test waveforms.

2.2.3 Short Pulse Radar Test Waveforms (Type 1~4)

Step intervals of 0.1 microsecond for Pulse Width, 1 microsecond for PRI, 1 MHz for chirp width and 1 for the number of pulses will be utilized for the random determination of specific test waveforms.

Table 5: Short pulse radar test waveforms

Radar Type	Pulse Width (μsec)	PRI (μsec)	Number of Pulses	Minimum Percentage of Successful Detection	Minimum Trials
0	1	1428	18	See Note 1	See Note 1
1	1	Test A: 15 unique PRI values randomly selected from the list of 23 PRI values in Table 5a	$\text{Roundup}\left\{\left(\frac{1}{360}\right) \times \left(\frac{19 \times 10^6}{PRI}\right)\right\}$	60%	30
		Test B: 15 unique PRI values randomly selected within the range of 518-3066 μsec, with a minimum increment of 1 μsec, excluding PRI values selected in Test A			
2	1-5	150-230	23-29	60%	30
3	6-10	200-500	16-18	60%	30
4	11-20	200-500	12-16	60%	30
Aggregate (Radar Types 1-4)				80%	120
Note 1: Short Pulse Radar Type 0 should be used for the detection bandwidth test, channel move time, and channel closing time tests.					

A minimum of 30 unique waveforms are required for each of the Short Pulse Radar Types 2 through 4. If more than 30 waveforms are used for Short Pulse Radar Types 2 through 4, then each additional waveform must also

be unique and not repeated from the previous waveforms. If more than 30 waveforms are used for Short Pulse Radar Type 1, then each additional waveform is generated with Test B and must also be unique and not repeated from the previous waveforms in Tests A or B.

For example if in Short Pulse Radar Type 1 Test B a PRI of 3066 usec is selected, the number of pulses

$$\text{would be } \text{Roundup}\left\{\left(\frac{1}{360}\right) \cdot \left(\frac{19.10^6}{3066}\right)\right\} = \text{Roundup}\{17.2\} = 18$$

Radar Types (1~4) System Diagram

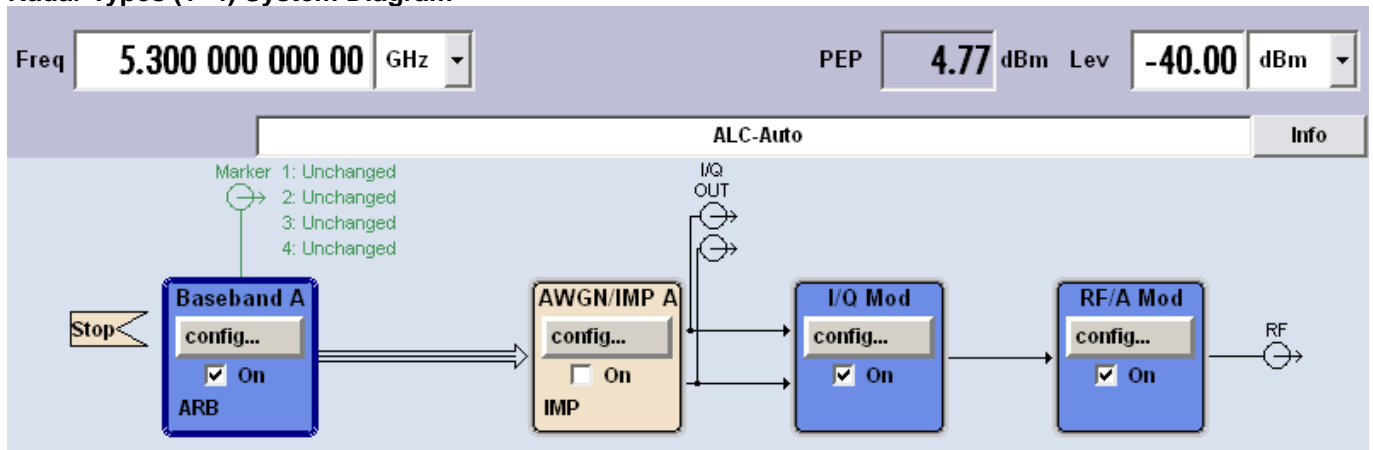

Used R&S SMU200A (Vector SG with one ARB) or SG + ARB

B11: Base-band Generator with ARB (16 M samples) and Digital Modulation

B13: Base-band Main Module

B106: frequency range (100 kHz to 6 GHz)

For selecting the waveform parameters from within the bounds of the signal type, system were random selection using uniform distribution.



2.2.4 Long Pulse Radar Test Waveform (Type 5)

Table 6: Long pulse radar test waveform

Radar Type	Pulse Width (µsec)	Chirp Width (MHz)	PRI (µsec)	Number of Pulses per Burst	Number of Bursts	Minimum Percentage of Successful Detection	Minimum Trials
5	50-100	5-20	1000-2000	1-3	8-20	80%	30

The parameters for this waveform are randomly chosen. Thirty unique waveforms are required for the Long Pulse Radar Type waveforms. If more than 30 waveforms are used for the Long Pulse Radar Type waveforms, then each additional waveform must also be unique and not repeated from the previous waveforms. Each waveform is defined as follows:

- (1) The transmission period for the Long Pulse Radar test signal is 12 seconds.
- (2) There are a total of 8 to 20 Bursts in the 12 second period, with the number of Bursts being randomly chosen. This number is Burst Count.
- (3) Each Burst consists of 1 to 3 pulses, with the number of pulses being randomly chosen. Each Burst within the 12 second sequence may have a different number of pulses.
- (4) The pulse width is between 50 and 100 microseconds, with the pulse width being randomly chosen. Each pulse within a Burst will have the same pulse width. Pulses in different Bursts may have different pulse widths.
- (5) Each pulse has a linear frequency modulated chirp between 5 and 20 MHz, with the chirp width being randomly chosen. Each pulse within a transmission period will have the same chirp width. The chirp is centered on the pulse. For example, with a radar frequency of 5300 MHz and a 20 MHz chirped signal, the chirp starts at 5290 MHz and ends at 5310 MHz.
- (6) If more than one pulse is present in a Burst, the time between the pulses will be between 1000 and 2000 microseconds, with the time being randomly chosen. If three pulses are present in a Burst, the random time interval between the first and second pulses is chosen independently of the random time interval between the second and third pulses.
- (7) The 12 second transmission period is divided into even intervals. The number of intervals is equal to Burst Count. Each interval is of length $(12,000,000 / \text{Burst Count})$ microseconds. Each interval contains one Burst. The start time for the Burst, relative to the beginning of the interval, is between 1 and $[(12,000,000 / \text{Burst Count}) - (\text{Total Burst Length}) + (\text{One Random PRI Interval})]$ microseconds, with the start time being randomly chosen. The step interval for the start time is 1 microsecond. The start time for each Burst is chosen randomly.

A representative example of a Long Pulse radar test waveform:

- (1) The total test waveform length is 12 seconds.
- (2) Eight (8) Bursts are randomly generated for the Burst Count.
- (3) Burst 1 has 2 randomly generated pulses.
- (4) The pulse width (for both pulses) is randomly selected to be 75 microseconds.
- (5) The PRI is randomly selected to be at 1213 microseconds.
- (6) Bursts 2 through 8 are generated using steps 3 – 5.
- (7) Each Burst is contained in even intervals of 1,500,000 microseconds. The starting location for Pulse 1, Burst 1 is randomly generated (1 to 1,500,000 minus the total Burst 1 length + 1 random PRI interval) at the 325,001 microsecond step. Bursts 2 through 8 randomly fall in successive 1,500,000 microsecond intervals (i.e. Burst 2 falls in the 1,500,001 – 3,000,000 microsecond range).

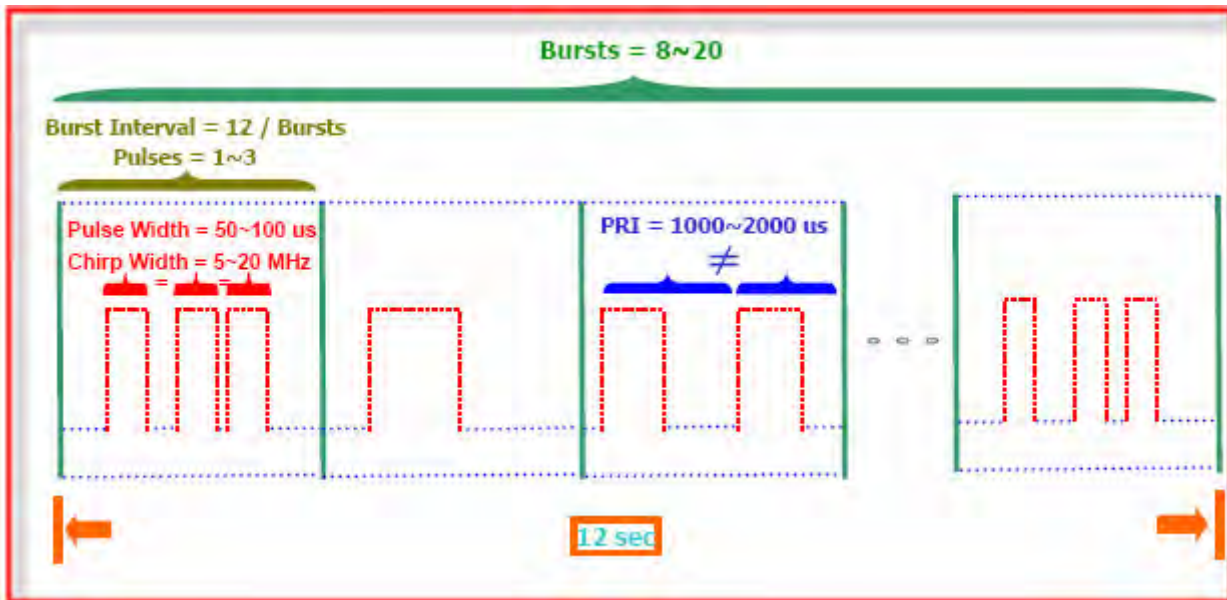

Radar Types (5) System Diagram

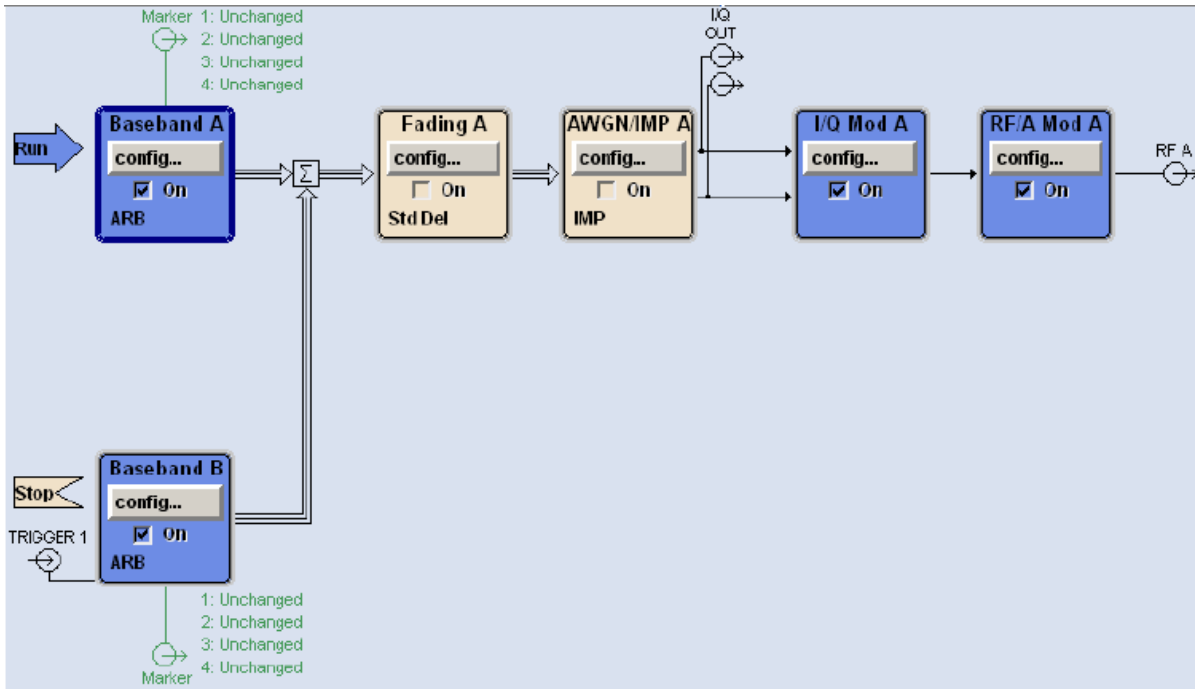

Used R&S SMU200A (Vector SG with two ARB)

Path A / Path B Two B11: Base-band Generator with ARB (16 M samples) and Digital Modulation

B13: Base-band Main Module

B106: frequency range (100 kHz to 6 GHz)

For selecting the waveform parameters from within the bounds of the signal type, system was random selection using uniform distribution.

2.2.5 Frequency Hopping Radar Test Waveform (Type 6)

Table 7: Frequency hopping radar test waveform

Radar Type	Pulse Width (µsec)	PRI (µsec)	Pulses per Hop	Hopping Rate (kHz)	Hopping Sequence Length (ms)	Minimum Percentage of Successful Detection	Minimum Trials
6	1	333	9	0.333	300	70%	30

For the Frequency Hopping Radar Type, the same Burst parameters are used for each waveform. The hopping sequence is different for each waveform and a 100-length segment is selected from the hopping sequence defined by the following algorithm:

The first frequency in a hopping sequence is selected randomly from the group of 475 integer frequencies from 5250 – 5724 MHz. Next, the frequency that was just chosen is removed from the group and a frequency is randomly selected from the remaining 474 frequencies in the group. This process continues until all 475 frequencies are chosen for the set. For selection of a random frequency, the frequencies remaining within the group are always treated as equally likely.

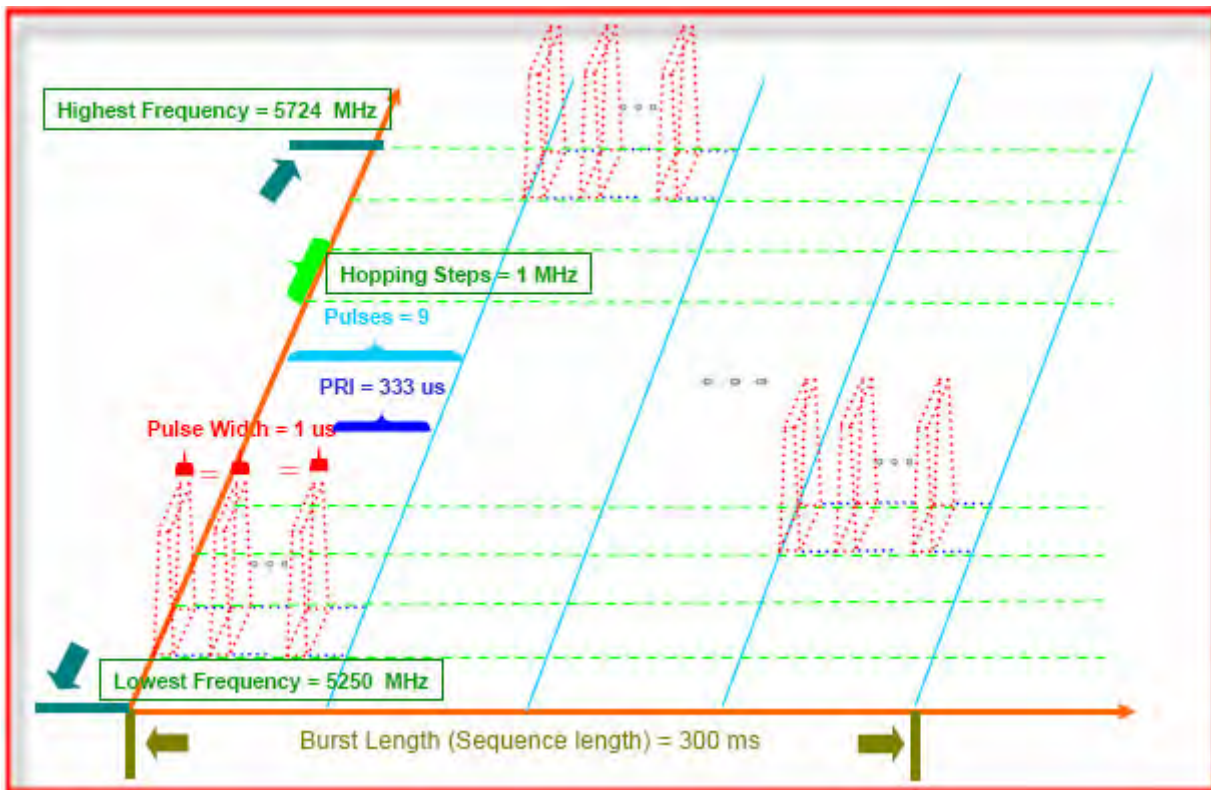

Radar Types (6) System Diagram

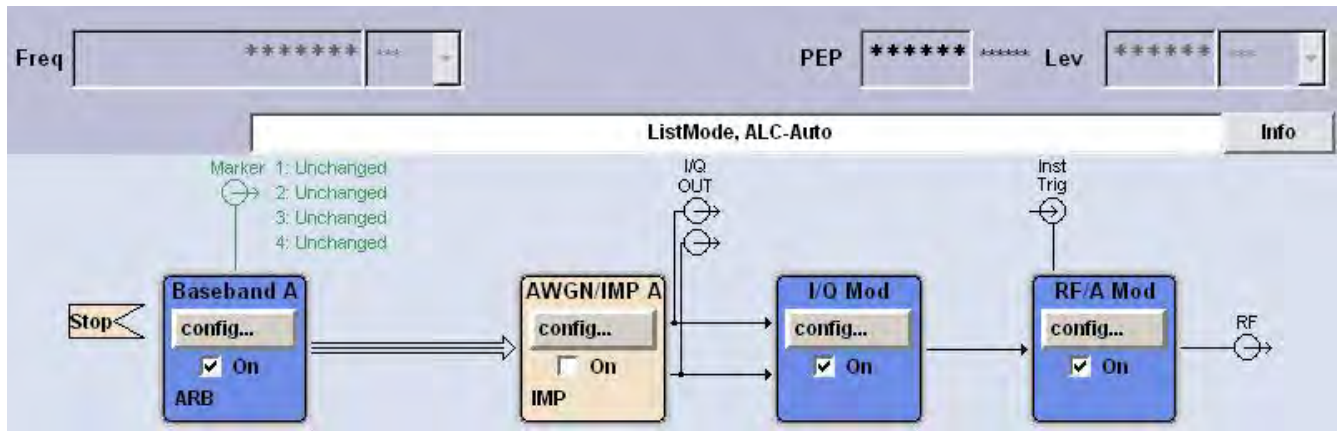

Used R&S SMU200A (Vector SG with one ARB)

B11: Base-band Generator with ARB (16 M samples) and Digital Modulation

B13: Base-band Main Module

B106: frequency range (100 kHz to 6 GHz)

For selecting the waveform parameters from within the bounds of the signal type, system were random selection using uniform distribution.

2.2.6 Measuring Instruments

Refer to a list of measuring equipment in section 3.

2.2.7 Measuring Instruments and Setting

The following table is the setting of the spectrum analyzer.

Spectrum Parameter	Setting
Attenuation	0 dB
Span Frequency	0 MHz
RBW / VBW	3 MHz
Sweep Time	More than DFS requirement values

2.2.8 DFS Radiated Test Setup Layout

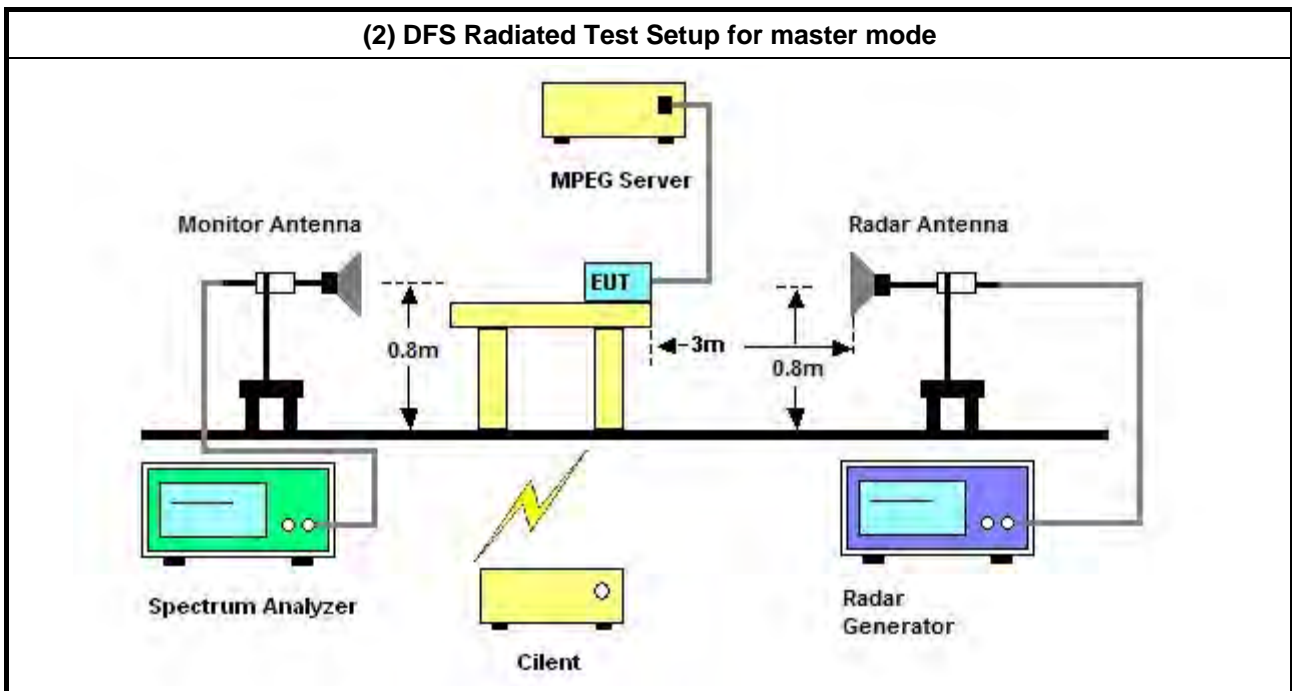
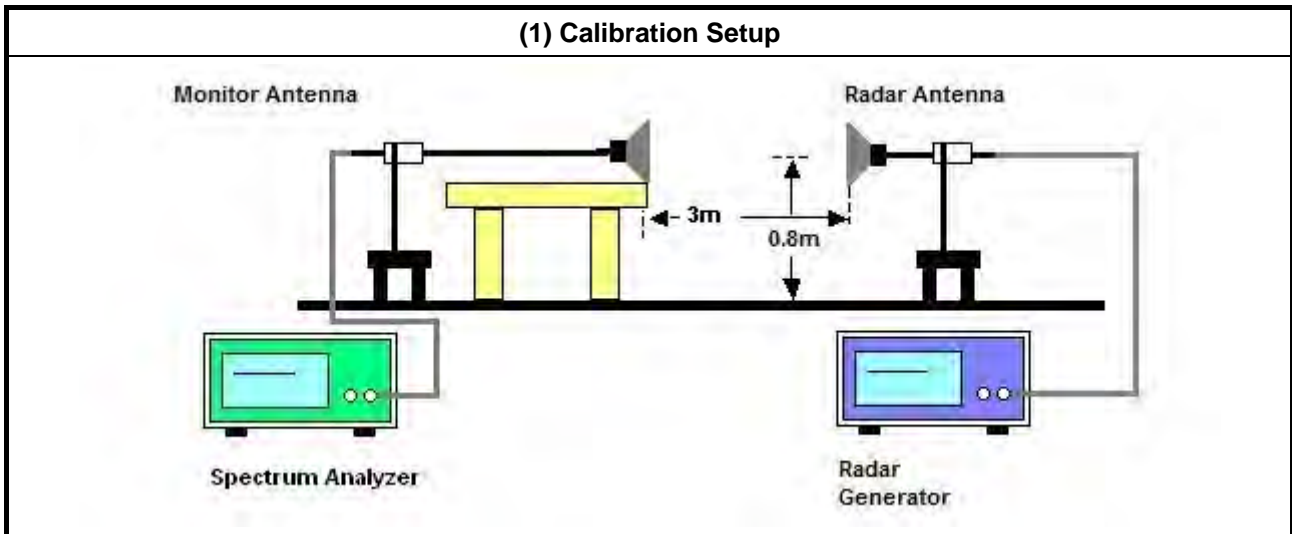

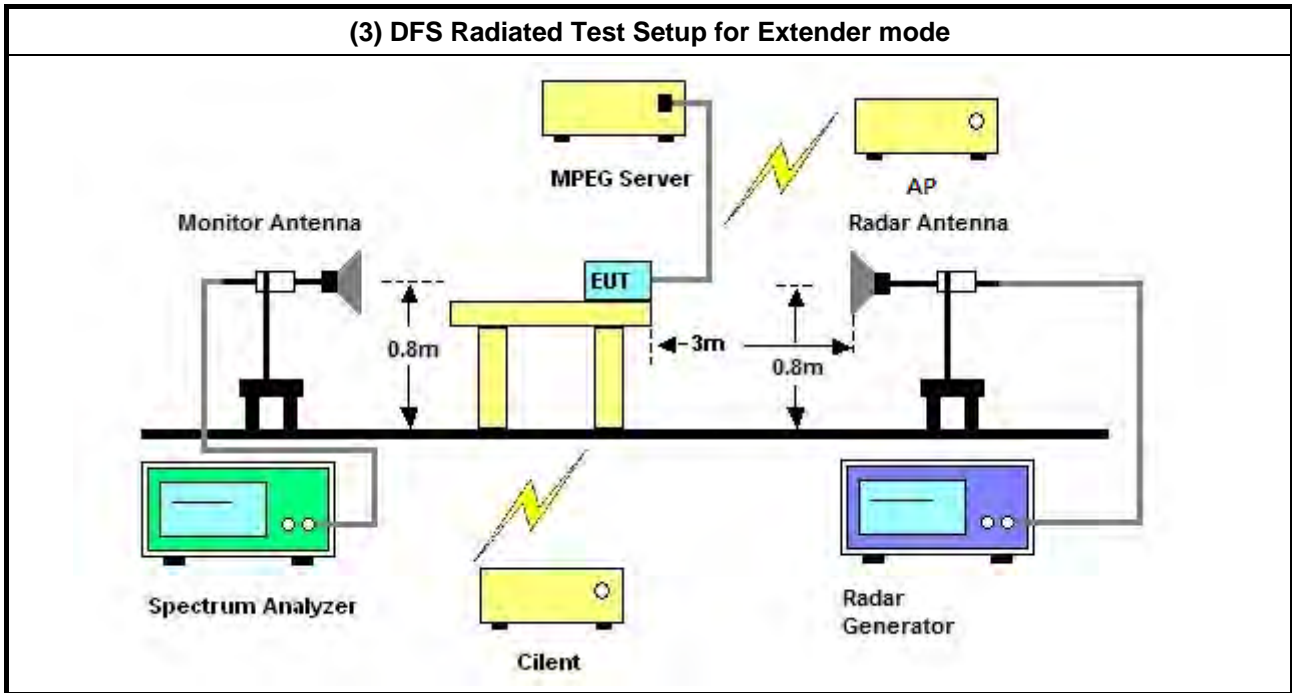



2.2.9 Radar Waveform Calibration Procedure

The Interference **Radar Detection Threshold Level** is (-63dBm), The above equipment setup was used to calibrate the radiated Radar Waveform. A vector signal generator was utilized to establish the test signal level for each radar type. During this process there were replace 50ohm terminal form Master and Client device and no transmissions by either the Master or Client Device. The spectrum analyzer was switched to the zero span (Time Domain) at the frequency of the Radar Waveform generator. Peak detection was used. The spectrum analyzer resolution bandwidth (RBW) and video bandwidth (VBW) were set to at least 3 MHz. The vector signal generator amplitude was set so that the power level measured at the spectrum analyzer was (-63dBm). Capture the spectrum analyzer plots on short pulse radar types, long pulse radar type and hopping radar waveform.

2.2.10 Calibration Deviation

There is no deviation with the original standard.



2.2.11 The Test Result of Threshold Level

Set configuration as section 2.2.8 (1) and do DFS calibration, and then adjust attenuator to make sure that the threshold value is (-63dBm) at the UUT's antenna port.

AP Mode:

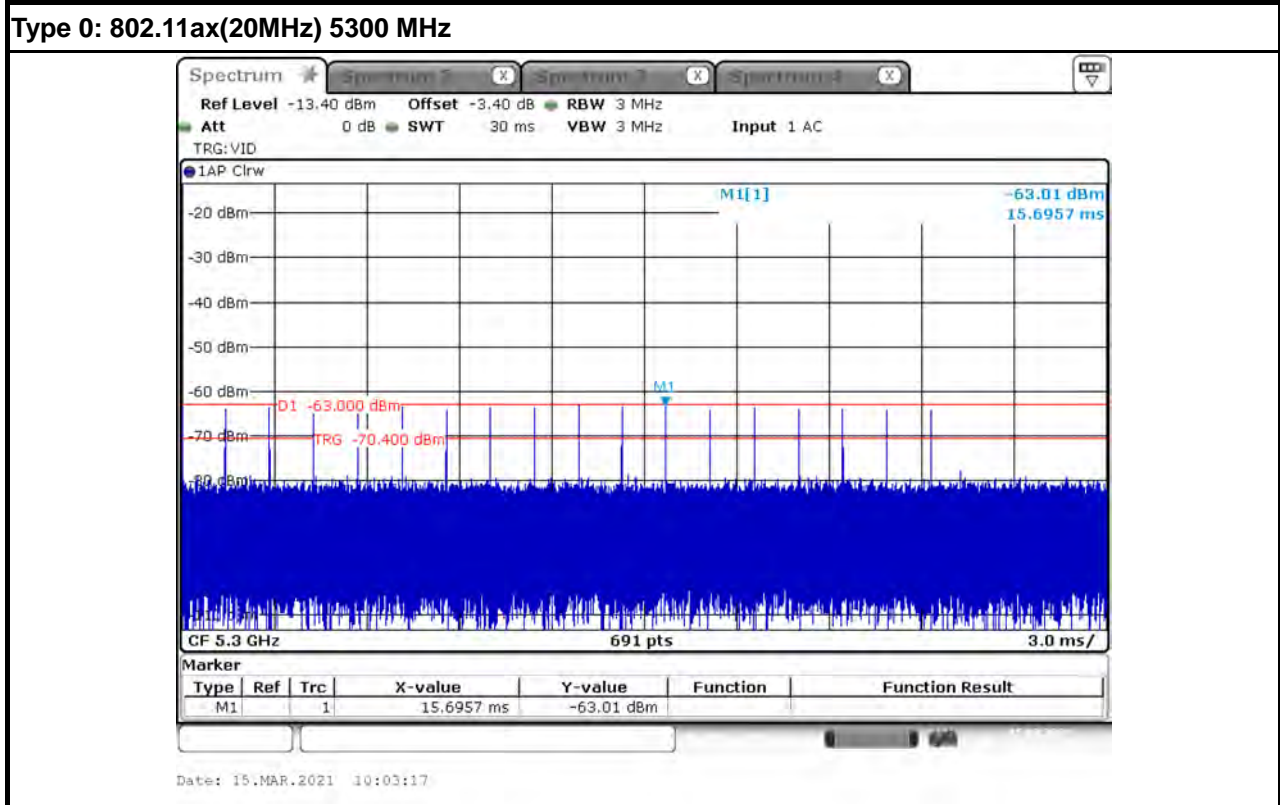



Type 1: 802.11ax(20MHz) 5300 MHz

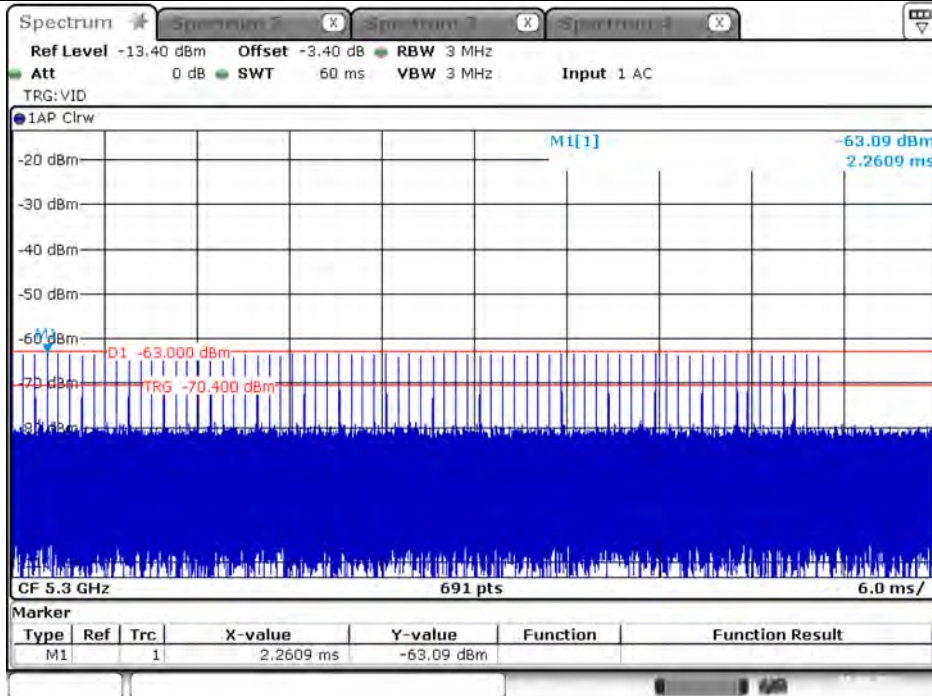

Date: 15.MAR.2021 10:06:08

Type 2: 802.11ax(20MHz) 5300 MHz

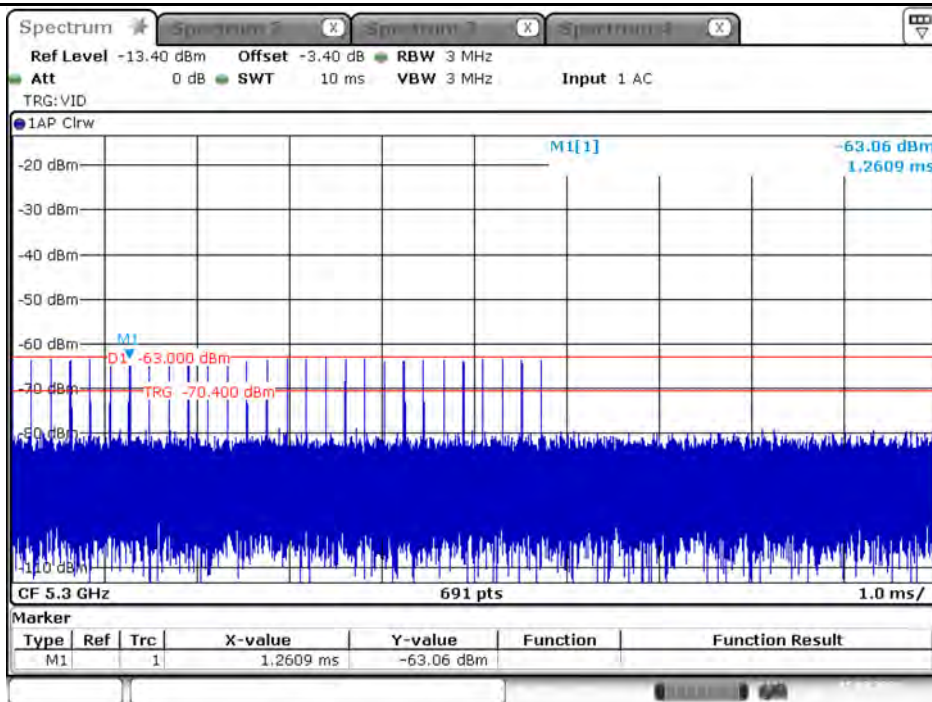

Date: 15.MAR.2021 10:11:19



Type 3: 802.11ax(20MHz) 5300 MHz

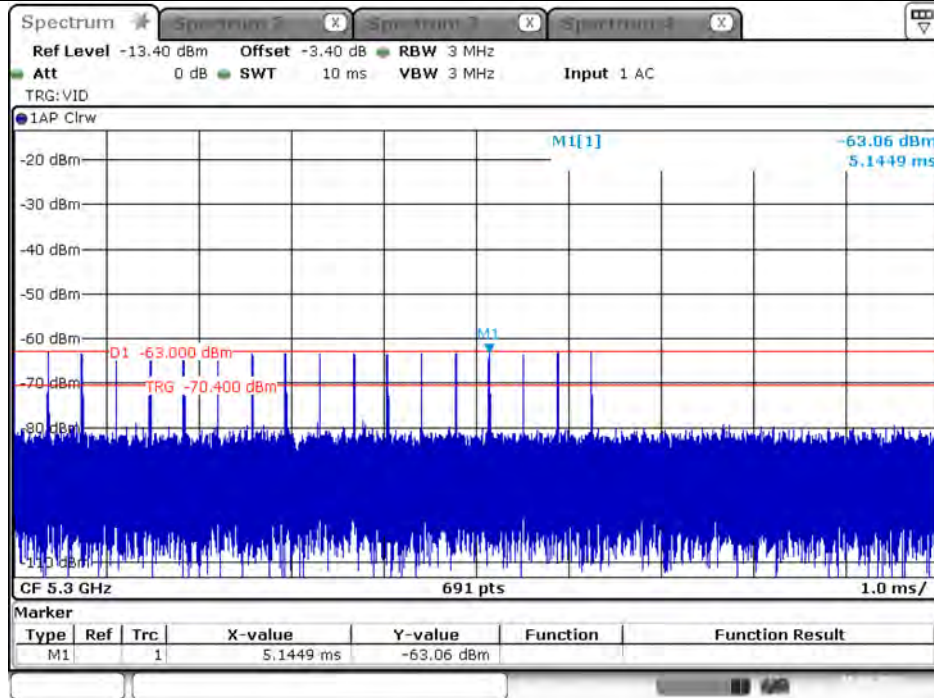

Date: 15.MAR.2021 10:14:25

Type 4: 802.11ax(20MHz) 5300 MHz

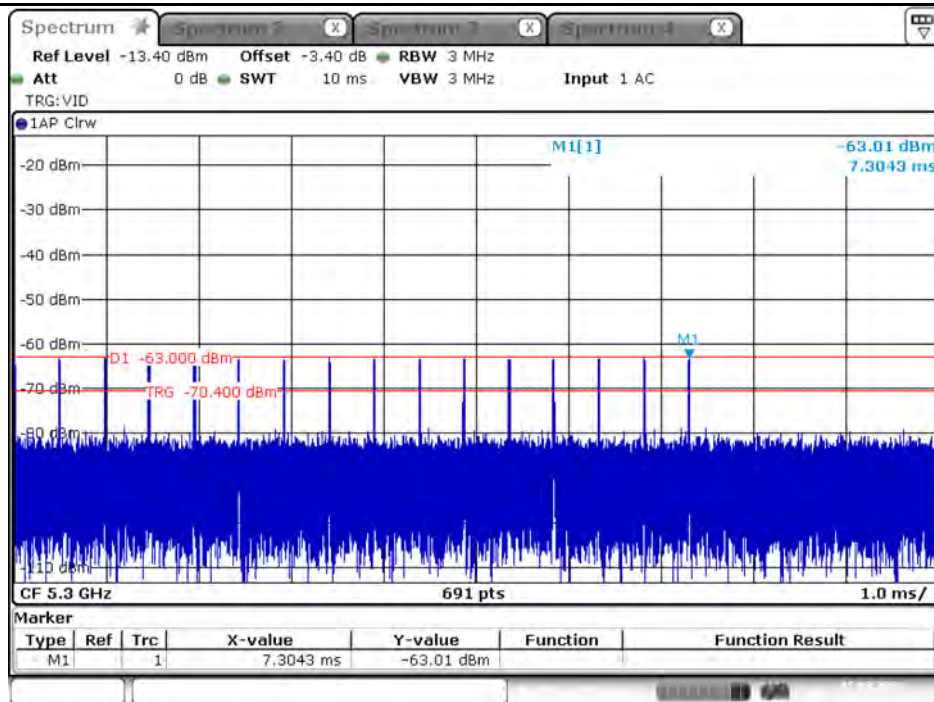

Date: 15.MAR.2021 10:17:29



Type 5: 802.11ax(20MHz) 5300 MHz

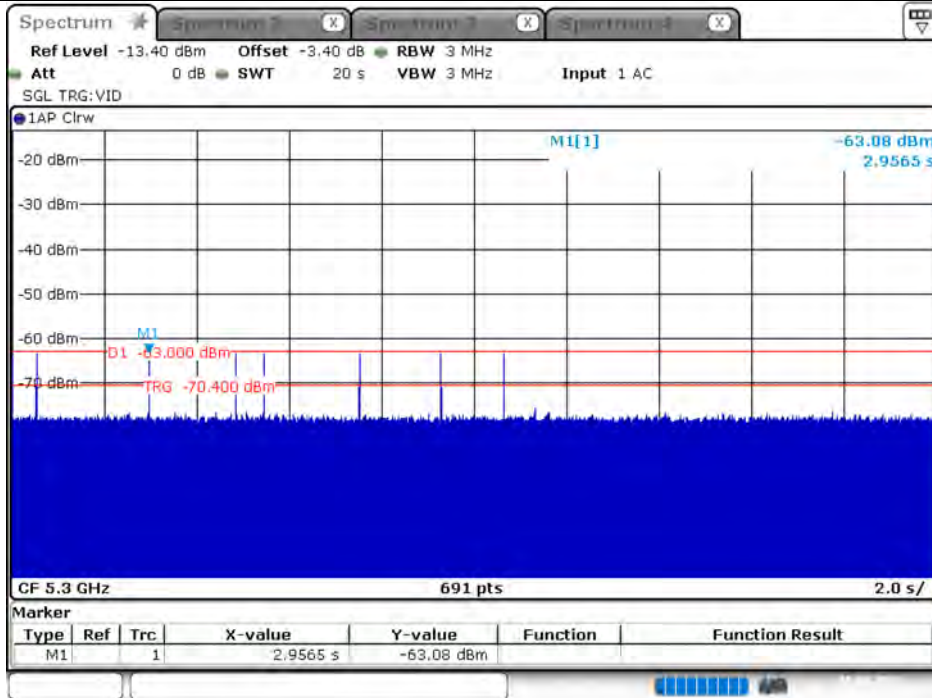

Date: 15.MAR.2021 10:25:12

Type 6: 802.11ax(20MHz) 5300 MHz

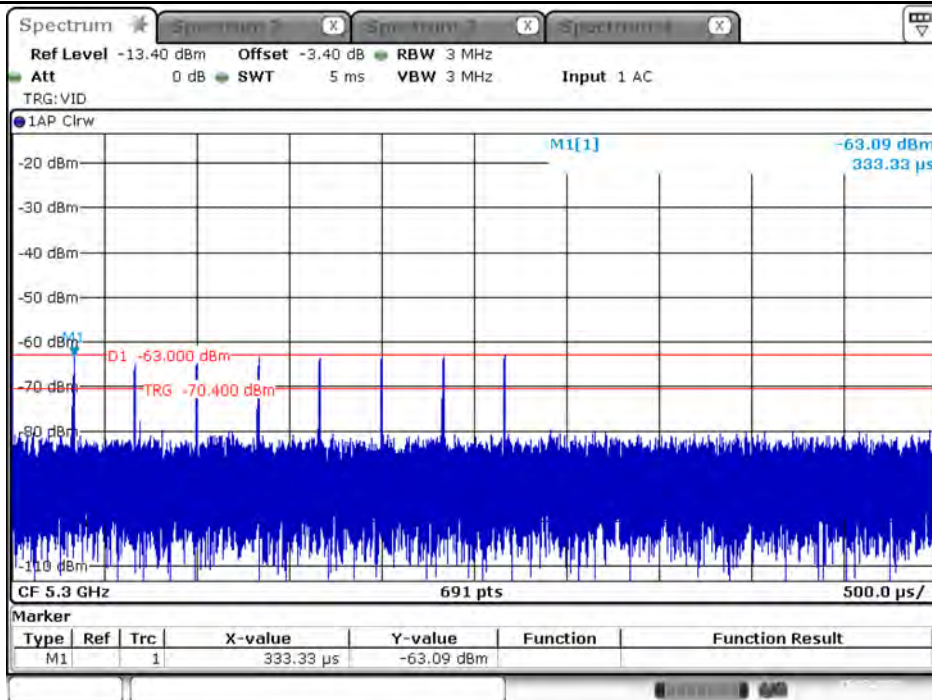

Date: 15.MAR.2021 10:38:46



Type 0: 802.11ax(40MHz) 5310 MHz

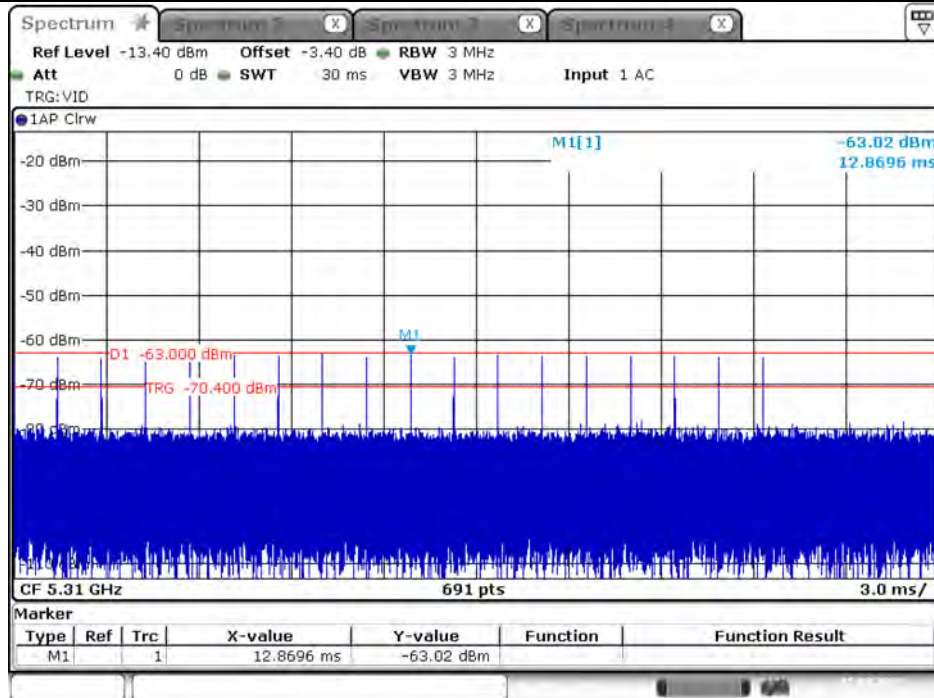

Date: 15.MAR.2021 10:03:35

Type 1: 802.11ax(40MHz) 5310 MHz

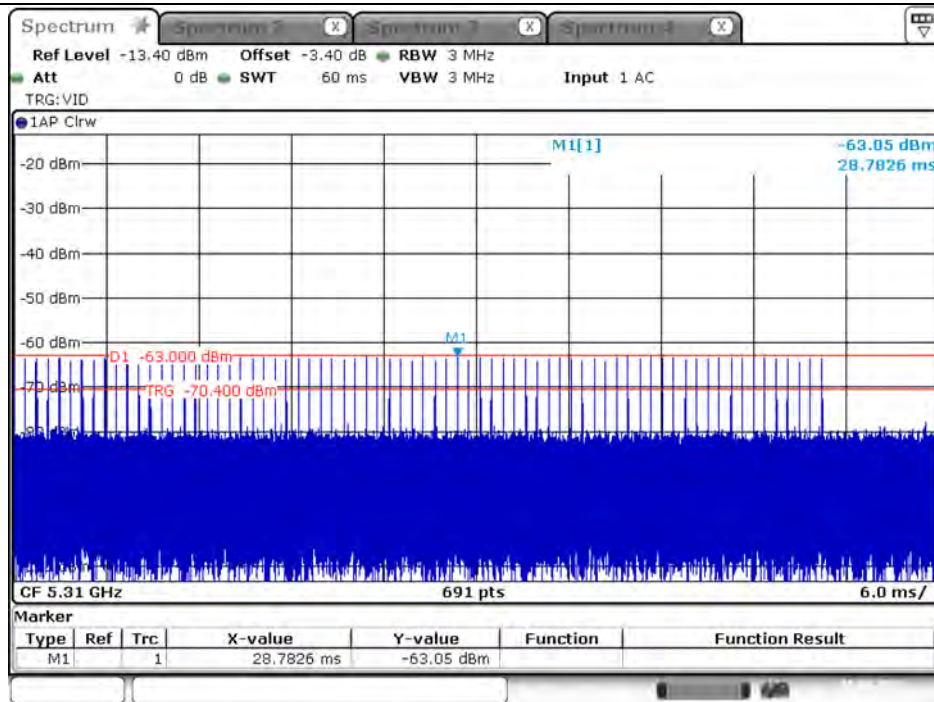

Date: 15.MAR.2021 10:07:04



Type 2: 802.11ax(40MHz) 5310 MHz

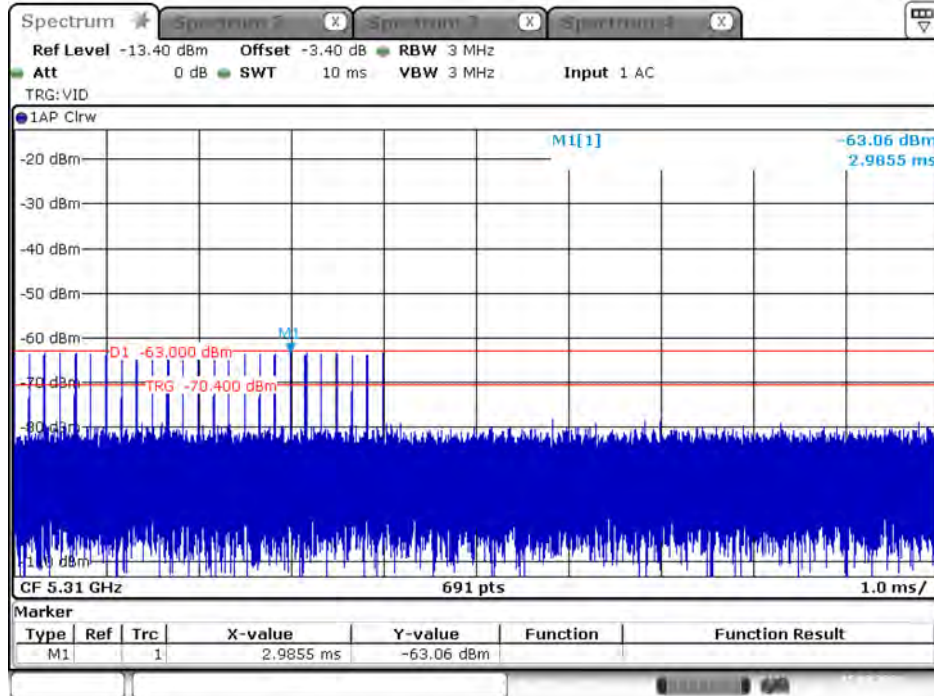

Date: 15.MAR.2021 10:11:40

Type 3: 802.11ax(40MHz) 5310 MHz

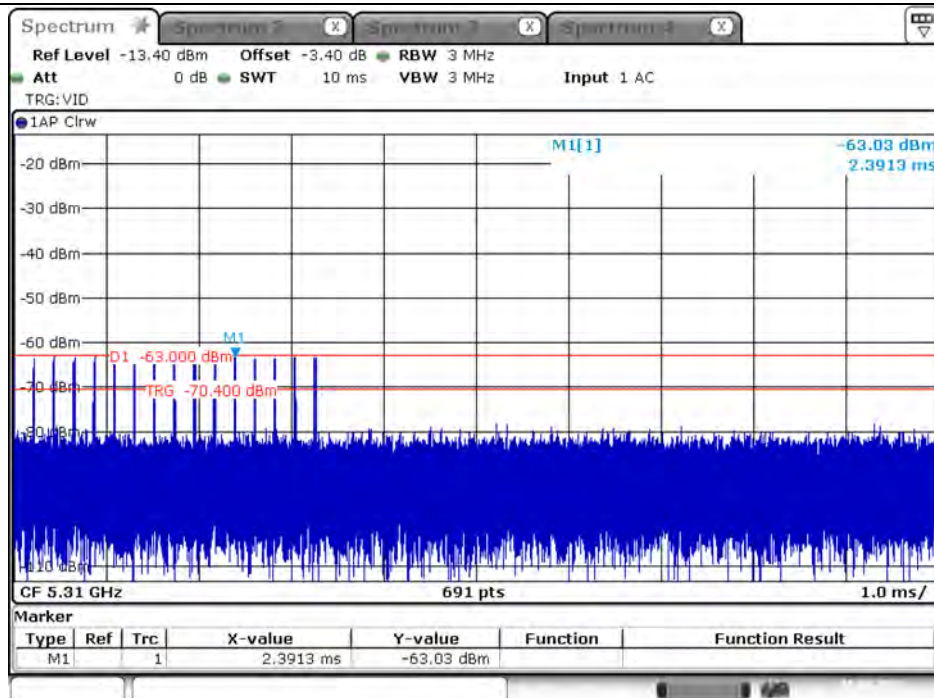

Date: 15.MAR.2021 10:14:56



Type 4: 802.11ax(40MHz) 5310 MHz

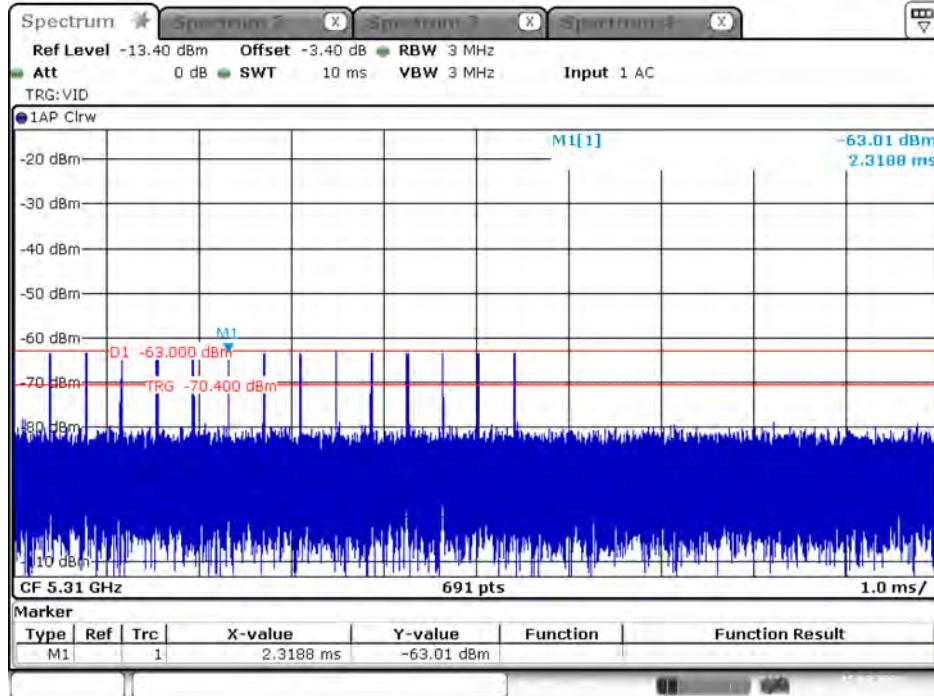

Date: 15.MAR.2021 10:17:54

Type 5: 802.11ax(40MHz) 5310 MHz

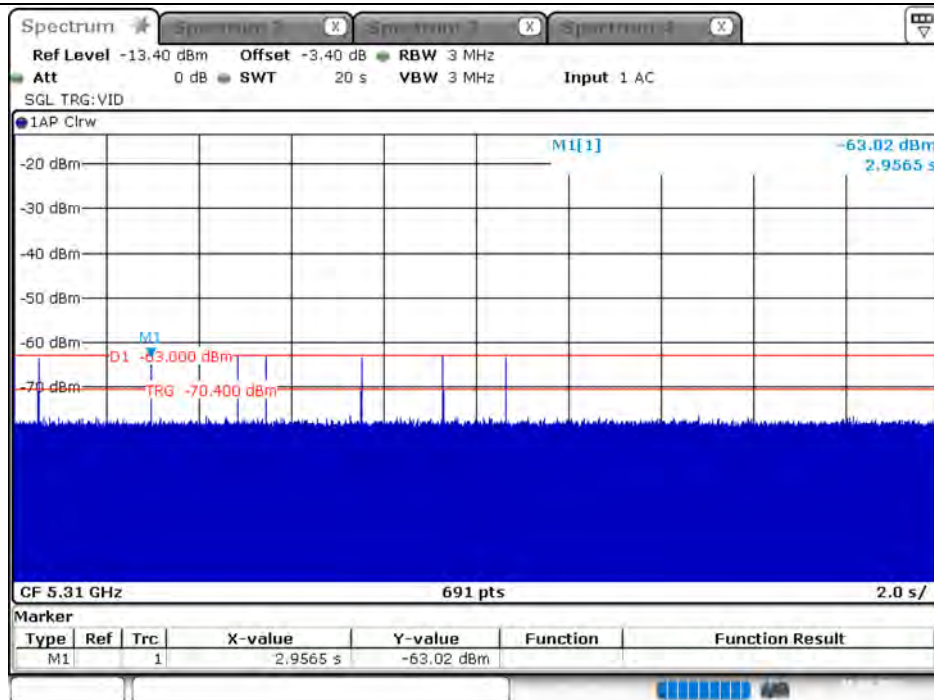

Date: 15.MAR.2021 10:26:16



Type 6: 802.11ax(40MHz) 5310 MHz

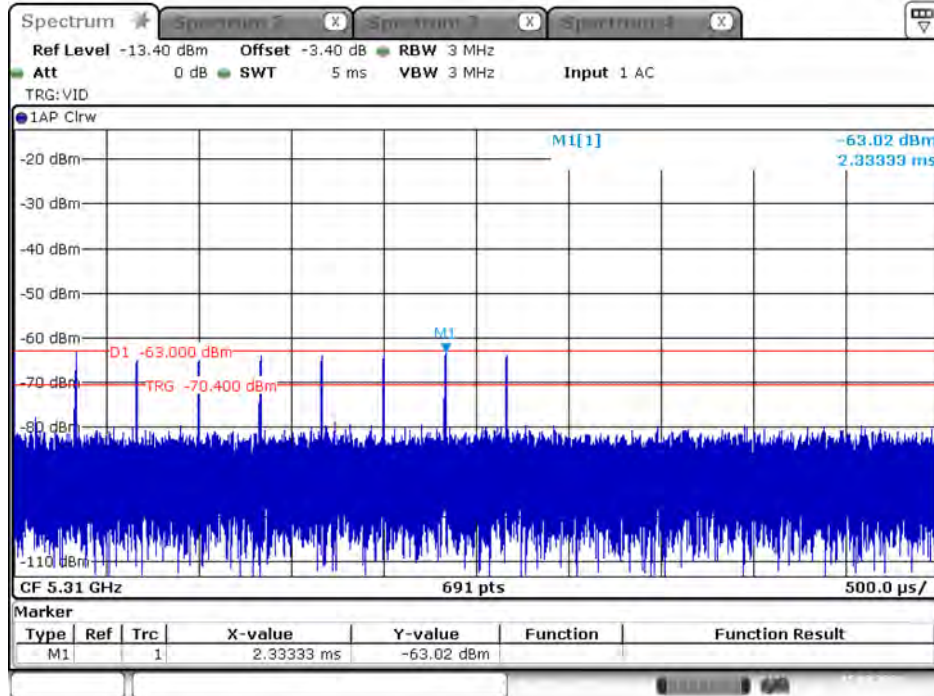

Date: 15.MAR.2021 10:40:04



Type 0: 802.11ax(80MHz) 5290 MHz

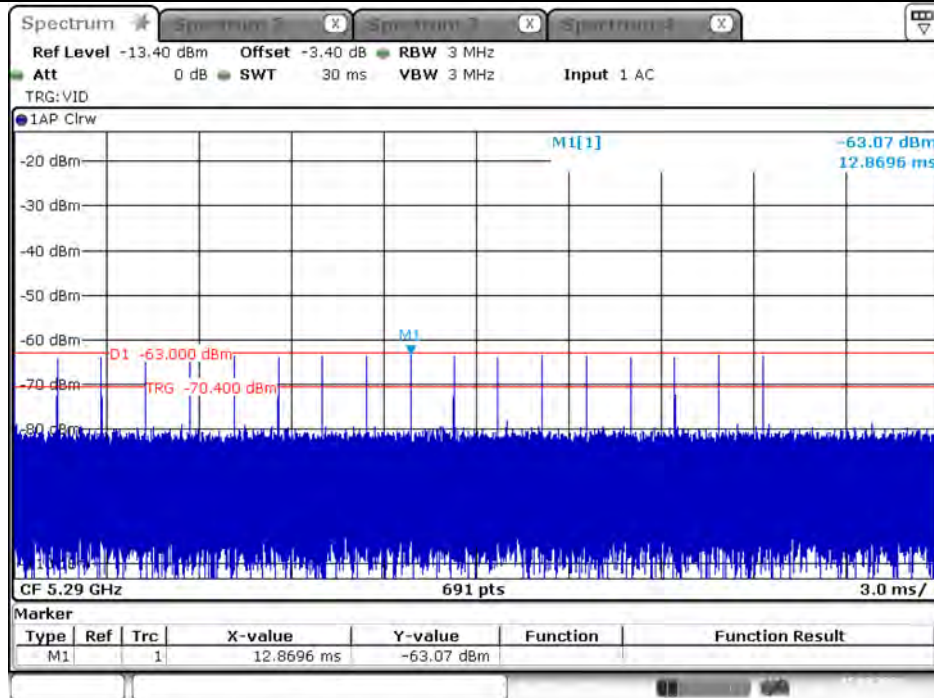

Date: 15.MAR.2021 10:02:40

Type 1: 802.11ax(80MHz) 5290 MHz

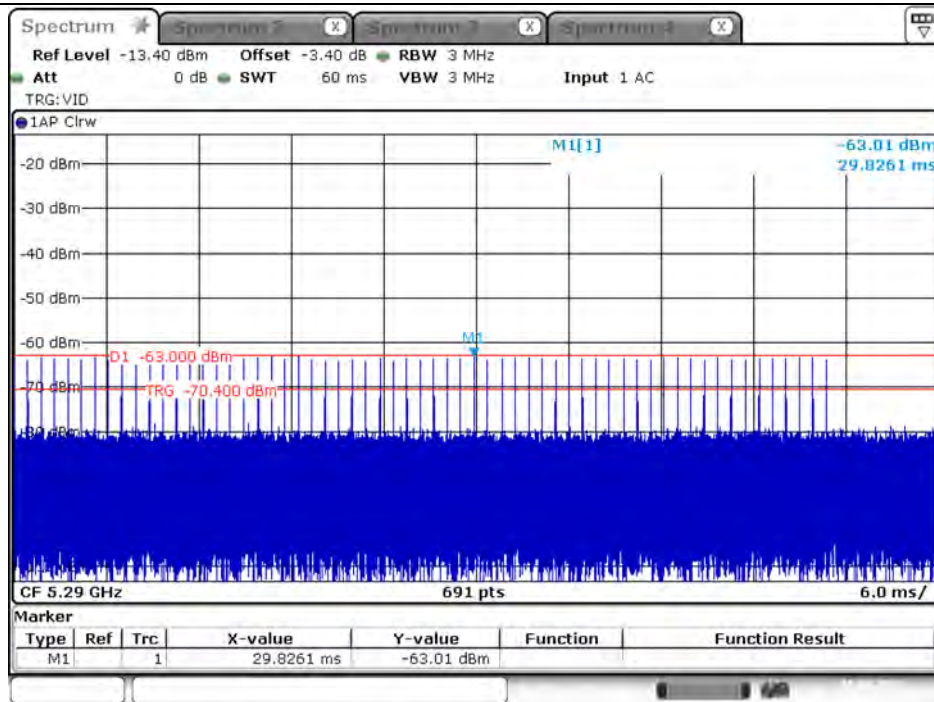

Date: 15.MAR.2021 10:06:31



Type 2: 802.11ax(80MHz) 5290 MHz

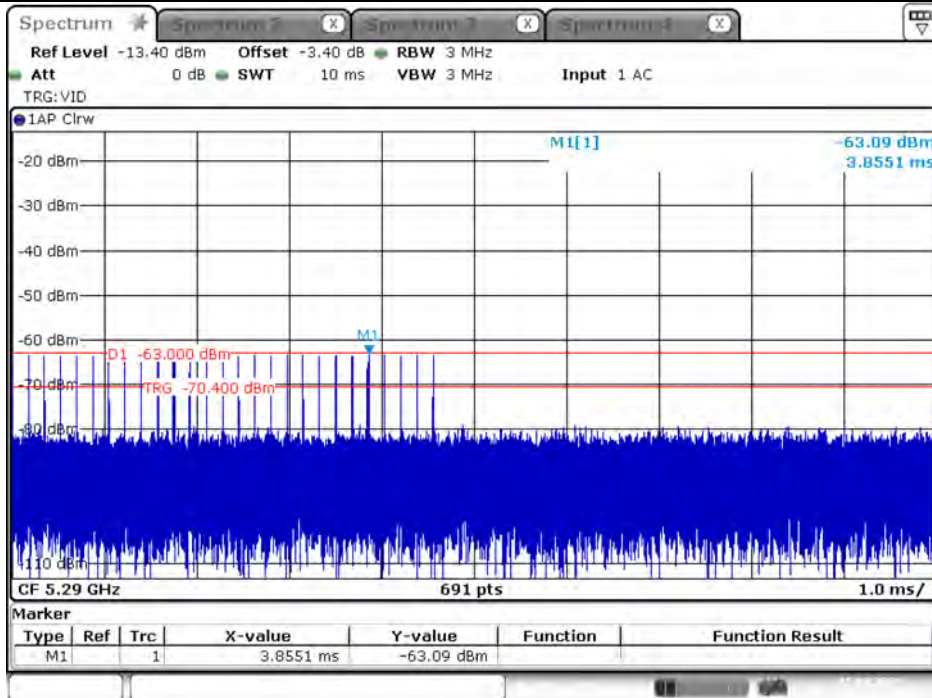

Date: 15.MAR.2021 10:10:45

Type 3: 802.11ax(80MHz) 5290 MHz

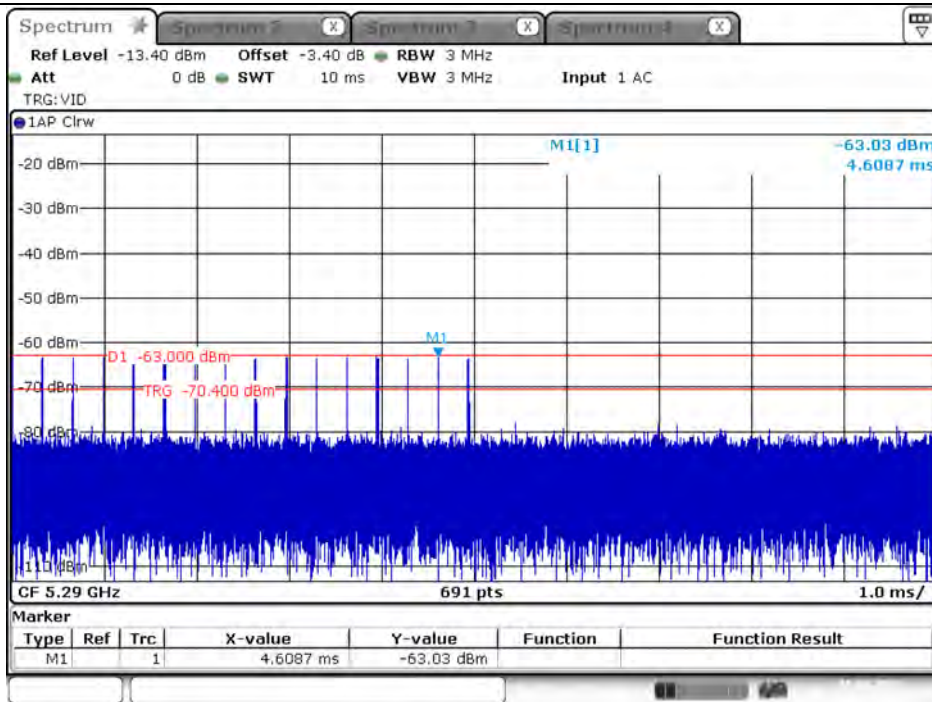

Date: 15.MAR.2021 10:13:53



Type 4: 802.11ax(80MHz) 5290 MHz

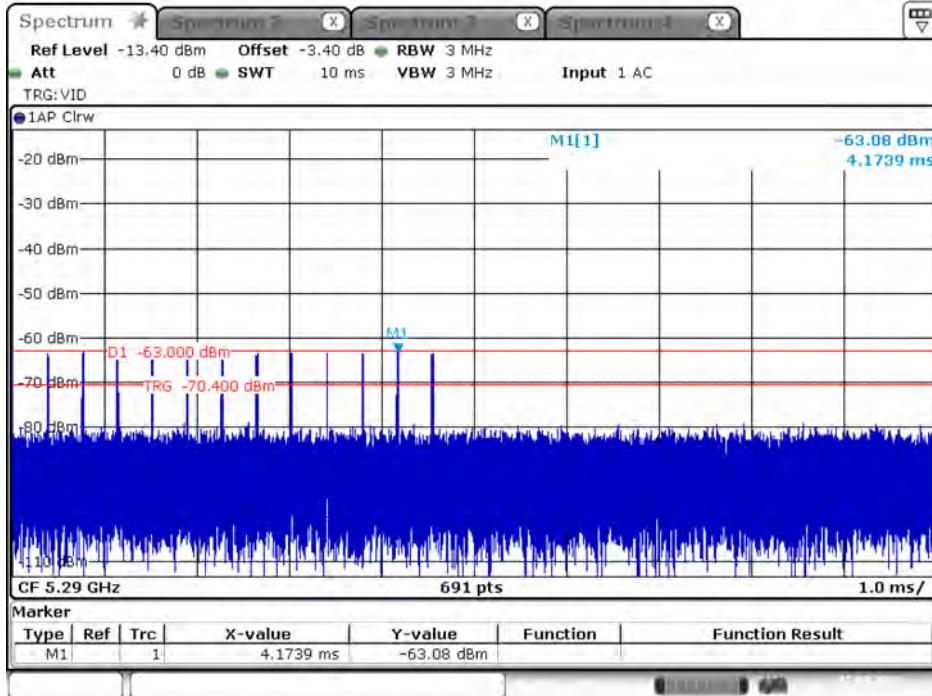

Date: 15.MAR.2021 10:17:08

Type 5: 802.11ax(80MHz) 5290 MHz

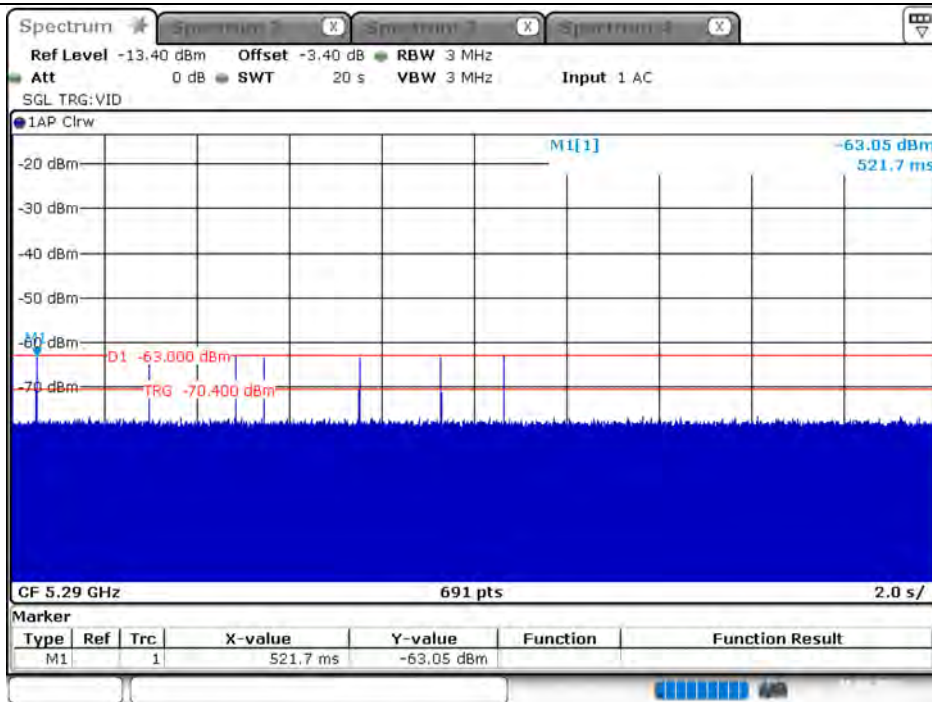

Date: 15.MAR.2021 10:23:59



Type 6: 802.11ax(80MHz) 5290 MHz

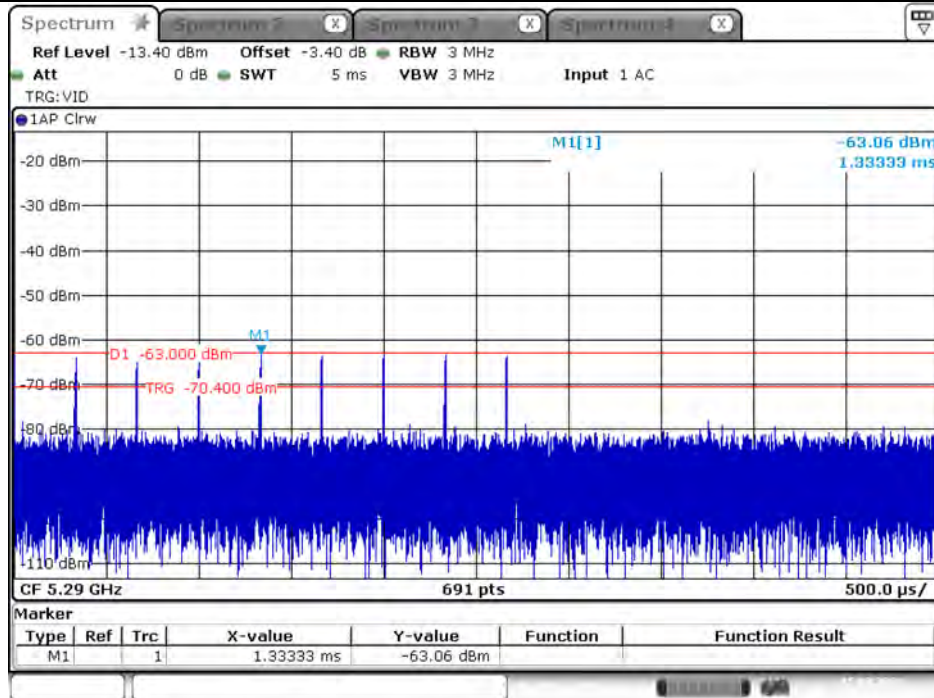

Date: 15.MAR.2021 10:36:22



Type 0: 802.11ax(20MHz) 5500 MHz

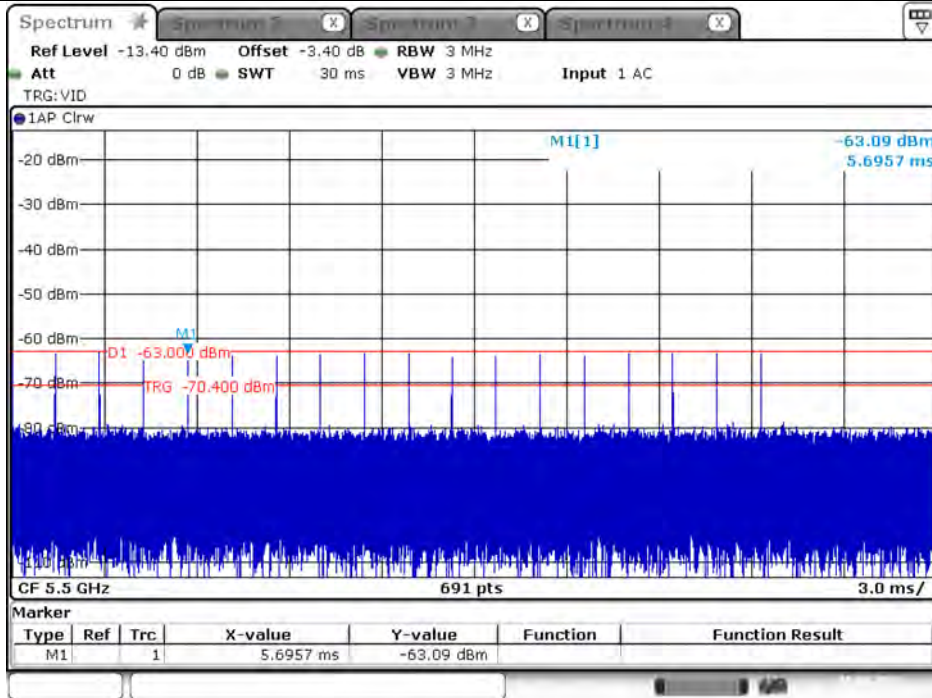

Date: 15.MAR.2021 10:03:58

Type 1: 802.11ax(20MHz) 5500 MHz

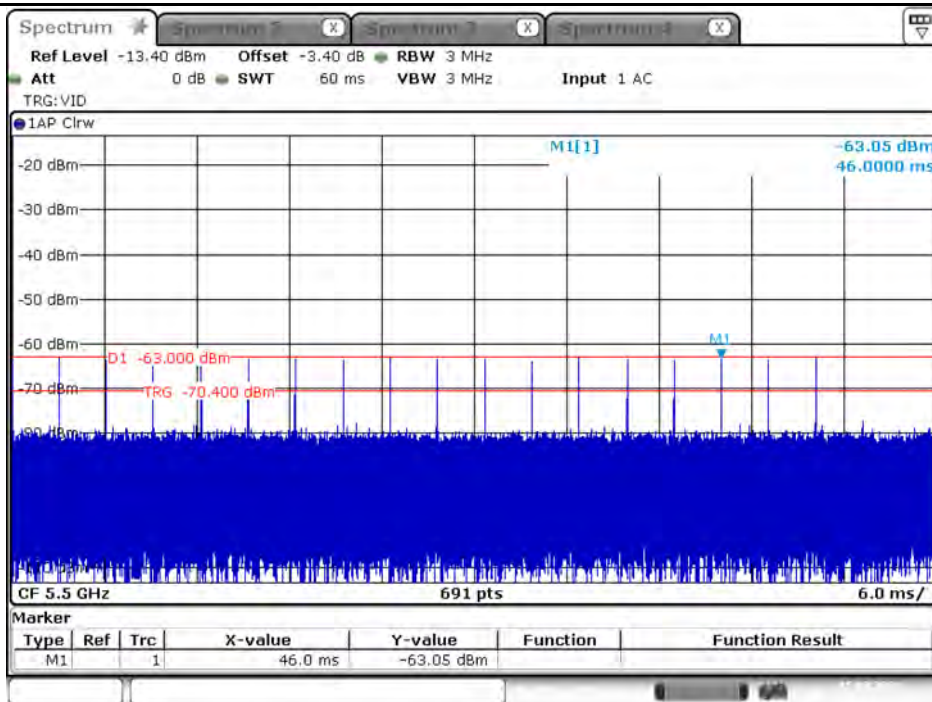

Date: 15.MAR.2021 10:07:40



Type 2: 802.11ax(20MHz) 5500 MHz

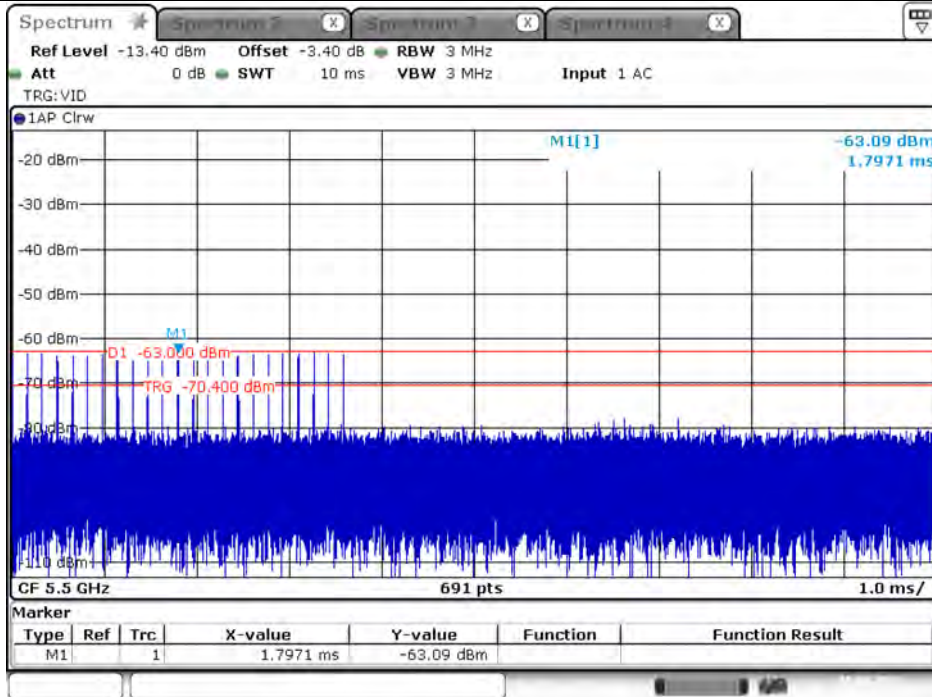

Date: 15.MAR.2021 10:10:21

Type 3: 802.11ax(20MHz) 5500 MHz

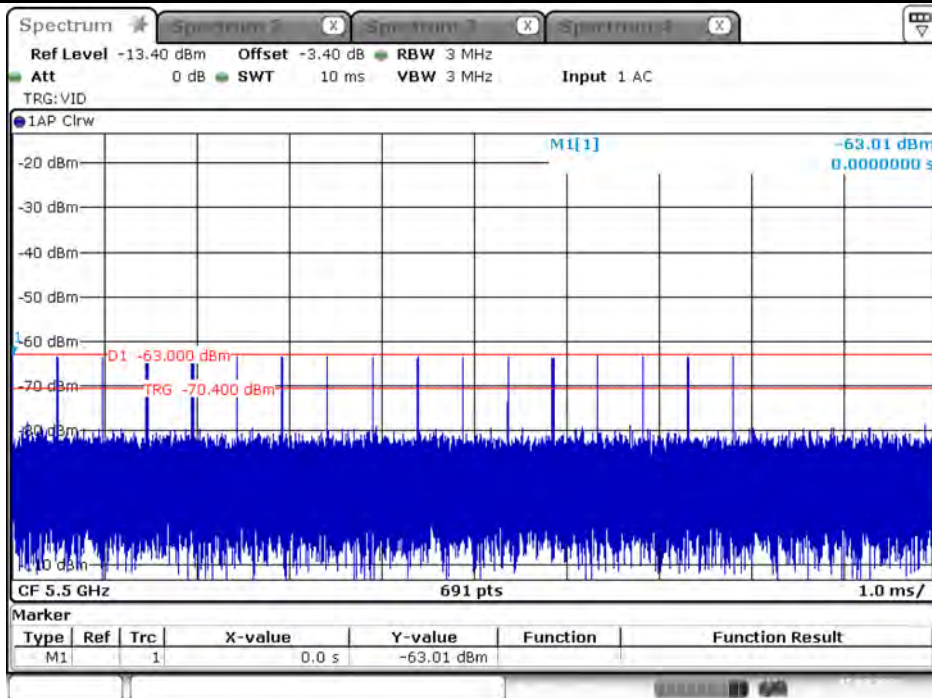

Date: 15.MAR.2021 10:13:34



Type 4: 802.11ax(20MHz) 5500 MHz

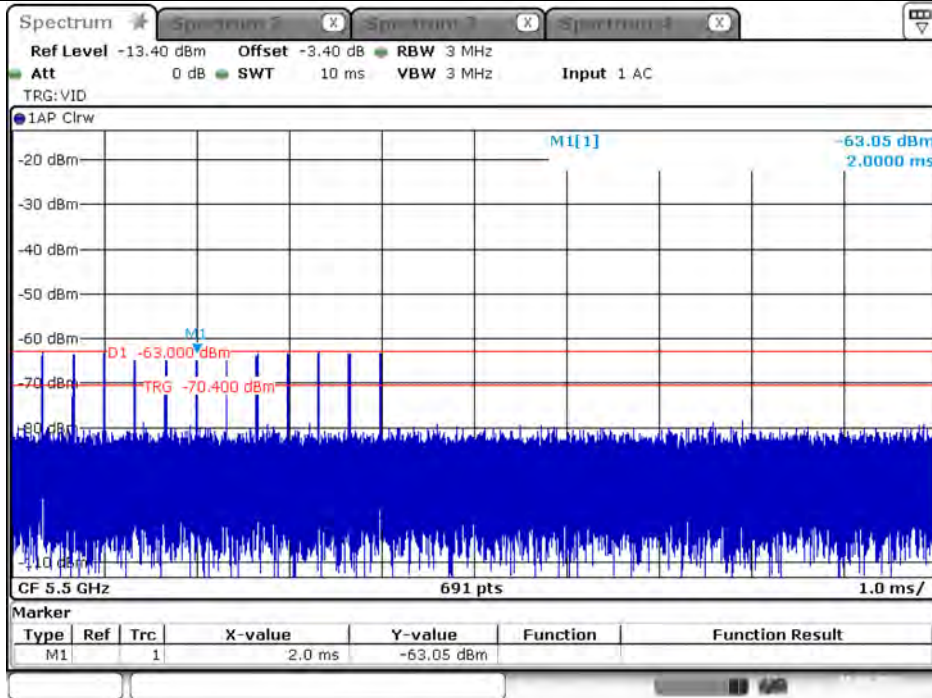

Date: 15.MAR.2021 10:16:45

Type 5: 802.11ax(20MHz) 5500 MHz

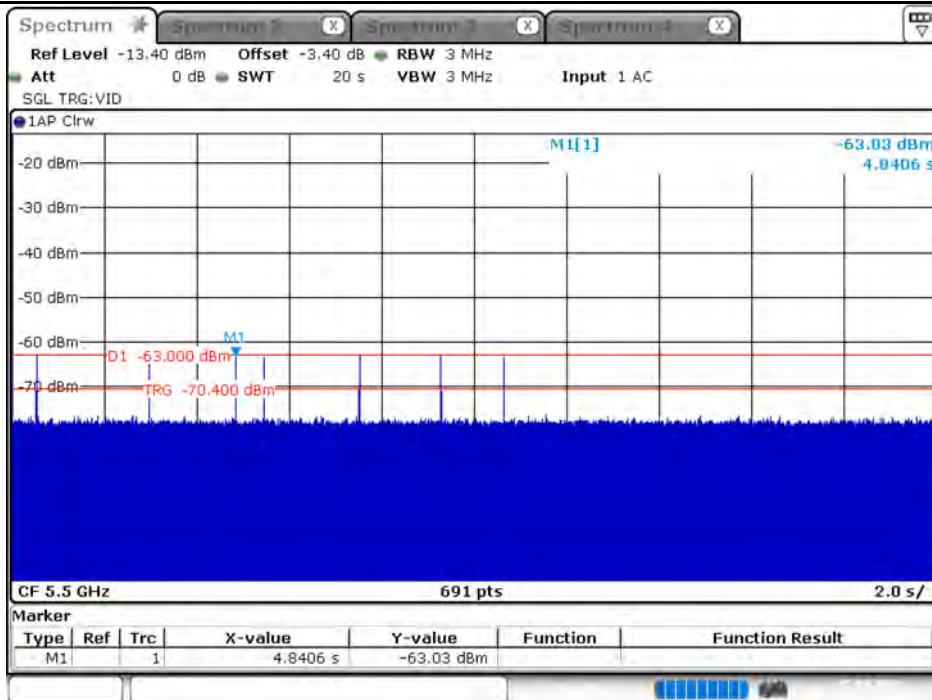

Date: 15.MAR.2021 10:22:00



Type 6: 802.11ax(20MHz) 5500 MHz

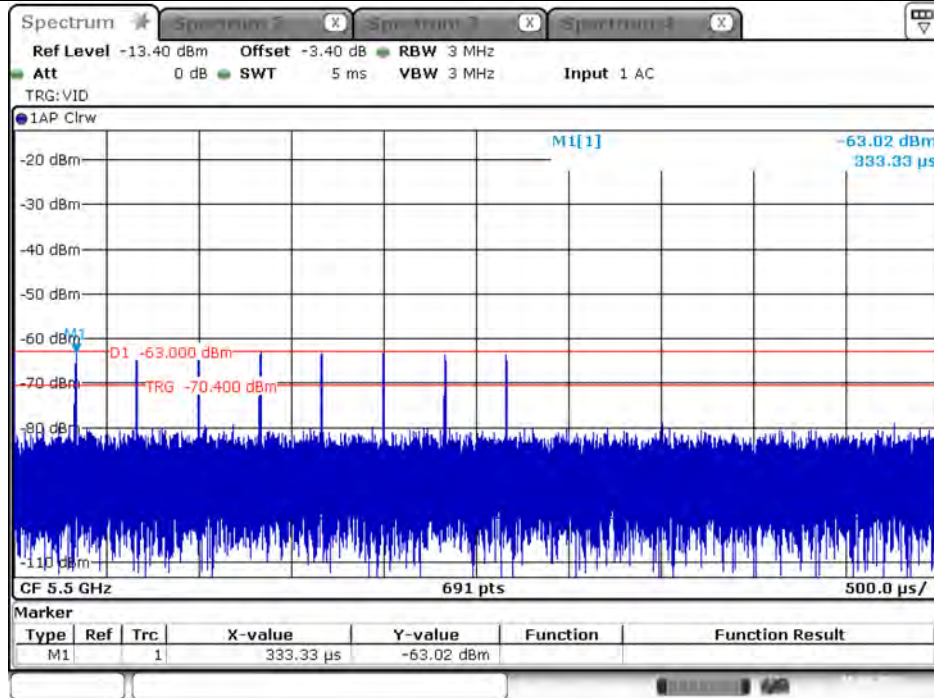

Date: 15.MAR.2021 10:37:55



Type 0: 802.11ax(40MHz) 5510 MHz

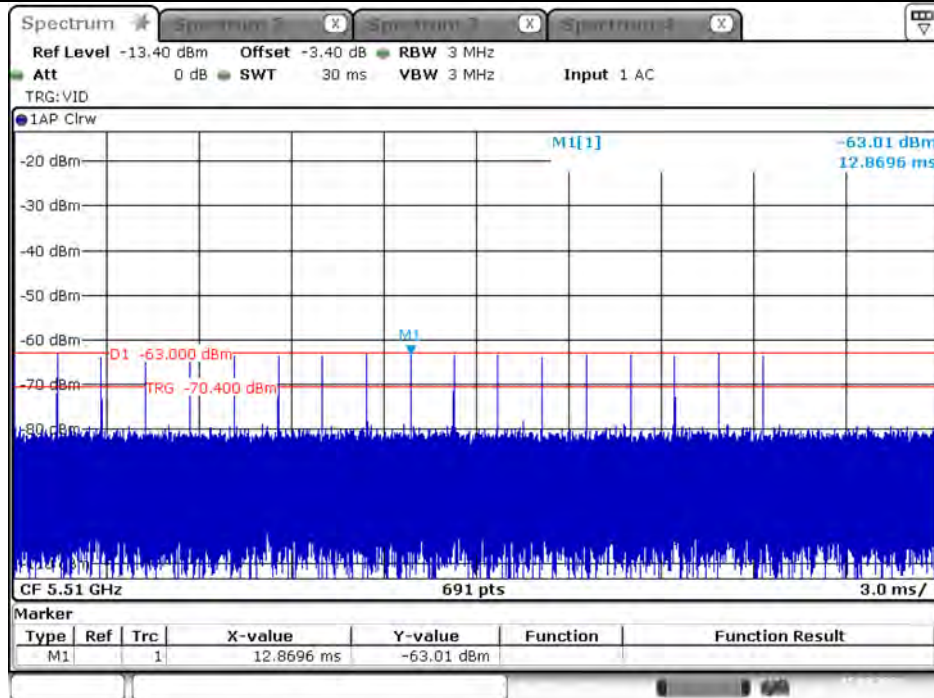

Date: 15.MAR.2021 10:04:31

Type 1: 802.11ax(40MHz) 5510 MHz

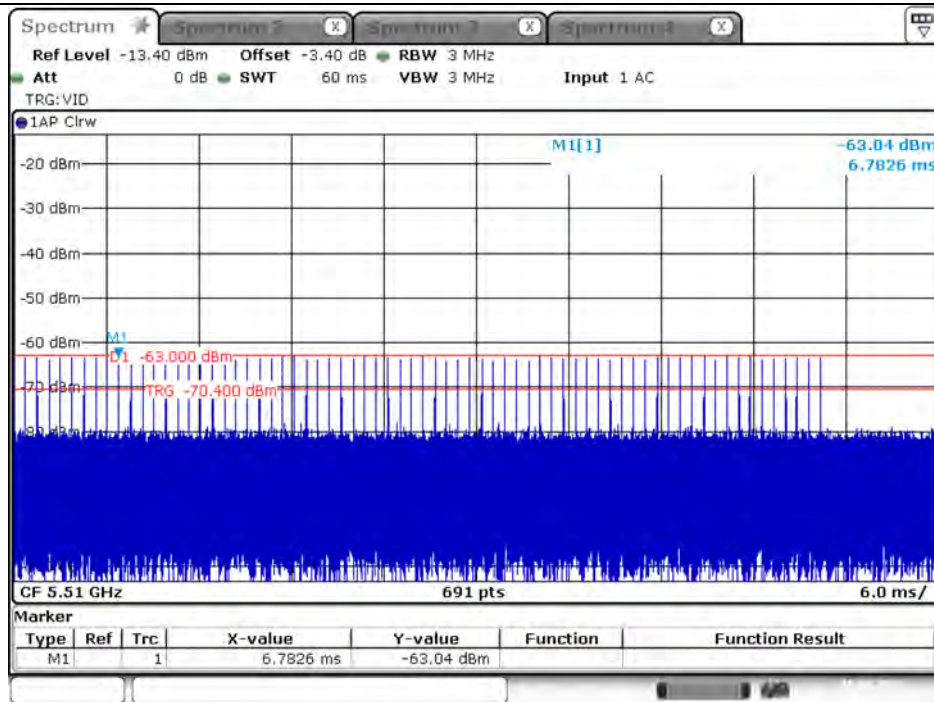

Date: 15.MAR.2021 10:08:14



Type 2: 802.11ax(40MHz) 5510 MHz

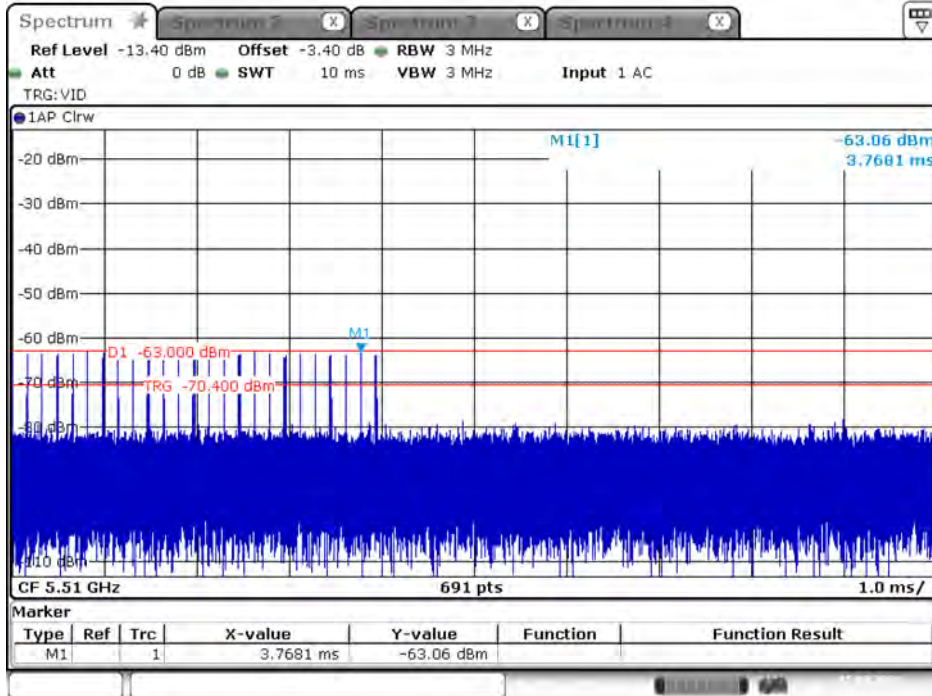

Date: 15.MAR.2021 10:12:12

Type 3: 802.11ax(40MHz) 5510 MHz

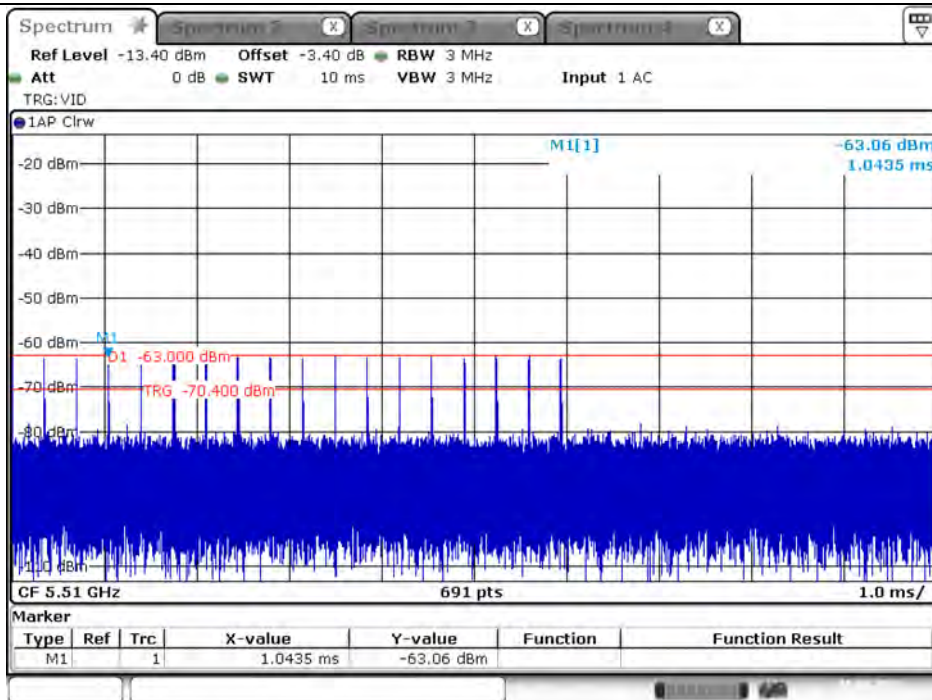

Date: 15.MAR.2021 10:15:20



Type 4: 802.11ax(40MHz) 5510 MHz

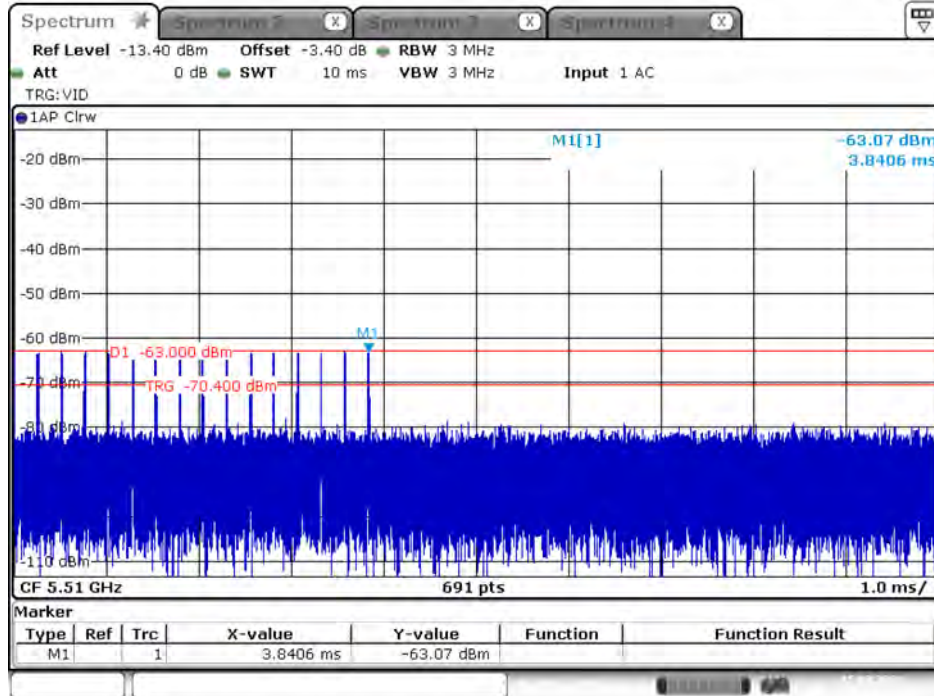

Date: 15.MAR.2021 10:18:19

Type 5: 802.11ax(40MHz) 5510 MHz

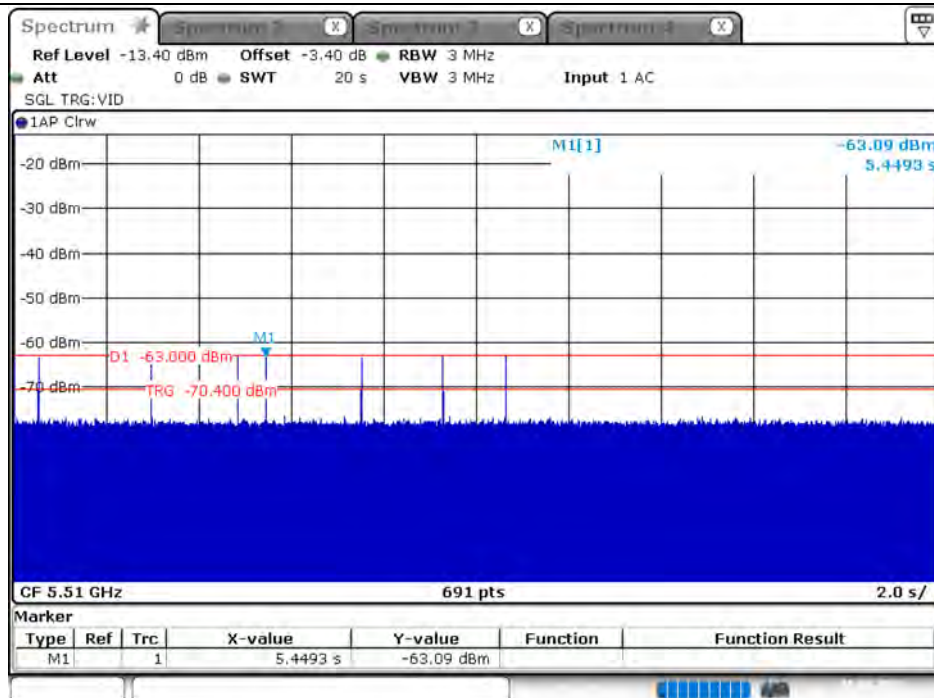

Date: 15.MAR.2021 10:27:06



Type 6: 802.11ax(40MHz) 5510 MHz

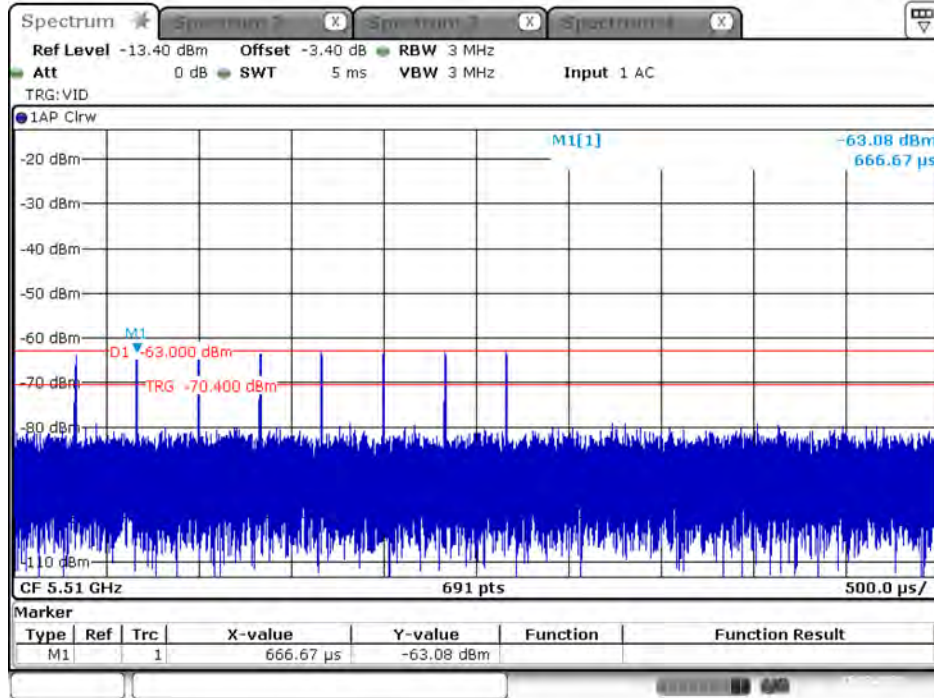

Date: 15.MAR.2021 10:40:28



Type 0: 802.11ax(80MHz) 5530 MHz

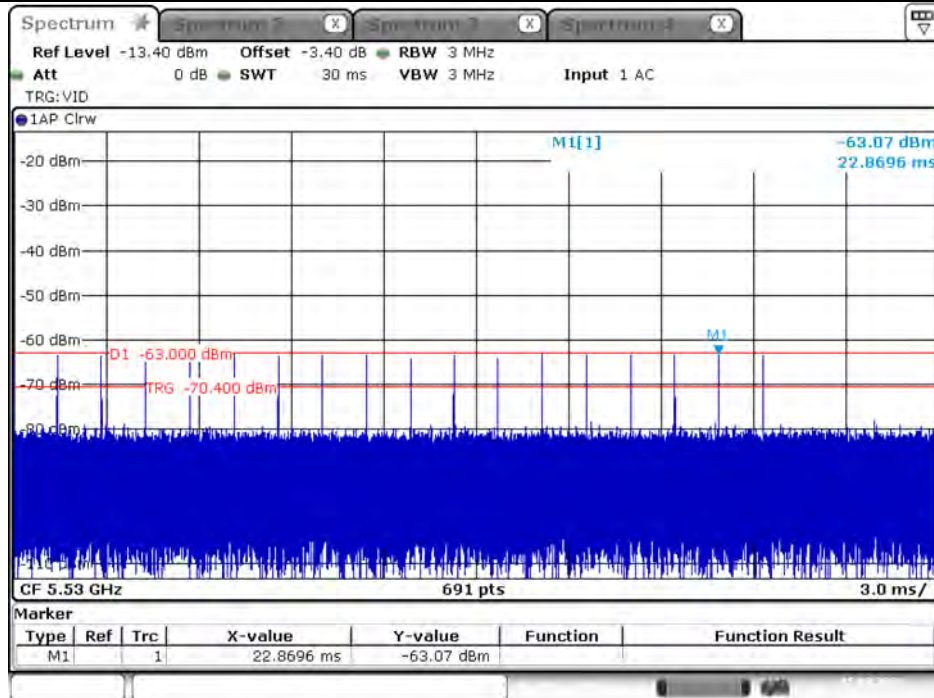

Date: 15.MAR.2021 10:04:56

Type 1: 802.11ax(80MHz) 5530 MHz

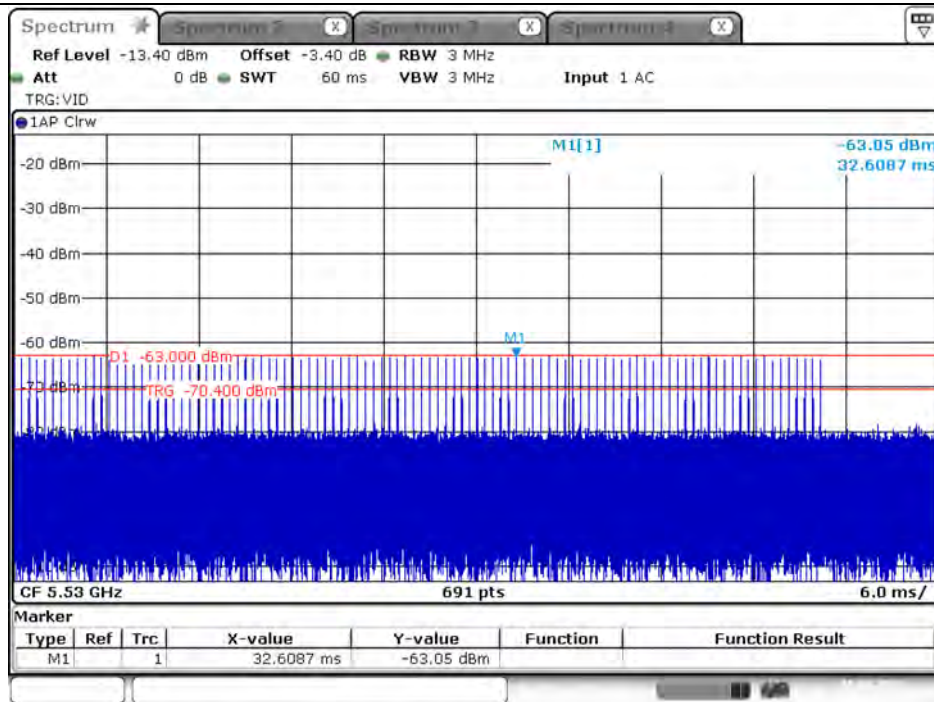

Date: 15.MAR.2021 10:08:55



Type 2: 802.11ax(80MHz) 5530 MHz

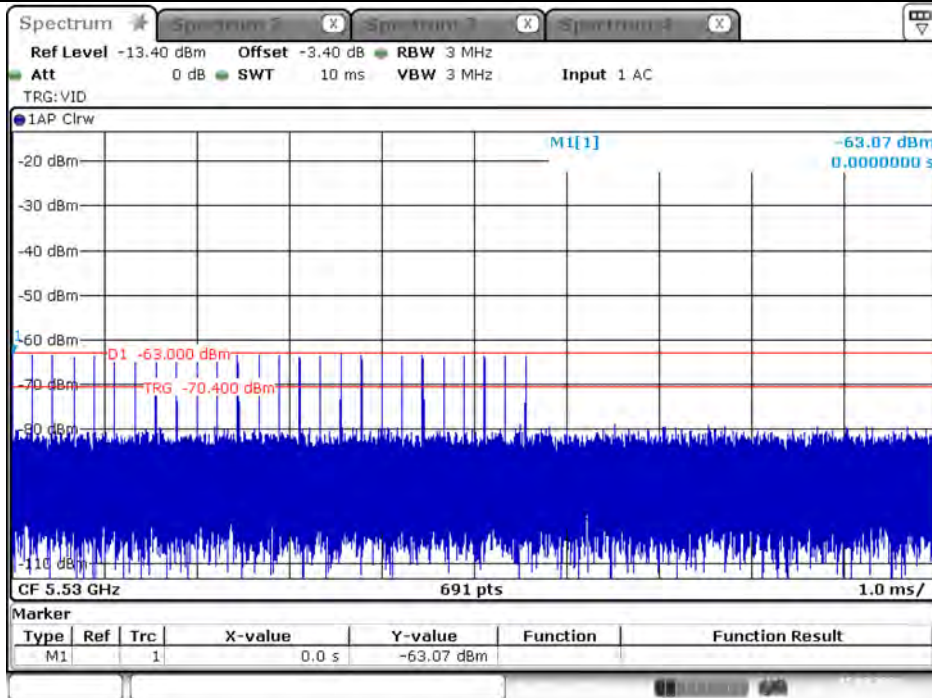

Date: 15.MAR.2021 10:12:39

Type 3: 802.11ax(80MHz) 5530 MHz

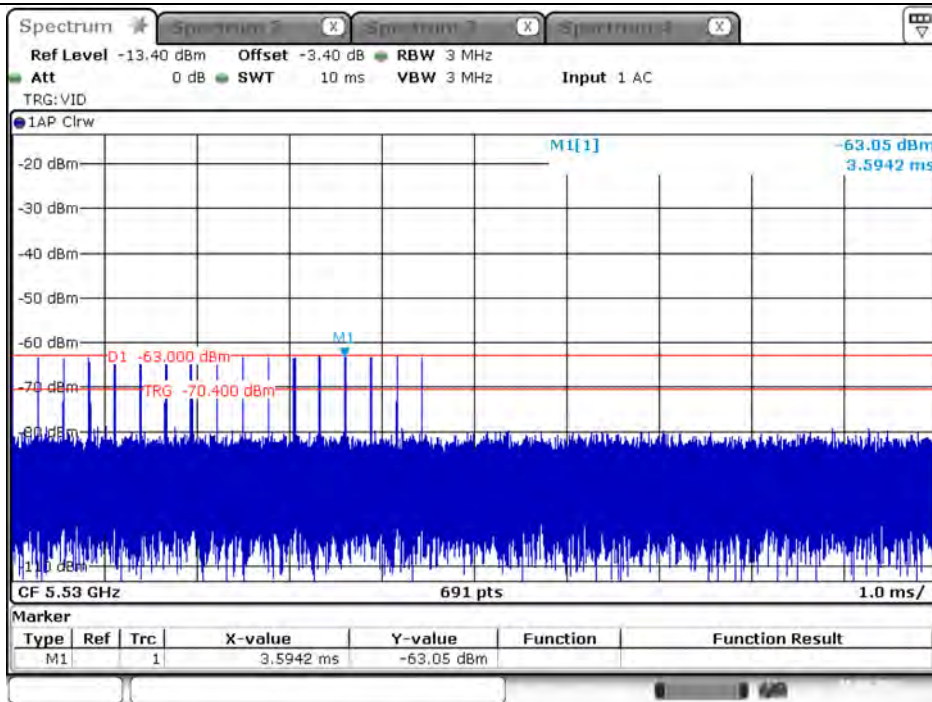

Date: 15.MAR.2021 10:15:48



Type 4: 802.11ax(80MHz) 5530 MHz

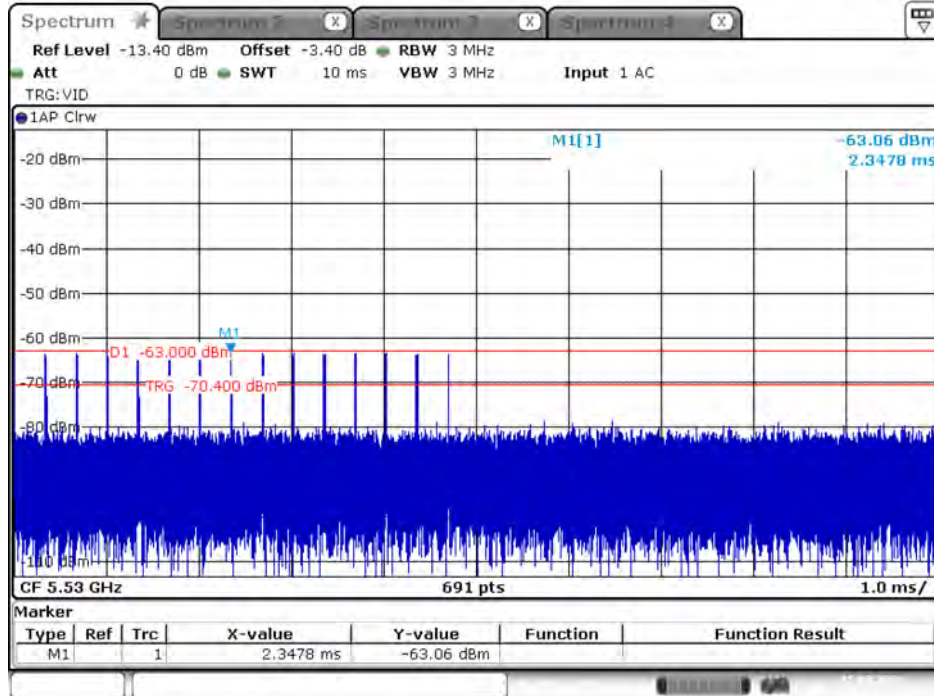

Date: 15.MAR.2021 10:19:22

Type 5: 802.11ax(80MHz) 5530 MHz

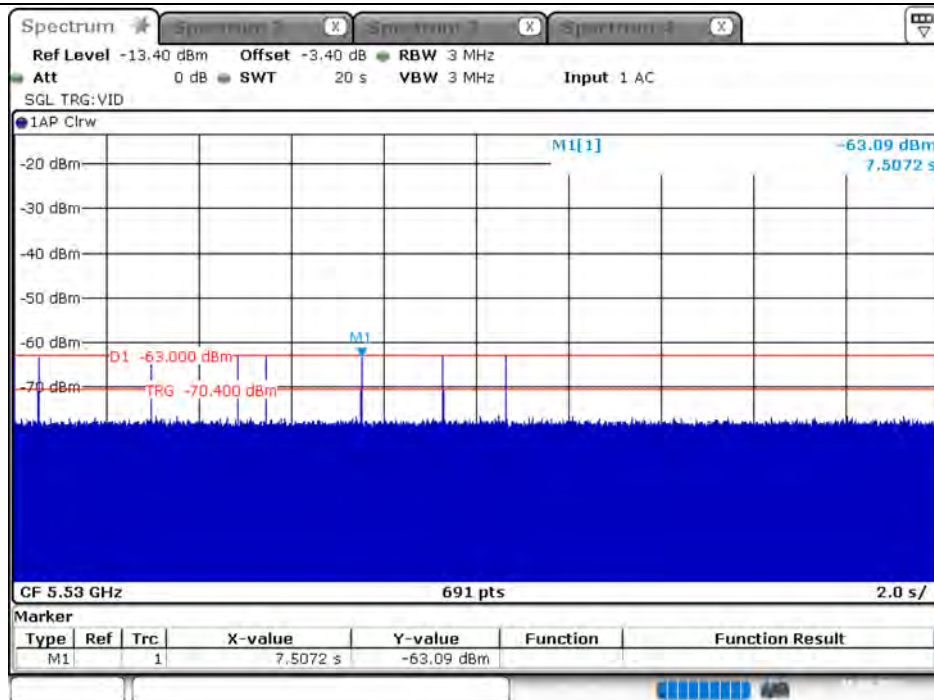

Date: 15.MAR.2021 10:31:22



Type 6: 802.11ax(80MHz) 5530 MHz

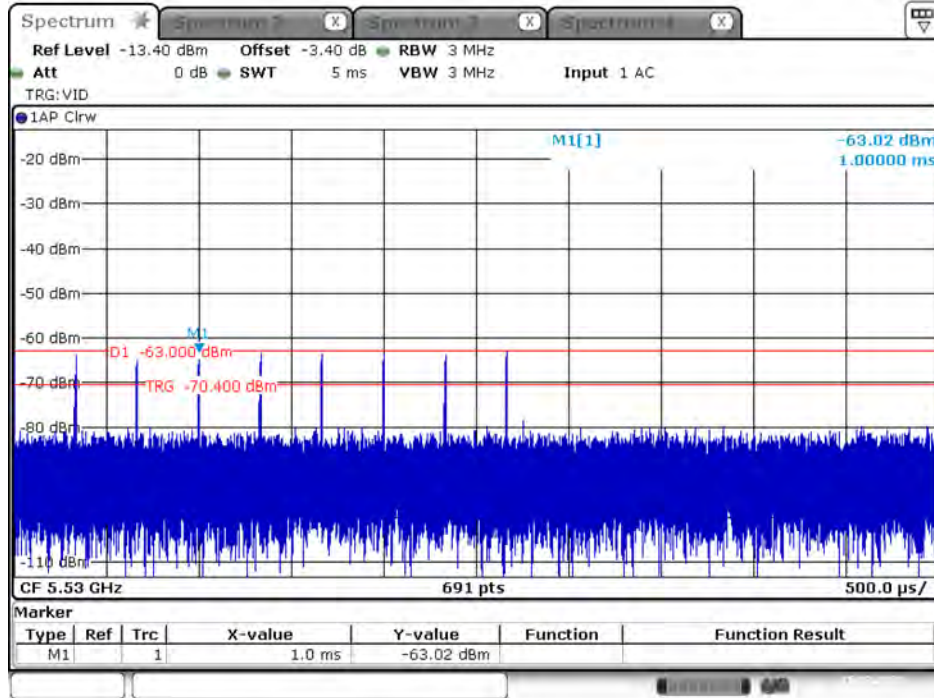

Date: 15.MAR.2021 10:41:03



Type 0: 802.11ax(160MHz) 5570 MHz

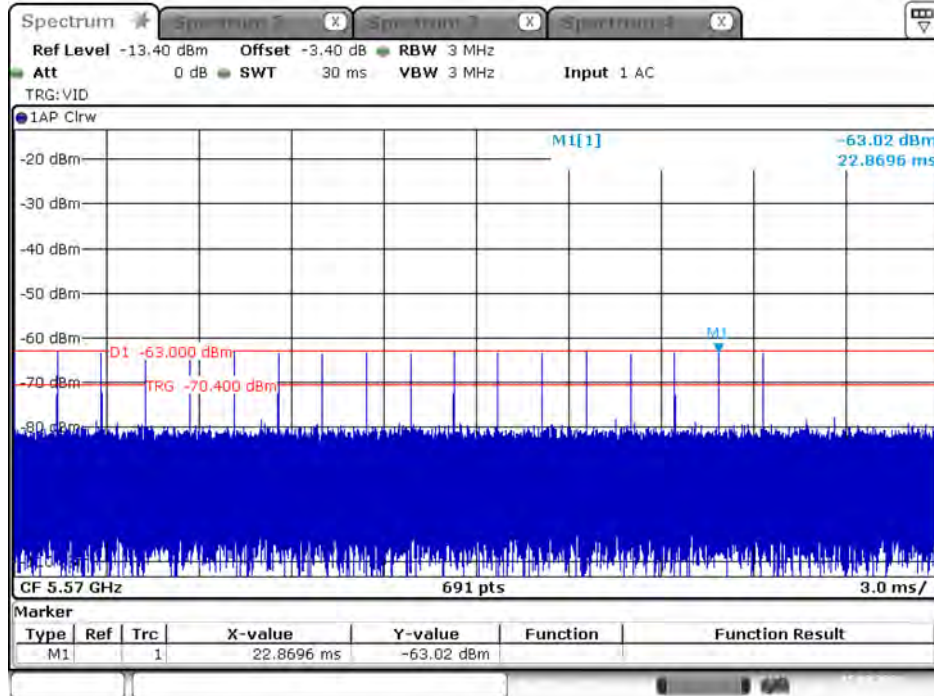

Date: 15.MAR.2021 10:05:26

Type 1: 802.11ax(160MHz) 5570 MHz

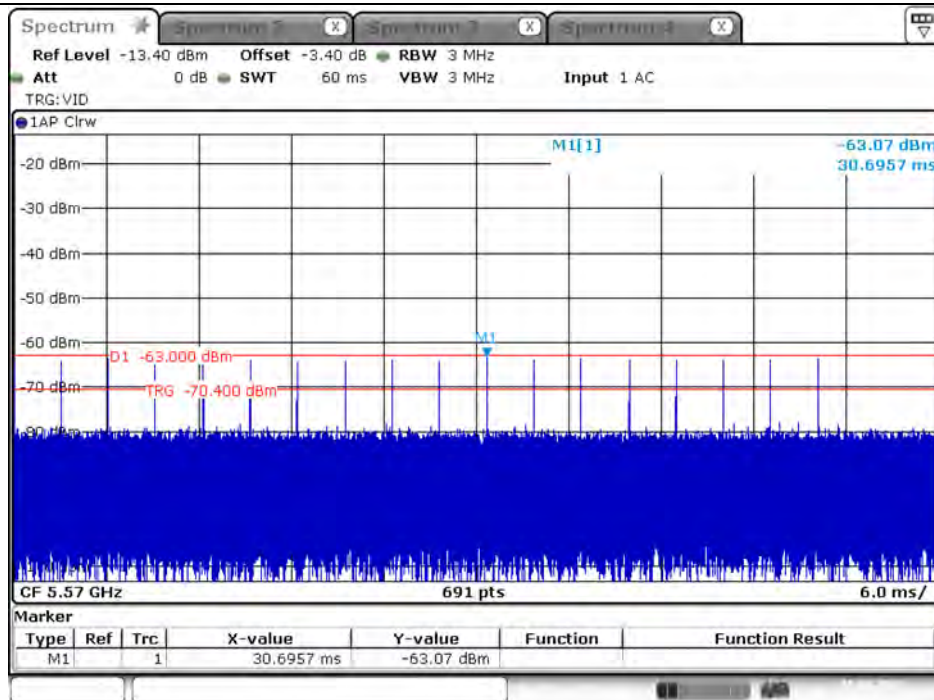

Date: 15.MAR.2021 10:09:41



Type 2: 802.11ax(160MHz) 5570 MHz

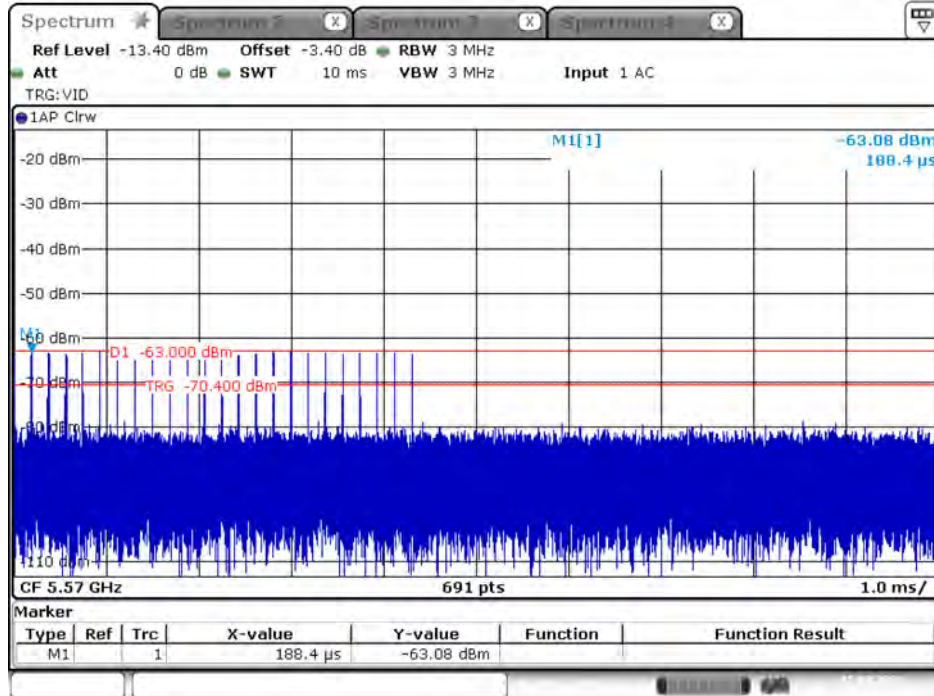

Date: 15.MAR.2021 10:13:00

Type 3: 802.11ax(160MHz) 5570 MHz

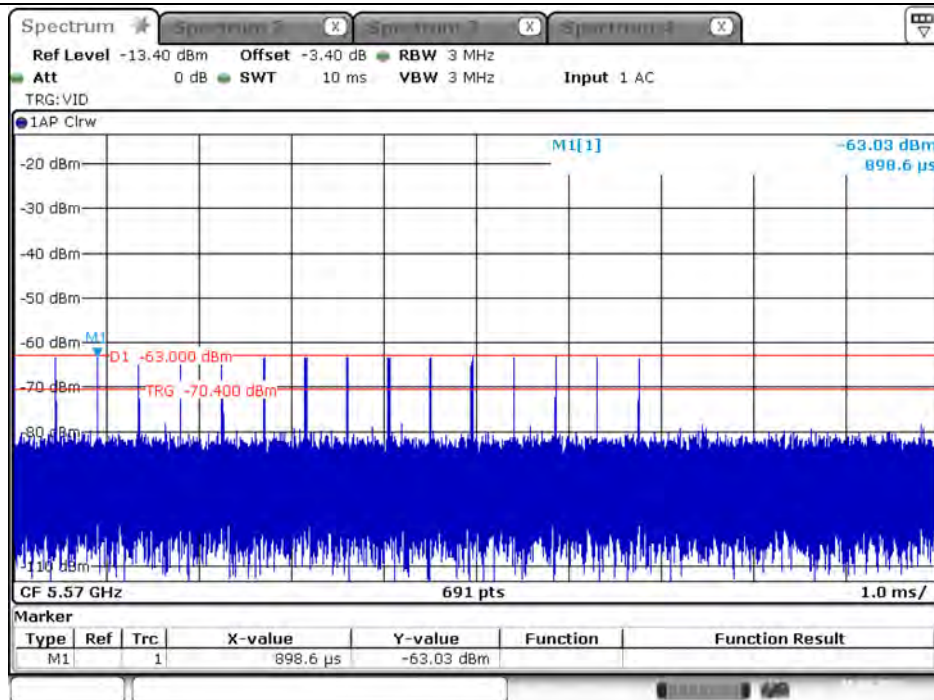

Date: 15.MAR.2021 10:16:08



Type 4: 802.11ax(160MHz) 5570 MHz

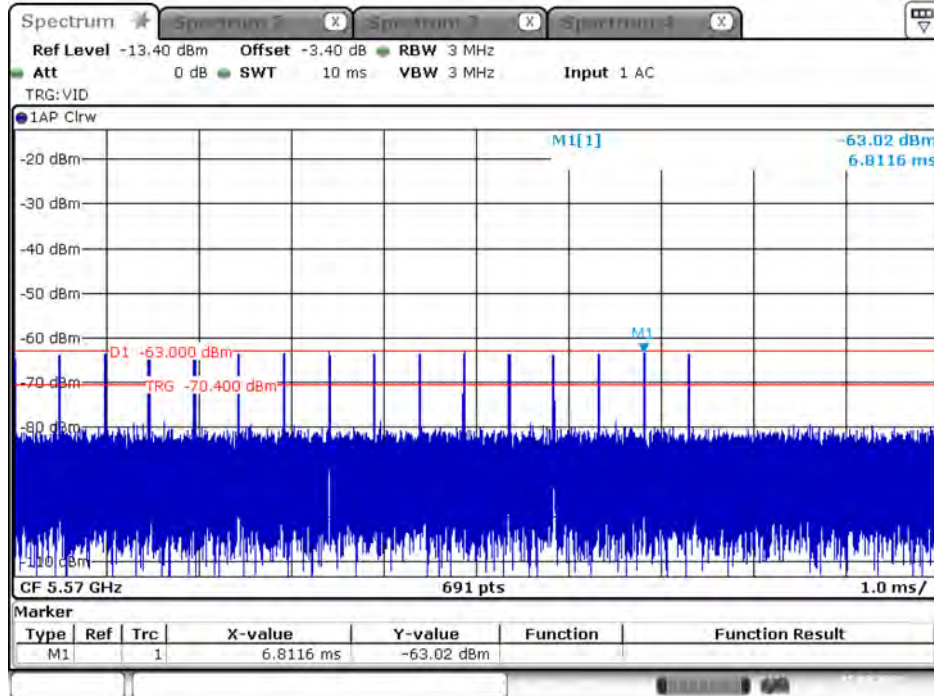

Date: 15.MAR.2021 10:19:45

Type 5: 802.11ax(160MHz) 5570 MHz

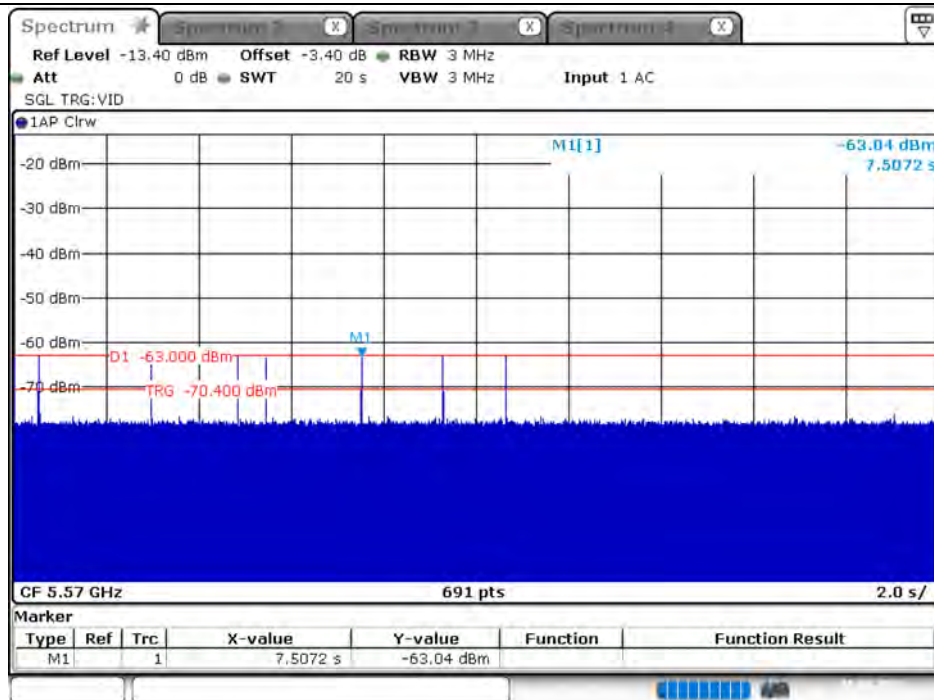

Date: 15.MAR.2021 10:35:24



Type 6: 802.11ax(160MHz) 5570 MHz

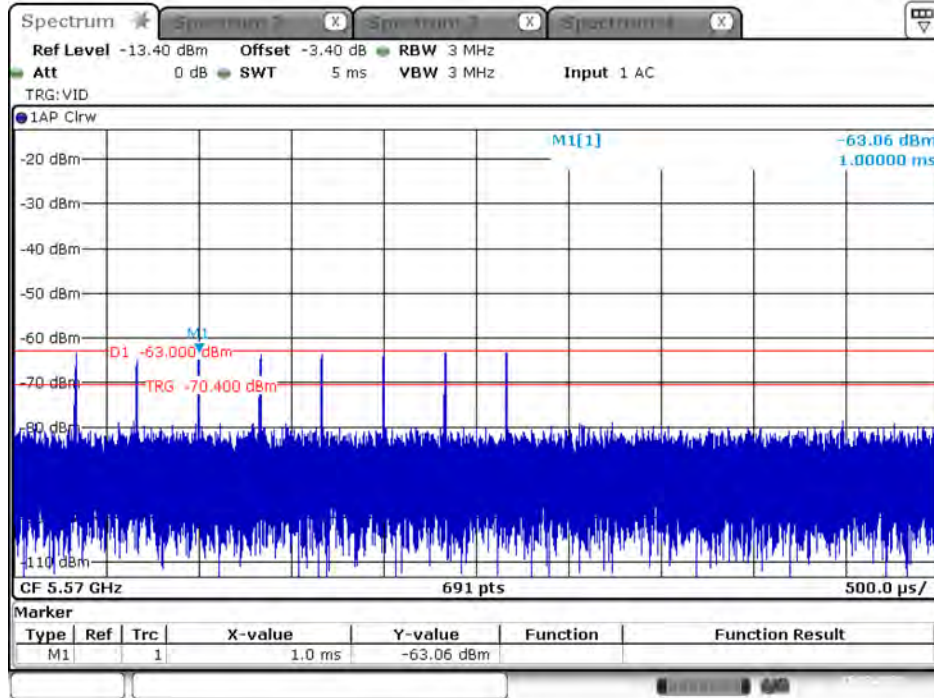

Date: 15.MAR.2021 10:41:39



Extender mode

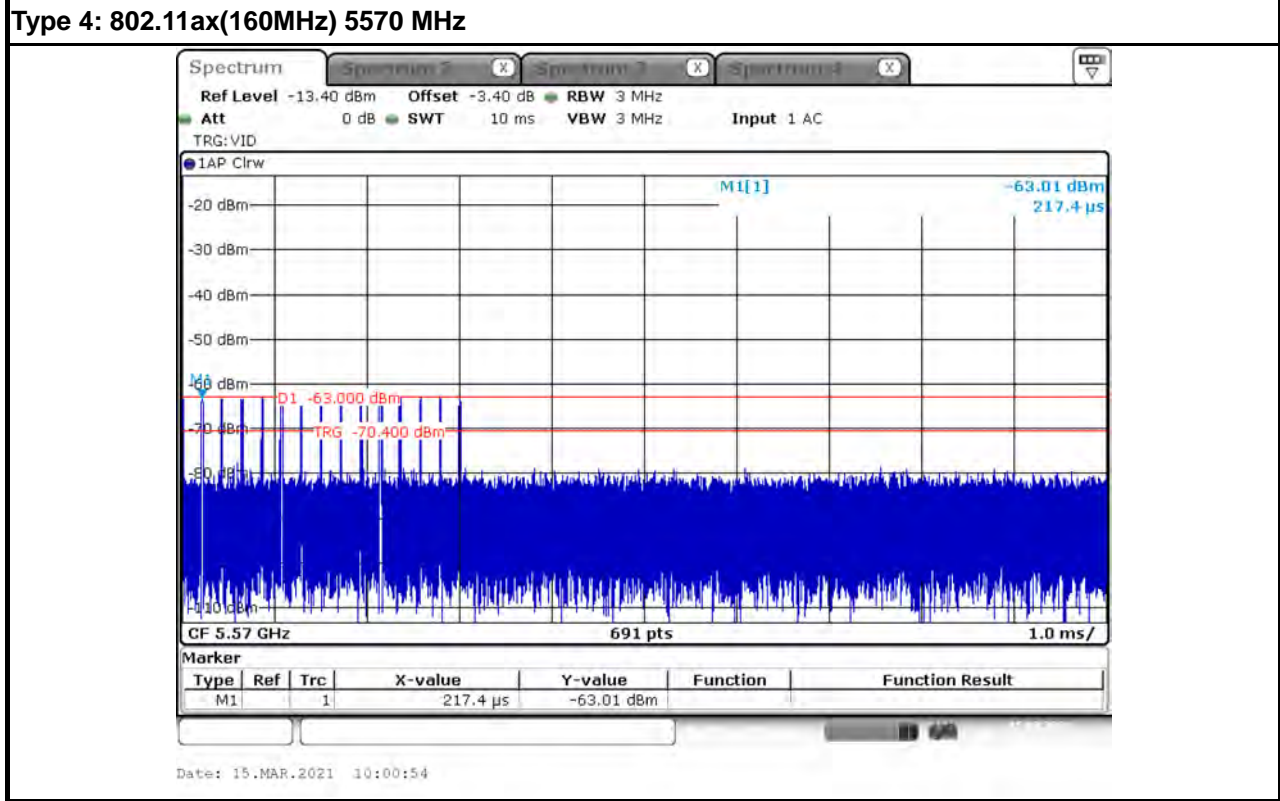



2.2.12 Data traffic Plot

AP Mode

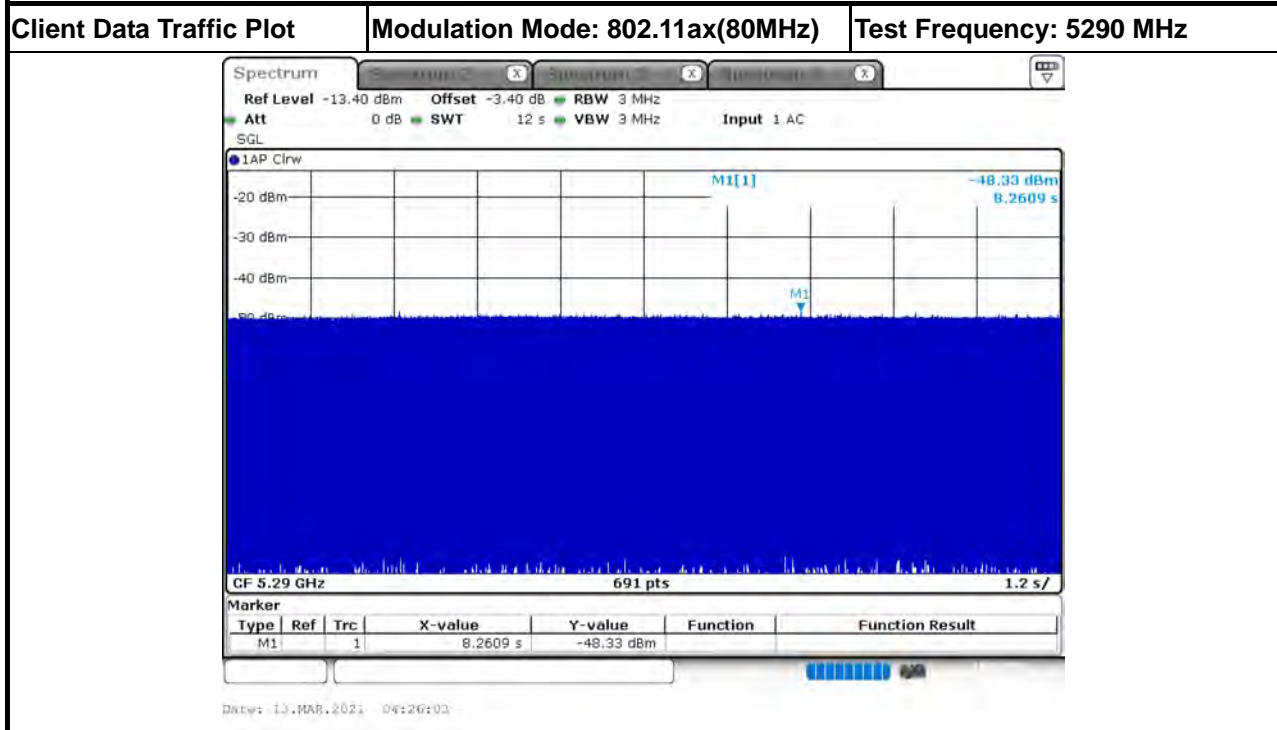
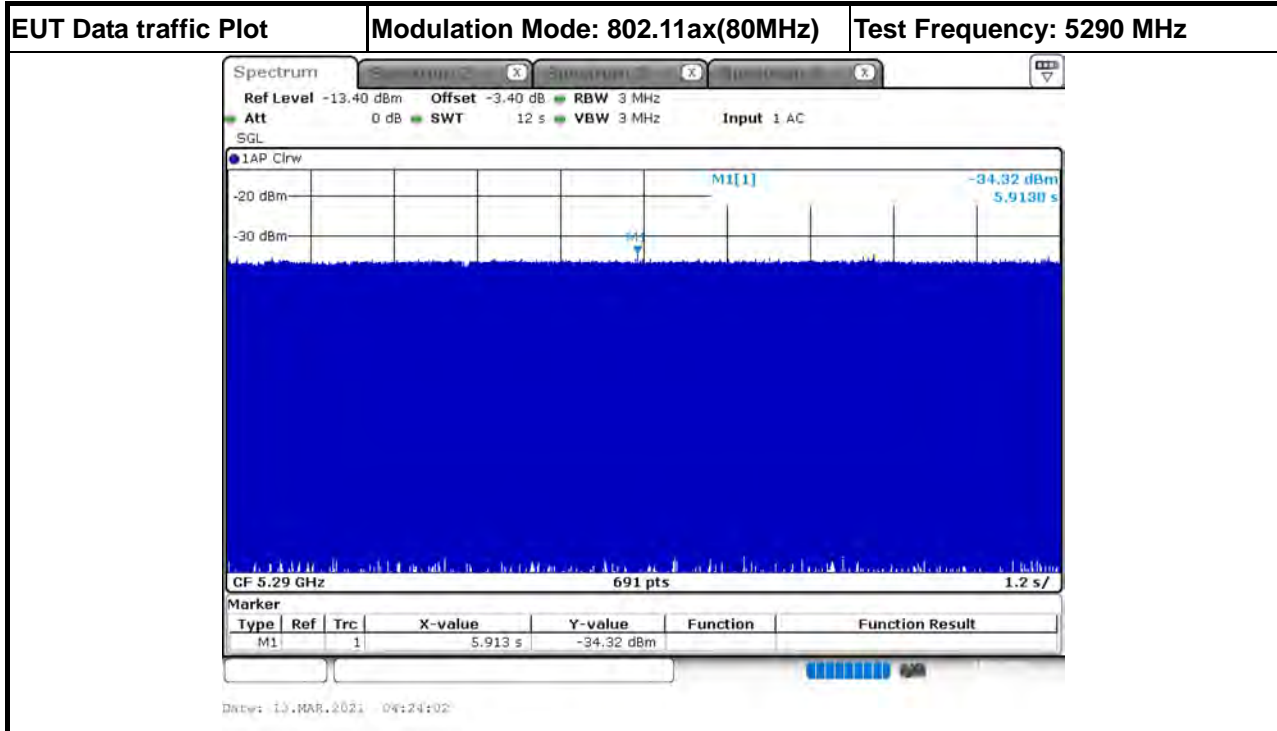

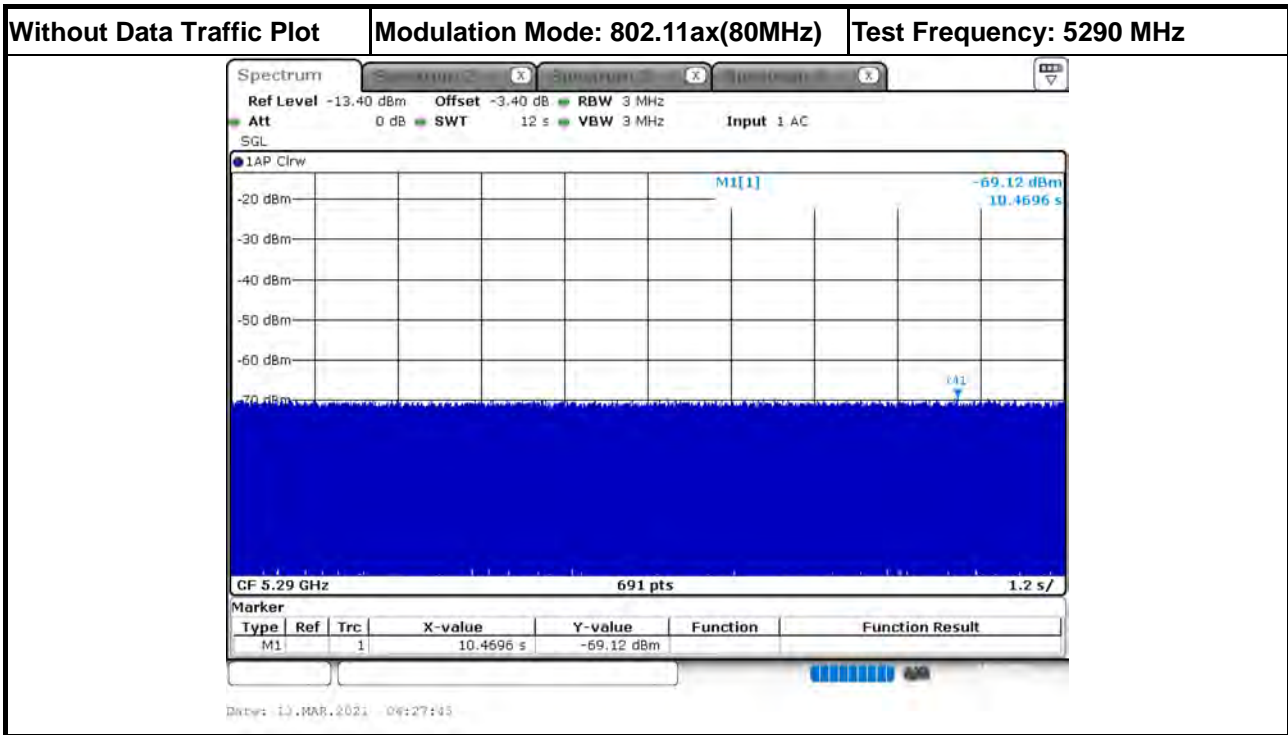

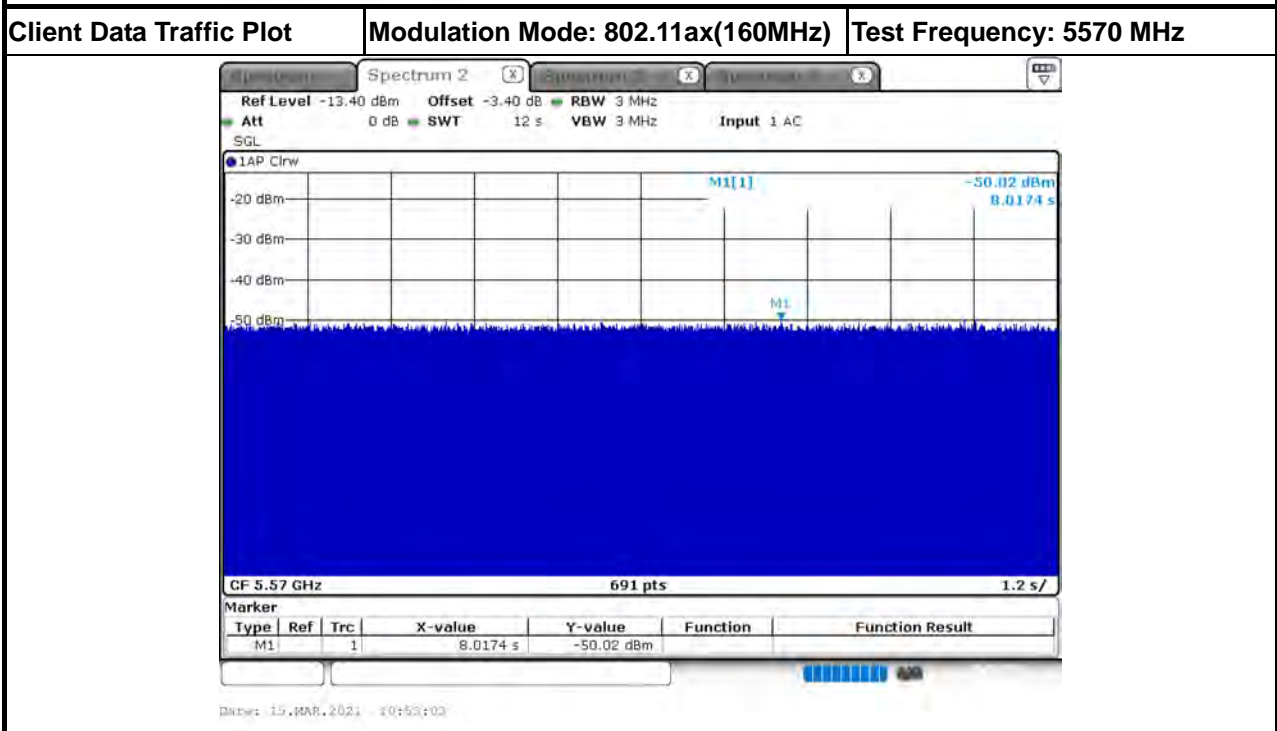
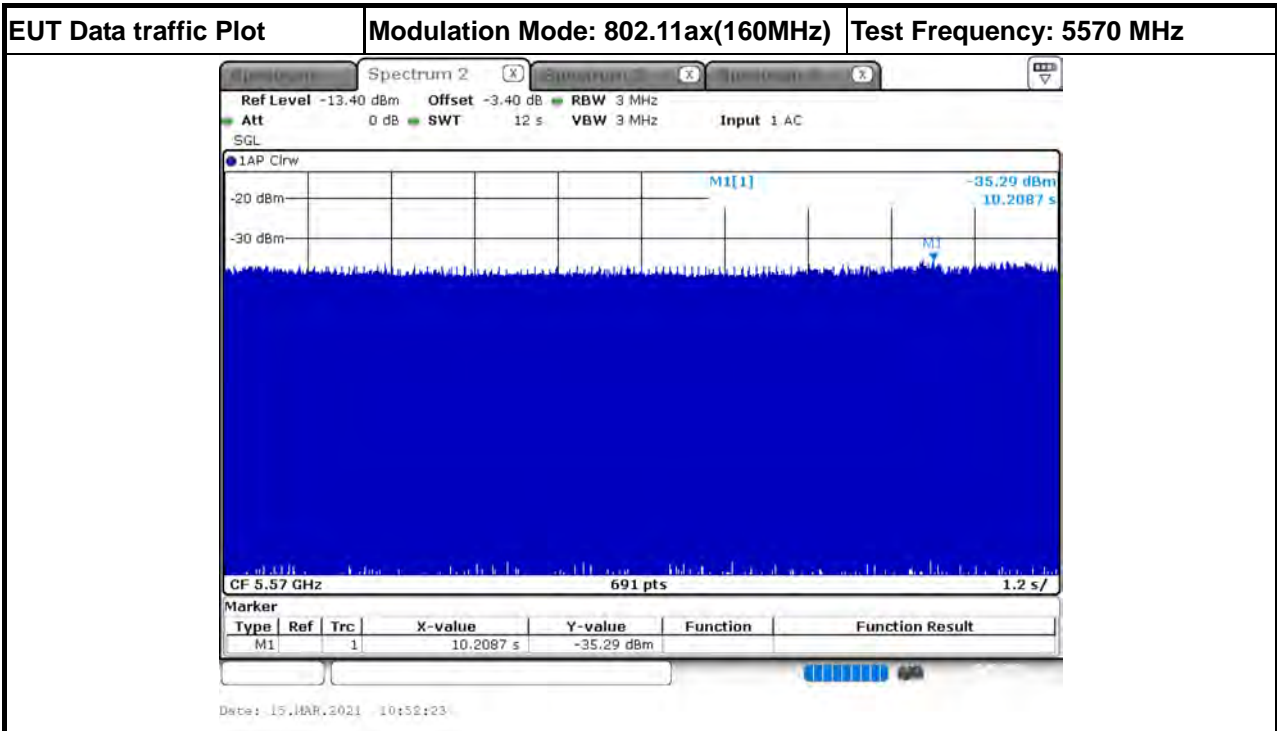

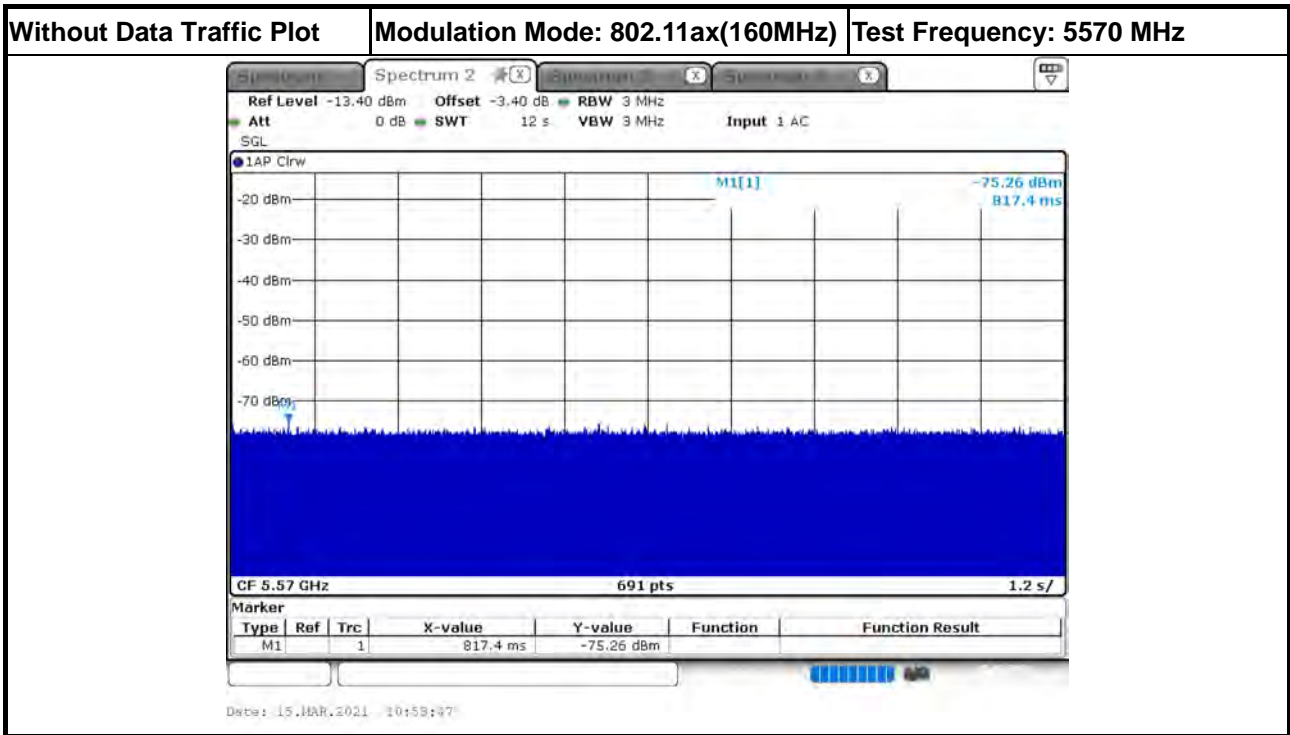



2.2.13 Channel Loading

System testing will be performed with channel-loading using means appropriate to the data types that are used by the unlicensed device. The following requirements apply:

1. The data file must be of a type that is typical for the device (i.e., MPEG-2, MPEG-4, WAV, MP3, MP4, AVI, etc.) and must generally be transmitting in a streaming mode.
2. Software to ping the client is permitted to simulate data transfer but must have random ping intervals.
3. Timing plots are required with calculations demonstrating a minimum channel loading of approximately 17% or greater. For example, you can zero span the spectrum analyzer and approximate the transmission time.
4. Unicast or Multicast protocols are preferable but other protocols may be used. The appropriate protocol used must be described in the test procedures.

<input checked="" type="checkbox"/>	IP Based (Load Based) – stream the test file form the Master to the Client.
<input type="checkbox"/>	The data file (MPEG-4) has been transmitting in a streaming mode.
<input checked="" type="checkbox"/>	Software to ping the client is permitted to simulate data transfer with random ping intervals.
<input checked="" type="checkbox"/>	Minimum channel loading of approximately 17%.
<input type="checkbox"/>	Unicast protocol has been used.
<input type="checkbox"/>	Frame Based – stream the test file form the Master to the Client.
<input type="checkbox"/>	Fixd talk/listen ratio, set the ratio to 45%/55%.



AP Mode

Modulation Mode: 802.11ax(80MHz) Test Frequency: 5290 MHz

Loading

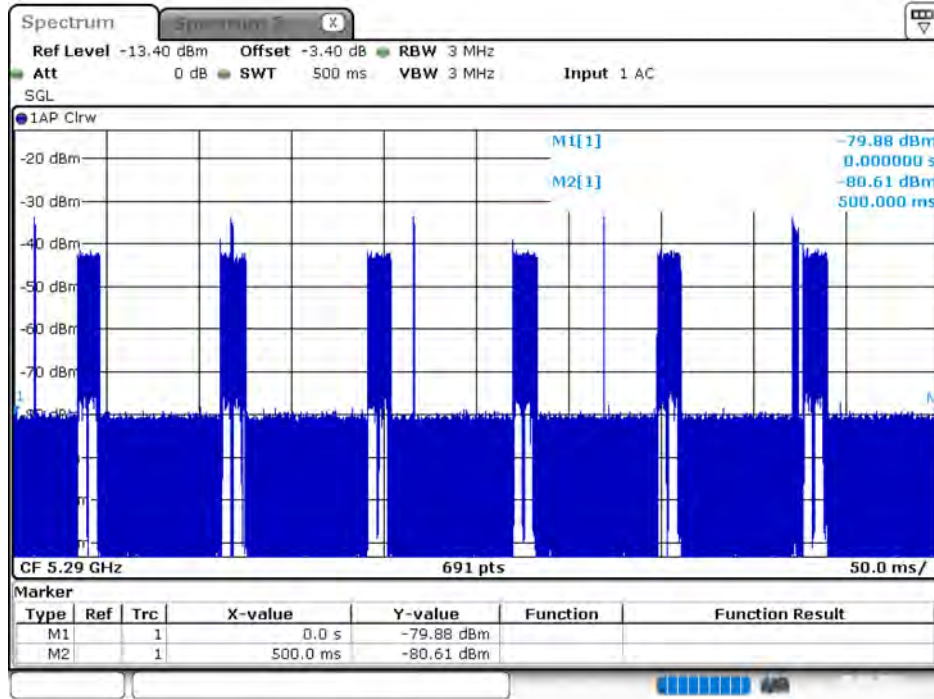

Date: 5.MAR.2021 09:28:28

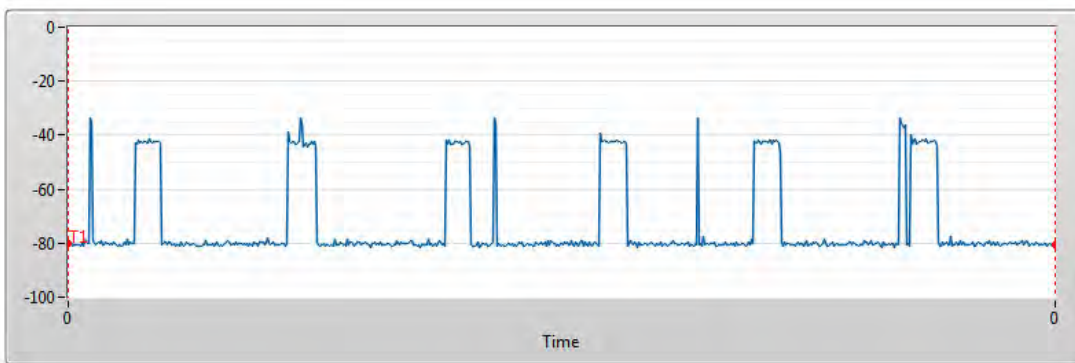

Sample Time	724.64us
All TX Time	89.13ms
All TX Sample	123
Duty Cycle	0.178003
T1[s]	T2[s]
0s	500ms
T3[s]	T4[s]
NaNs	NaNs



Modulation Mode: 802.11ax(160MHz) Test Frequency: 5570 MHz

Loading

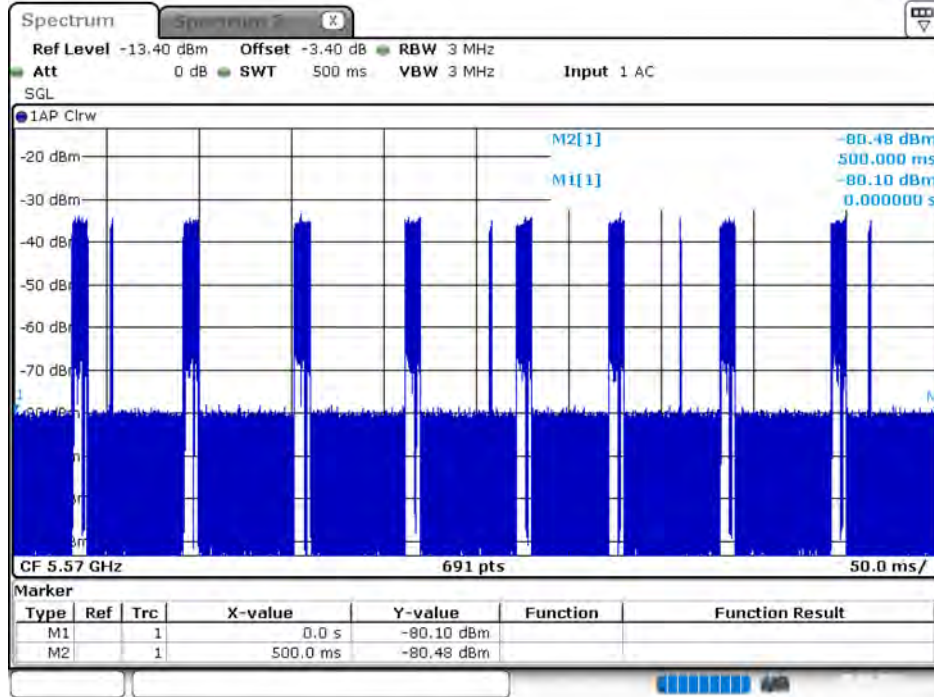

Date: 5.MAR.2021 03:05:23

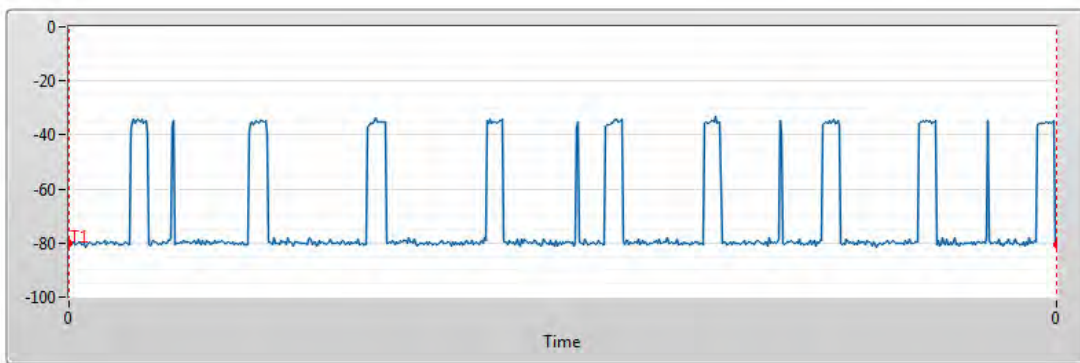

Sample Time	724.64us
All TX Time	85.51ms
All TX Sample	118
Duty Cycle	0.170767
T1[s]	T2[s]
0s	500ms
T3[s]	T4[s]
NaNs	NaNs



Extender mode

Modulation Mode: 802.11ax(160MHz) Test Frequency: 5570 MHz

Loading

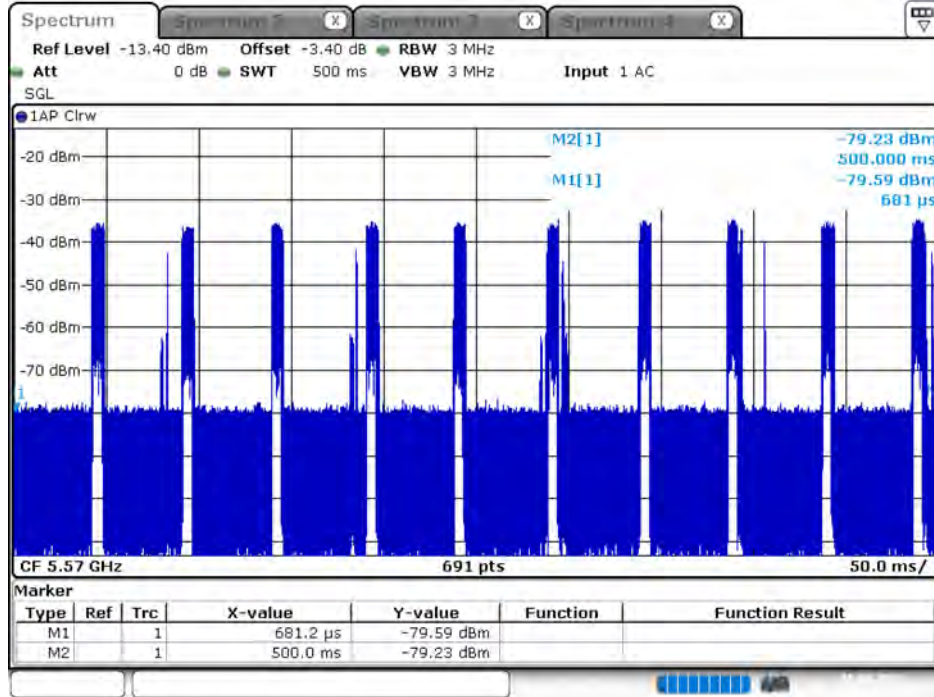

Date: 15.MAR.2021 09:35:17

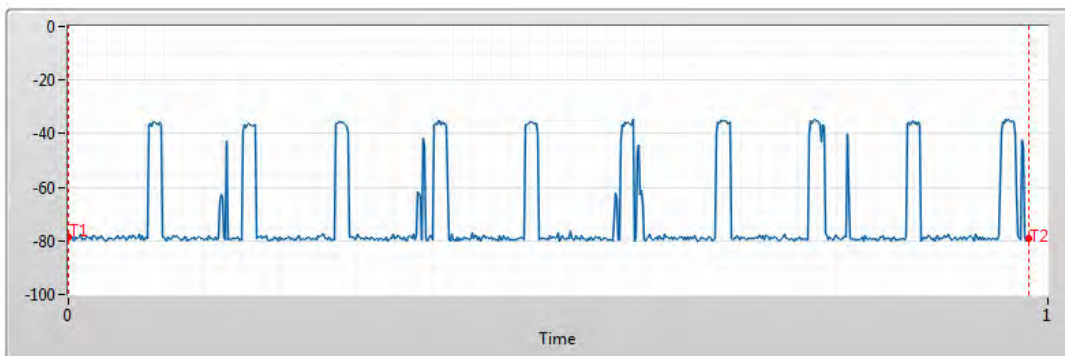

Sample Time	724.64us
All TX Time	89.86ms
All TX Sample	124
Duty Cycle	0.17945
T1[s]	T2[s]
0s	500ms
T3[s]	T4[s]
NaNs	NaNs



2.3 UNII Detection Bandwidth

2.3.1 UNII Detection Bandwidth Limit

Minimum 100% of the UNII 99% transmission power bandwidth. During the U-NII Detection Bandwidth detection test, radar type 0 is used and for each frequency step the minimum percentage of detection is 90 percent. Measurements are performed with no data traffic

2.3.2 Test Procedures

1. Adjust the equipment to produce a single Burst of the Short Pulse Radar Type 0 at the center frequency of the UUT Operating Channel at the specified DFS Detection Threshold level.
2. The generating equipment is configured as shown in the Radiated Test Setup above section 2.2.8 (2).
3. The UUT is set up as a stand-alone device (no associated Client and no traffic). Frame based systems will be set to a talk/listen ratio of 0%/100% during this test.
4. Generate single radar Burst, and note the response of the UUT. Repeat for a minimum of 10 trials.
The UUT must detect the Radar Waveform using the specified U-NII Detection Bandwidth criterion.
5. Starting at the center frequency of the UUT operating Channel, increase the radar frequency in 5 MHz steps, repeating the above item 4 test sequence, until the detection rate falls below the U-NII Detection Bandwidth criterion. Repeat this measurement in 1MHz steps at frequencies 5 MHz below where the detection rate begins to fall. Record the highest frequency (denote as FH) at which detection is greater than or equal to the U-NII Detection Bandwidth criterion. Recording the detection rate at frequencies above FH is not required to demonstrate compliance.
6. Starting at the center frequency of the UUT operating Channel, decrease the radar frequency in 5 MHz steps, repeating the above item 4 test sequence, until the detection rate falls below the U-NII Detection Bandwidth criterion. Repeat this measurement in 1MHz steps at frequencies 5 MHz above where the detection rate begins to fall. Record the lowest frequency (denote as FL) at which detection is greater than or equal to the U-NII Detection Bandwidth criterion. Recording the detection rate at frequencies below FL is not required to demonstrate compliance.
7. The U-NII Detection Bandwidth is calculated as follows: $U\text{-NII Detection Bandwidth} = FH - FL$
8. The U-NII Detection Bandwidth must be at least 100% of the UUT transmitter 99% power, otherwise, the UUT does not comply with DFS requirements.



2.3.3 Test Result of UNII Detection Bandwidth

AP Router mode

For 802.11ax(20MHz) / CH60

EUT Frequency=5300 MHz												
Channel Bandwidth (MHz)	20											
Radar Frequency (MHz)	DFS Detection Trials (1=Detection, 0= No Detection)										Detection Rate (%)	
	1	2	3	4	5	6	7	8	9	10		
5290	0	0	0	0	0	0	0	0	0	0	0	0
5290.3(FL)	1	0	1	1	1	1	1	1	1	1	1	90
5291	1	0	1	1	1	1	1	1	1	1	1	90
5292	1	1	1	1	1	1	1	1	1	1	1	100
5293	1	1	1	1	1	1	1	1	1	1	1	100
5294	1	1	1	1	1	1	1	1	1	1	1	100
5295	1	1	1	1	1	1	1	1	1	1	1	100
5300	1	1	1	1	1	1	1	1	1	1	1	100
5305	1	1	1	1	1	1	1	1	1	1	1	100
5306	1	1	1	1	1	1	1	1	1	1	1	100
5307	1	1	1	1	1	1	1	1	1	1	1	100
5308	1	1	1	1	1	1	1	1	1	1	1	100
5309	1	1	1	1	1	1	1	1	1	1	1	100
5309.7(FH)	1	1	1	0	1	1	1	1	1	1	1	90
5310	0	0	0	0	0	0	0	0	0	0	0	0
Radar Type 0-Detection Bandwidth (MHz) = (FH-FL) = (5309.7MHz-5290.3MHz)=											19.4	
UUT 99% Bandwidth (MHz) =											see note	
UNII Detection Bandwidth Min. Limit (MHz) = 19.363MHz											19.4	

Note:

All UNII channels for this device have identical Channel bandwidths. Therefore, all DFS testing was done at 5300 MHz. The 99% channel bandwidth is 19.363MHz.



For 802.11ax(40MHz) / CH62

EUT Frequency=5310 MHz												
Channel Bandwidth (MHz)	40											
Radar Frequency (MHz)	DFS Detection Trials (1=Detection, 0= No Detection)										Detection Rate (%)	
	1	2	3	4	5	6	7	8	9	10		
5290	0	0	0	0	0	0	0	0	0	0	0	0
5291(FL)	1	1	1	1	1	1	1	0	1	1	1	90
5292	1	1	1	1	1	1	1	1	1	1	1	100
5293	1	1	1	1	1	1	1	1	1	1	1	100
5294	1	1	1	1	1	1	1	1	1	1	1	100
5295	1	1	1	1	1	1	1	1	1	1	1	100
5300	1	1	1	1	1	1	1	1	1	1	1	100
5305	1	1	1	1	1	1	1	1	1	1	1	100
5310	1	1	1	1	1	1	1	1	1	1	1	100
5315	1	1	1	1	1	1	1	1	1	1	1	100
5320	1	1	1	1	1	1	1	1	1	1	1	100
5325	1	1	1	1	1	1	1	1	1	1	1	100
5326	1	1	1	1	1	1	1	1	1	1	1	100
5327	1	1	1	1	1	1	1	1	1	1	1	100
5328	1	1	1	1	1	1	1	1	1	1	1	100
5329	1	1	1	1	1	1	1	1	1	1	1	100
5330(FH)	1	1	1	1	1	1	1	1	1	1	0	90
5331	0	0	0	0	0	0	0	0	0	0	0	0
Radar Type 0-Detection Bandwidth (MHz) = (FH-FL) = (5330MHz-5291MHz)=											39	
UUT 99% Bandwidth (MHz) =											see note	
UNII Detection Bandwidth Min. Limit (MHz) = 37.771MHz											38	

Note:

All UNII channels for this device have identical Channel bandwidths. Therefore, all DFS testing was done at 5310 MHz. The 99% channel bandwidth is 37.771MHz.



For 802.11ax(80MHz) / CH58

EUT Frequency=5290 MHz												
Channel Bandwidth (MHz)	80											
Radar Frequency (MHz)	DFS Detection Trials (1=Detection, 0= No Detection)										Detection Rate (%)	
	1	2	3	4	5	6	7	8	9	10		
5250	0	0	0	0	0	0	0	0	0	0	0	0
5251(FL)	1	1	0	1	1	1	1	1	1	1	1	90
5252	1	1	1	1	1	1	1	1	1	1	1	100
5253	1	1	1	1	1	1	1	1	1	1	1	100
5254	1	1	1	1	1	1	1	1	1	1	1	100
5255	1	1	1	1	1	1	1	1	1	1	1	100
5260	1	1	1	1	1	1	1	1	1	1	1	100
5265	1	1	1	1	1	1	1	1	1	1	1	100
5270	1	1	1	1	1	1	1	1	1	1	1	100
5275	1	1	1	1	1	1	1	1	1	1	1	100
5280	1	1	1	1	1	1	1	1	1	1	1	100
5285	1	1	1	1	1	1	1	1	1	1	1	100
5290	1	1	1	1	1	1	1	1	1	1	1	100
5295	1	1	1	1	1	1	1	1	1	1	1	100
5300	1	1	1	1	1	1	1	1	1	1	1	100
5305	1	1	1	1	1	1	1	1	1	1	1	100
5310	1	1	1	1	1	1	1	1	1	1	1	100
5315	1	1	1	1	1	1	1	1	1	1	1	100
5320	1	1	1	1	1	1	1	1	1	1	1	100
5325	1	1	1	1	1	1	1	1	1	1	1	100
5326	1	1	1	1	1	1	1	1	1	1	1	100
5327	1	1	1	1	1	1	1	1	1	1	1	100
5328	1	1	1	1	1	1	1	1	1	1	1	100
5329(FH)	1	1	1	1	1	1	0	1	1	1	1	90
5330	0	0	0	0	0	0	0	0	0	0	0	0
Radar Type 0-Detection Bandwidth (MHz) = (FH-FL) = (5329MHz-5251MHz)=											78	
UUT 99% Bandwidth (MHz) =											see note	
UNII Detection Bandwidth Min. Limit (MHz) = 76.700MHz											77	

Note:

All UNII channels for this device have identical Channel bandwidths. Therefore, all DFS testing was done at 5290 MHz. The 99% channel bandwidth is 76.700MHz.



For 802.11ax(20MHz) / CH100

EUT Frequency=5500 MHz												
Channel Bandwidth (MHz)	20											
Radar Frequency (MHz)	DFS Detection Trials (1=Detection, 0= No Detection)										Detection Rate (%)	
	1	2	3	4	5	6	7	8	9	10		
5490	0	0	0	0	0	0	0	0	0	0	0	0
5490.5(FL)	1	1	1	0	1	1	1	1	1	1	1	90
5491	1	1	1	1	1	1	1	1	1	1	1	100
5492	1	1	1	1	1	1	1	1	1	1	1	100
5493	1	1	1	1	1	1	1	1	1	1	1	100
5494	1	1	1	1	1	1	1	1	1	1	1	100
5495	1	1	1	1	1	1	1	1	1	1	1	100
5500	1	1	1	1	1	1	1	1	1	1	1	100
5505	1	1	1	1	1	1	1	1	1	1	1	100
5506	1	1	1	1	1	1	1	1	1	1	1	100
5507	1	1	1	1	1	1	1	1	1	1	1	100
5508	1	1	1	1	1	1	1	1	1	1	1	100
5509	1	1	1	1	1	1	1	1	1	1	1	100
5509.8(FH)	1	1	1	0	1	1	1	1	1	1	1	90
5510	0	0	0	0	0	0	0	0	0	0	0	0
Radar Type 0-Detection Bandwidth (MHz) = (FH-FL) = (5509.8MHz-5490.5MHz)=											19.3	
UUT 99% Bandwidth (MHz) =											see note	
UNII Detection Bandwidth Min. Limit (MHz) = 19.276MHz											19.3	

Note:

All UNII channels for this device have identical Channel bandwidths. Therefore, all DFS testing was done at 5500 MHz. The 99% channel bandwidth is 19.276MHz.



For 802.11ax(40MHz) / CH102

EUT Frequency=5510 MHz												
Channel Bandwidth (MHz)	40											
Radar Frequency (MHz)	DFS Detection Trials (1=Detection, 0= No Detection)										Detection Rate (%)	
	1	2	3	4	5	6	7	8	9	10		
5490	0	0	0	0	0	0	0	0	0	0	0	0
5491(FL)	1	1	1	1	1	1	0	1	1	1	1	90
5492	1	1	1	1	1	1	1	1	1	1	1	100
5493	1	1	1	1	1	1	1	1	1	1	1	100
5494	1	1	1	1	1	1	1	1	1	1	1	100
5495	1	1	1	1	1	1	1	1	1	1	1	100
5500	1	1	1	1	1	1	1	1	1	1	1	100
5505	1	1	1	1	1	1	1	1	1	1	1	100
5510	1	1	1	1	1	1	1	1	1	1	1	100
5515	1	1	1	1	1	1	1	1	1	1	1	100
5520	1	1	1	1	1	1	1	1	1	1	1	100
5525	1	1	1	1	1	1	1	1	1	1	1	100
5526	1	1	1	1	1	1	1	1	1	1	1	100
5527	1	1	1	1	1	1	1	1	1	1	1	100
5528	1	1	1	1	1	1	1	1	1	1	1	100
5529(FH)	1	1	1	1	0	1	1	1	1	1	1	90
5530	0	0	0	0	0	0	0	0	0	0	0	0
Radar Type 0-Detection Bandwidth (MHz) = (FH-FL) = (5529MHz-5491MHz)=											38	
UUT 99% Bandwidth (MHz) =											see note	
UNII Detection Bandwidth Min. Limit (MHz) = 37.481MHz											38	

Note:

All UNII channels for this device have identical Channel bandwidths. Therefore, all DFS testing was done at 5510 MHz. The 99% channel bandwidth is 37.481MHz.



For 802.11ax(80MHz) / CH106

EUT Frequency=5530 MHz												
Channel Bandwidth (MHz)	80											
Radar Frequency (MHz)	DFS Detection Trials (1=Detection, 0= No Detection)										Detection Rate (%)	
	1	2	3	4	5	6	7	8	9	10		
5490	0	0	0	0	0	0	0	0	0	0	0	0
5491(FL)	1	0	1	1	1	1	1	1	1	1	1	90
5492	1	1	1	1	1	1	1	1	1	1	1	100
5493	1	1	1	1	1	1	1	1	1	1	1	100
5494	1	1	1	1	1	1	1	1	1	1	1	100
5495	1	1	1	1	1	1	1	1	1	1	1	100
5500	1	1	1	1	1	1	1	1	1	1	1	100
5505	1	1	1	1	1	1	1	1	1	1	1	100
5510	1	1	1	1	1	1	1	1	1	1	1	100
5515	1	1	1	1	1	1	1	1	1	1	1	100
5520	1	1	1	1	1	1	1	1	1	1	1	100
5525	1	1	1	1	1	1	1	1	1	1	1	100
5530	1	1	1	1	1	1	1	1	1	1	1	100
5535	1	1	1	1	1	1	1	1	1	1	1	100
5540	1	1	1	1	1	1	1	1	1	1	1	100
5545	1	1	1	1	1	1	1	1	1	1	1	100
5550	1	1	1	1	1	1	1	1	1	1	1	100
5555	1	1	1	1	1	1	1	1	1	1	1	100
5560	1	1	1	1	1	1	1	1	1	1	1	100
5565	1	1	1	1	1	1	1	1	1	1	1	100
5566	1	1	1	1	1	1	1	1	1	1	1	100
5567	1	1	1	1	1	1	1	1	1	1	1	100
5568(FH)	1	1	1	0	1	1	1	1	1	1	1	90
5569	0	0	0	0	0	0	0	0	0	0	0	0
Radar Type 0-Detection Bandwidth (MHz) = (FH-FL) = (5568MHz-5491MHz)=											77	
UUT 99% Bandwidth (MHz) =											see note	
UNII Detection Bandwidth Min. Limit (MHz) = 76.700MHz											77	

Note:

All UNII channels for this device have identical Channel bandwidths. Therefore, all DFS testing was done at 5530 MHz. The 99% channel bandwidth is 76.700MHz.



For 802.11ax(160MHz) / CH114

EUT Frequency= 5570 MHz												
Channel Bandwidth (MHz)	160											
Radar Frequency (MHz)	DFS Detection Trials (1=Detection, 0= No Detection)										Detection Rate (%)	
	1	2	3	4	5	6	7	8	9	10		
5491	0	0	0	0	0	0	0	0	0	0	0	0
5492(FL)	1	1	1	1	1	1	1	1	0	1	90	
5493	1	1	1	1	1	1	1	1	1	1	100	
5494	1	1	1	1	1	1	1	1	1	1	100	
5495	1	1	1	1	1	1	1	1	1	1	100	
5500	1	1	1	1	1	1	1	1	1	1	100	
5505	1	1	1	1	1	1	1	1	1	1	100	
5510	1	1	1	1	1	1	1	1	1	1	100	
5515	1	1	1	1	1	1	1	1	1	1	100	
5520	1	1	1	1	1	1	1	1	1	1	100	
5525	1	1	1	1	1	1	1	1	1	1	100	
5530	1	1	1	1	1	1	1	1	1	1	100	
5535	1	1	1	1	1	1	1	1	1	1	100	
5540	1	1	1	1	1	1	1	1	1	1	100	
5545	1	1	1	1	1	1	1	1	1	1	100	
5550	1	1	1	1	1	1	1	1	1	1	100	
5555	1	1	1	1	1	1	1	1	1	1	100	
5560	1	1	1	1	1	1	1	1	1	1	100	
5565	1	1	1	1	1	1	1	1	1	1	100	
5570	1	1	1	1	1	1	1	1	1	1	100	
5575	1	1	1	1	1	1	1	1	1	1	100	
5580	1	1	1	1	1	1	1	1	1	1	100	
5585	1	1	1	1	1	1	1	1	1	1	100	
5590	1	1	1	1	1	1	1	1	1	1	100	
5595	1	1	1	1	1	1	1	1	1	1	100	
5600	1	1	1	1	1	1	1	1	1	1	100	
5605	1	1	1	1	1	1	1	1	1	1	100	
5610	1	1	1	1	1	1	1	1	1	1	100	
5615	1	1	1	1	1	1	1	1	1	1	100	
5620	1	1	1	1	1	1	1	1	1	1	100	
5625	1	1	1	1	1	1	1	1	1	1	100	
5630	1	1	1	1	1	1	1	1	1	1	100	
5635	1	1	1	1	1	1	1	1	1	1	100	
5640	1	1	1	1	1	1	1	1	1	1	100	
5645	1	1	1	1	1	1	1	1	1	1	100	
5646	1	1	1	1	1	1	1	1	1	1	100	
5647(FH)	1	1	1	1	1	1	1	0	1	1	90	
5648	0	0	0	0	0	0	0	0	0	0	0	
Radar Type 0-Detection Bandwidth (MHz) = (FH-FL) = (5647MHz-5492MHz)=											155	
UUT 99% Bandwidth (MHz) =											see note	
UNII Detection Bandwidth Min. Limit (MHz) = 154.124MHz											155	

Note:

All UNII channels for this device have identical Channel bandwidths. Therefore, all DFS testing was done at 5530 MHz. The 99% channel bandwidth is 154.124MHz.



2.4 Initial Channel Availability Check Time Measurement

2.4.1 Channel Availability Check Limit

The UUT shall perform a Channel Availability Check to ensure that there is no radar operating on the channel. After power-up sequence, receive at least 1 minute on the intended operating frequency.

2.4.2 Initial Channel Availability Check Time

Test Procedures

1. Set configuration as section 2.2.8 (2) and set spectrum analyzer as section 2.2.7.
2. Power on the UUT and measure T2 from spectrum. T2 is end CAC timing and start to link on DFS channel.
Use spectrum analyzer to monitor T1 & T2.
3. We inject radar at (T2-60) sec to insure that CAC time is not less than 60 sec.
4. We inject radar at (T2-61) sec to insure that CAC time is less than 61 sec.



Example of Initial Channel Availability Check Time

AP Mode

Illustration for confirming cac duration:

For 802.11ax(80MHz) / 5290 MHz

Step 1: We will inject radar at T2-60s to see if there is any transmission after T2, if it will stop transmission after T2, it can prove CAC= or > 60s

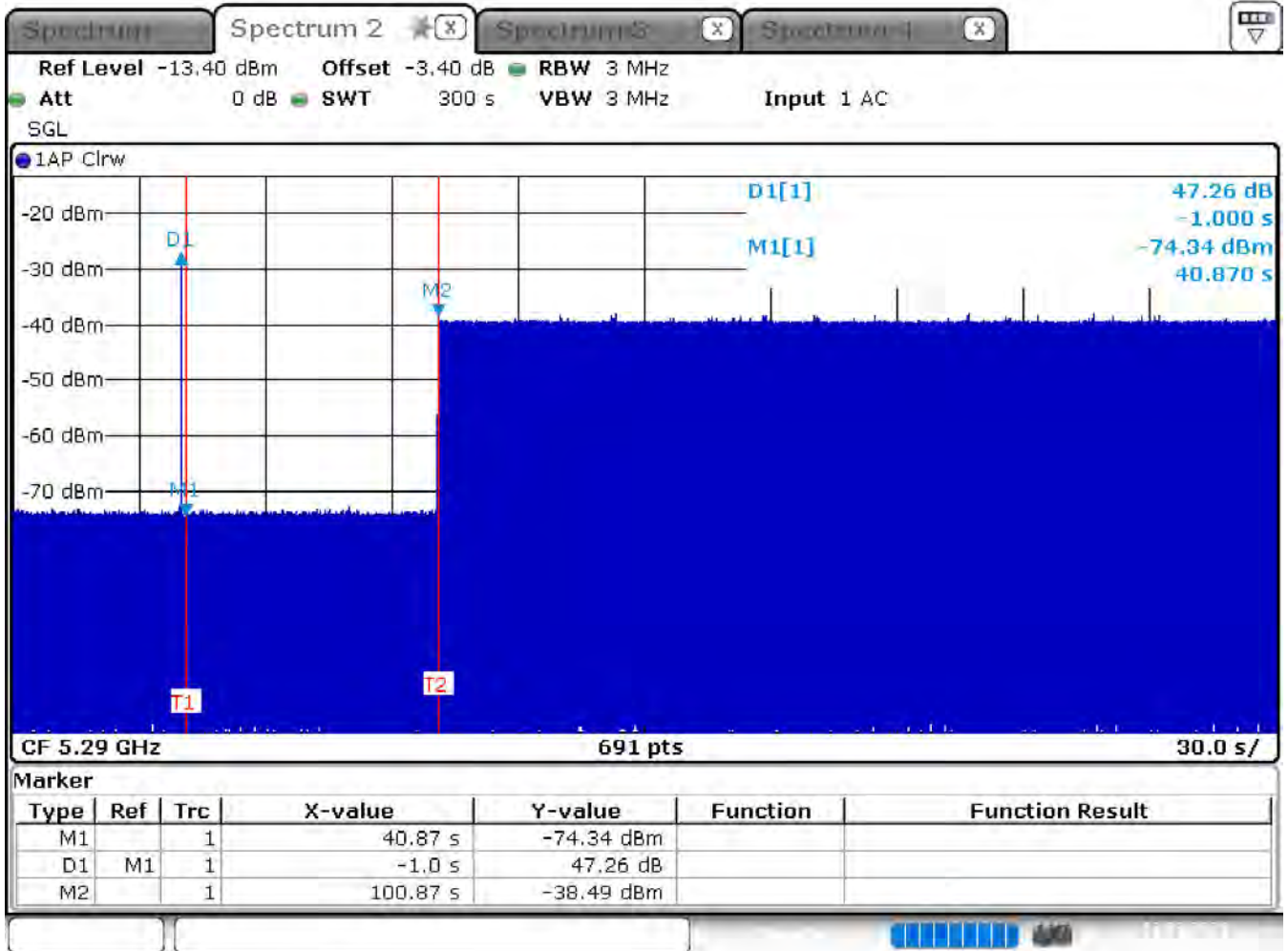

Date: 12.MAR.2021 10:27:49



Step 2: We will inject radar at T2-61s to see if there is any transmission after T2, if it will not stop transmission after T2, it can prove CAC < 61s

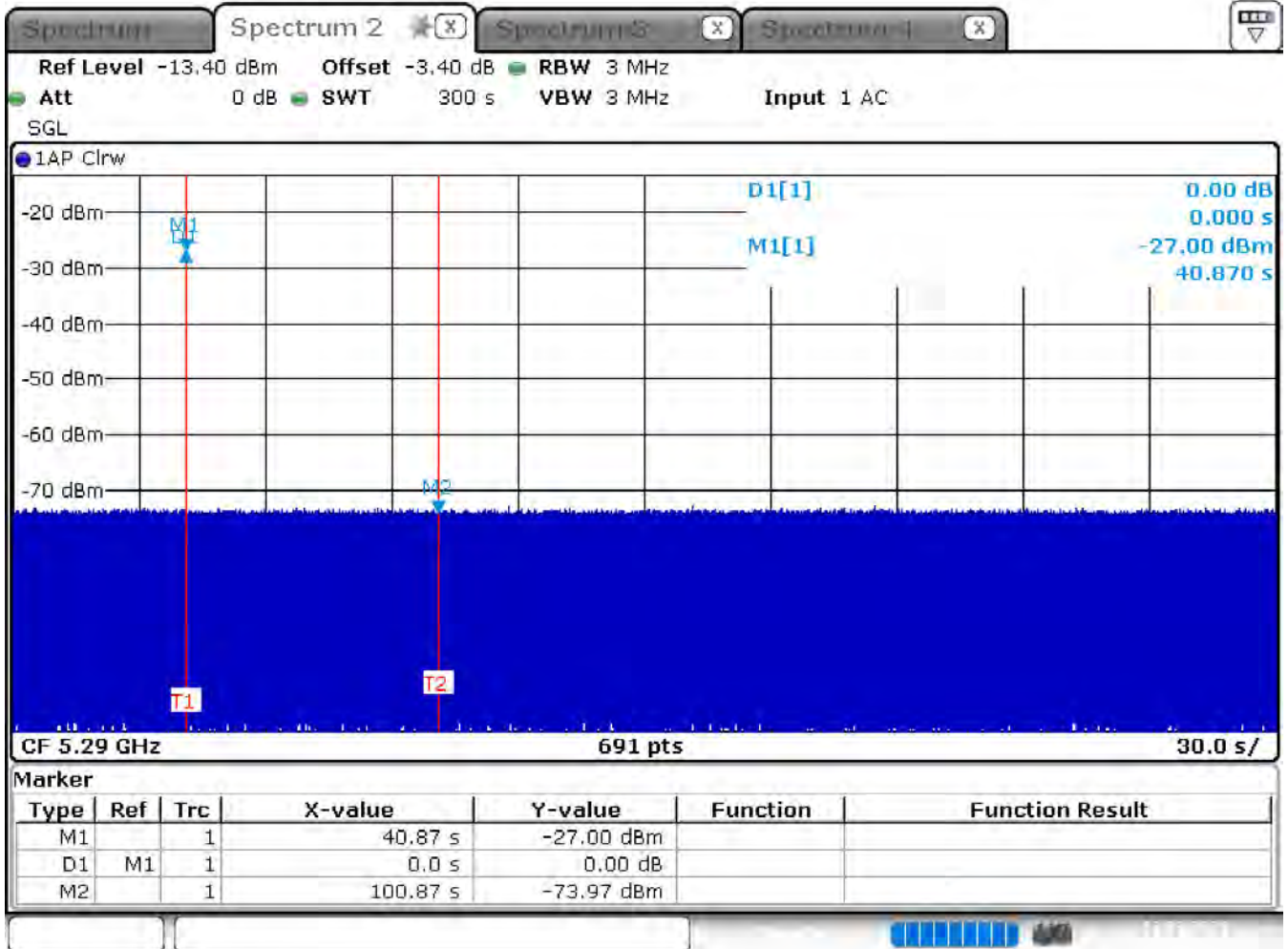

Date: 12.MAR.2021 10:37:32



For 802.11ax(160MHz) / 5570 MHz

Step 1: We will inject radar at T2-60s to see if there is any transmission after T2, if it will stop transmission after T2, it can prove CAC= or > 60s

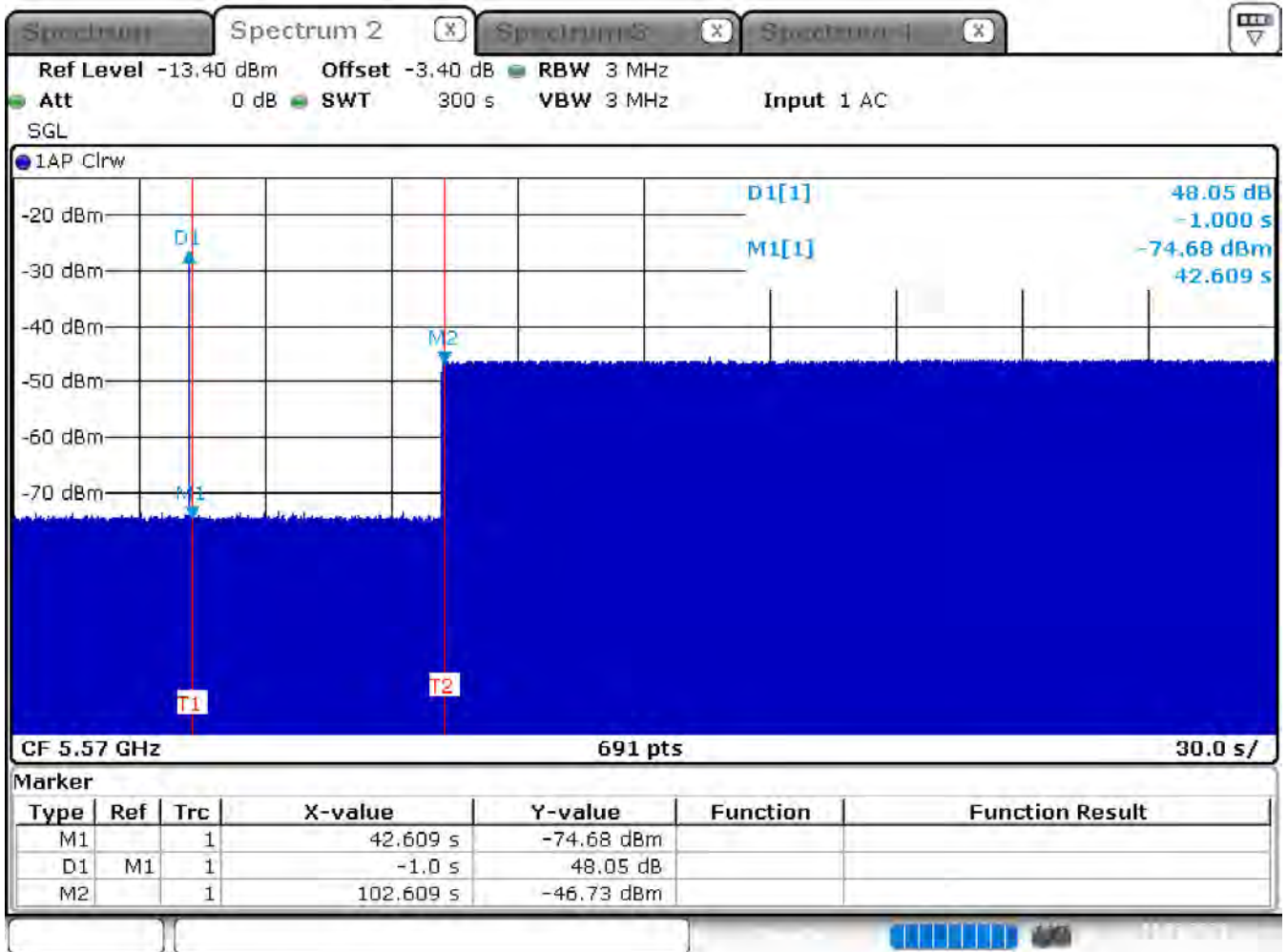

Date: 10.MAR.2021 10:30:14



Step 2: We will inject radar at T2-61s to see if there is any transmission after T2, if it will not stop transmission after T2, it can prove CAC < 61s

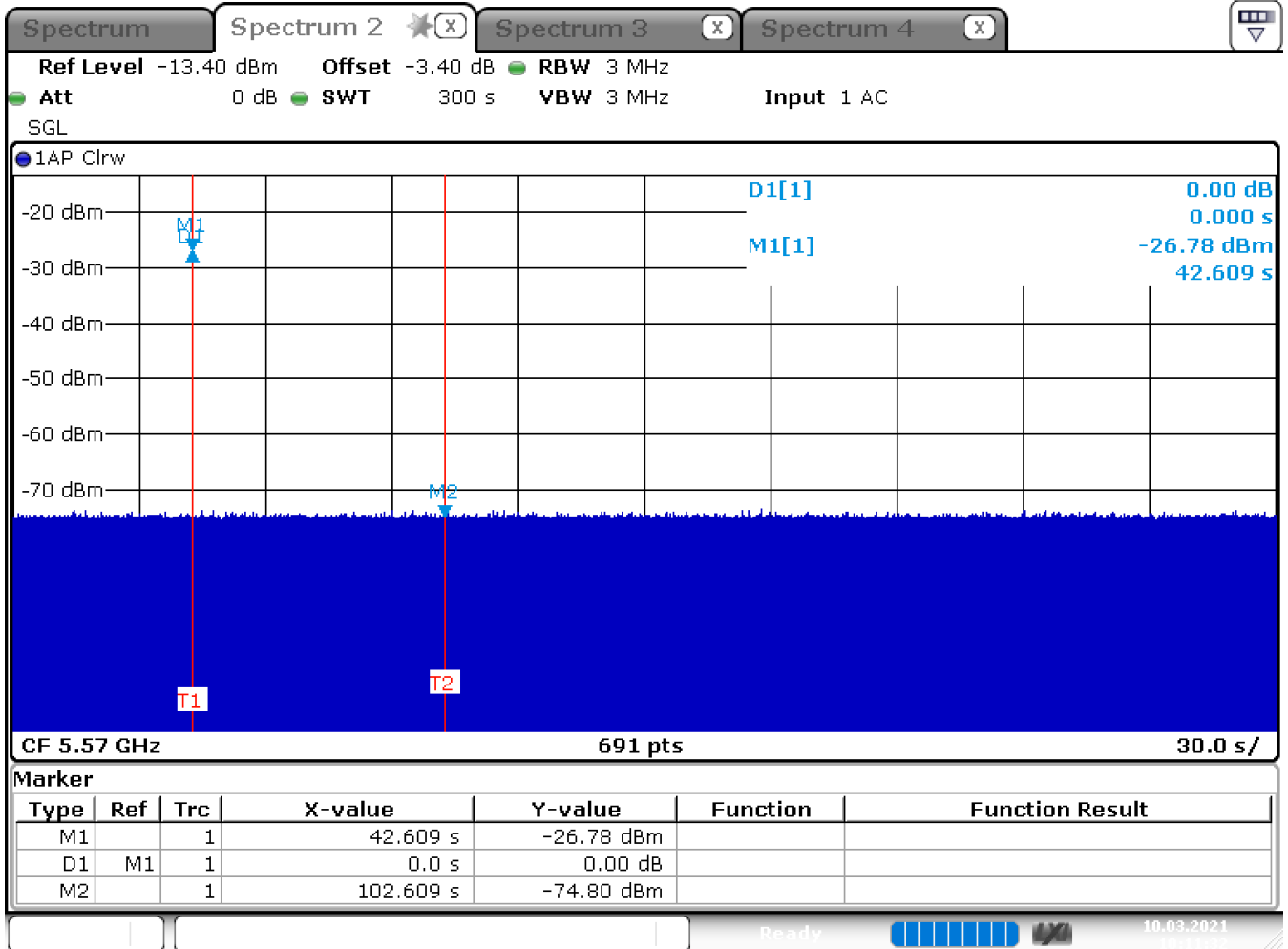

Date: 10.MAR.2021 10:11:33



2.4.3 Test Result of Initial Channel Availability Check Time

AP Mode

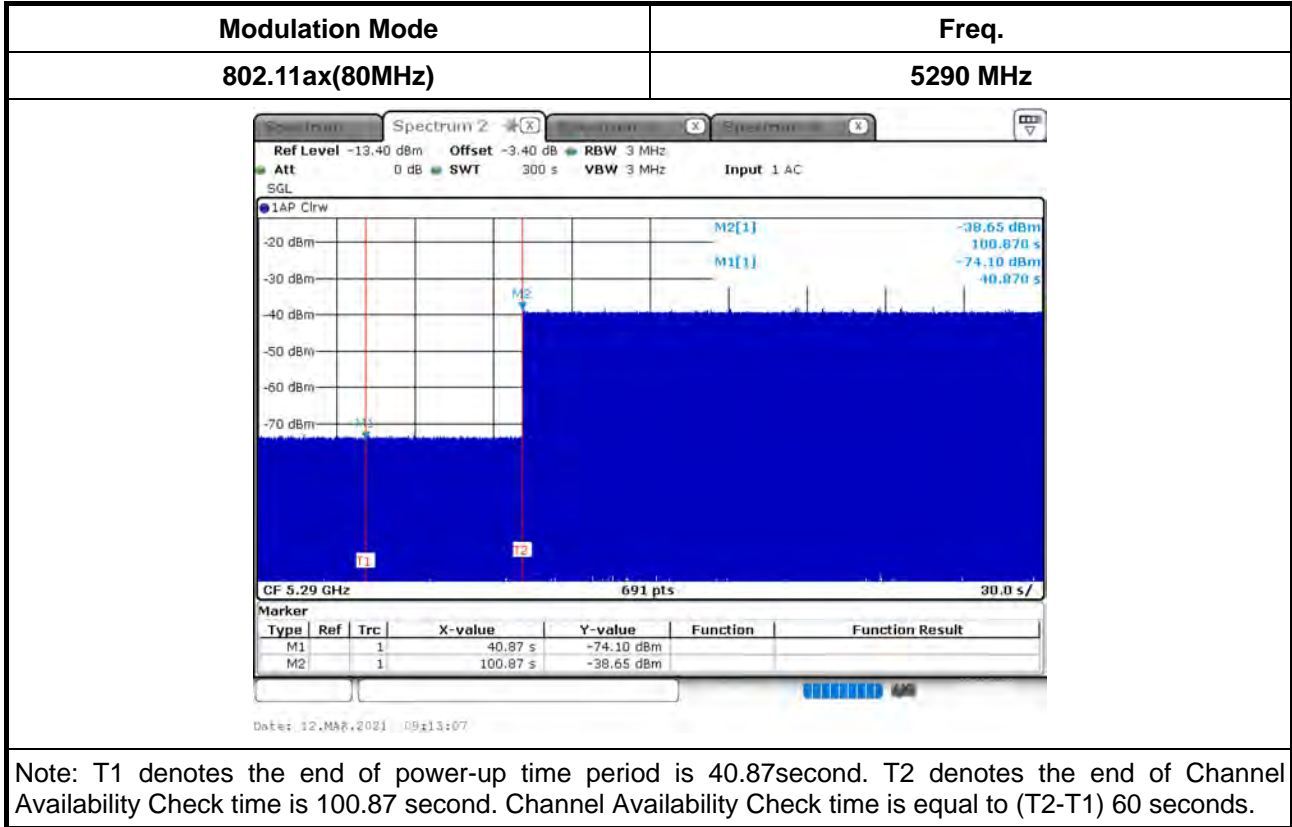

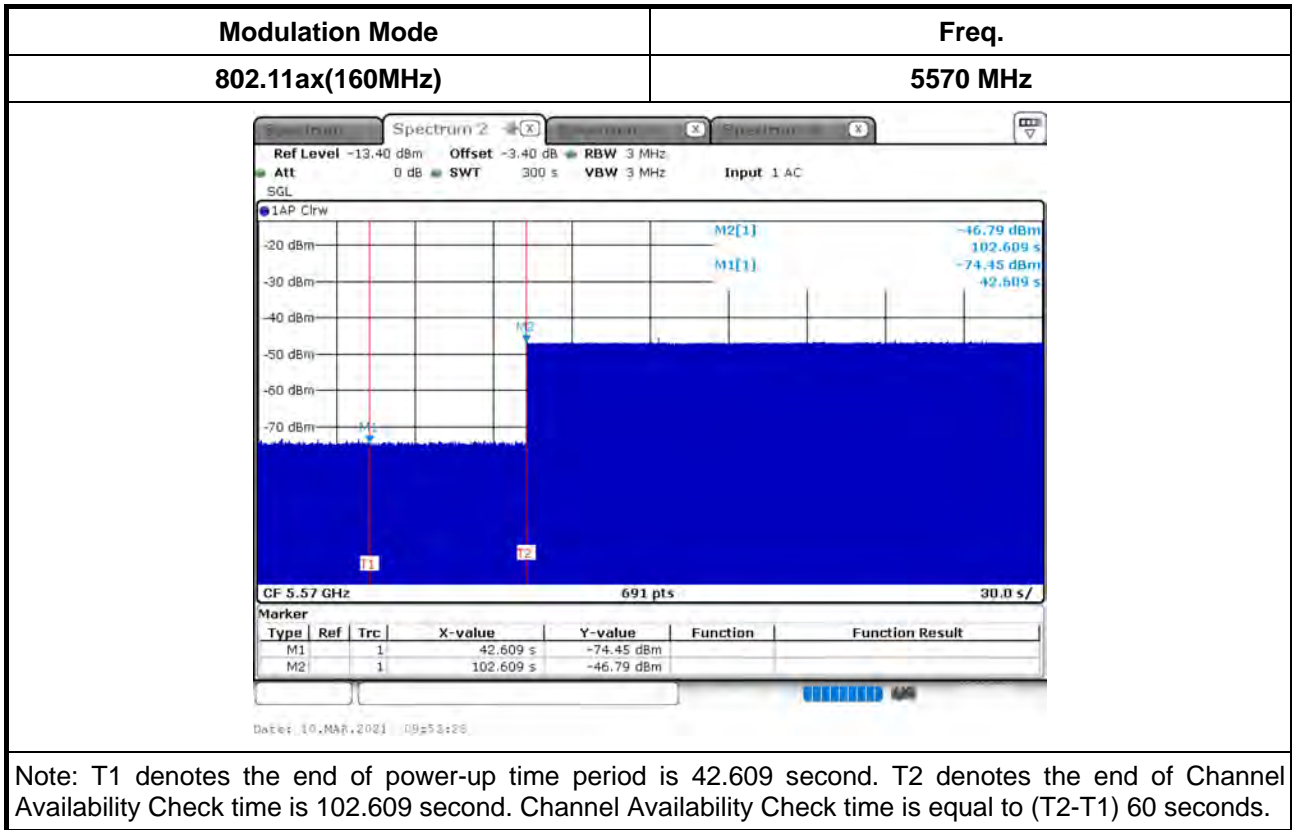



2.4.4 Beginning and End of the Channel Availability Check Time

Test Procedures

1. Set configuration as section 2.2.8 (1) and do DFS calibration, and then adjust attenuator to make sure that the threshold value of the reference test signal defined in table 3 is (-63dBm) at the UUT’s antenna port.
2. Set configuration as section 2.2.8 (2) and set spectrum analyzer as section 2.2.7
3. A single Burst of one of the Short Pulse Radar Types 0-4 will commence within a 6 second window starting at T1. (for beginning).
4. A single Burst of one of the Short Pulse Radar Types 0-4 will commence within a 6 second window starting at T1 + 54 seconds. (for end).
5. Verify that during the 2.5 minute measurement window no UUT transmissions occurred on Chr.
The Channel Availability Check results will be recorded.

2.4.5 Test Result of Channel Availability Check Time

Beginning & End of the Channel Availability Check Result				
Detection Threshold Level (dBm)	-63 (DFS Detection Threshold + 1 dB)			
Modulation Mode / Freq. (MHz)	Radar Test Signal	Beginning CAC of Timing of radar burst (sec)	End CAC of Timing of radar burst (sec)	DFS Triggered (Yes/No)
802.11ax(80MHz) 5290 MHz	Type 0	0-6	54-60	Yes
802.11ax(160MHz) 5570 MHz	Type 0	0-6	54-60	Yes



2.4.6 Test Result of Radar Burst at the Beginning of the Channel Availability Check Time

AP Mode

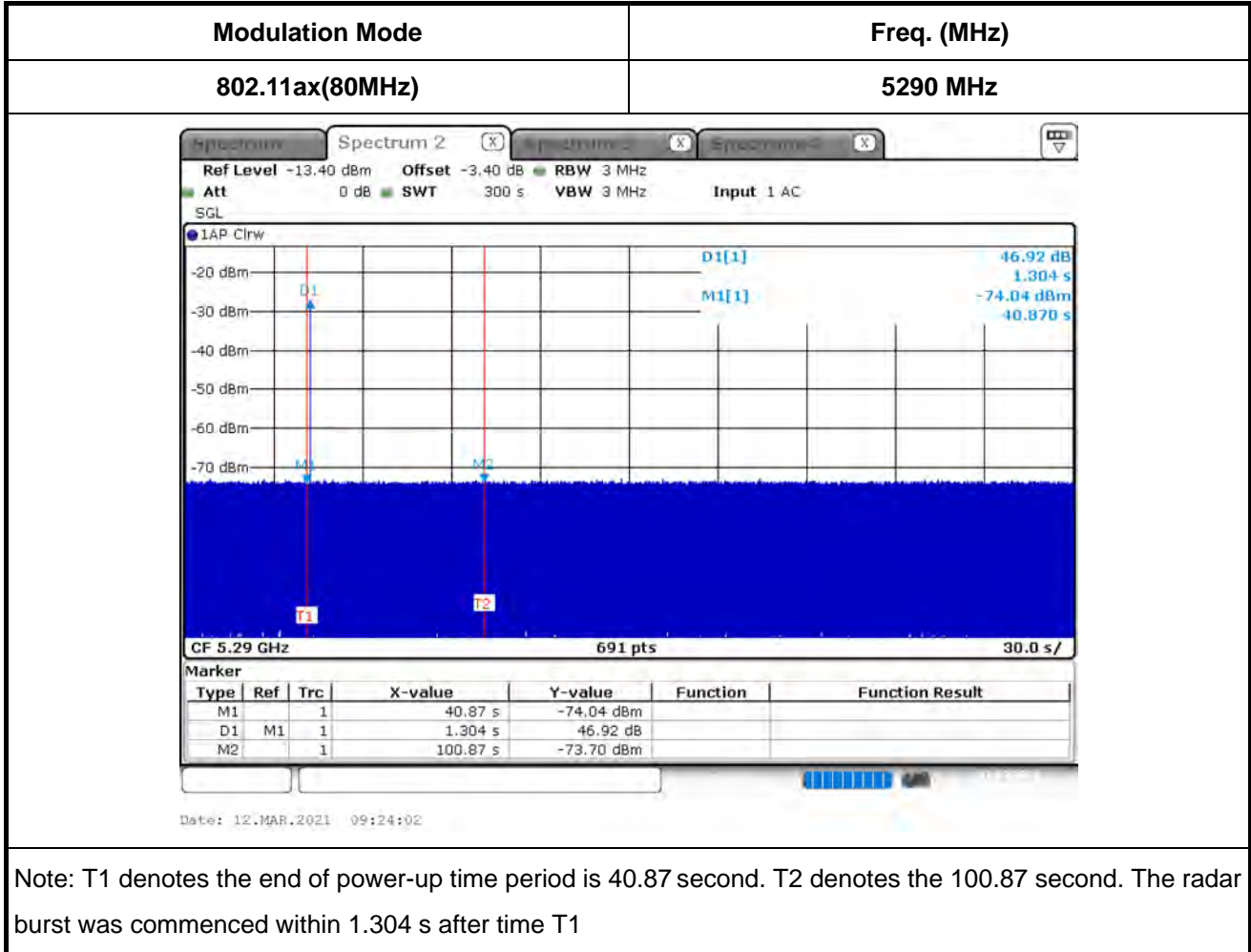



Modulation Mode	Freq. (MHz)
802.11ax(160MHz)	5570 MHz

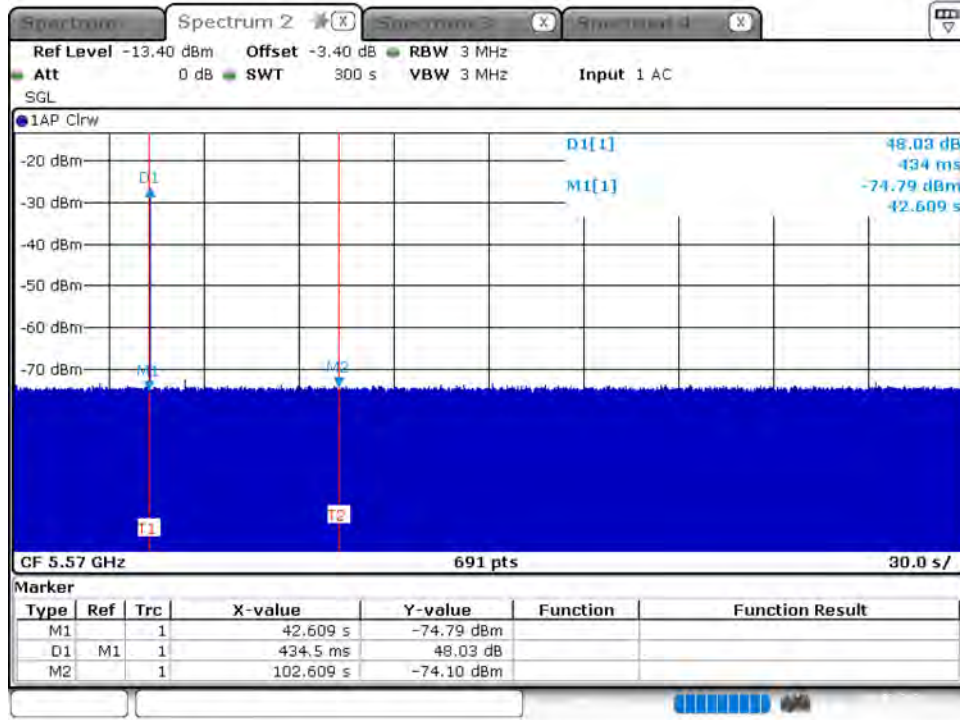

Date: 10.MAR.2021 09:59:16

Note: T1 denotes the end of power-up time period is 42.609 second. T2 denotes the 102.609 second. The radar burst was commenced within 0.4345 s after time T1



2.4.7 Test Result of Radar Burst at the End of the Channel Availability Check Time

AP Mode

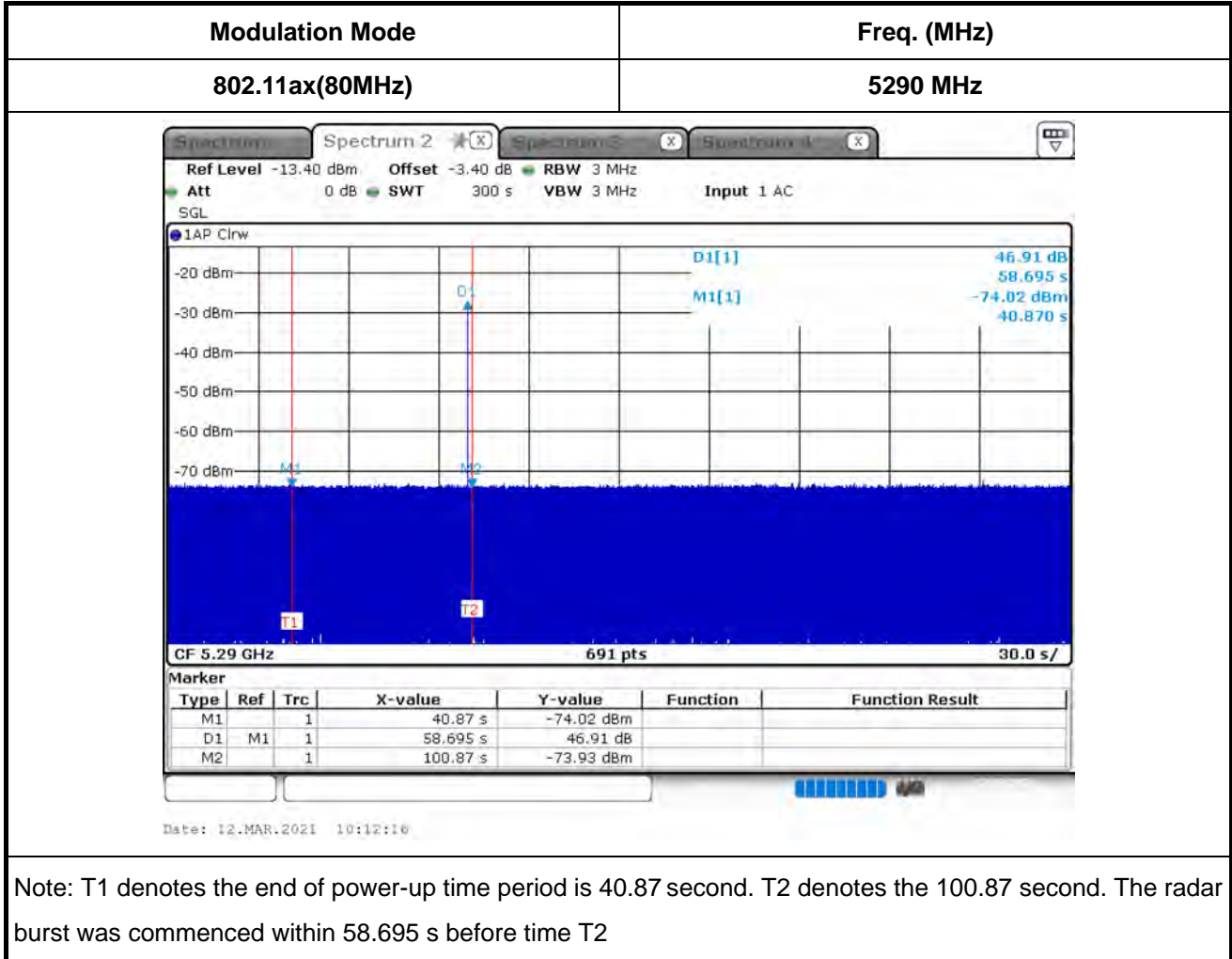

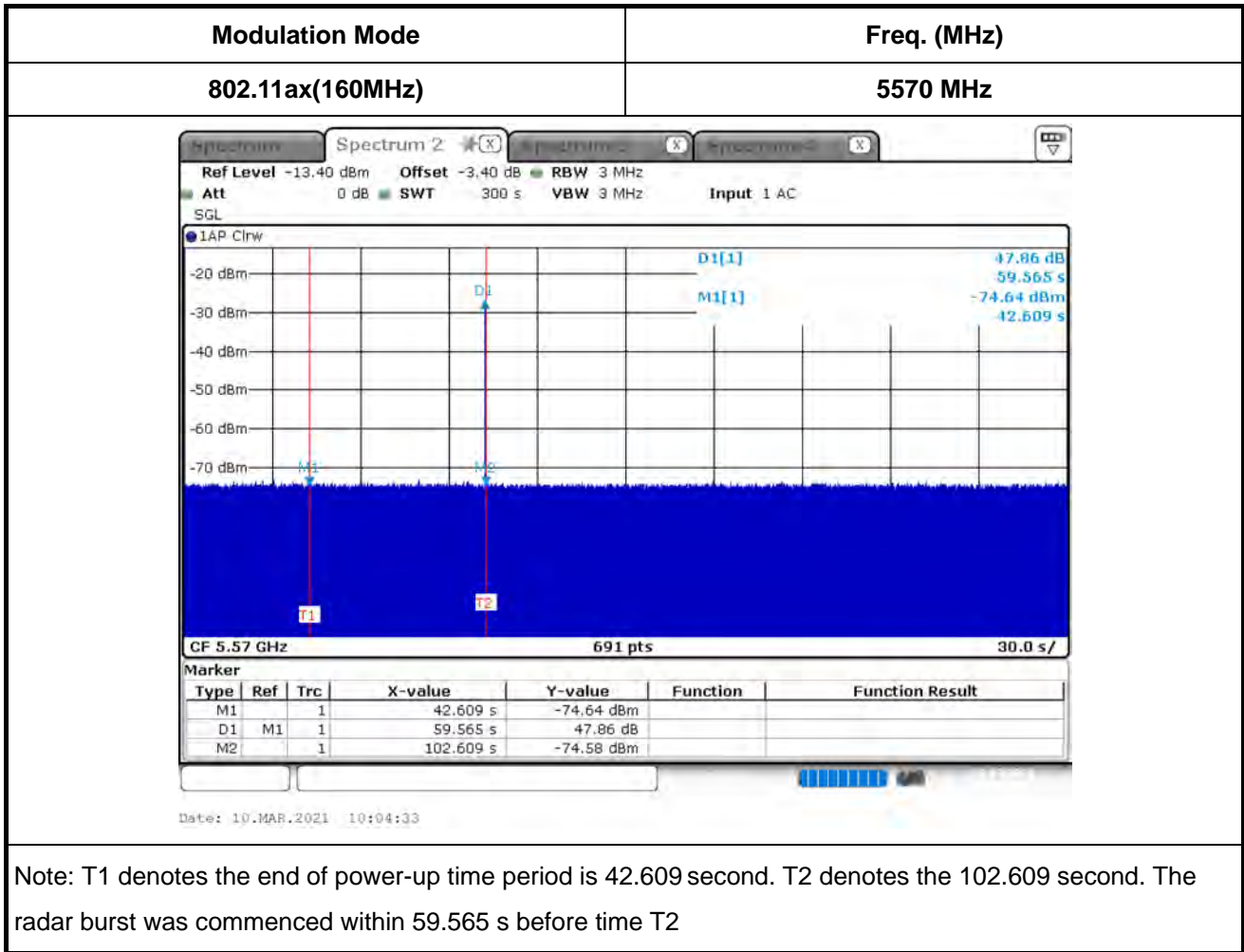



2.5 Channel Shutdown and Non-Occupancy Period for Master mode

2.5.1 Channel Shutdown and Non-Occupancy Period Limit

1. The UUT has In-Service Monitoring function to continuously monitor the radar signals, If radar is detected, must leave the channel (Shutdown).
2. Channel Shutdown Limit
 - The Channel Move Time to cease all transmissions on the current Channel upon detection of a Radar Waveform above the DFS Detection Threshold within 10 sec.
 - The total duration of Channel Closing Transmission Time is 260ms, consisting of aggregate of control signals, by a U-NII device during the Channel Move Time.
3. Non-Occupancy Period Limit
 - The Non-Occupancy Period time is 30 minute during which a Channel will not be utilized after a Radar Waveform is detected on that Channel.

2.5.2 Measuring Instruments

Refer a test equipment and calibration data table in this test report.

2.5.3 Test Setup

Refer a clause 2.2.8 in this test report.

2.5.4 Test Procedures

● **Channel Shutdown**

1. Set configuration as section 2.2.8 (1) and do DFS calibration, and then adjust attenuator to make sure that the threshold value of the reference test signal is -61dBm or -63dBm at the UUT’s antenna port and traffic signal is lower than radar burst signal.
2. Set configuration as section 2.2.8 (2) and set spectrum analyzer as section 2.2.7
3. Use Chariot software to reach duty cycle 17 % traffic from Slave to UUT.
4. The frequency of a radar is as same as transmitting frequency of UUT.
5. The Channel Closing Transmission Time and the Channel Move Time are illustrated in figure 17. T1 denotes the end of the radar burst
6. The transmissions of the UUT following instant T1 shall be observed for a period greater than 10 s.
The aggregate duration (Channel Closing Transmission Time) of all transmissions from the UUT on Chr during the Channel Move Time shall be compared to the limit (260ms).
- NOTE: The aggregate duration of all transmissions of the UUT does not include quiet periods in between transmissions of the UUT.
7. T2 denotes the instant when the UUT has ceased all transmissions on the channel Chr. The time difference between T1 and T2 shall be measured. This value (Channel Move Time) shall be noted and compared with the limit (10 s).
8. A timing trace or description of the observed timing and behaviour of the UUT shall be recorded in the report

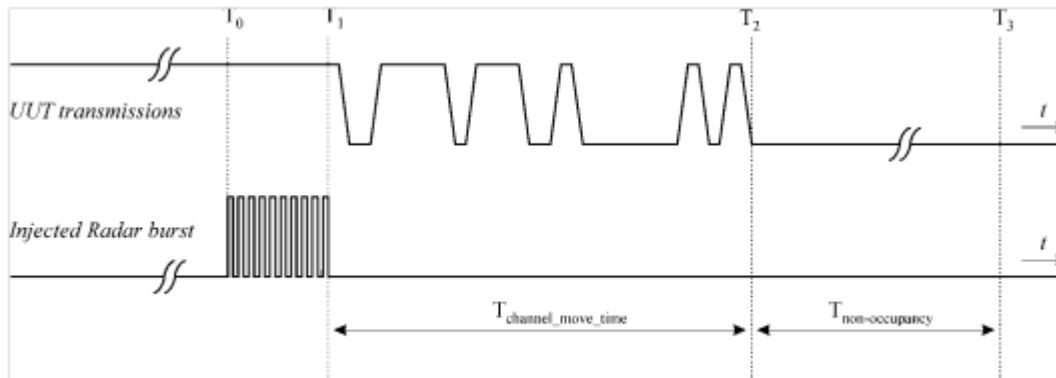

Figure 17: Example of Channel Closing Transmission Time & Channel Closing Time

● **Non-Occupancy Period**

1. Following instant T2 of channel shutdown, the selected channel Chr shall be observed for a period equal to the Non-Occupancy Period (T3-T2) to verify that the UUT does not resume any transmissions on this channel.
2. A timing trace or description of the observed timing and behaviour of the UUT shall be recorded in the report.

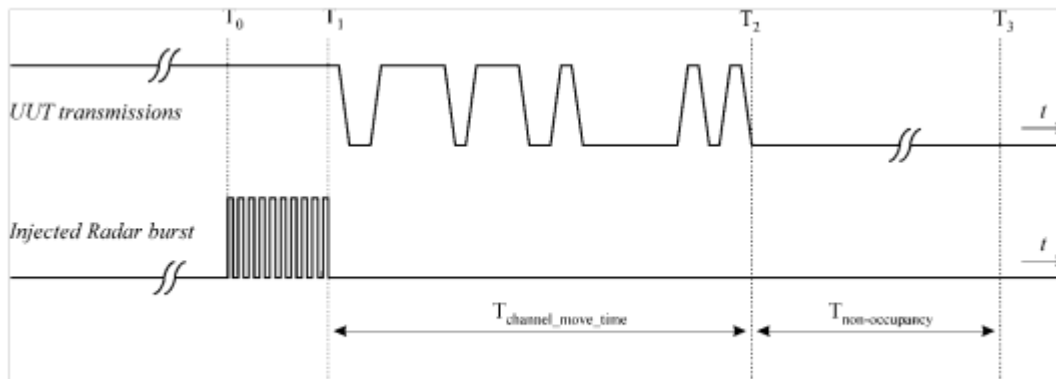

Figure 17: Example of Channel Closing Transmission Time & Channel Closing Time

2.5.5 Test Result of Channel Shutdown and Non-Occupancy Period for Master mode

AP Mode

Channel Shutdown and Non-Occupancy Period Result				
Detection Threshold Level (dBm)	-63 (DFS Detection Threshold + 1 dB)			
Modulation Mode / Freq. (MHz)	Radar Test Signal	Channel Move Time (s)	Channel Closing Transmission Time (ms)	Non-Occupancy Period (min)
802.11ax(80MHz) / 5290 MHz	Type 0	0.800	26.090	≥ 30 min
802.11ax(160MHz) / 5570 MHz	Type 0	0.852	28.990	≥ 30 min
Limit		< 10s	< 60ms	≥ 30 min
Test Result		Complied		
Note : Test using widest BW mode available				

2.5.6 Test Result of Channel Move Time

AP Mode

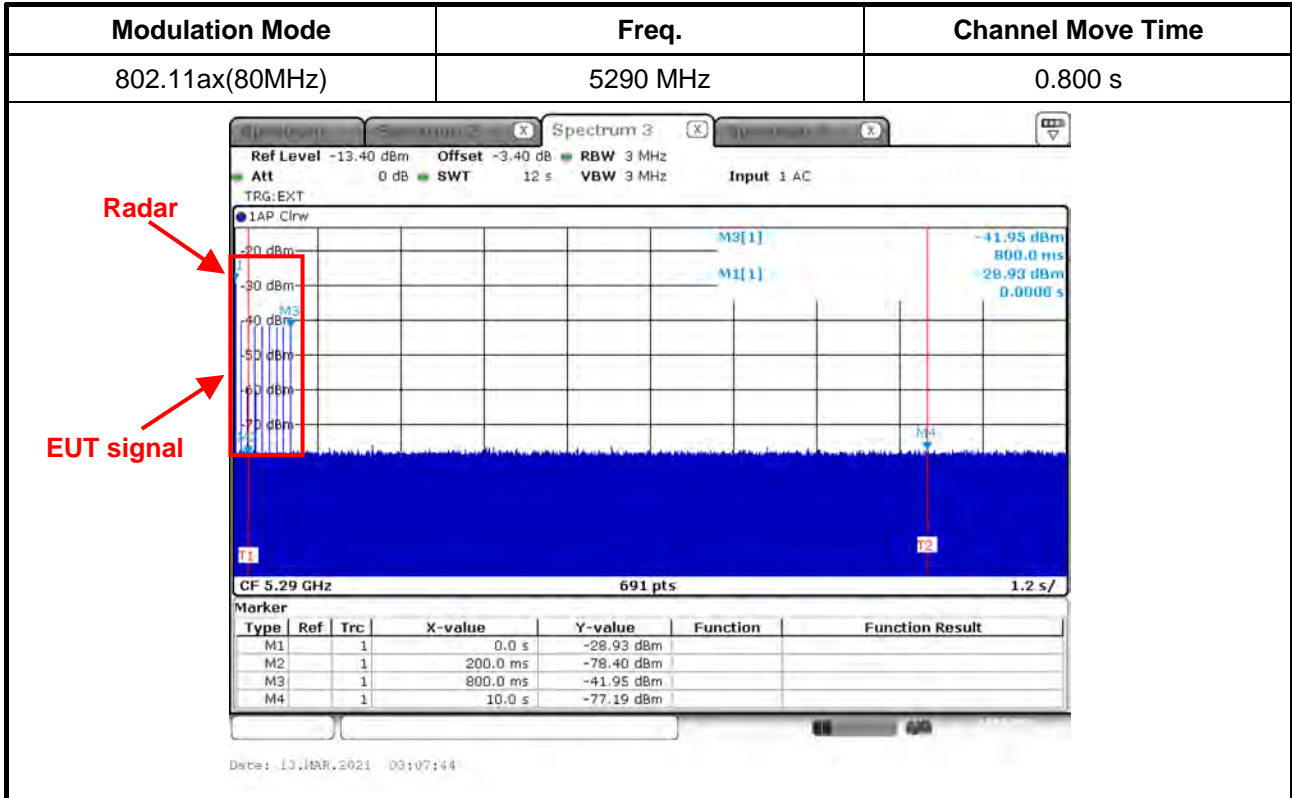

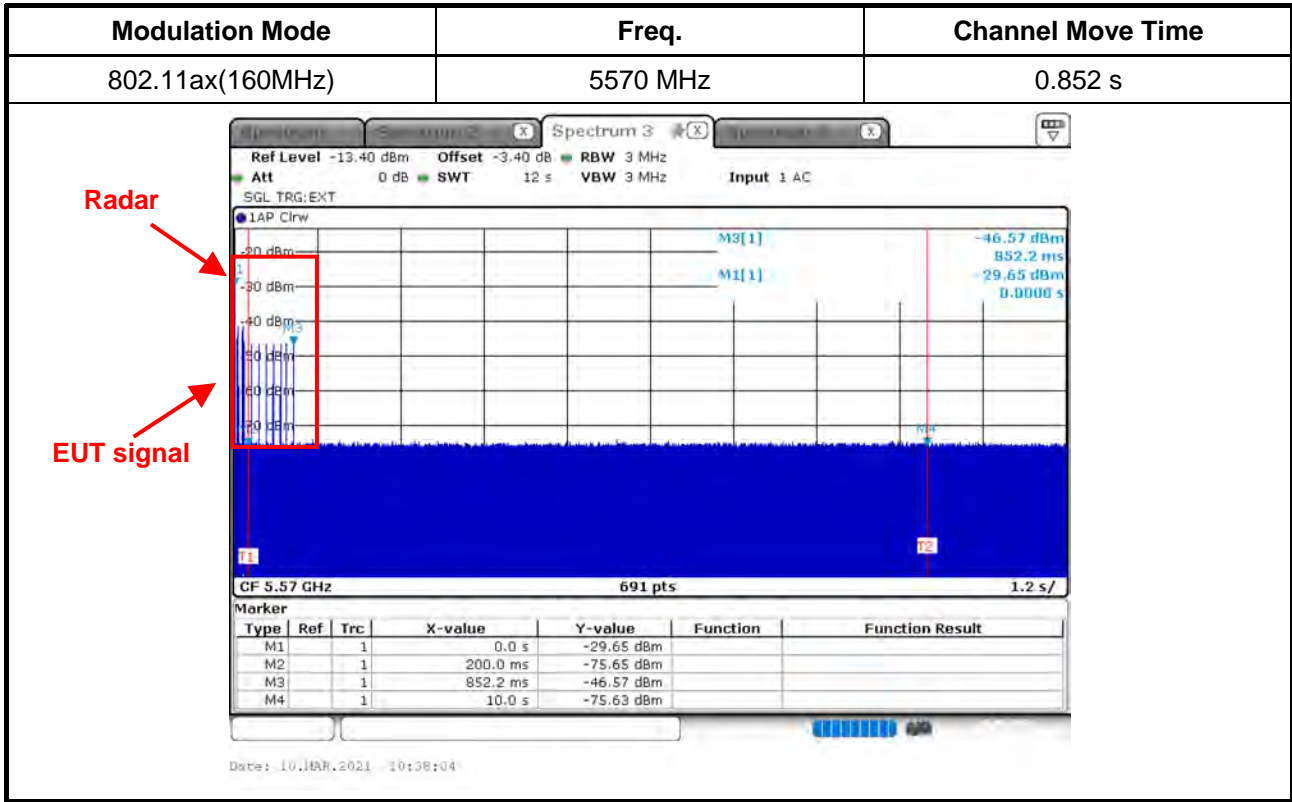

2.5.7 Test Result of Channel Closing Transmission Time

AP Mode

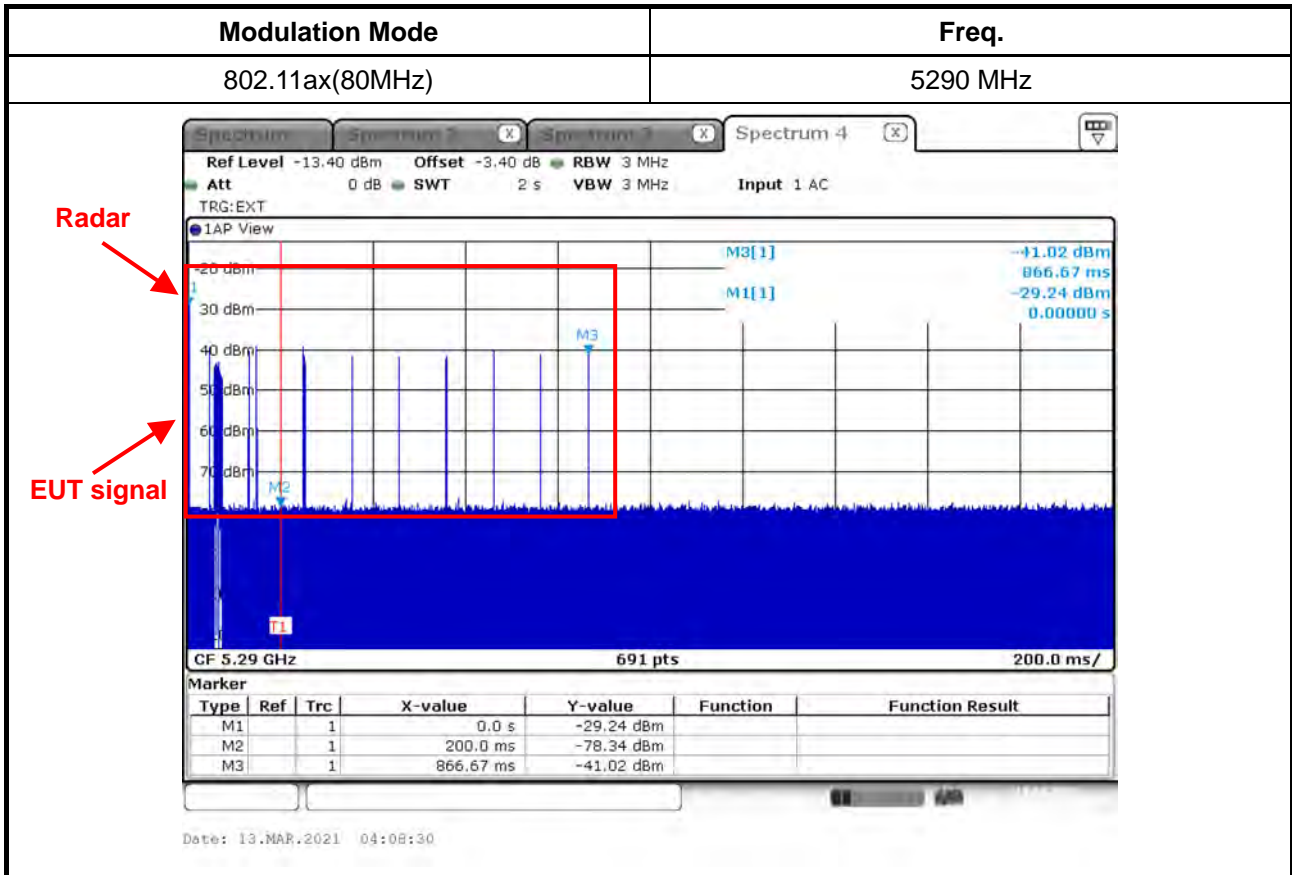

Dwell is the dwell time per spectrum analyzer sampling bin.

S is the sweep time

B is the number of spectrum analyzer sampling bins

C is the intermittent control signals of Channel Closing Transmission Time

N is the number of spectrum analyzer sampling bins (intermittent control signals) showing a U-NII transmission

Dwell (2.899 ms) = S (2000 ms) / B (690)

C (26.090ms) = N (9) X Dwell (2.899 ms)

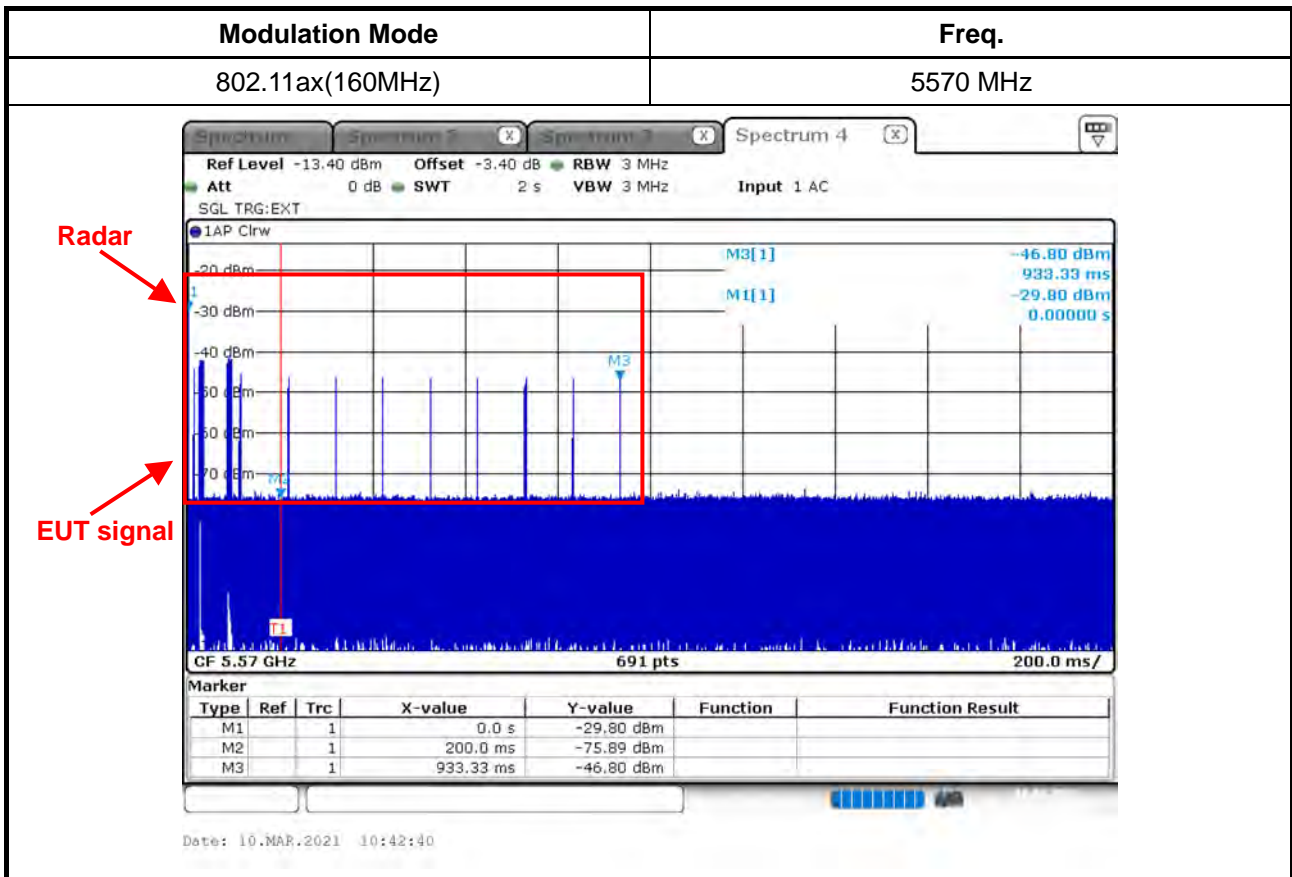

Dwell is the dwell time per spectrum analyzer sampling bin.

S is the sweep time

B is the number of spectrum analyzer sampling bins

C is the intermittent control signals of Channel Closing Transmission Time

N is the number of spectrum analyzer sampling bins (intermittent control signals) showing a U-NII transmission

Dwell (2.899 ms) = S (2000 ms) / B (690)

C (28.990 ms) = N (10) X Dwell (2.899 ms)



2.5.8 Test Result of Non-Occupancy Period

AP Mode

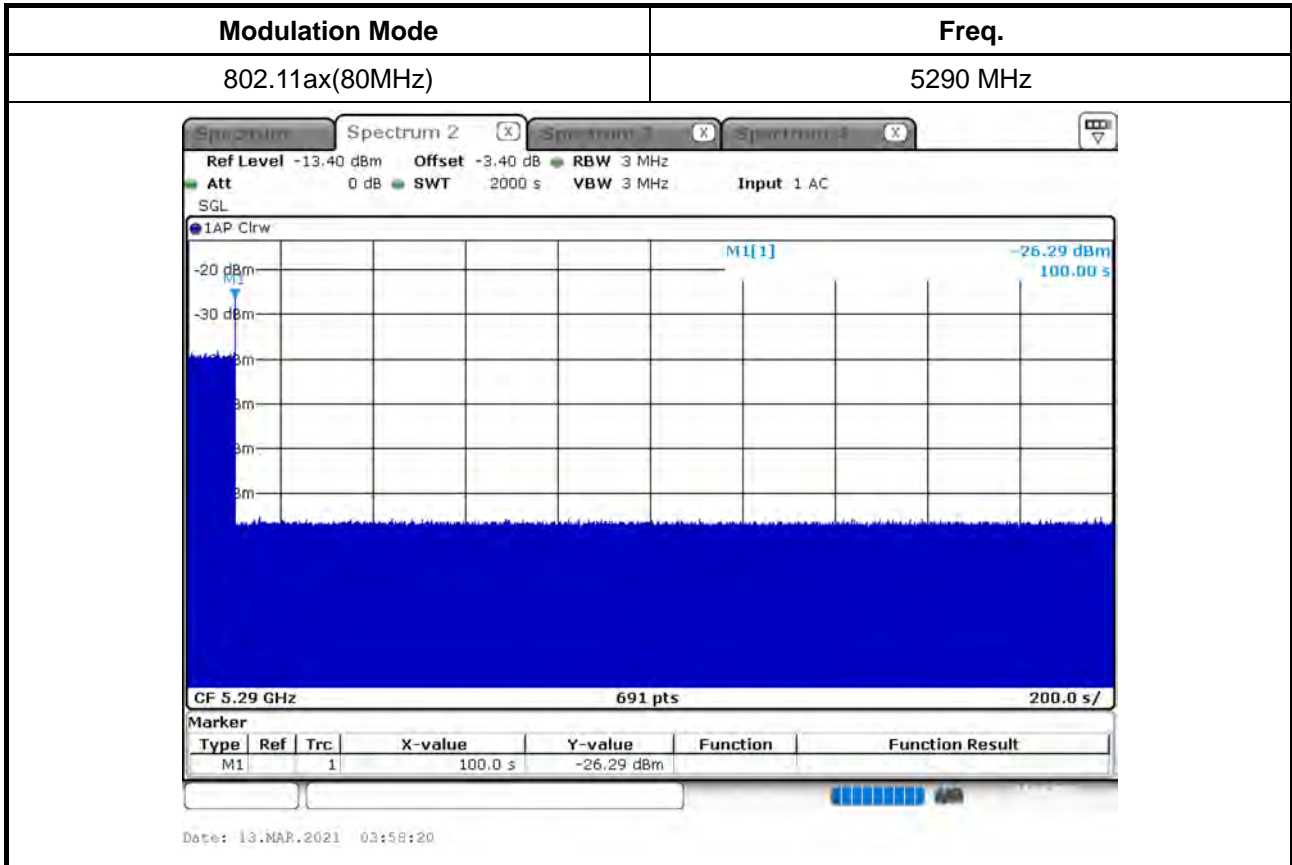

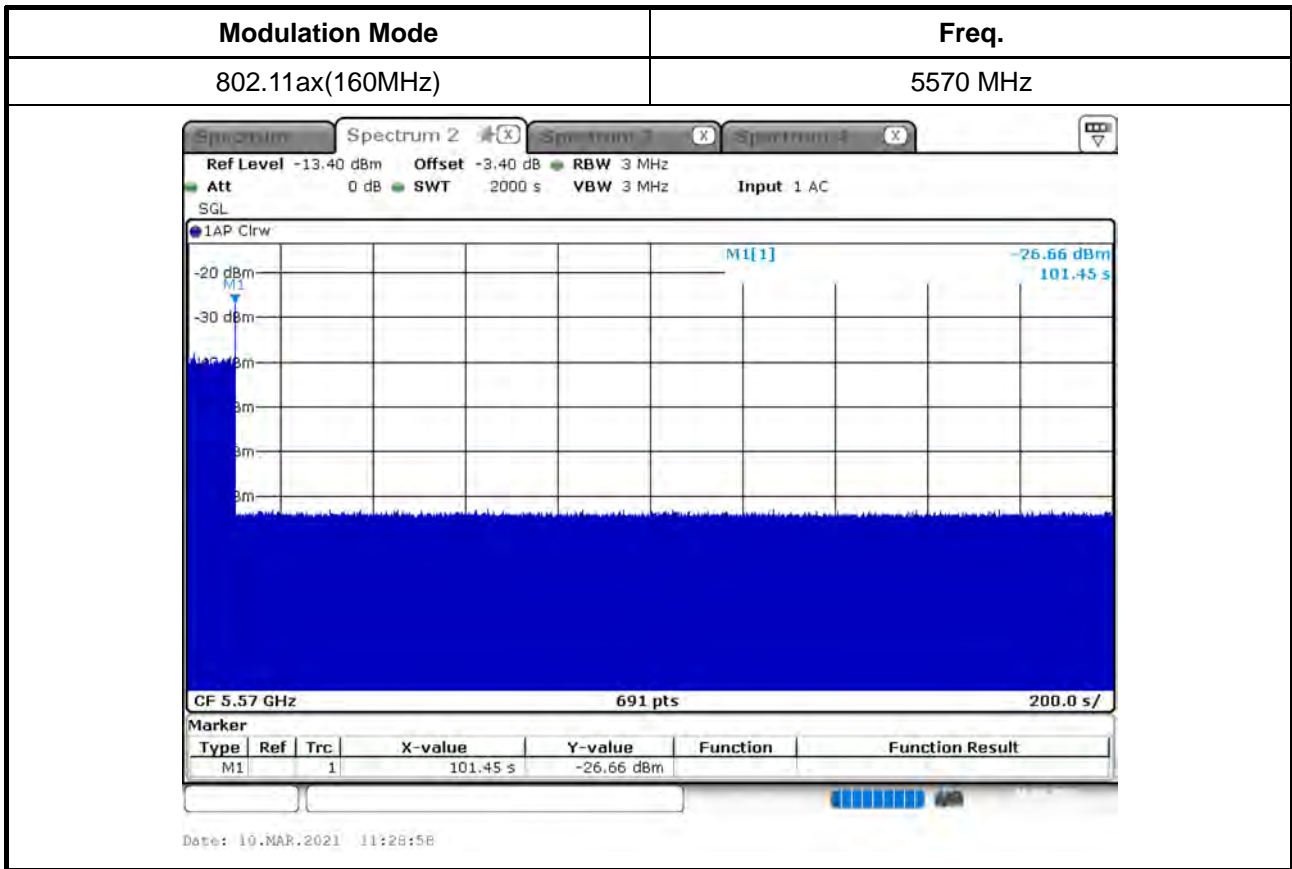



2.6 Statistical Performance Check

2.6.1 Statistical Performance Check Limit

The minimum percentage of successful detection requirements found in below table when a radar burst with a level equal to the DFS Detection Threshold + 1dB is generated on the Operating Channel of the U-NII device (In- Service Monitoring).

Radar Type	Minimum Percentage of Successful Detection (Pd)	Minimum Trials
1	Pd > 60%	30
2	Pd > 60%	30
3	Pd > 60%	30
4	Pd > 60%	30
Aggregate (Radar Types 1-4)	Pd > 80%	120
5	Pd > 80%	30
6	Pd > 70%	30

1. Short Pulse Radar Test

The percentage of successful detection is calculated by:

$$\frac{\text{Total Wave form Detections}}{\text{Total Wave form Trial}} \times 100 = \text{Probability of Detection Radar Waveform}$$

In addition an aggregate minimum percentage of successful detection across all Short Pulse Radar Types 1-4 is required and is calculated as follows: $\frac{Pd1 + Pd2 + Pd3 + Pd4}{4}$

2. Long Pulse Radar Test

Three subsets of trials will be performed with a minimum of ten trials per subset. The subset of trials differ in where the Long Pulse Type 5 Signal is tuned in frequency:

- a) the Channel center frequency (Figure 18).
- b) tuned frequencies such that 90% of the Long Pulse Type 5 frequency modulation is within the low edge of the UUT Occupied Bandwidth (Figure 19).
- c) tuned frequencies such that 90% of the Long Pulse Type 5 frequency modulation is within the high edge of the UUT Occupied Bandwidth (Figure 20).

For Figure 18

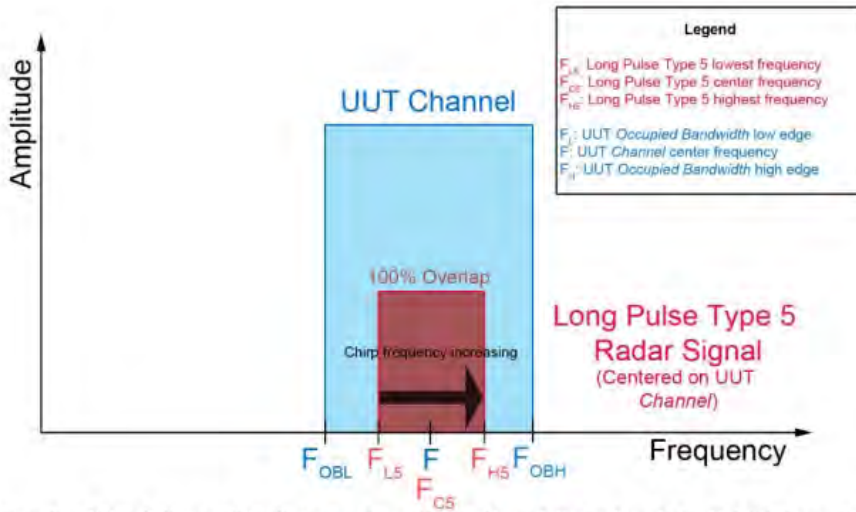

Figure 18: Example of the Relationship Between Long Pulse Type 5 Signal and the U-NII channel when the Signal is Tuned to the UUT Channel Center Frequency

For Figure 19

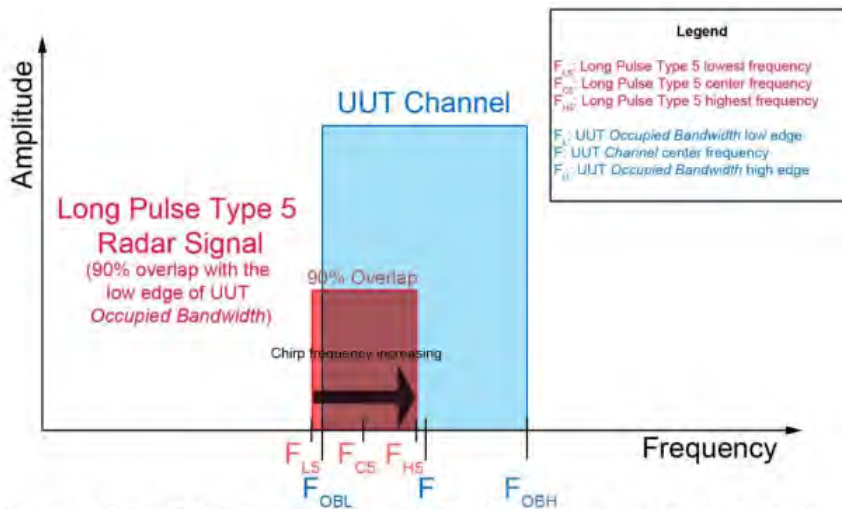

Figure 19: Example of the Relationship Between Long Pulse Type 5 Signal and the U-NII channel when the Signal is Tuned so that 90% of the Radar Signal Overlaps with the Low Edge of the UUT Occupied Bandwidth

For Figure 20

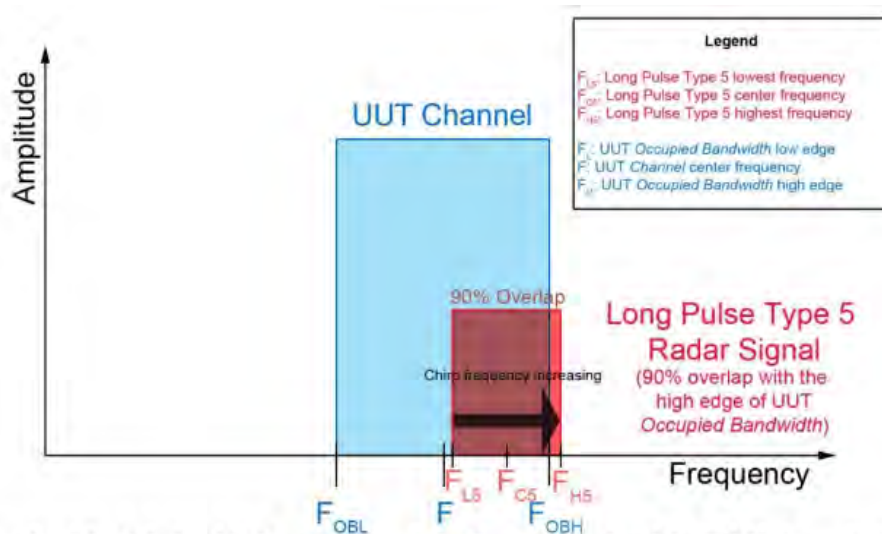

Figure 20: Example of the Relationship Between Long Pulse Type 5 Signal and the U-NII channel when the Signal is Tuned so that 90% of the Radar Signal Overlaps with the High Edge of the UUT Occupied Bandwidth

For subset case 1: the center frequency of the signal generator will remain fixed at the center of the UUT Channel.
 For subset case 2: to retain 90% frequency overlap between the radar signal and the UUT Occupied Bandwidth, the center frequency of the signal generator will vary for each of the ten trials in subset case 2. The center frequency of the signal generator for each trial is calculated by:

$$F_L + (0.4 * \text{Chirp Width [in MHz]})$$

For subset case 3: to retain 90% frequency overlap between the radar signal and the UUT Occupied Bandwidth, the center frequency of the signal generator will vary for each of the ten trials in subset case 3. The center frequency of the signal generator for each trial is calculated by:

$$F_H + (0.4 * \text{Chirp Width [in MHz]})$$

The percentage of successful detection is calculated by dividing the sum of the detections for the three subsets by the sum of trials for the three subsets:

$$\frac{\text{TotalWaveformDetections}}{\text{TotalWaveformTrial}} \times 100$$

3. Frequency Hopping Radar Test

The percentage of successful detection is calculated by:

$$\frac{\text{TotalWaveformDetections}}{\text{TotalWaveformTrial}} \times 100$$



2.6.2 Test Procedures

1. Stream the MPEG test file from the Master Device to the Client Device on the test Channel for the entire period of the test.
2. Set configuration as section 2.2.8 (1) and do DFS calibration, and then adjust attenuator to make sure that the threshold value of the radar test signals defined in table 5-7 (Type1~6) is -61dBm or -63dBm at the UUT's antenna port and traffic signal is higher than radar burst signal.
3. Set configuration as section 2.2.8 (2) and set spectrum analyzer as section 2.2.7
4. Use Chariot software to reach duty cycle 17 % traffic from Slave to UUT
5. Enter "debug command" from console.
6. The frequency of a radar is as same as transmitting frequency of UUT. If the UUT successfully detects the radar burst, it will appear "detected DFS message" from console.
7. Observe the transmissions of the EUT at the end of the Burst on the Operating Channel for duration greater than 10 seconds for Short Pulse Radar Types 1-4 and 6 to ensure detection occurs.
8. Observe the transmissions of the EUT at the end of the Burst on the Operating Channel for duration greater than 22 seconds for Long Pulse Radar Type 5 to ensure detection occurs.
9. The Minimum number of trial, minimum percentage of successful detection and the average minimum percentage of successful detection are found in below table.

2.6.3 Test Deviation

There is no deviation with the original standard.



2.6.4 Test Result of Statistical Performance Check

AP Mode

Modulation Mode: 802.11ax(20MHz) / 5300 MHz

Type 1 Radar Statistical Performance

Trial #	Test Freq. (MHz)	Pulse Repetition Frequency Number	Pulse Repetition Frequency (Pulse Per Second)	PRI (us)	1=Detection 0=No Detection
1	5300	1	1930.5	518	1
2	5295	23	326.2	3066	1
3	5293	19	1139.0	878	1
4	5294	12	1355.0	738	1
5	5290.3	4	1730.1	578	1
6	5303	8	1519.8	658	1
7	5292	15	1253.1	798	1
8	5306	6	1618.1	618	1
9	5306	14	1285.3	778	1
10	5306	3	1792.1	558	1
11	5297	13	1319.3	758	1
12	5304	9	1474.9	678	1
13	5308	7	1567.4	638	1
14	5308	17	1193.3	838	1
15	5293	10	1432.7	698	1
16	5309.7	-	1692.0	591	1
17	5301	-	328.1	3048	1
18	5309	-	373.4	2678	1
19	5303	-	574.4	1741	1
20	5293	-	1216.5	822	1
21	5302	-	801.3	1248	1
22	5303	-	488.5	2047	1
23	5291	-	956.0	1046	1
24	5307	-	517.6	1932	1
25	5300	-	1422.5	703	1
26	5303	-	542.0	1845	1
27	5297	-	741.3	1349	1
28	5297	-	881.8	1134	1
29	5301	-	427.4	2340	1
30	5307	-	628.9	1590	1
Detection Percentage (%)					100.000
Limit					60%
Test Result					Complied



Type 2 Radar Statistical Performance

Trial #	Test Freq. (MHz)	Pulse Width (us)	PRI (us)	Pulses / Burst	1=Detection 0=No Detection
1	5298	2.6	221	23	0
2	5309.7	4.6	198	27	1
3	5308	1.1	184	29	1
4	5304	4.8	203	24	1
5	5299	2.4	162	25	1
6	5308	3.4	204	28	1
7	5308	2.3	170	27	1
8	5299	3.5	184	23	1
9	5306	4.9	150	27	1
10	5291	4.6	211	29	1
11	5303	2.9	158	23	0
12	5292	2.6	226	27	1
13	5292	1.6	204	26	1
14	5292	3.9	181	25	1
15	5296	4.6	202	24	1
16	5295	4.1	194	27	1
17	5290.3	2.3	193	28	1
18	5305	3.9	173	29	1
19	5297	4.3	188	23	1
20	5298	1.5	215	26	1
21	5291	4.9	227	27	1
22	5305	1.1	199	23	1
23	5309	4.5	155	29	1
24	5297	4.0	190	27	0
25	5304	2.4	151	23	0
26	5291	2.5	180	28	1
27	5291	2.5	228	23	1
28	5293	2.5	203	25	1
29	5302	1.5	188	25	1
30	5309	1.9	217	24	1
Detection Percentage (%)					86.667
Limit					60%
Test Result					Complied



Type 3 Radar Statistical Performance

Trial #	Test Freq. (MHz)	Pulse Width (us)	PRI (us)	Pulses / Burst	1=Detection ; 0=No Detection
1	5293	8.0	205	16	1
2	5290.3	6.7	382	18	1
3	5294	8.6	418	16	1
4	5296	9.4	351	17	0
5	5303	7.4	383	18	1
6	5298	9.8	232	16	1
7	5292	9.1	377	17	0
8	5303	9.6	457	16	1
9	5299	8.0	471	18	0
10	5309.7	9.0	304	18	1
11	5302	8.0	316	17	1
12	5295	9.8	325	16	0
13	5296	8.0	409	17	1
14	5291	9.9	200	17	1
15	5298	8.8	458	16	1
16	5293	8.0	232	18	1
17	5301	8.3	250	16	0
18	5307	8.7	270	16	1
19	5292	7.7	350	17	1
20	5300	7.1	230	16	1
21	5307	7.3	416	18	1
22	5296	7.6	498	18	1
23	5309	7.3	286	17	1
24	5306	7.3	287	16	1
25	5307	7.5	462	17	1
26	5294	6.2	300	17	1
27	5293	6.4	323	18	1
28	5295	7.1	420	16	1
29	5306	7.2	395	18	1
30	5303	8.4	377	16	1
Detection Percentage (%)					83.333
Limit					60%
Test Result					Complied



Type 4 Radar Statistical Performance

Trial #	Test Freq. (MHz)	Pulse Width (us)	PRI (us)	Pulses / Burst	1=Detection 0=No Detection
1	5301	18.0	242	15	1
2	5296	19.9	279	12	1
3	5297	12.9	487	14	1
4	5301	15.0	452	13	1
5	5292	16.3	230	12	1
6	5299	19.8	238	13	1
7	5295	18.2	420	16	1
8	5300	16.3	452	15	1
9	5299	14.2	495	12	1
10	5298	17.8	228	16	1
11	5300	19.1	211	16	1
12	5298	18.4	283	15	1
13	5291	11.8	411	12	1
14	5299	14.2	284	13	1
15	5295	13.9	202	12	1
16	5304	17.8	340	14	1
17	5296	15.6	290	16	1
18	5309.7	14.6	250	16	1
19	5306	14.4	484	15	0
20	5301	18.9	387	13	0
21	5291	11.1	348	15	1
22	5309	13.8	291	16	0
23	5303	14.3	295	12	1
24	5300	12.5	300	12	1
25	5298	12.5	322	14	0
26	5291	12.5	383	13	1
27	5308	15.7	322	16	1
28	5307	19.8	469	13	1
29	5302	18.6	406	15	1
30	5290.3	15.9	238	14	1
Detection Percentage (%)					86.667
Limit					60%
Test Result					Complied



Total Type 1~4 Radar Statistical Performance

Radar Type #	Detection Percentage (%)
1	100.000
2	86.667
3	83.333
4	86.667
Aggregate (Radar Types 1-4)	89.167
Limit	80%
Test Result	Complied



Type 5 Radar Statistical Performance

Center Freq. (MHz)	Low Edge (MHz)	High Edge (MHz)	VSG Freq. (MHz)	Detection
5300	5290.3	5309.7		
Trial	Chirp	Offset		
1	5	2	5300.0	0
2	20	8	5300.0	1
3	7	2.8	5300.0	1
4	8	3.2	5300.0	1
5	9	3.6	5300.0	1
6	10	4	5300.0	1
7	11	4.4	5300.0	1
8	12	4.8	5300.0	1
9	13	5.2	5300.0	1
10	14	5.6	5300.0	1
11	15	6	5296.3	1
12	16	6.4	5296.7	1
13	17	6.8	5297.1	1
14	20	8	5298.3	1
15	19	7.6	5297.9	1
16	18	7.2	5297.5	1
17	17	6.8	5297.1	1
18	16	6.4	5296.7	1
19	15	6	5296.3	1
20	14	5.6	5295.9	1
21	13	5.2	5304.5	1
22	12	4.8	5304.9	1
23	11	4.4	5305.3	1
24	10	4	5305.7	1
25	9	3.6	5306.1	1
26	8	3.2	5306.5	1
27	18	7.2	5302.5	1
28	19	7.6	5302.1	0
29	20	8	5301.7	0
30	5	2	5307.7	1
Total				27
Detection Percentage (%)				90%
Limit				80%
Test Result				Complied



Trial Number							1
Number of Bursts in Trial							8
Chirp Center Frequency							5300
Burst	No. of Pulses	Pulse Width (us)	Chirp Width (MHz)	Pulse 1-to-2 Spacing (us)	Pulse 2-to-3 Spacing (us)	Starting Location Within Interval (ms)	
1	1	62.1	5	-	-	1091	
2	2	56	5	1729	-	133	
3	2	91.3	5	1230	-	1057	
4	3	50.7	5	1762	1616	1442	
5	2	92.6	5	1723	-	544	
6	2	87.3	5	1302	-	1089	
7	2	59.5	5	1291	-	1374	
8	2	52.2	5	1653	-	1237	
Detection Check (1=Detection; 0=No Detection)							0

Trial Number							2
Number of Bursts in Trial							9
Chirp Center Frequency							5300
Burst	No. of Pulses	Pulse Width (us)	Chirp Width (MHz)	Pulse 1-to-2 Spacing (us)	Pulse 2-to-3 Spacing (us)	Starting Location Within Interval (ms)	
1	3	90	20	1007	1326	30	
2	2	73.7	20	1785	-	979	
3	1	78.1	20	-	-	683	
4	2	92.4	20	1281	-	950	
5	1	61.2	20	-	-	612	
6	3	67.2	20	1525	1870	17	
7	1	78.5	20	-	-	429	
8	2	60.3	20	1931	-	936	
9	3	92.9	20	1403	1476	548	
Detection Check (1=Detection; 0=No Detection)							1



Trial Number							3
Number of Bursts in Trial							10
Chirp Center Frequency							5300
Burst	No. of Pulses	Pulse Width (us)	Chirp Width (MHz)	Pulse 1-to-2 Spacing (us)	Pulse 2-to-3 Spacing (us)	Starting Location Within Interval (ms)	
1	3	63.4	7	1574	1607	801	
2	1	98	7	-	-	966	
3	1	58.7	7	-	-	185	
4	1	88	7	-	-	1012	
5	3	79.5	7	1562	1370	943	
6	3	57.1	7	1900	1188	686	
7	2	64.4	7	1090	-	599	
8	1	78.7	7	-	-	1089	
9	1	69.3	7	-	-	188	
10	3	55.3	7	1375	1691	933	
Detection Check (1=Detection; 0=No Detection)							1

Trial Number							4
Number of Bursts in Trial							11
Chirp Center Frequency							5300
Burst	No. of Pulses	Pulse Width (us)	Chirp Width (MHz)	Pulse 1-to-2 Spacing (us)	Pulse 2-to-3 Spacing (us)	Starting Location Within Interval (ms)	
1	2	74.3	8	1642	-	24	
2	1	83.1	8	-	-	985	
3	2	59.5	8	1680	-	988	
4	2	59.8	8	1786	-	800	
5	2	77.6	8	1617	-	339	
6	2	79.9	8	1553	-	1040	
7	1	56	8	-	-	544	
8	3	71.4	8	1406	1927	452	
9	1	97.4	8	-	-	204	
10	2	98.3	8	1037	-	926	
11	1	63.6	8	-	-	1052	
Detection Check (1=Detection; 0=No Detection)							1



Trial Number							5
Number of Bursts in Trial							12
Chirp Center Frequency							5300
Burst	No. of Pulses	Pulse Width (us)	Chirp Width (MHz)	Pulse 1-to-2 Spacing (us)	Pulse 2-to-3 Spacing (us)	Starting Location Within Interval (ms)	
1	1	50	9	-	-	557	
2	2	62.5	9	1731	-	567	
3	2	55.4	9	1070	-	460	
4	1	65.7	9	-	-	4	
5	2	58	9	1512	-	64	
6	2	60.9	9	1230	-	650	
7	3	89.6	9	1598	1738	235	
8	3	84.4	9	1271	1617	873	
9	3	72.3	9	1498	1321	901	
10	1	58.9	9	-	-	663	
11	2	74.8	9	1584	-	919	
12	1	71.8	9	-	-	375	
Detection Check (1=Detection; 0=No Detection)							1

Trial Number							6
Number of Bursts in Trial							13
Chirp Center Frequency							5300
Burst	No. of Pulses	Pulse Width (us)	Chirp Width (MHz)	Pulse 1-to-2 Spacing (us)	Pulse 2-to-3 Spacing (us)	Starting Location Within Interval (ms)	
1	2	88.1	10	1257	-	846	
2	1	58.7	10	-	-	725	
3	2	97.1	10	1037	-	30	
4	3	83.1	10	1029	1106	490	
5	1	62.1	10	-	-	262	
6	2	71.4	10	1058	-	283	
7	2	86.3	10	1867	-	49	
8	3	77.3	10	1418	1876	634	
9	1	78.9	10	-	-	304	
10	3	79.2	10	1055	1572	564	
11	3	52	10	1582	1836	852	
12	3	56.5	10	1195	1542	525	
13	3	100	10	1638	1729	750	
Detection Check (1=Detection; 0=No Detection)							1



Trial Number							7
Number of Bursts in Trial							14
Chirp Center Frequency							5300
Burst	No. of Pulses	Pulse Width (us)	Chirp Width (MHz)	Pulse 1-to-2 Spacing (us)	Pulse 2-to-3 Spacing (us)	Starting Location Within Interval (ms)	
1	2	92.7	11	1208	-	231	
2	2	81.3	11	1144	-	804	
3	2	60.4	11	1555	-	34	
4	2	62.1	11	1320	-	427	
5	1	50	11	-	-	577	
6	3	65.9	11	1020	1365	3	
7	2	73.8	11	1308	-	51	
8	2	74.3	11	1143	-	360	
9	1	62.9	11	-	-	394	
10	2	74.8	11	1404	-	317	
11	2	69.7	11	1309	-	532	
12	2	69.8	11	1688	-	339	
13	2	77.4	11	1857	-	381	
14	1	55.1	11	-	-	426	
Detection Check (1=Detection; 0=No Detection)							1

Trial Number							8
Number of Bursts in Trial							15
Chirp Center Frequency							5300
Burst	No. of Pulses	Pulse Width (us)	Chirp Width (MHz)	Pulse 1-to-2 Spacing (us)	Pulse 2-to-3 Spacing (us)	Starting Location Within Interval (ms)	
1	1	91.7	12	-	-	776	
2	2	90	12	1196	-	187	
3	3	92.3	12	1486	1853	448	
4	2	66.8	12	1545	-	702	
5	1	64	12	-	-	403	
6	3	95.4	12	1123	1473	230	
7	3	66.8	12	1867	1401	604	
8	3	67.7	12	1472	1397	38	
9	1	68.2	12	-	-	735	
10	2	82.2	12	1297	-	610	
11	1	92.1	12	-	-	618	
12	2	57	12	1764	-	705	
13	2	58.5	12	1310	-	22	
14	3	85.5	12	1630	1447	641	
15	2	82.2	12	1371	-	109	
Detection Check (1=Detection; 0=No Detection)							1



Trial Number			9			
Number of Bursts in Trial			16			
Chirp Center Frequency			5300			
Burst	No. of Pulses	Pulse Width (us)	Chirp Width (MHz)	Pulse 1-to-2 Spacing (us)	Pulse 2-to-3 Spacing (us)	Starting Location Within Interval (ms)
1	2	74.4	13	1707	-	442
2	2	63.6	13	1725	-	280
3	2	71.3	13	1704	-	459
4	3	77.6	13	1063	1405	197
5	3	65.2	13	1731	1294	101
6	3	55.1	13	1109	1549	17
7	2	96.8	13	1034	-	131
8	3	80.8	13	1533	1051	365
9	1	60.4	13	-	-	222
10	2	61.8	13	1312	-	371
11	2	71.3	13	1657	-	33
12	2	98.1	13	1024	-	291
13	1	57.9	13	-	-	188
14	1	91.8	13	-	-	163
15	2	56.7	13	1259	-	426
16	2	89.7	13	1690	-	606
Detection Check (1=Detection; 0=No Detection)						1



Trial Number			10			
Number of Bursts in Trial			17			
Chirp Center Frequency			5300			
Burst	No. of Pulses	Pulse Width (us)	Chirp Width (MHz)	Pulse 1-to-2 Spacing (us)	Pulse 2-to-3 Spacing (us)	Starting Location Within Interval (ms)
1	2	74.4	14	1107	-	462
2	1	87.6	14	-	-	653
3	2	61.7	14	1741	-	457
4	2	57.5	14	1566	-	388
5	2	66.1	14	1855	-	63
6	3	70.1	14	1044	1012	136
7	1	66.4	14	-	-	343
8	1	59.2	14	-	-	349
9	2	88.3	14	1240	-	362
10	1	64.7	14	-	-	221
11	2	73	14	1703	-	144
12	2	81.7	14	1450	-	671
13	3	70.1	14	1741	1278	320
14	1	63.6	14	-	-	196
15	1	58.7	14	-	-	413
16	2	65.9	14	1478	-	170
17	1	72.7	14	-	-	564
Detection Check (1=Detection; 0=No Detection)						1



Trial Number		11				
Number of Bursts in Trial		18				
Chirp Center Frequency		5296				
Burst	No. of Pulses	Pulse Width (us)	Chirp Width (MHz)	Pulse 1-to-2 Spacing (us)	Pulse 2-to-3 Spacing (us)	Starting Location Within Interval (ms)
1	2	72.1	15	1193	-	130
2	3	76.3	15	1484	1390	114
3	1	86.1	15	-	-	14
4	1	73.2	15	-	-	604
5	1	81.2	15	-	-	548
6	2	99.5	15	1398	-	173
7	1	93.9	15	-	-	262
8	2	75.9	15	1921	-	38
9	3	79.2	15	1100	1429	84
10	3	77	15	1166	1799	610
11	1	91.8	15	-	-	339
12	3	56.8	15	1330	1556	580
13	2	83.1	15	1556	-	295
14	2	63	15	1552	-	156
15	1	65.7	15	-	-	439
16	1	64.5	15	-	-	188
17	1	88.5	15	-	-	419
18	1	60.6	15	-	-	205
Detection Check (1=Detection; 0=No Detection)						1



Trial Number			12			
Number of Bursts in Trial			19			
Chirp Center Frequency			5297			
Burst	No. of Pulses	Pulse Width (us)	Chirp Width (MHz)	Pulse 1-to-2 Spacing (us)	Pulse 2-to-3 Spacing (us)	Starting Location Within Interval (ms)
1	2	90.5	16	1299	-	381
2	2	88.4	16	1418	-	327
3	2	53.7	16	1055	-	536
4	1	80.5	16	-	-	285
5	1	50.4	16	-	-	398
6	2	61.2	16	1749	-	439
7	2	78.8	16	1065	-	129
8	3	75	16	1748	1820	325
9	2	96.7	16	1254	-	440
10	3	76.3	16	1848	1106	397
11	1	73.3	16	-	-	232
12	2	92.4	16	1317	-	91
13	2	92.4	16	1854	-	256
14	3	64.4	16	1240	1634	582
15	2	67.3	16	1473	-	117
16	2	84.1	16	1795	-	202
17	1	80.9	16	-	-	135
18	1	74.6	16	-	-	396
19	2	97.6	16	1805	-	615
Detection Check (1=Detection; 0=No Detection)						1



Trial Number							13
Number of Bursts in Trial							20
Chirp Center Frequency							5297
Burst	No. of Pulses	Pulse Width (us)	Chirp Width (MHz)	Pulse 1-to-2 Spacing (us)	Pulse 2-to-3 Spacing (us)	Starting Location Within Interval (ms)	
1	2	66.1	17	1417	-	388	
2	2	86.7	17	1693	-	348	
3	2	70.5	17	1263	-	215	
4	2	78	17	1446	-	28	
5	2	66	17	1185	-	585	
6	2	80.6	17	1855	-	65	
7	1	95.5	17	-	-	92	
8	1	98.8	17	-	-	68	
9	3	64.3	17	1641	1108	517	
10	1	75.1	17	-	-	121	
11	2	72.6	17	1499	-	448	
12	1	60.3	17	-	-	567	
13	2	54.9	17	1056	-	245	
14	2	98.8	17	1023	-	584	
15	2	60.9	17	1243	-	579	
16	2	62.7	17	1226	-	464	
17	1	80.1	17	-	-	89	
18	2	70.9	17	1711	-	153	
19	1	90.7	17	-	-	282	
20	1	98.9	17	-	-	71	
Detection Check (1=Detection; 0=No Detection)							1

Trial Number							14
Number of Bursts in Trial							8
Chirp Center Frequency							5298
Burst	No. of Pulses	Pulse Width (us)	Chirp Width (MHz)	Pulse 1-to-2 Spacing (us)	Pulse 2-to-3 Spacing (us)	Starting Location Within Interval (ms)	
1	2	67.5	20	1542	-	947	
2	3	83.6	20	1272	1696	124	
3	2	93.2	20	1877	-	701	
4	1	55.6	20	-	-	1123	
5	3	84.2	20	1733	1619	756	
6	3	69.1	20	1612	1071	1	
7	2	66.9	20	1905	-	7	
8	3	86.8	20	1697	1621	1082	
Detection Check (1=Detection; 0=No Detection)							1



Trial Number							15
Number of Bursts in Trial							9
Chirp Center Frequency							5298
Burst	No. of Pulses	Pulse Width (us)	Chirp Width (MHz)	Pulse 1-to-2 Spacing (us)	Pulse 2-to-3 Spacing (us)	Starting Location Within Interval (ms)	
1	2	62.2	19	1571	-	949	
2	2	85	19	1669	-	189	
3	2	64.5	19	1505	-	176	
4	2	50.4	19	1325	-	538	
5	2	66.1	19	1483	-	908	
6	2	71.2	19	1110	-	1017	
7	3	53.7	19	1445	1677	492	
8	3	62.5	19	1596	1341	349	
9	3	62	19	1929	1221	1105	
Detection Check (1=Detection; 0=No Detection)							1

Trial Number							16
Number of Bursts in Trial							10
Chirp Center Frequency							5298
Burst	No. of Pulses	Pulse Width (us)	Chirp Width (MHz)	Pulse 1-to-2 Spacing (us)	Pulse 2-to-3 Spacing (us)	Starting Location Within Interval (ms)	
1	2	80.5	18	1910	-	284	
2	2	64.2	18	1661	-	751	
3	2	90.1	18	1041	-	491	
4	2	69.8	18	1495	-	107	
5	1	73.1	18	-	-	490	
6	3	77.2	18	1418	1145	1155	
7	3	52.6	18	1732	1787	772	
8	2	71.4	18	1562	-	121	
9	2	89.8	18	1491	-	89	
10	2	76.4	18	1355	-	615	
Detection Check (1=Detection; 0=No Detection)							1



Trial Number							17
Number of Bursts in Trial							11
Chirp Center Frequency							5297
Burst	No. of Pulses	Pulse Width (us)	Chirp Width (MHz)	Pulse 1-to-2 Spacing (us)	Pulse 2-to-3 Spacing (us)	Starting Location Within Interval (ms)	
1	2	51.2	17	1236	-	740	
2	1	71.7	17	-	-	941	
3	2	74.7	17	1164	-	370	
4	2	50.9	17	1919	-	371	
5	2	65.2	17	1206	-	1033	
6	2	98	17	1182	-	346	
7	2	58.7	17	1612	-	639	
8	1	63.8	17	-	-	1056	
9	3	86.3	17	1545	1065	205	
10	1	94.4	17	-	-	753	
11	3	88.5	17	1699	1319	58	
Detection Check (1=Detection; 0=No Detection)							1

Trial Number							18
Number of Bursts in Trial							12
Chirp Center Frequency							5297
Burst	No. of Pulses	Pulse Width (us)	Chirp Width (MHz)	Pulse 1-to-2 Spacing (us)	Pulse 2-to-3 Spacing (us)	Starting Location Within Interval (ms)	
1	2	88.7	16	1405	-	448	
2	3	90.2	16	1544	1235	621	
3	1	96.5	16	-	-	512	
4	2	80.5	16	1090	-	321	
5	2	63.7	16	1268	-	798	
6	1	53.4	16	-	-	809	
7	2	52.3	16	1043	-	301	
8	3	54.7	16	1701	1104	796	
9	3	75.6	16	1923	1729	669	
10	2	59.2	16	1244	-	369	
11	1	56.3	16	-	-	51	
12	2	87.8	16	1608	-	733	
Detection Check (1=Detection; 0=No Detection)							1



Trial Number							19
Number of Bursts in Trial							13
Chirp Center Frequency							5296
Burst	No. of Pulses	Pulse Width (us)	Chirp Width (MHz)	Pulse 1-to-2 Spacing (us)	Pulse 2-to-3 Spacing (us)	Starting Location Within Interval (ms)	
1	2	68.2	15	1104	-	229	
2	2	58.4	15	1627	-	488	
3	3	74.7	15	1861	1015	137	
4	2	58.2	15	1593	-	520	
5	1	51.6	15	-	-	799	
6	2	94.7	15	1469	-	43	
7	2	70.7	15	1091	-	126	
8	2	82.9	15	1472	-	607	
9	3	62.7	15	1168	1453	527	
10	2	63.1	15	1529	-	143	
11	1	96.1	15	-	-	176	
12	2	57	15	1457	-	882	
13	3	95.6	15	1707	1501	214	
Detection Check (1=Detection; 0=No Detection)							1

Trial Number							20
Number of Bursts in Trial							14
Chirp Center Frequency							5296
Burst	No. of Pulses	Pulse Width (us)	Chirp Width (MHz)	Pulse 1-to-2 Spacing (us)	Pulse 2-to-3 Spacing (us)	Starting Location Within Interval (ms)	
1	1	95.7	14	-	-	117	
2	1	93.1	14	-	-	720	
3	1	55.8	14	-	-	297	
4	1	76.7	14	-	-	284	
5	2	68	14	1686	-	472	
6	3	94.1	14	1796	1393	264	
7	2	53.9	14	1293	-	525	
8	1	99.3	14	-	-	155	
9	2	73.3	14	1458	-	65	
10	2	93.3	14	1196	-	451	
11	3	55.8	14	1895	1034	243	
12	1	66.4	14	-	-	228	
13	2	65.6	14	1732	-	746	
14	2	76.5	14	1187	-	522	
Detection Check (1=Detection; 0=No Detection)							1



Trial Number							21
Number of Bursts in Trial							15
Chirp Center Frequency							5305
Burst	No. of Pulses	Pulse Width (us)	Chirp Width (MHz)	Pulse 1-to-2 Spacing (us)	Pulse 2-to-3 Spacing (us)	Starting Location Within Interval (ms)	
1	1	85.1	13	-	-	565	
2	2	72.5	13	1648	-	211	
3	1	67.5	13	-	-	348	
4	2	56.1	13	1360	-	156	
5	1	71.1	13	-	-	718	
6	2	93.1	13	1391	-	400	
7	1	56.5	13	-	-	482	
8	1	63.8	13	-	-	703	
9	2	67.4	13	1727	-	780	
10	1	52.3	13	-	-	102	
11	3	62.4	13	1228	1715	304	
12	2	53.3	13	1630	-	57	
13	2	83.1	13	1205	-	768	
14	2	93.7	13	1085	-	461	
15	2	90.7	13	1297	-	746	
Detection Check (1=Detection; 0=No Detection)							1

Trial Number							22
Number of Bursts in Trial							16
Chirp Center Frequency							5305
Burst	No. of Pulses	Pulse Width (us)	Chirp Width (MHz)	Pulse 1-to-2 Spacing (us)	Pulse 2-to-3 Spacing (us)	Starting Location Within Interval (ms)	
1	2	98.8	12	1439	-	95	
2	1	54.5	12	-	-	676	
3	2	80.5	12	1360	-	8	
4	2	55.9	12	1906	-	373	
5	2	72.1	12	1623	-	254	
6	2	84.4	12	1604	-	480	
7	1	78.5	12	-	-	663	
8	1	88	12	-	-	314	
9	2	74.7	12	1157	-	596	
10	2	97.1	12	1673	-	264	
11	1	81.6	12	-	-	740	
12	1	83.6	12	-	-	163	
13	3	87.6	12	1757	1322	628	
14	2	58.5	12	1372	-	132	
15	3	91.8	12	1767	1183	106	
16	2	58.8	12	1432	-	659	
Detection Check (1=Detection; 0=No Detection)							1



Trial Number			23			
Number of Bursts in Trial			17			
Chirp Center Frequency			5305			
Burst	No. of Pulses	Pulse Width (us)	Chirp Width (MHz)	Pulse 1-to-2 Spacing (us)	Pulse 2-to-3 Spacing (us)	Starting Location Within Interval (ms)
1	1	96	11	-	-	284
2	2	92.5	11	1241	-	488
3	2	89.5	11	1347	-	76
4	2	74.8	11	1607	-	688
5	2	60.6	11	1523	-	28
6	2	71.5	11	1659	-	383
7	2	71.1	11	1454	-	182
8	1	98.7	11	-	-	20
9	2	85.1	11	1770	-	576
10	2	89.2	11	1086	-	410
11	2	60.7	11	1101	-	458
12	2	75.2	11	1719	-	348
13	2	75.7	11	1799	-	481
14	3	56.7	11	1132	1884	587
15	2	65	11	1885	-	480
16	2	64.6	11	1910	-	195
17	3	69.9	11	1410	1190	396
Detection Check (1=Detection; 0=No Detection)						1



Trial Number			24			
Number of Bursts in Trial			18			
Chirp Center Frequency			5306			
Burst	No. of Pulses	Pulse Width (us)	Chirp Width (MHz)	Pulse 1-to-2 Spacing (us)	Pulse 2-to-3 Spacing (us)	Starting Location Within Interval (ms)
1	3	83.8	10	1290	1021	536
2	2	66.9	10	1112	-	44
3	3	91	10	1220	1504	611
4	2	86.1	10	1678	-	456
5	3	65.5	10	1928	1222	330
6	1	62.6	10	-	-	297
7	3	68.7	10	1505	1200	351
8	3	59.2	10	1452	1114	230
9	1	73.9	10	-	-	222
10	1	77.2	10	-	-	57
11	2	96.4	10	1357	-	399
12	2	99.9	10	1173	-	299
13	2	99.9	10	1520	-	464
14	1	86.7	10	-	-	294
15	1	92.6	10	-	-	653
16	1	77.1	10	-	-	550
17	2	81.1	10	1664	-	566
18	3	68.4	10	1536	1309	580
Detection Check (1=Detection; 0=No Detection)						1



Trial Number			25			
Number of Bursts in Trial			19			
Chirp Center Frequency			5306			
Burst	No. of Pulses	Pulse Width (us)	Chirp Width (MHz)	Pulse 1-to-2 Spacing (us)	Pulse 2-to-3 Spacing (us)	Starting Location Within Interval (ms)
1	3	68.2	9	1723	1868	471
2	3	83.7	9	1711	1405	368
3	2	69.7	9	1781	-	425
4	1	59.7	9	-	-	440
5	2	96.7	9	1484	-	123
6	2	95.8	9	1319	-	261
7	3	71.3	9	1095	1354	332
8	3	53.2	9	1527	1427	427
9	2	69.5	9	1771	-	397
10	3	63.9	9	1075	1447	67
11	2	93.4	9	1783	-	174
12	2	77.3	9	1564	-	17
13	2	73.1	9	1294	-	216
14	1	77.4	9	-	-	292
15	3	57.2	9	1722	1886	619
16	2	68.7	9	1629	-	233
17	1	60.8	9	-	-	226
18	3	69.7	9	1128	1224	599
19	1	62.2	9	-	-	433
Detection Check (1=Detection; 0=No Detection)						1



Trial Number							26
Number of Bursts in Trial							20
Chirp Center Frequency							5307
Burst	No. of Pulses	Pulse Width (us)	Chirp Width (MHz)	Pulse 1-to-2 Spacing (us)	Pulse 2-to-3 Spacing (us)	Starting Location Within Interval (ms)	
1	1	80.5	8	-	-	90	
2	3	62.6	8	1406	1343	319	
3	3	85.6	8	1190	1529	384	
4	2	83.9	8	1208	-	567	
5	2	92.4	8	1488	-	234	
6	2	54	8	1529	-	535	
7	3	81.3	8	1501	1812	325	
8	1	98.5	8	-	-	532	
9	1	85.8	8	-	-	272	
10	2	84.7	8	1593	-	182	
11	2	83.3	8	1705	-	134	
12	2	79.8	8	1567	-	286	
13	1	77.9	8	-	-	368	
14	3	98.4	8	1510	1569	290	
15	2	79.9	8	1588	-	231	
16	3	78	8	1140	1353	353	
17	3	55.2	8	1700	1327	53	
18	3	71.9	8	1081	1224	44	
19	1	62	8	-	-	298	
20	3	70.5	8	1888	1442	529	
Detection Check (1=Detection; 0=No Detection)							1

Trial Number							27
Number of Bursts in Trial							8
Chirp Center Frequency							5303
Burst	No. of Pulses	Pulse Width (us)	Chirp Width (MHz)	Pulse 1-to-2 Spacing (us)	Pulse 2-to-3 Spacing (us)	Starting Location Within Interval (ms)	
1	2	69.1	18	1076	-	1436	
2	2	62.1	18	1688	-	22	
3	2	94.8	18	1891	-	897	
4	1	75.8	18	-	-	1186	
5	2	65.4	18	1713	-	589	
6	2	97.7	18	1292	-	614	
7	3	98.1	18	1670	1711	506	
8	2	85.4	18	1672	-	776	
Detection Check (1=Detection; 0=No Detection)							1



Trial Number							28
Number of Bursts in Trial							9
Chirp Center Frequency							5302
Burst	No. of Pulses	Pulse Width (us)	Chirp Width (MHz)	Pulse 1-to-2 Spacing (us)	Pulse 2-to-3 Spacing (us)	Starting Location Within Interval (ms)	
1	3	82	19	1233	1713	679	
2	3	87.7	19	1554	1123	473	
3	2	98.9	19	1518	-	869	
4	1	55	19	-	-	719	
5	1	93.6	19	-	-	902	
6	2	58.7	19	1641	-	1243	
7	2	88.7	19	1387	-	410	
8	1	60.3	19	-	-	1154	
9	1	97.7	19	-	-	512	
Detection Check (1=Detection; 0=No Detection)							1

Trial Number							29
Number of Bursts in Trial							10
Chirp Center Frequency							5302
Burst	No. of Pulses	Pulse Width (us)	Chirp Width (MHz)	Pulse 1-to-2 Spacing (us)	Pulse 2-to-3 Spacing (us)	Starting Location Within Interval (ms)	
1	1	69.6	20	-	-	1131	
2	1	74.5	20	-	-	290	
3	1	60.9	20	-	-	895	
4	1	74.6	20	-	-	202	
5	2	99.3	20	1501	-	139	
6	2	95.3	20	1065	-	854	
7	2	91.9	20	1722	-	219	
8	2	51	20	1285	-	57	
9	2	87.7	20	1747	-	141	
10	1	87.2	20	-	-	596	
Detection Check (1=Detection; 0=No Detection)							0



Trial Number			30			
Number of Bursts in Trial			11			
Chirp Center Frequency			5308			
Burst	No. of Pulses	Pulse Width (us)	Chirp Width (MHz)	Pulse 1-to-2 Spacing (us)	Pulse 2-to-3 Spacing (us)	Starting Location Within Interval (ms)
1	3	59.9	5	1901	1196	935
2	2	77.1	5	1590	-	1038
3	2	62.7	5	1227	-	690
4	1	77.1	5	-	-	547
5	3	99.8	5	1798	1790	551
6	2	61.5	5	1135	-	876
7	2	77.5	5	1583	-	448
8	2	57.3	5	1890	-	736
9	2	53.5	5	1757	-	362
10	1	66.6	5	-	-	836
11	3	80.7	5	1811	1289	410
Detection Check (1=Detection; 0=No Detection)						1



Type 6 Radar Statistical Performance

Trial #	Test Freq. (MHz)	Pulses / Hop	Pulse Width (us)	PRI (us)	1=Detection 0=No Detection
1	5300	9	1	333	1
2	5300	9	1	333	1
3	5300	9	1	333	1
4	5300	9	1	333	1
5	5300	9	1	333	1
6	5300	9	1	333	1
7	5300	9	1	333	1
8	5300	9	1	333	1
9	5300	9	1	333	1
10	5300	9	1	333	1
11	5300	9	1	333	1
12	5300	9	1	333	1
13	5300	9	1	333	1
14	5300	9	1	333	1
15	5300	9	1	333	1
16	5300	9	1	333	1
17	5300	9	1	333	1
18	5300	9	1	333	1
19	5300	9	1	333	1
20	5300	9	1	333	1
21	5300	9	1	333	1
22	5300	9	1	333	1
23	5300	9	1	333	1
24	5300	9	1	333	1
25	5300	9	1	333	1
26	5300	9	1	333	1
27	5300	9	1	333	1
28	5300	9	1	333	1
29	5300	9	1	333	1
30	5300	9	1	333	1
Detection Percentage (%)					100.00
Limit					70%
Test Result					Complied



Modulation Mode: 802.11ax(40MHz) / 5310 MHz

Type 1 Radar Statistical Performance

Trial #	Test Freq. (MHz)	Pulse Repetition Frequency Number	Pulse Repetition Frequency (Pulse Per Second)	PRI (us)	1=Detection 0=No Detection
1	5302	1	1930.5	518	1
2	5310	23	326.2	3066	1
3	5303	19	1139.0	878	1
4	5302	12	1355.0	738	1
5	5295	4	1730.1	578	1
6	5312	8	1519.8	658	1
7	5317	15	1253.1	798	1
8	5320	6	1618.1	618	1
9	5301	14	1285.3	778	1
10	5328	3	1792.1	558	1
11	5309	13	1319.3	758	1
12	5320	9	1474.9	678	1
13	5307	7	1567.4	638	1
14	5299	17	1193.3	838	1
15	5329	10	1432.7	698	1
16	5300	-	1692.0	591	1
17	5308	-	328.1	3048	1
18	5303	-	373.4	2678	1
19	5310	-	574.4	1741	1
20	5300	-	1216.5	822	1
21	5291	-	801.3	1248	1
22	5324	-	488.5	2047	1
23	5292	-	956.0	1046	1
24	5303	-	517.6	1932	1
25	5293	-	1422.5	703	0
26	5323	-	542.0	1845	1
27	5296	-	741.3	1349	1
28	5327	-	881.8	1134	1
29	5322	-	427.4	2340	1
30	5327	-	628.9	1590	1
Detection Percentage (%)					96.667
Limit					60%
Test Result					Complied



Type 2 Radar Statistical Performance

Trial #	Test Freq. (MHz)	Pulse Width (us)	PRI (us)	Pulses / Burst	1=Detection 0=No Detection
1	5315	2.6	221	23	1
2	5304	4.6	198	27	1
3	5325	1.1	184	29	1
4	5328	4.8	203	24	1
5	5291	2.4	162	25	1
6	5297	3.4	204	28	1
7	5322	2.3	170	27	1
8	5319	3.5	184	23	1
9	5310	4.9	150	27	1
10	5306	4.6	211	29	0
11	5324	2.9	158	23	1
12	5313	2.6	226	27	1
13	5310	1.6	204	26	1
14	5325	3.9	181	25	1
15	5321	4.6	202	24	1
16	5297	4.1	194	27	1
17	5314	2.3	193	28	0
18	5303	3.9	173	29	0
19	5316	4.3	188	23	1
20	5295	1.5	215	26	1
21	5311	4.9	227	27	0
22	5308	1.1	199	23	1
23	5305	4.5	155	29	1
24	5324	4.0	190	27	1
25	5305	2.4	151	23	1
26	5303	2.5	180	28	1
27	5307	2.5	228	23	1
28	5324	2.5	203	25	0
29	5307	1.5	188	25	0
30	5326	1.9	217	24	1
Detection Percentage (%)					80.000
Limit					60%
Test Result					Complied



Type 3 Radar Statistical Performance

Trial #	Test Freq. (MHz)	Pulse Width (us)	PRI (us)	Pulses / Burst	1=Detection 0=No Detection
1	5296	8.0	205	16	1
2	5314	6.7	382	18	1
3	5298	8.6	418	16	1
4	5297	9.4	351	17	1
5	5307	7.4	383	18	1
6	5298	9.8	232	16	1
7	5291	9.1	377	17	0
8	5320	9.6	457	16	1
9	5314	8.0	471	18	1
10	5300	9.0	304	18	1
11	5325	8.0	316	17	0
12	5320	9.8	325	16	1
13	5328	8.0	409	17	1
14	5293	9.9	200	17	1
15	5315	8.8	458	16	1
16	5294	8.0	232	18	1
17	5317	8.3	250	16	1
18	5306	8.7	270	16	1
19	5303	7.7	350	17	1
20	5328	7.1	230	16	0
21	5324	7.3	416	18	1
22	5292	7.6	498	18	1
23	5294	7.3	286	17	0
24	5308	7.3	287	16	1
25	5311	7.5	462	17	1
26	5305	6.2	300	17	1
27	5307	6.4	323	18	1
28	5321	7.1	420	16	0
29	5325	7.2	395	18	1
30	5325	8.4	377	16	1
Detection Percentage (%)					83.333
Limit					60%
Test Result					Complied



Type 4 Radar Statistical Performance

Trial #	Test Freq. (MHz)	Pulse Width (us)	PRI (us)	Pulses / Burst	1=Detection 0=No Detection
1	5291	18.0	242	15	0
2	5292	19.9	279	12	1
3	5305	12.9	487	14	1
4	5311	15.0	452	13	1
5	5292	16.3	230	12	1
6	5295	19.8	238	13	1
7	5313	18.2	420	16	0
8	5316	16.3	452	15	1
9	5326	14.2	495	12	0
10	5305	17.8	228	16	1
11	5324	19.1	211	16	0
12	5294	18.4	283	15	1
13	5299	11.8	411	12	1
14	5311	14.2	284	13	0
15	5315	13.9	202	12	1
16	5321	17.8	340	14	1
17	5326	15.6	290	16	1
18	5300	14.6	250	16	1
19	5318	14.4	484	15	1
20	5303	18.9	387	13	1
21	5299	11.1	348	15	1
22	5329	13.8	291	16	1
23	5323	14.3	295	12	1
24	5310	12.5	300	12	1
25	5312	12.5	322	14	1
26	5294	12.5	383	13	1
27	5291	15.7	322	16	1
28	5300	19.8	469	13	0
29	5321	18.6	406	15	1
30	5320	15.9	238	14	1
Detection Percentage (%)					80.000
Limit					60%
Test Result					Complied



Total Type 1~4 Radar Statistical Performance

Radar Type #	Detection Percentage (%)
1	96.667
2	80.000
3	83.333
4	80.000
Aggregate (Radar Types 1-4)	85.000
Limit	80%
Test Result	Complied



Type 5 Radar Statistical Performance

Center Freq. (MHz)	Low Edge (MHz)	High Edge (MHz)	VSG Freq. (MHz)	Detection
Trial	Chirp	Offset		
1	5	2	5310.0	1
2	20	8	5310.0	1
3	7	2.8	5310.0	1
4	8	3.2	5310.0	1
5	9	3.6	5310.0	1
6	10	4	5310.0	1
7	11	4.4	5310.0	1
8	12	4.8	5310.0	1
9	13	5.2	5310.0	1
10	14	5.6	5310.0	0
11	15	6	5297.0	1
12	16	6.4	5297.4	1
13	17	6.8	5297.8	1
14	20	8	5299.0	1
15	19	7.6	5298.6	1
16	18	7.2	5298.2	1
17	17	6.8	5297.8	1
18	16	6.4	5297.4	0
19	15	6	5297.0	1
20	14	5.6	5296.6	1
21	13	5.2	5324.8	1
22	12	4.8	5325.2	1
23	11	4.4	5325.6	1
24	10	4	5326.0	1
25	9	3.6	5326.4	1
26	8	3.2	5326.8	1
27	18	7.2	5322.8	1
28	19	7.6	5322.4	0
29	20	8	5322.0	0
30	5	2	5328.0	1
Total				26
Detection Percentage (%)				87%
Limit				80%
Test Result				Complied



Trial Number							1
Number of Bursts in Trial							8
Chirp Center Frequency							5310
Burst	No. of Pulses	Pulse Width (us)	Chirp Width (MHz)	Pulse 1-to-2 Spacing (us)	Pulse 2-to-3 Spacing (us)	Starting Location Within Interval (ms)	
1	1	62.1	5	-	-	1091	
2	2	56	5	1729	-	133	
3	2	91.3	5	1230	-	1057	
4	3	50.7	5	1762	1616	1442	
5	2	92.6	5	1723	-	544	
6	2	87.3	5	1302	-	1089	
7	2	59.5	5	1291	-	1374	
8	2	52.2	5	1653	-	1237	
Detection Check (1=Detection; 0=No Detection)							1

Trial Number							2
Number of Bursts in Trial							9
Chirp Center Frequency							5310
Burst	No. of Pulses	Pulse Width (us)	Chirp Width (MHz)	Pulse 1-to-2 Spacing (us)	Pulse 2-to-3 Spacing (us)	Starting Location Within Interval (ms)	
1	3	90	20	1007	1326	30	
2	2	73.7	20	1785	-	979	
3	1	78.1	20	-	-	683	
4	2	92.4	20	1281	-	950	
5	1	61.2	20	-	-	612	
6	3	67.2	20	1525	1870	17	
7	1	78.5	20	-	-	429	
8	2	60.3	20	1931	-	936	
9	3	92.9	20	1403	1476	548	
Detection Check (1=Detection; 0=No Detection)							1



Trial Number							3
Number of Bursts in Trial							10
Chirp Center Frequency							5310
Burst	No. of Pulses	Pulse Width (us)	Chirp Width (MHz)	Pulse 1-to-2 Spacing (us)	Pulse 2-to-3 Spacing (us)	Starting Location Within Interval (ms)	
1	3	63.4	7	1574	1607	801	
2	1	98	7	-	-	966	
3	1	58.7	7	-	-	185	
4	1	88	7	-	-	1012	
5	3	79.5	7	1562	1370	943	
6	3	57.1	7	1900	1188	686	
7	2	64.4	7	1090	-	599	
8	1	78.7	7	-	-	1089	
9	1	69.3	7	-	-	188	
10	3	55.3	7	1375	1691	933	
Detection Check (1=Detection; 0=No Detection)							1

Trial Number							4
Number of Bursts in Trial							11
Chirp Center Frequency							5310
Burst	No. of Pulses	Pulse Width (us)	Chirp Width (MHz)	Pulse 1-to-2 Spacing (us)	Pulse 2-to-3 Spacing (us)	Starting Location Within Interval (ms)	
1	2	74.3	8	1642	-	24	
2	1	83.1	8	-	-	985	
3	2	59.5	8	1680	-	988	
4	2	59.8	8	1786	-	800	
5	2	77.6	8	1617	-	339	
6	2	79.9	8	1553	-	1040	
7	1	56	8	-	-	544	
8	3	71.4	8	1406	1927	452	
9	1	97.4	8	-	-	204	
10	2	98.3	8	1037	-	926	
11	1	63.6	8	-	-	1052	
Detection Check (1=Detection; 0=No Detection)							1



Trial Number							5
Number of Bursts in Trial							12
Chirp Center Frequency							5310
Burst	No. of Pulses	Pulse Width (us)	Chirp Width (MHz)	Pulse 1-to-2 Spacing (us)	Pulse 2-to-3 Spacing (us)	Starting Location Within Interval (ms)	
1	1	50	9	-	-	557	
2	2	62.5	9	1731	-	567	
3	2	55.4	9	1070	-	460	
4	1	65.7	9	-	-	4	
5	2	58	9	1512	-	64	
6	2	60.9	9	1230	-	650	
7	3	89.6	9	1598	1738	235	
8	3	84.4	9	1271	1617	873	
9	3	72.3	9	1498	1321	901	
10	1	58.9	9	-	-	663	
11	2	74.8	9	1584	-	919	
12	1	71.8	9	-	-	375	
Detection Check (1=Detection; 0=No Detection)							1

Trial Number							6
Number of Bursts in Trial							13
Chirp Center Frequency							5310
Burst	No. of Pulses	Pulse Width (us)	Chirp Width (MHz)	Pulse 1-to-2 Spacing (us)	Pulse 2-to-3 Spacing (us)	Starting Location Within Interval (ms)	
1	2	88.1	10	1257	-	846	
2	1	58.7	10	-	-	725	
3	2	97.1	10	1037	-	30	
4	3	83.1	10	1029	1106	490	
5	1	62.1	10	-	-	262	
6	2	71.4	10	1058	-	283	
7	2	86.3	10	1867	-	49	
8	3	77.3	10	1418	1876	634	
9	1	78.9	10	-	-	304	
10	3	79.2	10	1055	1572	564	
11	3	52	10	1582	1836	852	
12	3	56.5	10	1195	1542	525	
13	3	100	10	1638	1729	750	
Detection Check (1=Detection; 0=No Detection)							1



Trial Number							7
Number of Bursts in Trial							14
Chirp Center Frequency							5310
Burst	No. of Pulses	Pulse Width (us)	Chirp Width (MHz)	Pulse 1-to-2 Spacing (us)	Pulse 2-to-3 Spacing (us)	Starting Location Within Interval (ms)	
1	2	92.7	11	1208	-	231	
2	2	81.3	11	1144	-	804	
3	2	60.4	11	1555	-	34	
4	2	62.1	11	1320	-	427	
5	1	50	11	-	-	577	
6	3	65.9	11	1020	1365	3	
7	2	73.8	11	1308	-	51	
8	2	74.3	11	1143	-	360	
9	1	62.9	11	-	-	394	
10	2	74.8	11	1404	-	317	
11	2	69.7	11	1309	-	532	
12	2	69.8	11	1688	-	339	
13	2	77.4	11	1857	-	381	
14	1	55.1	11	-	-	426	
Detection Check (1=Detection; 0=No Detection)							1

Trial Number							8
Number of Bursts in Trial							15
Chirp Center Frequency							5310
Burst	No. of Pulses	Pulse Width (us)	Chirp Width (MHz)	Pulse 1-to-2 Spacing (us)	Pulse 2-to-3 Spacing (us)	Starting Location Within Interval (ms)	
1	1	91.7	12	-	-	776	
2	2	90	12	1196	-	187	
3	3	92.3	12	1486	1853	448	
4	2	66.8	12	1545	-	702	
5	1	64	12	-	-	403	
6	3	95.4	12	1123	1473	230	
7	3	66.8	12	1867	1401	604	
8	3	67.7	12	1472	1397	38	
9	1	68.2	12	-	-	735	
10	2	82.2	12	1297	-	610	
11	1	92.1	12	-	-	618	
12	2	57	12	1764	-	705	
13	2	58.5	12	1310	-	22	
14	3	85.5	12	1630	1447	641	
15	2	82.2	12	1371	-	109	
Detection Check (1=Detection; 0=No Detection)							1



Trial Number			9			
Number of Bursts in Trial			16			
Chirp Center Frequency			5310			
Burst	No. of Pulses	Pulse Width (us)	Chirp Width (MHz)	Pulse 1-to-2 Spacing (us)	Pulse 2-to-3 Spacing (us)	Starting Location Within Interval (ms)
1	2	74.4	13	1707	-	442
2	2	63.6	13	1725	-	280
3	2	71.3	13	1704	-	459
4	3	77.6	13	1063	1405	197
5	3	65.2	13	1731	1294	101
6	3	55.1	13	1109	1549	17
7	2	96.8	13	1034	-	131
8	3	80.8	13	1533	1051	365
9	1	60.4	13	-	-	222
10	2	61.8	13	1312	-	371
11	2	71.3	13	1657	-	33
12	2	98.1	13	1024	-	291
13	1	57.9	13	-	-	188
14	1	91.8	13	-	-	163
15	2	56.7	13	1259	-	426
16	2	89.7	13	1690	-	606
Detection Check (1=Detection; 0=No Detection)						1



Trial Number			10			
Number of Bursts in Trial			17			
Chirp Center Frequency			5310			
Burst	No. of Pulses	Pulse Width (us)	Chirp Width (MHz)	Pulse 1-to-2 Spacing (us)	Pulse 2-to-3 Spacing (us)	Starting Location Within Interval (ms)
1	2	74.4	14	1107	-	462
2	1	87.6	14	-	-	653
3	2	61.7	14	1741	-	457
4	2	57.5	14	1566	-	388
5	2	66.1	14	1855	-	63
6	3	70.1	14	1044	1012	136
7	1	66.4	14	-	-	343
8	1	59.2	14	-	-	349
9	2	88.3	14	1240	-	362
10	1	64.7	14	-	-	221
11	2	73	14	1703	-	144
12	2	81.7	14	1450	-	671
13	3	70.1	14	1741	1278	320
14	1	63.6	14	-	-	196
15	1	58.7	14	-	-	413
16	2	65.9	14	1478	-	170
17	1	72.7	14	-	-	564
Detection Check (1=Detection; 0=No Detection)						0



Trial Number			11			
Number of Bursts in Trial			18			
Chirp Center Frequency			5297			
Burst	No. of Pulses	Pulse Width (us)	Chirp Width (MHz)	Pulse 1-to-2 Spacing (us)	Pulse 2-to-3 Spacing (us)	Starting Location Within Interval (ms)
1	2	72.1	15	1193	-	130
2	3	76.3	15	1484	1390	114
3	1	86.1	15	-	-	14
4	1	73.2	15	-	-	604
5	1	81.2	15	-	-	548
6	2	99.5	15	1398	-	173
7	1	93.9	15	-	-	262
8	2	75.9	15	1921	-	38
9	3	79.2	15	1100	1429	84
10	3	77	15	1166	1799	610
11	1	91.8	15	-	-	339
12	3	56.8	15	1330	1556	580
13	2	83.1	15	1556	-	295
14	2	63	15	1552	-	156
15	1	65.7	15	-	-	439
16	1	64.5	15	-	-	188
17	1	88.5	15	-	-	419
18	1	60.6	15	-	-	205
Detection Check (1=Detection; 0=No Detection)						1



Trial Number			12			
Number of Bursts in Trial			19			
Chirp Center Frequency			5297			
Burst	No. of Pulses	Pulse Width (us)	Chirp Width (MHz)	Pulse 1-to-2 Spacing (us)	Pulse 2-to-3 Spacing (us)	Starting Location Within Interval (ms)
1	2	90.5	16	1299	-	381
2	2	88.4	16	1418	-	327
3	2	53.7	16	1055	-	536
4	1	80.5	16	-	-	285
5	1	50.4	16	-	-	398
6	2	61.2	16	1749	-	439
7	2	78.8	16	1065	-	129
8	3	75	16	1748	1820	325
9	2	96.7	16	1254	-	440
10	3	76.3	16	1848	1106	397
11	1	73.3	16	-	-	232
12	2	92.4	16	1317	-	91
13	2	92.4	16	1854	-	256
14	3	64.4	16	1240	1634	582
15	2	67.3	16	1473	-	117
16	2	84.1	16	1795	-	202
17	1	80.9	16	-	-	135
18	1	74.6	16	-	-	396
19	2	97.6	16	1805	-	615
Detection Check (1=Detection; 0=No Detection)						1



Trial Number							13
Number of Bursts in Trial							20
Chirp Center Frequency							5298
Burst	No. of Pulses	Pulse Width (us)	Chirp Width (MHz)	Pulse 1-to-2 Spacing (us)	Pulse 2-to-3 Spacing (us)	Starting Location Within Interval (ms)	
1	2	66.1	17	1417	-	388	
2	2	86.7	17	1693	-	348	
3	2	70.5	17	1263	-	215	
4	2	78	17	1446	-	28	
5	2	66	17	1185	-	585	
6	2	80.6	17	1855	-	65	
7	1	95.5	17	-	-	92	
8	1	98.8	17	-	-	68	
9	3	64.3	17	1641	1108	517	
10	1	75.1	17	-	-	121	
11	2	72.6	17	1499	-	448	
12	1	60.3	17	-	-	567	
13	2	54.9	17	1056	-	245	
14	2	98.8	17	1023	-	584	
15	2	60.9	17	1243	-	579	
16	2	62.7	17	1226	-	464	
17	1	80.1	17	-	-	89	
18	2	70.9	17	1711	-	153	
19	1	90.7	17	-	-	282	
20	1	98.9	17	-	-	71	
Detection Check (1=Detection; 0=No Detection)							1

Trial Number							14
Number of Bursts in Trial							8
Chirp Center Frequency							5299
Burst	No. of Pulses	Pulse Width (us)	Chirp Width (MHz)	Pulse 1-to-2 Spacing (us)	Pulse 2-to-3 Spacing (us)	Starting Location Within Interval (ms)	
1	2	67.5	20	1542	-	947	
2	3	83.6	20	1272	1696	124	
3	2	93.2	20	1877	-	701	
4	1	55.6	20	-	-	1123	
5	3	84.2	20	1733	1619	756	
6	3	69.1	20	1612	1071	1	
7	2	66.9	20	1905	-	7	
8	3	86.8	20	1697	1621	1082	
Detection Check (1=Detection; 0=No Detection)							1



Trial Number							15
Number of Bursts in Trial							9
Chirp Center Frequency							5299
Burst	No. of Pulses	Pulse Width (us)	Chirp Width (MHz)	Pulse 1-to-2 Spacing (us)	Pulse 2-to-3 Spacing (us)	Starting Location Within Interval (ms)	
1	2	62.2	19	1571	-	949	
2	2	85	19	1669	-	189	
3	2	64.5	19	1505	-	176	
4	2	50.4	19	1325	-	538	
5	2	66.1	19	1483	-	908	
6	2	71.2	19	1110	-	1017	
7	3	53.7	19	1445	1677	492	
8	3	62.5	19	1596	1341	349	
9	3	62	19	1929	1221	1105	
Detection Check (1=Detection; 0=No Detection)							1

Trial Number							16
Number of Bursts in Trial							10
Chirp Center Frequency							5298
Burst	No. of Pulses	Pulse Width (us)	Chirp Width (MHz)	Pulse 1-to-2 Spacing (us)	Pulse 2-to-3 Spacing (us)	Starting Location Within Interval (ms)	
1	2	80.5	18	1910	-	284	
2	2	64.2	18	1661	-	751	
3	2	90.1	18	1041	-	491	
4	2	69.8	18	1495	-	107	
5	1	73.1	18	-	-	490	
6	3	77.2	18	1418	1145	1155	
7	3	52.6	18	1732	1787	772	
8	2	71.4	18	1562	-	121	
9	2	89.8	18	1491	-	89	
10	2	76.4	18	1355	-	615	
Detection Check (1=Detection; 0=No Detection)							1



Trial Number							17
Number of Bursts in Trial							11
Chirp Center Frequency							5298
Burst	No. of Pulses	Pulse Width (us)	Chirp Width (MHz)	Pulse 1-to-2 Spacing (us)	Pulse 2-to-3 Spacing (us)	Starting Location Within Interval (ms)	
1	2	51.2	17	1236	-	740	
2	1	71.7	17	-	-	941	
3	2	74.7	17	1164	-	370	
4	2	50.9	17	1919	-	371	
5	2	65.2	17	1206	-	1033	
6	2	98	17	1182	-	346	
7	2	58.7	17	1612	-	639	
8	1	63.8	17	-	-	1056	
9	3	86.3	17	1545	1065	205	
10	1	94.4	17	-	-	753	
11	3	88.5	17	1699	1319	58	
Detection Check (1=Detection; 0=No Detection)							1

Trial Number							18
Number of Bursts in Trial							12
Chirp Center Frequency							5297
Burst	No. of Pulses	Pulse Width (us)	Chirp Width (MHz)	Pulse 1-to-2 Spacing (us)	Pulse 2-to-3 Spacing (us)	Starting Location Within Interval (ms)	
1	2	88.7	16	1405	-	448	
2	3	90.2	16	1544	1235	621	
3	1	96.5	16	-	-	512	
4	2	80.5	16	1090	-	321	
5	2	63.7	16	1268	-	798	
6	1	53.4	16	-	-	809	
7	2	52.3	16	1043	-	301	
8	3	54.7	16	1701	1104	796	
9	3	75.6	16	1923	1729	669	
10	2	59.2	16	1244	-	369	
11	1	56.3	16	-	-	51	
12	2	87.8	16	1608	-	733	
Detection Check (1=Detection; 0=No Detection)							0



Trial Number							19
Number of Bursts in Trial							13
Chirp Center Frequency							5297
Burst	No. of Pulses	Pulse Width (us)	Chirp Width (MHz)	Pulse 1-to-2 Spacing (us)	Pulse 2-to-3 Spacing (us)	Starting Location Within Interval (ms)	
1	2	68.2	15	1104	-	229	
2	2	58.4	15	1627	-	488	
3	3	74.7	15	1861	1015	137	
4	2	58.2	15	1593	-	520	
5	1	51.6	15	-	-	799	
6	2	94.7	15	1469	-	43	
7	2	70.7	15	1091	-	126	
8	2	82.9	15	1472	-	607	
9	3	62.7	15	1168	1453	527	
10	2	63.1	15	1529	-	143	
11	1	96.1	15	-	-	176	
12	2	57	15	1457	-	882	
13	3	95.6	15	1707	1501	214	
Detection Check (1=Detection; 0=No Detection)							1

Trial Number							20
Number of Bursts in Trial							14
Chirp Center Frequency							5297
Burst	No. of Pulses	Pulse Width (us)	Chirp Width (MHz)	Pulse 1-to-2 Spacing (us)	Pulse 2-to-3 Spacing (us)	Starting Location Within Interval (ms)	
1	1	95.7	14	-	-	117	
2	1	93.1	14	-	-	720	
3	1	55.8	14	-	-	297	
4	1	76.7	14	-	-	284	
5	2	68	14	1686	-	472	
6	3	94.1	14	1796	1393	264	
7	2	53.9	14	1293	-	525	
8	1	99.3	14	-	-	155	
9	2	73.3	14	1458	-	65	
10	2	93.3	14	1196	-	451	
11	3	55.8	14	1895	1034	243	
12	1	66.4	14	-	-	228	
13	2	65.6	14	1732	-	746	
14	2	76.5	14	1187	-	522	
Detection Check (1=Detection; 0=No Detection)							1



Trial Number							21
Number of Bursts in Trial							15
Chirp Center Frequency							5325
Burst	No. of Pulses	Pulse Width (us)	Chirp Width (MHz)	Pulse 1-to-2 Spacing (us)	Pulse 2-to-3 Spacing (us)	Starting Location Within Interval (ms)	
1	1	85.1	13	-	-	565	
2	2	72.5	13	1648	-	211	
3	1	67.5	13	-	-	348	
4	2	56.1	13	1360	-	156	
5	1	71.1	13	-	-	718	
6	2	93.1	13	1391	-	400	
7	1	56.5	13	-	-	482	
8	1	63.8	13	-	-	703	
9	2	67.4	13	1727	-	780	
10	1	52.3	13	-	-	102	
11	3	62.4	13	1228	1715	304	
12	2	53.3	13	1630	-	57	
13	2	83.1	13	1205	-	768	
14	2	93.7	13	1085	-	461	
15	2	90.7	13	1297	-	746	
Detection Check (1=Detection; 0=No Detection)							1

Trial Number							22
Number of Bursts in Trial							16
Chirp Center Frequency							5325
Burst	No. of Pulses	Pulse Width (us)	Chirp Width (MHz)	Pulse 1-to-2 Spacing (us)	Pulse 2-to-3 Spacing (us)	Starting Location Within Interval (ms)	
1	2	98.8	12	1439	-	95	
2	1	54.5	12	-	-	676	
3	2	80.5	12	1360	-	8	
4	2	55.9	12	1906	-	373	
5	2	72.1	12	1623	-	254	
6	2	84.4	12	1604	-	480	
7	1	78.5	12	-	-	663	
8	1	88	12	-	-	314	
9	2	74.7	12	1157	-	596	
10	2	97.1	12	1673	-	264	
11	1	81.6	12	-	-	740	
12	1	83.6	12	-	-	163	
13	3	87.6	12	1757	1322	628	
14	2	58.5	12	1372	-	132	
15	3	91.8	12	1767	1183	106	
16	2	58.8	12	1432	-	659	
Detection Check (1=Detection; 0=No Detection)							1



Trial Number			23			
Number of Bursts in Trial			17			
Chirp Center Frequency			5326			
Burst	No. of Pulses	Pulse Width (us)	Chirp Width (MHz)	Pulse 1-to-2 Spacing (us)	Pulse 2-to-3 Spacing (us)	Starting Location Within Interval (ms)
1	1	96	11	-	-	284
2	2	92.5	11	1241	-	488
3	2	89.5	11	1347	-	76
4	2	74.8	11	1607	-	688
5	2	60.6	11	1523	-	28
6	2	71.5	11	1659	-	383
7	2	71.1	11	1454	-	182
8	1	98.7	11	-	-	20
9	2	85.1	11	1770	-	576
10	2	89.2	11	1086	-	410
11	2	60.7	11	1101	-	458
12	2	75.2	11	1719	-	348
13	2	75.7	11	1799	-	481
14	3	56.7	11	1132	1884	587
15	2	65	11	1885	-	480
16	2	64.6	11	1910	-	195
17	3	69.9	11	1410	1190	396
Detection Check (1=Detection; 0=No Detection)						1



Trial Number			24			
Number of Bursts in Trial			18			
Chirp Center Frequency			5326			
Burst	No. of Pulses	Pulse Width (us)	Chirp Width (MHz)	Pulse 1-to-2 Spacing (us)	Pulse 2-to-3 Spacing (us)	Starting Location Within Interval (ms)
1	3	83.8	10	1290	1021	536
2	2	66.9	10	1112	-	44
3	3	91	10	1220	1504	611
4	2	86.1	10	1678	-	456
5	3	65.5	10	1928	1222	330
6	1	62.6	10	-	-	297
7	3	68.7	10	1505	1200	351
8	3	59.2	10	1452	1114	230
9	1	73.9	10	-	-	222
10	1	77.2	10	-	-	57
11	2	96.4	10	1357	-	399
12	2	99.9	10	1173	-	299
13	2	99.9	10	1520	-	464
14	1	86.7	10	-	-	294
15	1	92.6	10	-	-	653
16	1	77.1	10	-	-	550
17	2	81.1	10	1664	-	566
18	3	68.4	10	1536	1309	580
Detection Check (1=Detection; 0=No Detection)						1



Trial Number			25			
Number of Bursts in Trial			19			
Chirp Center Frequency			5326			
Burst	No. of Pulses	Pulse Width (us)	Chirp Width (MHz)	Pulse 1-to-2 Spacing (us)	Pulse 2-to-3 Spacing (us)	Starting Location Within Interval (ms)
1	3	68.2	9	1723	1868	471
2	3	83.7	9	1711	1405	368
3	2	69.7	9	1781	-	425
4	1	59.7	9	-	-	440
5	2	96.7	9	1484	-	123
6	2	95.8	9	1319	-	261
7	3	71.3	9	1095	1354	332
8	3	53.2	9	1527	1427	427
9	2	69.5	9	1771	-	397
10	3	63.9	9	1075	1447	67
11	2	93.4	9	1783	-	174
12	2	77.3	9	1564	-	17
13	2	73.1	9	1294	-	216
14	1	77.4	9	-	-	292
15	3	57.2	9	1722	1886	619
16	2	68.7	9	1629	-	233
17	1	60.8	9	-	-	226
18	3	69.7	9	1128	1224	599
19	1	62.2	9	-	-	433
Detection Check (1=Detection; 0=No Detection)						1



Trial Number							26
Number of Bursts in Trial							20
Chirp Center Frequency							5327
Burst	No. of Pulses	Pulse Width (us)	Chirp Width (MHz)	Pulse 1-to-2 Spacing (us)	Pulse 2-to-3 Spacing (us)	Starting Location Within Interval (ms)	
1	1	80.5	8	-	-	90	
2	3	62.6	8	1406	1343	319	
3	3	85.6	8	1190	1529	384	
4	2	83.9	8	1208	-	567	
5	2	92.4	8	1488	-	234	
6	2	54	8	1529	-	535	
7	3	81.3	8	1501	1812	325	
8	1	98.5	8	-	-	532	
9	1	85.8	8	-	-	272	
10	2	84.7	8	1593	-	182	
11	2	83.3	8	1705	-	134	
12	2	79.8	8	1567	-	286	
13	1	77.9	8	-	-	368	
14	3	98.4	8	1510	1569	290	
15	2	79.9	8	1588	-	231	
16	3	78	8	1140	1353	353	
17	3	55.2	8	1700	1327	53	
18	3	71.9	8	1081	1224	44	
19	1	62	8	-	-	298	
20	3	70.5	8	1888	1442	529	
Detection Check (1=Detection; 0=No Detection)							1

Trial Number							27
Number of Bursts in Trial							8
Chirp Center Frequency							5323
Burst	No. of Pulses	Pulse Width (us)	Chirp Width (MHz)	Pulse 1-to-2 Spacing (us)	Pulse 2-to-3 Spacing (us)	Starting Location Within Interval (ms)	
1	2	69.1	18	1076	-	1436	
2	2	62.1	18	1688	-	22	
3	2	94.8	18	1891	-	897	
4	1	75.8	18	-	-	1186	
5	2	65.4	18	1713	-	589	
6	2	97.7	18	1292	-	614	
7	3	98.1	18	1670	1711	506	
8	2	85.4	18	1672	-	776	
Detection Check (1=Detection; 0=No Detection)							1



Trial Number							28
Number of Bursts in Trial							9
Chirp Center Frequency							5322
Burst	No. of Pulses	Pulse Width (us)	Chirp Width (MHz)	Pulse 1-to-2 Spacing (us)	Pulse 2-to-3 Spacing (us)	Starting Location Within Interval (ms)	
1	3	82	19	1233	1713	679	
2	3	87.7	19	1554	1123	473	
3	2	98.9	19	1518	-	869	
4	1	55	19	-	-	719	
5	1	93.6	19	-	-	902	
6	2	58.7	19	1641	-	1243	
7	2	88.7	19	1387	-	410	
8	1	60.3	19	-	-	1154	
9	1	97.7	19	-	-	512	
Detection Check (1=Detection; 0=No Detection)							0

Trial Number							29
Number of Bursts in Trial							10
Chirp Center Frequency							5322
Burst	No. of Pulses	Pulse Width (us)	Chirp Width (MHz)	Pulse 1-to-2 Spacing (us)	Pulse 2-to-3 Spacing (us)	Starting Location Within Interval (ms)	
1	1	69.6	20	-	-	1131	
2	1	74.5	20	-	-	290	
3	1	60.9	20	-	-	895	
4	1	74.6	20	-	-	202	
5	2	99.3	20	1501	-	139	
6	2	95.3	20	1065	-	854	
7	2	91.9	20	1722	-	219	
8	2	51	20	1285	-	57	
9	2	87.7	20	1747	-	141	
10	1	87.2	20	-	-	596	
Detection Check (1=Detection; 0=No Detection)							0



Trial Number		30				
Number of Bursts in Trial		11				
Chirp Center Frequency		5328				
Burst	No. of Pulses	Pulse Width (us)	Chirp Width (MHz)	Pulse 1-to-2 Spacing (us)	Pulse 2-to-3 Spacing (us)	Starting Location Within Interval (ms)
1	3	59.9	5	1901	1196	935
2	2	77.1	5	1590	-	1038
3	2	62.7	5	1227	-	690
4	1	77.1	5	-	-	547
5	3	99.8	5	1798	1790	551
6	2	61.5	5	1135	-	876
7	2	77.5	5	1583	-	448
8	2	57.3	5	1890	-	736
9	2	53.5	5	1757	-	362
10	1	66.6	5	-	-	836
11	3	80.7	5	1811	1289	410
Detection Check (1=Detection; 0=No Detection)						1



Type 6 Radar Statistical Performance

Trial #	Test Freq. (MHz)	Pulses / Hop	Pulse Width (us)	PRI (us)	1=Detection 0=No Detection
1	5310	9	1	333	1
2	5310	9	1	333	1
3	5310	9	1	333	1
4	5310	9	1	333	1
5	5310	9	1	333	1
6	5310	9	1	333	1
7	5310	9	1	333	1
8	5310	9	1	333	1
9	5310	9	1	333	1
10	5310	9	1	333	1
11	5310	9	1	333	1
12	5310	9	1	333	1
13	5310	9	1	333	1
14	5310	9	1	333	1
15	5310	9	1	333	1
16	5310	9	1	333	1
17	5310	9	1	333	1
18	5310	9	1	333	1
19	5310	9	1	333	1
20	5310	9	1	333	1
21	5310	9	1	333	1
22	5310	9	1	333	1
23	5310	9	1	333	1
24	5310	9	1	333	1
25	5310	9	1	333	1
26	5310	9	1	333	1
27	5310	9	1	333	1
28	5310	9	1	333	1
29	5310	9	1	333	1
30	5310	9	1	333	1
Detection Percentage (%)					100.000
Limit					70%
Test Result					Complied



Modulation Mode: 802.11ax(80MHz) / 5290 MHz

Type 1 Radar Statistical Performance

Trial #	Test Freq. (MHz)	Pulse Repetition Frequency Number	Pulse Repetition Frequency (Pulse Per Second)	PRI (us)	1=Detection 0=No Detection
1	5284	1	1930.5	518	1
2	5289	23	326.2	3066	1
3	5279	19	1139.0	878	1
4	5298	12	1355.0	738	1
5	5322	4	1730.1	578	1
6	5306	8	1519.8	658	1
7	5267	15	1253.1	798	1
8	5328	6	1618.1	618	1
9	5270	14	1285.3	778	1
10	5260	3	1792.1	558	1
11	5329	13	1319.3	758	1
12	5319	9	1474.9	678	1
13	5312	7	1567.4	638	1
14	5260	17	1193.3	838	1
15	5252	10	1432.7	698	1
16	5327	-	1692.0	591	1
17	5294	-	328.1	3048	1
18	5326	-	373.4	2678	1
19	5300	-	574.4	1741	1
20	5329	-	1216.5	822	1
21	5324	-	801.3	1248	1
22	5283	-	488.5	2047	1
23	5251	-	956.0	1046	1
24	5273	-	517.6	1932	1
25	5305	-	1422.5	703	1
26	5289	-	542.0	1845	1
27	5313	-	741.3	1349	1
28	5319	-	881.8	1134	0
29	5296	-	427.4	2340	1
30	5289	-	628.9	1590	1
Detection Percentage (%)					96.667
Limit					60%
Test Result					Complied



Type 2 Radar Statistical Performance

Trial #	Test Freq. (MHz)	Pulse Width (us)	PRI (us)	Pulses / Burst	1=Detection 0=No Detection
1	5323	2.6	221	23	1
2	5267	4.6	198	27	1
3	5280	1.1	184	29	1
4	5252	4.8	203	24	1
5	5275	2.4	162	25	0
6	5305	3.4	204	28	1
7	5319	2.3	170	27	1
8	5269	3.5	184	23	0
9	5289	4.9	150	27	1
10	5317	4.6	211	29	1
11	5304	2.9	158	23	1
12	5306	2.6	226	27	0
13	5288	1.6	204	26	1
14	5252	3.9	181	25	1
15	5289	4.6	202	24	1
16	5318	4.1	194	27	1
17	5289	2.3	193	28	1
18	5305	3.9	173	29	0
19	5322	4.3	188	23	1
20	5292	1.5	215	26	1
21	5321	4.9	227	27	0
22	5283	1.1	199	23	1
23	5256	4.5	155	29	1
24	5277	4.0	190	27	1
25	5252	2.4	151	23	1
26	5308	2.5	180	28	0
27	5262	2.5	228	23	1
28	5329	2.5	203	25	1
29	5308	1.5	188	25	1
30	5282	1.9	217	24	1
Detection Percentage (%)					80.000
Limit					60%
Test Result					Complied



Type 3 Radar Statistical Performance

Trial #	Test Freq. (MHz)	Pulse Width (us)	PRI (us)	Pulses / Burst	1=Detection 0=No Detection
1	5299	8.0	205	16	1
2	5280	6.7	382	18	1
3	5283	8.6	418	16	1
4	5319	9.4	351	17	0
5	5314	7.4	383	18	1
6	5270	9.8	232	16	1
7	5275	9.1	377	17	0
8	5309	9.6	457	16	1
9	5267	8.0	471	18	1
10	5271	9.0	304	18	1
11	5291	8.0	316	17	1
12	5258	9.8	325	16	0
13	5256	8.0	409	17	1
14	5300	9.9	200	17	1
15	5307	8.8	458	16	1
16	5314	8.0	232	18	1
17	5286	8.3	250	16	0
18	5317	8.7	270	16	1
19	5319	7.7	350	17	1
20	5284	7.1	230	16	1
21	5290	7.3	416	18	0
22	5328	7.6	498	18	1
23	5320	7.3	286	17	1
24	5284	7.3	287	16	1
25	5283	7.5	462	17	1
26	5294	6.2	300	17	0
27	5306	6.4	323	18	1
28	5260	7.1	420	16	0
29	5317	7.2	395	18	1
30	5295	8.4	377	16	1
Detection Percentage (%)					76.667
Limit					60%
Test Result					Complied



Type 4 Radar Statistical Performance

Trial #	Test Freq. (MHz)	Pulse Width (us)	PRI (us)	Pulses / Burst	1=Detection 0=No Detection
1	5278	18.0	242	15	1
2	5329	19.9	279	12	1
3	5290	12.9	487	14	0
4	5276	15.0	452	13	1
5	5317	16.3	230	12	0
6	5266	19.8	238	13	1
7	5300	18.2	420	16	1
8	5288	16.3	452	15	1
9	5256	14.2	495	12	0
10	5270	17.8	228	16	1
11	5303	19.1	211	16	0
12	5315	18.4	283	15	1
13	5325	11.8	411	12	1
14	5257	14.2	284	13	1
15	5322	13.9	202	12	0
16	5262	17.8	340	14	1
17	5272	15.6	290	16	1
18	5279	14.6	250	16	0
19	5302	14.4	484	15	1
20	5316	18.9	387	13	1
21	5261	11.1	348	15	0
22	5327	13.8	291	16	1
23	5296	14.3	295	12	1
24	5263	12.5	300	12	0
25	5277	12.5	322	14	1
26	5326	12.5	383	13	1
27	5283	15.7	322	16	0
28	5251	19.8	469	13	1
29	5307	18.6	406	15	1
30	5318	15.9	238	14	1
Detection Percentage (%)					70.000
Limit					60%
Test Result					Complied



Total Type 1~4 Radar Statistical Performance

Radar Type #	Detection Percentage (%)
1	96.667
2	80.000
3	76.667
4	70.000
Aggregate (Radar Types 1-4)	80.833
Limit	80%
Test Result	Complied



Type 5 Radar Statistical Performance

Center Freq. (MHz)	Low Edge (MHz)	High Edge (MHz)	VSG Freq. (MHz)	Detection
Trial	Chirp	Offset		
1	5	2	5290.0	1
2	20	8	5290.0	1
3	7	2.8	5290.0	1
4	8	3.2	5290.0	1
5	9	3.6	5290.0	1
6	10	4	5290.0	1
7	11	4.4	5290.0	0
8	12	4.8	5290.0	1
9	13	5.2	5290.0	1
10	14	5.6	5290.0	1
11	15	6	5257.0	1
12	16	6.4	5257.4	1
13	17	6.8	5257.8	1
14	20	8	5259.0	1
15	19	7.6	5258.6	1
16	18	7.2	5258.2	1
17	17	6.8	5257.8	0
18	16	6.4	5257.4	1
19	15	6	5257.0	0
20	14	5.6	5256.6	1
21	13	5.2	5323.8	1
22	12	4.8	5324.2	1
23	11	4.4	5324.6	1
24	10	4	5325.0	1
25	9	3.6	5325.4	1
26	8	3.2	5325.8	1
27	18	7.2	5321.8	1
28	19	7.6	5321.4	0
29	20	8	5321.0	1
30	5	2	5327.0	1
Total				26
Detection Percentage (%)				87%
Limit				80%
Test Result				Complied



Trial Number							1
Number of Bursts in Trial							8
Chirp Center Frequency							5290
Burst	No. of Pulses	Pulse Width (us)	Chirp Width (MHz)	Pulse 1-to-2 Spacing (us)	Pulse 2-to-3 Spacing (us)	Starting Location Within Interval (ms)	
1	1	62.1	5	-	-	1091	
2	2	56	5	1729	-	133	
3	2	91.3	5	1230	-	1057	
4	3	50.7	5	1762	1616	1442	
5	2	92.6	5	1723	-	544	
6	2	87.3	5	1302	-	1089	
7	2	59.5	5	1291	-	1374	
8	2	52.2	5	1653	-	1237	
Detection Check (1=Detection; 0=No Detection)							1

Trial Number							2
Number of Bursts in Trial							9
Chirp Center Frequency							5290
Burst	No. of Pulses	Pulse Width (us)	Chirp Width (MHz)	Pulse 1-to-2 Spacing (us)	Pulse 2-to-3 Spacing (us)	Starting Location Within Interval (ms)	
1	3	90	20	1007	1326	30	
2	2	73.7	20	1785	-	979	
3	1	78.1	20	-	-	683	
4	2	92.4	20	1281	-	950	
5	1	61.2	20	-	-	612	
6	3	67.2	20	1525	1870	17	
7	1	78.5	20	-	-	429	
8	2	60.3	20	1931	-	936	
9	3	92.9	20	1403	1476	548	
Detection Check (1=Detection; 0=No Detection)							1



Trial Number							3
Number of Bursts in Trial							10
Chirp Center Frequency							5290
Burst	No. of Pulses	Pulse Width (us)	Chirp Width (MHz)	Pulse 1-to-2 Spacing (us)	Pulse 2-to-3 Spacing (us)	Starting Location Within Interval (ms)	
1	3	63.4	7	1574	1607	801	
2	1	98	7	-	-	966	
3	1	58.7	7	-	-	185	
4	1	88	7	-	-	1012	
5	3	79.5	7	1562	1370	943	
6	3	57.1	7	1900	1188	686	
7	2	64.4	7	1090	-	599	
8	1	78.7	7	-	-	1089	
9	1	69.3	7	-	-	188	
10	3	55.3	7	1375	1691	933	
Detection Check (1=Detection; 0=No Detection)							1

Trial Number							4
Number of Bursts in Trial							11
Chirp Center Frequency							5290
Burst	No. of Pulses	Pulse Width (us)	Chirp Width (MHz)	Pulse 1-to-2 Spacing (us)	Pulse 2-to-3 Spacing (us)	Starting Location Within Interval (ms)	
1	2	74.3	8	1642	-	24	
2	1	83.1	8	-	-	985	
3	2	59.5	8	1680	-	988	
4	2	59.8	8	1786	-	800	
5	2	77.6	8	1617	-	339	
6	2	79.9	8	1553	-	1040	
7	1	56	8	-	-	544	
8	3	71.4	8	1406	1927	452	
9	1	97.4	8	-	-	204	
10	2	98.3	8	1037	-	926	
11	1	63.6	8	-	-	1052	
Detection Check (1=Detection; 0=No Detection)							1



Trial Number							5
Number of Bursts in Trial							12
Chirp Center Frequency							5290
Burst	No. of Pulses	Pulse Width (us)	Chirp Width (MHz)	Pulse 1-to-2 Spacing (us)	Pulse 2-to-3 Spacing (us)	Starting Location Within Interval (ms)	
1	1	50	9	-	-	557	
2	2	62.5	9	1731	-	567	
3	2	55.4	9	1070	-	460	
4	1	65.7	9	-	-	4	
5	2	58	9	1512	-	64	
6	2	60.9	9	1230	-	650	
7	3	89.6	9	1598	1738	235	
8	3	84.4	9	1271	1617	873	
9	3	72.3	9	1498	1321	901	
10	1	58.9	9	-	-	663	
11	2	74.8	9	1584	-	919	
12	1	71.8	9	-	-	375	
Detection Check (1=Detection; 0=No Detection)							1

Trial Number							6
Number of Bursts in Trial							13
Chirp Center Frequency							5290
Burst	No. of Pulses	Pulse Width (us)	Chirp Width (MHz)	Pulse 1-to-2 Spacing (us)	Pulse 2-to-3 Spacing (us)	Starting Location Within Interval (ms)	
1	2	88.1	10	1257	-	846	
2	1	58.7	10	-	-	725	
3	2	97.1	10	1037	-	30	
4	3	83.1	10	1029	1106	490	
5	1	62.1	10	-	-	262	
6	2	71.4	10	1058	-	283	
7	2	86.3	10	1867	-	49	
8	3	77.3	10	1418	1876	634	
9	1	78.9	10	-	-	304	
10	3	79.2	10	1055	1572	564	
11	3	52	10	1582	1836	852	
12	3	56.5	10	1195	1542	525	
13	3	100	10	1638	1729	750	
Detection Check (1=Detection; 0=No Detection)							1



Trial Number							7
Number of Bursts in Trial							14
Chirp Center Frequency							5290
Burst	No. of Pulses	Pulse Width (us)	Chirp Width (MHz)	Pulse 1-to-2 Spacing (us)	Pulse 2-to-3 Spacing (us)	Starting Location Within Interval (ms)	
1	2	92.7	11	1208	-	231	
2	2	81.3	11	1144	-	804	
3	2	60.4	11	1555	-	34	
4	2	62.1	11	1320	-	427	
5	1	50	11	-	-	577	
6	3	65.9	11	1020	1365	3	
7	2	73.8	11	1308	-	51	
8	2	74.3	11	1143	-	360	
9	1	62.9	11	-	-	394	
10	2	74.8	11	1404	-	317	
11	2	69.7	11	1309	-	532	
12	2	69.8	11	1688	-	339	
13	2	77.4	11	1857	-	381	
14	1	55.1	11	-	-	426	
Detection Check (1=Detection; 0=No Detection)							0

Trial Number							8
Number of Bursts in Trial							15
Chirp Center Frequency							5290
Burst	No. of Pulses	Pulse Width (us)	Chirp Width (MHz)	Pulse 1-to-2 Spacing (us)	Pulse 2-to-3 Spacing (us)	Starting Location Within Interval (ms)	
1	1	91.7	12	-	-	776	
2	2	90	12	1196	-	187	
3	3	92.3	12	1486	1853	448	
4	2	66.8	12	1545	-	702	
5	1	64	12	-	-	403	
6	3	95.4	12	1123	1473	230	
7	3	66.8	12	1867	1401	604	
8	3	67.7	12	1472	1397	38	
9	1	68.2	12	-	-	735	
10	2	82.2	12	1297	-	610	
11	1	92.1	12	-	-	618	
12	2	57	12	1764	-	705	
13	2	58.5	12	1310	-	22	
14	3	85.5	12	1630	1447	641	
15	2	82.2	12	1371	-	109	
Detection Check (1=Detection; 0=No Detection)							1



Trial Number			9			
Number of Bursts in Trial			16			
Chirp Center Frequency			5290			
Burst	No. of Pulses	Pulse Width (us)	Chirp Width (MHz)	Pulse 1-to-2 Spacing (us)	Pulse 2-to-3 Spacing (us)	Starting Location Within Interval (ms)
1	2	74.4	13	1707	-	442
2	2	63.6	13	1725	-	280
3	2	71.3	13	1704	-	459
4	3	77.6	13	1063	1405	197
5	3	65.2	13	1731	1294	101
6	3	55.1	13	1109	1549	17
7	2	96.8	13	1034	-	131
8	3	80.8	13	1533	1051	365
9	1	60.4	13	-	-	222
10	2	61.8	13	1312	-	371
11	2	71.3	13	1657	-	33
12	2	98.1	13	1024	-	291
13	1	57.9	13	-	-	188
14	1	91.8	13	-	-	163
15	2	56.7	13	1259	-	426
16	2	89.7	13	1690	-	606
Detection Check (1=Detection; 0=No Detection)						1



Trial Number			10			
Number of Bursts in Trial			17			
Chirp Center Frequency			5290			
Burst	No. of Pulses	Pulse Width (us)	Chirp Width (MHz)	Pulse 1-to-2 Spacing (us)	Pulse 2-to-3 Spacing (us)	Starting Location Within Interval (ms)
1	2	74.4	14	1107	-	462
2	1	87.6	14	-	-	653
3	2	61.7	14	1741	-	457
4	2	57.5	14	1566	-	388
5	2	66.1	14	1855	-	63
6	3	70.1	14	1044	1012	136
7	1	66.4	14	-	-	343
8	1	59.2	14	-	-	349
9	2	88.3	14	1240	-	362
10	1	64.7	14	-	-	221
11	2	73	14	1703	-	144
12	2	81.7	14	1450	-	671
13	3	70.1	14	1741	1278	320
14	1	63.6	14	-	-	196
15	1	58.7	14	-	-	413
16	2	65.9	14	1478	-	170
17	1	72.7	14	-	-	564
Detection Check (1=Detection; 0=No Detection)						1



Trial Number			11			
Number of Bursts in Trial			18			
Chirp Center Frequency			5257			
Burst	No. of Pulses	Pulse Width (us)	Chirp Width (MHz)	Pulse 1-to-2 Spacing (us)	Pulse 2-to-3 Spacing (us)	Starting Location Within Interval (ms)
1	2	72.1	15	1193	-	130
2	3	76.3	15	1484	1390	114
3	1	86.1	15	-	-	14
4	1	73.2	15	-	-	604
5	1	81.2	15	-	-	548
6	2	99.5	15	1398	-	173
7	1	93.9	15	-	-	262
8	2	75.9	15	1921	-	38
9	3	79.2	15	1100	1429	84
10	3	77	15	1166	1799	610
11	1	91.8	15	-	-	339
12	3	56.8	15	1330	1556	580
13	2	83.1	15	1556	-	295
14	2	63	15	1552	-	156
15	1	65.7	15	-	-	439
16	1	64.5	15	-	-	188
17	1	88.5	15	-	-	419
18	1	60.6	15	-	-	205
Detection Check (1=Detection; 0=No Detection)						1



Trial Number			12			
Number of Bursts in Trial			19			
Chirp Center Frequency			5257			
Burst	No. of Pulses	Pulse Width (us)	Chirp Width (MHz)	Pulse 1-to-2 Spacing (us)	Pulse 2-to-3 Spacing (us)	Starting Location Within Interval (ms)
1	2	90.5	16	1299	-	381
2	2	88.4	16	1418	-	327
3	2	53.7	16	1055	-	536
4	1	80.5	16	-	-	285
5	1	50.4	16	-	-	398
6	2	61.2	16	1749	-	439
7	2	78.8	16	1065	-	129
8	3	75	16	1748	1820	325
9	2	96.7	16	1254	-	440
10	3	76.3	16	1848	1106	397
11	1	73.3	16	-	-	232
12	2	92.4	16	1317	-	91
13	2	92.4	16	1854	-	256
14	3	64.4	16	1240	1634	582
15	2	67.3	16	1473	-	117
16	2	84.1	16	1795	-	202
17	1	80.9	16	-	-	135
18	1	74.6	16	-	-	396
19	2	97.6	16	1805	-	615
Detection Check (1=Detection; 0=No Detection)						1



Trial Number							13
Number of Bursts in Trial							20
Chirp Center Frequency							5258
Burst	No. of Pulses	Pulse Width (us)	Chirp Width (MHz)	Pulse 1-to-2 Spacing (us)	Pulse 2-to-3 Spacing (us)	Starting Location Within Interval (ms)	
1	2	66.1	17	1417	-	388	
2	2	86.7	17	1693	-	348	
3	2	70.5	17	1263	-	215	
4	2	78	17	1446	-	28	
5	2	66	17	1185	-	585	
6	2	80.6	17	1855	-	65	
7	1	95.5	17	-	-	92	
8	1	98.8	17	-	-	68	
9	3	64.3	17	1641	1108	517	
10	1	75.1	17	-	-	121	
11	2	72.6	17	1499	-	448	
12	1	60.3	17	-	-	567	
13	2	54.9	17	1056	-	245	
14	2	98.8	17	1023	-	584	
15	2	60.9	17	1243	-	579	
16	2	62.7	17	1226	-	464	
17	1	80.1	17	-	-	89	
18	2	70.9	17	1711	-	153	
19	1	90.7	17	-	-	282	
20	1	98.9	17	-	-	71	
Detection Check (1=Detection; 0=No Detection)							1

Trial Number							14
Number of Bursts in Trial							8
Chirp Center Frequency							5259
Burst	No. of Pulses	Pulse Width (us)	Chirp Width (MHz)	Pulse 1-to-2 Spacing (us)	Pulse 2-to-3 Spacing (us)	Starting Location Within Interval (ms)	
1	2	67.5	20	1542	-	947	
2	3	83.6	20	1272	1696	124	
3	2	93.2	20	1877	-	701	
4	1	55.6	20	-	-	1123	
5	3	84.2	20	1733	1619	756	
6	3	69.1	20	1612	1071	1	
7	2	66.9	20	1905	-	7	
8	3	86.8	20	1697	1621	1082	
Detection Check (1=Detection; 0=No Detection)							1



Trial Number							15
Number of Bursts in Trial							9
Chirp Center Frequency							5259
Burst	No. of Pulses	Pulse Width (us)	Chirp Width (MHz)	Pulse 1-to-2 Spacing (us)	Pulse 2-to-3 Spacing (us)	Starting Location Within Interval (ms)	
1	2	62.2	19	1571	-	949	
2	2	85	19	1669	-	189	
3	2	64.5	19	1505	-	176	
4	2	50.4	19	1325	-	538	
5	2	66.1	19	1483	-	908	
6	2	71.2	19	1110	-	1017	
7	3	53.7	19	1445	1677	492	
8	3	62.5	19	1596	1341	349	
9	3	62	19	1929	1221	1105	
Detection Check (1=Detection; 0=No Detection)							1

Trial Number							16
Number of Bursts in Trial							10
Chirp Center Frequency							5258
Burst	No. of Pulses	Pulse Width (us)	Chirp Width (MHz)	Pulse 1-to-2 Spacing (us)	Pulse 2-to-3 Spacing (us)	Starting Location Within Interval (ms)	
1	2	80.5	18	1910	-	284	
2	2	64.2	18	1661	-	751	
3	2	90.1	18	1041	-	491	
4	2	69.8	18	1495	-	107	
5	1	73.1	18	-	-	490	
6	3	77.2	18	1418	1145	1155	
7	3	52.6	18	1732	1787	772	
8	2	71.4	18	1562	-	121	
9	2	89.8	18	1491	-	89	
10	2	76.4	18	1355	-	615	
Detection Check (1=Detection; 0=No Detection)							1



Trial Number							17
Number of Bursts in Trial							11
Chirp Center Frequency							5258
Burst	No. of Pulses	Pulse Width (us)	Chirp Width (MHz)	Pulse 1-to-2 Spacing (us)	Pulse 2-to-3 Spacing (us)	Starting Location Within Interval (ms)	
1	2	51.2	17	1236	-	740	
2	1	71.7	17	-	-	941	
3	2	74.7	17	1164	-	370	
4	2	50.9	17	1919	-	371	
5	2	65.2	17	1206	-	1033	
6	2	98	17	1182	-	346	
7	2	58.7	17	1612	-	639	
8	1	63.8	17	-	-	1056	
9	3	86.3	17	1545	1065	205	
10	1	94.4	17	-	-	753	
11	3	88.5	17	1699	1319	58	
Detection Check (1=Detection; 0=No Detection)							0

Trial Number							18
Number of Bursts in Trial							12
Chirp Center Frequency							5257
Burst	No. of Pulses	Pulse Width (us)	Chirp Width (MHz)	Pulse 1-to-2 Spacing (us)	Pulse 2-to-3 Spacing (us)	Starting Location Within Interval (ms)	
1	2	88.7	16	1405	-	448	
2	3	90.2	16	1544	1235	621	
3	1	96.5	16	-	-	512	
4	2	80.5	16	1090	-	321	
5	2	63.7	16	1268	-	798	
6	1	53.4	16	-	-	809	
7	2	52.3	16	1043	-	301	
8	3	54.7	16	1701	1104	796	
9	3	75.6	16	1923	1729	669	
10	2	59.2	16	1244	-	369	
11	1	56.3	16	-	-	51	
12	2	87.8	16	1608	-	733	
Detection Check (1=Detection; 0=No Detection)							1



Trial Number							19
Number of Bursts in Trial							13
Chirp Center Frequency							5257
Burst	No. of Pulses	Pulse Width (us)	Chirp Width (MHz)	Pulse 1-to-2 Spacing (us)	Pulse 2-to-3 Spacing (us)	Starting Location Within Interval (ms)	
1	2	68.2	15	1104	-	229	
2	2	58.4	15	1627	-	488	
3	3	74.7	15	1861	1015	137	
4	2	58.2	15	1593	-	520	
5	1	51.6	15	-	-	799	
6	2	94.7	15	1469	-	43	
7	2	70.7	15	1091	-	126	
8	2	82.9	15	1472	-	607	
9	3	62.7	15	1168	1453	527	
10	2	63.1	15	1529	-	143	
11	1	96.1	15	-	-	176	
12	2	57	15	1457	-	882	
13	3	95.6	15	1707	1501	214	
Detection Check (1=Detection; 0=No Detection)							0

Trial Number							20
Number of Bursts in Trial							14
Chirp Center Frequency							5257
Burst	No. of Pulses	Pulse Width (us)	Chirp Width (MHz)	Pulse 1-to-2 Spacing (us)	Pulse 2-to-3 Spacing (us)	Starting Location Within Interval (ms)	
1	1	95.7	14	-	-	117	
2	1	93.1	14	-	-	720	
3	1	55.8	14	-	-	297	
4	1	76.7	14	-	-	284	
5	2	68	14	1686	-	472	
6	3	94.1	14	1796	1393	264	
7	2	53.9	14	1293	-	525	
8	1	99.3	14	-	-	155	
9	2	73.3	14	1458	-	65	
10	2	93.3	14	1196	-	451	
11	3	55.8	14	1895	1034	243	
12	1	66.4	14	-	-	228	
13	2	65.6	14	1732	-	746	
14	2	76.5	14	1187	-	522	
Detection Check (1=Detection; 0=No Detection)							1



Trial Number							21
Number of Bursts in Trial							15
Chirp Center Frequency							5324
Burst	No. of Pulses	Pulse Width (us)	Chirp Width (MHz)	Pulse 1-to-2 Spacing (us)	Pulse 2-to-3 Spacing (us)	Starting Location Within Interval (ms)	
1	1	85.1	13	-	-	565	
2	2	72.5	13	1648	-	211	
3	1	67.5	13	-	-	348	
4	2	56.1	13	1360	-	156	
5	1	71.1	13	-	-	718	
6	2	93.1	13	1391	-	400	
7	1	56.5	13	-	-	482	
8	1	63.8	13	-	-	703	
9	2	67.4	13	1727	-	780	
10	1	52.3	13	-	-	102	
11	3	62.4	13	1228	1715	304	
12	2	53.3	13	1630	-	57	
13	2	83.1	13	1205	-	768	
14	2	93.7	13	1085	-	461	
15	2	90.7	13	1297	-	746	
Detection Check (1=Detection; 0=No Detection)							1

Trial Number							22
Number of Bursts in Trial							16
Chirp Center Frequency							5324
Burst	No. of Pulses	Pulse Width (us)	Chirp Width (MHz)	Pulse 1-to-2 Spacing (us)	Pulse 2-to-3 Spacing (us)	Starting Location Within Interval (ms)	
1	2	98.8	12	1439	-	95	
2	1	54.5	12	-	-	676	
3	2	80.5	12	1360	-	8	
4	2	55.9	12	1906	-	373	
5	2	72.1	12	1623	-	254	
6	2	84.4	12	1604	-	480	
7	1	78.5	12	-	-	663	
8	1	88	12	-	-	314	
9	2	74.7	12	1157	-	596	
10	2	97.1	12	1673	-	264	
11	1	81.6	12	-	-	740	
12	1	83.6	12	-	-	163	
13	3	87.6	12	1757	1322	628	
14	2	58.5	12	1372	-	132	
15	3	91.8	12	1767	1183	106	
16	2	58.8	12	1432	-	659	
Detection Check (1=Detection; 0=No Detection)							1



Trial Number			23			
Number of Bursts in Trial			17			
Chirp Center Frequency			5325			
Burst	No. of Pulses	Pulse Width (us)	Chirp Width (MHz)	Pulse 1-to-2 Spacing (us)	Pulse 2-to-3 Spacing (us)	Starting Location Within Interval (ms)
1	1	96	11	-	-	284
2	2	92.5	11	1241	-	488
3	2	89.5	11	1347	-	76
4	2	74.8	11	1607	-	688
5	2	60.6	11	1523	-	28
6	2	71.5	11	1659	-	383
7	2	71.1	11	1454	-	182
8	1	98.7	11	-	-	20
9	2	85.1	11	1770	-	576
10	2	89.2	11	1086	-	410
11	2	60.7	11	1101	-	458
12	2	75.2	11	1719	-	348
13	2	75.7	11	1799	-	481
14	3	56.7	11	1132	1884	587
15	2	65	11	1885	-	480
16	2	64.6	11	1910	-	195
17	3	69.9	11	1410	1190	396
Detection Check (1=Detection; 0=No Detection)						1



Trial Number			24			
Number of Bursts in Trial			18			
Chirp Center Frequency			5325			
Burst	No. of Pulses	Pulse Width (us)	Chirp Width (MHz)	Pulse 1-to-2 Spacing (us)	Pulse 2-to-3 Spacing (us)	Starting Location Within Interval (ms)
1	3	83.8	10	1290	1021	536
2	2	66.9	10	1112	-	44
3	3	91	10	1220	1504	611
4	2	86.1	10	1678	-	456
5	3	65.5	10	1928	1222	330
6	1	62.6	10	-	-	297
7	3	68.7	10	1505	1200	351
8	3	59.2	10	1452	1114	230
9	1	73.9	10	-	-	222
10	1	77.2	10	-	-	57
11	2	96.4	10	1357	-	399
12	2	99.9	10	1173	-	299
13	2	99.9	10	1520	-	464
14	1	86.7	10	-	-	294
15	1	92.6	10	-	-	653
16	1	77.1	10	-	-	550
17	2	81.1	10	1664	-	566
18	3	68.4	10	1536	1309	580
Detection Check (1=Detection; 0=No Detection)						1



Trial Number			25			
Number of Bursts in Trial			19			
Chirp Center Frequency			5325			
Burst	No. of Pulses	Pulse Width (us)	Chirp Width (MHz)	Pulse 1-to-2 Spacing (us)	Pulse 2-to-3 Spacing (us)	Starting Location Within Interval (ms)
1	3	68.2	9	1723	1868	471
2	3	83.7	9	1711	1405	368
3	2	69.7	9	1781	-	425
4	1	59.7	9	-	-	440
5	2	96.7	9	1484	-	123
6	2	95.8	9	1319	-	261
7	3	71.3	9	1095	1354	332
8	3	53.2	9	1527	1427	427
9	2	69.5	9	1771	-	397
10	3	63.9	9	1075	1447	67
11	2	93.4	9	1783	-	174
12	2	77.3	9	1564	-	17
13	2	73.1	9	1294	-	216
14	1	77.4	9	-	-	292
15	3	57.2	9	1722	1886	619
16	2	68.7	9	1629	-	233
17	1	60.8	9	-	-	226
18	3	69.7	9	1128	1224	599
19	1	62.2	9	-	-	433
Detection Check (1=Detection; 0=No Detection)						1



Trial Number							26
Number of Bursts in Trial							20
Chirp Center Frequency							5326
Burst	No. of Pulses	Pulse Width (us)	Chirp Width (MHz)	Pulse 1-to-2 Spacing (us)	Pulse 2-to-3 Spacing (us)	Starting Location Within Interval (ms)	
1	1	80.5	8	-	-	90	
2	3	62.6	8	1406	1343	319	
3	3	85.6	8	1190	1529	384	
4	2	83.9	8	1208	-	567	
5	2	92.4	8	1488	-	234	
6	2	54	8	1529	-	535	
7	3	81.3	8	1501	1812	325	
8	1	98.5	8	-	-	532	
9	1	85.8	8	-	-	272	
10	2	84.7	8	1593	-	182	
11	2	83.3	8	1705	-	134	
12	2	79.8	8	1567	-	286	
13	1	77.9	8	-	-	368	
14	3	98.4	8	1510	1569	290	
15	2	79.9	8	1588	-	231	
16	3	78	8	1140	1353	353	
17	3	55.2	8	1700	1327	53	
18	3	71.9	8	1081	1224	44	
19	1	62	8	-	-	298	
20	3	70.5	8	1888	1442	529	
Detection Check (1=Detection; 0=No Detection)							1

Trial Number							27
Number of Bursts in Trial							8
Chirp Center Frequency							5322
Burst	No. of Pulses	Pulse Width (us)	Chirp Width (MHz)	Pulse 1-to-2 Spacing (us)	Pulse 2-to-3 Spacing (us)	Starting Location Within Interval (ms)	
1	2	69.1	18	1076	-	1436	
2	2	62.1	18	1688	-	22	
3	2	94.8	18	1891	-	897	
4	1	75.8	18	-	-	1186	
5	2	65.4	18	1713	-	589	
6	2	97.7	18	1292	-	614	
7	3	98.1	18	1670	1711	506	
8	2	85.4	18	1672	-	776	
Detection Check (1=Detection; 0=No Detection)							1



Trial Number							28
Number of Bursts in Trial							9
Chirp Center Frequency							5321
Burst	No. of Pulses	Pulse Width (us)	Chirp Width (MHz)	Pulse 1-to-2 Spacing (us)	Pulse 2-to-3 Spacing (us)	Starting Location Within Interval (ms)	
1	3	82	19	1233	1713	679	
2	3	87.7	19	1554	1123	473	
3	2	98.9	19	1518	-	869	
4	1	55	19	-	-	719	
5	1	93.6	19	-	-	902	
6	2	58.7	19	1641	-	1243	
7	2	88.7	19	1387	-	410	
8	1	60.3	19	-	-	1154	
9	1	97.7	19	-	-	512	
Detection Check (1=Detection; 0=No Detection)							0

Trial Number							29
Number of Bursts in Trial							10
Chirp Center Frequency							5321
Burst	No. of Pulses	Pulse Width (us)	Chirp Width (MHz)	Pulse 1-to-2 Spacing (us)	Pulse 2-to-3 Spacing (us)	Starting Location Within Interval (ms)	
1	1	69.6	20	-	-	1131	
2	1	74.5	20	-	-	290	
3	1	60.9	20	-	-	895	
4	1	74.6	20	-	-	202	
5	2	99.3	20	1501	-	139	
6	2	95.3	20	1065	-	854	
7	2	91.9	20	1722	-	219	
8	2	51	20	1285	-	57	
9	2	87.7	20	1747	-	141	
10	1	87.2	20	-	-	596	
Detection Check (1=Detection; 0=No Detection)							1



Trial Number			30			
Number of Bursts in Trial			11			
Chirp Center Frequency			5327			
Burst	No. of Pulses	Pulse Width (us)	Chirp Width (MHz)	Pulse 1-to-2 Spacing (us)	Pulse 2-to-3 Spacing (us)	Starting Location Within Interval (ms)
1	3	59.9	5	1901	1196	935
2	2	77.1	5	1590	-	1038
3	2	62.7	5	1227	-	690
4	1	77.1	5	-	-	547
5	3	99.8	5	1798	1790	551
6	2	61.5	5	1135	-	876
7	2	77.5	5	1583	-	448
8	2	57.3	5	1890	-	736
9	2	53.5	5	1757	-	362
10	1	66.6	5	-	-	836
11	3	80.7	5	1811	1289	410
Detection Check (1=Detection; 0=No Detection)						1



Type 6 Radar Statistical Performance

Trial #	Test Freq. (MHz)	Pulses / Hop	Pulse Width (us)	PRI (us)	1=Detection 0=No Detection
1	5290	9	1	333	1
2	5290	9	1	333	1
3	5290	9	1	333	1
4	5290	9	1	333	1
5	5290	9	1	333	1
6	5290	9	1	333	1
7	5290	9	1	333	1
8	5290	9	1	333	1
9	5290	9	1	333	1
10	5290	9	1	333	1
11	5290	9	1	333	1
12	5290	9	1	333	1
13	5290	9	1	333	1
14	5290	9	1	333	1
15	5290	9	1	333	1
16	5290	9	1	333	1
17	5290	9	1	333	1
18	5290	9	1	333	1
19	5290	9	1	333	1
20	5290	9	1	333	1
21	5290	9	1	333	1
22	5290	9	1	333	1
23	5290	9	1	333	1
24	5290	9	1	333	1
25	5290	9	1	333	1
26	5290	9	1	333	1
27	5290	9	1	333	1
28	5290	9	1	333	1
29	5290	9	1	333	1
30	5290	9	1	333	1
Detection Percentage (%)					100.000
Limit					70%
Test Result					Complied



Modulation Mode: 802.11ax(20MHz) / 5500 MHz

Type 1 Radar Statistical Performance

Trial #	Test Freq. (MHz)	Pulse Repetition Frequency Number	Pulse Repetition Frequency (Pulse Per Second)	PRI (us)	1=Detection 0=No Detection
1	5509	1	1930.5	518	1
2	5505	23	326.2	3066	1
3	5501	19	1139.0	878	1
4	5506	12	1355.0	738	1
5	5494	4	1730.1	578	1
6	5503	8	1519.8	658	1
7	5494	15	1253.1	798	1
8	5501	6	1618.1	618	1
9	5506	14	1285.3	778	1
10	5491	3	1792.1	558	1
11	5495	13	1319.3	758	1
12	5509.8	9	1474.9	678	1
13	5491	7	1567.4	638	1
14	5498	17	1193.3	838	1
15	5499	10	1432.7	698	1
16	5495	-	1692.0	591	1
17	5493	-	328.1	3048	1
18	5498	-	373.4	2678	1
19	5508	-	574.4	1741	1
20	5496	-	1216.5	822	1
21	5490.5	-	801.3	1248	1
22	5500	-	488.5	2047	1
23	5498	-	956.0	1046	0
24	5497	-	517.6	1932	1
25	5498	-	1422.5	703	1
26	5507	-	542.0	1845	1
27	5506	-	741.3	1349	1
28	5504	-	881.8	1134	1
29	5504	-	427.4	2340	1
30	5493	-	628.9	1590	1
Detection Percentage (%)					96.667
Limit					60%
Test Result					Complied



Type 2 Radar Statistical Performance

Trial #	Test Freq. (MHz)	Pulse Width (us)	PRI (us)	Pulses / Burst	1=Detection 0=No Detection
1	5491	2.6	221	23	0
2	5498	4.6	198	27	1
3	5505	1.1	184	29	1
4	5490.5	4.8	203	24	1
5	5505	2.4	162	25	0
6	5504	3.4	204	28	1
7	5502	2.3	170	27	1
8	5492	3.5	184	23	1
9	5493	4.9	150	27	1
10	5506	4.6	211	29	1
11	5493	2.9	158	23	1
12	5506	2.6	226	27	1
13	5507	1.6	204	26	0
14	5497	3.9	181	25	1
15	5509	4.6	202	24	1
16	5495	4.1	194	27	1
17	5494	2.3	193	28	1
18	5492	3.9	173	29	1
19	5498	4.3	188	23	0
20	5503	1.5	215	26	1
21	5504	4.9	227	27	0
22	5507	1.1	199	23	1
23	5501	4.5	155	29	1
24	5495	4.0	190	27	1
25	5509.8	2.4	151	23	1
26	5498	2.5	180	28	1
27	5495	2.5	228	23	1
28	5500	2.5	203	25	1
29	5498	1.5	188	25	0
30	5497	1.9	217	24	1
Detection Percentage (%)					80.000
Limit					60%
Test Result					Complied



Type 3 Radar Statistical Performance

Trial #	Test Freq. (MHz)	Pulse Width (us)	PRI (us)	Pulses / Burst	1=Detection ; 0=No Detection
1	5504	8.0	205	16	1
2	5496	6.7	382	18	1
3	5491	8.6	418	16	1
4	5507	9.4	351	17	1
5	5493	7.4	383	18	1
6	5494	9.8	232	16	1
7	5500	9.1	377	17	1
8	5490.5	9.6	457	16	1
9	5495	8.0	471	18	1
10	5505	9.0	304	18	1
11	5506	8.0	316	17	1
12	5492	9.8	325	16	1
13	5505	8.0	409	17	0
14	5509	9.9	200	17	1
15	5503	8.8	458	16	1
16	5491	8.0	232	18	1
17	5502	8.3	250	16	1
18	5509.8	8.7	270	16	1
19	5492	7.7	350	17	1
20	5502	7.1	230	16	1
21	5501	7.3	416	18	1
22	5505	7.6	498	18	1
23	5501	7.3	286	17	1
24	5504	7.3	287	16	1
25	5508	7.5	462	17	1
26	5494	6.2	300	17	1
27	5491	6.4	323	18	0
28	5497	7.1	420	16	1
29	5493	7.2	395	18	1
30	5505	8.4	377	16	1
Detection Percentage (%)					93.333
Limit					60%
Test Result					Complied



Type 4 Radar Statistical Performance

Trial #	Test Freq. (MHz)	Pulse Width (us)	PRI (us)	Pulses / Burst	1=Detection 0=No Detection
1	5495	18.0	242	15	1
2	5493	19.9	279	12	1
3	5503	12.9	487	14	1
4	5495	15.0	452	13	1
5	5505	16.3	230	12	1
6	5501	19.8	238	13	1
7	5508	18.2	420	16	1
8	5503	16.3	452	15	1
9	5492	14.2	495	12	1
10	5494	17.8	228	16	1
11	5495	19.1	211	16	1
12	5508	18.4	283	15	0
13	5508	11.8	411	12	0
14	5496	14.2	284	13	1
15	5491	13.9	202	12	1
16	5508	17.8	340	14	1
17	5504	15.6	290	16	1
18	5498	14.6	250	16	0
19	5501	14.4	484	15	1
20	5493	18.9	387	13	1
21	5502	11.1	348	15	1
22	5507	13.8	291	16	1
23	5505	14.3	295	12	1
24	5493	12.5	300	12	1
25	5490.5	12.5	322	14	1
26	5509	12.5	383	13	1
27	5492	15.7	322	16	1
28	5509	19.8	469	13	1
29	5509.8	18.6	406	15	1
30	5503	15.9	238	14	1
Detection Percentage (%)					90.000
Limit					60%
Test Result					Complied



Total Type 1~4 Radar Statistical Performance

Radar Type #	Detection Percentage (%)
1	96.667
2	80.000
3	93.333
4	90.000
Aggregate (Radar Types 1-4)	90.000
Limit	80%
Test Result	Complied



Type 5 Radar Statistical Performance

Center Freq. (MHz)	Low Edge (MHz)	High Edge (MHz)	VSG Freq. (MHz)	Detection
Trial	Chirp	Offset		
1	5	2	5500.0	1
2	20	8	5500.0	0
3	7	2.8	5500.0	1
4	8	3.2	5500.0	1
5	9	3.6	5500.0	1
6	10	4	5500.0	1
7	11	4.4	5500.0	1
8	12	4.8	5500.0	1
9	13	5.2	5500.0	1
10	14	5.6	5500.0	1
11	15	6	5496.5	1
12	16	6.4	5496.9	1
13	17	6.8	5497.3	1
14	20	8	5498.5	0
15	19	7.6	5498.1	0
16	18	7.2	5497.7	1
17	17	6.8	5497.3	0
18	16	6.4	5496.9	0
19	15	6	5496.5	1
20	14	5.6	5496.1	1
21	13	5.2	5504.6	1
22	12	4.8	5505.0	1
23	11	4.4	5505.4	1
24	10	4	5505.8	0
25	9	3.6	5506.2	1
26	8	3.2	5506.6	1
27	18	7.2	5502.6	1
28	19	7.6	5502.2	1
29	20	8	5501.8	1
30	5	2	5507.8	1
Total				24
Detection Percentage (%)				80%
Limit				80%
Test Result				Complied



Trial Number							1
Number of Bursts in Trial							8
Chirp Center Frequency							5500
Burst	No. of Pulses	Pulse Width (us)	Chirp Width (MHz)	Pulse 1-to-2 Spacing (us)	Pulse 2-to-3 Spacing (us)	Starting Location Within Interval (ms)	
1	1	62.1	5	-	-	1091	
2	2	56	5	1729	-	133	
3	2	91.3	5	1230	-	1057	
4	3	50.7	5	1762	1616	1442	
5	2	92.6	5	1723	-	544	
6	2	87.3	5	1302	-	1089	
7	2	59.5	5	1291	-	1374	
8	2	52.2	5	1653	-	1237	
Detection Check (1=Detection; 0=No Detection)							1

Trial Number							2
Number of Bursts in Trial							9
Chirp Center Frequency							5500
Burst	No. of Pulses	Pulse Width (us)	Chirp Width (MHz)	Pulse 1-to-2 Spacing (us)	Pulse 2-to-3 Spacing (us)	Starting Location Within Interval (ms)	
1	3	90	20	1007	1326	30	
2	2	73.7	20	1785	-	979	
3	1	78.1	20	-	-	683	
4	2	92.4	20	1281	-	950	
5	1	61.2	20	-	-	612	
6	3	67.2	20	1525	1870	17	
7	1	78.5	20	-	-	429	
8	2	60.3	20	1931	-	936	
9	3	92.9	20	1403	1476	548	
Detection Check (1=Detection; 0=No Detection)							0



Trial Number		3				
Number of Bursts in Trial		10				
Chirp Center Frequency		5500				
Burst	No. of Pulses	Pulse Width (us)	Chirp Width (MHz)	Pulse 1-to-2 Spacing (us)	Pulse 2-to-3 Spacing (us)	Starting Location Within Interval (ms)
1	3	63.4	7	1574	1607	801
2	1	98	7	-	-	966
3	1	58.7	7	-	-	185
4	1	88	7	-	-	1012
5	3	79.5	7	1562	1370	943
6	3	57.1	7	1900	1188	686
7	2	64.4	7	1090	-	599
8	1	78.7	7	-	-	1089
9	1	69.3	7	-	-	188
10	3	55.3	7	1375	1691	933
Detection Check (1=Detection; 0=No Detection)						1

Trial Number		4				
Number of Bursts in Trial		11				
Chirp Center Frequency		5500				
Burst	No. of Pulses	Pulse Width (us)	Chirp Width (MHz)	Pulse 1-to-2 Spacing (us)	Pulse 2-to-3 Spacing (us)	Starting Location Within Interval (ms)
1	2	74.3	8	1642	-	24
2	1	83.1	8	-	-	985
3	2	59.5	8	1680	-	988
4	2	59.8	8	1786	-	800
5	2	77.6	8	1617	-	339
6	2	79.9	8	1553	-	1040
7	1	56	8	-	-	544
8	3	71.4	8	1406	1927	452
9	1	97.4	8	-	-	204
10	2	98.3	8	1037	-	926
11	1	63.6	8	-	-	1052
Detection Check (1=Detection; 0=No Detection)						1



Trial Number							5
Number of Bursts in Trial							12
Chirp Center Frequency							5500
Burst	No. of Pulses	Pulse Width (us)	Chirp Width (MHz)	Pulse 1-to-2 Spacing (us)	Pulse 2-to-3 Spacing (us)	Starting Location Within Interval (ms)	
1	1	50	9	-	-	557	
2	2	62.5	9	1731	-	567	
3	2	55.4	9	1070	-	460	
4	1	65.7	9	-	-	4	
5	2	58	9	1512	-	64	
6	2	60.9	9	1230	-	650	
7	3	89.6	9	1598	1738	235	
8	3	84.4	9	1271	1617	873	
9	3	72.3	9	1498	1321	901	
10	1	58.9	9	-	-	663	
11	2	74.8	9	1584	-	919	
12	1	71.8	9	-	-	375	
Detection Check (1=Detection; 0=No Detection)							1

Trial Number							6
Number of Bursts in Trial							13
Chirp Center Frequency							5500
Burst	No. of Pulses	Pulse Width (us)	Chirp Width (MHz)	Pulse 1-to-2 Spacing (us)	Pulse 2-to-3 Spacing (us)	Starting Location Within Interval (ms)	
1	2	88.1	10	1257	-	846	
2	1	58.7	10	-	-	725	
3	2	97.1	10	1037	-	30	
4	3	83.1	10	1029	1106	490	
5	1	62.1	10	-	-	262	
6	2	71.4	10	1058	-	283	
7	2	86.3	10	1867	-	49	
8	3	77.3	10	1418	1876	634	
9	1	78.9	10	-	-	304	
10	3	79.2	10	1055	1572	564	
11	3	52	10	1582	1836	852	
12	3	56.5	10	1195	1542	525	
13	3	100	10	1638	1729	750	
Detection Check (1=Detection; 0=No Detection)							1



Trial Number							7
Number of Bursts in Trial							14
Chirp Center Frequency							5500
Burst	No. of Pulses	Pulse Width (us)	Chirp Width (MHz)	Pulse 1-to-2 Spacing (us)	Pulse 2-to-3 Spacing (us)	Starting Location Within Interval (ms)	
1	2	92.7	11	1208	-	231	
2	2	81.3	11	1144	-	804	
3	2	60.4	11	1555	-	34	
4	2	62.1	11	1320	-	427	
5	1	50	11	-	-	577	
6	3	65.9	11	1020	1365	3	
7	2	73.8	11	1308	-	51	
8	2	74.3	11	1143	-	360	
9	1	62.9	11	-	-	394	
10	2	74.8	11	1404	-	317	
11	2	69.7	11	1309	-	532	
12	2	69.8	11	1688	-	339	
13	2	77.4	11	1857	-	381	
14	1	55.1	11	-	-	426	
Detection Check (1=Detection; 0=No Detection)							1

Trial Number							8
Number of Bursts in Trial							15
Chirp Center Frequency							5500
Burst	No. of Pulses	Pulse Width (us)	Chirp Width (MHz)	Pulse 1-to-2 Spacing (us)	Pulse 2-to-3 Spacing (us)	Starting Location Within Interval (ms)	
1	1	91.7	12	-	-	776	
2	2	90	12	1196	-	187	
3	3	92.3	12	1486	1853	448	
4	2	66.8	12	1545	-	702	
5	1	64	12	-	-	403	
6	3	95.4	12	1123	1473	230	
7	3	66.8	12	1867	1401	604	
8	3	67.7	12	1472	1397	38	
9	1	68.2	12	-	-	735	
10	2	82.2	12	1297	-	610	
11	1	92.1	12	-	-	618	
12	2	57	12	1764	-	705	
13	2	58.5	12	1310	-	22	
14	3	85.5	12	1630	1447	641	
15	2	82.2	12	1371	-	109	
Detection Check (1=Detection; 0=No Detection)							1



Trial Number			9			
Number of Bursts in Trial			16			
Chirp Center Frequency			5500			
Burst	No. of Pulses	Pulse Width (us)	Chirp Width (MHz)	Pulse 1-to-2 Spacing (us)	Pulse 2-to-3 Spacing (us)	Starting Location Within Interval (ms)
1	2	74.4	13	1707	-	442
2	2	63.6	13	1725	-	280
3	2	71.3	13	1704	-	459
4	3	77.6	13	1063	1405	197
5	3	65.2	13	1731	1294	101
6	3	55.1	13	1109	1549	17
7	2	96.8	13	1034	-	131
8	3	80.8	13	1533	1051	365
9	1	60.4	13	-	-	222
10	2	61.8	13	1312	-	371
11	2	71.3	13	1657	-	33
12	2	98.1	13	1024	-	291
13	1	57.9	13	-	-	188
14	1	91.8	13	-	-	163
15	2	56.7	13	1259	-	426
16	2	89.7	13	1690	-	606
Detection Check (1=Detection; 0=No Detection)						1



Trial Number			10			
Number of Bursts in Trial			17			
Chirp Center Frequency			5500			
Burst	No. of Pulses	Pulse Width (us)	Chirp Width (MHz)	Pulse 1-to-2 Spacing (us)	Pulse 2-to-3 Spacing (us)	Starting Location Within Interval (ms)
1	2	74.4	14	1107	-	462
2	1	87.6	14	-	-	653
3	2	61.7	14	1741	-	457
4	2	57.5	14	1566	-	388
5	2	66.1	14	1855	-	63
6	3	70.1	14	1044	1012	136
7	1	66.4	14	-	-	343
8	1	59.2	14	-	-	349
9	2	88.3	14	1240	-	362
10	1	64.7	14	-	-	221
11	2	73	14	1703	-	144
12	2	81.7	14	1450	-	671
13	3	70.1	14	1741	1278	320
14	1	63.6	14	-	-	196
15	1	58.7	14	-	-	413
16	2	65.9	14	1478	-	170
17	1	72.7	14	-	-	564
Detection Check (1=Detection; 0=No Detection)						1



Trial Number			11			
Number of Bursts in Trial			18			
Chirp Center Frequency			5497			
Burst	No. of Pulses	Pulse Width (us)	Chirp Width (MHz)	Pulse 1-to-2 Spacing (us)	Pulse 2-to-3 Spacing (us)	Starting Location Within Interval (ms)
1	2	72.1	15	1193	-	130
2	3	76.3	15	1484	1390	114
3	1	86.1	15	-	-	14
4	1	73.2	15	-	-	604
5	1	81.2	15	-	-	548
6	2	99.5	15	1398	-	173
7	1	93.9	15	-	-	262
8	2	75.9	15	1921	-	38
9	3	79.2	15	1100	1429	84
10	3	77	15	1166	1799	610
11	1	91.8	15	-	-	339
12	3	56.8	15	1330	1556	580
13	2	83.1	15	1556	-	295
14	2	63	15	1552	-	156
15	1	65.7	15	-	-	439
16	1	64.5	15	-	-	188
17	1	88.5	15	-	-	419
18	1	60.6	15	-	-	205
Detection Check (1=Detection; 0=No Detection)						1



Trial Number			12			
Number of Bursts in Trial			19			
Chirp Center Frequency			5497			
Burst	No. of Pulses	Pulse Width (us)	Chirp Width (MHz)	Pulse 1-to-2 Spacing (us)	Pulse 2-to-3 Spacing (us)	Starting Location Within Interval (ms)
1	2	90.5	16	1299	-	381
2	2	88.4	16	1418	-	327
3	2	53.7	16	1055	-	536
4	1	80.5	16	-	-	285
5	1	50.4	16	-	-	398
6	2	61.2	16	1749	-	439
7	2	78.8	16	1065	-	129
8	3	75	16	1748	1820	325
9	2	96.7	16	1254	-	440
10	3	76.3	16	1848	1106	397
11	1	73.3	16	-	-	232
12	2	92.4	16	1317	-	91
13	2	92.4	16	1854	-	256
14	3	64.4	16	1240	1634	582
15	2	67.3	16	1473	-	117
16	2	84.1	16	1795	-	202
17	1	80.9	16	-	-	135
18	1	74.6	16	-	-	396
19	2	97.6	16	1805	-	615
Detection Check (1=Detection; 0=No Detection)						1



Trial Number							13
Number of Bursts in Trial							20
Chirp Center Frequency							5497
Burst	No. of Pulses	Pulse Width (us)	Chirp Width (MHz)	Pulse 1-to-2 Spacing (us)	Pulse 2-to-3 Spacing (us)	Starting Location Within Interval (ms)	
1	2	66.1	17	1417	-	388	
2	2	86.7	17	1693	-	348	
3	2	70.5	17	1263	-	215	
4	2	78	17	1446	-	28	
5	2	66	17	1185	-	585	
6	2	80.6	17	1855	-	65	
7	1	95.5	17	-	-	92	
8	1	98.8	17	-	-	68	
9	3	64.3	17	1641	1108	517	
10	1	75.1	17	-	-	121	
11	2	72.6	17	1499	-	448	
12	1	60.3	17	-	-	567	
13	2	54.9	17	1056	-	245	
14	2	98.8	17	1023	-	584	
15	2	60.9	17	1243	-	579	
16	2	62.7	17	1226	-	464	
17	1	80.1	17	-	-	89	
18	2	70.9	17	1711	-	153	
19	1	90.7	17	-	-	282	
20	1	98.9	17	-	-	71	
Detection Check (1=Detection; 0=No Detection)							1

Trial Number							14
Number of Bursts in Trial							8
Chirp Center Frequency							5499
Burst	No. of Pulses	Pulse Width (us)	Chirp Width (MHz)	Pulse 1-to-2 Spacing (us)	Pulse 2-to-3 Spacing (us)	Starting Location Within Interval (ms)	
1	2	67.5	20	1542	-	947	
2	3	83.6	20	1272	1696	124	
3	2	93.2	20	1877	-	701	
4	1	55.6	20	-	-	1123	
5	3	84.2	20	1733	1619	756	
6	3	69.1	20	1612	1071	1	
7	2	66.9	20	1905	-	7	
8	3	86.8	20	1697	1621	1082	
Detection Check (1=Detection; 0=No Detection)							0



Trial Number							15
Number of Bursts in Trial							9
Chirp Center Frequency							5498
Burst	No. of Pulses	Pulse Width (us)	Chirp Width (MHz)	Pulse 1-to-2 Spacing (us)	Pulse 2-to-3 Spacing (us)	Starting Location Within Interval (ms)	
1	2	62.2	19	1571	-	949	
2	2	85	19	1669	-	189	
3	2	64.5	19	1505	-	176	
4	2	50.4	19	1325	-	538	
5	2	66.1	19	1483	-	908	
6	2	71.2	19	1110	-	1017	
7	3	53.7	19	1445	1677	492	
8	3	62.5	19	1596	1341	349	
9	3	62	19	1929	1221	1105	
Detection Check (1=Detection; 0=No Detection)							0

Trial Number							16
Number of Bursts in Trial							10
Chirp Center Frequency							5498
Burst	No. of Pulses	Pulse Width (us)	Chirp Width (MHz)	Pulse 1-to-2 Spacing (us)	Pulse 2-to-3 Spacing (us)	Starting Location Within Interval (ms)	
1	2	80.5	18	1910	-	284	
2	2	64.2	18	1661	-	751	
3	2	90.1	18	1041	-	491	
4	2	69.8	18	1495	-	107	
5	1	73.1	18	-	-	490	
6	3	77.2	18	1418	1145	1155	
7	3	52.6	18	1732	1787	772	
8	2	71.4	18	1562	-	121	
9	2	89.8	18	1491	-	89	
10	2	76.4	18	1355	-	615	
Detection Check (1=Detection; 0=No Detection)							1



Trial Number							17
Number of Bursts in Trial							11
Chirp Center Frequency							5497
Burst	No. of Pulses	Pulse Width (us)	Chirp Width (MHz)	Pulse 1-to-2 Spacing (us)	Pulse 2-to-3 Spacing (us)	Starting Location Within Interval (ms)	
1	2	51.2	17	1236	-	740	
2	1	71.7	17	-	-	941	
3	2	74.7	17	1164	-	370	
4	2	50.9	17	1919	-	371	
5	2	65.2	17	1206	-	1033	
6	2	98	17	1182	-	346	
7	2	58.7	17	1612	-	639	
8	1	63.8	17	-	-	1056	
9	3	86.3	17	1545	1065	205	
10	1	94.4	17	-	-	753	
11	3	88.5	17	1699	1319	58	
Detection Check (1=Detection; 0=No Detection)							0

Trial Number							18
Number of Bursts in Trial							12
Chirp Center Frequency							5497
Burst	No. of Pulses	Pulse Width (us)	Chirp Width (MHz)	Pulse 1-to-2 Spacing (us)	Pulse 2-to-3 Spacing (us)	Starting Location Within Interval (ms)	
1	2	88.7	16	1405	-	448	
2	3	90.2	16	1544	1235	621	
3	1	96.5	16	-	-	512	
4	2	80.5	16	1090	-	321	
5	2	63.7	16	1268	-	798	
6	1	53.4	16	-	-	809	
7	2	52.3	16	1043	-	301	
8	3	54.7	16	1701	1104	796	
9	3	75.6	16	1923	1729	669	
10	2	59.2	16	1244	-	369	
11	1	56.3	16	-	-	51	
12	2	87.8	16	1608	-	733	
Detection Check (1=Detection; 0=No Detection)							0



Trial Number							19
Number of Bursts in Trial							13
Chirp Center Frequency							5497
Burst	No. of Pulses	Pulse Width (us)	Chirp Width (MHz)	Pulse 1-to-2 Spacing (us)	Pulse 2-to-3 Spacing (us)	Starting Location Within Interval (ms)	
1	2	68.2	15	1104	-	229	
2	2	58.4	15	1627	-	488	
3	3	74.7	15	1861	1015	137	
4	2	58.2	15	1593	-	520	
5	1	51.6	15	-	-	799	
6	2	94.7	15	1469	-	43	
7	2	70.7	15	1091	-	126	
8	2	82.9	15	1472	-	607	
9	3	62.7	15	1168	1453	527	
10	2	63.1	15	1529	-	143	
11	1	96.1	15	-	-	176	
12	2	57	15	1457	-	882	
13	3	95.6	15	1707	1501	214	
Detection Check (1=Detection; 0=No Detection)							1

Trial Number							20
Number of Bursts in Trial							14
Chirp Center Frequency							5496
Burst	No. of Pulses	Pulse Width (us)	Chirp Width (MHz)	Pulse 1-to-2 Spacing (us)	Pulse 2-to-3 Spacing (us)	Starting Location Within Interval (ms)	
1	1	95.7	14	-	-	117	
2	1	93.1	14	-	-	720	
3	1	55.8	14	-	-	297	
4	1	76.7	14	-	-	284	
5	2	68	14	1686	-	472	
6	3	94.1	14	1796	1393	264	
7	2	53.9	14	1293	-	525	
8	1	99.3	14	-	-	155	
9	2	73.3	14	1458	-	65	
10	2	93.3	14	1196	-	451	
11	3	55.8	14	1895	1034	243	
12	1	66.4	14	-	-	228	
13	2	65.6	14	1732	-	746	
14	2	76.5	14	1187	-	522	
Detection Check (1=Detection; 0=No Detection)							1



Trial Number							21
Number of Bursts in Trial							15
Chirp Center Frequency							5505
Burst	No. of Pulses	Pulse Width (us)	Chirp Width (MHz)	Pulse 1-to-2 Spacing (us)	Pulse 2-to-3 Spacing (us)	Starting Location Within Interval (ms)	
1	1	85.1	13	-	-	565	
2	2	72.5	13	1648	-	211	
3	1	67.5	13	-	-	348	
4	2	56.1	13	1360	-	156	
5	1	71.1	13	-	-	718	
6	2	93.1	13	1391	-	400	
7	1	56.5	13	-	-	482	
8	1	63.8	13	-	-	703	
9	2	67.4	13	1727	-	780	
10	1	52.3	13	-	-	102	
11	3	62.4	13	1228	1715	304	
12	2	53.3	13	1630	-	57	
13	2	83.1	13	1205	-	768	
14	2	93.7	13	1085	-	461	
15	2	90.7	13	1297	-	746	
Detection Check (1=Detection; 0=No Detection)							1

Trial Number							22
Number of Bursts in Trial							16
Chirp Center Frequency							5505
Burst	No. of Pulses	Pulse Width (us)	Chirp Width (MHz)	Pulse 1-to-2 Spacing (us)	Pulse 2-to-3 Spacing (us)	Starting Location Within Interval (ms)	
1	2	98.8	12	1439	-	95	
2	1	54.5	12	-	-	676	
3	2	80.5	12	1360	-	8	
4	2	55.9	12	1906	-	373	
5	2	72.1	12	1623	-	254	
6	2	84.4	12	1604	-	480	
7	1	78.5	12	-	-	663	
8	1	88	12	-	-	314	
9	2	74.7	12	1157	-	596	
10	2	97.1	12	1673	-	264	
11	1	81.6	12	-	-	740	
12	1	83.6	12	-	-	163	
13	3	87.6	12	1757	1322	628	
14	2	58.5	12	1372	-	132	
15	3	91.8	12	1767	1183	106	
16	2	58.8	12	1432	-	659	
Detection Check (1=Detection; 0=No Detection)							1



Trial Number			23			
Number of Bursts in Trial			17			
Chirp Center Frequency			5505			
Burst	No. of Pulses	Pulse Width (us)	Chirp Width (MHz)	Pulse 1-to-2 Spacing (us)	Pulse 2-to-3 Spacing (us)	Starting Location Within Interval (ms)
1	1	96	11	-	-	284
2	2	92.5	11	1241	-	488
3	2	89.5	11	1347	-	76
4	2	74.8	11	1607	-	688
5	2	60.6	11	1523	-	28
6	2	71.5	11	1659	-	383
7	2	71.1	11	1454	-	182
8	1	98.7	11	-	-	20
9	2	85.1	11	1770	-	576
10	2	89.2	11	1086	-	410
11	2	60.7	11	1101	-	458
12	2	75.2	11	1719	-	348
13	2	75.7	11	1799	-	481
14	3	56.7	11	1132	1884	587
15	2	65	11	1885	-	480
16	2	64.6	11	1910	-	195
17	3	69.9	11	1410	1190	396
Detection Check (1=Detection; 0=No Detection)						1



Trial Number			24			
Number of Bursts in Trial			18			
Chirp Center Frequency			5506			
Burst	No. of Pulses	Pulse Width (us)	Chirp Width (MHz)	Pulse 1-to-2 Spacing (us)	Pulse 2-to-3 Spacing (us)	Starting Location Within Interval (ms)
1	3	83.8	10	1290	1021	536
2	2	66.9	10	1112	-	44
3	3	91	10	1220	1504	611
4	2	86.1	10	1678	-	456
5	3	65.5	10	1928	1222	330
6	1	62.6	10	-	-	297
7	3	68.7	10	1505	1200	351
8	3	59.2	10	1452	1114	230
9	1	73.9	10	-	-	222
10	1	77.2	10	-	-	57
11	2	96.4	10	1357	-	399
12	2	99.9	10	1173	-	299
13	2	99.9	10	1520	-	464
14	1	86.7	10	-	-	294
15	1	92.6	10	-	-	653
16	1	77.1	10	-	-	550
17	2	81.1	10	1664	-	566
18	3	68.4	10	1536	1309	580
Detection Check (1=Detection; 0=No Detection)						0



Trial Number			25			
Number of Bursts in Trial			19			
Chirp Center Frequency			5506			
Burst	No. of Pulses	Pulse Width (us)	Chirp Width (MHz)	Pulse 1-to-2 Spacing (us)	Pulse 2-to-3 Spacing (us)	Starting Location Within Interval (ms)
1	3	68.2	9	1723	1868	471
2	3	83.7	9	1711	1405	368
3	2	69.7	9	1781	-	425
4	1	59.7	9	-	-	440
5	2	96.7	9	1484	-	123
6	2	95.8	9	1319	-	261
7	3	71.3	9	1095	1354	332
8	3	53.2	9	1527	1427	427
9	2	69.5	9	1771	-	397
10	3	63.9	9	1075	1447	67
11	2	93.4	9	1783	-	174
12	2	77.3	9	1564	-	17
13	2	73.1	9	1294	-	216
14	1	77.4	9	-	-	292
15	3	57.2	9	1722	1886	619
16	2	68.7	9	1629	-	233
17	1	60.8	9	-	-	226
18	3	69.7	9	1128	1224	599
19	1	62.2	9	-	-	433
Detection Check (1=Detection; 0=No Detection)						1



Trial Number							26
Number of Bursts in Trial							20
Chirp Center Frequency							5507
Burst	No. of Pulses	Pulse Width (us)	Chirp Width (MHz)	Pulse 1-to-2 Spacing (us)	Pulse 2-to-3 Spacing (us)	Starting Location Within Interval (ms)	
1	1	80.5	8	-	-	90	
2	3	62.6	8	1406	1343	319	
3	3	85.6	8	1190	1529	384	
4	2	83.9	8	1208	-	567	
5	2	92.4	8	1488	-	234	
6	2	54	8	1529	-	535	
7	3	81.3	8	1501	1812	325	
8	1	98.5	8	-	-	532	
9	1	85.8	8	-	-	272	
10	2	84.7	8	1593	-	182	
11	2	83.3	8	1705	-	134	
12	2	79.8	8	1567	-	286	
13	1	77.9	8	-	-	368	
14	3	98.4	8	1510	1569	290	
15	2	79.9	8	1588	-	231	
16	3	78	8	1140	1353	353	
17	3	55.2	8	1700	1327	53	
18	3	71.9	8	1081	1224	44	
19	1	62	8	-	-	298	
20	3	70.5	8	1888	1442	529	
Detection Check (1=Detection; 0=No Detection)							1

Trial Number							27
Number of Bursts in Trial							8
Chirp Center Frequency							5503
Burst	No. of Pulses	Pulse Width (us)	Chirp Width (MHz)	Pulse 1-to-2 Spacing (us)	Pulse 2-to-3 Spacing (us)	Starting Location Within Interval (ms)	
1	2	69.1	18	1076	-	1436	
2	2	62.1	18	1688	-	22	
3	2	94.8	18	1891	-	897	
4	1	75.8	18	-	-	1186	
5	2	65.4	18	1713	-	589	
6	2	97.7	18	1292	-	614	
7	3	98.1	18	1670	1711	506	
8	2	85.4	18	1672	-	776	
Detection Check (1=Detection; 0=No Detection)							1



Trial Number							28
Number of Bursts in Trial							9
Chirp Center Frequency							5502
Burst	No. of Pulses	Pulse Width (us)	Chirp Width (MHz)	Pulse 1-to-2 Spacing (us)	Pulse 2-to-3 Spacing (us)	Starting Location Within Interval (ms)	
1	3	82	19	1233	1713	679	
2	3	87.7	19	1554	1123	473	
3	2	98.9	19	1518	-	869	
4	1	55	19	-	-	719	
5	1	93.6	19	-	-	902	
6	2	58.7	19	1641	-	1243	
7	2	88.7	19	1387	-	410	
8	1	60.3	19	-	-	1154	
9	1	97.7	19	-	-	512	
Detection Check (1=Detection; 0=No Detection)							1

Trial Number							29
Number of Bursts in Trial							10
Chirp Center Frequency							5502
Burst	No. of Pulses	Pulse Width (us)	Chirp Width (MHz)	Pulse 1-to-2 Spacing (us)	Pulse 2-to-3 Spacing (us)	Starting Location Within Interval (ms)	
1	1	69.6	20	-	-	1131	
2	1	74.5	20	-	-	290	
3	1	60.9	20	-	-	895	
4	1	74.6	20	-	-	202	
5	2	99.3	20	1501	-	139	
6	2	95.3	20	1065	-	854	
7	2	91.9	20	1722	-	219	
8	2	51	20	1285	-	57	
9	2	87.7	20	1747	-	141	
10	1	87.2	20	-	-	596	
Detection Check (1=Detection; 0=No Detection)							1



Trial Number			30			
Number of Bursts in Trial			11			
Chirp Center Frequency			5508			
Burst	No. of Pulses	Pulse Width (us)	Chirp Width (MHz)	Pulse 1-to-2 Spacing (us)	Pulse 2-to-3 Spacing (us)	Starting Location Within Interval (ms)
1	3	59.9	5	1901	1196	935
2	2	77.1	5	1590	-	1038
3	2	62.7	5	1227	-	690
4	1	77.1	5	-	-	547
5	3	99.8	5	1798	1790	551
6	2	61.5	5	1135	-	876
7	2	77.5	5	1583	-	448
8	2	57.3	5	1890	-	736
9	2	53.5	5	1757	-	362
10	1	66.6	5	-	-	836
11	3	80.7	5	1811	1289	410
Detection Check (1=Detection; 0=No Detection)						1



Type 6 Radar Statistical Performance

Trial #	Test Freq. (MHz)	Pulses / Hop	Pulse Width (us)	PRI (us)	1=Detection 0=No Detection
1	5500	9	1	333	1
2	5500	9	1	333	1
3	5500	9	1	333	1
4	5500	9	1	333	1
5	5500	9	1	333	1
6	5500	9	1	333	1
7	5500	9	1	333	1
8	5500	9	1	333	1
9	5500	9	1	333	1
10	5500	9	1	333	1
11	5500	9	1	333	1
12	5500	9	1	333	1
13	5500	9	1	333	1
14	5500	9	1	333	1
15	5500	9	1	333	1
16	5500	9	1	333	1
17	5500	9	1	333	1
18	5500	9	1	333	1
19	5500	9	1	333	1
20	5500	9	1	333	1
21	5500	9	1	333	1
22	5500	9	1	333	1
23	5500	9	1	333	1
24	5500	9	1	333	1
25	5500	9	1	333	1
26	5500	9	1	333	1
27	5500	9	1	333	1
28	5500	9	1	333	1
29	5500	9	1	333	1
30	5500	9	1	333	1
Detection Percentage (%)					100.000
Limit					70%
Test Result					Complied



Modulation Mode: 802.11ax(40MHz) / 5550 MHz

Type 1 Radar Statistical Performance

Trial #	Test Freq. (MHz)	Pulse Repetition Frequency Number	Pulse Repetition Frequency (Pulse Per Second)	PRI (us)	1=Detection 0=No Detection
1	5491	1	1930.5	518	1
2	5522	23	326.2	3066	1
3	5509	19	1139.0	878	1
4	5503	12	1355.0	738	1
5	5520	4	1730.1	578	1
6	5506	8	1519.8	658	1
7	5515	15	1253.1	798	1
8	5492	6	1618.1	618	1
9	5525	14	1285.3	778	1
10	5520	3	1792.1	558	1
11	5518	13	1319.3	758	1
12	5526	9	1474.9	678	1
13	5525	7	1567.4	638	1
14	5510	17	1193.3	838	1
15	5519	10	1432.7	698	1
16	5517	-	1692.0	591	1
17	5519	-	328.1	3048	1
18	5508	-	373.4	2678	1
19	5501	-	574.4	1741	1
20	5528	-	1216.5	822	1
21	5523	-	801.3	1248	1
22	5528	-	488.5	2047	1
23	5503	-	956.0	1046	1
24	5527	-	517.6	1932	1
25	5523	-	1422.5	703	1
26	5493	-	542.0	1845	1
27	5496	-	741.3	1349	1
28	5515	-	881.8	1134	1
29	5514	-	427.4	2340	1
30	5522	-	628.9	1590	0
Detection Percentage (%)					96.667
Limit					60%
Test Result					Complied



Type 2 Radar Statistical Performance

Trial #	Test Freq. (MHz)	Pulse Width (us)	PRI (us)	Pulses / Burst	1=Detection 0=No Detection
1	5503	2.6	221	23	1
2	5509	4.6	198	27	1
3	5504	1.1	184	29	1
4	5529	4.8	203	24	0
5	5509	2.4	162	25	1
6	5522	3.4	204	28	1
7	5503	2.3	170	27	0
8	5526	3.5	184	23	1
9	5516	4.9	150	27	1
10	5498	4.6	211	29	1
11	5498	2.9	158	23	1
12	5494	2.6	226	27	1
13	5516	1.6	204	26	1
14	5502	3.9	181	25	1
15	5519	4.6	202	24	1
16	5528	4.1	194	27	1
17	5494	2.3	193	28	1
18	5524	3.9	173	29	1
19	5503	4.3	188	23	1
20	5528	1.5	215	26	1
21	5497	4.9	227	27	1
22	5500	1.1	199	23	1
23	5523	4.5	155	29	0
24	5515	4.0	190	27	1
25	5494	2.4	151	23	0
26	5516	2.5	180	28	1
27	5520	2.5	228	23	0
28	5525	2.5	203	25	1
29	5492	1.5	188	25	1
30	5515	1.9	217	24	1
Detection Percentage (%)					83.333
Limit					60%
Test Result					Complied



Type 3 Radar Statistical Performance

Trial #	Test Freq. (MHz)	Pulse Width (us)	PRI (us)	Pulses / Burst	1=Detection 0=No Detection
1	5505	8.0	205	16	1
2	5524	6.7	382	18	1
3	5522	8.6	418	16	1
4	5501	9.4	351	17	1
5	5520	7.4	383	18	1
6	5491	9.8	232	16	1
7	5501	9.1	377	17	1
8	5526	9.6	457	16	0
9	5518	8.0	471	18	1
10	5498	9.0	304	18	1
11	5504	8.0	316	17	1
12	5491	9.8	325	16	1
13	5508	8.0	409	17	1
14	5494	9.9	200	17	1
15	5506	8.8	458	16	1
16	5529	8.0	232	18	1
17	5505	8.3	250	16	0
18	5500	8.7	270	16	1
19	5507	7.7	350	17	1
20	5506	7.1	230	16	1
21	5508	7.3	416	18	1
22	5499	7.6	498	18	1
23	5528	7.3	286	17	1
24	5506	7.3	287	16	1
25	5496	7.5	462	17	1
26	5521	6.2	300	17	1
27	5517	6.4	323	18	1
28	5513	7.1	420	16	1
29	5511	7.2	395	18	1
30	5493	8.4	377	16	1
Detection Percentage (%)					93.333
Limit					60%
Test Result					Complied



Type 4 Radar Statistical Performance

Trial #	Test Freq. (MHz)	Pulse Width (us)	PRI (us)	Pulses / Burst	1=Detection 0=No Detection
1	5495	18.0	242	15	0
2	5529	19.9	279	12	1
3	5506	12.9	487	14	1
4	5512	15.0	452	13	1
5	5527	16.3	230	12	0
6	5493	19.8	238	13	1
7	5521	18.2	420	16	1
8	5513	16.3	452	15	0
9	5492	14.2	495	12	1
10	5526	17.8	228	16	1
11	5494	19.1	211	16	1
12	5524	18.4	283	15	1
13	5528	11.8	411	12	1
14	5502	14.2	284	13	1
15	5508	13.9	202	12	0
16	5491	17.8	340	14	1
17	5516	15.6	290	16	1
18	5501	14.6	250	16	1
19	5513	14.4	484	15	1
20	5507	18.9	387	13	0
21	5504	11.1	348	15	1
22	5523	13.8	291	16	1
23	5505	14.3	295	12	1
24	5527	12.5	300	12	1
25	5492	12.5	322	14	1
26	5512	12.5	383	13	1
27	5506	15.7	322	16	1
28	5497	19.8	469	13	1
29	5502	18.6	406	15	1
30	5513	15.9	238	14	0
Detection Percentage (%)					80.000
Limit					60%
Test Result					Complied



Total Type 1~4 Radar Statistical Performance

Radar Type #	Detection Percentage (%)
1	96.667
2	83.333
3	93.333
4	80.000
Aggregate (Radar Types 1-4)	88.333
Limit	80%
Test Result	Complied



Type 5 Radar Statistical Performance

Center Freq. (MHz)	Low Edge (MHz)	High Edge (MHz)	VSG Freq. (MHz)	Detection
Trial	Chirp	Offset		
1	5	2	5510.0	0
2	20	8	5510.0	1
3	7	2.8	5510.0	1
4	8	3.2	5510.0	1
5	9	3.6	5510.0	1
6	10	4	5510.0	1
7	11	4.4	5510.0	1
8	12	4.8	5510.0	1
9	13	5.2	5510.0	1
10	14	5.6	5510.0	1
11	15	6	5497.0	1
12	16	6.4	5497.4	1
13	17	6.8	5497.8	1
14	20	8	5499.0	1
15	19	7.6	5498.6	1
16	18	7.2	5498.2	1
17	17	6.8	5497.8	1
18	16	6.4	5497.4	1
19	15	6	5497.0	1
20	14	5.6	5496.6	1
21	13	5.2	5523.8	1
22	12	4.8	5524.2	1
23	11	4.4	5524.6	1
24	10	4	5525.0	1
25	9	3.6	5525.4	1
26	8	3.2	5525.8	1
27	18	7.2	5521.8	1
28	19	7.6	5521.4	0
29	20	8	5521.0	0
30	5	2	5527.0	1
Total				27
Detection Percentage (%)				90%
Limit				80%
Test Result				Complied



Trial Number							1
Number of Bursts in Trial							8
Chirp Center Frequency							5510
Burst	No. of Pulses	Pulse Width (us)	Chirp Width (MHz)	Pulse 1-to-2 Spacing (us)	Pulse 2-to-3 Spacing (us)	Starting Location Within Interval (ms)	
1	1	62.1	5	-	-	1091	
2	2	56	5	1729	-	133	
3	2	91.3	5	1230	-	1057	
4	3	50.7	5	1762	1616	1442	
5	2	92.6	5	1723	-	544	
6	2	87.3	5	1302	-	1089	
7	2	59.5	5	1291	-	1374	
8	2	52.2	5	1653	-	1237	
Detection Check (1=Detection; 0=No Detection)							0

Trial Number							2
Number of Bursts in Trial							9
Chirp Center Frequency							5510
Burst	No. of Pulses	Pulse Width (us)	Chirp Width (MHz)	Pulse 1-to-2 Spacing (us)	Pulse 2-to-3 Spacing (us)	Starting Location Within Interval (ms)	
1	3	90	20	1007	1326	30	
2	2	73.7	20	1785	-	979	
3	1	78.1	20	-	-	683	
4	2	92.4	20	1281	-	950	
5	1	61.2	20	-	-	612	
6	3	67.2	20	1525	1870	17	
7	1	78.5	20	-	-	429	
8	2	60.3	20	1931	-	936	
9	3	92.9	20	1403	1476	548	
Detection Check (1=Detection; 0=No Detection)							1



Trial Number		3				
Number of Bursts in Trial		10				
Chirp Center Frequency		5510				
Burst	No. of Pulses	Pulse Width (us)	Chirp Width (MHz)	Pulse 1-to-2 Spacing (us)	Pulse 2-to-3 Spacing (us)	Starting Location Within Interval (ms)
1	3	63.4	7	1574	1607	801
2	1	98	7	-	-	966
3	1	58.7	7	-	-	185
4	1	88	7	-	-	1012
5	3	79.5	7	1562	1370	943
6	3	57.1	7	1900	1188	686
7	2	64.4	7	1090	-	599
8	1	78.7	7	-	-	1089
9	1	69.3	7	-	-	188
10	3	55.3	7	1375	1691	933
Detection Check (1=Detection; 0=No Detection)						1

Trial Number		4				
Number of Bursts in Trial		11				
Chirp Center Frequency		5510				
Burst	No. of Pulses	Pulse Width (us)	Chirp Width (MHz)	Pulse 1-to-2 Spacing (us)	Pulse 2-to-3 Spacing (us)	Starting Location Within Interval (ms)
1	2	74.3	8	1642	-	24
2	1	83.1	8	-	-	985
3	2	59.5	8	1680	-	988
4	2	59.8	8	1786	-	800
5	2	77.6	8	1617	-	339
6	2	79.9	8	1553	-	1040
7	1	56	8	-	-	544
8	3	71.4	8	1406	1927	452
9	1	97.4	8	-	-	204
10	2	98.3	8	1037	-	926
11	1	63.6	8	-	-	1052
Detection Check (1=Detection; 0=No Detection)						1



Trial Number							5
Number of Bursts in Trial							12
Chirp Center Frequency							5510
Burst	No. of Pulses	Pulse Width (us)	Chirp Width (MHz)	Pulse 1-to-2 Spacing (us)	Pulse 2-to-3 Spacing (us)	Starting Location Within Interval (ms)	
1	1	50	9	-	-	557	
2	2	62.5	9	1731	-	567	
3	2	55.4	9	1070	-	460	
4	1	65.7	9	-	-	4	
5	2	58	9	1512	-	64	
6	2	60.9	9	1230	-	650	
7	3	89.6	9	1598	1738	235	
8	3	84.4	9	1271	1617	873	
9	3	72.3	9	1498	1321	901	
10	1	58.9	9	-	-	663	
11	2	74.8	9	1584	-	919	
12	1	71.8	9	-	-	375	
Detection Check (1=Detection; 0=No Detection)							1

Trial Number							6
Number of Bursts in Trial							13
Chirp Center Frequency							5510
Burst	No. of Pulses	Pulse Width (us)	Chirp Width (MHz)	Pulse 1-to-2 Spacing (us)	Pulse 2-to-3 Spacing (us)	Starting Location Within Interval (ms)	
1	2	88.1	10	1257	-	846	
2	1	58.7	10	-	-	725	
3	2	97.1	10	1037	-	30	
4	3	83.1	10	1029	1106	490	
5	1	62.1	10	-	-	262	
6	2	71.4	10	1058	-	283	
7	2	86.3	10	1867	-	49	
8	3	77.3	10	1418	1876	634	
9	1	78.9	10	-	-	304	
10	3	79.2	10	1055	1572	564	
11	3	52	10	1582	1836	852	
12	3	56.5	10	1195	1542	525	
13	3	100	10	1638	1729	750	
Detection Check (1=Detection; 0=No Detection)							1



Trial Number							7
Number of Bursts in Trial							14
Chirp Center Frequency							5510
Burst	No. of Pulses	Pulse Width (us)	Chirp Width (MHz)	Pulse 1-to-2 Spacing (us)	Pulse 2-to-3 Spacing (us)	Starting Location Within Interval (ms)	
1	2	92.7	11	1208	-	231	
2	2	81.3	11	1144	-	804	
3	2	60.4	11	1555	-	34	
4	2	62.1	11	1320	-	427	
5	1	50	11	-	-	577	
6	3	65.9	11	1020	1365	3	
7	2	73.8	11	1308	-	51	
8	2	74.3	11	1143	-	360	
9	1	62.9	11	-	-	394	
10	2	74.8	11	1404	-	317	
11	2	69.7	11	1309	-	532	
12	2	69.8	11	1688	-	339	
13	2	77.4	11	1857	-	381	
14	1	55.1	11	-	-	426	
Detection Check (1=Detection; 0=No Detection)							1

Trial Number							8
Number of Bursts in Trial							15
Chirp Center Frequency							5510
Burst	No. of Pulses	Pulse Width (us)	Chirp Width (MHz)	Pulse 1-to-2 Spacing (us)	Pulse 2-to-3 Spacing (us)	Starting Location Within Interval (ms)	
1	1	91.7	12	-	-	776	
2	2	90	12	1196	-	187	
3	3	92.3	12	1486	1853	448	
4	2	66.8	12	1545	-	702	
5	1	64	12	-	-	403	
6	3	95.4	12	1123	1473	230	
7	3	66.8	12	1867	1401	604	
8	3	67.7	12	1472	1397	38	
9	1	68.2	12	-	-	735	
10	2	82.2	12	1297	-	610	
11	1	92.1	12	-	-	618	
12	2	57	12	1764	-	705	
13	2	58.5	12	1310	-	22	
14	3	85.5	12	1630	1447	641	
15	2	82.2	12	1371	-	109	
Detection Check (1=Detection; 0=No Detection)							1



Trial Number			9			
Number of Bursts in Trial			16			
Chirp Center Frequency			5510			
Burst	No. of Pulses	Pulse Width (us)	Chirp Width (MHz)	Pulse 1-to-2 Spacing (us)	Pulse 2-to-3 Spacing (us)	Starting Location Within Interval (ms)
1	2	74.4	13	1707	-	442
2	2	63.6	13	1725	-	280
3	2	71.3	13	1704	-	459
4	3	77.6	13	1063	1405	197
5	3	65.2	13	1731	1294	101
6	3	55.1	13	1109	1549	17
7	2	96.8	13	1034	-	131
8	3	80.8	13	1533	1051	365
9	1	60.4	13	-	-	222
10	2	61.8	13	1312	-	371
11	2	71.3	13	1657	-	33
12	2	98.1	13	1024	-	291
13	1	57.9	13	-	-	188
14	1	91.8	13	-	-	163
15	2	56.7	13	1259	-	426
16	2	89.7	13	1690	-	606
Detection Check (1=Detection; 0=No Detection)						1



Trial Number			10			
Number of Bursts in Trial			17			
Chirp Center Frequency			5510			
Burst	No. of Pulses	Pulse Width (us)	Chirp Width (MHz)	Pulse 1-to-2 Spacing (us)	Pulse 2-to-3 Spacing (us)	Starting Location Within Interval (ms)
1	2	74.4	14	1107	-	462
2	1	87.6	14	-	-	653
3	2	61.7	14	1741	-	457
4	2	57.5	14	1566	-	388
5	2	66.1	14	1855	-	63
6	3	70.1	14	1044	1012	136
7	1	66.4	14	-	-	343
8	1	59.2	14	-	-	349
9	2	88.3	14	1240	-	362
10	1	64.7	14	-	-	221
11	2	73	14	1703	-	144
12	2	81.7	14	1450	-	671
13	3	70.1	14	1741	1278	320
14	1	63.6	14	-	-	196
15	1	58.7	14	-	-	413
16	2	65.9	14	1478	-	170
17	1	72.7	14	-	-	564
Detection Check (1=Detection; 0=No Detection)						1



Trial Number		11				
Number of Bursts in Trial		18				
Chirp Center Frequency		5497				
Burst	No. of Pulses	Pulse Width (us)	Chirp Width (MHz)	Pulse 1-to-2 Spacing (us)	Pulse 2-to-3 Spacing (us)	Starting Location Within Interval (ms)
1	2	72.1	15	1193	-	130
2	3	76.3	15	1484	1390	114
3	1	86.1	15	-	-	14
4	1	73.2	15	-	-	604
5	1	81.2	15	-	-	548
6	2	99.5	15	1398	-	173
7	1	93.9	15	-	-	262
8	2	75.9	15	1921	-	38
9	3	79.2	15	1100	1429	84
10	3	77	15	1166	1799	610
11	1	91.8	15	-	-	339
12	3	56.8	15	1330	1556	580
13	2	83.1	15	1556	-	295
14	2	63	15	1552	-	156
15	1	65.7	15	-	-	439
16	1	64.5	15	-	-	188
17	1	88.5	15	-	-	419
18	1	60.6	15	-	-	205
Detection Check (1=Detection; 0=No Detection)						1



Trial Number			12			
Number of Bursts in Trial			19			
Chirp Center Frequency			5497			
Burst	No. of Pulses	Pulse Width (us)	Chirp Width (MHz)	Pulse 1-to-2 Spacing (us)	Pulse 2-to-3 Spacing (us)	Starting Location Within Interval (ms)
1	2	90.5	16	1299	-	381
2	2	88.4	16	1418	-	327
3	2	53.7	16	1055	-	536
4	1	80.5	16	-	-	285
5	1	50.4	16	-	-	398
6	2	61.2	16	1749	-	439
7	2	78.8	16	1065	-	129
8	3	75	16	1748	1820	325
9	2	96.7	16	1254	-	440
10	3	76.3	16	1848	1106	397
11	1	73.3	16	-	-	232
12	2	92.4	16	1317	-	91
13	2	92.4	16	1854	-	256
14	3	64.4	16	1240	1634	582
15	2	67.3	16	1473	-	117
16	2	84.1	16	1795	-	202
17	1	80.9	16	-	-	135
18	1	74.6	16	-	-	396
19	2	97.6	16	1805	-	615
Detection Check (1=Detection; 0=No Detection)						1



Trial Number							13
Number of Bursts in Trial							20
Chirp Center Frequency							5498
Burst	No. of Pulses	Pulse Width (us)	Chirp Width (MHz)	Pulse 1-to-2 Spacing (us)	Pulse 2-to-3 Spacing (us)	Starting Location Within Interval (ms)	
1	2	66.1	17	1417	-	388	
2	2	86.7	17	1693	-	348	
3	2	70.5	17	1263	-	215	
4	2	78	17	1446	-	28	
5	2	66	17	1185	-	585	
6	2	80.6	17	1855	-	65	
7	1	95.5	17	-	-	92	
8	1	98.8	17	-	-	68	
9	3	64.3	17	1641	1108	517	
10	1	75.1	17	-	-	121	
11	2	72.6	17	1499	-	448	
12	1	60.3	17	-	-	567	
13	2	54.9	17	1056	-	245	
14	2	98.8	17	1023	-	584	
15	2	60.9	17	1243	-	579	
16	2	62.7	17	1226	-	464	
17	1	80.1	17	-	-	89	
18	2	70.9	17	1711	-	153	
19	1	90.7	17	-	-	282	
20	1	98.9	17	-	-	71	
Detection Check (1=Detection; 0=No Detection)							1

Trial Number							14
Number of Bursts in Trial							8
Chirp Center Frequency							5499
Burst	No. of Pulses	Pulse Width (us)	Chirp Width (MHz)	Pulse 1-to-2 Spacing (us)	Pulse 2-to-3 Spacing (us)	Starting Location Within Interval (ms)	
1	2	67.5	20	1542	-	947	
2	3	83.6	20	1272	1696	124	
3	2	93.2	20	1877	-	701	
4	1	55.6	20	-	-	1123	
5	3	84.2	20	1733	1619	756	
6	3	69.1	20	1612	1071	1	
7	2	66.9	20	1905	-	7	
8	3	86.8	20	1697	1621	1082	
Detection Check (1=Detection; 0=No Detection)							1



Trial Number							15
Number of Bursts in Trial							9
Chirp Center Frequency							5499
Burst	No. of Pulses	Pulse Width (us)	Chirp Width (MHz)	Pulse 1-to-2 Spacing (us)	Pulse 2-to-3 Spacing (us)	Starting Location Within Interval (ms)	
1	2	62.2	19	1571	-	949	
2	2	85	19	1669	-	189	
3	2	64.5	19	1505	-	176	
4	2	50.4	19	1325	-	538	
5	2	66.1	19	1483	-	908	
6	2	71.2	19	1110	-	1017	
7	3	53.7	19	1445	1677	492	
8	3	62.5	19	1596	1341	349	
9	3	62	19	1929	1221	1105	
Detection Check (1=Detection; 0=No Detection)							1

Trial Number							16
Number of Bursts in Trial							10
Chirp Center Frequency							5498
Burst	No. of Pulses	Pulse Width (us)	Chirp Width (MHz)	Pulse 1-to-2 Spacing (us)	Pulse 2-to-3 Spacing (us)	Starting Location Within Interval (ms)	
1	2	80.5	18	1910	-	284	
2	2	64.2	18	1661	-	751	
3	2	90.1	18	1041	-	491	
4	2	69.8	18	1495	-	107	
5	1	73.1	18	-	-	490	
6	3	77.2	18	1418	1145	1155	
7	3	52.6	18	1732	1787	772	
8	2	71.4	18	1562	-	121	
9	2	89.8	18	1491	-	89	
10	2	76.4	18	1355	-	615	
Detection Check (1=Detection; 0=No Detection)							1



Trial Number							17
Number of Bursts in Trial							11
Chirp Center Frequency							5498
Burst	No. of Pulses	Pulse Width (us)	Chirp Width (MHz)	Pulse 1-to-2 Spacing (us)	Pulse 2-to-3 Spacing (us)	Starting Location Within Interval (ms)	
1	2	51.2	17	1236	-	740	
2	1	71.7	17	-	-	941	
3	2	74.7	17	1164	-	370	
4	2	50.9	17	1919	-	371	
5	2	65.2	17	1206	-	1033	
6	2	98	17	1182	-	346	
7	2	58.7	17	1612	-	639	
8	1	63.8	17	-	-	1056	
9	3	86.3	17	1545	1065	205	
10	1	94.4	17	-	-	753	
11	3	88.5	17	1699	1319	58	
Detection Check (1=Detection; 0=No Detection)							1

Trial Number							18
Number of Bursts in Trial							12
Chirp Center Frequency							5497
Burst	No. of Pulses	Pulse Width (us)	Chirp Width (MHz)	Pulse 1-to-2 Spacing (us)	Pulse 2-to-3 Spacing (us)	Starting Location Within Interval (ms)	
1	2	88.7	16	1405	-	448	
2	3	90.2	16	1544	1235	621	
3	1	96.5	16	-	-	512	
4	2	80.5	16	1090	-	321	
5	2	63.7	16	1268	-	798	
6	1	53.4	16	-	-	809	
7	2	52.3	16	1043	-	301	
8	3	54.7	16	1701	1104	796	
9	3	75.6	16	1923	1729	669	
10	2	59.2	16	1244	-	369	
11	1	56.3	16	-	-	51	
12	2	87.8	16	1608	-	733	
Detection Check (1=Detection; 0=No Detection)							1



Trial Number							19
Number of Bursts in Trial							13
Chirp Center Frequency							5497
Burst	No. of Pulses	Pulse Width (us)	Chirp Width (MHz)	Pulse 1-to-2 Spacing (us)	Pulse 2-to-3 Spacing (us)	Starting Location Within Interval (ms)	
1	2	68.2	15	1104	-	229	
2	2	58.4	15	1627	-	488	
3	3	74.7	15	1861	1015	137	
4	2	58.2	15	1593	-	520	
5	1	51.6	15	-	-	799	
6	2	94.7	15	1469	-	43	
7	2	70.7	15	1091	-	126	
8	2	82.9	15	1472	-	607	
9	3	62.7	15	1168	1453	527	
10	2	63.1	15	1529	-	143	
11	1	96.1	15	-	-	176	
12	2	57	15	1457	-	882	
13	3	95.6	15	1707	1501	214	
Detection Check (1=Detection; 0=No Detection)							1

Trial Number							20
Number of Bursts in Trial							14
Chirp Center Frequency							5497
Burst	No. of Pulses	Pulse Width (us)	Chirp Width (MHz)	Pulse 1-to-2 Spacing (us)	Pulse 2-to-3 Spacing (us)	Starting Location Within Interval (ms)	
1	1	95.7	14	-	-	117	
2	1	93.1	14	-	-	720	
3	1	55.8	14	-	-	297	
4	1	76.7	14	-	-	284	
5	2	68	14	1686	-	472	
6	3	94.1	14	1796	1393	264	
7	2	53.9	14	1293	-	525	
8	1	99.3	14	-	-	155	
9	2	73.3	14	1458	-	65	
10	2	93.3	14	1196	-	451	
11	3	55.8	14	1895	1034	243	
12	1	66.4	14	-	-	228	
13	2	65.6	14	1732	-	746	
14	2	76.5	14	1187	-	522	
Detection Check (1=Detection; 0=No Detection)							1



Trial Number							21
Number of Bursts in Trial							15
Chirp Center Frequency							5524
Burst	No. of Pulses	Pulse Width (us)	Chirp Width (MHz)	Pulse 1-to-2 Spacing (us)	Pulse 2-to-3 Spacing (us)	Starting Location Within Interval (ms)	
1	1	85.1	13	-	-	565	
2	2	72.5	13	1648	-	211	
3	1	67.5	13	-	-	348	
4	2	56.1	13	1360	-	156	
5	1	71.1	13	-	-	718	
6	2	93.1	13	1391	-	400	
7	1	56.5	13	-	-	482	
8	1	63.8	13	-	-	703	
9	2	67.4	13	1727	-	780	
10	1	52.3	13	-	-	102	
11	3	62.4	13	1228	1715	304	
12	2	53.3	13	1630	-	57	
13	2	83.1	13	1205	-	768	
14	2	93.7	13	1085	-	461	
15	2	90.7	13	1297	-	746	
Detection Check (1=Detection; 0=No Detection)							1

Trial Number							22
Number of Bursts in Trial							16
Chirp Center Frequency							5524
Burst	No. of Pulses	Pulse Width (us)	Chirp Width (MHz)	Pulse 1-to-2 Spacing (us)	Pulse 2-to-3 Spacing (us)	Starting Location Within Interval (ms)	
1	2	98.8	12	1439	-	95	
2	1	54.5	12	-	-	676	
3	2	80.5	12	1360	-	8	
4	2	55.9	12	1906	-	373	
5	2	72.1	12	1623	-	254	
6	2	84.4	12	1604	-	480	
7	1	78.5	12	-	-	663	
8	1	88	12	-	-	314	
9	2	74.7	12	1157	-	596	
10	2	97.1	12	1673	-	264	
11	1	81.6	12	-	-	740	
12	1	83.6	12	-	-	163	
13	3	87.6	12	1757	1322	628	
14	2	58.5	12	1372	-	132	
15	3	91.8	12	1767	1183	106	
16	2	58.8	12	1432	-	659	
Detection Check (1=Detection; 0=No Detection)							1



Trial Number			23			
Number of Bursts in Trial			17			
Chirp Center Frequency			5525			
Burst	No. of Pulses	Pulse Width (us)	Chirp Width (MHz)	Pulse 1-to-2 Spacing (us)	Pulse 2-to-3 Spacing (us)	Starting Location Within Interval (ms)
1	1	96	11	-	-	284
2	2	92.5	11	1241	-	488
3	2	89.5	11	1347	-	76
4	2	74.8	11	1607	-	688
5	2	60.6	11	1523	-	28
6	2	71.5	11	1659	-	383
7	2	71.1	11	1454	-	182
8	1	98.7	11	-	-	20
9	2	85.1	11	1770	-	576
10	2	89.2	11	1086	-	410
11	2	60.7	11	1101	-	458
12	2	75.2	11	1719	-	348
13	2	75.7	11	1799	-	481
14	3	56.7	11	1132	1884	587
15	2	65	11	1885	-	480
16	2	64.6	11	1910	-	195
17	3	69.9	11	1410	1190	396
Detection Check (1=Detection; 0=No Detection)						1



Trial Number			24			
Number of Bursts in Trial			18			
Chirp Center Frequency			5525			
Burst	No. of Pulses	Pulse Width (us)	Chirp Width (MHz)	Pulse 1-to-2 Spacing (us)	Pulse 2-to-3 Spacing (us)	Starting Location Within Interval (ms)
1	3	83.8	10	1290	1021	536
2	2	66.9	10	1112	-	44
3	3	91	10	1220	1504	611
4	2	86.1	10	1678	-	456
5	3	65.5	10	1928	1222	330
6	1	62.6	10	-	-	297
7	3	68.7	10	1505	1200	351
8	3	59.2	10	1452	1114	230
9	1	73.9	10	-	-	222
10	1	77.2	10	-	-	57
11	2	96.4	10	1357	-	399
12	2	99.9	10	1173	-	299
13	2	99.9	10	1520	-	464
14	1	86.7	10	-	-	294
15	1	92.6	10	-	-	653
16	1	77.1	10	-	-	550
17	2	81.1	10	1664	-	566
18	3	68.4	10	1536	1309	580
Detection Check (1=Detection; 0=No Detection)						1



Trial Number			25			
Number of Bursts in Trial			19			
Chirp Center Frequency			5525			
Burst	No. of Pulses	Pulse Width (us)	Chirp Width (MHz)	Pulse 1-to-2 Spacing (us)	Pulse 2-to-3 Spacing (us)	Starting Location Within Interval (ms)
1	3	68.2	9	1723	1868	471
2	3	83.7	9	1711	1405	368
3	2	69.7	9	1781	-	425
4	1	59.7	9	-	-	440
5	2	96.7	9	1484	-	123
6	2	95.8	9	1319	-	261
7	3	71.3	9	1095	1354	332
8	3	53.2	9	1527	1427	427
9	2	69.5	9	1771	-	397
10	3	63.9	9	1075	1447	67
11	2	93.4	9	1783	-	174
12	2	77.3	9	1564	-	17
13	2	73.1	9	1294	-	216
14	1	77.4	9	-	-	292
15	3	57.2	9	1722	1886	619
16	2	68.7	9	1629	-	233
17	1	60.8	9	-	-	226
18	3	69.7	9	1128	1224	599
19	1	62.2	9	-	-	433
Detection Check (1=Detection; 0=No Detection)						1



Trial Number							26
Number of Bursts in Trial							20
Chirp Center Frequency							5526
Burst	No. of Pulses	Pulse Width (us)	Chirp Width (MHz)	Pulse 1-to-2 Spacing (us)	Pulse 2-to-3 Spacing (us)	Starting Location Within Interval (ms)	
1	1	80.5	8	-	-	90	
2	3	62.6	8	1406	1343	319	
3	3	85.6	8	1190	1529	384	
4	2	83.9	8	1208	-	567	
5	2	92.4	8	1488	-	234	
6	2	54	8	1529	-	535	
7	3	81.3	8	1501	1812	325	
8	1	98.5	8	-	-	532	
9	1	85.8	8	-	-	272	
10	2	84.7	8	1593	-	182	
11	2	83.3	8	1705	-	134	
12	2	79.8	8	1567	-	286	
13	1	77.9	8	-	-	368	
14	3	98.4	8	1510	1569	290	
15	2	79.9	8	1588	-	231	
16	3	78	8	1140	1353	353	
17	3	55.2	8	1700	1327	53	
18	3	71.9	8	1081	1224	44	
19	1	62	8	-	-	298	
20	3	70.5	8	1888	1442	529	
Detection Check (1=Detection; 0=No Detection)							1

Trial Number							27
Number of Bursts in Trial							8
Chirp Center Frequency							5522
Burst	No. of Pulses	Pulse Width (us)	Chirp Width (MHz)	Pulse 1-to-2 Spacing (us)	Pulse 2-to-3 Spacing (us)	Starting Location Within Interval (ms)	
1	2	69.1	18	1076	-	1436	
2	2	62.1	18	1688	-	22	
3	2	94.8	18	1891	-	897	
4	1	75.8	18	-	-	1186	
5	2	65.4	18	1713	-	589	
6	2	97.7	18	1292	-	614	
7	3	98.1	18	1670	1711	506	
8	2	85.4	18	1672	-	776	
Detection Check (1=Detection; 0=No Detection)							1



Trial Number							28
Number of Bursts in Trial							9
Chirp Center Frequency							5521
Burst	No. of Pulses	Pulse Width (us)	Chirp Width (MHz)	Pulse 1-to-2 Spacing (us)	Pulse 2-to-3 Spacing (us)	Starting Location Within Interval (ms)	
1	3	82	19	1233	1713	679	
2	3	87.7	19	1554	1123	473	
3	2	98.9	19	1518	-	869	
4	1	55	19	-	-	719	
5	1	93.6	19	-	-	902	
6	2	58.7	19	1641	-	1243	
7	2	88.7	19	1387	-	410	
8	1	60.3	19	-	-	1154	
9	1	97.7	19	-	-	512	
Detection Check (1=Detection; 0=No Detection)							0

Trial Number							29
Number of Bursts in Trial							10
Chirp Center Frequency							5521
Burst	No. of Pulses	Pulse Width (us)	Chirp Width (MHz)	Pulse 1-to-2 Spacing (us)	Pulse 2-to-3 Spacing (us)	Starting Location Within Interval (ms)	
1	1	69.6	20	-	-	1131	
2	1	74.5	20	-	-	290	
3	1	60.9	20	-	-	895	
4	1	74.6	20	-	-	202	
5	2	99.3	20	1501	-	139	
6	2	95.3	20	1065	-	854	
7	2	91.9	20	1722	-	219	
8	2	51	20	1285	-	57	
9	2	87.7	20	1747	-	141	
10	1	87.2	20	-	-	596	
Detection Check (1=Detection; 0=No Detection)							0



Trial Number		30				
Number of Bursts in Trial		11				
Chirp Center Frequency		5527				
Burst	No. of Pulses	Pulse Width (us)	Chirp Width (MHz)	Pulse 1-to-2 Spacing (us)	Pulse 2-to-3 Spacing (us)	Starting Location Within Interval (ms)
1	3	59.9	5	1901	1196	935
2	2	77.1	5	1590	-	1038
3	2	62.7	5	1227	-	690
4	1	77.1	5	-	-	547
5	3	99.8	5	1798	1790	551
6	2	61.5	5	1135	-	876
7	2	77.5	5	1583	-	448
8	2	57.3	5	1890	-	736
9	2	53.5	5	1757	-	362
10	1	66.6	5	-	-	836
11	3	80.7	5	1811	1289	410
Detection Check (1=Detection; 0=No Detection)						1



Type 6 Radar Statistical Performance

Trial #	Test Freq. (MHz)	Pulses / Hop	Pulse Width (us)	PRI (us)	1=Detection 0=No Detection
1	5510	9	1	333	1
2	5510	9	1	333	1
3	5510	9	1	333	1
4	5510	9	1	333	1
5	5510	9	1	333	1
6	5510	9	1	333	1
7	5510	9	1	333	1
8	5510	9	1	333	1
9	5510	9	1	333	1
10	5510	9	1	333	1
11	5510	9	1	333	1
12	5510	9	1	333	1
13	5510	9	1	333	1
14	5510	9	1	333	1
15	5510	9	1	333	1
16	5510	9	1	333	1
17	5510	9	1	333	1
18	5510	9	1	333	1
19	5510	9	1	333	1
20	5510	9	1	333	1
21	5510	9	1	333	1
22	5510	9	1	333	1
23	5510	9	1	333	1
24	5510	9	1	333	1
25	5510	9	1	333	1
26	5510	9	1	333	1
27	5510	9	1	333	1
28	5510	9	1	333	1
29	5510	9	1	333	1
30	5510	9	1	333	1
Detection Percentage (%)					100.000
Limit					70%
Test Result					Complied



Modulation Mode: 802.11ax(80MHz) / 5530 MHz

Type 1 Radar Statistical Performance

Trial #	Test Freq. (MHz)	Pulse Repetition Frequency Number	Pulse Repetition Frequency (Pulse Per Second)	PRI (us)	1=Detection 0=No Detection
1	5520	1	1930.5	518	1
2	5506	23	326.2	3066	1
3	5522	19	1139.0	878	1
4	5557	12	1355.0	738	1
5	5517	4	1730.1	578	1
6	5496	8	1519.8	658	1
7	5512	15	1253.1	798	1
8	5528	6	1618.1	618	1
9	5564	14	1285.3	778	1
10	5546	3	1792.1	558	1
11	5519	13	1319.3	758	1
12	5493	9	1474.9	678	1
13	5544	7	1567.4	638	1
14	5548	17	1193.3	838	1
15	5506	10	1432.7	698	1
16	5522	-	1692.0	591	1
17	5518	-	328.1	3048	1
18	5547	-	373.4	2678	1
19	5560	-	574.4	1741	1
20	5555	-	1216.5	822	1
21	5528	-	801.3	1248	1
22	5513	-	488.5	2047	1
23	5557	-	956.0	1046	1
24	5525	-	517.6	1932	1
25	5544	-	1422.5	703	1
26	5539	-	542.0	1845	1
27	5491	-	741.3	1349	1
28	5567	-	881.8	1134	1
29	5550	-	427.4	2340	1
30	5558	-	628.9	1590	0
Detection Percentage (%)					96.667
Limit					60%
Test Result					Complied



Type 2 Radar Statistical Performance

Trial #	Test Freq. (MHz)	Pulse Width (us)	PRI (us)	Pulses / Burst	1=Detection 0=No Detection
1	5514	2.6	221	23	1
2	5503	4.6	198	27	1
3	5526	1.1	184	29	0
4	5497	4.8	203	24	1
5	5539	2.4	162	25	1
6	5507	3.4	204	28	1
7	5500	2.3	170	27	1
8	5555	3.5	184	23	1
9	5508	4.9	150	27	1
10	5495	4.6	211	29	1
11	5531	2.9	158	23	1
12	5558	2.6	226	27	1
13	5504	1.6	204	26	1
14	5549	3.9	181	25	1
15	5556	4.6	202	24	1
16	5518	4.1	194	27	1
17	5547	2.3	193	28	1
18	5565	3.9	173	29	1
19	5555	4.3	188	23	1
20	5523	1.5	215	26	1
21	5553	4.9	227	27	1
22	5493	1.1	199	23	1
23	5531	4.5	155	29	1
24	5546	4.0	190	27	1
25	5519	2.4	151	23	1
26	5543	2.5	180	28	1
27	5497	2.5	228	23	1
28	5515	2.5	203	25	1
29	5522	1.5	188	25	1
30	5542	1.9	217	24	0
Detection Percentage (%)					93.333
Limit					60%
Test Result					Complied



Type 3 Radar Statistical Performance

Trial #	Test Freq. (MHz)	Pulse Width (us)	PRI (us)	Pulses / Burst	1=Detection 0=No Detection
1	5538	8.0	205	16	1
2	5514	6.7	382	18	1
3	5561	8.6	418	16	1
4	5495	9.4	351	17	1
5	5518	7.4	383	18	1
6	5565	9.8	232	16	0
7	5555	9.1	377	17	0
8	5499	9.6	457	16	1
9	5566	8.0	471	18	0
10	5530	9.0	304	18	1
11	5495	8.0	316	17	1
12	5562	9.8	325	16	1
13	5566	8.0	409	17	1
14	5507	9.9	200	17	1
15	5563	8.8	458	16	1
16	5543	8.0	232	18	1
17	5552	8.3	250	16	1
18	5503	8.7	270	16	1
19	5506	7.7	350	17	1
20	5503	7.1	230	16	1
21	5549	7.3	416	18	1
22	5536	7.6	498	18	1
23	5514	7.3	286	17	1
24	5532	7.3	287	16	1
25	5513	7.5	462	17	1
26	5548	6.2	300	17	0
27	5530	6.4	323	18	1
28	5554	7.1	420	16	1
29	5533	7.2	395	18	1
30	5556	8.4	377	16	1
Detection Percentage (%)					86.667
Limit					60%
Test Result					Complied



Type 4 Radar Statistical Performance

Trial #	Test Freq. (MHz)	Pulse Width (us)	PRI (us)	Pulses / Burst	1=Detection 0=No Detection
1	5533	18.0	242	15	1
2	5546	19.9	279	12	1
3	5534	12.9	487	14	0
4	5548	15.0	452	13	1
5	5498	16.3	230	12	0
6	5491	19.8	238	13	1
7	5566	18.2	420	16	1
8	5524	16.3	452	15	0
9	5554	14.2	495	12	1
10	5553	17.8	228	16	1
11	5505	19.1	211	16	0
12	5504	18.4	283	15	1
13	5568	11.8	411	12	1
14	5501	14.2	284	13	1
15	5522	13.9	202	12	1
16	5568	17.8	340	14	1
17	5547	15.6	290	16	1
18	5524	14.6	250	16	0
19	5558	14.4	484	15	1
20	5544	18.9	387	13	1
21	5540	11.1	348	15	1
22	5527	13.8	291	16	0
23	5505	14.3	295	12	1
24	5503	12.5	300	12	1
25	5522	12.5	322	14	1
26	5512	12.5	383	13	0
27	5548	15.7	322	16	1
28	5500	19.8	469	13	1
29	5526	18.6	406	15	0
30	5497	15.9	238	14	1
Detection Percentage (%)					73.333
Limit					60%
Test Result					Complied



Total Type 1~4 Radar Statistical Performance

Radar Type #	Detection Percentage (%)
1	96.667
2	93.333
3	86.667
4	73.333
Aggregate (Radar Types 1-4)	87.500
Limit	80%
Test Result	Complied



Type 5 Radar Statistical Performance

Center Freq. (MHz)	Low Edge (MHz)	High Edge (MHz)	VSG Freq. (MHz)	Detection
Trial	Chirp	Offset		
1	5	2	5530.0	1
2	20	8	5530.0	1
3	7	2.8	5530.0	1
4	8	3.2	5530.0	1
5	9	3.6	5530.0	1
6	10	4	5530.0	1
7	11	4.4	5530.0	1
8	12	4.8	5530.0	1
9	13	5.2	5530.0	1
10	14	5.6	5530.0	1
11	15	6	5497.0	1
12	16	6.4	5497.4	1
13	17	6.8	5497.8	1
14	20	8	5499.0	0
15	19	7.6	5498.6	1
16	18	7.2	5498.2	1
17	17	6.8	5497.8	1
18	16	6.4	5497.4	1
19	15	6	5497.0	1
20	14	5.6	5496.6	1
21	13	5.2	5562.8	1
22	12	4.8	5563.2	1
23	11	4.4	5563.6	1
24	10	4	5564.0	1
25	9	3.6	5564.4	1
26	8	3.2	5564.8	1
27	18	7.2	5560.8	1
28	19	7.6	5560.4	1
29	20	8	5560.0	1
30	5	2	5566.0	1
Total				29
Detection Percentage (%)				97%
Limit				80%
Test Result				Complied



Trial Number							1
Number of Bursts in Trial							8
Chirp Center Frequency							5530
Burst	No. of Pulses	Pulse Width (us)	Chirp Width (MHz)	Pulse 1-to-2 Spacing (us)	Pulse 2-to-3 Spacing (us)	Starting Location Within Interval (ms)	
1	1	62.1	5	-	-	1091	
2	2	56	5	1729	-	133	
3	2	91.3	5	1230	-	1057	
4	3	50.7	5	1762	1616	1442	
5	2	92.6	5	1723	-	544	
6	2	87.3	5	1302	-	1089	
7	2	59.5	5	1291	-	1374	
8	2	52.2	5	1653	-	1237	
Detection Check (1=Detection; 0=No Detection)							1

Trial Number							2
Number of Bursts in Trial							9
Chirp Center Frequency							5530
Burst	No. of Pulses	Pulse Width (us)	Chirp Width (MHz)	Pulse 1-to-2 Spacing (us)	Pulse 2-to-3 Spacing (us)	Starting Location Within Interval (ms)	
1	3	90	20	1007	1326	30	
2	2	73.7	20	1785	-	979	
3	1	78.1	20	-	-	683	
4	2	92.4	20	1281	-	950	
5	1	61.2	20	-	-	612	
6	3	67.2	20	1525	1870	17	
7	1	78.5	20	-	-	429	
8	2	60.3	20	1931	-	936	
9	3	92.9	20	1403	1476	548	
Detection Check (1=Detection; 0=No Detection)							1



Trial Number							3
Number of Bursts in Trial							10
Chirp Center Frequency							5530
Burst	No. of Pulses	Pulse Width (us)	Chirp Width (MHz)	Pulse 1-to-2 Spacing (us)	Pulse 2-to-3 Spacing (us)	Starting Location Within Interval (ms)	
1	3	63.4	7	1574	1607	801	
2	1	98	7	-	-	966	
3	1	58.7	7	-	-	185	
4	1	88	7	-	-	1012	
5	3	79.5	7	1562	1370	943	
6	3	57.1	7	1900	1188	686	
7	2	64.4	7	1090	-	599	
8	1	78.7	7	-	-	1089	
9	1	69.3	7	-	-	188	
10	3	55.3	7	1375	1691	933	
Detection Check (1=Detection; 0=No Detection)							1

Trial Number							4
Number of Bursts in Trial							11
Chirp Center Frequency							5530
Burst	No. of Pulses	Pulse Width (us)	Chirp Width (MHz)	Pulse 1-to-2 Spacing (us)	Pulse 2-to-3 Spacing (us)	Starting Location Within Interval (ms)	
1	2	74.3	8	1642	-	24	
2	1	83.1	8	-	-	985	
3	2	59.5	8	1680	-	988	
4	2	59.8	8	1786	-	800	
5	2	77.6	8	1617	-	339	
6	2	79.9	8	1553	-	1040	
7	1	56	8	-	-	544	
8	3	71.4	8	1406	1927	452	
9	1	97.4	8	-	-	204	
10	2	98.3	8	1037	-	926	
11	1	63.6	8	-	-	1052	
Detection Check (1=Detection; 0=No Detection)							1



Trial Number							5
Number of Bursts in Trial							12
Chirp Center Frequency							5530
Burst	No. of Pulses	Pulse Width (us)	Chirp Width (MHz)	Pulse 1-to-2 Spacing (us)	Pulse 2-to-3 Spacing (us)	Starting Location Within Interval (ms)	
1	1	50	9	-	-	557	
2	2	62.5	9	1731	-	567	
3	2	55.4	9	1070	-	460	
4	1	65.7	9	-	-	4	
5	2	58	9	1512	-	64	
6	2	60.9	9	1230	-	650	
7	3	89.6	9	1598	1738	235	
8	3	84.4	9	1271	1617	873	
9	3	72.3	9	1498	1321	901	
10	1	58.9	9	-	-	663	
11	2	74.8	9	1584	-	919	
12	1	71.8	9	-	-	375	
Detection Check (1=Detection; 0=No Detection)							1

Trial Number							6
Number of Bursts in Trial							13
Chirp Center Frequency							5530
Burst	No. of Pulses	Pulse Width (us)	Chirp Width (MHz)	Pulse 1-to-2 Spacing (us)	Pulse 2-to-3 Spacing (us)	Starting Location Within Interval (ms)	
1	2	88.1	10	1257	-	846	
2	1	58.7	10	-	-	725	
3	2	97.1	10	1037	-	30	
4	3	83.1	10	1029	1106	490	
5	1	62.1	10	-	-	262	
6	2	71.4	10	1058	-	283	
7	2	86.3	10	1867	-	49	
8	3	77.3	10	1418	1876	634	
9	1	78.9	10	-	-	304	
10	3	79.2	10	1055	1572	564	
11	3	52	10	1582	1836	852	
12	3	56.5	10	1195	1542	525	
13	3	100	10	1638	1729	750	
Detection Check (1=Detection; 0=No Detection)							1



Trial Number							7
Number of Bursts in Trial							14
Chirp Center Frequency							5530
Burst	No. of Pulses	Pulse Width (us)	Chirp Width (MHz)	Pulse 1-to-2 Spacing (us)	Pulse 2-to-3 Spacing (us)	Starting Location Within Interval (ms)	
1	2	92.7	11	1208	-	231	
2	2	81.3	11	1144	-	804	
3	2	60.4	11	1555	-	34	
4	2	62.1	11	1320	-	427	
5	1	50	11	-	-	577	
6	3	65.9	11	1020	1365	3	
7	2	73.8	11	1308	-	51	
8	2	74.3	11	1143	-	360	
9	1	62.9	11	-	-	394	
10	2	74.8	11	1404	-	317	
11	2	69.7	11	1309	-	532	
12	2	69.8	11	1688	-	339	
13	2	77.4	11	1857	-	381	
14	1	55.1	11	-	-	426	
Detection Check (1=Detection; 0=No Detection)							1

Trial Number							8
Number of Bursts in Trial							15
Chirp Center Frequency							5530
Burst	No. of Pulses	Pulse Width (us)	Chirp Width (MHz)	Pulse 1-to-2 Spacing (us)	Pulse 2-to-3 Spacing (us)	Starting Location Within Interval (ms)	
1	1	91.7	12	-	-	776	
2	2	90	12	1196	-	187	
3	3	92.3	12	1486	1853	448	
4	2	66.8	12	1545	-	702	
5	1	64	12	-	-	403	
6	3	95.4	12	1123	1473	230	
7	3	66.8	12	1867	1401	604	
8	3	67.7	12	1472	1397	38	
9	1	68.2	12	-	-	735	
10	2	82.2	12	1297	-	610	
11	1	92.1	12	-	-	618	
12	2	57	12	1764	-	705	
13	2	58.5	12	1310	-	22	
14	3	85.5	12	1630	1447	641	
15	2	82.2	12	1371	-	109	
Detection Check (1=Detection; 0=No Detection)							1



Trial Number			9			
Number of Bursts in Trial			16			
Chirp Center Frequency			5530			
Burst	No. of Pulses	Pulse Width (us)	Chirp Width (MHz)	Pulse 1-to-2 Spacing (us)	Pulse 2-to-3 Spacing (us)	Starting Location Within Interval (ms)
1	2	74.4	13	1707	-	442
2	2	63.6	13	1725	-	280
3	2	71.3	13	1704	-	459
4	3	77.6	13	1063	1405	197
5	3	65.2	13	1731	1294	101
6	3	55.1	13	1109	1549	17
7	2	96.8	13	1034	-	131
8	3	80.8	13	1533	1051	365
9	1	60.4	13	-	-	222
10	2	61.8	13	1312	-	371
11	2	71.3	13	1657	-	33
12	2	98.1	13	1024	-	291
13	1	57.9	13	-	-	188
14	1	91.8	13	-	-	163
15	2	56.7	13	1259	-	426
16	2	89.7	13	1690	-	606
Detection Check (1=Detection; 0=No Detection)						1



Trial Number			10			
Number of Bursts in Trial			17			
Chirp Center Frequency			5530			
Burst	No. of Pulses	Pulse Width (us)	Chirp Width (MHz)	Pulse 1-to-2 Spacing (us)	Pulse 2-to-3 Spacing (us)	Starting Location Within Interval (ms)
1	2	74.4	14	1107	-	462
2	1	87.6	14	-	-	653
3	2	61.7	14	1741	-	457
4	2	57.5	14	1566	-	388
5	2	66.1	14	1855	-	63
6	3	70.1	14	1044	1012	136
7	1	66.4	14	-	-	343
8	1	59.2	14	-	-	349
9	2	88.3	14	1240	-	362
10	1	64.7	14	-	-	221
11	2	73	14	1703	-	144
12	2	81.7	14	1450	-	671
13	3	70.1	14	1741	1278	320
14	1	63.6	14	-	-	196
15	1	58.7	14	-	-	413
16	2	65.9	14	1478	-	170
17	1	72.7	14	-	-	564
Detection Check (1=Detection; 0=No Detection)						1



Trial Number			11			
Number of Bursts in Trial			18			
Chirp Center Frequency			5497			
Burst	No. of Pulses	Pulse Width (us)	Chirp Width (MHz)	Pulse 1-to-2 Spacing (us)	Pulse 2-to-3 Spacing (us)	Starting Location Within Interval (ms)
1	2	72.1	15	1193	-	130
2	3	76.3	15	1484	1390	114
3	1	86.1	15	-	-	14
4	1	73.2	15	-	-	604
5	1	81.2	15	-	-	548
6	2	99.5	15	1398	-	173
7	1	93.9	15	-	-	262
8	2	75.9	15	1921	-	38
9	3	79.2	15	1100	1429	84
10	3	77	15	1166	1799	610
11	1	91.8	15	-	-	339
12	3	56.8	15	1330	1556	580
13	2	83.1	15	1556	-	295
14	2	63	15	1552	-	156
15	1	65.7	15	-	-	439
16	1	64.5	15	-	-	188
17	1	88.5	15	-	-	419
18	1	60.6	15	-	-	205
Detection Check (1=Detection; 0=No Detection)						1



Trial Number			12			
Number of Bursts in Trial			19			
Chirp Center Frequency			5497			
Burst	No. of Pulses	Pulse Width (us)	Chirp Width (MHz)	Pulse 1-to-2 Spacing (us)	Pulse 2-to-3 Spacing (us)	Starting Location Within Interval (ms)
1	2	90.5	16	1299	-	381
2	2	88.4	16	1418	-	327
3	2	53.7	16	1055	-	536
4	1	80.5	16	-	-	285
5	1	50.4	16	-	-	398
6	2	61.2	16	1749	-	439
7	2	78.8	16	1065	-	129
8	3	75	16	1748	1820	325
9	2	96.7	16	1254	-	440
10	3	76.3	16	1848	1106	397
11	1	73.3	16	-	-	232
12	2	92.4	16	1317	-	91
13	2	92.4	16	1854	-	256
14	3	64.4	16	1240	1634	582
15	2	67.3	16	1473	-	117
16	2	84.1	16	1795	-	202
17	1	80.9	16	-	-	135
18	1	74.6	16	-	-	396
19	2	97.6	16	1805	-	615
Detection Check (1=Detection; 0=No Detection)						1



Trial Number							13
Number of Bursts in Trial							20
Chirp Center Frequency							5498
Burst	No. of Pulses	Pulse Width (us)	Chirp Width (MHz)	Pulse 1-to-2 Spacing (us)	Pulse 2-to-3 Spacing (us)	Starting Location Within Interval (ms)	
1	2	66.1	17	1417	-	388	
2	2	86.7	17	1693	-	348	
3	2	70.5	17	1263	-	215	
4	2	78	17	1446	-	28	
5	2	66	17	1185	-	585	
6	2	80.6	17	1855	-	65	
7	1	95.5	17	-	-	92	
8	1	98.8	17	-	-	68	
9	3	64.3	17	1641	1108	517	
10	1	75.1	17	-	-	121	
11	2	72.6	17	1499	-	448	
12	1	60.3	17	-	-	567	
13	2	54.9	17	1056	-	245	
14	2	98.8	17	1023	-	584	
15	2	60.9	17	1243	-	579	
16	2	62.7	17	1226	-	464	
17	1	80.1	17	-	-	89	
18	2	70.9	17	1711	-	153	
19	1	90.7	17	-	-	282	
20	1	98.9	17	-	-	71	
Detection Check (1=Detection; 0=No Detection)							1

Trial Number							14
Number of Bursts in Trial							8
Chirp Center Frequency							5499
Burst	No. of Pulses	Pulse Width (us)	Chirp Width (MHz)	Pulse 1-to-2 Spacing (us)	Pulse 2-to-3 Spacing (us)	Starting Location Within Interval (ms)	
1	2	67.5	20	1542	-	947	
2	3	83.6	20	1272	1696	124	
3	2	93.2	20	1877	-	701	
4	1	55.6	20	-	-	1123	
5	3	84.2	20	1733	1619	756	
6	3	69.1	20	1612	1071	1	
7	2	66.9	20	1905	-	7	
8	3	86.8	20	1697	1621	1082	
Detection Check (1=Detection; 0=No Detection)							0



Trial Number							15
Number of Bursts in Trial							9
Chirp Center Frequency							5499
Burst	No. of Pulses	Pulse Width (us)	Chirp Width (MHz)	Pulse 1-to-2 Spacing (us)	Pulse 2-to-3 Spacing (us)	Starting Location Within Interval (ms)	
1	2	62.2	19	1571	-	949	
2	2	85	19	1669	-	189	
3	2	64.5	19	1505	-	176	
4	2	50.4	19	1325	-	538	
5	2	66.1	19	1483	-	908	
6	2	71.2	19	1110	-	1017	
7	3	53.7	19	1445	1677	492	
8	3	62.5	19	1596	1341	349	
9	3	62	19	1929	1221	1105	
Detection Check (1=Detection; 0=No Detection)							1

Trial Number							16
Number of Bursts in Trial							10
Chirp Center Frequency							5498
Burst	No. of Pulses	Pulse Width (us)	Chirp Width (MHz)	Pulse 1-to-2 Spacing (us)	Pulse 2-to-3 Spacing (us)	Starting Location Within Interval (ms)	
1	2	80.5	18	1910	-	284	
2	2	64.2	18	1661	-	751	
3	2	90.1	18	1041	-	491	
4	2	69.8	18	1495	-	107	
5	1	73.1	18	-	-	490	
6	3	77.2	18	1418	1145	1155	
7	3	52.6	18	1732	1787	772	
8	2	71.4	18	1562	-	121	
9	2	89.8	18	1491	-	89	
10	2	76.4	18	1355	-	615	
Detection Check (1=Detection; 0=No Detection)							1



Trial Number							17
Number of Bursts in Trial							11
Chirp Center Frequency							5498
Burst	No. of Pulses	Pulse Width (us)	Chirp Width (MHz)	Pulse 1-to-2 Spacing (us)	Pulse 2-to-3 Spacing (us)	Starting Location Within Interval (ms)	
1	2	51.2	17	1236	-	740	
2	1	71.7	17	-	-	941	
3	2	74.7	17	1164	-	370	
4	2	50.9	17	1919	-	371	
5	2	65.2	17	1206	-	1033	
6	2	98	17	1182	-	346	
7	2	58.7	17	1612	-	639	
8	1	63.8	17	-	-	1056	
9	3	86.3	17	1545	1065	205	
10	1	94.4	17	-	-	753	
11	3	88.5	17	1699	1319	58	
Detection Check (1=Detection; 0=No Detection)							1

Trial Number							18
Number of Bursts in Trial							12
Chirp Center Frequency							5497
Burst	No. of Pulses	Pulse Width (us)	Chirp Width (MHz)	Pulse 1-to-2 Spacing (us)	Pulse 2-to-3 Spacing (us)	Starting Location Within Interval (ms)	
1	2	88.7	16	1405	-	448	
2	3	90.2	16	1544	1235	621	
3	1	96.5	16	-	-	512	
4	2	80.5	16	1090	-	321	
5	2	63.7	16	1268	-	798	
6	1	53.4	16	-	-	809	
7	2	52.3	16	1043	-	301	
8	3	54.7	16	1701	1104	796	
9	3	75.6	16	1923	1729	669	
10	2	59.2	16	1244	-	369	
11	1	56.3	16	-	-	51	
12	2	87.8	16	1608	-	733	
Detection Check (1=Detection; 0=No Detection)							1



Trial Number							19
Number of Bursts in Trial							13
Chirp Center Frequency							5497
Burst	No. of Pulses	Pulse Width (us)	Chirp Width (MHz)	Pulse 1-to-2 Spacing (us)	Pulse 2-to-3 Spacing (us)	Starting Location Within Interval (ms)	
1	2	68.2	15	1104	-	229	
2	2	58.4	15	1627	-	488	
3	3	74.7	15	1861	1015	137	
4	2	58.2	15	1593	-	520	
5	1	51.6	15	-	-	799	
6	2	94.7	15	1469	-	43	
7	2	70.7	15	1091	-	126	
8	2	82.9	15	1472	-	607	
9	3	62.7	15	1168	1453	527	
10	2	63.1	15	1529	-	143	
11	1	96.1	15	-	-	176	
12	2	57	15	1457	-	882	
13	3	95.6	15	1707	1501	214	
Detection Check (1=Detection; 0=No Detection)							1

Trial Number							20
Number of Bursts in Trial							14
Chirp Center Frequency							5497
Burst	No. of Pulses	Pulse Width (us)	Chirp Width (MHz)	Pulse 1-to-2 Spacing (us)	Pulse 2-to-3 Spacing (us)	Starting Location Within Interval (ms)	
1	1	95.7	14	-	-	117	
2	1	93.1	14	-	-	720	
3	1	55.8	14	-	-	297	
4	1	76.7	14	-	-	284	
5	2	68	14	1686	-	472	
6	3	94.1	14	1796	1393	264	
7	2	53.9	14	1293	-	525	
8	1	99.3	14	-	-	155	
9	2	73.3	14	1458	-	65	
10	2	93.3	14	1196	-	451	
11	3	55.8	14	1895	1034	243	
12	1	66.4	14	-	-	228	
13	2	65.6	14	1732	-	746	
14	2	76.5	14	1187	-	522	
Detection Check (1=Detection; 0=No Detection)							1



Trial Number							21
Number of Bursts in Trial							15
Chirp Center Frequency							5563
Burst	No. of Pulses	Pulse Width (us)	Chirp Width (MHz)	Pulse 1-to-2 Spacing (us)	Pulse 2-to-3 Spacing (us)	Starting Location Within Interval (ms)	
1	1	85.1	13	-	-	565	
2	2	72.5	13	1648	-	211	
3	1	67.5	13	-	-	348	
4	2	56.1	13	1360	-	156	
5	1	71.1	13	-	-	718	
6	2	93.1	13	1391	-	400	
7	1	56.5	13	-	-	482	
8	1	63.8	13	-	-	703	
9	2	67.4	13	1727	-	780	
10	1	52.3	13	-	-	102	
11	3	62.4	13	1228	1715	304	
12	2	53.3	13	1630	-	57	
13	2	83.1	13	1205	-	768	
14	2	93.7	13	1085	-	461	
15	2	90.7	13	1297	-	746	
Detection Check (1=Detection; 0=No Detection)							1

Trial Number							22
Number of Bursts in Trial							16
Chirp Center Frequency							5563
Burst	No. of Pulses	Pulse Width (us)	Chirp Width (MHz)	Pulse 1-to-2 Spacing (us)	Pulse 2-to-3 Spacing (us)	Starting Location Within Interval (ms)	
1	2	98.8	12	1439	-	95	
2	1	54.5	12	-	-	676	
3	2	80.5	12	1360	-	8	
4	2	55.9	12	1906	-	373	
5	2	72.1	12	1623	-	254	
6	2	84.4	12	1604	-	480	
7	1	78.5	12	-	-	663	
8	1	88	12	-	-	314	
9	2	74.7	12	1157	-	596	
10	2	97.1	12	1673	-	264	
11	1	81.6	12	-	-	740	
12	1	83.6	12	-	-	163	
13	3	87.6	12	1757	1322	628	
14	2	58.5	12	1372	-	132	
15	3	91.8	12	1767	1183	106	
16	2	58.8	12	1432	-	659	
Detection Check (1=Detection; 0=No Detection)							1



Trial Number			23			
Number of Bursts in Trial			17			
Chirp Center Frequency			5564			
Burst	No. of Pulses	Pulse Width (us)	Chirp Width (MHz)	Pulse 1-to-2 Spacing (us)	Pulse 2-to-3 Spacing (us)	Starting Location Within Interval (ms)
1	1	96	11	-	-	284
2	2	92.5	11	1241	-	488
3	2	89.5	11	1347	-	76
4	2	74.8	11	1607	-	688
5	2	60.6	11	1523	-	28
6	2	71.5	11	1659	-	383
7	2	71.1	11	1454	-	182
8	1	98.7	11	-	-	20
9	2	85.1	11	1770	-	576
10	2	89.2	11	1086	-	410
11	2	60.7	11	1101	-	458
12	2	75.2	11	1719	-	348
13	2	75.7	11	1799	-	481
14	3	56.7	11	1132	1884	587
15	2	65	11	1885	-	480
16	2	64.6	11	1910	-	195
17	3	69.9	11	1410	1190	396
Detection Check (1=Detection; 0=No Detection)						1



Trial Number			24			
Number of Bursts in Trial			18			
Chirp Center Frequency			5564			
Burst	No. of Pulses	Pulse Width (us)	Chirp Width (MHz)	Pulse 1-to-2 Spacing (us)	Pulse 2-to-3 Spacing (us)	Starting Location Within Interval (ms)
1	3	83.8	10	1290	1021	536
2	2	66.9	10	1112	-	44
3	3	91	10	1220	1504	611
4	2	86.1	10	1678	-	456
5	3	65.5	10	1928	1222	330
6	1	62.6	10	-	-	297
7	3	68.7	10	1505	1200	351
8	3	59.2	10	1452	1114	230
9	1	73.9	10	-	-	222
10	1	77.2	10	-	-	57
11	2	96.4	10	1357	-	399
12	2	99.9	10	1173	-	299
13	2	99.9	10	1520	-	464
14	1	86.7	10	-	-	294
15	1	92.6	10	-	-	653
16	1	77.1	10	-	-	550
17	2	81.1	10	1664	-	566
18	3	68.4	10	1536	1309	580
Detection Check (1=Detection; 0=No Detection)						1



Trial Number			25			
Number of Bursts in Trial			19			
Chirp Center Frequency			5564			
Burst	No. of Pulses	Pulse Width (us)	Chirp Width (MHz)	Pulse 1-to-2 Spacing (us)	Pulse 2-to-3 Spacing (us)	Starting Location Within Interval (ms)
1	3	68.2	9	1723	1868	471
2	3	83.7	9	1711	1405	368
3	2	69.7	9	1781	-	425
4	1	59.7	9	-	-	440
5	2	96.7	9	1484	-	123
6	2	95.8	9	1319	-	261
7	3	71.3	9	1095	1354	332
8	3	53.2	9	1527	1427	427
9	2	69.5	9	1771	-	397
10	3	63.9	9	1075	1447	67
11	2	93.4	9	1783	-	174
12	2	77.3	9	1564	-	17
13	2	73.1	9	1294	-	216
14	1	77.4	9	-	-	292
15	3	57.2	9	1722	1886	619
16	2	68.7	9	1629	-	233
17	1	60.8	9	-	-	226
18	3	69.7	9	1128	1224	599
19	1	62.2	9	-	-	433
Detection Check (1=Detection; 0=No Detection)						1



Trial Number							26
Number of Bursts in Trial							20
Chirp Center Frequency							5565
Burst	No. of Pulses	Pulse Width (us)	Chirp Width (MHz)	Pulse 1-to-2 Spacing (us)	Pulse 2-to-3 Spacing (us)	Starting Location Within Interval (ms)	
1	1	80.5	8	-	-	90	
2	3	62.6	8	1406	1343	319	
3	3	85.6	8	1190	1529	384	
4	2	83.9	8	1208	-	567	
5	2	92.4	8	1488	-	234	
6	2	54	8	1529	-	535	
7	3	81.3	8	1501	1812	325	
8	1	98.5	8	-	-	532	
9	1	85.8	8	-	-	272	
10	2	84.7	8	1593	-	182	
11	2	83.3	8	1705	-	134	
12	2	79.8	8	1567	-	286	
13	1	77.9	8	-	-	368	
14	3	98.4	8	1510	1569	290	
15	2	79.9	8	1588	-	231	
16	3	78	8	1140	1353	353	
17	3	55.2	8	1700	1327	53	
18	3	71.9	8	1081	1224	44	
19	1	62	8	-	-	298	
20	3	70.5	8	1888	1442	529	
Detection Check (1=Detection; 0=No Detection)							1

Trial Number							27
Number of Bursts in Trial							8
Chirp Center Frequency							5561
Burst	No. of Pulses	Pulse Width (us)	Chirp Width (MHz)	Pulse 1-to-2 Spacing (us)	Pulse 2-to-3 Spacing (us)	Starting Location Within Interval (ms)	
1	2	69.1	18	1076	-	1436	
2	2	62.1	18	1688	-	22	
3	2	94.8	18	1891	-	897	
4	1	75.8	18	-	-	1186	
5	2	65.4	18	1713	-	589	
6	2	97.7	18	1292	-	614	
7	3	98.1	18	1670	1711	506	
8	2	85.4	18	1672	-	776	
Detection Check (1=Detection; 0=No Detection)							1



Trial Number							28
Number of Bursts in Trial							9
Chirp Center Frequency							5560
Burst	No. of Pulses	Pulse Width (us)	Chirp Width (MHz)	Pulse 1-to-2 Spacing (us)	Pulse 2-to-3 Spacing (us)	Starting Location Within Interval (ms)	
1	3	82	19	1233	1713	679	
2	3	87.7	19	1554	1123	473	
3	2	98.9	19	1518	-	869	
4	1	55	19	-	-	719	
5	1	93.6	19	-	-	902	
6	2	58.7	19	1641	-	1243	
7	2	88.7	19	1387	-	410	
8	1	60.3	19	-	-	1154	
9	1	97.7	19	-	-	512	
Detection Check (1=Detection; 0=No Detection)							1

Trial Number							29
Number of Bursts in Trial							10
Chirp Center Frequency							5560
Burst	No. of Pulses	Pulse Width (us)	Chirp Width (MHz)	Pulse 1-to-2 Spacing (us)	Pulse 2-to-3 Spacing (us)	Starting Location Within Interval (ms)	
1	1	69.6	20	-	-	1131	
2	1	74.5	20	-	-	290	
3	1	60.9	20	-	-	895	
4	1	74.6	20	-	-	202	
5	2	99.3	20	1501	-	139	
6	2	95.3	20	1065	-	854	
7	2	91.9	20	1722	-	219	
8	2	51	20	1285	-	57	
9	2	87.7	20	1747	-	141	
10	1	87.2	20	-	-	596	
Detection Check (1=Detection; 0=No Detection)							1



Trial Number		30				
Number of Bursts in Trial		11				
Chirp Center Frequency		5566				
Burst	No. of Pulses	Pulse Width (us)	Chirp Width (MHz)	Pulse 1-to-2 Spacing (us)	Pulse 2-to-3 Spacing (us)	Starting Location Within Interval (ms)
1	3	59.9	5	1901	1196	935
2	2	77.1	5	1590	-	1038
3	2	62.7	5	1227	-	690
4	1	77.1	5	-	-	547
5	3	99.8	5	1798	1790	551
6	2	61.5	5	1135	-	876
7	2	77.5	5	1583	-	448
8	2	57.3	5	1890	-	736
9	2	53.5	5	1757	-	362
10	1	66.6	5	-	-	836
11	3	80.7	5	1811	1289	410
Detection Check (1=Detection; 0=No Detection)						1



Type 6 Radar Statistical Performance

Trial #	Test Freq. (MHz)	Pulses / Hop	Pulse Width (us)	PRI (us)	1=Detection 0=No Detection
1	5530	9	1	333	1
2	5530	9	1	333	1
3	5530	9	1	333	1
4	5530	9	1	333	1
5	5530	9	1	333	1
6	5530	9	1	333	1
7	5530	9	1	333	1
8	5530	9	1	333	1
9	5530	9	1	333	1
10	5530	9	1	333	1
11	5530	9	1	333	1
12	5530	9	1	333	1
13	5530	9	1	333	1
14	5530	9	1	333	1
15	5530	9	1	333	1
16	5530	9	1	333	1
17	5530	9	1	333	1
18	5530	9	1	333	1
19	5530	9	1	333	1
20	5530	9	1	333	1
21	5530	9	1	333	1
22	5530	9	1	333	1
23	5530	9	1	333	1
24	5530	9	1	333	1
25	5530	9	1	333	1
26	5530	9	1	333	1
27	5530	9	1	333	1
28	5530	9	1	333	1
29	5530	9	1	333	1
30	5530	9	1	333	1
Detection Percentage (%)					100.000
Limit					70%
Test Result					Complied



Modulation Mode: 802.11ax(160MHz) / 5570 MHz

Type 1 Radar Statistical Performance

Trial #	Test Freq. (MHz)	Pulse Repetition Frequency Number	Pulse Repetition Frequency (Pulse Per Second)	PRI (us)	1=Detection 0=No Detection
1	5647	1	1930.5	518	1
2	5563	23	326.2	3066	1
3	5537	19	1139.0	878	1
4	5620	12	1355.0	738	1
5	5553	4	1730.1	578	1
6	5524	8	1519.8	658	1
7	5577	15	1253.1	798	1
8	5522	6	1618.1	618	1
9	5510	14	1285.3	778	1
10	5632	3	1792.1	558	1
11	5594	13	1319.3	758	1
12	5525	9	1474.9	678	1
13	5641	7	1567.4	638	1
14	5515	17	1193.3	838	1
15	5644	10	1432.7	698	1
16	5640	-	1692.0	591	1
17	5594	-	328.1	3048	1
18	5553	-	373.4	2678	1
19	5518	-	574.4	1741	1
20	5529	-	1216.5	822	1
21	5648	-	801.3	1248	1
22	5620	-	488.5	2047	1
23	5599	-	956.0	1046	1
24	5620	-	517.6	1932	1
25	5549	-	1422.5	703	1
26	5565	-	542.0	1845	1
27	5493	-	741.3	1349	1
28	5605	-	881.8	1134	0
29	5598	-	427.4	2340	1
30	5592	-	628.9	1590	1
Detection Percentage (%)					96.667
Limit					60%
Test Result					Complied



Type 2 Radar Statistical Performance

Trial #	Test Freq. (MHz)	Pulse Width (us)	PRI (us)	Pulses / Burst	1=Detection 0=No Detection
1	5569	2.6	221	23	1
2	5603	4.6	198	27	1
3	5564	1.1	184	29	1
4	5621	4.8	203	24	0
5	5640	2.4	162	25	1
6	5525	3.4	204	28	1
7	5648	2.3	170	27	1
8	5517	3.5	184	23	0
9	5594	4.9	150	27	1
10	5562	4.6	211	29	1
11	5535	2.9	158	23	1
12	5640	2.6	226	27	1
13	5567	1.6	204	26	1
14	5509	3.9	181	25	1
15	5630	4.6	202	24	0
16	5623	4.1	194	27	1
17	5591	2.3	193	28	1
18	5516	3.9	173	29	1
19	5573	4.3	188	23	1
20	5594	1.5	215	26	1
21	5555	4.9	227	27	0
22	5493	1.1	199	23	1
23	5621	4.5	155	29	1
24	5550	4.0	190	27	1
25	5558	2.4	151	23	1
26	5617	2.5	180	28	1
27	5496	2.5	228	23	1
28	5562	2.5	203	25	1
29	5521	1.5	188	25	1
30	5498	1.9	217	24	1
Detection Percentage (%)					86.667
Limit					60%
Test Result					Complied



Type 3 Radar Statistical Performance

Trial #	Test Freq. (MHz)	Pulse Width (us)	PRI (us)	Pulses / Burst	1=Detection 0=No Detection
1	5601	8.0	205	16	1
2	5520	6.7	382	18	1
3	5543	8.6	418	16	0
4	5570	9.4	351	17	1
5	5622	7.4	383	18	1
6	5493	9.8	232	16	0
7	5647	9.1	377	17	1
8	5542	9.6	457	16	1
9	5579	8.0	471	18	1
10	5555	9.0	304	18	0
11	5495	8.0	316	17	1
12	5510	9.8	325	16	1
13	5517	8.0	409	17	1
14	5616	9.9	200	17	1
15	5597	8.8	458	16	1
16	5541	8.0	232	18	0
17	5648	8.3	250	16	1
18	5577	8.7	270	16	1
19	5625	7.7	350	17	1
20	5559	7.1	230	16	1
21	5596	7.3	416	18	1
22	5634	7.6	498	18	0
23	5625	7.3	286	17	1
24	5505	7.3	287	16	1
25	5510	7.5	462	17	1
26	5600	6.2	300	17	1
27	5541	6.4	323	18	0
28	5531	7.1	420	16	1
29	5501	7.2	395	18	1
30	5609	8.4	377	16	1
Detection Percentage (%)					80.000
Limit					60%
Test Result					Complied



Type 4 Radar Statistical Performance

Trial #	Test Freq. (MHz)	Pulse Width (us)	PRI (us)	Pulses / Burst	1=Detection 0=No Detection
1	5544	18.0	242	15	1
2	5636	19.9	279	12	1
3	5604	12.9	487	14	0
4	5635	15.0	452	13	1
5	5602	16.3	230	12	1
6	5503	19.8	238	13	1
7	5620	18.2	420	16	0
8	5574	16.3	452	15	1
9	5564	14.2	495	12	1
10	5643	17.8	228	16	1
11	5493	19.1	211	16	1
12	5621	18.4	283	15	1
13	5593	11.8	411	12	1
14	5613	14.2	284	13	1
15	5587	13.9	202	12	0
16	5585	17.8	340	14	1
17	5566	15.6	290	16	1
18	5544	14.6	250	16	1
19	5541	14.4	484	15	0
20	5627	18.9	387	13	1
21	5592	11.1	348	15	0
22	5504	13.8	291	16	1
23	5505	14.3	295	12	1
24	5547	12.5	300	12	1
25	5619	12.5	322	14	0
26	5648	12.5	383	13	1
27	5575	15.7	322	16	1
28	5543	19.8	469	13	1
29	5534	18.6	406	15	0
30	5512	15.9	238	14	1
Detection Percentage (%)					76.667
Limit					60%
Test Result					Complied



Total Type 1~4 Radar Statistical Performance

Radar Type #	Detection Percentage (%)
1	96.667
2	86.667
3	80.000
4	76.667
Aggregate (Radar Types 1-4)	85.000
Limit	80%
Test Result	Complied



Type 5 Radar Statistical Performance

Center Freq. (MHz)	Low Edge (MHz)	High Edge (MHz)	VSG Freq. (MHz)	Detection
Trial	Chirp	Offset		
1	5	2	5570.0	1
2	20	8	5570.0	1
3	7	2.8	5570.0	1
4	8	3.2	5570.0	1
5	9	3.6	5570.0	1
6	10	4	5570.0	1
7	11	4.4	5570.0	1
8	12	4.8	5570.0	1
9	13	5.2	5570.0	1
10	14	5.6	5570.0	1
11	15	6	5498.0	1
12	16	6.4	5498.4	1
13	17	6.8	5498.8	1
14	20	8	5500.0	0
15	19	7.6	5499.6	1
16	18	7.2	5499.2	0
17	17	6.8	5498.8	0
18	16	6.4	5498.4	1
19	15	6	5498.0	1
20	14	5.6	5497.6	1
21	13	5.2	5641.8	1
22	12	4.8	5642.2	1
23	11	4.4	5642.6	1
24	10	4	5643.0	1
25	9	3.6	5643.4	1
26	8	3.2	5643.8	1
27	18	7.2	5639.8	1
28	19	7.6	5639.4	1
29	20	8	5639.0	0
30	5	2	5645.0	1
Total				26
Detection Percentage (%)				87%
Limit				80%
Test Result				Complied



Trial Number							1
Number of Bursts in Trial							8
Chirp Center Frequency							5570
Burst	No. of Pulses	Pulse Width (us)	Chirp Width (MHz)	Pulse 1-to-2 Spacing (us)	Pulse 2-to-3 Spacing (us)	Starting Location Within Interval (ms)	
1	1	62.1	5	-	-	1091	
2	2	56	5	1729	-	133	
3	2	91.3	5	1230	-	1057	
4	3	50.7	5	1762	1616	1442	
5	2	92.6	5	1723	-	544	
6	2	87.3	5	1302	-	1089	
7	2	59.5	5	1291	-	1374	
8	2	52.2	5	1653	-	1237	
Detection Check (1=Detection; 0=No Detection)							1

Trial Number							2
Number of Bursts in Trial							9
Chirp Center Frequency							5570
Burst	No. of Pulses	Pulse Width (us)	Chirp Width (MHz)	Pulse 1-to-2 Spacing (us)	Pulse 2-to-3 Spacing (us)	Starting Location Within Interval (ms)	
1	3	90	20	1007	1326	30	
2	2	73.7	20	1785	-	979	
3	1	78.1	20	-	-	683	
4	2	92.4	20	1281	-	950	
5	1	61.2	20	-	-	612	
6	3	67.2	20	1525	1870	17	
7	1	78.5	20	-	-	429	
8	2	60.3	20	1931	-	936	
9	3	92.9	20	1403	1476	548	
Detection Check (1=Detection; 0=No Detection)							1



Trial Number							3
Number of Bursts in Trial							10
Chirp Center Frequency							5570
Burst	No. of Pulses	Pulse Width (us)	Chirp Width (MHz)	Pulse 1-to-2 Spacing (us)	Pulse 2-to-3 Spacing (us)	Starting Location Within Interval (ms)	
1	3	63.4	7	1574	1607	801	
2	1	98	7	-	-	966	
3	1	58.7	7	-	-	185	
4	1	88	7	-	-	1012	
5	3	79.5	7	1562	1370	943	
6	3	57.1	7	1900	1188	686	
7	2	64.4	7	1090	-	599	
8	1	78.7	7	-	-	1089	
9	1	69.3	7	-	-	188	
10	3	55.3	7	1375	1691	933	
Detection Check (1=Detection; 0=No Detection)							1

Trial Number							4
Number of Bursts in Trial							11
Chirp Center Frequency							5570
Burst	No. of Pulses	Pulse Width (us)	Chirp Width (MHz)	Pulse 1-to-2 Spacing (us)	Pulse 2-to-3 Spacing (us)	Starting Location Within Interval (ms)	
1	2	74.3	8	1642	-	24	
2	1	83.1	8	-	-	985	
3	2	59.5	8	1680	-	988	
4	2	59.8	8	1786	-	800	
5	2	77.6	8	1617	-	339	
6	2	79.9	8	1553	-	1040	
7	1	56	8	-	-	544	
8	3	71.4	8	1406	1927	452	
9	1	97.4	8	-	-	204	
10	2	98.3	8	1037	-	926	
11	1	63.6	8	-	-	1052	
Detection Check (1=Detection; 0=No Detection)							1



Trial Number							5
Number of Bursts in Trial							12
Chirp Center Frequency							5570
Burst	No. of Pulses	Pulse Width (us)	Chirp Width (MHz)	Pulse 1-to-2 Spacing (us)	Pulse 2-to-3 Spacing (us)	Starting Location Within Interval (ms)	
1	1	50	9	-	-	557	
2	2	62.5	9	1731	-	567	
3	2	55.4	9	1070	-	460	
4	1	65.7	9	-	-	4	
5	2	58	9	1512	-	64	
6	2	60.9	9	1230	-	650	
7	3	89.6	9	1598	1738	235	
8	3	84.4	9	1271	1617	873	
9	3	72.3	9	1498	1321	901	
10	1	58.9	9	-	-	663	
11	2	74.8	9	1584	-	919	
12	1	71.8	9	-	-	375	
Detection Check (1=Detection; 0=No Detection)							1

Trial Number							6
Number of Bursts in Trial							13
Chirp Center Frequency							5570
Burst	No. of Pulses	Pulse Width (us)	Chirp Width (MHz)	Pulse 1-to-2 Spacing (us)	Pulse 2-to-3 Spacing (us)	Starting Location Within Interval (ms)	
1	2	88.1	10	1257	-	846	
2	1	58.7	10	-	-	725	
3	2	97.1	10	1037	-	30	
4	3	83.1	10	1029	1106	490	
5	1	62.1	10	-	-	262	
6	2	71.4	10	1058	-	283	
7	2	86.3	10	1867	-	49	
8	3	77.3	10	1418	1876	634	
9	1	78.9	10	-	-	304	
10	3	79.2	10	1055	1572	564	
11	3	52	10	1582	1836	852	
12	3	56.5	10	1195	1542	525	
13	3	100	10	1638	1729	750	
Detection Check (1=Detection; 0=No Detection)							1



Trial Number							7
Number of Bursts in Trial							14
Chirp Center Frequency							5570
Burst	No. of Pulses	Pulse Width (us)	Chirp Width (MHz)	Pulse 1-to-2 Spacing (us)	Pulse 2-to-3 Spacing (us)	Starting Location Within Interval (ms)	
1	2	92.7	11	1208	-	231	
2	2	81.3	11	1144	-	804	
3	2	60.4	11	1555	-	34	
4	2	62.1	11	1320	-	427	
5	1	50	11	-	-	577	
6	3	65.9	11	1020	1365	3	
7	2	73.8	11	1308	-	51	
8	2	74.3	11	1143	-	360	
9	1	62.9	11	-	-	394	
10	2	74.8	11	1404	-	317	
11	2	69.7	11	1309	-	532	
12	2	69.8	11	1688	-	339	
13	2	77.4	11	1857	-	381	
14	1	55.1	11	-	-	426	
Detection Check (1=Detection; 0=No Detection)							1

Trial Number							8
Number of Bursts in Trial							15
Chirp Center Frequency							5570
Burst	No. of Pulses	Pulse Width (us)	Chirp Width (MHz)	Pulse 1-to-2 Spacing (us)	Pulse 2-to-3 Spacing (us)	Starting Location Within Interval (ms)	
1	1	91.7	12	-	-	776	
2	2	90	12	1196	-	187	
3	3	92.3	12	1486	1853	448	
4	2	66.8	12	1545	-	702	
5	1	64	12	-	-	403	
6	3	95.4	12	1123	1473	230	
7	3	66.8	12	1867	1401	604	
8	3	67.7	12	1472	1397	38	
9	1	68.2	12	-	-	735	
10	2	82.2	12	1297	-	610	
11	1	92.1	12	-	-	618	
12	2	57	12	1764	-	705	
13	2	58.5	12	1310	-	22	
14	3	85.5	12	1630	1447	641	
15	2	82.2	12	1371	-	109	
Detection Check (1=Detection; 0=No Detection)							1



Trial Number			9			
Number of Bursts in Trial			16			
Chirp Center Frequency			5570			
Burst	No. of Pulses	Pulse Width (us)	Chirp Width (MHz)	Pulse 1-to-2 Spacing (us)	Pulse 2-to-3 Spacing (us)	Starting Location Within Interval (ms)
1	2	74.4	13	1707	-	442
2	2	63.6	13	1725	-	280
3	2	71.3	13	1704	-	459
4	3	77.6	13	1063	1405	197
5	3	65.2	13	1731	1294	101
6	3	55.1	13	1109	1549	17
7	2	96.8	13	1034	-	131
8	3	80.8	13	1533	1051	365
9	1	60.4	13	-	-	222
10	2	61.8	13	1312	-	371
11	2	71.3	13	1657	-	33
12	2	98.1	13	1024	-	291
13	1	57.9	13	-	-	188
14	1	91.8	13	-	-	163
15	2	56.7	13	1259	-	426
16	2	89.7	13	1690	-	606
Detection Check (1=Detection; 0=No Detection)						1



Trial Number			10			
Number of Bursts in Trial			17			
Chirp Center Frequency			5570			
Burst	No. of Pulses	Pulse Width (us)	Chirp Width (MHz)	Pulse 1-to-2 Spacing (us)	Pulse 2-to-3 Spacing (us)	Starting Location Within Interval (ms)
1	2	74.4	14	1107	-	462
2	1	87.6	14	-	-	653
3	2	61.7	14	1741	-	457
4	2	57.5	14	1566	-	388
5	2	66.1	14	1855	-	63
6	3	70.1	14	1044	1012	136
7	1	66.4	14	-	-	343
8	1	59.2	14	-	-	349
9	2	88.3	14	1240	-	362
10	1	64.7	14	-	-	221
11	2	73	14	1703	-	144
12	2	81.7	14	1450	-	671
13	3	70.1	14	1741	1278	320
14	1	63.6	14	-	-	196
15	1	58.7	14	-	-	413
16	2	65.9	14	1478	-	170
17	1	72.7	14	-	-	564
Detection Check (1=Detection; 0=No Detection)						1



Trial Number		11				
Number of Bursts in Trial		18				
Chirp Center Frequency		5498				
Burst	No. of Pulses	Pulse Width (us)	Chirp Width (MHz)	Pulse 1-to-2 Spacing (us)	Pulse 2-to-3 Spacing (us)	Starting Location Within Interval (ms)
1	2	72.1	15	1193	-	130
2	3	76.3	15	1484	1390	114
3	1	86.1	15	-	-	14
4	1	73.2	15	-	-	604
5	1	81.2	15	-	-	548
6	2	99.5	15	1398	-	173
7	1	93.9	15	-	-	262
8	2	75.9	15	1921	-	38
9	3	79.2	15	1100	1429	84
10	3	77	15	1166	1799	610
11	1	91.8	15	-	-	339
12	3	56.8	15	1330	1556	580
13	2	83.1	15	1556	-	295
14	2	63	15	1552	-	156
15	1	65.7	15	-	-	439
16	1	64.5	15	-	-	188
17	1	88.5	15	-	-	419
18	1	60.6	15	-	-	205
Detection Check (1=Detection; 0=No Detection)						1



Trial Number			12			
Number of Bursts in Trial			19			
Chirp Center Frequency			5498			
Burst	No. of Pulses	Pulse Width (us)	Chirp Width (MHz)	Pulse 1-to-2 Spacing (us)	Pulse 2-to-3 Spacing (us)	Starting Location Within Interval (ms)
1	2	90.5	16	1299	-	381
2	2	88.4	16	1418	-	327
3	2	53.7	16	1055	-	536
4	1	80.5	16	-	-	285
5	1	50.4	16	-	-	398
6	2	61.2	16	1749	-	439
7	2	78.8	16	1065	-	129
8	3	75	16	1748	1820	325
9	2	96.7	16	1254	-	440
10	3	76.3	16	1848	1106	397
11	1	73.3	16	-	-	232
12	2	92.4	16	1317	-	91
13	2	92.4	16	1854	-	256
14	3	64.4	16	1240	1634	582
15	2	67.3	16	1473	-	117
16	2	84.1	16	1795	-	202
17	1	80.9	16	-	-	135
18	1	74.6	16	-	-	396
19	2	97.6	16	1805	-	615
Detection Check (1=Detection; 0=No Detection)						1



Trial Number							13
Number of Bursts in Trial							20
Chirp Center Frequency							5499
Burst	No. of Pulses	Pulse Width (us)	Chirp Width (MHz)	Pulse 1-to-2 Spacing (us)	Pulse 2-to-3 Spacing (us)	Starting Location Within Interval (ms)	
1	2	66.1	17	1417	-	388	
2	2	86.7	17	1693	-	348	
3	2	70.5	17	1263	-	215	
4	2	78	17	1446	-	28	
5	2	66	17	1185	-	585	
6	2	80.6	17	1855	-	65	
7	1	95.5	17	-	-	92	
8	1	98.8	17	-	-	68	
9	3	64.3	17	1641	1108	517	
10	1	75.1	17	-	-	121	
11	2	72.6	17	1499	-	448	
12	1	60.3	17	-	-	567	
13	2	54.9	17	1056	-	245	
14	2	98.8	17	1023	-	584	
15	2	60.9	17	1243	-	579	
16	2	62.7	17	1226	-	464	
17	1	80.1	17	-	-	89	
18	2	70.9	17	1711	-	153	
19	1	90.7	17	-	-	282	
20	1	98.9	17	-	-	71	
Detection Check (1=Detection; 0=No Detection)							1

Trial Number							14
Number of Bursts in Trial							8
Chirp Center Frequency							5500
Burst	No. of Pulses	Pulse Width (us)	Chirp Width (MHz)	Pulse 1-to-2 Spacing (us)	Pulse 2-to-3 Spacing (us)	Starting Location Within Interval (ms)	
1	2	67.5	20	1542	-	947	
2	3	83.6	20	1272	1696	124	
3	2	93.2	20	1877	-	701	
4	1	55.6	20	-	-	1123	
5	3	84.2	20	1733	1619	756	
6	3	69.1	20	1612	1071	1	
7	2	66.9	20	1905	-	7	
8	3	86.8	20	1697	1621	1082	
Detection Check (1=Detection; 0=No Detection)							0



Trial Number							15
Number of Bursts in Trial							9
Chirp Center Frequency							5500
Burst	No. of Pulses	Pulse Width (us)	Chirp Width (MHz)	Pulse 1-to-2 Spacing (us)	Pulse 2-to-3 Spacing (us)	Starting Location Within Interval (ms)	
1	2	62.2	19	1571	-	949	
2	2	85	19	1669	-	189	
3	2	64.5	19	1505	-	176	
4	2	50.4	19	1325	-	538	
5	2	66.1	19	1483	-	908	
6	2	71.2	19	1110	-	1017	
7	3	53.7	19	1445	1677	492	
8	3	62.5	19	1596	1341	349	
9	3	62	19	1929	1221	1105	
Detection Check (1=Detection; 0=No Detection)							1

Trial Number							16
Number of Bursts in Trial							10
Chirp Center Frequency							5499
Burst	No. of Pulses	Pulse Width (us)	Chirp Width (MHz)	Pulse 1-to-2 Spacing (us)	Pulse 2-to-3 Spacing (us)	Starting Location Within Interval (ms)	
1	2	80.5	18	1910	-	284	
2	2	64.2	18	1661	-	751	
3	2	90.1	18	1041	-	491	
4	2	69.8	18	1495	-	107	
5	1	73.1	18	-	-	490	
6	3	77.2	18	1418	1145	1155	
7	3	52.6	18	1732	1787	772	
8	2	71.4	18	1562	-	121	
9	2	89.8	18	1491	-	89	
10	2	76.4	18	1355	-	615	
Detection Check (1=Detection; 0=No Detection)							0



Trial Number							17
Number of Bursts in Trial							11
Chirp Center Frequency							5499
Burst	No. of Pulses	Pulse Width (us)	Chirp Width (MHz)	Pulse 1-to-2 Spacing (us)	Pulse 2-to-3 Spacing (us)	Starting Location Within Interval (ms)	
1	2	51.2	17	1236	-	740	
2	1	71.7	17	-	-	941	
3	2	74.7	17	1164	-	370	
4	2	50.9	17	1919	-	371	
5	2	65.2	17	1206	-	1033	
6	2	98	17	1182	-	346	
7	2	58.7	17	1612	-	639	
8	1	63.8	17	-	-	1056	
9	3	86.3	17	1545	1065	205	
10	1	94.4	17	-	-	753	
11	3	88.5	17	1699	1319	58	
Detection Check (1=Detection; 0=No Detection)							0

Trial Number							18
Number of Bursts in Trial							12
Chirp Center Frequency							5498
Burst	No. of Pulses	Pulse Width (us)	Chirp Width (MHz)	Pulse 1-to-2 Spacing (us)	Pulse 2-to-3 Spacing (us)	Starting Location Within Interval (ms)	
1	2	88.7	16	1405	-	448	
2	3	90.2	16	1544	1235	621	
3	1	96.5	16	-	-	512	
4	2	80.5	16	1090	-	321	
5	2	63.7	16	1268	-	798	
6	1	53.4	16	-	-	809	
7	2	52.3	16	1043	-	301	
8	3	54.7	16	1701	1104	796	
9	3	75.6	16	1923	1729	669	
10	2	59.2	16	1244	-	369	
11	1	56.3	16	-	-	51	
12	2	87.8	16	1608	-	733	
Detection Check (1=Detection; 0=No Detection)							1



Trial Number							19
Number of Bursts in Trial							13
Chirp Center Frequency							5498
Burst	No. of Pulses	Pulse Width (us)	Chirp Width (MHz)	Pulse 1-to-2 Spacing (us)	Pulse 2-to-3 Spacing (us)	Starting Location Within Interval (ms)	
1	2	68.2	15	1104	-	229	
2	2	58.4	15	1627	-	488	
3	3	74.7	15	1861	1015	137	
4	2	58.2	15	1593	-	520	
5	1	51.6	15	-	-	799	
6	2	94.7	15	1469	-	43	
7	2	70.7	15	1091	-	126	
8	2	82.9	15	1472	-	607	
9	3	62.7	15	1168	1453	527	
10	2	63.1	15	1529	-	143	
11	1	96.1	15	-	-	176	
12	2	57	15	1457	-	882	
13	3	95.6	15	1707	1501	214	
Detection Check (1=Detection; 0=No Detection)							1

Trial Number							20
Number of Bursts in Trial							14
Chirp Center Frequency							5498
Burst	No. of Pulses	Pulse Width (us)	Chirp Width (MHz)	Pulse 1-to-2 Spacing (us)	Pulse 2-to-3 Spacing (us)	Starting Location Within Interval (ms)	
1	1	95.7	14	-	-	117	
2	1	93.1	14	-	-	720	
3	1	55.8	14	-	-	297	
4	1	76.7	14	-	-	284	
5	2	68	14	1686	-	472	
6	3	94.1	14	1796	1393	264	
7	2	53.9	14	1293	-	525	
8	1	99.3	14	-	-	155	
9	2	73.3	14	1458	-	65	
10	2	93.3	14	1196	-	451	
11	3	55.8	14	1895	1034	243	
12	1	66.4	14	-	-	228	
13	2	65.6	14	1732	-	746	
14	2	76.5	14	1187	-	522	
Detection Check (1=Detection; 0=No Detection)							1



Trial Number							21
Number of Bursts in Trial							15
Chirp Center Frequency							5642
Burst	No. of Pulses	Pulse Width (us)	Chirp Width (MHz)	Pulse 1-to-2 Spacing (us)	Pulse 2-to-3 Spacing (us)	Starting Location Within Interval (ms)	
1	1	85.1	13	-	-	565	
2	2	72.5	13	1648	-	211	
3	1	67.5	13	-	-	348	
4	2	56.1	13	1360	-	156	
5	1	71.1	13	-	-	718	
6	2	93.1	13	1391	-	400	
7	1	56.5	13	-	-	482	
8	1	63.8	13	-	-	703	
9	2	67.4	13	1727	-	780	
10	1	52.3	13	-	-	102	
11	3	62.4	13	1228	1715	304	
12	2	53.3	13	1630	-	57	
13	2	83.1	13	1205	-	768	
14	2	93.7	13	1085	-	461	
15	2	90.7	13	1297	-	746	
Detection Check (1=Detection; 0=No Detection)							1

Trial Number							22
Number of Bursts in Trial							16
Chirp Center Frequency							5642
Burst	No. of Pulses	Pulse Width (us)	Chirp Width (MHz)	Pulse 1-to-2 Spacing (us)	Pulse 2-to-3 Spacing (us)	Starting Location Within Interval (ms)	
1	2	98.8	12	1439	-	95	
2	1	54.5	12	-	-	676	
3	2	80.5	12	1360	-	8	
4	2	55.9	12	1906	-	373	
5	2	72.1	12	1623	-	254	
6	2	84.4	12	1604	-	480	
7	1	78.5	12	-	-	663	
8	1	88	12	-	-	314	
9	2	74.7	12	1157	-	596	
10	2	97.1	12	1673	-	264	
11	1	81.6	12	-	-	740	
12	1	83.6	12	-	-	163	
13	3	87.6	12	1757	1322	628	
14	2	58.5	12	1372	-	132	
15	3	91.8	12	1767	1183	106	
16	2	58.8	12	1432	-	659	
Detection Check (1=Detection; 0=No Detection)							1



Trial Number			23			
Number of Bursts in Trial			17			
Chirp Center Frequency			5643			
Burst	No. of Pulses	Pulse Width (us)	Chirp Width (MHz)	Pulse 1-to-2 Spacing (us)	Pulse 2-to-3 Spacing (us)	Starting Location Within Interval (ms)
1	1	96	11	-	-	284
2	2	92.5	11	1241	-	488
3	2	89.5	11	1347	-	76
4	2	74.8	11	1607	-	688
5	2	60.6	11	1523	-	28
6	2	71.5	11	1659	-	383
7	2	71.1	11	1454	-	182
8	1	98.7	11	-	-	20
9	2	85.1	11	1770	-	576
10	2	89.2	11	1086	-	410
11	2	60.7	11	1101	-	458
12	2	75.2	11	1719	-	348
13	2	75.7	11	1799	-	481
14	3	56.7	11	1132	1884	587
15	2	65	11	1885	-	480
16	2	64.6	11	1910	-	195
17	3	69.9	11	1410	1190	396
Detection Check (1=Detection; 0=No Detection)						1



Trial Number			24			
Number of Bursts in Trial			18			
Chirp Center Frequency			5643			
Burst	No. of Pulses	Pulse Width (us)	Chirp Width (MHz)	Pulse 1-to-2 Spacing (us)	Pulse 2-to-3 Spacing (us)	Starting Location Within Interval (ms)
1	3	83.8	10	1290	1021	536
2	2	66.9	10	1112	-	44
3	3	91	10	1220	1504	611
4	2	86.1	10	1678	-	456
5	3	65.5	10	1928	1222	330
6	1	62.6	10	-	-	297
7	3	68.7	10	1505	1200	351
8	3	59.2	10	1452	1114	230
9	1	73.9	10	-	-	222
10	1	77.2	10	-	-	57
11	2	96.4	10	1357	-	399
12	2	99.9	10	1173	-	299
13	2	99.9	10	1520	-	464
14	1	86.7	10	-	-	294
15	1	92.6	10	-	-	653
16	1	77.1	10	-	-	550
17	2	81.1	10	1664	-	566
18	3	68.4	10	1536	1309	580
Detection Check (1=Detection; 0=No Detection)						1



Trial Number			25			
Number of Bursts in Trial			19			
Chirp Center Frequency			5643			
Burst	No. of Pulses	Pulse Width (us)	Chirp Width (MHz)	Pulse 1-to-2 Spacing (us)	Pulse 2-to-3 Spacing (us)	Starting Location Within Interval (ms)
1	3	68.2	9	1723	1868	471
2	3	83.7	9	1711	1405	368
3	2	69.7	9	1781	-	425
4	1	59.7	9	-	-	440
5	2	96.7	9	1484	-	123
6	2	95.8	9	1319	-	261
7	3	71.3	9	1095	1354	332
8	3	53.2	9	1527	1427	427
9	2	69.5	9	1771	-	397
10	3	63.9	9	1075	1447	67
11	2	93.4	9	1783	-	174
12	2	77.3	9	1564	-	17
13	2	73.1	9	1294	-	216
14	1	77.4	9	-	-	292
15	3	57.2	9	1722	1886	619
16	2	68.7	9	1629	-	233
17	1	60.8	9	-	-	226
18	3	69.7	9	1128	1224	599
19	1	62.2	9	-	-	433
Detection Check (1=Detection; 0=No Detection)						1



Trial Number							26
Number of Bursts in Trial							20
Chirp Center Frequency							5644
Burst	No. of Pulses	Pulse Width (us)	Chirp Width (MHz)	Pulse 1-to-2 Spacing (us)	Pulse 2-to-3 Spacing (us)	Starting Location Within Interval (ms)	
1	1	80.5	8	-	-	90	
2	3	62.6	8	1406	1343	319	
3	3	85.6	8	1190	1529	384	
4	2	83.9	8	1208	-	567	
5	2	92.4	8	1488	-	234	
6	2	54	8	1529	-	535	
7	3	81.3	8	1501	1812	325	
8	1	98.5	8	-	-	532	
9	1	85.8	8	-	-	272	
10	2	84.7	8	1593	-	182	
11	2	83.3	8	1705	-	134	
12	2	79.8	8	1567	-	286	
13	1	77.9	8	-	-	368	
14	3	98.4	8	1510	1569	290	
15	2	79.9	8	1588	-	231	
16	3	78	8	1140	1353	353	
17	3	55.2	8	1700	1327	53	
18	3	71.9	8	1081	1224	44	
19	1	62	8	-	-	298	
20	3	70.5	8	1888	1442	529	
Detection Check (1=Detection; 0=No Detection)							1

Trial Number							27
Number of Bursts in Trial							8
Chirp Center Frequency							5640
Burst	No. of Pulses	Pulse Width (us)	Chirp Width (MHz)	Pulse 1-to-2 Spacing (us)	Pulse 2-to-3 Spacing (us)	Starting Location Within Interval (ms)	
1	2	69.1	18	1076	-	1436	
2	2	62.1	18	1688	-	22	
3	2	94.8	18	1891	-	897	
4	1	75.8	18	-	-	1186	
5	2	65.4	18	1713	-	589	
6	2	97.7	18	1292	-	614	
7	3	98.1	18	1670	1711	506	
8	2	85.4	18	1672	-	776	
Detection Check (1=Detection; 0=No Detection)							1



Trial Number							28
Number of Bursts in Trial							9
Chirp Center Frequency							5639
Burst	No. of Pulses	Pulse Width (us)	Chirp Width (MHz)	Pulse 1-to-2 Spacing (us)	Pulse 2-to-3 Spacing (us)	Starting Location Within Interval (ms)	
1	3	82	19	1233	1713	679	
2	3	87.7	19	1554	1123	473	
3	2	98.9	19	1518	-	869	
4	1	55	19	-	-	719	
5	1	93.6	19	-	-	902	
6	2	58.7	19	1641	-	1243	
7	2	88.7	19	1387	-	410	
8	1	60.3	19	-	-	1154	
9	1	97.7	19	-	-	512	
Detection Check (1=Detection; 0=No Detection)							1

Trial Number							29
Number of Bursts in Trial							10
Chirp Center Frequency							5639
Burst	No. of Pulses	Pulse Width (us)	Chirp Width (MHz)	Pulse 1-to-2 Spacing (us)	Pulse 2-to-3 Spacing (us)	Starting Location Within Interval (ms)	
1	1	69.6	20	-	-	1131	
2	1	74.5	20	-	-	290	
3	1	60.9	20	-	-	895	
4	1	74.6	20	-	-	202	
5	2	99.3	20	1501	-	139	
6	2	95.3	20	1065	-	854	
7	2	91.9	20	1722	-	219	
8	2	51	20	1285	-	57	
9	2	87.7	20	1747	-	141	
10	1	87.2	20	-	-	596	
Detection Check (1=Detection; 0=No Detection)							0



Trial Number		30				
Number of Bursts in Trial		11				
Chirp Center Frequency		5645				
Burst	No. of Pulses	Pulse Width (us)	Chirp Width (MHz)	Pulse 1-to-2 Spacing (us)	Pulse 2-to-3 Spacing (us)	Starting Location Within Interval (ms)
1	3	59.9	5	1901	1196	935
2	2	77.1	5	1590	-	1038
3	2	62.7	5	1227	-	690
4	1	77.1	5	-	-	547
5	3	99.8	5	1798	1790	551
6	2	61.5	5	1135	-	876
7	2	77.5	5	1583	-	448
8	2	57.3	5	1890	-	736
9	2	53.5	5	1757	-	362
10	1	66.6	5	-	-	836
11	3	80.7	5	1811	1289	410
Detection Check (1=Detection; 0=No Detection)						1



Type 6 Radar Statistical Performance

Trial #	Test Freq. (MHz)	Pulses / Hop	Pulse Width (us)	PRI (us)	1=Detection 0=No Detection
1	5570	9	1	333	1
2	5570	9	1	333	1
3	5570	9	1	333	1
4	5570	9	1	333	1
5	5570	9	1	333	1
6	5570	9	1	333	1
7	5570	9	1	333	1
8	5570	9	1	333	1
9	5570	9	1	333	1
10	5570	9	1	333	1
11	5570	9	1	333	1
12	5570	9	1	333	1
13	5570	9	1	333	1
14	5570	9	1	333	1
15	5570	9	1	333	1
16	5570	9	1	333	1
17	5570	9	1	333	1
18	5570	9	1	333	1
19	5570	9	1	333	1
20	5570	9	1	333	1
21	5570	9	1	333	1
22	5570	9	1	333	1
23	5570	9	1	333	1
24	5570	9	1	333	1
25	5570	9	1	333	1
26	5570	9	1	333	1
27	5570	9	1	333	1
28	5570	9	1	333	1
29	5570	9	1	333	1
30	5570	9	1	333	1
Detection Percentage (%)					100.000
Limit					70%
Test Result					Complied



Extender mode

Modulation Mode: 802.11ax(160MHz) / 5570 MHz

Type 4 Radar Statistical Performance

Trial #	Test Freq. (MHz)	Pulse Width (us)	PRI (us)	Pulses / Burst	1=Detection 0=No Detection
1	5582	18.0	242	15	1
2	5533	19.9	279	12	0
3	5507	12.9	487	14	1
4	5615	15.0	452	13	0
5	5629	16.3	230	12	1
6	5513	19.8	238	13	1
7	5568	18.2	420	16	1
8	5538	16.3	452	15	1
9	5630	14.2	495	12	1
10	5529	17.8	228	16	0
11	5641	19.1	211	16	1
12	5579	18.4	283	15	1
13	5581	11.8	411	12	0
14	5547	14.2	284	13	1
15	5565	13.9	202	12	1
16	5618	17.8	340	14	0
17	5492	15.6	290	16	1
18	5545	14.6	250	16	1
19	5508	14.4	484	15	1
20	5582	18.9	387	13	0
21	5497	11.1	348	15	1
22	5571	13.8	291	16	0
23	5561	14.3	295	12	1
24	5513	12.5	300	12	1
25	5571	12.5	322	14	1
26	5538	12.5	383	13	0
27	5573	15.7	322	16	1
28	5548	19.8	469	13	0
29	5610	18.6	406	15	1
30	5512	15.9	238	14	1
Detection Percentage (%)					70.000
Limit					60%
Test Result					Complied



3 Test Equipment and Calibration Data

Instrument	Brand	Model No.	Serial No.	Characteristics	Calibration Date	Calibration Due Date	Remark
Spectrum Analyzer	R&S	FSV40	101026	9kHz~40GHz	Dec. 01, 2020	Nov. 30, 2021	Radiated (DF01-CB)
ESG Signal generator	Agilent	E4438C	MY49072778	250kHz-6GHz	Aug. 24, 2020	Aug. 23, 2021	Radiated (DF01-CB)
Horn Antenna	COM-POWER	AH-118	071187	1GHz ~ 18GHz	Jul. 08, 2020	Jul. 07, 2021	Radiated (DF01-CB)
Horn Antenna	COM-POWER	AH-118	071042	1GHz ~ 18GHz	Dec. 22, 2020	Dec. 21, 2021	Radiated (DF01-CB)
RF Power Divider	MTJ	2 Way	DFS-01-DV-02	1GHz ~ 6GHz	Oct. 05, 2020	Oct. 04, 2021	Radiated (DF01-CB)
RF Power Divider	MTJ	2 Way	DFS-01-DV-03	1GHz ~ 6GHz	Oct. 05, 2020	Oct. 04, 2021	Radiated (DF01-CB)
RF Power Divider	MTJ	4 Way	DFS-01-DV-01	1GHz ~ 6GHz	Oct. 05, 2020	Oct. 04, 2021	Radiated (DF01-CB)
RF Cable-high	Woken	RG402	High Cable-57	1 GHz ~18 GHz	Oct. 05, 2020	Oct. 04, 2021	Radiated (DF01-CB)
RF Cable-high	Woken	RG402	High Cable-58	1 GHz ~18 GHz	Oct. 05, 2020	Oct. 04, 2021	Radiated (DF01-CB)
RF Cable-high	Woken	RG402	High Cable-59	1 GHz ~18 GHz	Oct. 05, 2020	Oct. 04, 2021	Radiated (DF01-CB)

Note: Calibration Interval of instruments listed above is one year.



4 Measurement Uncertainty

Test Items	Uncertainty	Remark
Radiated Emission	3.4 dB	Confidence levels of 95%