

## FCC RF Test Report (WLAN 5GHz)

**Report No.:** RF170526E11C-1

**FCC ID:** RSE-OWA0130

**Equipment Name:** Technicolor Wi-Fi Video Bridge & Extender

**Trade Name:** technicolor

**Model Number:** OWA0130

**Received Date:** June 05, 2018

**Test Date:** June 18 to Aug. 15, 2018

**Issued Date:** Oct. 29, 2018

**Applicant:** Technicolor Delivery Technologies Belgium

**Address:** Prins Boudewijnlaan 47, 2650 Edegem Belgium

**Issued By:** Bureau Veritas Consumer Products Services (H.K.) Ltd., Taoyuan Branch  
Hsin Chu Laboratory

**Lab Address:** E-2, No.1, Li Hsin 1st Road, Hsinchu Science Park, Hsinchu City 300,  
Taiwan R.O.C.

**Test Location:** E-2, No.1, Li Hsin 1st Road, Hsinchu Science Park, Hsinchu City 300,  
Taiwan R.O.C.

**FCC Registration /  
Designation Number:** 723255 / TW2022



This report is for your exclusive use. Any copying or replication of this report to or for any other person or entity, or use of our name or trademark, is permitted only with our prior written permission. This report sets forth our findings solely with respect to the test samples identified herein. The results set forth in this report are not indicative or representative of the quality or characteristics of the lot from which a test sample was taken or any similar or identical product unless specifically and expressly noted. Our report includes all of the tests requested by you and the results thereof based upon the information that you provided to us. You have 60 days from date of issuance of this report to notify us of any material error or omission caused by our negligence, provided, however, that such notice shall be in writing and shall specifically address the issue you wish to raise. A failure to raise such issue within the prescribed time shall constitute your unqualified acceptance of the completeness of this report, the tests conducted and the correctness of the report contents. Unless specific mention, the uncertainty of measurement has been explicitly taken into account to declare the compliance or non-compliance to the specification. The report must not be used by the client to claim product certification, approval, or endorsement by TAF or any government agencies.

## Table of Contents

<b>Release Control Record</b> .....	<b>4</b>
<b>1 Certificate of Conformity</b> .....	<b>5</b>
<b>2 Summary of Test Results</b> .....	<b>6</b>
2.1 Measurement Uncertainty .....	9
2.2 Modification Record .....	9
<b>3 General Information</b> .....	<b>10</b>
3.1 Basic Description of Equipment Under Test (WLAN 5GHz) .....	10
3.2 Accessories .....	16
3.3 Feature of Equipment Under Test .....	16
3.4 Information Provided by the Manufacturer .....	16
3.5 General Description of Applied Standards .....	17
3.6 Cabling Attached to the Equipment .....	18
3.7 Panel Drawing .....	19
3.8 Transmit Operating Mode .....	20
3.9 Antenna Requirements .....	20
3.10 Antenna Information .....	21
3.11 Table for Carrier Frequency .....	23
3.12 Table for Test Modes .....	24
1.13 Parameters of Test Software Settings .....	27
1.14 On Time and Duty Cycle .....	30
1.15 Testing Location Information .....	34
1.16 EUT Diagram and Support Equipment .....	35
<b>4 Test Types and Results</b> .....	<b>37</b>
4.1 AC Power Conducted Emissions Measurement .....	37
4.1.1 Limit .....	37
4.1.2 Measuring Instruments and Setting .....	37
4.1.3 Test Procedures .....	37
4.1.4 Test Setup Layout .....	38
4.1.5 Test Deviation .....	38
4.1.6 EUT Operating during Test .....	39
4.1.7 Test Results of AC Power Conducted Emissions .....	39
4.2 Occupied Bandwidth and 26dB Bandwidth Measurement .....	41
4.2.1 Measuring Instruments and Setting .....	41
4.2.2 Test Procedure .....	41
4.2.3 Test Setup Layout .....	42
4.2.4 Test Deviation .....	42
4.2.5 EUT Operating Conditions .....	42
4.2.6 Test Results .....	43
4.3 Maximum Conducted Output Power Measurement .....	83
4.3.1 Limit .....	83
4.3.2 Measuring Instruments and Setting .....	83
4.3.3 Test Procedures .....	84
4.3.4 Test Setup Layout .....	85
4.3.5 Test Deviation .....	85
4.3.6 EUT Operating Conditions .....	85
4.3.7 Test Results of Maximum Conducted Output Power .....	86
4.4 Power Spectral Density Measurement .....	95
4.4.1 Limit .....	95
4.4.2 Measuring Instruments and Setting .....	95
4.4.3 Test Procedure .....	96
4.4.4 Test Setup Layout .....	96
4.4.5 Test Deviation .....	96
4.4.6 EUT Operating Conditions .....	96

4.4.7	Test Results .....	97
4.5	Radiated Emission and Bandedge Measurement.....	108
4.5.1	Limits of Unwanted emissions in the restricted bands .....	108
4.5.2	Limits of Unwanted emissions out of the restricted bands .....	109
4.5.3	Measuring Instruments and Setting.....	110
4.5.4	Test Procedures .....	111
4.5.5	Test Setup Layout .....	112
4.5.6	Test Deviation.....	113
4.5.7	EUT Operating Conditions.....	113
4.5.8	Test Results of Radiated Emissions and Bandedge .....	114
4.6	Frequency Stability Measurement.....	256
4.6.1	Limit .....	256
4.6.2	Measuring Instruments and Setting.....	256
4.6.3	Test Procedure .....	256
4.6.4	Test Setup Layout .....	257
4.6.5	Test Deviation.....	257
4.6.6	EUT Operating Conditions.....	257
4.6.7	Test Results.....	258
<b>5</b>	<b>Test Instruments .....</b>	<b>261</b>
	<b>Appendix D. Information on the Testing Laboratories .....</b>	<b>263</b>

### Release Control Record

Issue No.	Description	Date Issued
RF170526E11C-1	Original release.	Oct. 29, 2018

## 1 Certificate of Conformity

**Equipment Name:** Technicolor Wi-Fi Video Bridge & Extender  
**Trade Name:** technicolor  
**Test Model:** OWA0130  
**Sample Status:** Product Unit  
**Applicant:** Technicolor Delivery Technologies Belgium  
**Test Date:** June 18 to Aug. 15, 2018  
**Standards:** 47 CFR FCC Part 15, Subpart E (Section 15.407)  
ANSI C63.10: 2013

The above equipment has been tested by **Bureau Veritas Consumer Products Services (H.K.) Ltd., Taoyuan Branch**, and found compliance with the requirement of the above standards. The test record, data evaluation & Equipment Under Test (EUT) configurations represented herein are true and accurate accounts of the measurements of the sample's RF characteristics under the conditions specified in this report.

**Prepared by :** Wendy Wu , **Date:** Oct. 29, 2018  
Wendy Wu / Specialist

**Approved by :** May Chen , **Date:** Oct. 29, 2018  
May Chen / Manager

## 2 Summary of Test Results

Applied Standard: 47 CFR FCC Part 15 Subpart E					
Report Clause	Ref. Std. Clause	Description	Measured	Limit	Result
3.9	15.203	Antenna Requirements	-	-	PASS
4.1	15.407(b)(6)	AC Power Conducted Emissions	Margin is -11.93dB at 0.15781MHz.	-	PASS
4.2	-	99% Occupied Bandwidth & 26dB Bandwidth	99% Occupied Bandwidth <b>5250-5350MHz:</b> 1S4T CDD 11a: 18.70 MHz 11ac (20M):19.91 MHz 11ac (40M):37.20 MHz 11ac (80M):75.48 MHz 1S4T TxBF 11ac (20M):19.80 MHz 11ac (40M):37.20 MHz 11ac (80M):75.48 MHz  <b>5470-5725MHz:</b> 1S4T CDD 11a: 18.84 MHz 11ac (20M):19.92 MHz 11ac (40M):37.20 MHz 11ac (80M):75.36 MHz 1S4T TxBF 11ac (20M):19.92 MHz 11ac (40M):37.20 MHz 11ac (80M):75.36 MHz  26dB Bandwidth <b>5250-5350MHz:</b> 1S4T CDD 11a: 23.64 MHz 11ac (20M):25.11 MHz 11ac (40M):44.66 MHz 11ac (80M):83.97 MHz 1S4T TxBF 11ac (20M):25.44 MHz 11ac (40M):44.47 MHz 11ac (80M):83.71 MHz  <b>5470-5725MHz:</b> 1S4T CDD 11a: 23.80 MHz 11ac (20M):25.25 MHz 11ac (40M):44.59 MHz 11ac (80M):84.08 MHz 1S4T TxBF 11ac (20M):25.38 MHz 11ac (40M):44.79 MHz 11ac (80M):83.63 MHz	-	-

## Applied Standard: 47 CFR FCC Part 15 Subpart E

Report Clause	Ref. Std. Clause	Description	Measured	Limit	Result
4.3	15.407 (a)(1/2/3)	Maximum Conducted Output Power	<b>5250-5350MHz:</b> <b>11a:</b> 1S4T CDD: 21.16 dBm <b>11ac (20M):</b> 1S4T CDD: 21.09 dBm 2S4T CDD: 21.05 dBm 4S4T SDM: 20.99 dBm 1S4T TxBF: 21.34 dBm 2S4T TxBF: 21.30 dBm 3S4T TxBF: 21.27 dBm <b>11ac (40M):</b> 1S4T CDD: 21.34 dBm 2S4T CDD: 21.31 dBm 4S4T SDM: 21.20 dBm 1S4T TxBF: 21.42 dBm 2S4T TxBF: 21.38 dBm 3S4T TxBF: 21.33 dBm <b>11ac (80M):</b> 1S4T CDD: 18.34 dBm 2S4T CDD: 18.29 dBm 4S4T SDM: 18.19 dBm 1S4T TxBF: 18.25 dBm 2S4T TxBF: 18.19 dBm 3S4T TxBF: 18.15 dBm <b>5470-5725MHz:</b> <b>11a:</b> 1S4T CDD: 21.51 dBm <b>11ac (20M):</b> 1S4T CDD: 21.52 dBm 2S4T CDD: 21.50 dBm 4S4T SDM: 21.45 dBm 1S4T TxBF: 21.76 dBm 2S4T TxBF: 21.71 dBm 3S4T TxBF: 21.67 dBm <b>11ac (40M):</b> 1S4T CDD: 22.63 dBm 2S4T CDD: 22.60 dBm 4S4T SDM: 22.51 dBm 1S4T TxBF: 22.59 dBm 2S4T TxBF: 22.55 dBm 3S4T TxBF: 22.49 dBm <b>11ac (80M):</b> 1S4T CDD: 19.16 dBm 2S4T CDD: 19.10 dBm 4S4T SDM: 19.01 dBm 1S4T TxBF: 18.06 dBm 2S4T TxBF: 18.00 dBm 3S4T TxBF: 17.96 dBm	Power [dBm] 5250-5350MHz:24 5470-5725MHz:24	PASS

## Applied Standard: 47 CFR FCC Part 15 Subpart E

Report Clause	Ref. Std. Clause	Description	Measured	Limit	Result
4.4	15.407 (a)(1/2/3)	Power Spectral Density	<b>5250-5350MHz:</b> [dBm/MHz] <b>11a:</b> 1S4T CDD: 9.09 <b>11ac (20M):</b> 1S4T CDD: 8.62 1S4T TxBF: 8.65 <b>11ac (40M):</b> 1S4T CDD: 5.73 1S4T TxBF: 5.73 <b>11ac (80M):</b> 1S4T CDD: 0.13 1S4T TxBF: 0.08  <b>5470-5725MHz:</b> [dBm/500kHz] <b>11a:</b> 1S4T CDD: 8.85 <b>11ac (20M):</b> 1S4T CDD: 8.51 1S4T TxBF: 8.11 <b>11ac (40M):</b> 1S4T CDD: 6.34 1S4T TxBF: 6.37 <b>11ac (80M):</b> 1S4T CDD: 0.37 1S4T TxBF: -0.52	5250-5350MHz: 11 [dBm/MHz] 5470-5725MHz: 11 [dBm/MHz]	PASS
4.5	15.407 (b)(1/2/3/4/6)	Radiated Emissions	Margin is -3.2dB at 625.02MHz, 250.00MHz.	-	PASS
		Band Edge	Margin is -5.6dB at 5725.00MHz	-	PASS
4.6	15.407(g)	Frequency Stability	-	Signal shall remain in-band	PASS



## 2.1 Measurement Uncertainty

Where relevant, the following measurement uncertainty levels have been estimated for tests performed on the EUT as specified in CISPR 16-4-2:

Measurement	Frequency	Expanded Uncertainty (k=2) ( $\pm$ )
Conducted Emissions at mains ports	150kHz ~ 30MHz	1.84 dB
Radiated Emissions up to 1 GHz	30MHz ~ 1GHz	5.53 dB
Radiated Emissions above 1 GHz	1GHz ~ 6GHz	5.08 dB
	6GHz ~ 18GHz	4.98 dB
	18GHz ~ 40GHz	5.19 dB

## 2.2 Modification Record

There were no modifications required for compliance.

### 3 General Information

#### 3.1 Basic Description of Equipment Under Test (WLAN 5GHz)

Items	Description		
Equipment Name	Technicolor Wi-Fi Video Bridge & Extender		
Trade Name	technicolor		
Model Number	OWA0130		
FCC ID	RSE-OWA0130		
Power Type	From power adapter		
Antenna	Refer section 3.10		
EUT Stage	<input checked="" type="checkbox"/> Product Unit	<input type="checkbox"/> Pre-Sample	
Operating Band and Conducted Output Power	<b>U-NII-1</b> 5150~5250MHz	<input type="checkbox"/> IEEE 802.11a:	
		<input type="checkbox"/> IEEE 802.11ac (20MHz):	
		<input type="checkbox"/> IEEE 802.11ac (40MHz):	
		<input type="checkbox"/> IEEE 802.11ac (80MHz):	
	<b>U-NII-2A</b> 5250~5350MHz	<input checked="" type="checkbox"/> IEEE 802.11a: 1S4T CDD Mode: 21.16 dBm	
		<input checked="" type="checkbox"/> IEEE 802.11ac (20MHz): 1S4T CDD Mode: 21.09 dBm 2S4T CDD Mode: 21.05 dBm 4S4T SDM Mode: 20.99 dBm 1S4T TxBF Mode: 21.34 dBm 2S4T TxBF Mode: 21.30 dBm 3S4T TxBF Mode: 21.27 dBm	
		<input checked="" type="checkbox"/> IEEE 802.11ac (40MHz): 1S4T CDD Mode: 21.34 dBm 2S4T CDD Mode: 21.31 dBm 4S4T SDM Mode: 21.20 dBm 1S4T TxBF Mode: 21.42 dBm 2S4T TxBF Mode: 21.38 dBm 3S4T TxBF Mode: 21.33 dBm	
		<input checked="" type="checkbox"/> IEEE 802.11ac (80MHz): 1S4T CDD Mode: 18.34 dBm 2S4T CDD Mode: 18.29 dBm 4S4T SDM Mode: 18.19 dBm 1S4T TxBF Mode: 18.25 dBm 2S4T TxBF Mode: 18.19 dBm 3S4T TxBF Mode: 18.15 dBm	

Operating Band and Conducted Output Power	<b>U-NII-2C</b> 5470~ 5725 MHz	<input checked="" type="checkbox"/>	IEEE 802.11a: 1S4T CDD Mode: 21.51 dBm
		<input checked="" type="checkbox"/>	IEEE 802.11ac (20MHz): 1S4T CDD Mode: 21.52 dBm 2S4T CDD Mode: 21.50 dBm 4S4T SDM Mode: 21.45 dBm 1S4T TxBF Mode: 21.76 dBm 2S4T TxBF Mode: 21.71 dBm 3S4T TxBF Mode: 21.67 dBm
		<input checked="" type="checkbox"/>	IEEE 802.11ac (40MHz): 1S4T CDD Mode: 22.63 dBm 2S4T CDD Mode: 22.60 dBm 4S4T SDM Mode: 22.51 dBm 1S4T TxBF Mode: 22.59 dBm 2S4T TxBF Mode: 22.55 dBm 3S4T TxBF Mode: 22.49 dBm
		<input checked="" type="checkbox"/>	IEEE 802.11ac (80MHz): 1S4T CDD Mode: 19.16 dBm 2S4T CDD Mode: 19.10 dBm 4S4T SDM Mode: 19.01 dBm 1S4T TxBF Mode: 18.06 dBm 2S4T TxBF Mode: 18.00 dBm 3S4T TxBF Mode: 17.96 dBm
	<b>U-NII-3</b> 5725~ 5850 MHz	<input type="checkbox"/>	IEEE 802.11a:
		<input type="checkbox"/>	IEEE 802.11ac (20MHz):
		<input type="checkbox"/>	IEEE 802.11ac (40MHz):
		<input type="checkbox"/>	IEEE 802.11ac (80MHz):
Product Type	For IEEE 802.11a: WLAN (4TX, 4RX) For IEEE 802.11n: WLAN (4TX, 4RX) For IEEE 802.11ac: WLAN (4TX, 4RX)		
Nominal Bandwidth	20MHz / 40MHz / 80MHz		
Modulation	802.11a: OFDM (BPSK / QPSK / 16QAM / 64QAM) 802.11n: (BPSK / QPSK / 16QAM / 64QAM) See the below table 802.11ac: (BPSK / QPSK / 16QAM / 64QAM/ 256QAM) See the below table		
Data Rate (Mbps)	11a mode OFDM (6/9/12/18/24/36/48/54) 11n(20MHz) mode (MCS0~MCS31) 11n(40MHz) mode (MCS0~MCS31) 11ac(20MHz) mode (MCS0~MCS9 for NSS1~NSS4) 11ac(40MHz) mode (MCS0~MCS9 for NSS1~NSS4) 11ac(80MHz) mode (MCS0~MCS9 for NSS1~NSS4)		
TPC Function	<input checked="" type="checkbox"/>	With TPC	<input type="checkbox"/> Without TPC
Beam forming Function	<input checked="" type="checkbox"/>	With Beam forming	<input type="checkbox"/> Without Beam forming
DFS Operating Mode(s)	<input checked="" type="checkbox"/>	Master	<input checked="" type="checkbox"/> Slave without radar detection
DFS Function	<input checked="" type="checkbox"/>	5250~5350MHz	
	<input checked="" type="checkbox"/>	5470~5725MHz	
	<input type="checkbox"/>	5600~5650MHz	
Off Channel CAC Feature Implemented	<input checked="" type="checkbox"/>	No	
Ad-hoc/Hotspot Mode	<input checked="" type="checkbox"/>	No Ad-hoc/Hotspot operation in 5150 - 5350 MHz and 5470 - 5725 MHz.	
User Access Restrictions	<input checked="" type="checkbox"/>	DFS controls (hardware or software) related to radar detection are	

	NOT accessible to the user.
I/O Ports	LAN Port x 2 DC JACK x 1
Hardware Version	80-999-440422B
Software Version	10.6.0.8

## 802.11n Data Rate spec

Standard	INDEX	Data Rate (Mbps)		Standard	INDEX	Data Rate (Mbps)	
		LGI (800ns)	SGL (400ns)			LGI (800ns)	SGL (400ns)
11n 20MHz Nss=1	MCS0	6.5	7.2	11n 40MHz Nss=1	MCS0	13.5	15
	MCS1	13	14.4		MCS1	27	30
	MCS2	19.5	21.7		MCS2	40.5	45
	MCS3	26	28.9		MCS3	54	60
	MCS4	39	43.3		MCS4	81	90
	MCS5	52	57.8		MCS5	108	120
	MCS6	58.5	65		MCS6	121.5	135
	MCS7	65	72.2		MCS7	135	150
11n 20MHz Nss=2	MCS8	13	14.4	11n 40MHz Nss=2	MCS8	27	30
	MCS9	26	28.9		MCS9	54	60
	MCS10	39	43.3		MCS10	81	90
	MCS11	52	57.8		MCS11	108	120
	MCS12	78	86.7		MCS12	162	180
	MCS13	104	115.6		MCS13	216	240
	MCS14	117	130		MCS14	243	270
	MCS15	130	144.4		MCS15	270	300
11n 20MHz Nss=3	MCS16	19.5	21.7	11n 40MHz Nss=3	MCS16	40.5	45
	MCS17	39	43.3		MCS17	81	90
	MCS18	58.5	65		MCS18	121.5	135
	MCS19	78	86.7		MCS19	162	180
	MCS20	117	130		MCS20	243	270
	MCS21	156	173.3		MCS21	324	360
	MCS22	175.5	195		MCS22	364.5	405
	MCS23	195	216.7		MCS23	405	450
11n 20MHz Nss=4	MCS24	26	28.9	11n 40MHz Nss=4	MCS24	54	60
	MCS25	52	57.8		MCS25	108	120
	MCS26	78	86.7		MCS26	162	180
	MCS27	104	115.6		MCS27	216	240
	MCS28	156	173.3		MCS28	324	260
	MCS29	208	231.1		MCS29	432	480
	MCS30	234	260		MCS30	486	540
	MCS31	260	288.9		MCS31	540	600

802.11ac Data Rate spec

Standard	INDEX	Data Rate (Mbps)		Standard	INDEX	Data Rate (Mbps)		Standard	INDEX	Data Rate (Mbps)	
		LGI (800ns)	SGI (400ns)			LGI (800ns)	SGI (400ns)			LGI (800ns)	SGI (400ns)
11ac 20MHz NSS = 1	MCS0	6.5	7.2	11ac 40MHz NSS = 1	MCS0	13.5	15.0	11ac 80MHz NSS = 1	MCS0	29.3	32.5
	MCS1	13.0	14.4		MCS1	27	30.0		MCS1	58.5	65.0
	MCS2	19.5	21.7		MCS2	40.5	45.0		MCS2	87.8	97.5
	MCS3	26	28.9		MCS3	54	60.0		MCS3	117.0	130.0
	MCS4	39	43.3		MCS4	81	90.0		MCS4	175.5	195.0
	MCS5	52	57.8		MCS5	108	120.0		MCS5	234.0	260.0
	MCS6	58.5	65		MCS6	121.5	135.0		MCS6	263.3	292.5
	MCS7	65	72.2		MCS7	135.0	150.0		MCS7	292.5	325.0
	MCS8	78	86.7		MCS8	162.0	180.0		MCS8	351.0	390.0
	MCS9	Note	Note		MCS9	180.0	200.0		MCS9	390.0	433.3

NOTE: MCS 9 is invalid due to mod(NCBPS/NES, DR) not being equal to 0.

Standard	INDEX	Data Rate (Mbps)		Standard	INDEX	Data Rate (Mbps)		Standard	INDEX	Data Rate (Mbps)	
		LGI (800ns)	SGI (400ns)			LGI (800ns)	SGI (400ns)			LGI (800ns)	SGI (400ns)
11ac 20MHz NSS = 2	MCS0	13.0	14.4	11ac 40MHz NSS = 2	MCS0	27.0	30.0	11ac 80MHz NSS = 2	MCS0	58.5	65.0
	MCS1	26.0	28.9		MCS1	54.0	60.0		MCS1	117.0	130.0
	MCS2	39.0	43.3		MCS2	81.0	90.0		MCS2	175.5	195.0
	MCS3	52.0	57.8		MCS3	108.0	120.0		MCS3	234.0	260.0
	MCS4	78.0	86.7		MCS4	162.0	180.0		MCS4	351.0	390.0
	MCS5	104.0	115.6		MCS5	216.0	240.0		MCS5	468.0	520.0
	MCS6	117.0	130.0		MCS6	243.0	270.0		MCS6	526.5	585.0
	MCS7	130.0	144.4		MCS7	270.0	300.0		MCS7	585.0	650.0
	MCS8	156.0	173.3		MCS8	324.0	360.0		MCS8	702.0	780.0
	MCS9	13.0	14.4		MCS9	360.0	400.0		MCS9	780.0	866.7

Standard	INDEX	Data Rate (Mbps)		Standard	INDEX	Data Rate (Mbps)		Standard	INDEX	Data Rate (Mbps)	
		LGI (800ns)	SGI (400ns)			LGI (800ns)	SGI (400ns)			LGI (800ns)	SGI (400ns)
11ac 20MHz NSS = 3	MCS0	19.5	21.7	11ac 40MHz NSS = 3	MCS0	40.5	45.0	11ac 80MHz NSS = 3	MCS0	87.8	97.5
	MCS1	39.0	43.3		MCS1	81.0	90.0		MCS1	175.5	195.0
	MCS2	58.5	65.0		MCS2	121.5	135.0		MCS2	263.3	292.5
	MCS3	78.0	86.7		MCS3	162.0	180.0		MCS3	351.0	190.0
	MCS4	117.0	130		MCS4	243.0	270.0		MCS4	526.5	585.0
	MCS5	156.0	173.3		MCS5	324.0	360.0		MCS5	702.0	780.0
	MCS6	175.5	195.0		MCS6	364.5	405.0		MCS6	Note	Note
	MCS7	195.0	216.7		MCS7	405.0	450.0		MCS7	877.5	975.0
	MCS8	234.0	260.0		MCS8	486.0	540.0		MCS8	1053.0	1170.0
	MCS9	260.0	228.9		MCS9	540.0	600.0		MCS9	1170.0	1300.0

NOTE: MCS 6 is invalid due to mod(NCBPS/NES, DR) not being equal to 0.

Standard	INDEX	Data Rate (Mbps)		Standard	INDEX	Data Rate (Mbps)		Standard	INDEX	Data Rate (Mbps)	
		LGI (800ns)	SGI (400ns)			LGI (800ns)	SGI (400ns)			LGI (800ns)	SGI (400ns)
11ac 20MHz NSS = 4	MCS0	26.0	28.9	11ac 40MHz NSS = 4	MCS0	54.0	60.0	11ac 80MHz NSS = 4	MCS0	117.0	130.0
	MCS1	52.0	57.8		MCS1	108.0	120.0		MCS1	234.0	260.0
	MCS2	78.0	86.7		MCS2	162.0	180.0		MCS2	351.0	390.0
	MCS3	104.0	115.6		MCS3	216.0	240.0		MCS3	468.0	520.0
	MCS4	156.0	173.3		MCS4	324.0	360.0		MCS4	702.0	780.0
	MCS5	208.0	231.1		MCS5	432.0	480.0		MCS5	936.0	1040.0
	MCS6	234.0	260.0		MCS6	486.0	540.0		MCS6	1053.0	1170.0
	MCS7	260.0	288.9		MCS7	540.0	600.0		MCS7	1170.0	1300.0
	MCS8	312.0	346.7		MCS8	648.0	720.0		MCS8	1404.0	1560.0
	MCS9	Note	Note		MCS9	720.0	800.0		MCS9	1560.0	1733.3

**NOTE:** MCS 9 is invalid due to mod(NCBPS/NES, DR) not being equal to 0.

### 3.2 Accessories

#### Power supply:

Power Adaptor	
Brand	AcBel
Model	WAG027
P/N	DSL37647540
Input Power	100-240Vac, 50/60Hz, 0.6A max
Output Power	12Vdc, 1.5A
Cable Length	1.5m

### 3.3 Feature of Equipment Under Test

Please refer to user manual.

### 3.4 Information Provided by the Manufacturer

Interface Availability

Interface Model	DC Power	Ethernet LAN 1000Mbps	WLAN IEEE 802.11n (2.4GHz)	WLAN IEEE 802.11n/ac (5GHz)
OWA0130	●(1.5A)	●(2 port)	●	●

●: Equipped

○: Not Equipped



### 3.5 General Description of Applied Standards

The EUT is a RF Product. According to the specifications of the manufacturer, it must comply with the requirements of the following standards:

**FCC Part 15, Subpart E (15.407)**

**KDB 789033 D02 General UNII Test Procedure New Rules v02r01, 12/14/2017**

**KDB 662911 D01 Multiple Transmitter Output v02r01, 10/31/2013**

**ANSI C63.10-2013**

All test items have been performed and recorded as per the above standards.

### 3.6 Cabling Attached to the Equipment

#### Cable and Interconnection

Interface	Cable type	Cable length delivered with the modem	"Real life" Cable length that can be attached to this type of interface	Cable length to be used for testing	Internal/ external connection
Ethernet	UTP Cat 5	2 meter	> 10 meter	one 10 meter cables;	Internal
AC power		1.5 meter			External

### 3.7 Panel Drawing



Label of Power adapter



### 3.8 Transmit Operating Mode

For 5250~5350MHz & 5470~5725MHz

Transmit Operating Mode						Transmit Multiple Antennas					
<input type="checkbox"/>	Operating mode 1 (single antenna)					<input type="checkbox"/>	1TX				
<input checked="" type="checkbox"/>	Operating mode 2 (multiple antenna, no beam forming)					<input type="checkbox"/>	2TX	<input type="checkbox"/>	3TX	<input checked="" type="checkbox"/>	4TX
<input checked="" type="checkbox"/>	Operating mode 3 (multiple antenna, with beam forming)					<input type="checkbox"/>	2TX	<input type="checkbox"/>	3TX	<input checked="" type="checkbox"/>	4TX
<input checked="" type="checkbox"/>	802.11a	Operating mode	<input type="checkbox"/>	1T	<input type="checkbox"/>	2T	<input type="checkbox"/>	3TX	<input checked="" type="checkbox"/>	4TX	
<input checked="" type="checkbox"/>	802.11n (20MHz)	Operating mode	<input type="checkbox"/>	1T	<input type="checkbox"/>	2T	<input type="checkbox"/>	3TX	<input checked="" type="checkbox"/>	4TX	
<input checked="" type="checkbox"/>	802.11n (40MHz)	Operating mode	<input type="checkbox"/>	1T	<input type="checkbox"/>	2T	<input type="checkbox"/>	3TX	<input checked="" type="checkbox"/>	4TX	
<input checked="" type="checkbox"/>	802.11ac (20MHz)	Operating mode	<input type="checkbox"/>	1T	<input type="checkbox"/>	2T	<input type="checkbox"/>	3TX	<input checked="" type="checkbox"/>	4TX	
<input checked="" type="checkbox"/>	802.11ac (40MHz)	Operating mode	<input type="checkbox"/>	1T	<input type="checkbox"/>	2T	<input type="checkbox"/>	3TX	<input checked="" type="checkbox"/>	4TX	
<input checked="" type="checkbox"/>	802.11ac (80MHz)	Operating mode	<input type="checkbox"/>	1T	<input type="checkbox"/>	2T	<input type="checkbox"/>	3TX	<input checked="" type="checkbox"/>	4TX	

Note:

For IEEE802.11a, 6Mbps~54Mbps: 4TX

For IEEE802.11n 20/40MHz, MCS0~MCS7: 1 Stream 4TX; MCS8~MCS15: 2 Stream 4TX;

MCS16~MCS23: 3 Stream 4TX; MCS24~MCS31: 4 Stream 4TX;

For IEEE802.11ac 20MHz and IEEE802.11ac 40/80MHz, Nss1MCS0~Nss1MCS8: 1 Stream 4TX;

Nss2MCS0~Nss2MCS9: 2 Stream 4TX. Nss3MCS0~Nss3MCS9: 3 Stream 4TX, 3 Stream 4TX;

Nss4MCS0~Nss4MCS9: 4 Stream 4TX

### 3.9 Antenna Requirements

Except for special regulations, the Low-power Radio-frequency Devices must not be equipped with any jacket for installing an antenna with extension cable. An intentional radiator shall be designed to ensure that no antenna other than that furnished by the responsible party shall be used with the device. The use of a permanently attached antenna or of an antenna that uses a unique coupling to the intentional radiator shall be considered sufficient to comply with the provisions of this Section. The manufacturer may design the unit so that the user can replace a broken antenna, but the use of a standard antenna jack or electrical connector is prohibited. Further, this requirement does not apply to intentional radiators that must be professionally installed.

### 3.10 Antenna Information

Ant.	Brand	Model Name	Antenna Type	Connector	Cable Length
1	technicolor	--	Printed Antenna	Murata	--
2	technicolor	--	Printed Antenna	Murata	--
3	technicolor	--	Printed Antenna	I-pex	340mm
4	technicolor	--	Printed Antenna	I-pex	150mm



Antenna & Bandwidth

Antenna	1st (TX)			2nd (TX)			3rd (TX)			4th (TX)		
	20 MHz	40 MHz	80 MHz	20 MHz	40 MHz	80 MHz	20 MHz	40 MHz	80 MHz	20 MHz	40 MHz	80 MHz
802.11a	V	X	X	V	X	X	V	X	X	V	X	X
802.11n	V	V	X	V	V	X	V	V	X	V	V	X
802.11ac	V	V	V	V	V	V	V	V	V	V	V	V

Frequency	Antenna Gain (dBi) for CDD/TxBF/SDM mode											
	1 Stream 4 TX for CDD/TxBF mode			2 Stream 4 TX for CDD/TxBF mode			3 Stream 4 TX for TxBF mode			4 Stream 4 TX for SDM mode		
	20 MHz	40 MHz	80 MHz	20 MHz	40 MHz	80 MHz	20 MHz	40 MHz	80 MHz	20 MHz	40 MHz	80 MHz
5180MHz	7.01	-	-	4.04	-	-	2.32	-	-	1.07	-	-
5190MHz	-	7.25	-	-	4.35	-	-	2.64	-	-	1.39	-
5200MHz	6.49	-	-	3.61	-	-	1.92	-	-	0.67	-	-
5210MHz	-	-	6.74	-	-	3.86	-	-	2.16	-	-	0.92
5230MHz	-	7.29	-	-	4.42	-	-	2.71	-	-	1.46	-
5240MHz	6.65	-	-	3.83	-	-	2.23	-	-	1	-	-
5260MHz	6.81	-	-	3.88	-	-	2.2	-	-	0.95	-	-
5270MHz	-	7.89	-	-	5	-	-	3.33	-	-	2.09	-
5290MHz	-	-	7.31	-	-	4.4	-	-	2.72	-	-	1.47
5300MHz	7.75	-	-	4.83	-	-	3.15	-	-	1.9	-	-
5310MHz	-	7.32	-	-	4.47	-	-	2.76	-	-	1.52	-
5320MHz	6.85	-	-	3.94	-	-	2.23	-	-	0.99	-	-
5500MHz	6.74	-	-	4.03	-	-	2.28	-	-	1.03	-	-
5510MHz	-	6.74	-	-	3.99	-	-	2.25	-	-	1.01	-
5530MHz	-	-	6.99	-	-	4.03	-	-	2.29	-	-	1.05
5550MHz	-	7.07	-	-	4.11	-	-	2.35	-	-	1.1	-
5580MHz	8.04	-	-	5.27	-	-	3.54	-	-	2.29	-	-
5670MHz	-	6.49	-	-	3.59	-	-	2.63	-	-	0.72	-
5700MHz	6.87	-	-	4.05	-	-	2.32	-	-	1.07	-	-
5745MHz	7.06	-	-	4.17	-	-	2.5	-	-	1.25	-	-
5755MHz	-	7.87	-	-	5.06	-	-	3.31	-	-	2.06	-
5775MHz	-	-	7.36	-	-	4.48	-	-	3.31	-	-	2.06
5785MHz	6.83	-	-	4.02	-	-	2.29	-	-	1.05	-	-
5795MHz	-	6.43	-	-	3.6	-	-	1.86	-	-	0.61	-
5825MHz	6.45	-	-	3.62	-	-	1.92	-	-	0.7	-	-

Note:

1. Antenna Gain refer to "OWA0130 with shielding antenna table\_20161012.xls" files
2. Maximum Correlated Directional Gain =  $10 \log[(10^{G1/20} + 10^{G2/20} + \dots + 10^{GN/20})^2 / N_{ANT}]$  dBi
3. Maximum Uncorrelated Directional Gain =  $10 \log[(10^{G1/10} + 10^{G2/10} + \dots + 10^{GN/10}) / N_{ANT}]$  dBi

### 3.11 Table for Carrier Frequency

12 channels are provided for 802.11a/ 802.11n (20MHz) / 802.11ac (20MHz):

Frequency Band	Channel No.	Frequency	Channel No.	Frequency
5250~5350 MHz U-NII-2A	52	5260 MHz	60	5300 MHz
	56	5280 MHz	64	5320 MHz
5470~5725 MHz U-NII-2C	100	5500 MHz	116	5580 MHz
	104	5520 MHz	132	5660 MHz
	108	5540 MHz	136	5680 MHz
	112	5560 MHz	140	5700 MHz

5 channels are provided for 802.11n (40MHz) / 802.11ac (40MHz):

Frequency Band	Channel No.	Frequency	Channel No.	Frequency
5250~5350 MHz U-NII-2A	54	5270 MHz	62	5310 MHz
5470~5725 MHz U-NII-2C	102	5510 MHz	134	5670 MHz
	110	5550 MHz	-	-

2 channels are provided for 802.11ac (80MHz):

Frequency Band	Channel No.	Frequency	Channel No.	Frequency
5250~5350 MHz U-NII-2A	58	5290 MHz	-	-
5470~5725 MHz U-NII-2C	106	5530 MHz	-	-

### 3.12 Table for Test Modes

Investigation has been done on all the possible configurations for searching the worst cases. The following table is a list of the test modes shown in this test report.

Test Items	Mode	Note	Channel	Data Rate	Antenna
AC Power Conducted Emissions	11ac(80MHz)	OFDM/BPSK	106	-	1+2+3+4
Emission Bandwidth	11a	OFDM/BPSK	52/60/64 100/116/140	6Mbps (CDD)	1+2+3+4
	11ac(20MHz)		52/60/64 100/116/140	Nss1 MCS0 (1S4T CDD)	1+2+3+4
				Nss1 MCS0 (1S4T TxBF)	1+2+3+4
	11ac(40MHz)		54/62 102/110/134	Nss1 MCS0 (1S4T CDD)	1+2+3+4
				Nss1 MCS0 (1S4T TxBF)	1+2+3+4
	11ac(80MHz)		58 106	Nss1 MCS0 (1S4T CDD)	1+2+3+4
				Nss1 MCS0 (1S4T TxBF)	1+2+3+4
	Power Spectral Density		11a	OFDM/BPSK	52/60/64 100/116/140
11ac(20MHz)		52/60/64 100/116/140	Nss1 MCS0 (1S4T CDD)		1+2+3+4
			Nss1 MCS0 (1S4T TxBF)		1+2+3+4
11ac(40MHz)		54/62 102/110/134	Nss1 MCS0 (1S4T CDD)		1+2+3+4
			Nss1 MCS0 (1S4T TxBF)		1+2+3+4
11ac(80MHz)		58 106	Nss1 MCS0 (1S4T CDD)		1+2+3+4
			Nss1 MCS0 (1S4T TxBF)		1+2+3+4



Test Items	Mode	Note	Channel	Data Rate	Antenna
Maximum Output Power (Average) and Transmit Power Control (TPC)	11a	OFDM/BPSK	52/60/64 100/116/140	6Mbps (CDD)	1+2+3+4
	11ac(20MHz)		52/60/64 100/116/140	Nss1 MCS0 (1S4T CDD)	1+2+3+4
				Nss2 MCS0 (2S4T CDD)	1+2+3+4
				Nss4 MCS0 (4S4T SDM)	1+2+3+4
				Nss1 MCS0 (1S4T TxBF)	1+2+3+4
				Nss2 MCS0 (2S4T TxBF)	1+2+3+4
				Nss3 MCS0 (3S4T TxBF)	1+2+3+4
	11ac(40MHz)		54/62 102/110/134	Nss1 MCS0 (1S4T CDD)	1+2+3+4
				Nss2 MCS0 (2S4T CDD)	1+2+3+4
				Nss4 MCS0 (4S4T SDM)	1+2+3+4
				Nss1 MCS0 (1S4T TxBF)	1+2+3+4
				Nss2 MCS0 (2S4T TxBF)	1+2+3+4
				Nss3 MCS0 (3S4T TxBF)	1+2+3+4
	11ac(80MHz)		58 106	Nss1 MCS0 (1S4T CDD)	1+2+3+4
				Nss2 MCS0 (2S4T CDD)	1+2+3+4
				Nss4 MCS0 (4S4T SDM)	1+2+3+4
				Nss1 MCS0 (1S4T TxBF)	1+2+3+4
				Nss2 MCS0 (2S4T TxBF)	1+2+3+4
				Nss3 MCS0 (3S4T TxBF)	1+2+3+4

Test Items	Mode	Note	Channel	Data Rate	Antenna
Radiated Emission and Bandedge Measurement above 1GHz (Radiated)	11a	OFDM/BPSK	52/60/64 100/116/140	6Mbps (CDD)	1+2+3+4
	11ac(20MHz)		52/60/64 100/116/140	Nss1 MCS0 (1S4T CDD)	1+2+3+4
				Nss1 MCS0 (1S4T TxBF)	1+2+3+4
	11ac(40MHz)		54/62 102/110/134	Nss1 MCS0 (1S4T CDD)	1+2+3+4
				Nss1 MCS0 (1S4T TxBF)	1+2+3+4
	11ac(80MHz)		58 106	Nss1 MCS0 (1S4T CDD)	1+2+3+4
				Nss1 MCS0 (1S4T TxBF)	1+2+3+4
	Radiated Emissions Below 1GHz(Radiated)		11a	OFDM/BPSK	100
11ac(20MHz)		100	Nss1 MCS0 (1S4T CDD)		1+2+3+4
			Nss1 MCS0 (1S4T TxBF)		1+2+3+4
11ac(40MHz)		102	Nss1 MCS0 (1S4T CDD)		1+2+3+4
			Nss1 MCS0 (1S4T TxBF)		1+2+3+4
11ac(80MHz)		106	Nss1 MCS0 (1S4T CDD)		1+2+3+4
			Nss1 MCS0 (1S4T TxBF)		1+2+3+4
Frequency Stability		20MHz	Un-modulation		100
	40MHz	102		-	1+2+3+4
	80MHz	106		-	1+2+3+4

Note:

1. The device with multiple operating mode, measurements on the middle channel were tested to determine the worst case mode. (Each modulation family were tested in band edge, spurious emission and in band PSD after investigate worst case mode)

### 1.13 Parameters of Test Software Settings

During testing, Channel & Power Controlling Software provided by the customer was used to control the operating channel as well as the output power level. The RF output power selection is for the setting of RF output power expected by the customer and is going to be fixed on the firmware of the final end product.

The Power Setting Parameter					
Test Software Version	12.1.4.3.AA				
Worst Modulation Mode	Number of Transmit Chains (NTX)	Frequency (MHz)	Maximum Output Power(dBm)	Power Setting	Data Rate / MCS
802.11a (CDD)	1 stream 4TX	5260	21.16	Default(16)	6Mbps
802.11a (CDD)	1 stream 4TX	5300	21.07	Default(16)	6Mbps
802.11a (CDD)	1 stream 4TX	5320	21.08	Default(16)	6Mbps
802.11a (CDD)	1 stream 4TX	5500	21.51	Default(16)	6Mbps
802.11a (CDD)	1 stream 4TX	5580	21.45	Default(16)	6Mbps
802.11a (CDD)	1 stream 4TX	5700	21.34	Default(16)	6Mbps
802.11ac 20MHz (CDD)	1 stream 4TX	5260	21.09	Default(16)	Nss1MCS0 (6.5)
802.11ac 20MHz (CDD)	1 stream 4TX	5300	21.00	Default(16)	Nss1MCS0 (6.5)
802.11ac 20MHz (CDD)	1 stream 4TX	5320	20.99	Default(16)	Nss1MCS0 (6.5)
802.11ac 20MHz (CDD)	1 stream 4TX	5500	21.52	Default(16)	Nss1MCS0 (6.5)
802.11ac 20MHz (CDD)	1 stream 4TX	5580	21.35	Default(16)	Nss1MCS0 (6.5)
802.11ac 20MHz (CDD)	1 stream 4TX	5700	21.37	Default(16)	Nss1MCS0 (6.5)
802.11ac 20MHz (CDD)	2 stream 4TX	5260	21.05	Default(16)	Nss2MCS0 (13)
802.11ac 20MHz (CDD)	2 stream 4TX	5300	20.97	Default(16)	Nss2MCS0 (13)
802.11ac 20MHz (CDD)	2 stream 4TX	5320	20.96	Default(16)	Nss2MCS0 (13)
802.11ac 20MHz (CDD)	2 stream 4TX	5500	21.50	Default(16)	Nss2MCS0 (13)
802.11ac 20MHz (CDD)	2 stream 4TX	5580	21.43	Default(16)	Nss2MCS0 (13)
802.11ac 20MHz (CDD)	2 stream 4TX	5700	21.43	Default(16)	Nss2MCS0 (13)
802.11ac 20MHz (SDM)	4 stream 4TX	5260	20.99	Default(16)	Nss4MCS0 (26)
802.11ac 20MHz (SDM)	4 stream 4TX	5300	20.91	Default(16)	Nss4MCS0 (26)
802.11ac 20MHz (SDM)	4 stream 4TX	5320	20.91	Default(16)	Nss4MCS0 (26)
802.11ac 20MHz (SDM)	4 stream 4TX	5500	21.45	Default(16)	Nss4MCS0 (26)
802.11ac 20MHz (SDM)	4 stream 4TX	5580	21.36	Default(16)	Nss4MCS0 (26)
802.11ac 20MHz (SDM)	4 stream 4TX	5700	21.35	Default(16)	Nss4MCS0 (26)
802.11ac 20MHz (TxBF)	1 stream 4TX	5260	21.34	Default(16)	Nss1MCS0 (6.5)
802.11ac 20MHz (TxBF)	1 stream 4TX	5300	21.00	Default(16)	Nss1MCS0 (6.5)
802.11ac 20MHz (TxBF)	1 stream 4TX	5320	21.13	Default(16)	Nss1MCS0 (6.5)
802.11ac 20MHz (TxBF)	1 stream 4TX	5500	21.76	Default(16)	Nss1MCS0 (6.5)
802.11ac 20MHz (TxBF)	1 stream 4TX	5580	21.44	Default(16)	Nss1MCS0 (6.5)
802.11ac 20MHz (TxBF)	1 stream 4TX	5700	20.59	Default(15)	Nss1MCS0 (6.5)
802.11ac 20MHz (TxBF)	2 stream 4TX	5260	21.30	Default(16)	Nss2MCS0 (13)
802.11ac 20MHz (TxBF)	2 stream 4TX	5300	20.96	Default(16)	Nss2MCS0 (13)
802.11ac 20MHz (TxBF)	2 stream 4TX	5320	21.09	Default(16)	Nss2MCS0 (13)
802.11ac 20MHz (TxBF)	2 stream 4TX	5500	21.71	Default(16)	Nss2MCS0 (13)
802.11ac 20MHz (TxBF)	2 stream 4TX	5580	21.38	Default(16)	Nss2MCS0 (13)
802.11ac 20MHz (TxBF)	2 stream 4TX	5700	19.83	Default(15)	Nss2MCS0 (13)

Worst Modulation Mode	Number of Transmit Chains (NTX)	Frequency (MHz)	Maximum Output Power(dBm)	Power Setting	Data Rate / MCS
802.11ac 20MHz (TxBF)	3 stream 4TX	5260	21.27	Default(16)	Nss3MCS0 (40.5)
802.11ac 20MHz (TxBF)	3 stream 4TX	5300	20.92	Default(16)	Nss3MCS0 (40.5)
802.11ac 20MHz (TxBF)	3 stream 4TX	5320	21.04	Default(16)	Nss3MCS0 (40.5)
802.11ac 20MHz (TxBF)	3 stream 4TX	5500	21.67	Default(16)	Nss3MCS0 (40.5)
802.11ac 20MHz (TxBF)	3 stream 4TX	5580	21.34	Default(16)	Nss3MCS0 (40.5)
802.11ac 20MHz (TxBF)	3 stream 4TX	5700	19.76	Default(15)	Nss3MCS0 (40.5)
802.11ac 40MHz (CDD)	1 stream 4TX	5270	21.34	Default(16)	Nss1MCS0 (13.5)
802.11ac 40MHz (CDD)	1 stream 4TX	5310	19.45	Default(14)	Nss1MCS0 (13.5)
802.11ac 40MHz (CDD)	1 stream 4TX	5510	20.13	Default(14)	Nss1MCS0 (13.5)
802.11ac 40MHz (CDD)	1 stream 4TX	5550	22.42	Default(17)	Nss1MCS0 (13.5)
802.11ac 40MHz (CDD)	1 stream 4TX	5670	22.63	Default(17)	Nss1MCS0 (13.5)
802.11ac 40MHz (CDD)	2 stream 4TX	5270	21.31	Default(16)	Nss2MCS0 (27)
802.11ac 40MHz (CDD)	2 stream 4TX	5310	19.42	Default(14)	Nss2MCS0 (27)
802.11ac 40MHz (CDD)	2 stream 4TX	5510	20.10	Default(14)	Nss2MCS0 (27)
802.11ac 40MHz (CDD)	2 stream 4TX	5550	22.39	Default(17)	Nss2MCS0 (27)
802.11ac 40MHz (CDD)	2 stream 4TX	5670	22.60	Default(17)	Nss2MCS0 (27)
802.11ac 40MHz (SDM)	4 stream 4TX	5270	21.20	Default(16)	Nss4MCS0 (54)
802.11ac 40MHz (SDM)	4 stream 4TX	5310	19.31	Default(14)	Nss4MCS0 (54)
802.11ac 40MHz (SDM)	4 stream 4TX	5510	20.01	Default(14)	Nss4MCS0 (54)
802.11ac 40MHz (SDM)	4 stream 4TX	5550	22.29	Default(17)	Nss4MCS0 (54)
802.11ac 40MHz (SDM)	4 stream 4TX	5670	22.51	Default(17)	Nss4MCS0 (54)
802.11ac 40MHz (TxBF)	1 stream 4TX	5270	21.42	Default(16)	Nss1MCS0 (13.5)
802.11ac 40MHz (TxBF)	1 stream 4TX	5310	18.51	Default(13)	Nss1MCS0 (13.5)
802.11ac 40MHz (TxBF)	1 stream 4TX	5510	19.14	Default(13)	Nss1MCS0 (13.5)
802.11ac 40MHz (TxBF)	1 stream 4TX	5550	22.42	Default(17)	Nss1MCS0 (13.5)
802.11ac 40MHz (TxBF)	1 stream 4TX	5670	22.59	Default(17)	Nss1MCS0 (13.5)
802.11ac 40MHz (TxBF)	2 stream 4TX	5270	21.38	Default(16)	Nss2MCS0 (27)
802.11ac 40MHz (TxBF)	2 stream 4TX	5310	18.47	Default(13)	Nss2MCS0 (27)
802.11ac 40MHz (TxBF)	2 stream 4TX	5510	19.09	Default(13)	Nss2MCS0 (27)
802.11ac 40MHz (TxBF)	2 stream 4TX	5550	22.38	Default(17)	Nss2MCS0 (27)
802.11ac 40MHz (TxBF)	2 stream 4TX	5670	22.55	Default(17)	Nss2MCS0 (27)
802.11ac 40MHz (TxBF)	3 stream 4TX	5270	21.33	Default(16)	Nss3MCS0 (40.5)
802.11ac 40MHz (TxBF)	3 stream 4TX	5310	18.42	Default(13)	Nss3MCS0 (40.5)
802.11ac 40MHz (TxBF)	3 stream 4TX	5510	19.03	Default(13)	Nss3MCS0 (40.5)
802.11ac 40MHz (TxBF)	3 stream 4TX	5550	22.30	Default(17)	Nss3MCS0 (40.5)
802.11ac 40MHz (TxBF)	3 stream 4TX	5670	22.49	Default(17)	Nss3MCS0 (40.5)

Worst Modulation Mode	Number of Transmit Chains (NTX)	Frequency (MHz)	Maximum Output Power(dBm)	Power Setting	Data Rate / MCS
802.11ac 80MHz (CDD)	1 stream 4TX	5290	18.34	Default(13)	Nss1MCS0 (29.3)
802.11ac 80MHz (CDD)	1 stream 4TX	5530	19.16	Default(13)	Nss1MCS0 (29.3)
802.11ac 80MHz (CDD)	2 stream 4TX	5290	18.29	Default(13)	Nss2MCS0 (58.5)
802.11ac 80MHz (CDD)	2 stream 4TX	5530	19.10	Default(13)	Nss2MCS0 (58.5)
802.11ac 80MHz (SDM)	4 stream 4TX	5290	18.19	Default(13)	Nss4MCS0 (117)
802.11ac 80MHz (SDM)	4 stream 4TX	5530	19.01	Default(13)	Nss4MCS0 (117)
802.11ac 80MHz (TxBF)	1 stream 4TX	5290	18.25	Default(13)	Nss1MCS0 (29.3)
802.11ac 80MHz (TxBF)	1 stream 4TX	5530	18.06	Default(12)	Nss1MCS0 (29.3)
802.11ac 80MHz (TxBF)	2 stream 4TX	5290	18.19	Default(13)	Nss2MCS0 (58.5)
802.11ac 80MHz (TxBF)	2 stream 4TX	5530	18.00	Default(12)	Nss2MCS0 (58.5)
802.11ac 80MHz (TxBF)	3 stream 4TX	5290	18.15	Default(13)	Nss3MCS0 (87.8)
802.11ac 80MHz (TxBF)	3 stream 4TX	5530	17.96	Default(12)	Nss3MCS0 (87.8)

### 1.14 On Time and Duty Cycle

Mode	On Time (ms)	Period (ms)	Duty Cycle (%)	Duty Cycle Correction Factor (dB)	1/T Minimum VBW (kHz)
11a 1S4T CDD	1.361	1.495	91	0.41	1
11ac (20MHz) 1S4T CDD	4.968	5.041	98.6	-	-
11ac (20MHz) 2S4T CDD	4.968	5.041	98.6	-	-
11ac (20MHz) 4S4T SDM	4.968	5.041	98.6	-	-
11ac (20MHz) 1S4T TxBF	4.968	5.041	98.6	-	-
11ac (20MHz) 2S4T TxBF	4.968	5.041	98.6	-	-
11ac (20MHz) 3S4T TxBF	4.968	5.041	98.6	-	-
11ac (40MHz) 1S4T CDD	5.968	6.048	98.7	-	-
11ac (40MHz) 2S4T CDD	5.968	6.048	98.7	-	-
11ac (40MHz) 4S4T SDM	5.968	6.048	98.7	-	-
11ac (40MHz) 1S4T TxBF	5.968	6.048	98.7	-	-
11ac (40MHz) 2S4T TxBF	5.968	6.048	98.7	-	-
11ac (40MHz) 3S4T TxBF	5.968	6.048	98.7	-	-
11ac (80MHz) 1S4T CDD	2.778	2.832	98.1	-	-
11ac (80MHz) 2S4T CDD	2.778	2.832	98.1	-	-
11ac (80MHz) 4S4T SDM	2.778	2.832	98.1	-	-
11ac (80MHz) 1S4T TxBF	2.778	2.832	98.1	-	-
11ac (80MHz) 2S4T TxBF	2.778	2.832	98.1	-	-
11ac (80MHz) 3S4T TxBF	2.778	2.832	98.1	-	-

Note:

1. Power measurement using sweep trigger and gating of the power meter, duty factor is not required.
2. Duty cycle > 98%, duty factor is not required.

### 11a 1S4T CDD

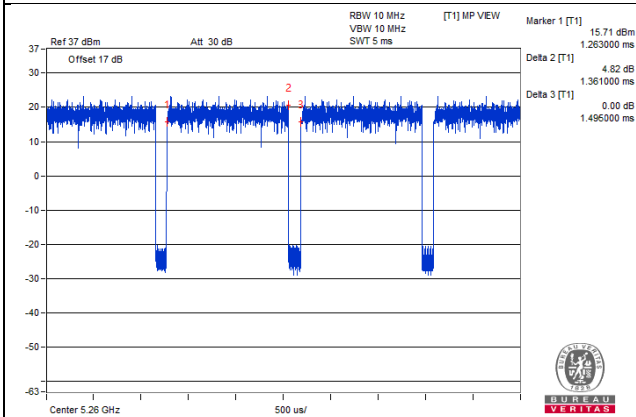

### 11ac (20MHz) 1S4T CDD

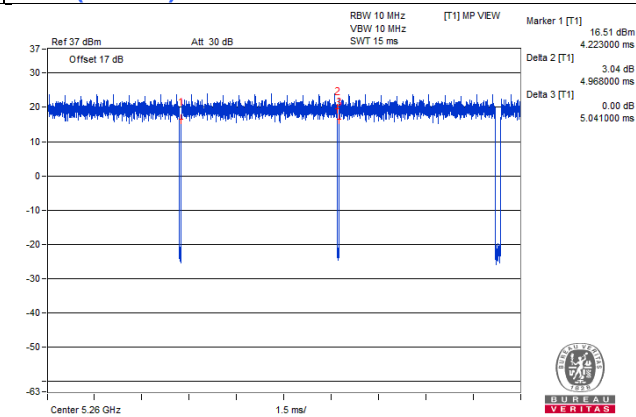

### 11ac (20MHz) 2S4T CDD

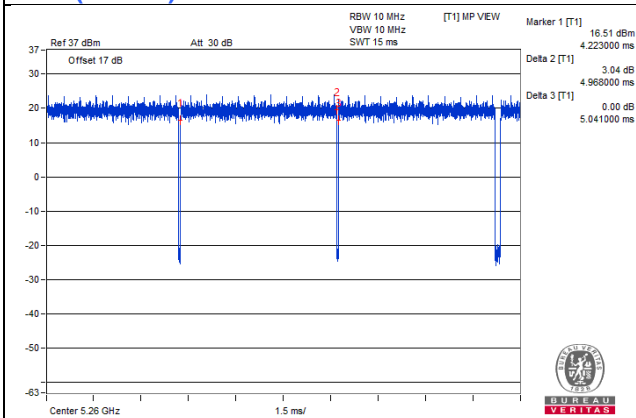

### 11ac (20MHz) 4S4T SDM

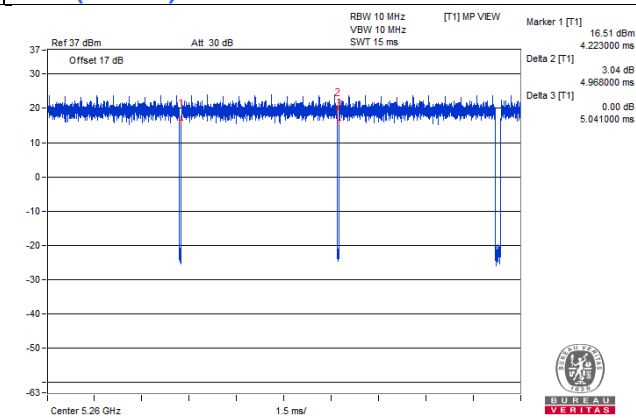

### 11ac (20MHz) 1S4T TxBF

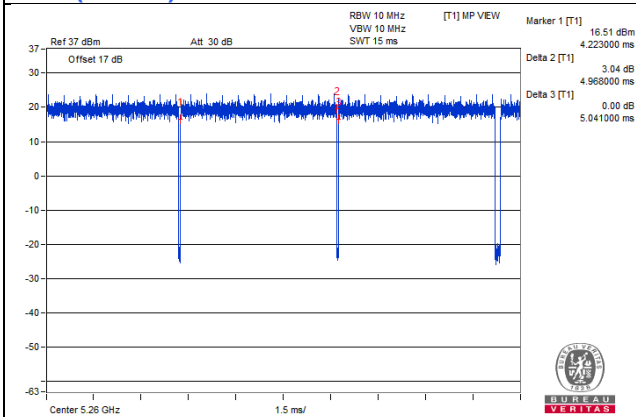

### 11ac (20MHz) 2S4T TxBF

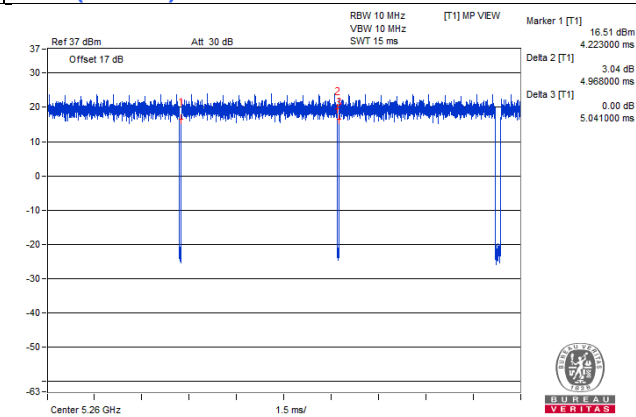

### 11ac (20MHz) 3S4T TxBF

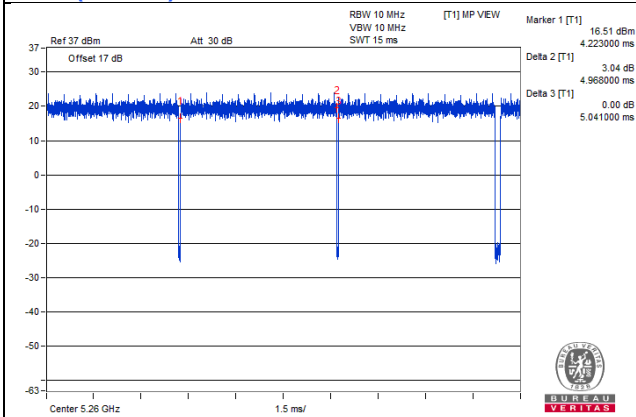

### 11ac (40MHz) 1S4T CDD

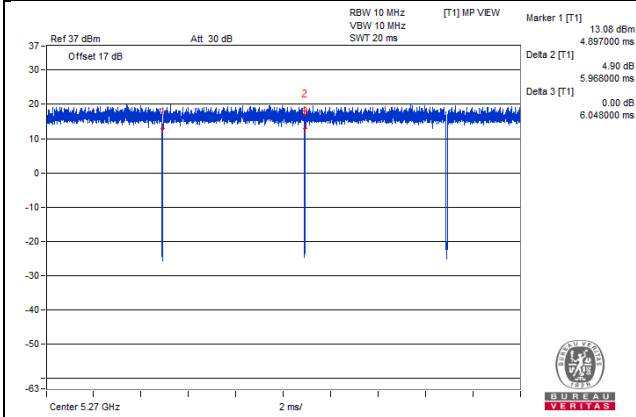

### 11ac (40MHz) 2S4T CDD

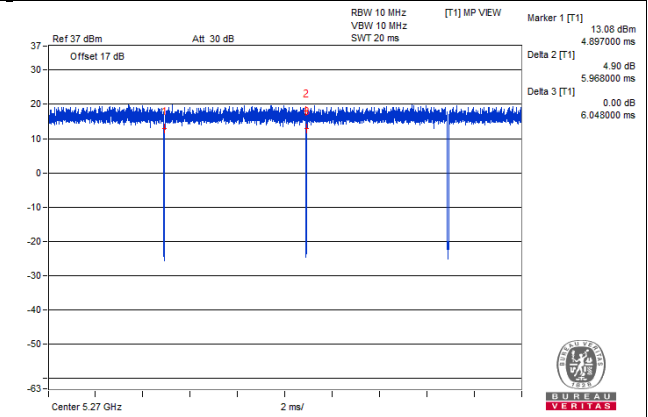

### 11ac (40MHz) 4S4T SDM

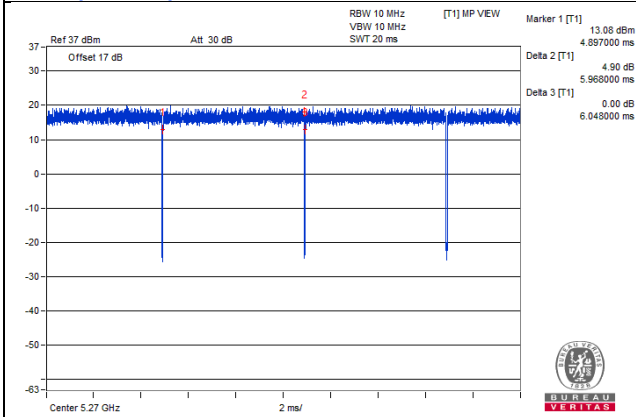

### 11ac (40MHz) 1S4T TxBF

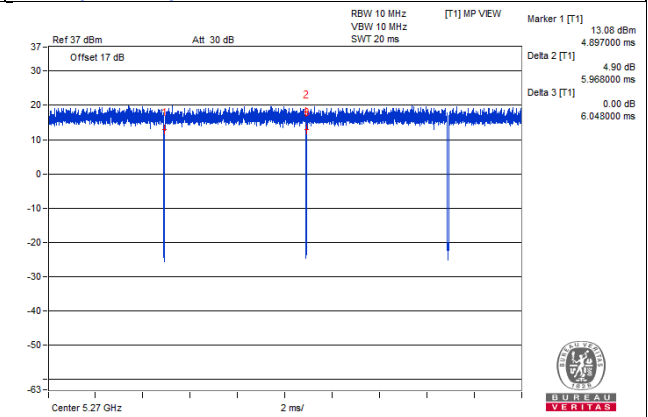

### 11ac (40MHz) 2S4T TxBF

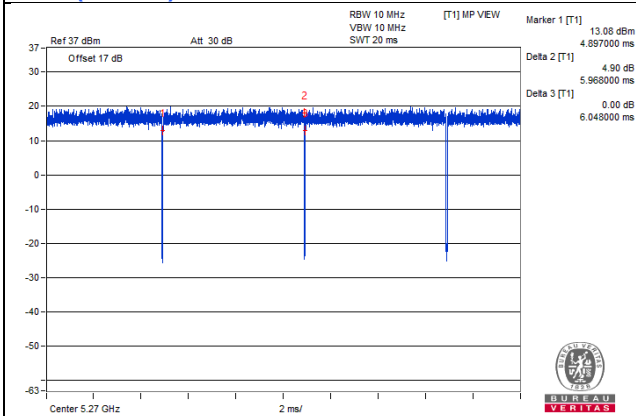

### 11ac (40MHz) 3S4T TxBF

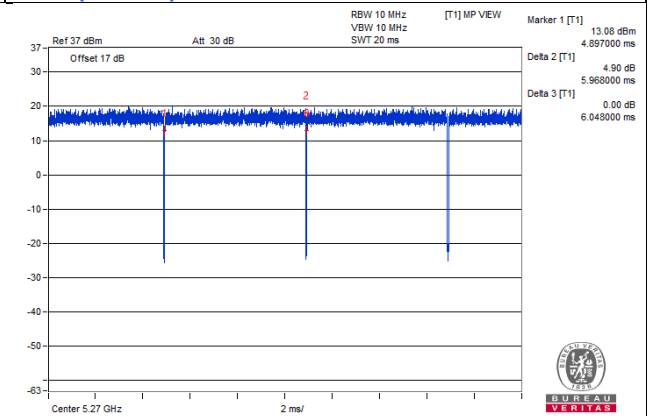



### 11ac (80MHz) 1S4T CDD

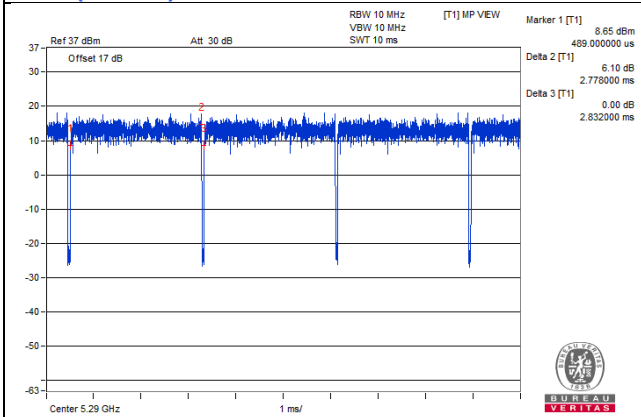

### 11ac (80MHz) 2S4T CDD

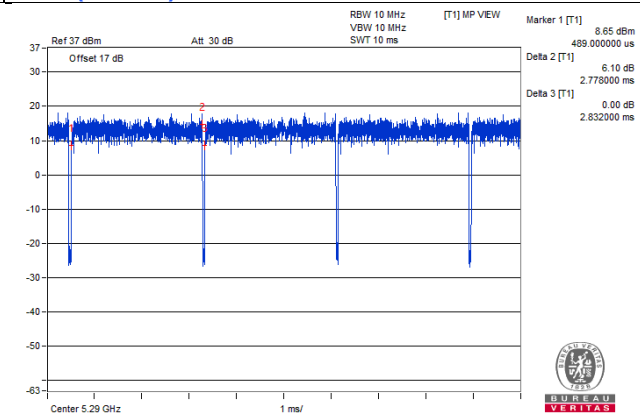

### 11ac (80MHz) 4S4T SDM

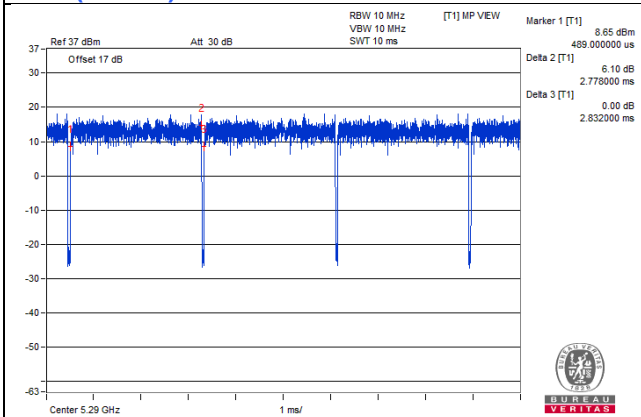

### 11ac (80MHz) 1S4T TxBF

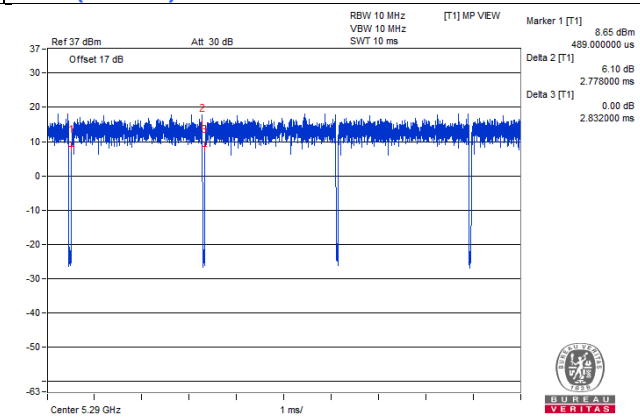

### 11ac (80MHz) 2S4T TxBF

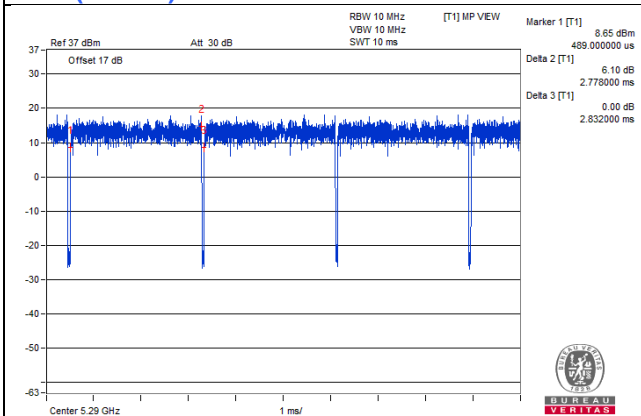

### 11ac (80MHz) 3S4T TxBF

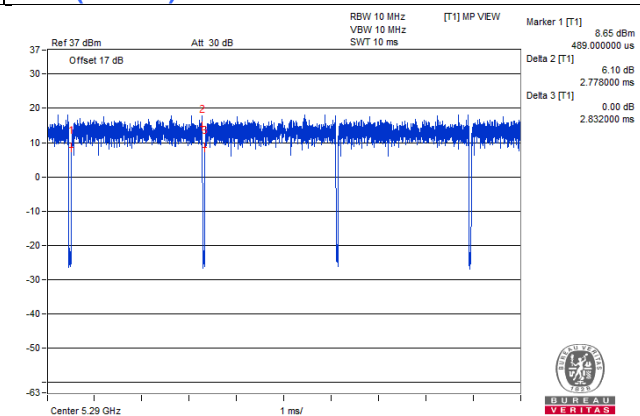

### 1.15 Testing Location Information

Test Site Location				
<b>Address</b>	(1) E-2, No.1, Li Hsin 1st Road, Hsinchu Science Park, Hsinchu City 300, Taiwan R.O.C.			
<b>TEL</b>	886-3-6668565			
<b>FAX</b>	886-3-6668323			
<b>Test Site No.</b>	<b>Site Category</b>	<b>Location</b>	<b>IC Reg. No.</b>	<b>VCCI Reg. No</b>
Conduction 1	Conduction	Hsinchu	-	-
Chamber 3	966 Chamber	Hsinchu	20331-1	-
Oven 2	Oven	Hsinchu	-	-

### 1.16 EUT Diagram and Support Equipment

The EUT has been tested as an independent unit together with other necessary accessories or support units. The following support units or accessories were used to form a representative test configuration during the tests.

ID	Product	Brand	Model No.	Serial No.	FCC ID	Remarks
A.	Laptop	DELL	E6420	B92T3R1	FCC DoC	Provided by Lab

Note:

- All power cords of the above support units are non-shielded (1.8m).

ID	Descriptions	Qty.	Length (m)	Shielding (Yes/No)	Cores (Qty.)	Remarks
1.	RJ-45 Cable	1	10	No	0	Provided by Lab
2.	DC Cable	1	1.5	No	0	Supplied by client

### EUT Diagram

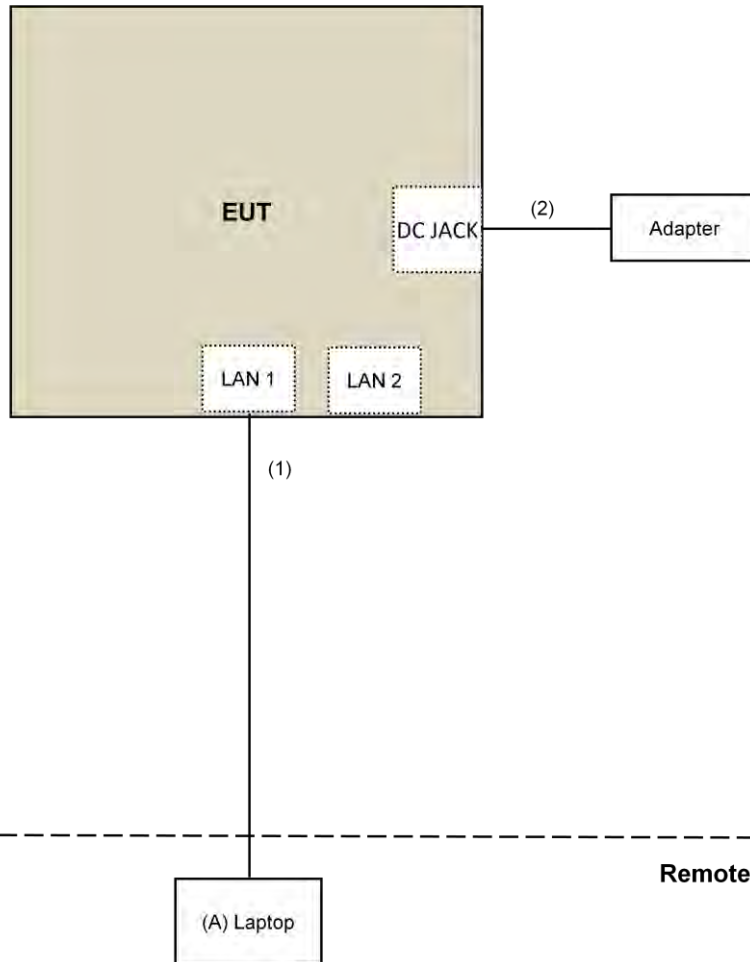

## 4 Test Types and Results

### 4.1 AC Power Conducted Emissions Measurement

#### 4.1.1 Limit

For this product which is designed to be connected to the AC power line, the radio frequency voltage that is conducted back onto the AC power line on any frequency or frequencies within the band 150 kHz to 30 MHz shall not exceed below limits table.

Frequency (MHz)	Conducted Limit (dBuV)	
	Quasi-peak	Average
0.15 - 0.5	66 - 56	56 - 46
0.50 - 5.0	56	46
5.0 - 30.0	60	50

#### 4.1.2 Measuring Instruments and Setting

Please refer to section 5 of equipments list in this report. The following table is the setting of the receiver

Receiver Parameters	Setting
Attenuation	10 dB
Start Frequency	0.15 MHz
Stop Frequency	30 MHz
IF Bandwidth	9 kHz

#### 4.1.3 Test Procedures

1. Configure the EUT according to ANSI C63.10. The EUT or host of EUT has to be placed 0.4 meter far from the conducting wall of the shielding room and at least 80 centimeters from any other grounded conducting surface.
2. Connect EUT or host of EUT to the power mains through a line impedance stabilization network (LISN).
3. All the support units are connected to the other LISNs. The LISN should provide 50uH/50ohms coupling impedance.
4. The frequency range from 150 kHz to 30 MHz was searched.
5. Set the test-receiver system to Peak Detect Function and Specified Bandwidth with Maximum Hold Mode.
6. The measurement has to be done between each power line and ground at the power terminal.

#### 4.1.4 Test Setup Layout

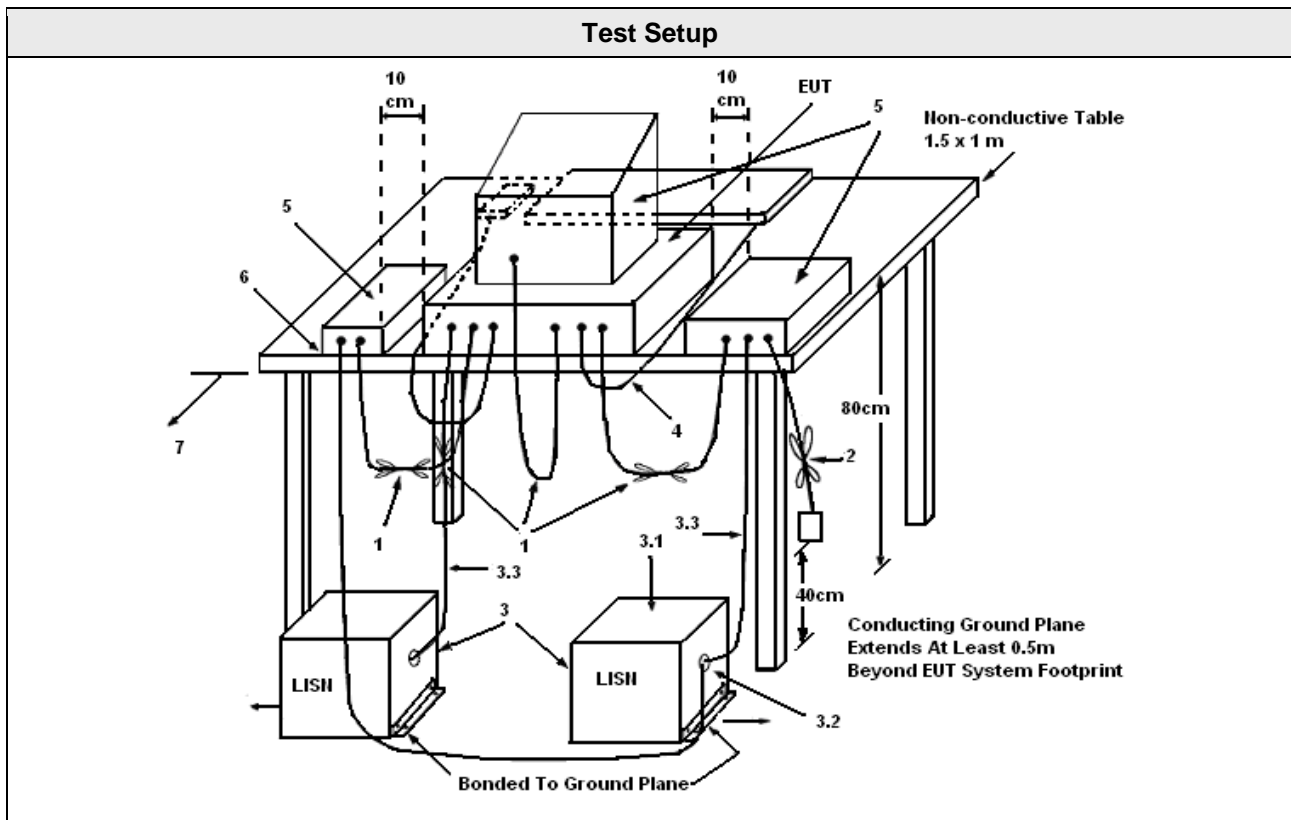

1. Interconnecting cables that hang closer than 40 cm to the ground plane shall be folded back and forth in the center forming a bundle 30 to 40 cm long.
2. I/O cables that are not connected to a peripheral shall be bundled in the center. The end of the cable may be terminated, if required, using the correct terminating impedance. The overall length shall not exceed 1 m.
3. EUT connected to one LISN. Unused LISN measuring port connectors shall be terminated in 50  $\Omega$ . LISN can be placed on top of, or immediately beneath, reference ground plane.
4. All other equipment powered from additional LISN(s).
5. Multiple outlet strip can be used for multiple power cords of non-EUT equipment.
6. LISN at least 80 cm from nearest part of EUT chassis.
7. Cables of hand-operated devices, such as keyboards, mice, etc., shall be placed as for normal use.
8. Non-EUT components of EUT system being tested.
9. Rear of EUT, including peripherals, shall all be aligned and flush with rear of tabletop.
10. Rear of tabletop shall be 40 cm removed from a vertical conducting plane that is bonded to the ground plane.

#### 4.1.5 Test Deviation

There are no deviations with the original standard.

#### 4.1.6 EUT Operating during Test

The EUT was placed on the test table and programmed in normal function.

#### 4.1.7 Test Results of AC Power Conducted Emissions

<b>Frequency Range</b>	150kHz ~ 30MHz	<b>Detector Function &amp; Resolution Bandwidth</b>	Quasi-Peak (QP) / Average (AV), 9kHz
<b>Input Power</b>	120Vac, 60Hz	<b>Environmental Conditions</b>	25°C, 75%RH
<b>Tested by</b>	Andy Ho		

Phase Of Power : Line (L)										
No	Frequency (MHz)	Correction Factor (dB)	Reading Value (dBuV)		Emission Level (dBuV)		Limit (dBuV)		Margin (dB)	
			Q.P.	AV.	Q.P.	AV.	Q.P.	AV.	Q.P.	AV.
1	0.15781	10.05	43.60	31.59	53.65	41.64	65.58	55.58	-11.93	-13.94
2	0.18125	10.06	39.41	27.75	49.47	37.81	64.43	54.43	-14.96	-16.62
3	0.33359	10.10	25.31	14.34	35.41	24.44	59.36	49.36	-23.95	-24.92
4	0.59141	10.14	28.17	21.55	38.31	31.69	56.00	46.00	-17.69	-14.31
5	12.60938	10.89	19.17	12.61	30.06	23.50	60.00	50.00	-29.94	-26.50
6	22.58984	11.43	22.34	17.18	33.77	28.61	60.00	50.00	-26.23	-21.39

#### Remarks:

1. Q.P. and AV. are abbreviations of quasi-peak and average individually.
2. The emission levels of other frequencies were very low against the limit.
3. Margin value = Emission level – Limit value
4. Correction factor = Insertion loss + Cable loss
5. Emission Level = Correction Factor + Reading Value

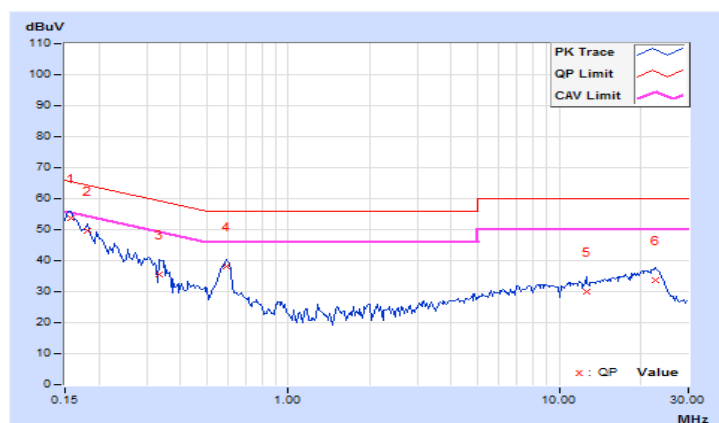

<b>Frequency Range</b>	150kHz ~ 30MHz	<b>Detector Function &amp; Resolution Bandwidth</b>	Quasi-Peak (QP) / Average (AV), 9kHz
<b>Input Power</b>	120Vac, 60Hz	<b>Environmental Conditions</b>	25°C, 75%RH
<b>Tested by</b>	Andy Ho		

Phase Of Power : Neutral (N)										
No	Frequency (MHz)	Correction Factor (dB)	Reading Value (dBuV)		Emission Level (dBuV)		Limit (dBuV)		Margin (dB)	
			Q.P.	AV.	Q.P.	AV.	Q.P.	AV.	Q.P.	AV.
1	0.15000	9.95	41.77	23.89	51.72	33.84	66.00	56.00	-14.28	-22.16
2	0.16562	9.96	41.64	26.24	51.60	36.20	65.18	55.18	-13.58	-18.98
3	0.29453	9.99	25.98	13.86	35.97	23.85	60.40	50.40	-24.43	-26.55
4	0.59531	10.03	26.95	19.09	36.98	29.12	56.00	46.00	-19.02	-16.88
5	10.44922	10.57	18.34	11.05	28.91	21.62	60.00	50.00	-31.09	-28.38
6	22.10938	11.19	23.32	18.05	34.51	29.24	60.00	50.00	-25.49	-20.76

**Remarks:**

1. Q.P. and AV. are abbreviations of quasi-peak and average individually.
2. The emission levels of other frequencies were very low against the limit.
3. Margin value = Emission level – Limit value
4. Correction factor = Insertion loss + Cable loss
5. Emission Level = Correction Factor + Reading Value

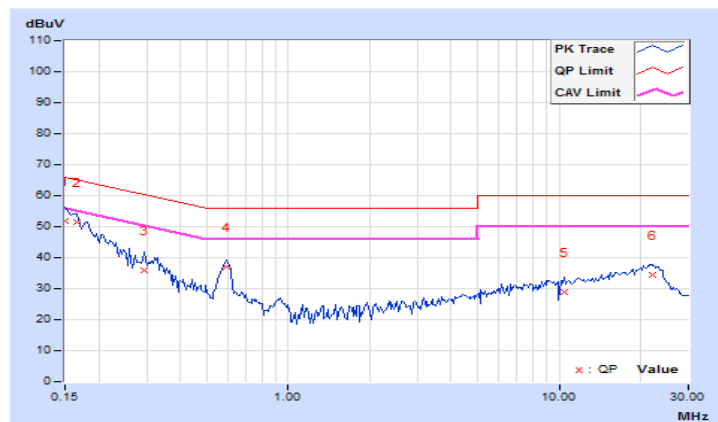



## 4.2 Occupied Bandwidth and 26dB Bandwidth Measurement

### 4.2.1 Measuring Instruments and Setting

The following table is the setting of the Spectrum Analyzer.

99% Occupied Bandwidth	
Spectrum Parameter	Setting
Attenuation	Auto
Span Frequency	1.5 times to 5.0 times the OBW
RBW	1% to 5% of the anticipated emission bandwidth
VBW	$\geq 3 \times \text{RBW}$
Detector	Peak
Trace	Max hold
Sweep Time	Auto
26dB Bandwidth	
Spectrum Parameter	Setting
Attenuation	Auto
Span Frequency	> 26dB Bandwidth
RBW	Approximately 1% of the emission bandwidth.
VBW	> RBW
Detector	Peak
Trace	Max hold
Sweep Time	Auto

### 4.2.2 Test Procedure

- 1 The transmitter output (antenna port) was connected to the spectrum analyzer.
- 2 Test was performed in accordance with Measurement of Digital Transmission Systems Operating under 789033 D02 General UNII Test Procedures New Rules v01r04, in section "Emission bandwidth (C)(1)" & "99 Percent Occupied Bandwidth"(D). 05/02/2017.
- 3 When measuring Emission bandwidth with multiple antenna systems, add every result of the values by mathematic formula.

### 4.2.3 Test Setup Layout

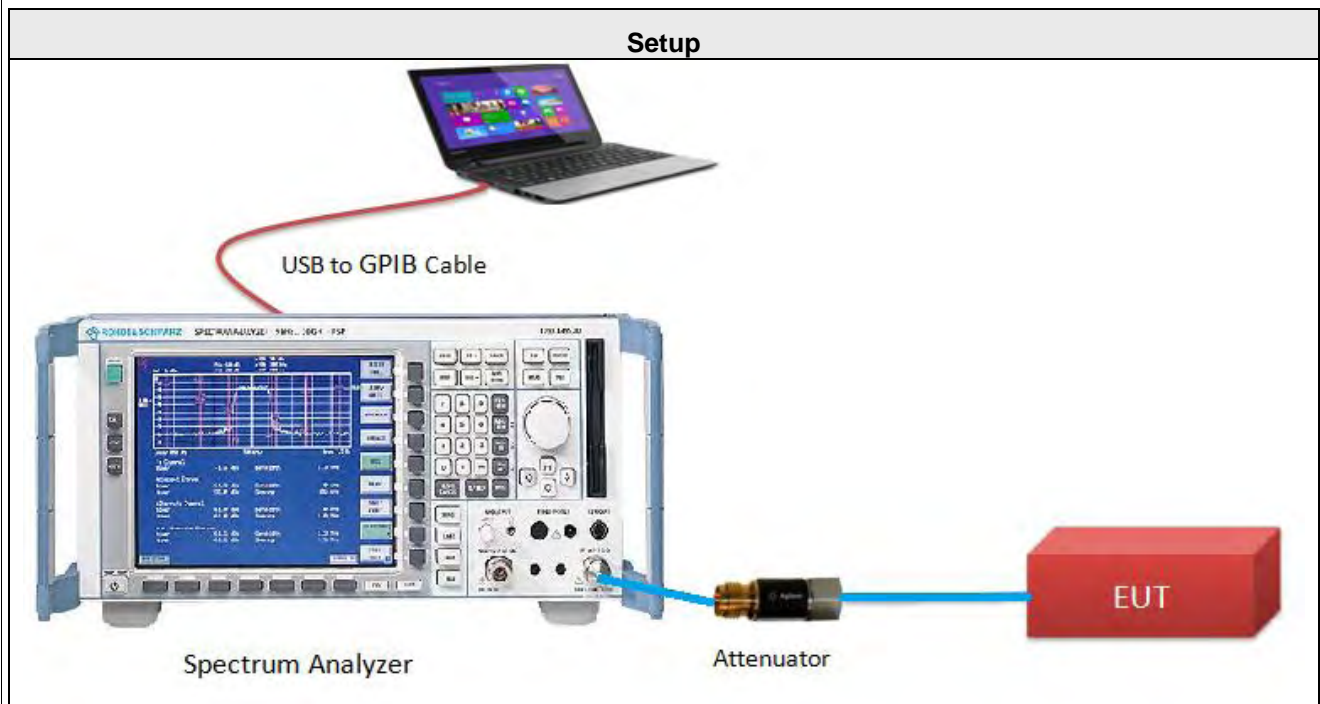

### 4.2.4 Test Deviation

There are no deviations with the original standard.

### 4.2.5 EUT Operating Conditions

The EUT was programmed to be in continuously transmitting mode.

#### 4.2.6 Test Results

Temperature	25°C	Humidity	60%
Test Engineer	Anderson Chen		

#### 11a 1S4T CDD

CHANNEL	FREQUENCY (MHz)	26dB Bandwidth (MHz)			
		CHAIN 1	CHAIN 2	CHAIN 3	CHAIN 4
52	5260	23.04	23.6	23.58	23.55
60	5300	22.87	23.58	23.61	23.64
64	5320	22.98	23.57	23.55	23.63
100	5500	23.26	23.75	23.11	23.64
116	5580	23.47	23.8	23	23.66
140	5700	23.39	23.69	22.96	23.6

#### 11ac (20MHz) 1S4T CDD

CHANNEL	FREQUENCY (MHz)	26dB Bandwidth (MHz)			
		CHAIN 1	CHAIN 2	CHAIN 3	CHAIN 4
52	5260	25.07	24.92	24.88	25.05
60	5300	24.88	25.01	24.8	24.54
64	5320	25.11	24.81	24.93	24.9
100	5500	24.97	25.11	24.7	24.44
116	5580	25.11	25.25	25.15	24.81
140	5700	25.09	25.24	25.06	24.76

#### 11ac (20MHz) 1S4T TxBF

CHANNEL	FREQUENCY (MHz)	26dB Bandwidth (MHz)			
		CHAIN 1	CHAIN 2	CHAIN 3	CHAIN 4
52	5260	25.44	24.86	24.45	24.82
60	5300	25.23	24.77	24.67	24.42
64	5320	25.23	24.93	24.63	24.68
100	5500	25.04	25.27	24.71	24.32
116	5580	25.13	25.38	24.53	24.7
140	5700	25.38	24.99	25.01	24.79

### 11ac (40MHz) 1S4T CDD

CHANNEL	FREQUENCY (MHz)	26dB Bandwidth (MHz)			
		CHAIN 1	CHAIN 2	CHAIN 3	CHAIN 4
54	5270	44.61	44.19	43.92	43.69
62	5310	44.66	43.82	43.83	43.64
102	5510	44.52	43.95	44.06	43.58
110	5550	44.59	44.06	44.05	43.7
134	5670	44.54	44.29	44.3	43.66

### 11ac (40MHz) 1S4T TxBF

CHANNEL	FREQUENCY (MHz)	26dB Bandwidth (MHz)			
		CHAIN 1	CHAIN 2	CHAIN 3	CHAIN 4
54	5270	44.47	43.89	43.95	43.35
62	5310	44.31	43.96	43.61	43.52
102	5510	44.49	43.78	44.09	43.63
110	5550	44.46	44.03	43.87	43.78
134	5670	44.79	44.15	43.8	43.56

### 11ac (80MHz) 1S4T CDD

CHANNEL	FREQUENCY (MHz)	26dB Bandwidth (MHz)			
		CHAIN 1	CHAIN 2	CHAIN 3	CHAIN 4
58	5290	83.97	83.47	83.62	83.07
106	5530	84.08	83.14	83.24	82.54

### 11ac (80MHz) 1S4T TxBF

CHANNEL	FREQUENCY (MHz)	26dB Bandwidth (MHz)			
		CHAIN 1	CHAIN 2	CHAIN 3	CHAIN 4
58	5290	83.71	82.94	83.27	82.43
106	5530	83.63	82.84	82.45	83.07

## 26dB BANDWIDTH SPECTRUM PLOT

### 11a 1S4T CDD CH52 Chain1

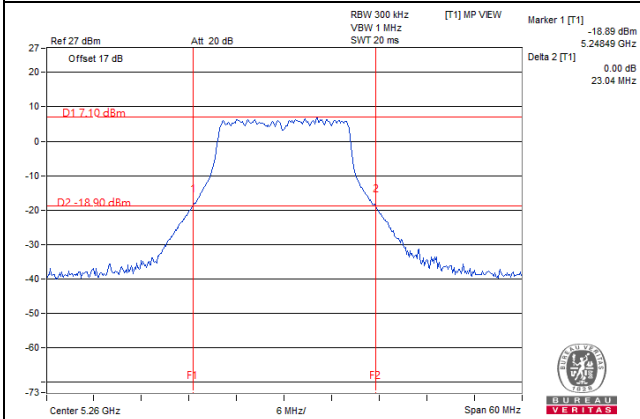

### 11a 1S4T CDD CH60 Chain1

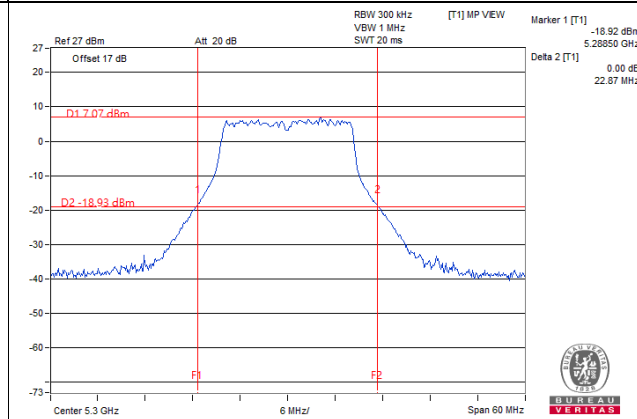

### 11a 1S4T CDD CH52 Chain2

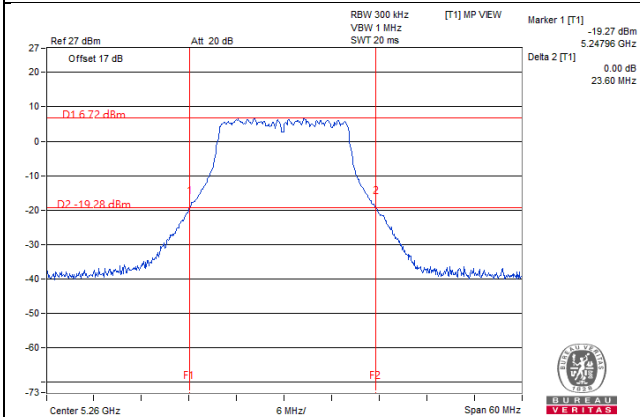

### 11a 1S4T CDD CH60 Chain2

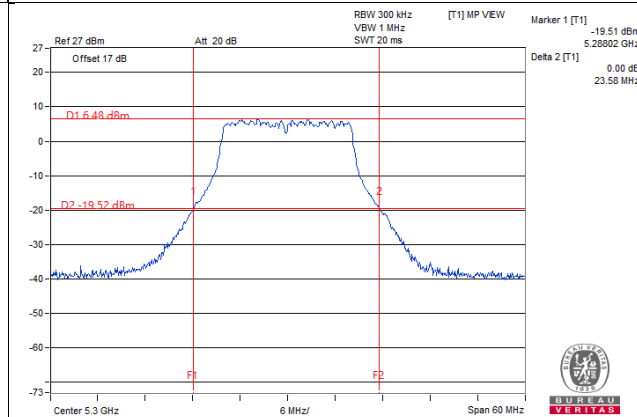

### 11a 1S4T CDD CH52 Chain3

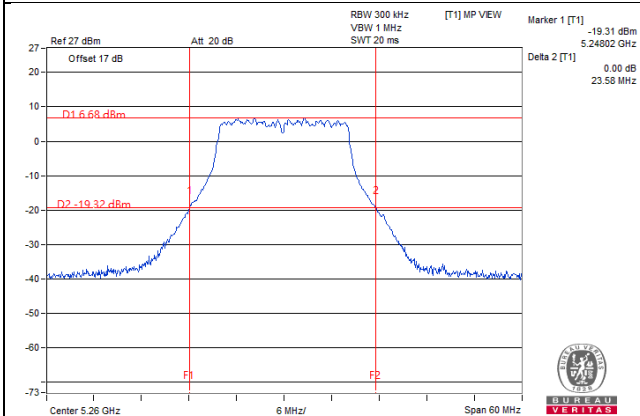

### 11a 1S4T CDD CH60 Chain3

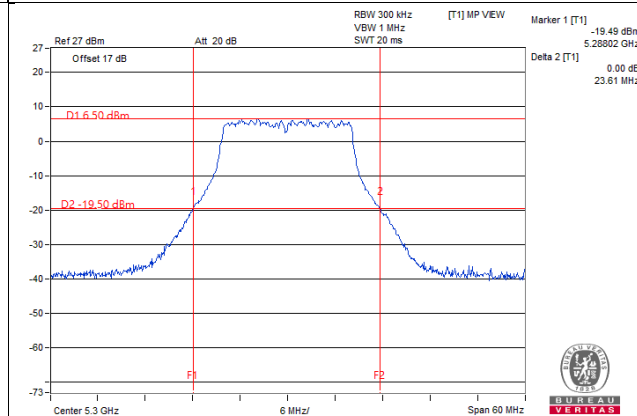

### 11a 1S4T CDD CH52 Chain4

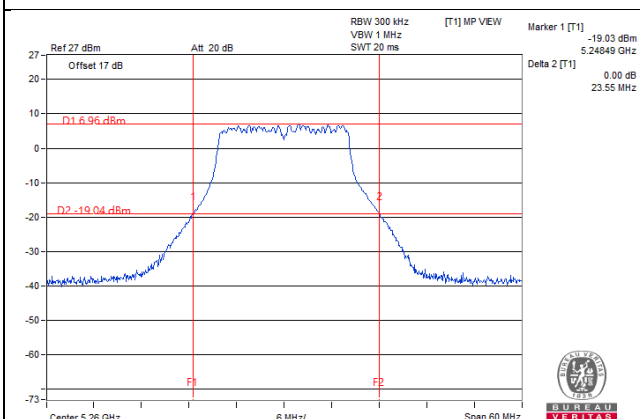

### 11a 1S4T CDD CH60 Chain4

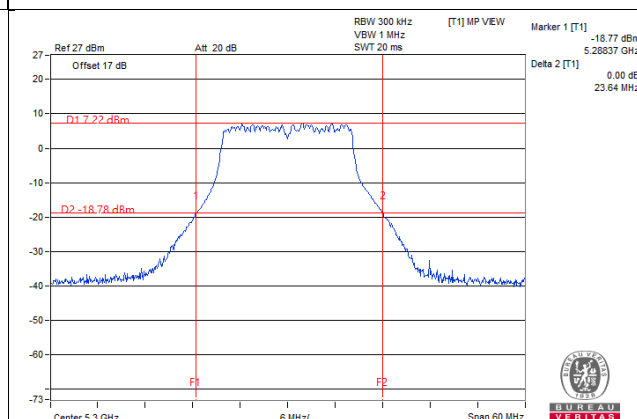

## 26dB BANDWIDTH SPECTRUM PLOT

### 11a 1S4T CDD CH64 Chain1

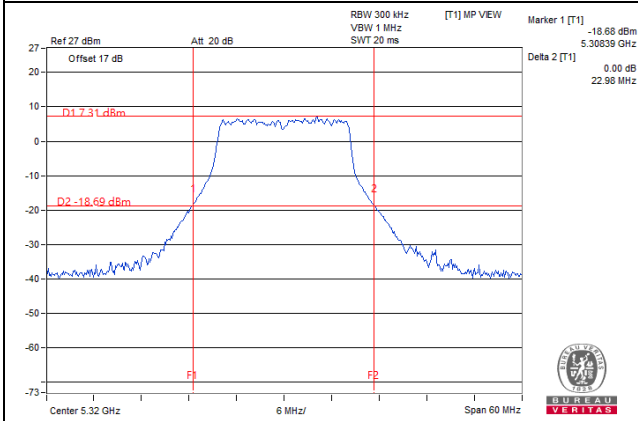

### 11a 1S4T CDD CH64 Chain2

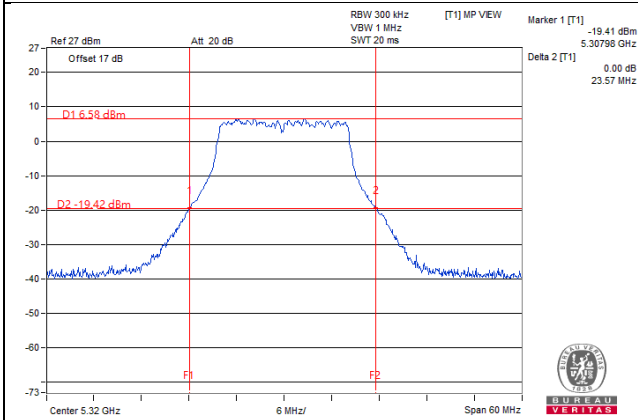

### 11a 1S4T CDD CH64 Chain3

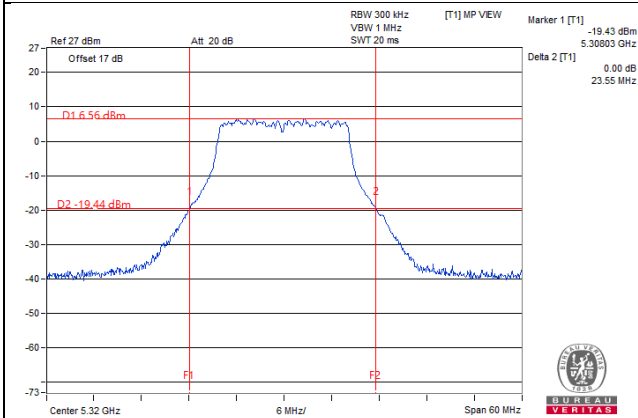

### 11a 1S4T CDD CH64 Chain4

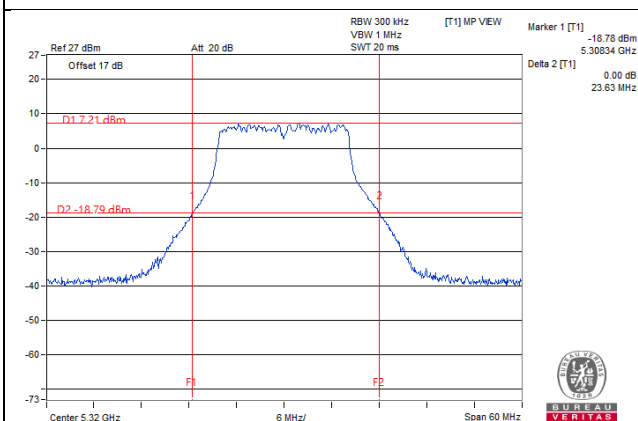

## 26dB BANDWIDTH SPECTRUM PLOT

### 11a 1S4T CDD CH100 Chain1

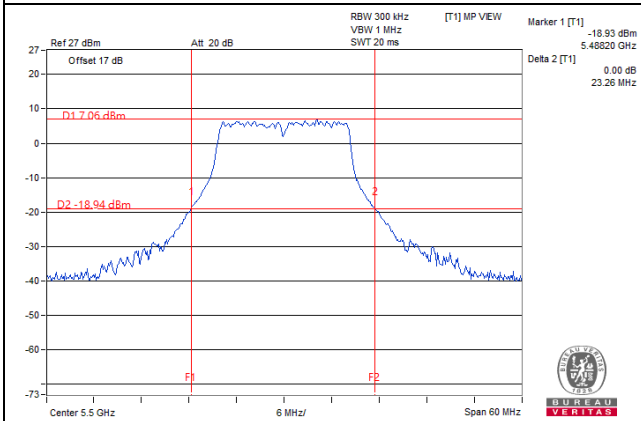

### 11a 1S4T CDD CH116 Chain1

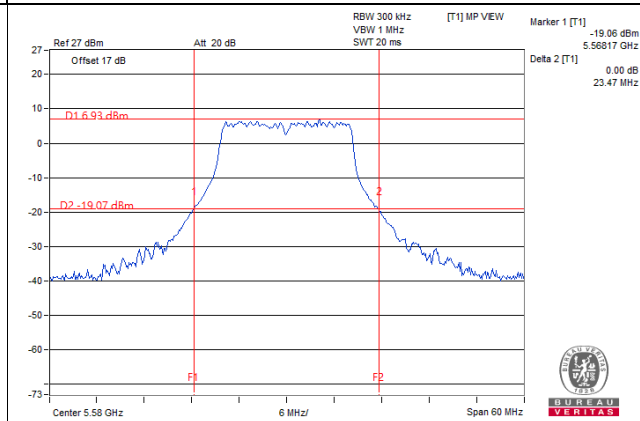

### 11a 1S4T CDD CH100 Chain2

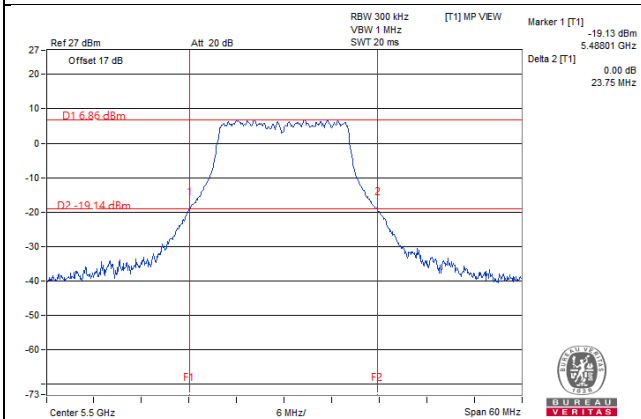

### 11a 1S4T CDD CH116 Chain2

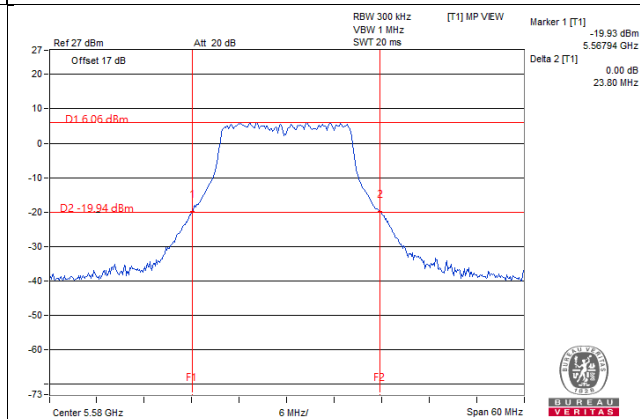

### 11a 1S4T CDD CH100 Chain3

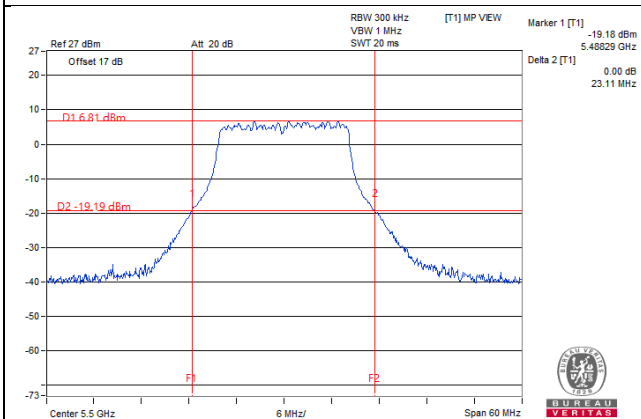

### 11a 1S4T CDD CH116 Chain3

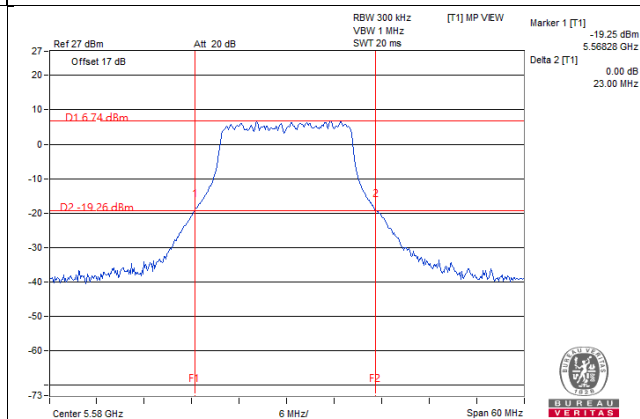

### 11a 1S4T CDD CH100 Chain4

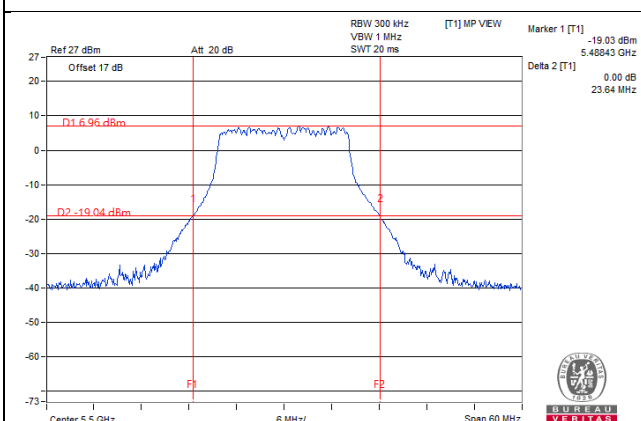

### 11a 1S4T CDD CH116 Chain4

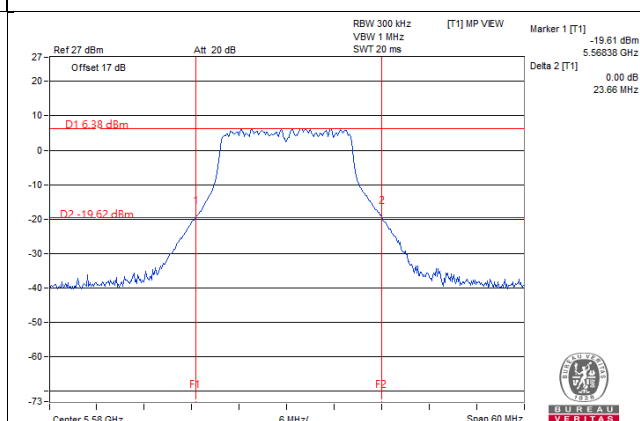

## 26dB BANDWIDTH SPECTRUM PLOT

### 11a 1S4T CDD CH140 Chain1

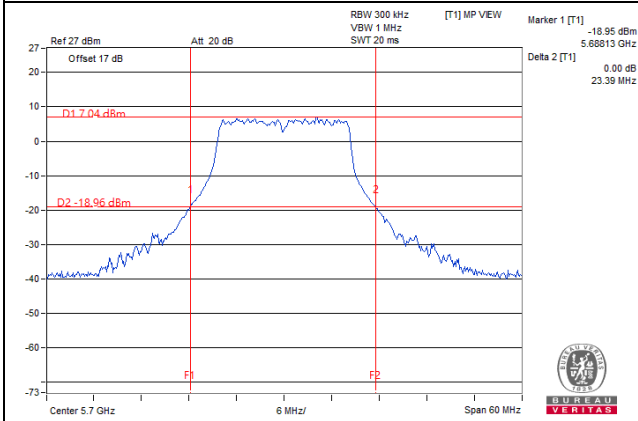

### 11a 1S4T CDD CH140 Chain2

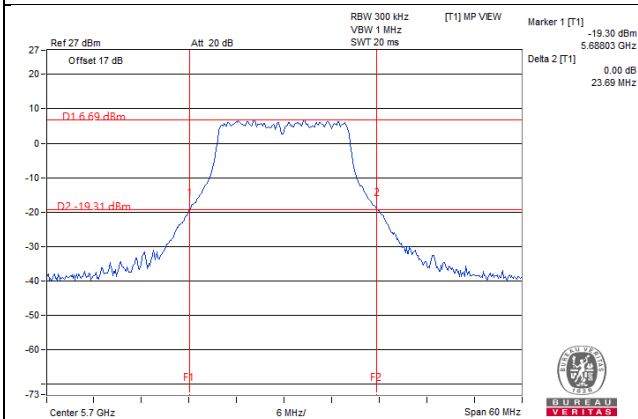

### 11a 1S4T CDD CH140 Chain3

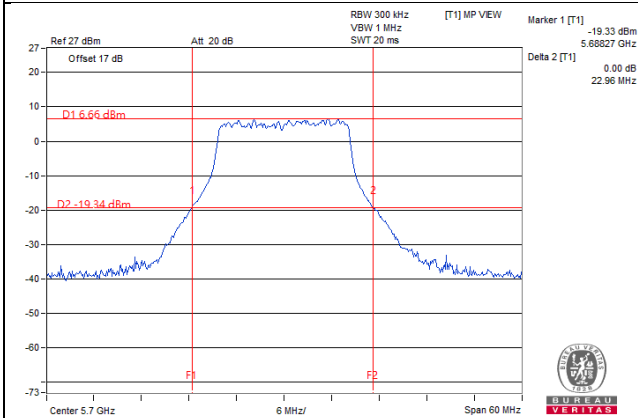

### 11a 1S4T CDD CH140 Chain4

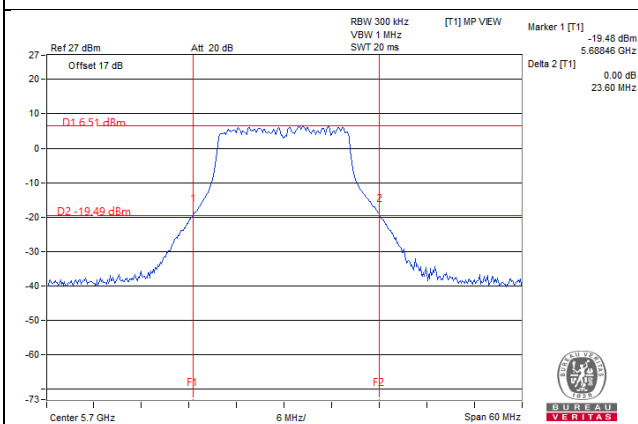



## 26dB BANDWIDTH SPECTRUM PLOT

### 11ac (20MHz) 1S4T CDD CH52 Chain1

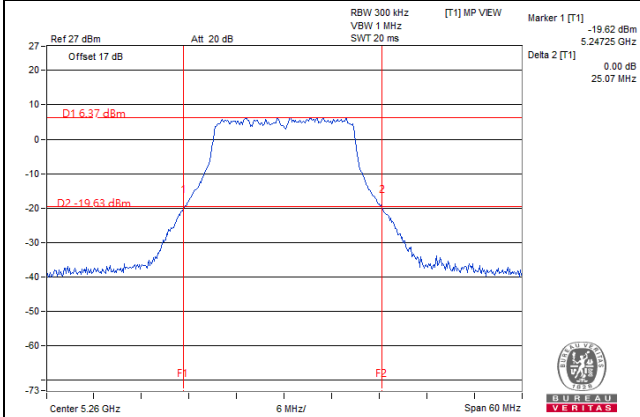

### 11ac (20MHz) 1S4T CDD CH60 Chain1

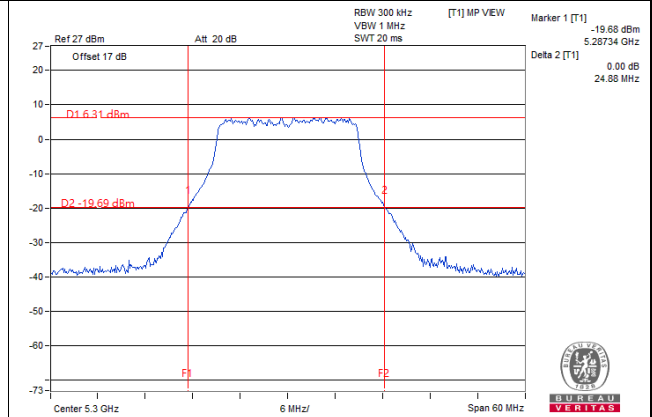

### 11ac (20MHz) 1S4T CDD CH52 Chain2

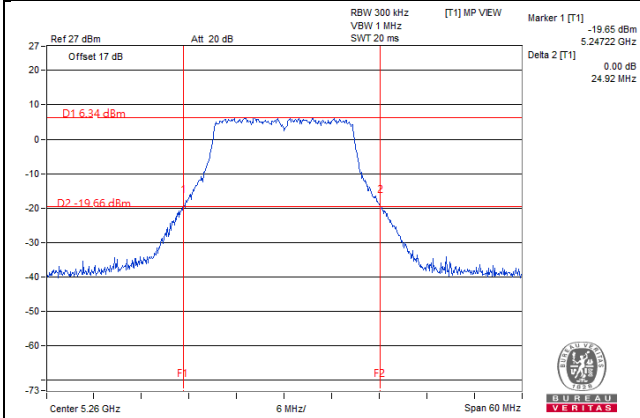

### 11ac (20MHz) 1S4T CDD CH60 Chain2

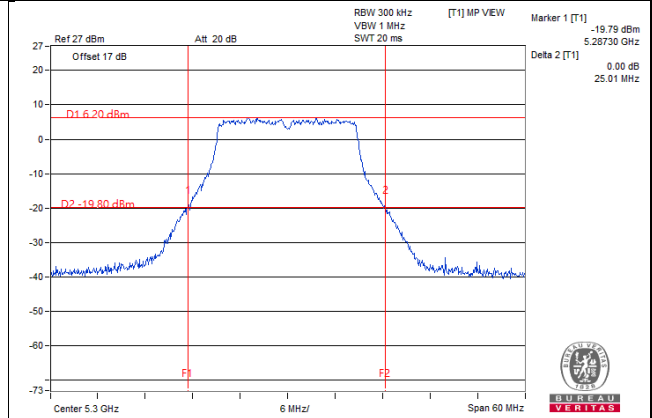

### 11ac (20MHz) 1S4T CDD CH52 Chain3

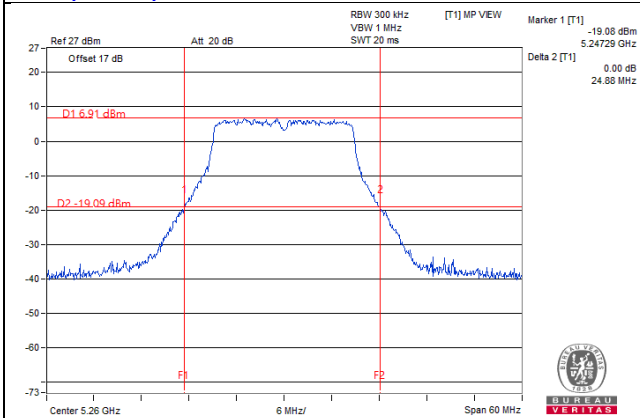

### 11ac (20MHz) 1S4T CDD CH60 Chain3

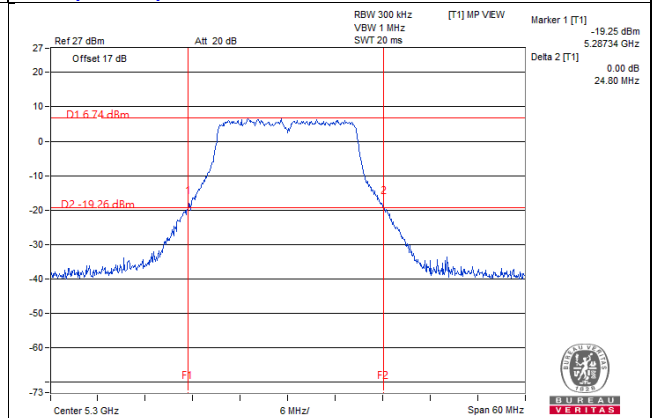

### 11ac (20MHz) 1S4T CDD CH52 Chain4

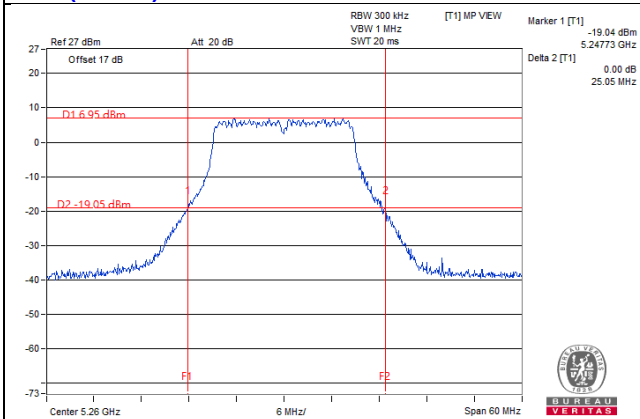

### 11ac (20MHz) 1S4T CDD CH60 Chain4

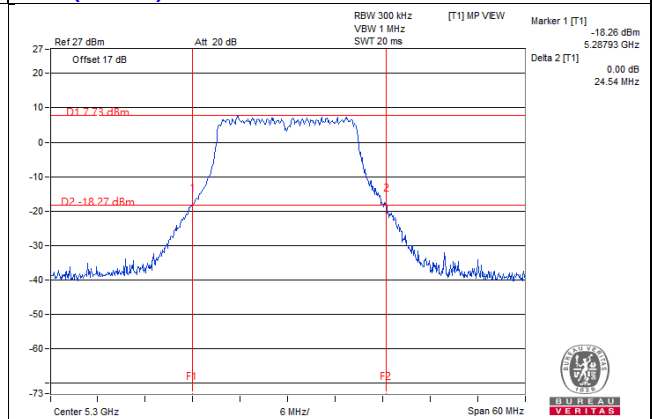

### 26dB BANDWIDTH SPECTRUM PLOT

**11ac (20MHz) 1S4T CDD CH64 Chain1**

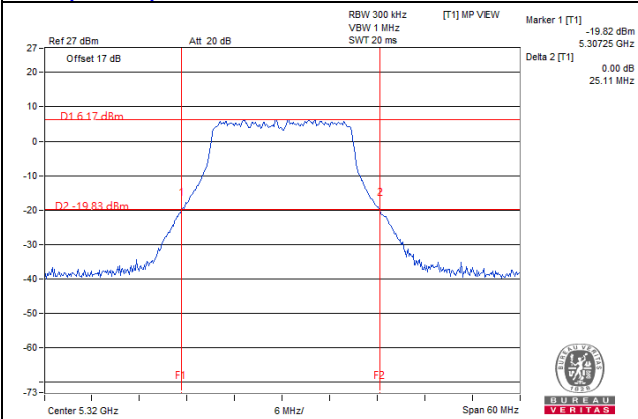

**11ac (20MHz) 1S4T CDD CH100 Chain1**

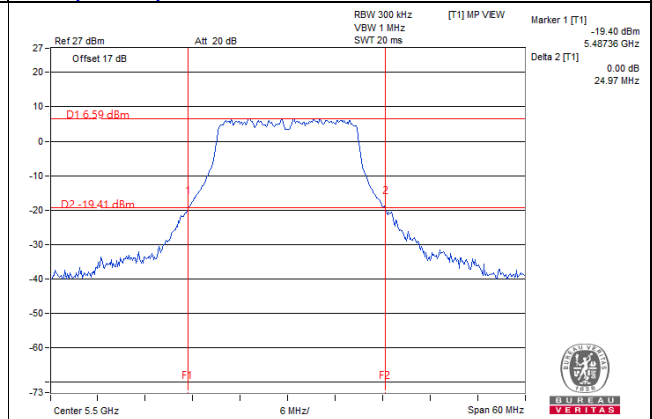

**11ac (20MHz) 1S4T CDD CH64 Chain2**

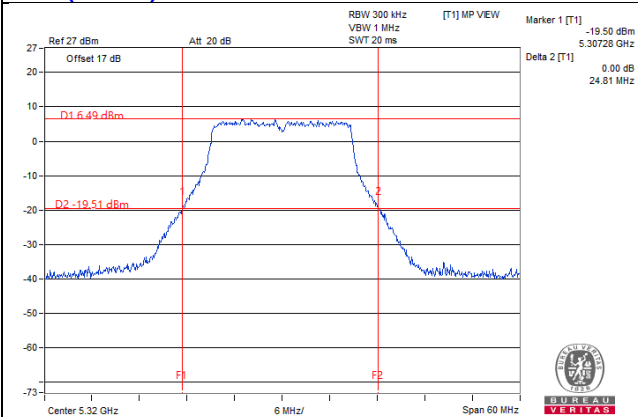

**11ac (20MHz) 1S4T CDD CH100 Chain2**

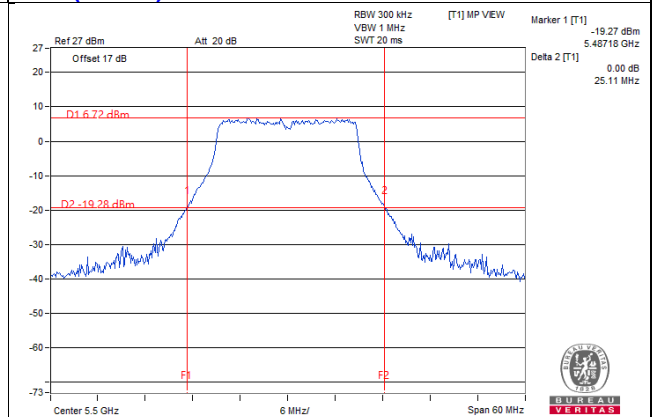

**11ac (20MHz) 1S4T CDD CH64 Chain3**

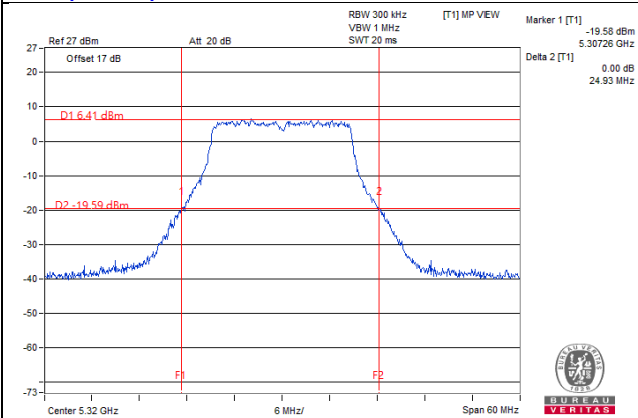

**11ac (20MHz) 1S4T CDD CH100 Chain3**

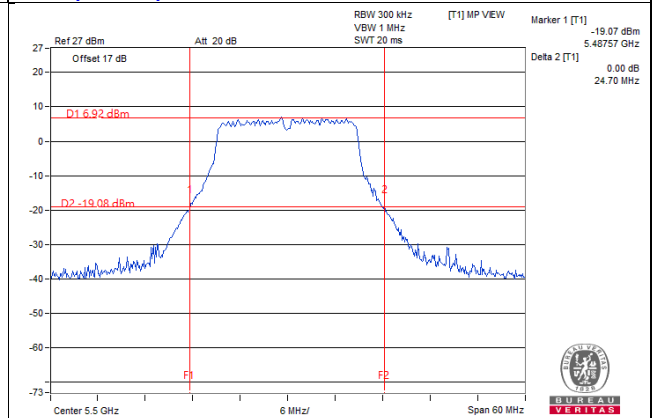

**11ac (20MHz) 1S4T CDD CH64 Chain4**

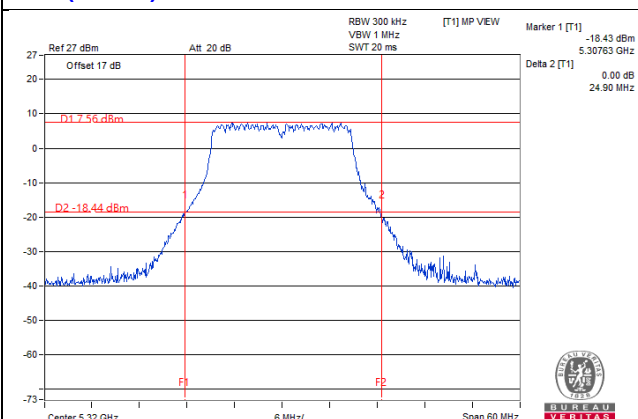

**11ac (20MHz) 1S4T CDD CH100 Chain4**

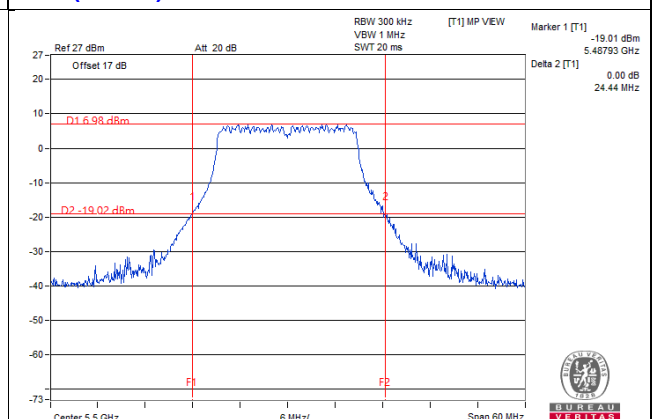

### 26dB BANDWIDTH SPECTRUM PLOT

**11ac (20MHz) 1S4T CDD CH116 Chain1**

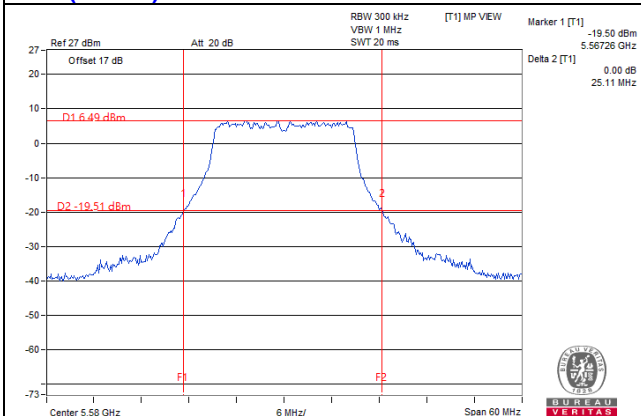

**11ac (20MHz) 1S4T CDD CH140 Chain1**

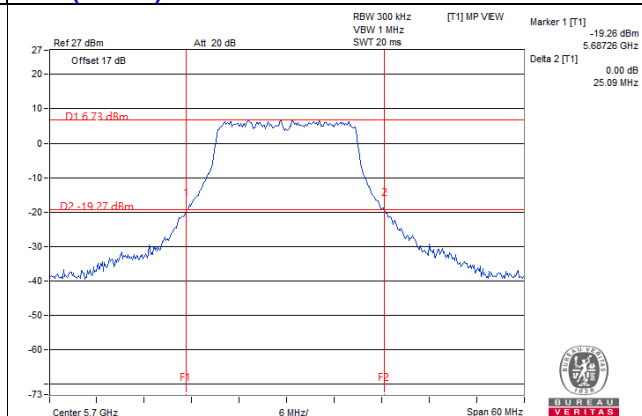

**11ac (20MHz) 1S4T CDD CH116 Chain2**

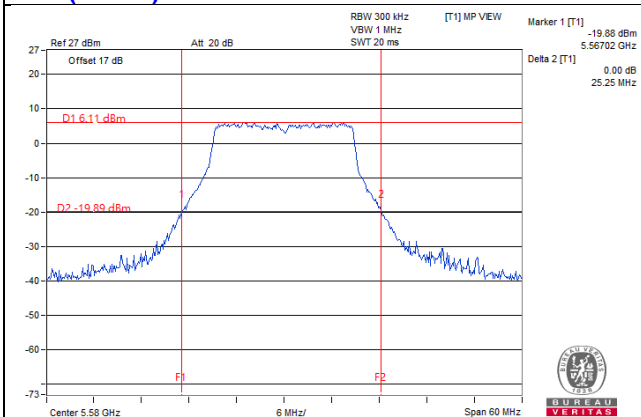

**11ac (20MHz) 1S4T CDD CH140 Chain2**

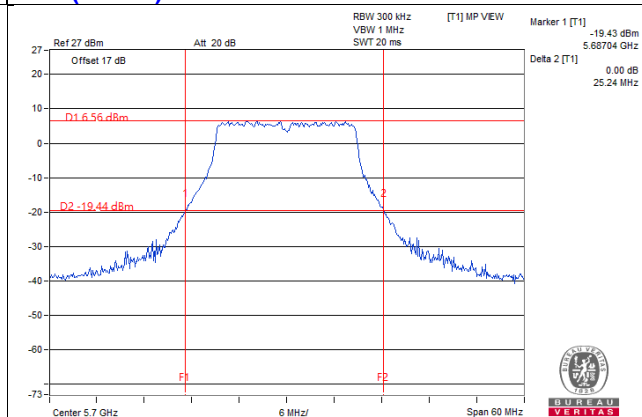

**11ac (20MHz) 1S4T CDD CH116 Chain3**

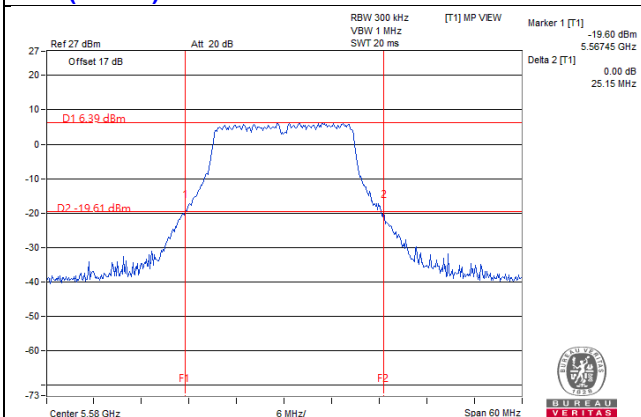

**11ac (20MHz) 1S4T CDD CH140 Chain3**

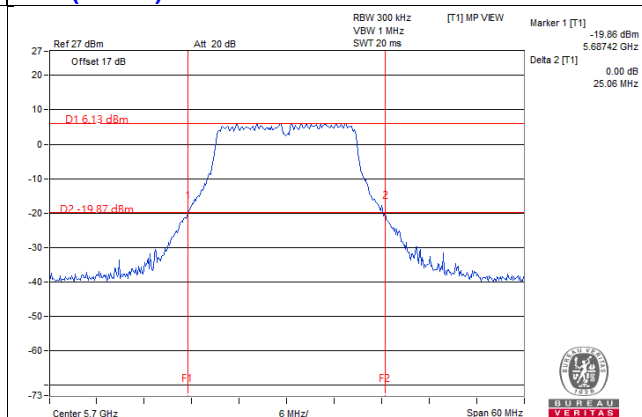

**11ac (20MHz) 1S4T CDD CH116 Chain4**

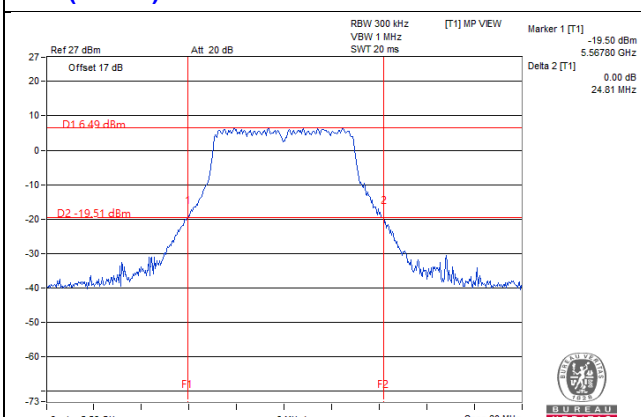

**11ac (20MHz) 1S4T CDD CH140 Chain4**

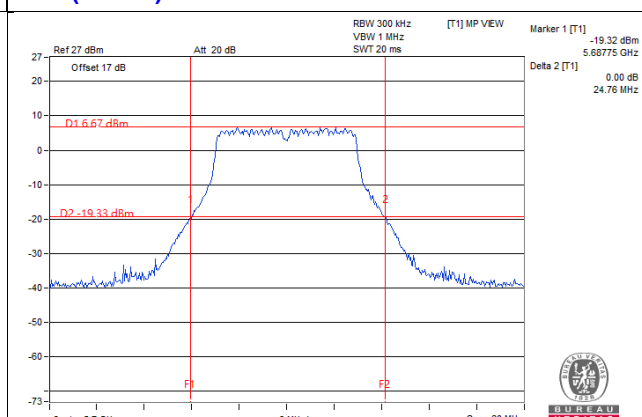

### 26dB BANDWIDTH SPECTRUM PLOT

**11ac (20MHz) 1S4T TXBF CH52 Chain1**

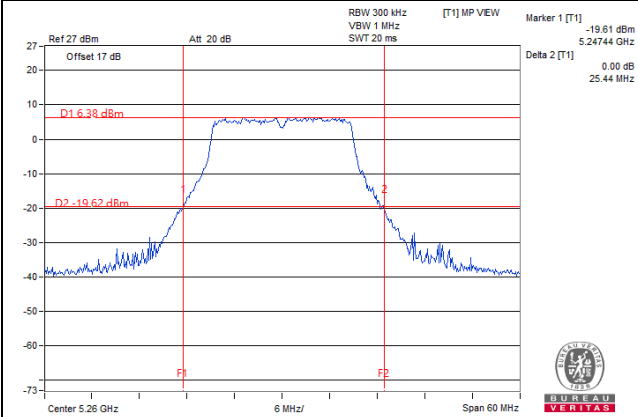

**11ac (20MHz) 1S4T TXBF CH60 Chain1**

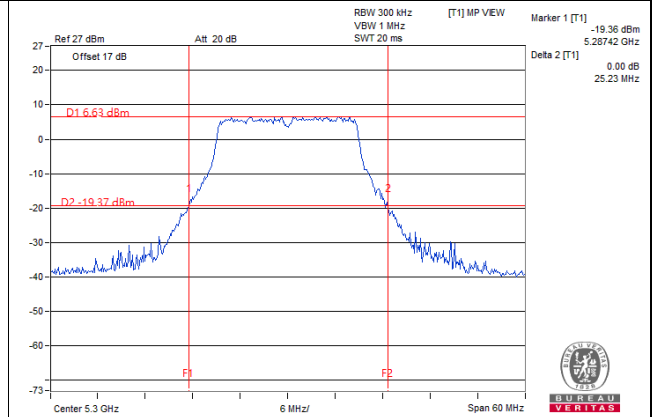

**11ac (20MHz) 1S4T TXBF CH52 Chain2**

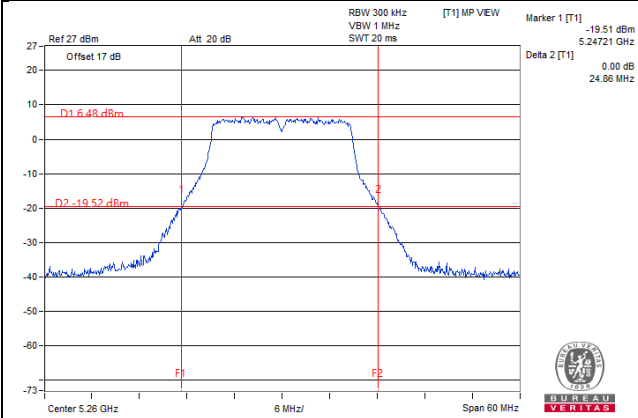

**11ac (20MHz) 1S4T TXBF CH60 Chain2**

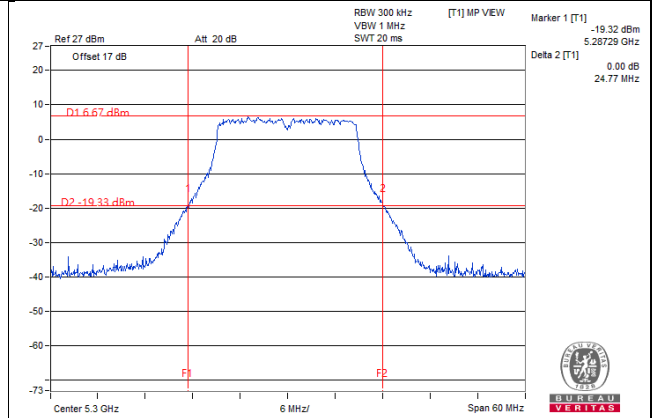

**11ac (20MHz) 1S4T TXBF CH52 Chain3**

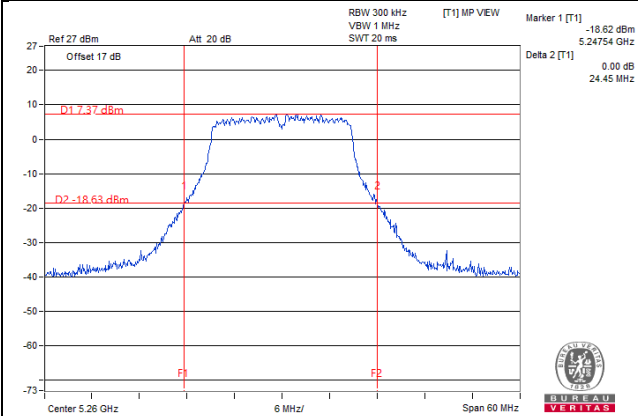

**11ac (20MHz) 1S4T TXBF CH60 Chain3**

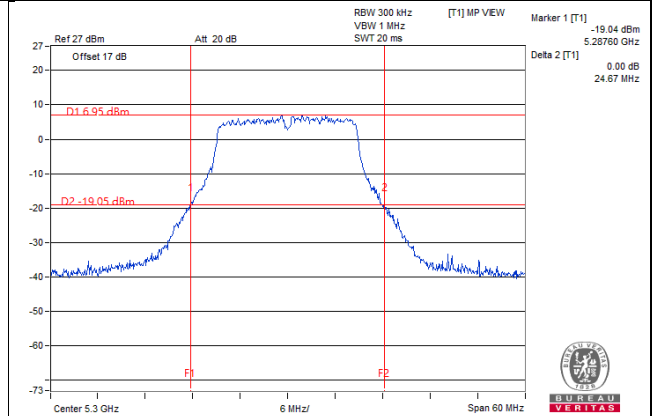

**11ac (20MHz) 1S4T TXBF CH52 Chain4**

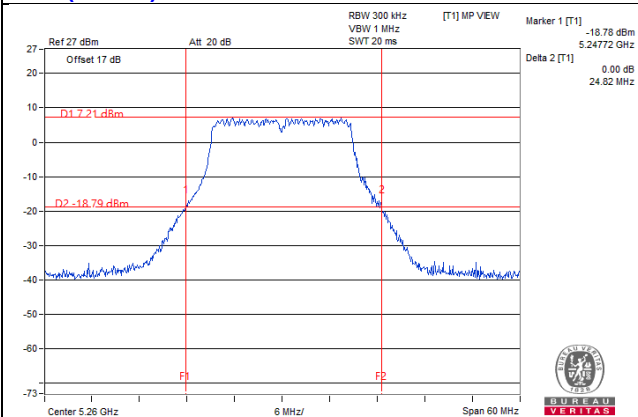

**11ac (20MHz) 1S4T TXBF CH60 Chain4**

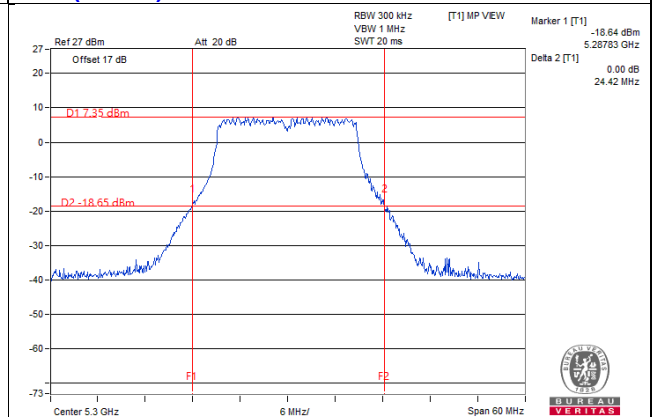

### 26dB BANDWIDTH SPECTRUM PLOT

**11ac (20MHz) 1S4T TXBF CH64 Chain1**

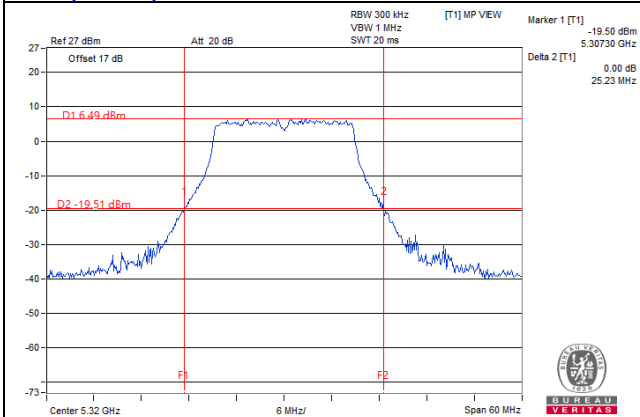

**11ac (20MHz) 1S4T TXBF CH100 Chain1**

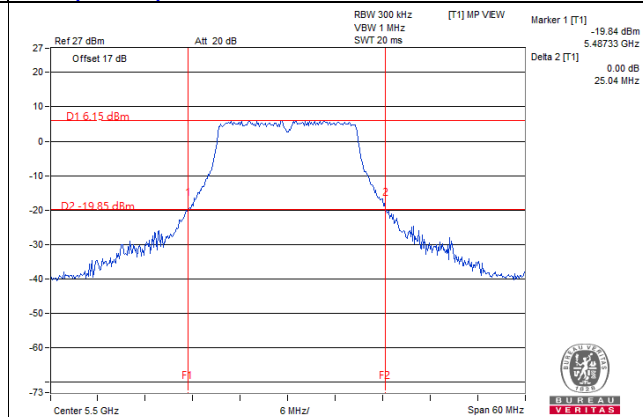

**11ac (20MHz) 1S4T TXBF CH64 Chain2**

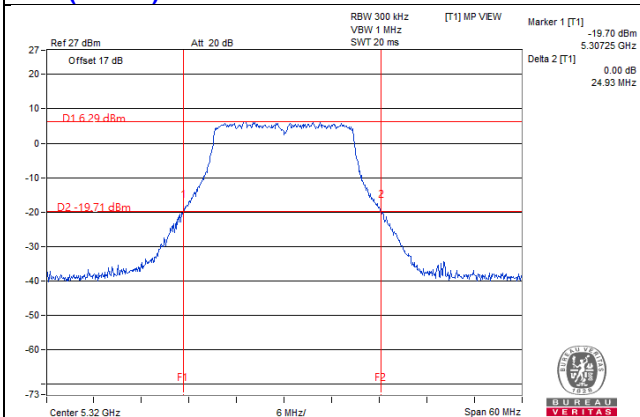

**11ac (20MHz) 1S4T TXBF CH100 Chain2**

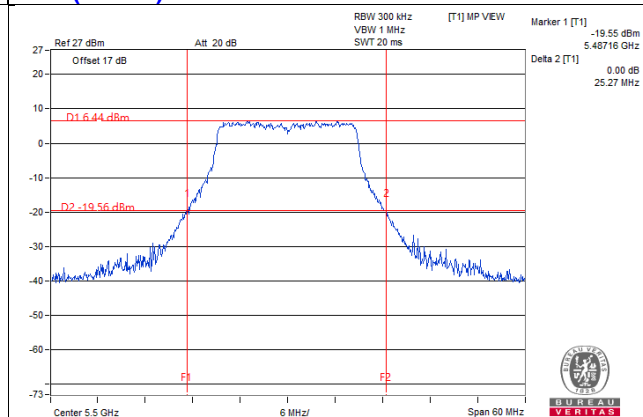

**11ac (20MHz) 1S4T TXBF CH64 Chain3**

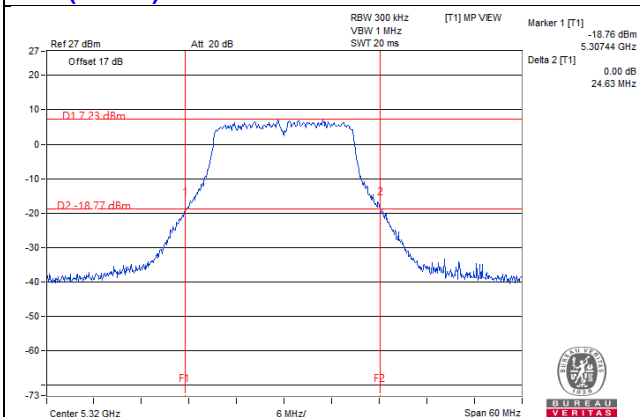

**11ac (20MHz) 1S4T TXBF CH100 Chain3**

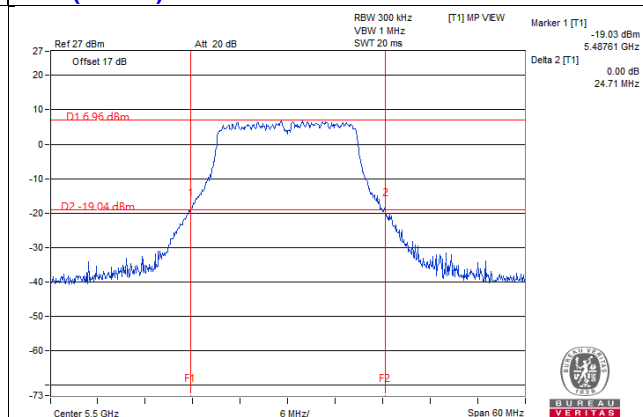

**11ac (20MHz) 1S4T TXBF CH64 Chain4**

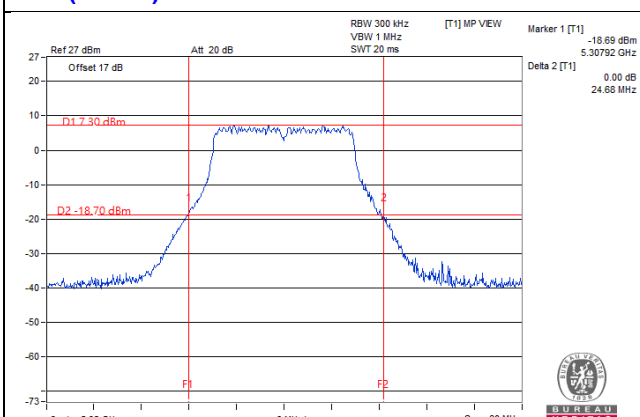

**11ac (20MHz) 1S4T TXBF CH100 Chain4**

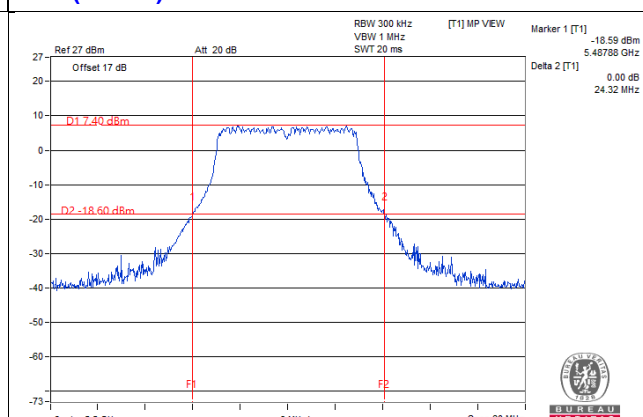

### 26dB BANDWIDTH SPECTRUM PLOT

**11ac (20MHz) 1S4T TXBF CH116 Chain1**

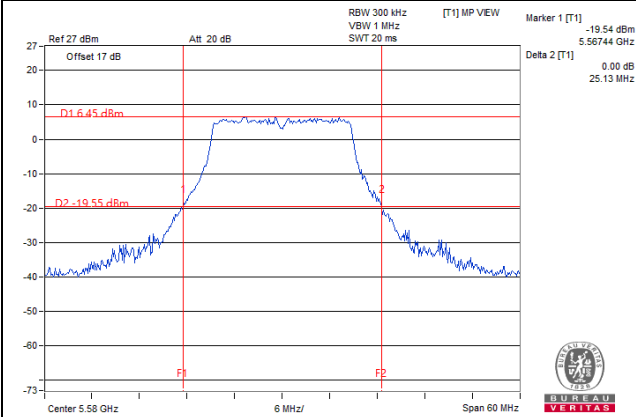

**11ac (20MHz) 1S4T TXBF CH140 Chain1**

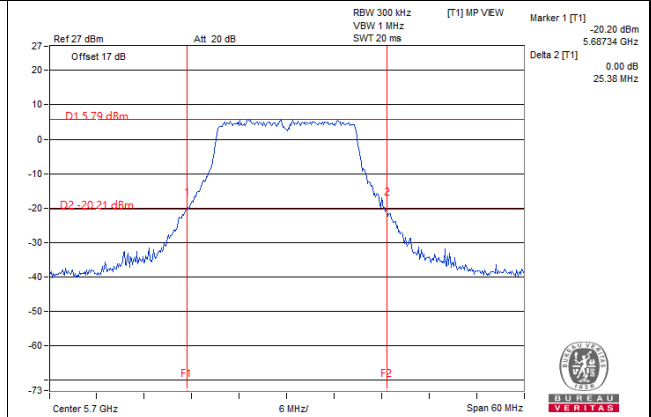

**11ac (20MHz) 1S4T TXBF CH116 Chain2**

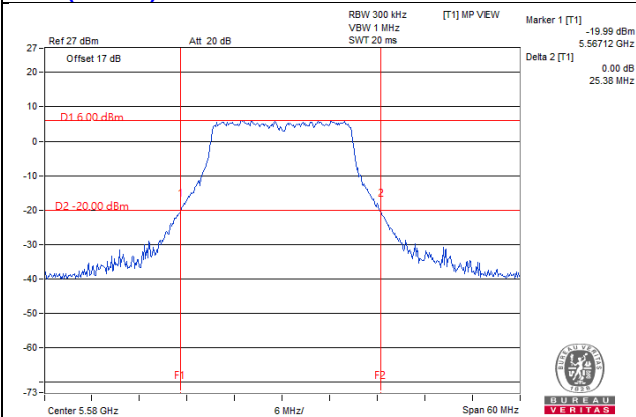

**11ac (20MHz) 1S4T TXBF CH140 Chain2**

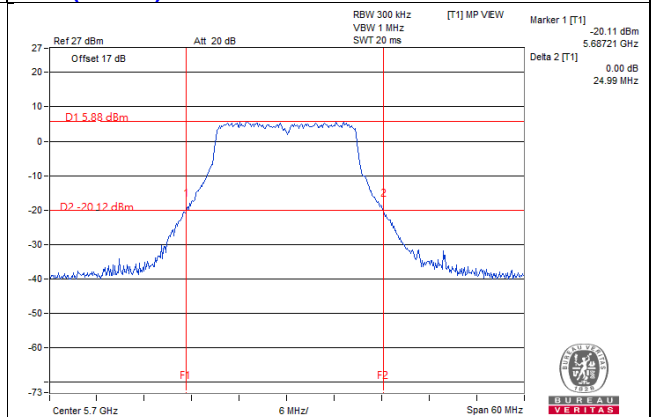

**11ac (20MHz) 1S4T TXBF CH116 Chain3**

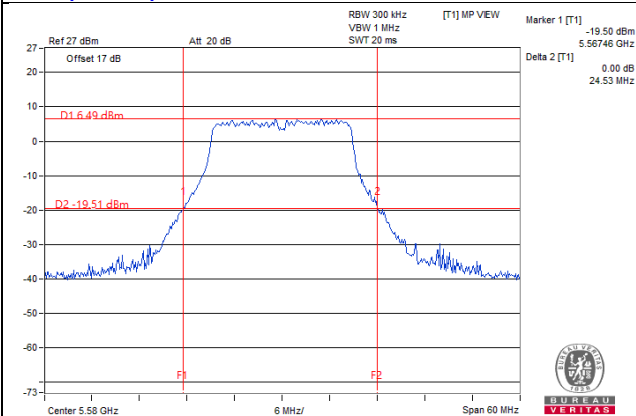

**11ac (20MHz) 1S4T TXBF CH140 Chain3**

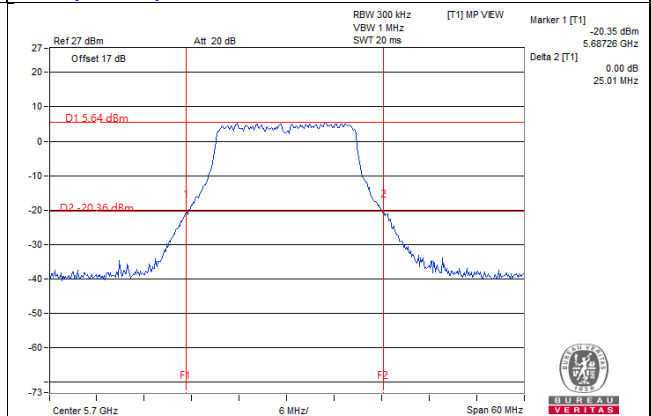

**11ac (20MHz) 1S4T TXBF CH116 Chain4**

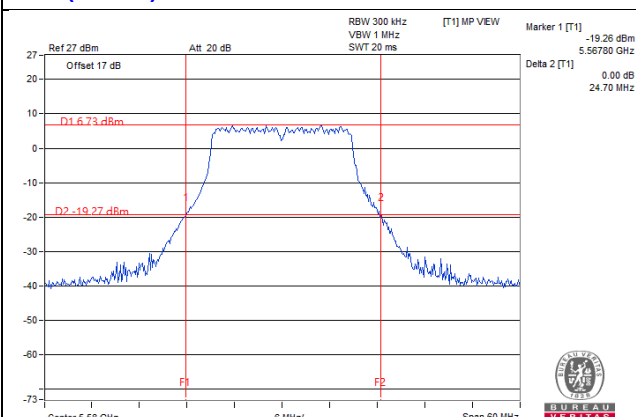

**11ac (20MHz) 1S4T TXBF CH140 Chain4**

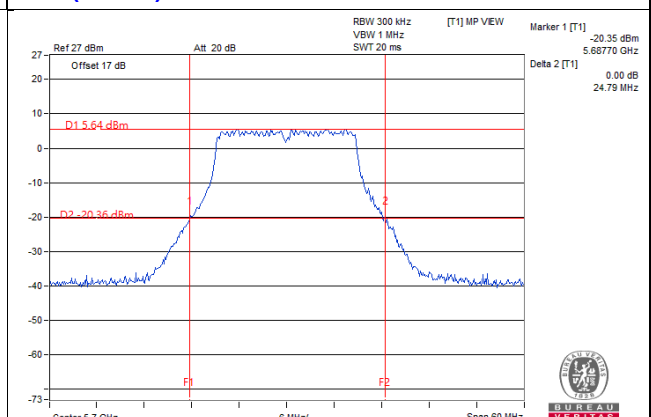

## 26dB BANDWIDTH SPECTRUM PLOT

### 11ac (40MHz) 1S4T CDD CH54 Chain1

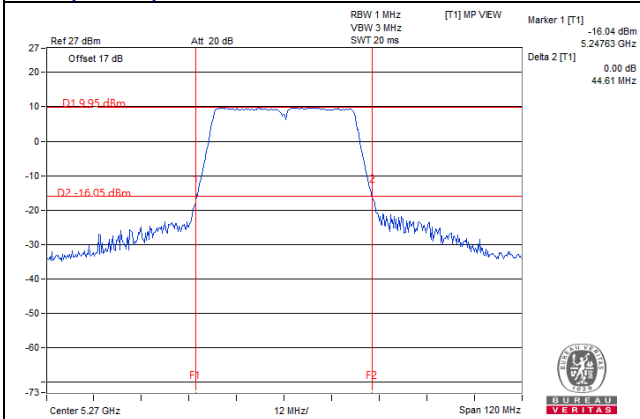

### 11ac (40MHz) 1S4T CDD CH62 Chain1

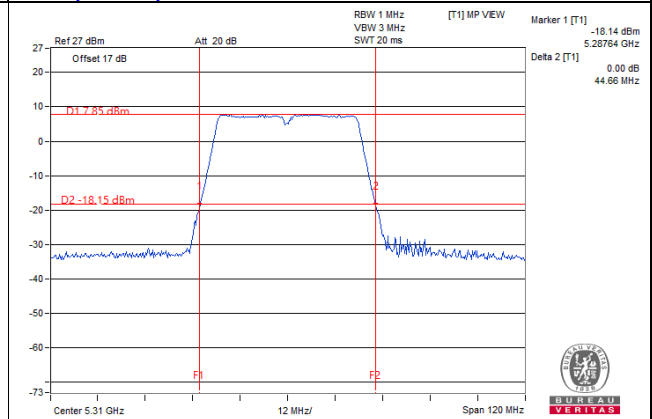

### 11ac (40MHz) 1S4T CDD CH54 Chain2

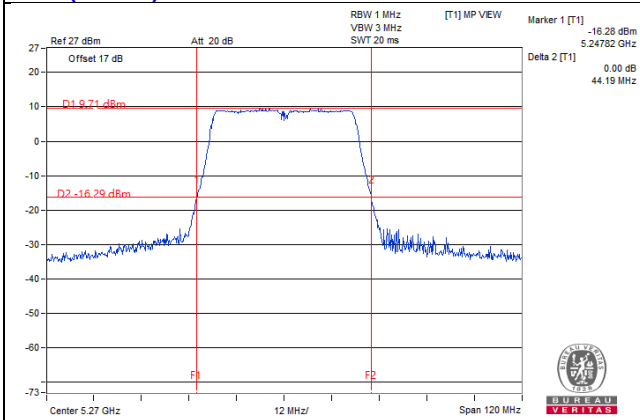

### 11ac (40MHz) 1S4T CDD CH62 Chain2

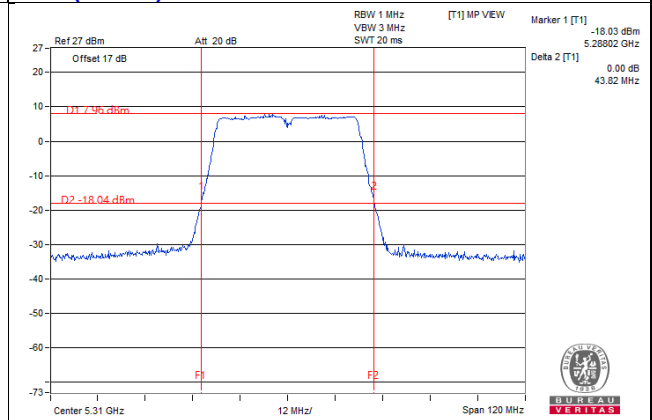

### 11ac (40MHz) 1S4T CDD CH54 Chain3

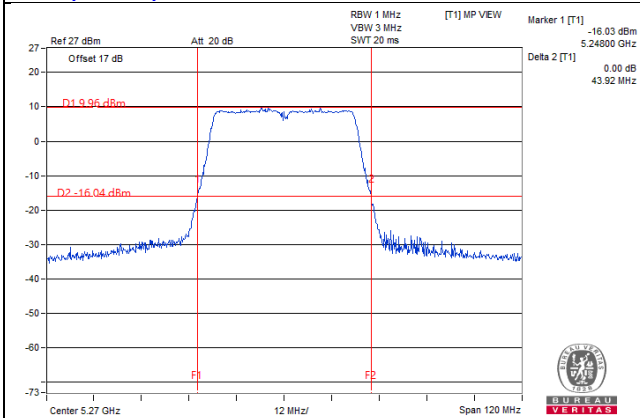

### 11ac (40MHz) 1S4T CDD CH62 Chain3

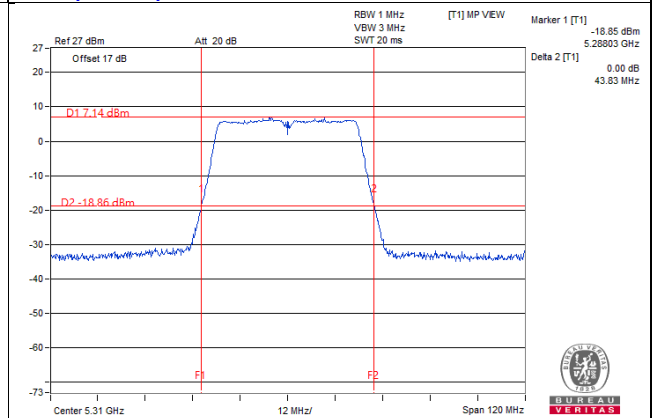

### 11ac (40MHz) 1S4T CDD CH54 Chain4

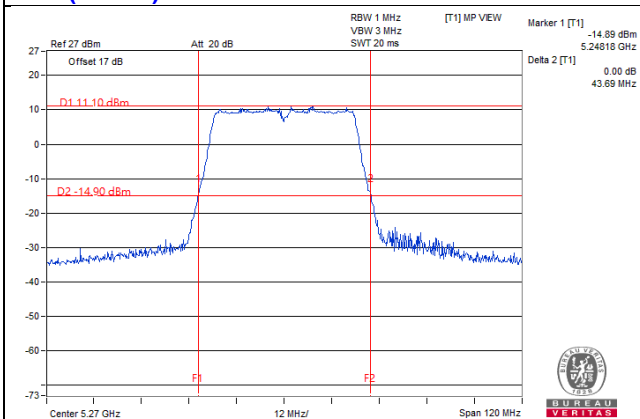

### 11ac (40MHz) 1S4T CDD CH62 Chain4

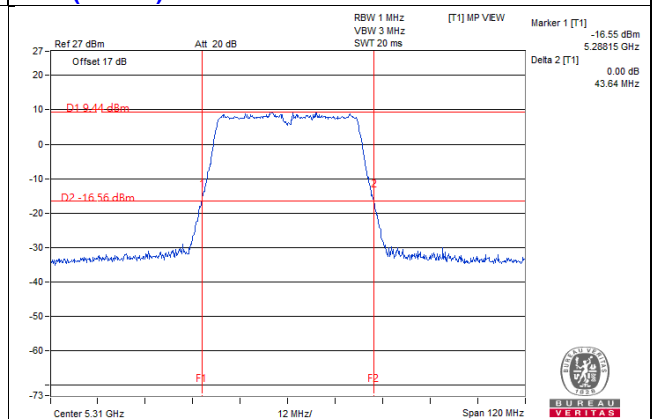

### 26dB BANDWIDTH SPECTRUM PLOT

**11ac (40MHz) 1S4T CDD CH102 Chain1**

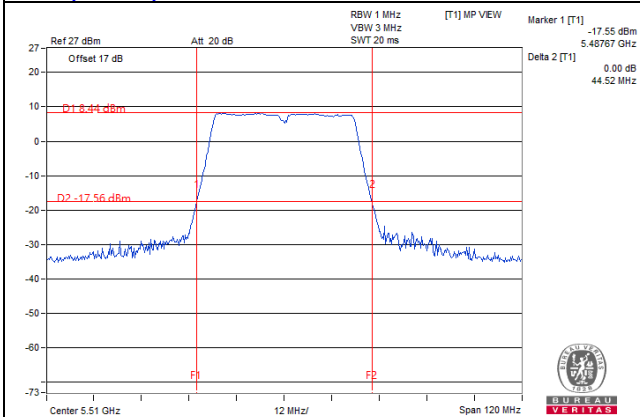

**11ac (40MHz) 1S4T CDD CH110 Chain1**

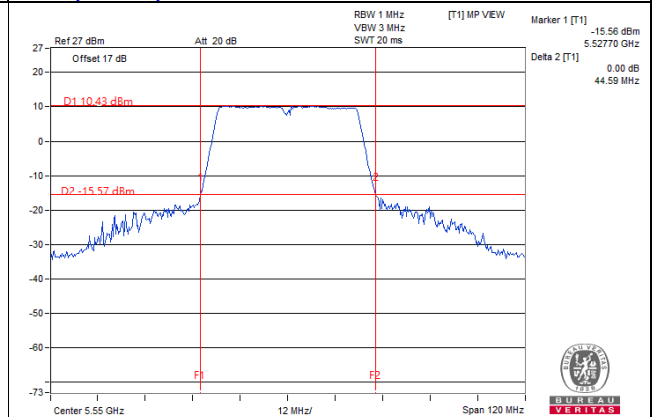

**11ac (40MHz) 1S4T CDD CH102 Chain2**

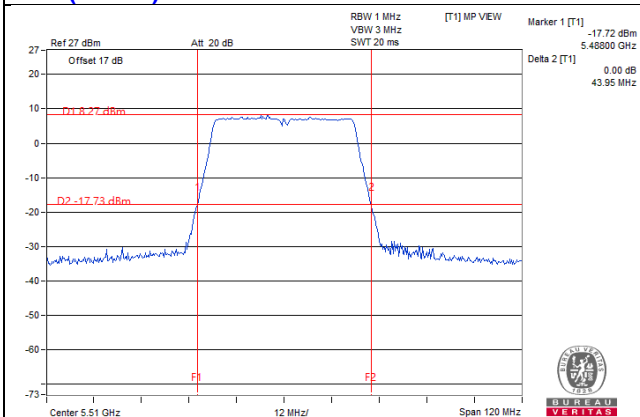

**11ac (40MHz) 1S4T CDD CH110 Chain2**

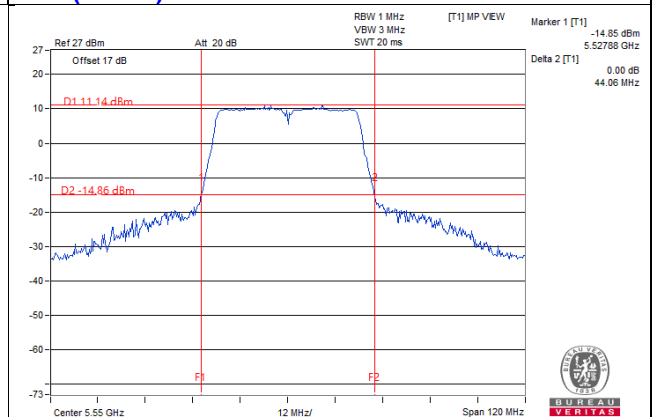

**11ac (40MHz) 1S4T CDD CH102 Chain3**

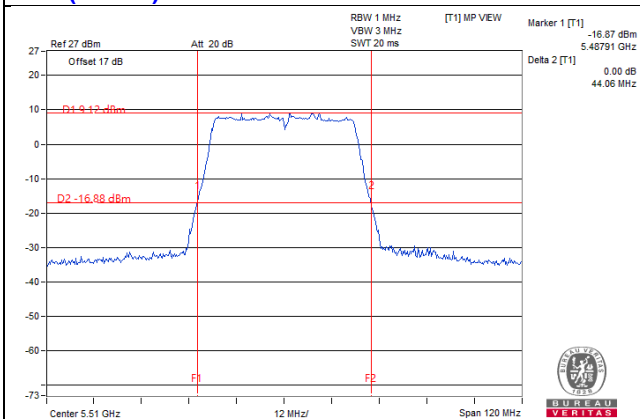

**11ac (40MHz) 1S4T CDD CH110 Chain3**

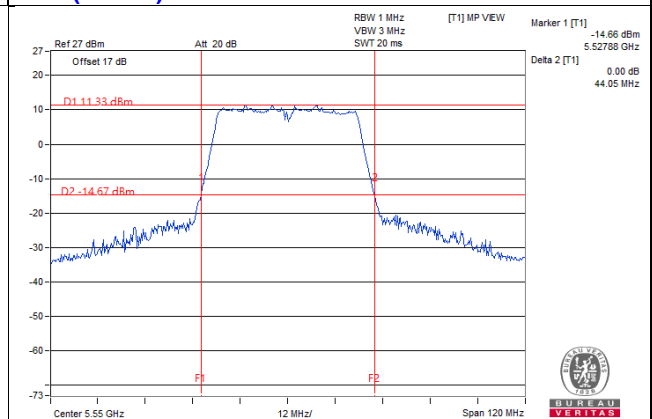

**11ac (40MHz) 1S4T CDD CH102 Chain4**

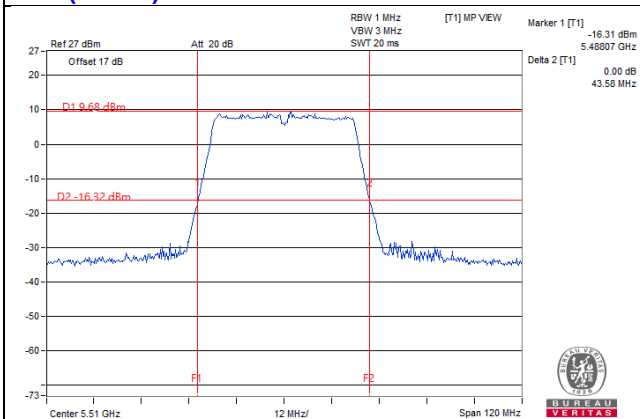

**11ac (40MHz) 1S4T CDD CH110 Chain4**

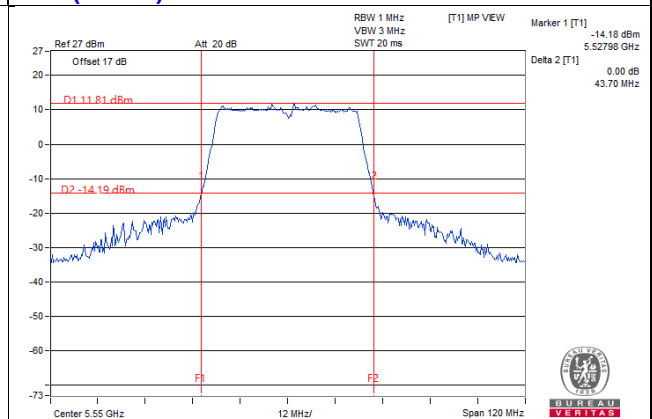



## 26dB BANDWIDTH SPECTRUM PLOT

### 11ac (40MHz) 1S4T CDD CH134 Chain1

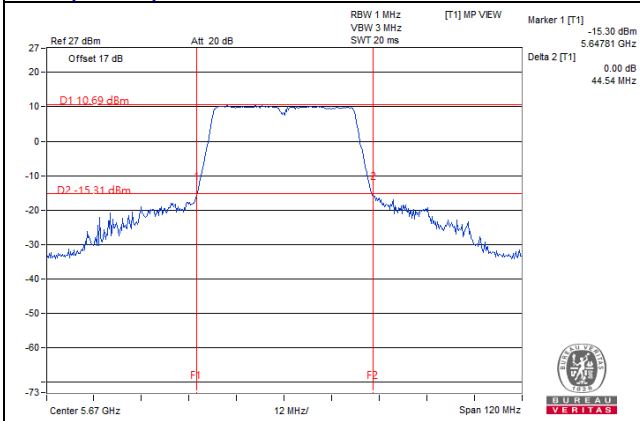

### 11ac (40MHz) 1S4T CDD CH134 Chain2

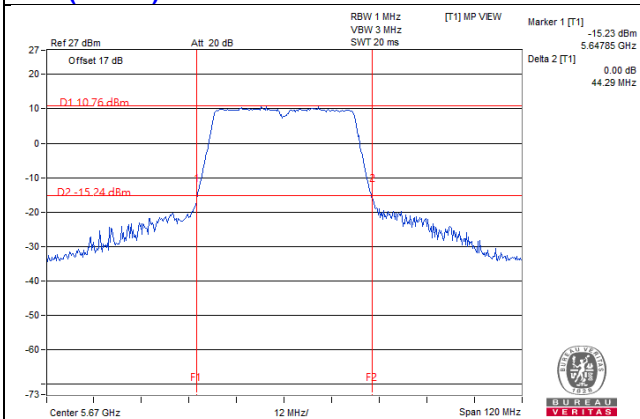

### 11ac (40MHz) 1S4T CDD CH134 Chain3

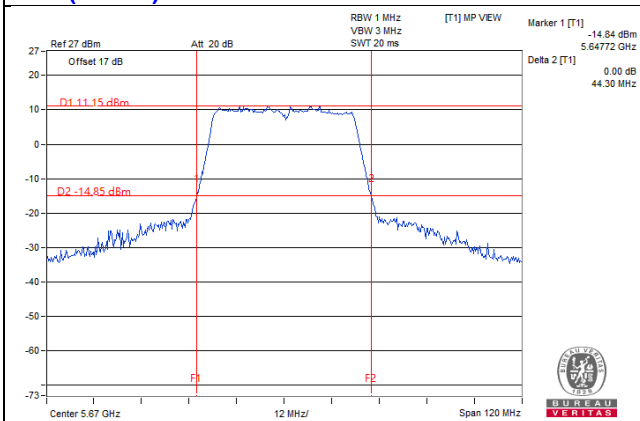

### 11ac (40MHz) 1S4T CDD CH134 Chain4

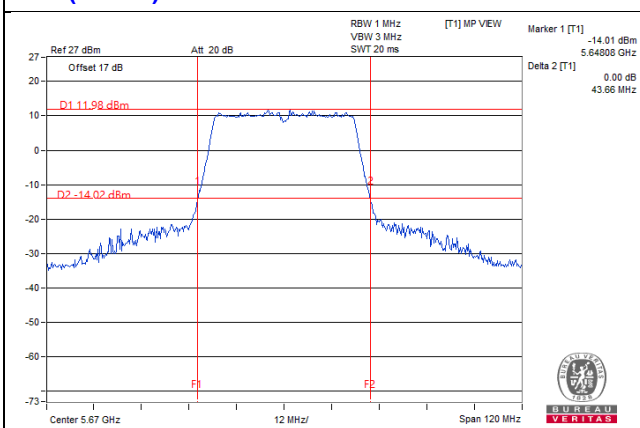

### 26dB BANDWIDTH SPECTRUM PLOT

**11ac (40MHz) 1S4T TxBF CH54 Chain1**

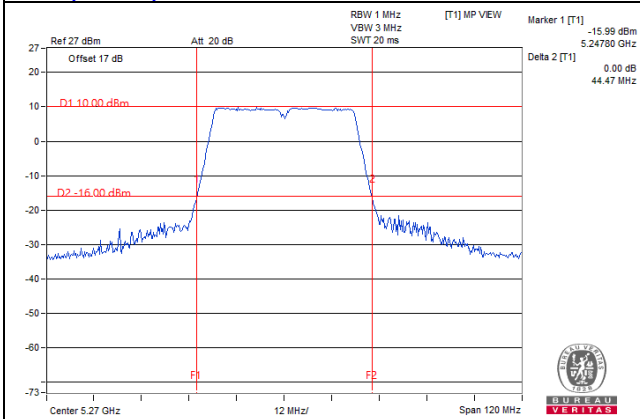

**11ac (40MHz) 1S4T TxBF CH62 Chain1**

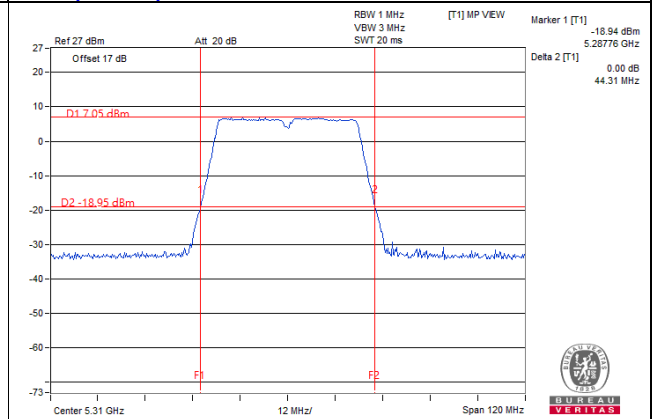

**11ac (40MHz) 1S4T TxBF CH54 Chain2**

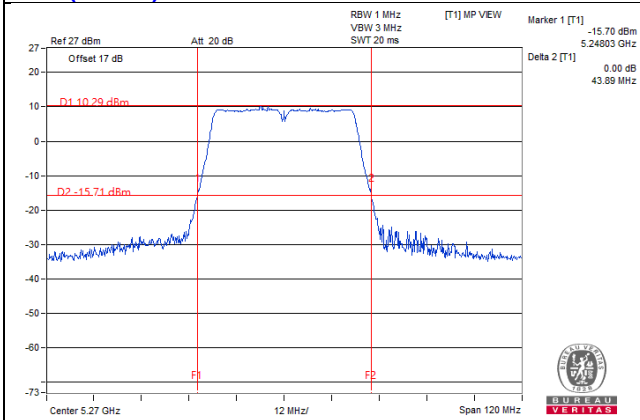

**11ac (40MHz) 1S4T TxBF CH62 Chain2**

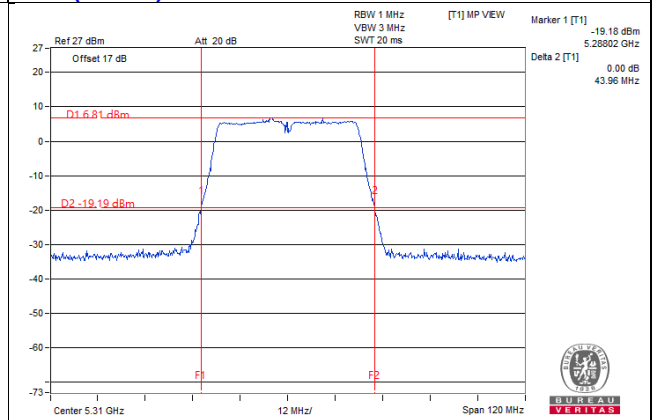

**11ac (40MHz) 1S4T TxBF CH54 Chain3**

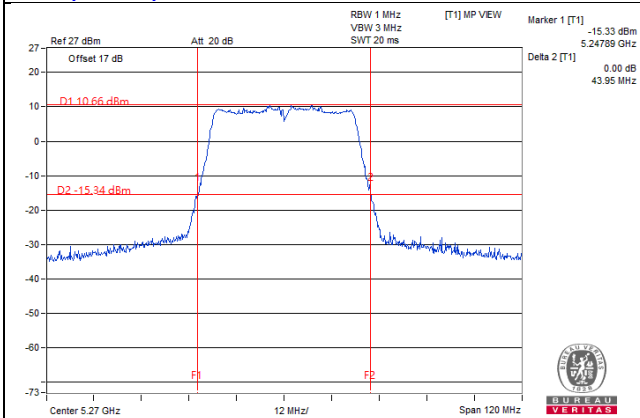

**11ac (40MHz) 1S4T TxBF CH62 Chain3**

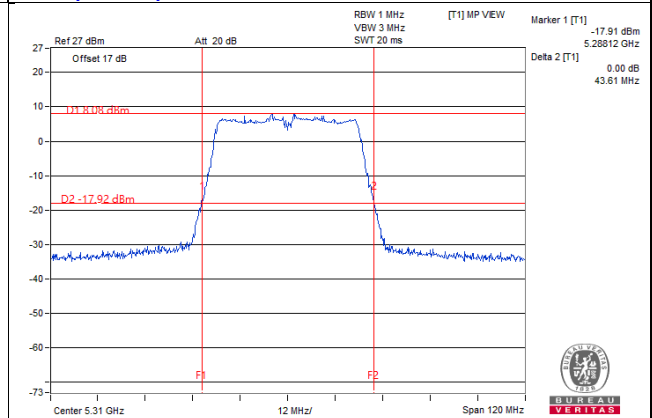

**11ac (40MHz) 1S4T TxBF CH54 Chain4**

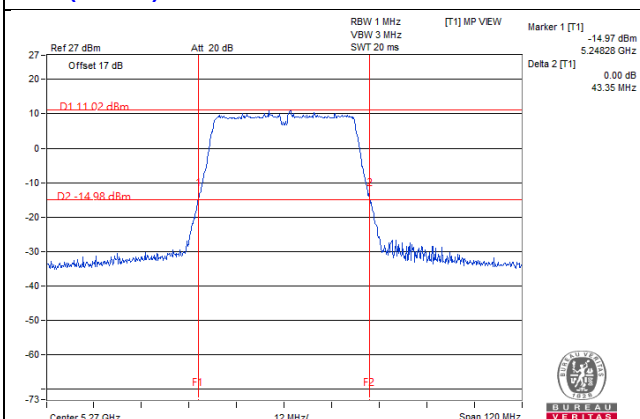

**11ac (40MHz) 1S4T TxBF CH62 Chain4**

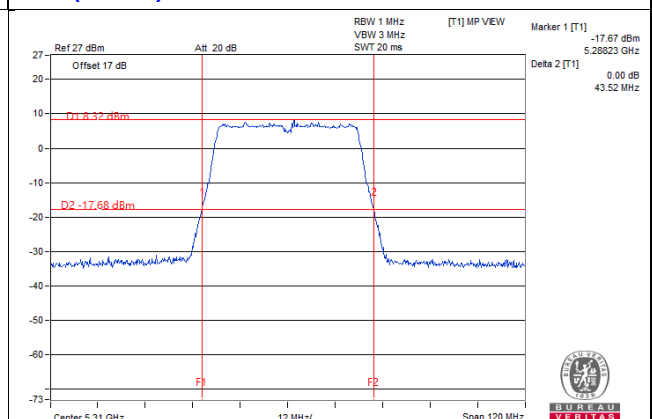

## 26dB BANDWIDTH SPECTRUM PLOT

### 11ac (40MHz) 1S4T TxBF CH102 Chain1

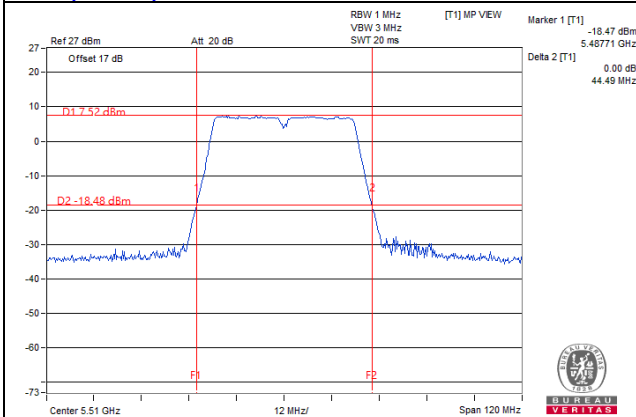

### 11ac (40MHz) 1S4T TxBF CH110 Chain1

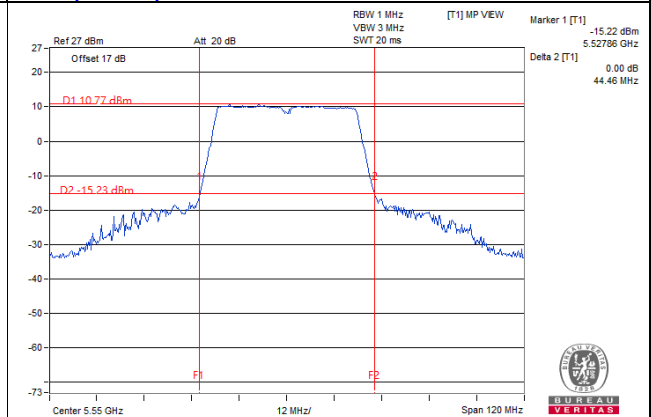

### 11ac (40MHz) 1S4T TxBF CH102 Chain2

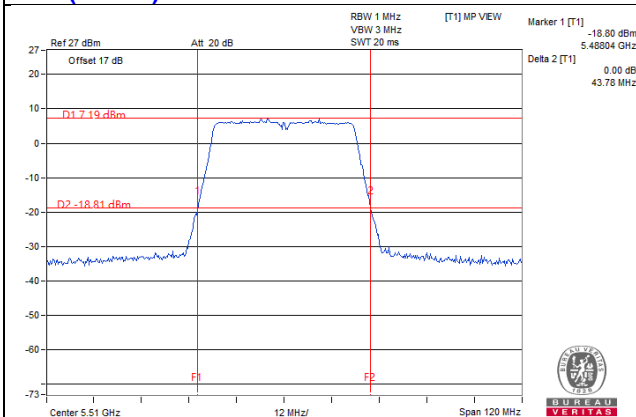

### 11ac (40MHz) 1S4T TxBF CH110 Chain2

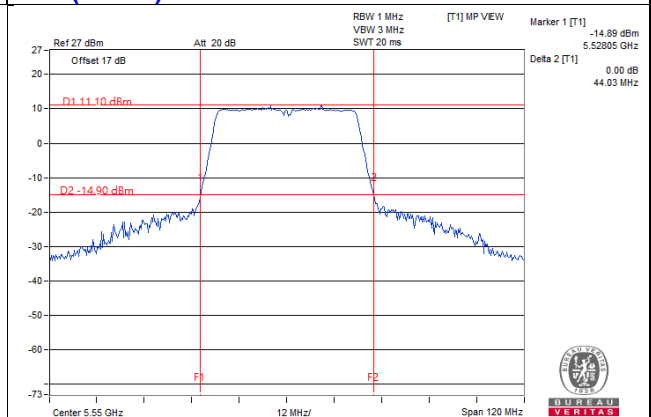

### 11ac (40MHz) 1S4T TxBF CH102 Chain3

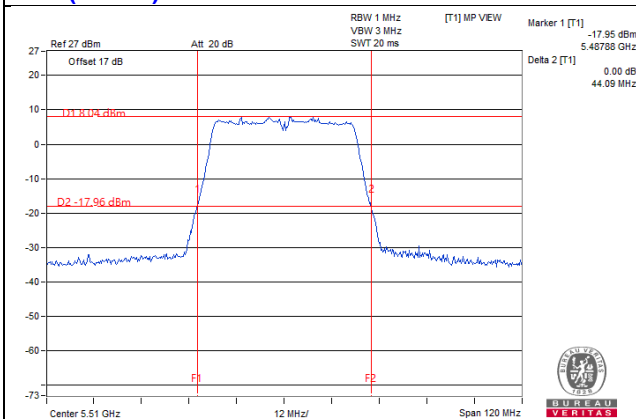

### 11ac (40MHz) 1S4T TxBF CH110 Chain3

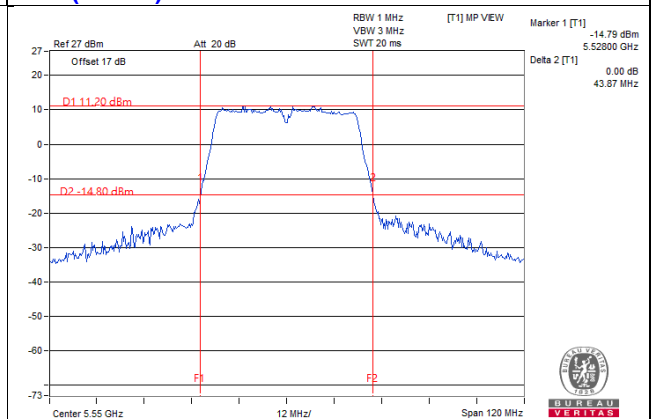

### 11ac (40MHz) 1S4T TxBF CH102 Chain4

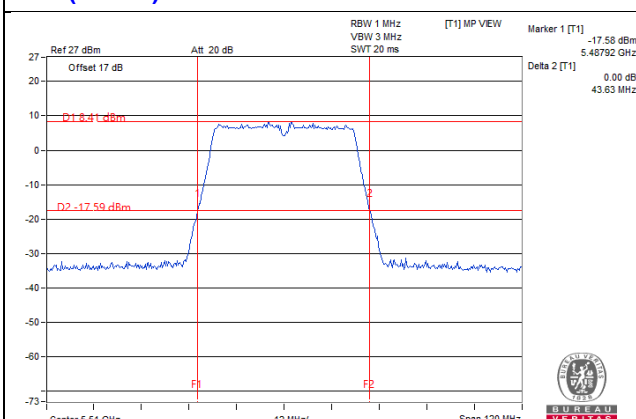

### 11ac (40MHz) 1S4T TxBF CH110 Chain4

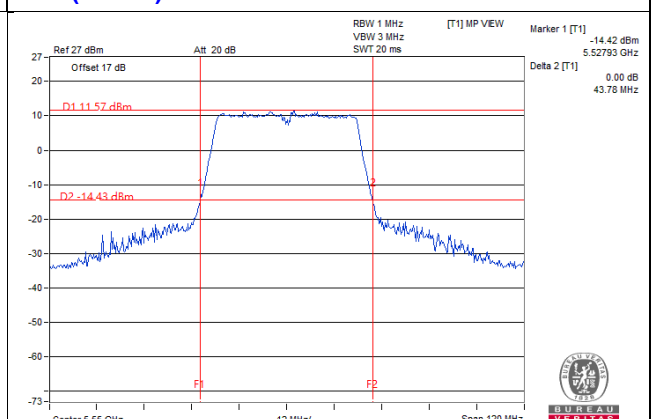

## 26dB BANDWIDTH SPECTRUM PLOT

### 11ac (40MHz) 1S4T TxBF CH134 Chain1

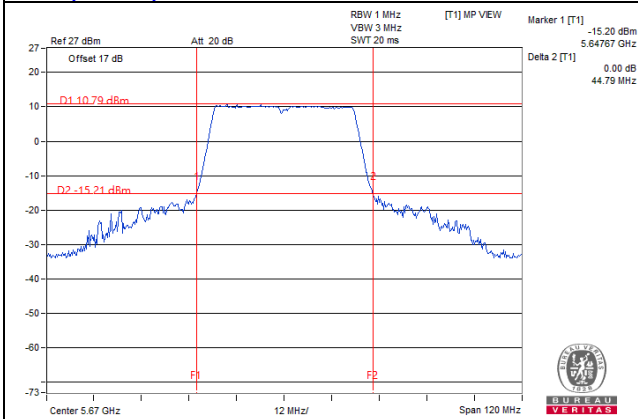

### 11ac (40MHz) 1S4T TxBF CH134 Chain2

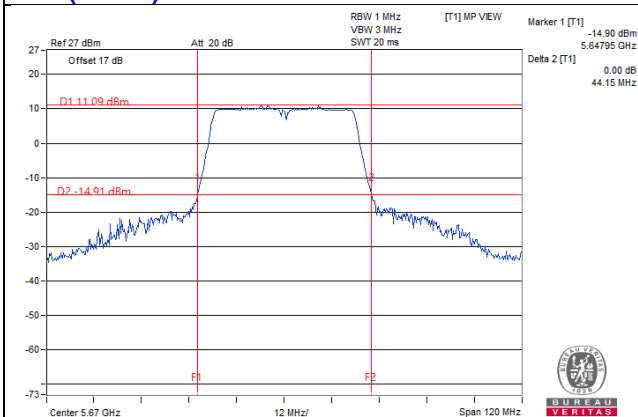

### 11ac (40MHz) 1S4T TxBF CH134 Chain3

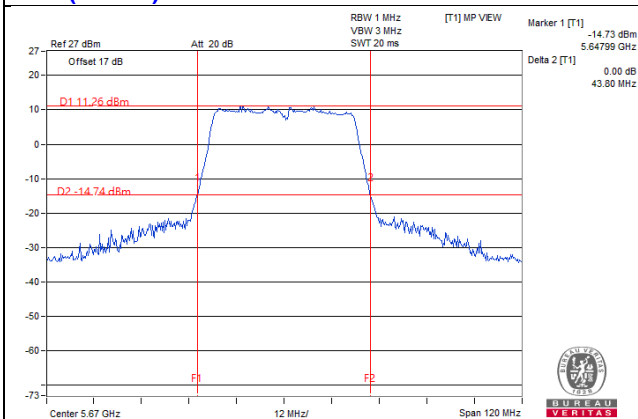

### 11ac (40MHz) 1S4T TxBF CH134 Chain4

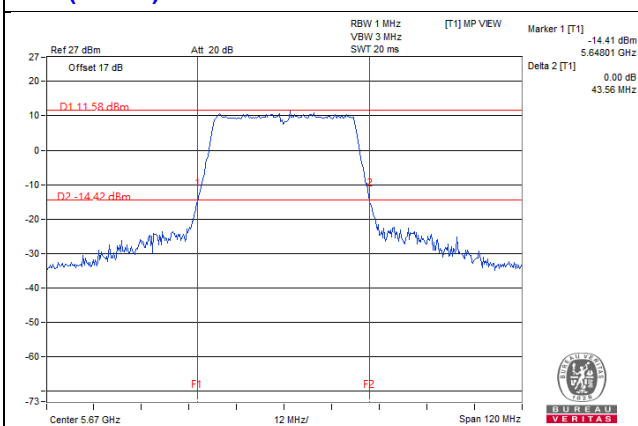

### 26dB BANDWIDTH SPECTRUM PLOT

**11ac (80MHz) 1S4T CDD CH58 Chain1**

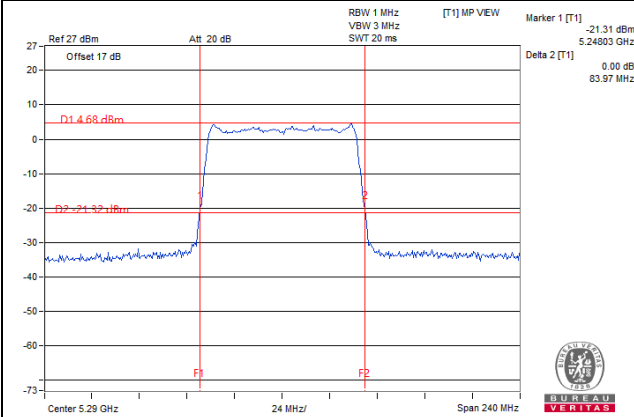

**11ac (80MHz) 1S4T CDD CH106 Chain1**

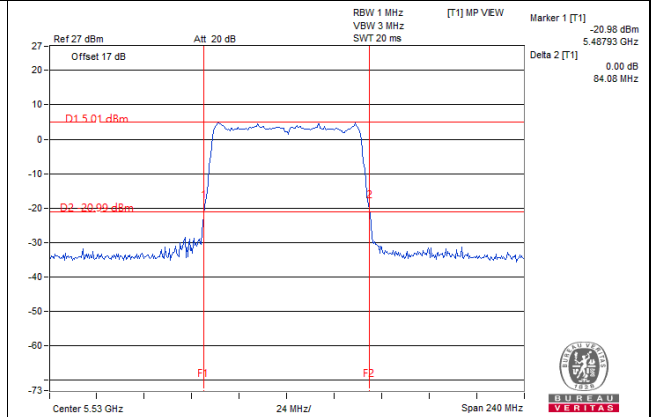

**11ac (80MHz) 1S4T CDD CH58 Chain2**

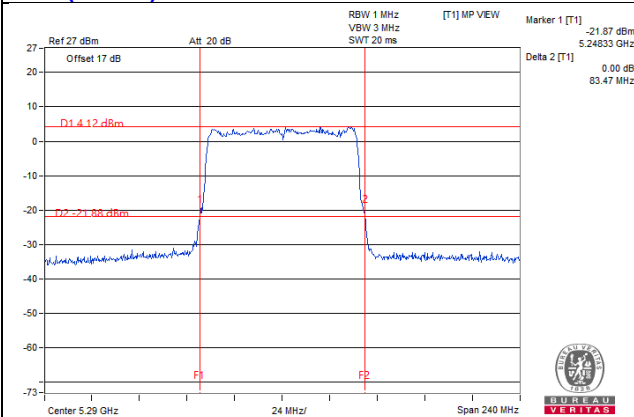

**11ac (80MHz) 1S4T CDD CH106 Chain2**

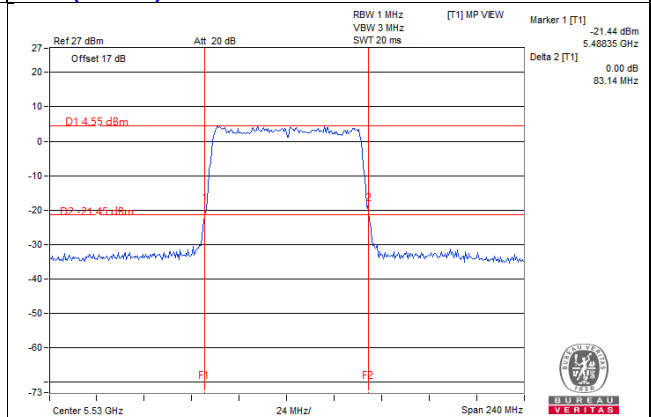

**11ac (80MHz) 1S4T CDD CH58 Chain3**

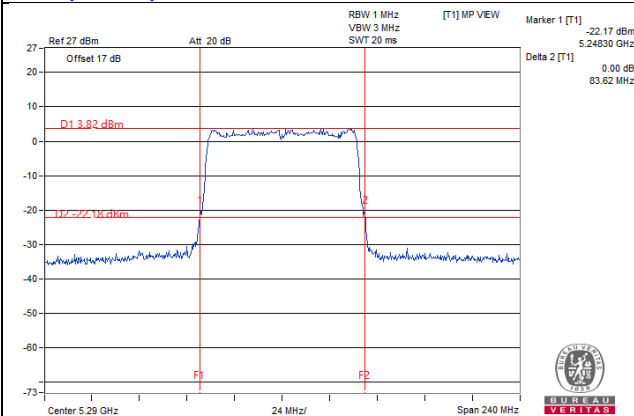

**11ac (80MHz) 1S4T CDD CH106 Chain3**

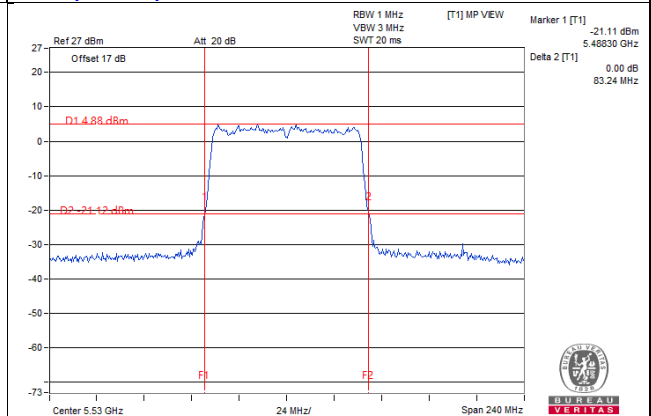

**11ac (80MHz) 1S4T CDD CH58 Chain4**

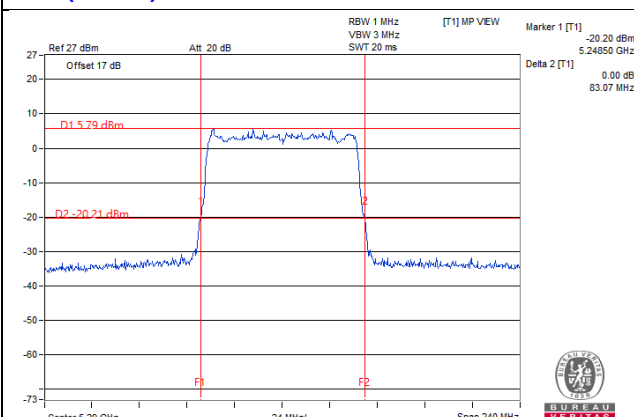

**11ac (80MHz) 1S4T CDD CH106 Chain4**

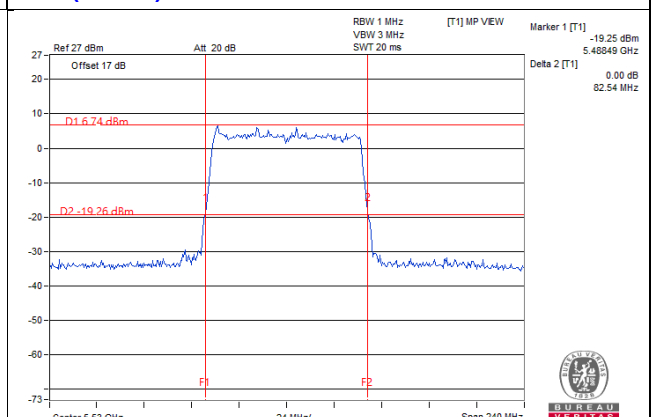

### 26dB BANDWIDTH SPECTRUM PLOT

**11ac (80MHz) 1S4T TxBF CH58 Chain1**

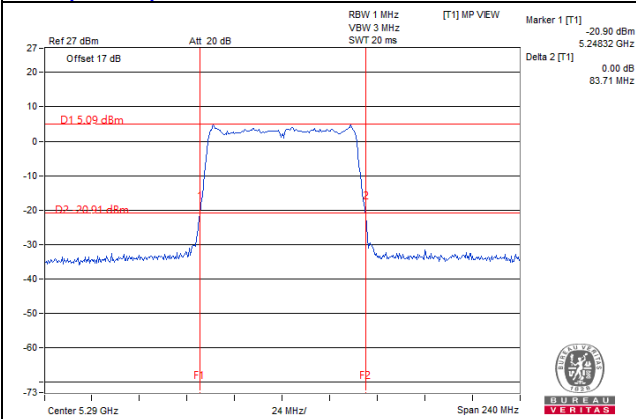

**11ac (80MHz) 1S4T TxBF CH106 Chain1**

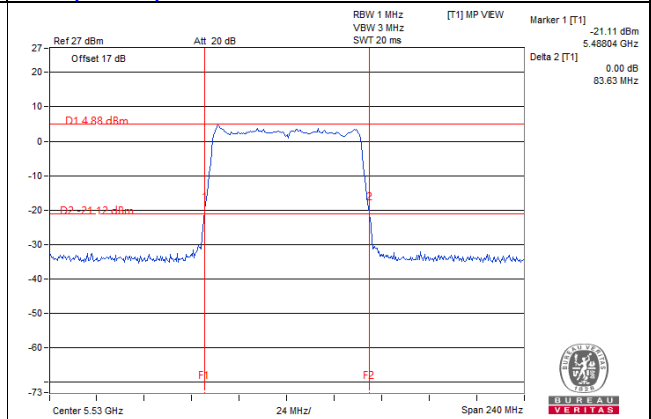

**11ac (80MHz) 1S4T TxBF CH58 Chain2**

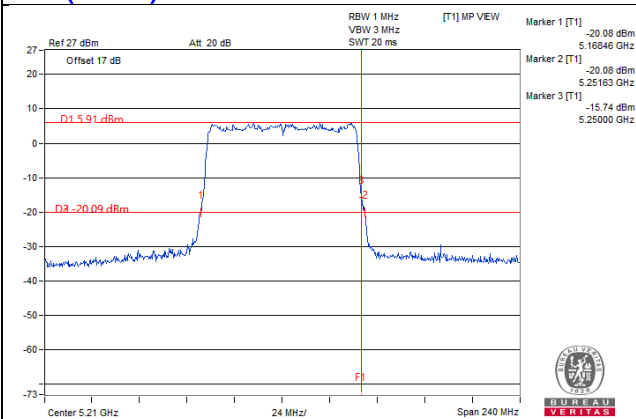

**11ac (80MHz) 1S4T TxBF CH106 Chain2**

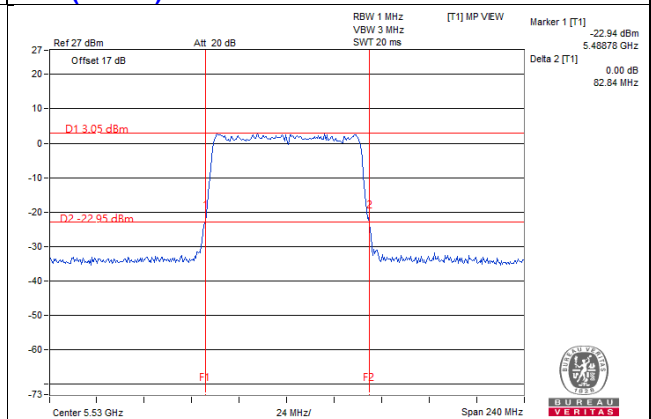

**11ac (80MHz) 1S4T TxBF CH58 Chain3**

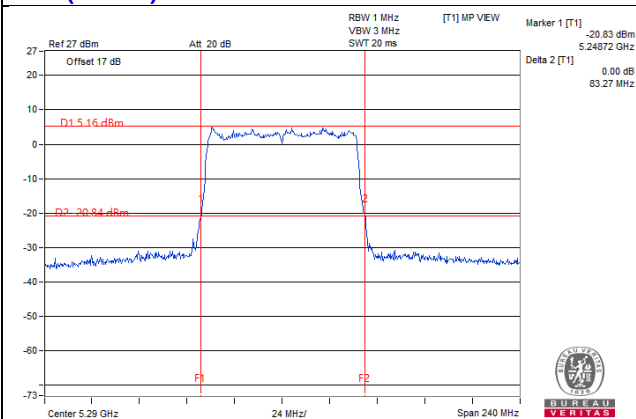

**11ac (80MHz) 1S4T TxBF CH106 Chain3**

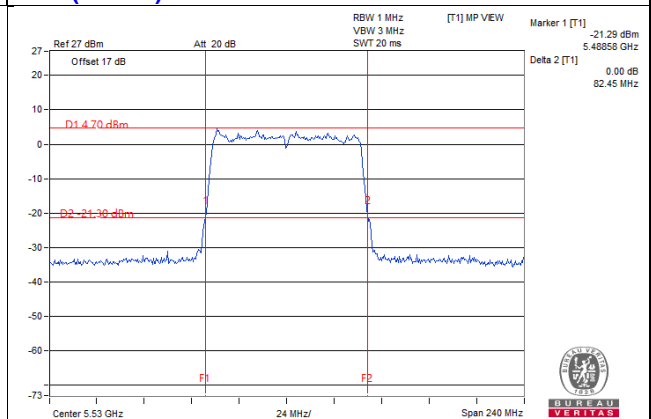

**11ac (80MHz) 1S4T TxBF CH58 Chain4**

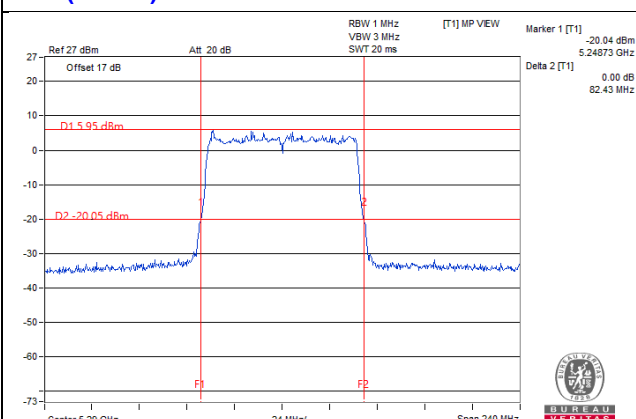

**11ac (80MHz) 1S4T TxBF CH106 Chain4**

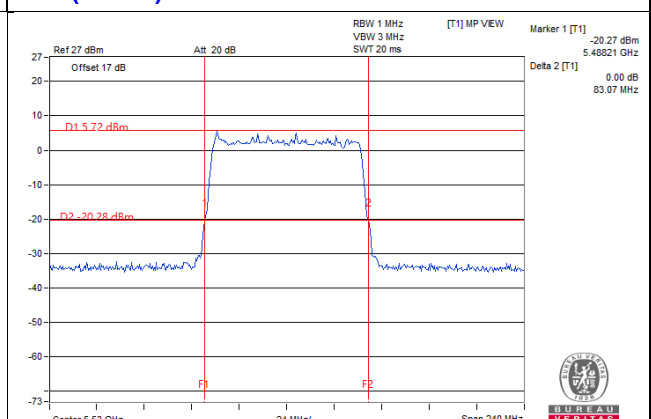

11a 1S4T CDD

CHANNEL	FREQUENCY (MHz)	99% Occupied Bandwidth (MHz)			
		CHAIN 1	CHAIN 2	CHAIN 3	CHAIN 4
52	5260	18.48	18.61	18.61	18.69
60	5300	18.36	18.7	18.61	18.69
64	5320	18.36	18.61	18.61	18.61
100	5500	18.48	18.61	18.34	18.69
116	5580	18.02	18.04	18.02	18.02
140	5700	18.48	18.84	18.36	18.6

11ac (20MHz) 1S4T CDD

CHANNEL	FREQUENCY (MHz)	99% Occupied Bandwidth (MHz)			
		CHAIN 1	CHAIN 2	CHAIN 3	CHAIN 4
52	5260	19.56	19.91	19.65	19.39
60	5300	19.8	19.65	19.74	19.39
64	5320	19.8	19.57	19.65	19.39
100	5500	19.8	19.92	19.56	19.39
116	5580	18.24	18.36	18.12	18.12
140	5700	19.8	19.68	19.56	19.32

11ac (20MHz) 1S4T TxBF

CHANNEL	FREQUENCY (MHz)	99% Occupied Bandwidth (MHz)			
		CHAIN 1	CHAIN 2	CHAIN 3	CHAIN 4
52	5260	19.8	19.57	19.48	19.48
60	5300	19.8	19.65	19.48	19.48
64	5320	19.8	19.74	19.56	19.31
100	5500	19.92	19.74	19.4	19.39
116	5580	18.36	18.24	18.24	18.12
140	5700	19.92	19.8	19.68	19.44

11ac (40MHz) 1S4T CDD

CHANNEL	FREQUENCY (MHz)	99% Occupied Bandwidth (MHz)			
		CHAIN 1	CHAIN 2	CHAIN 3	CHAIN 4
54	5270	37.2	36.86	37.04	36.69
62	5310	36.72	36.86	37.04	36.69
102	5510	37.2	36.72	37.2	36.96
110	5550	37.2	37.2	37.2	36.96
134	5670	37.2	36.96	36.96	36.96

11ac (40MHz) 1S4T TxBF

CHANNEL	FREQUENCY (MHz)	99% Occupied Bandwidth (MHz)			
		CHAIN 1	CHAIN 2	CHAIN 3	CHAIN 4
54	5270	37.2	36.86	37.04	36.69
62	5310	36.96	37.04	37.04	36.69
102	5510	37.2	36.96	37.2	36.72
110	5550	37.2	37.2	37.2	36.96
134	5670	37.2	37.2	36.96	36.72

11ac (80MHz) 1S4T CDD

CHANNEL	FREQUENCY (MHz)	99% Occupied Bandwidth (MHz)			
		CHAIN 1	CHAIN 2	CHAIN 3	CHAIN 4
58	5290	75.36	75.48	75.48	75.48
106	5530	75.36	75.36	75.36	75.36

11ac (80MHz) 1S4T TxBF

CHANNEL	FREQUENCY (MHz)	99% Occupied Bandwidth (MHz)			
		CHAIN 1	CHAIN 2	CHAIN 3	CHAIN 4
58	5290	75.36	75.48	75.48	75.48
106	5530	75.36	75.36	75.36	75.36



### 99% OCCUPIED BANDWIDTH SPECTRUM PLOT

#### 11a 1S4T CDD CH52 Chain1

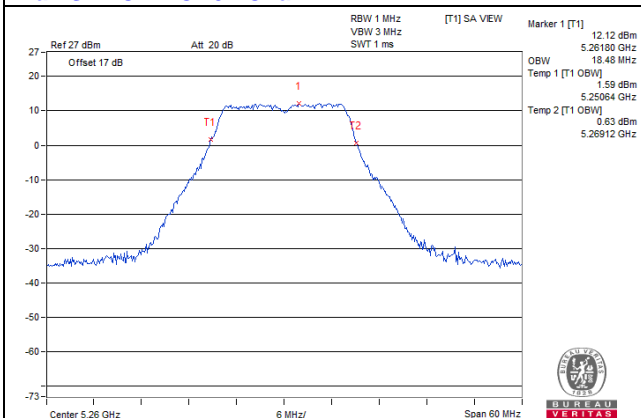

#### 11a 1S4T CDD CH60 Chain1

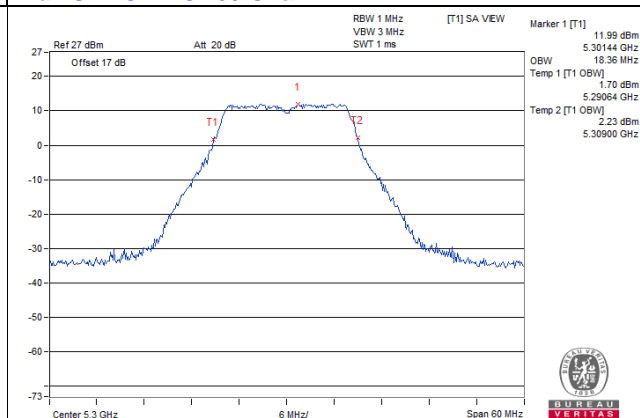

#### 11a 1S4T CDD CH52 Chain2

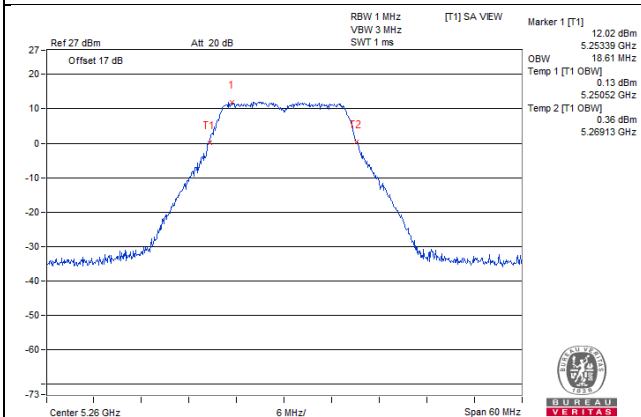

#### 11a 1S4T CDD CH60 Chain2

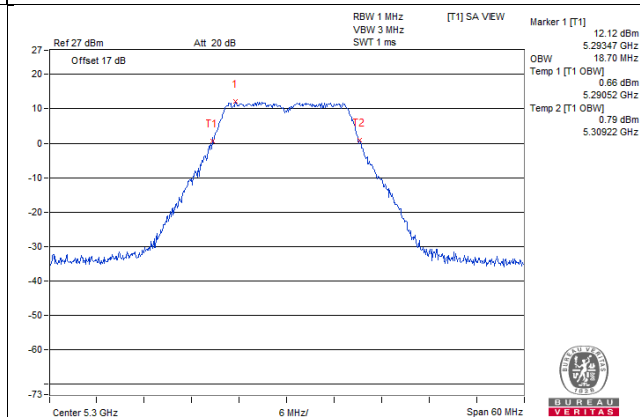

#### 11a 1S4T CDD CH52 Chain3

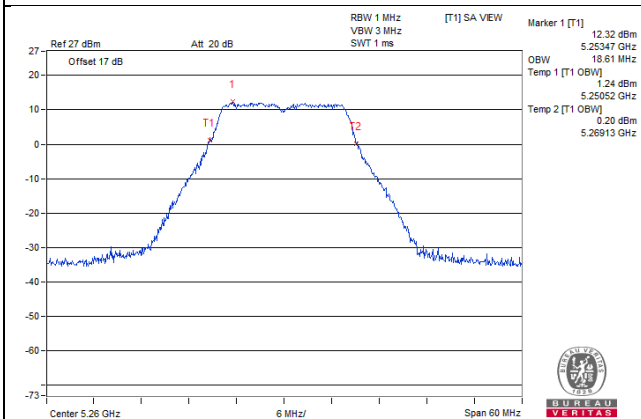

#### 11a 1S4T CDD CH60 Chain3

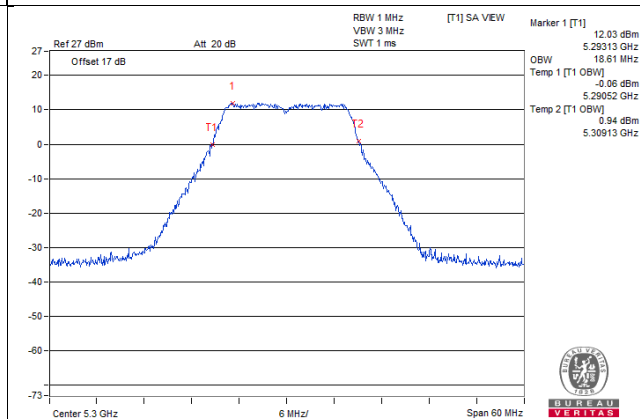

#### 11a 1S4T CDD CH52 Chain4

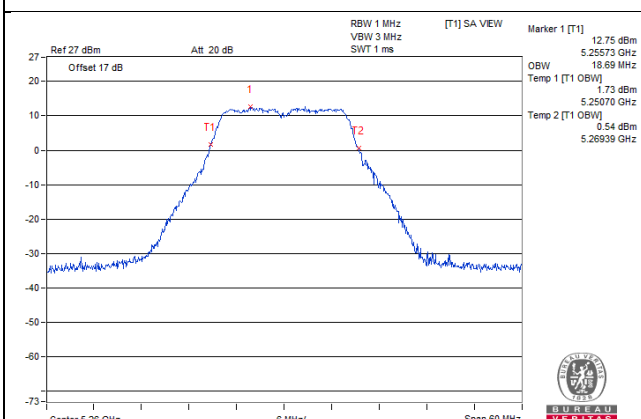

#### 11a 1S4T CDD CH60 Chain4

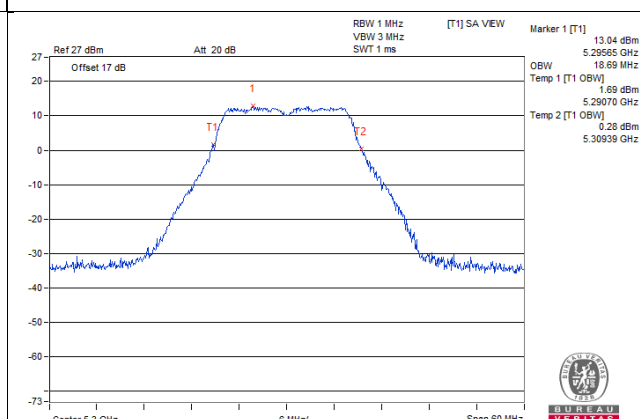

### 99% OCCUPIED BANDWIDTH SPECTRUM PLOT

#### 11a 1S4T CDD CH64 Chain1

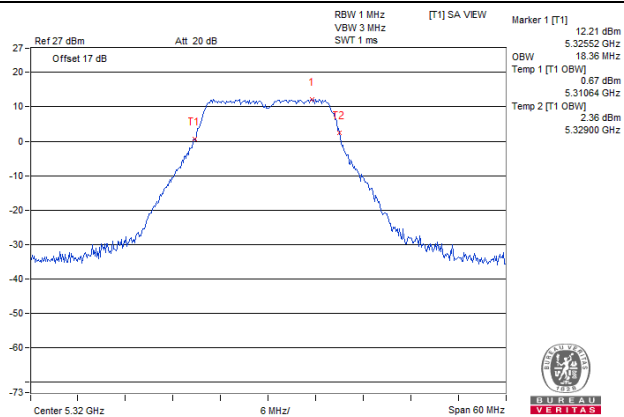

#### 11a 1S4T CDD CH64 Chain2

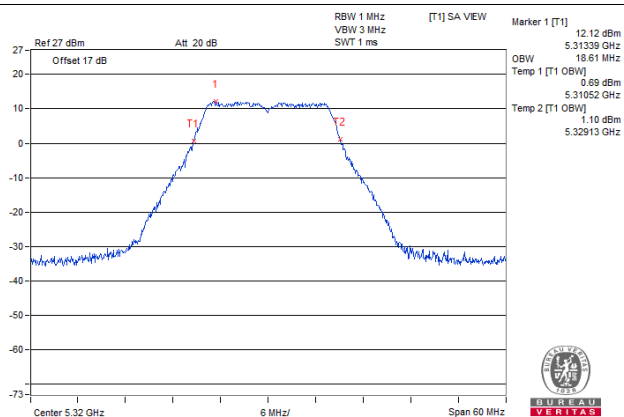

#### 11a 1S4T CDD CH64 Chain3

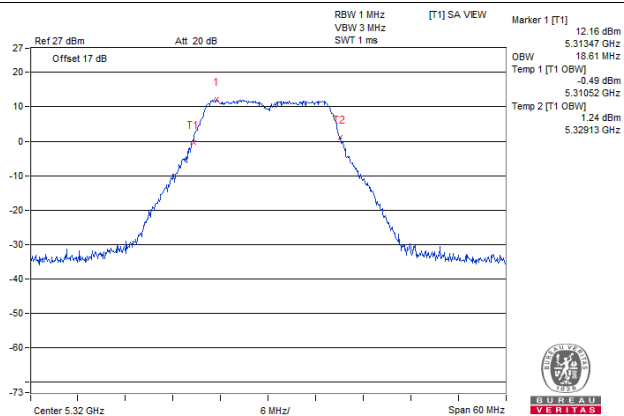

#### 11a 1S4T CDD CH64 Chain4

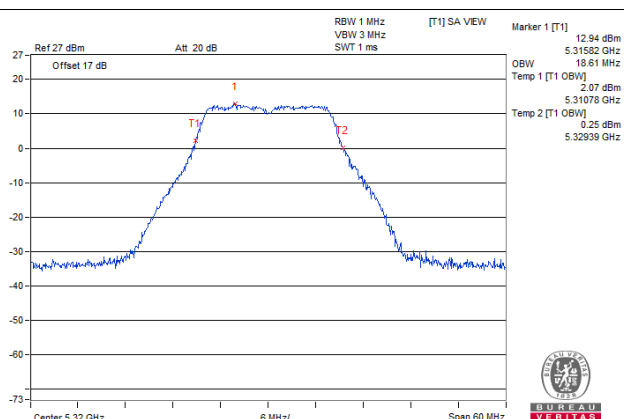

## 99% OCCUPIED BANDWIDTH SPECTRUM PLOT

### 11a 1S4T CDD CH100 Chain1

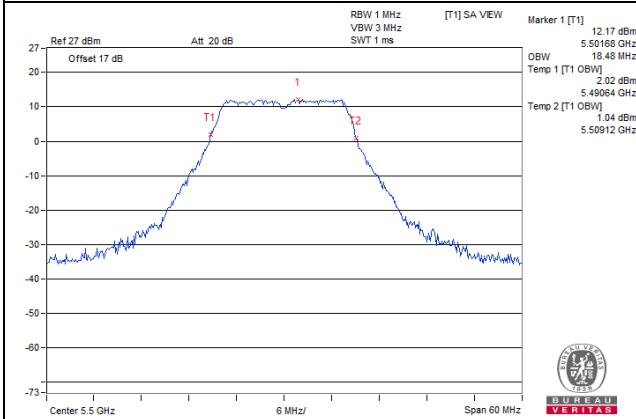

### 11a 1S4T CDD CH116 Chain1

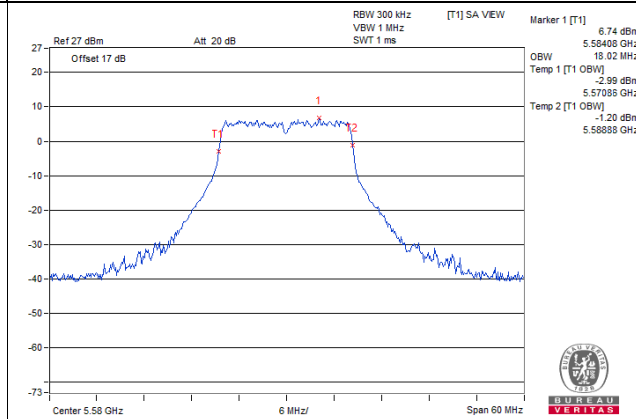

### 11a 1S4T CDD CH100 Chain2

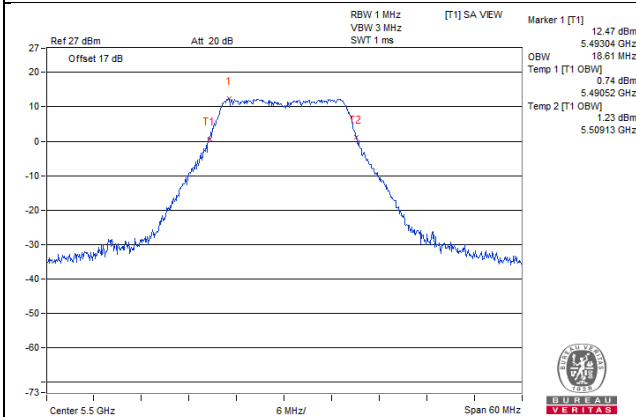

### 11a 1S4T CDD CH116 Chain2

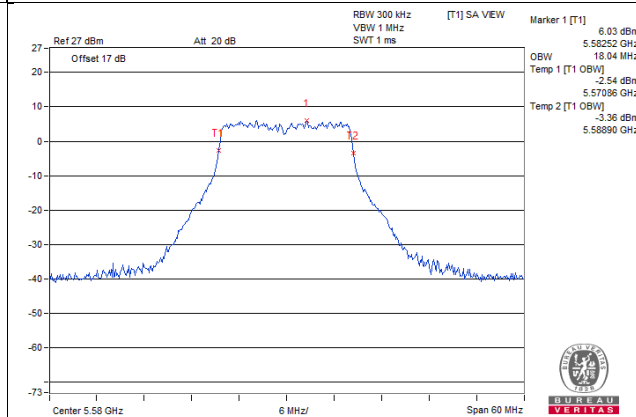

### 11a 1S4T CDD CH100 Chain3

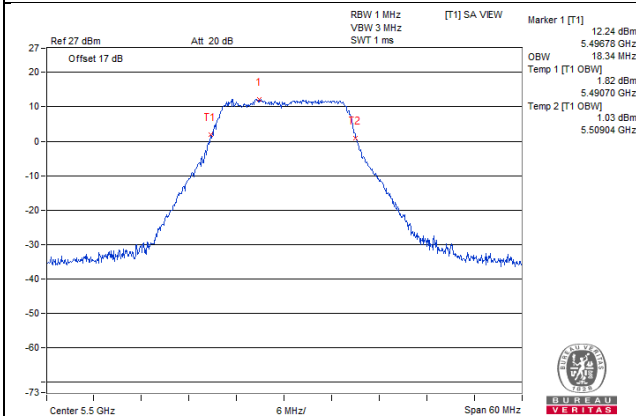

### 11a 1S4T CDD CH116 Chain3

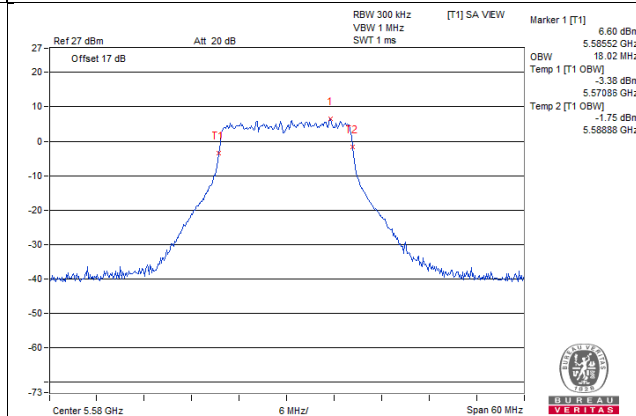

### 11a 1S4T CDD CH100 Chain4

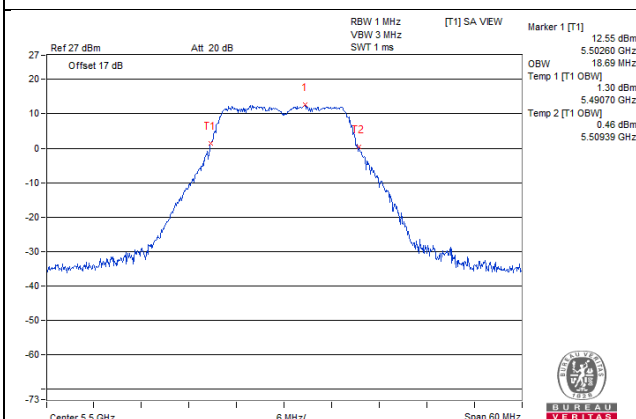

### 11a 1S4T CDD CH116 Chain4

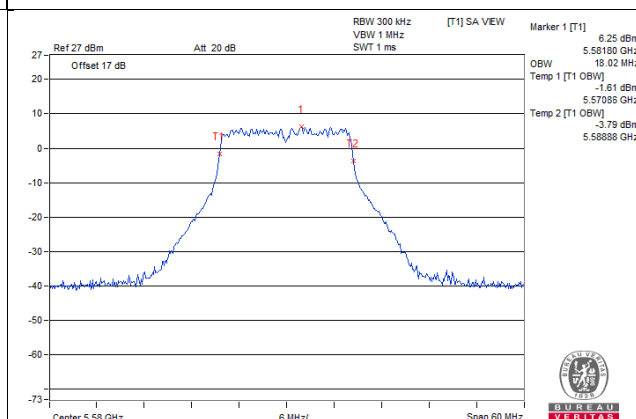

### 99% OCCUPIED BANDWIDTH SPECTRUM PLOT

#### 11a 1S4T CDD CH140 Chain1

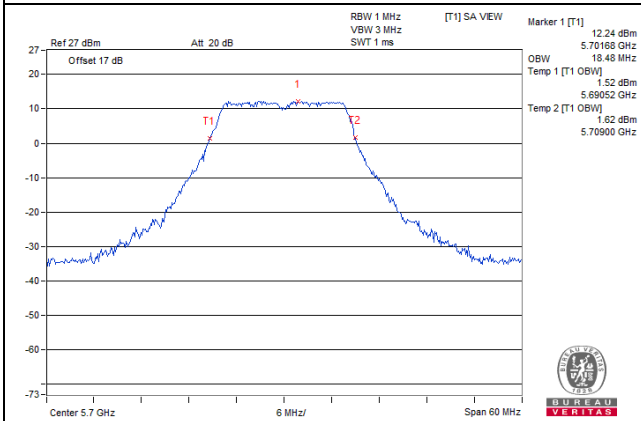

#### 11a 1S4T CDD CH140 Chain2

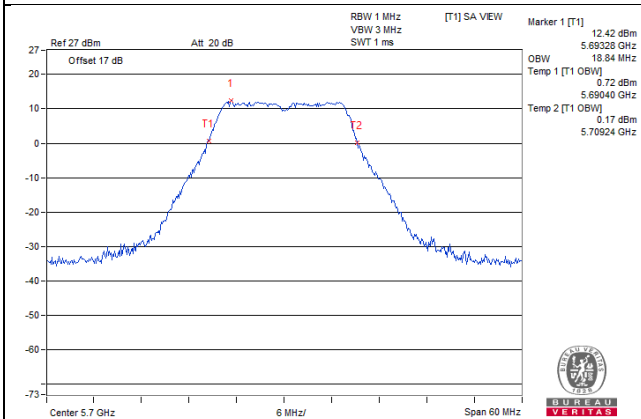

#### 11a 1S4T CDD CH140 Chain3

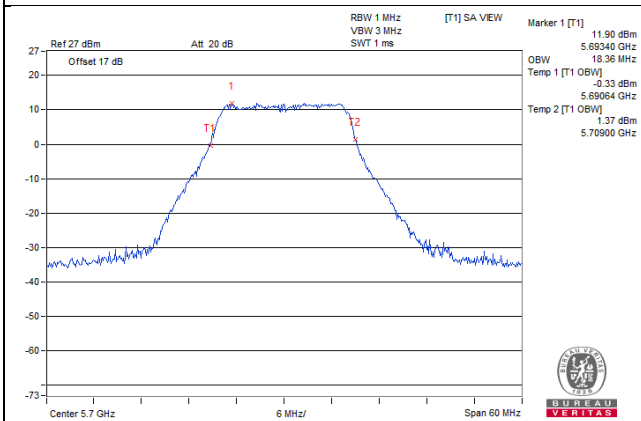

#### 11a 1S4T CDD CH140 Chain4

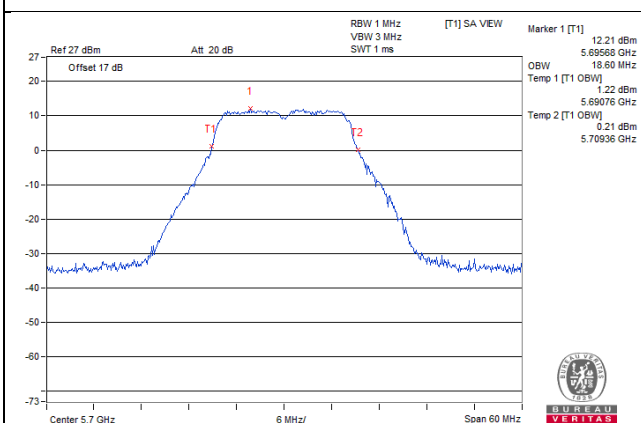

### 99% OCCUPIED BANDWIDTH SPECTRUM PLOT

**11ac (20MHz) 1S4T CDD CH52 Chain1**

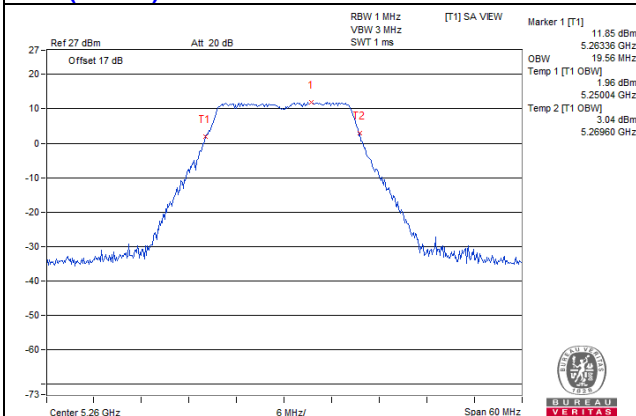

**11ac (20MHz) 1S4T CDD CH60 Chain1**

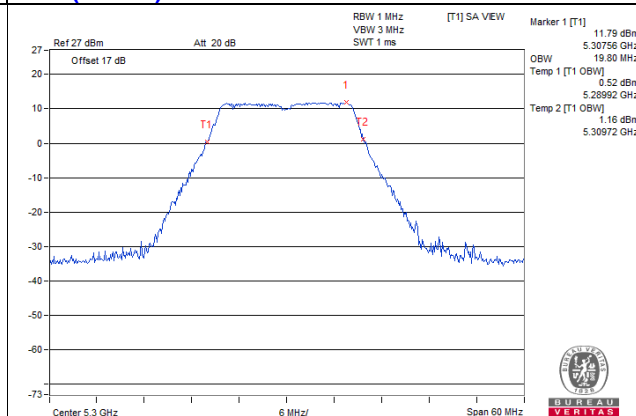

**11ac (20MHz) 1S4T CDD CH52 Chain2**

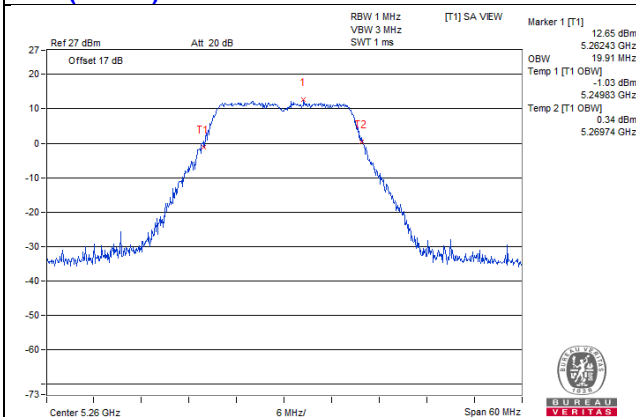

**11ac (20MHz) 1S4T CDD CH60 Chain2**

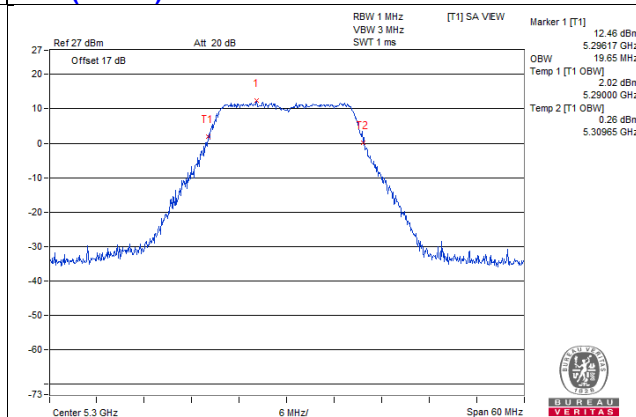

**11ac (20MHz) 1S4T CDD CH52 Chain3**

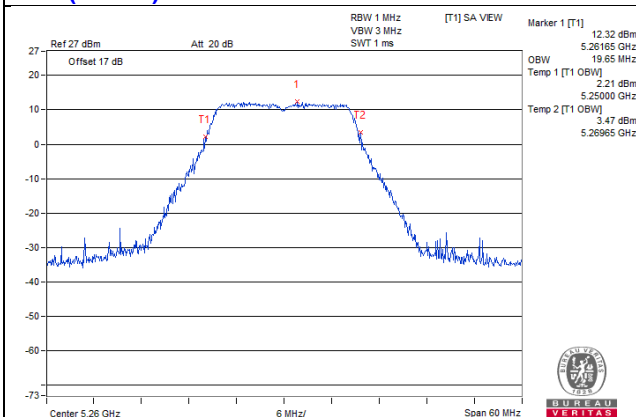

**11ac (20MHz) 1S4T CDD CH60 Chain3**

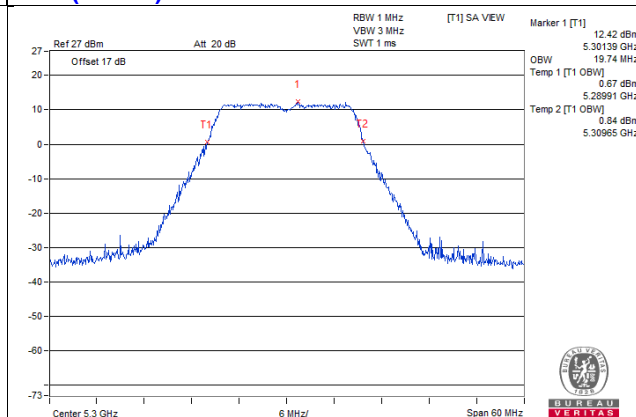

**11ac (20MHz) 1S4T CDD CH52 Chain4**

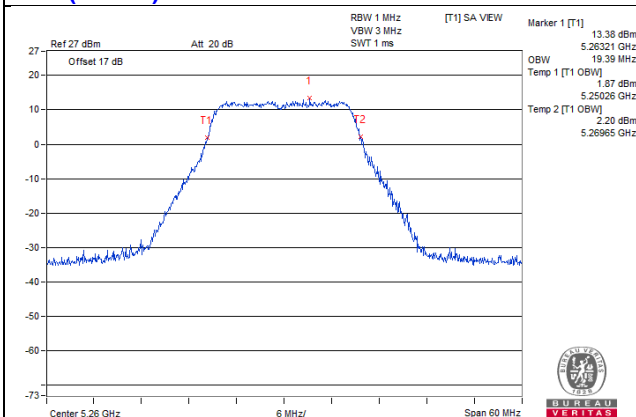

**11ac (20MHz) 1S4T CDD CH60 Chain4**

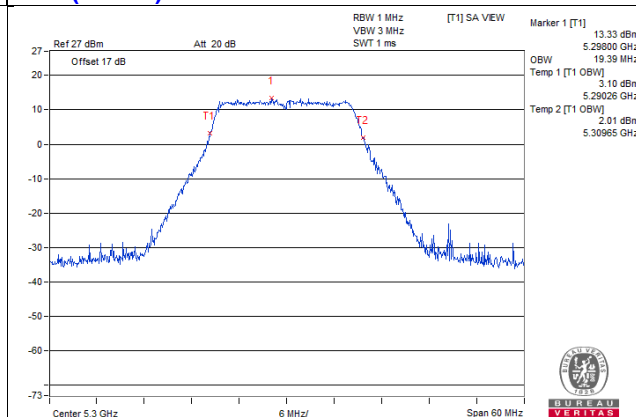

### 99% OCCUPIED BANDWIDTH SPECTRUM PLOT

**11ac (20MHz) 1S4T CDD CH64 Chain1**

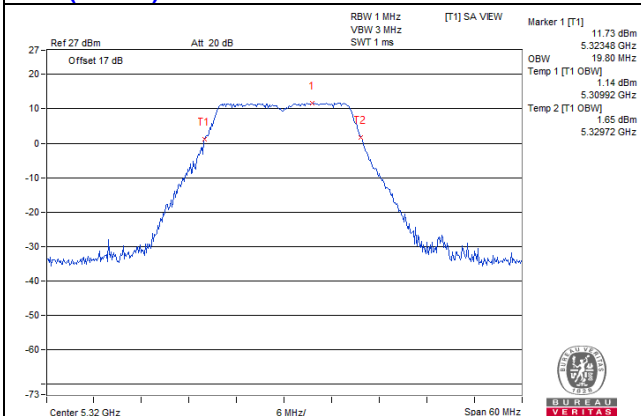

**11ac (20MHz) 1S4T CDD CH100 Chain1**

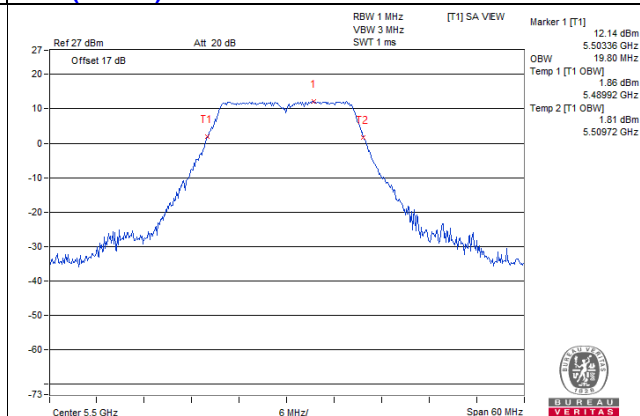

**11ac (20MHz) 1S4T CDD CH64 Chain2**

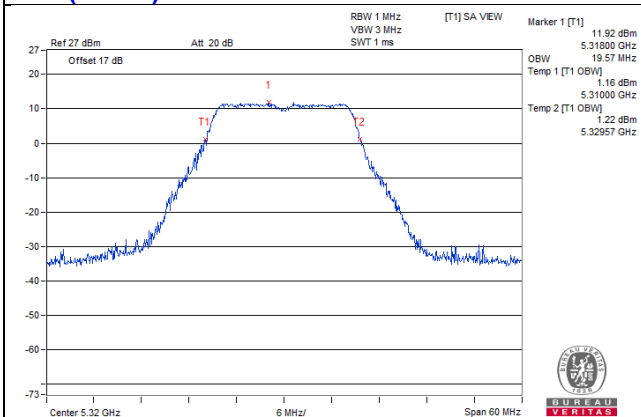

**11ac (20MHz) 1S4T CDD CH100 Chain2**

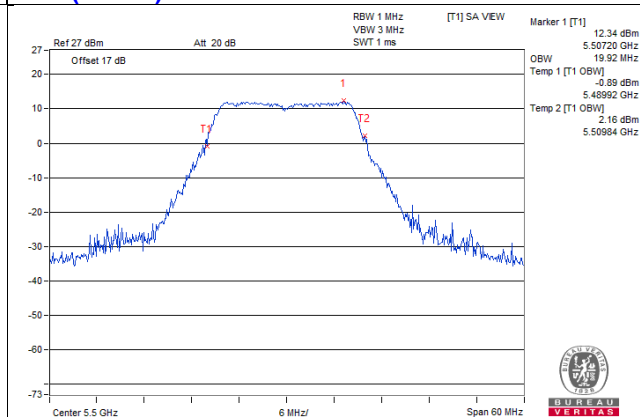

**11ac (20MHz) 1S4T CDD CH64 Chain3**

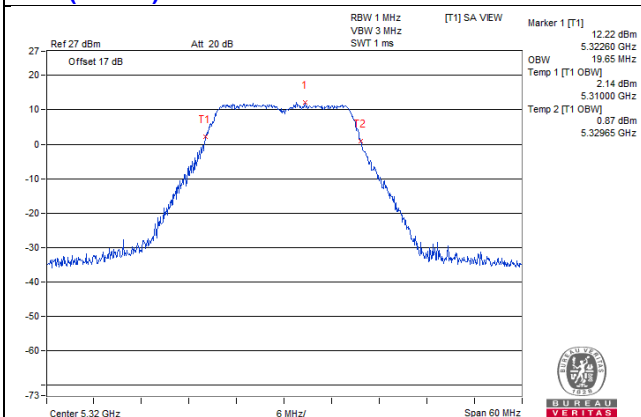

**11ac (20MHz) 1S4T CDD CH100 Chain3**

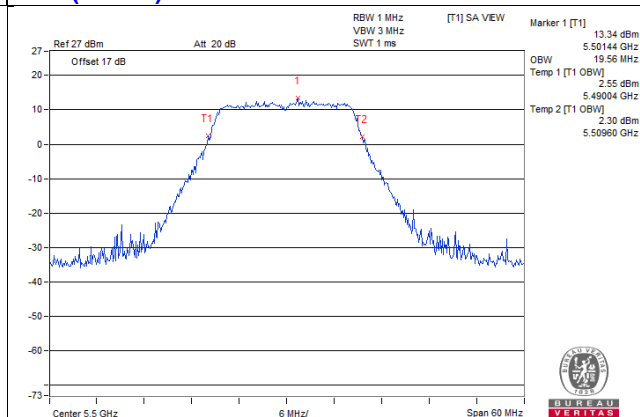

**11ac (20MHz) 1S4T CDD CH64 Chain4**

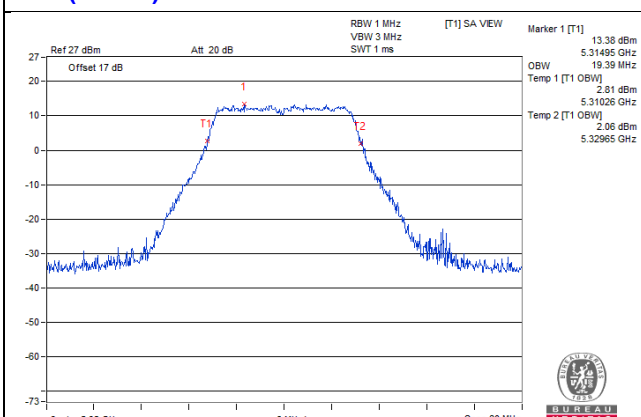

**11ac (20MHz) 1S4T CDD CH100 Chain4**

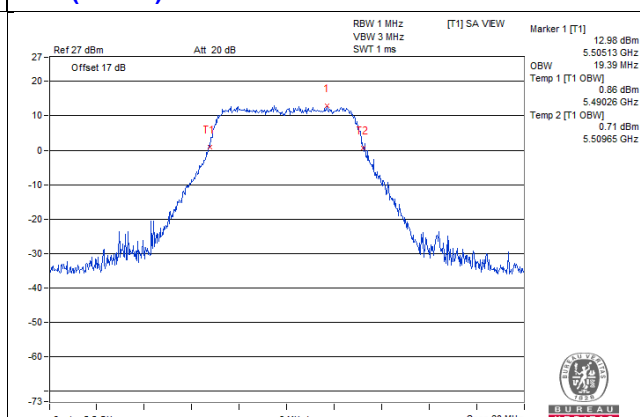

### 99% OCCUPIED BANDWIDTH SPECTRUM PLOT

**11ac (20MHz) 1S4T CDD CH116 Chain1**

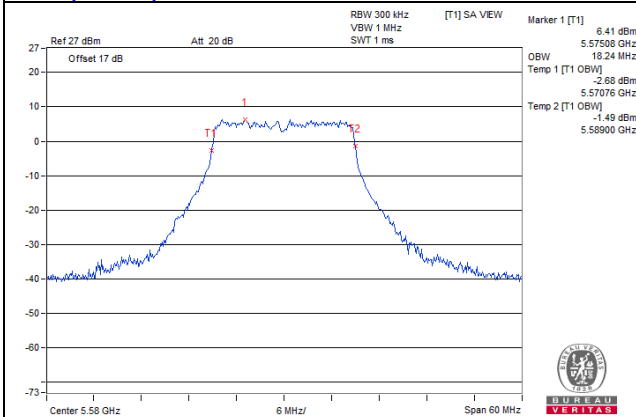

**11ac (20MHz) 1S4T CDD CH140 Chain1**

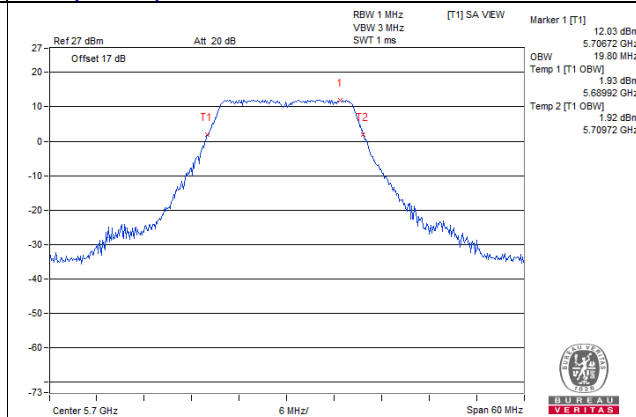

**11ac (20MHz) 1S4T CDD CH116 Chain2**

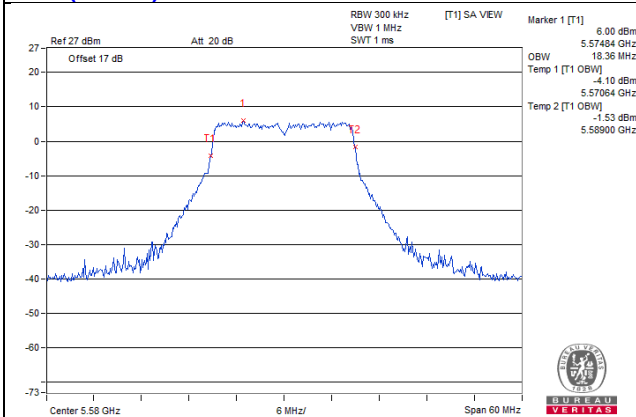

**11ac (20MHz) 1S4T CDD CH140 Chain2**

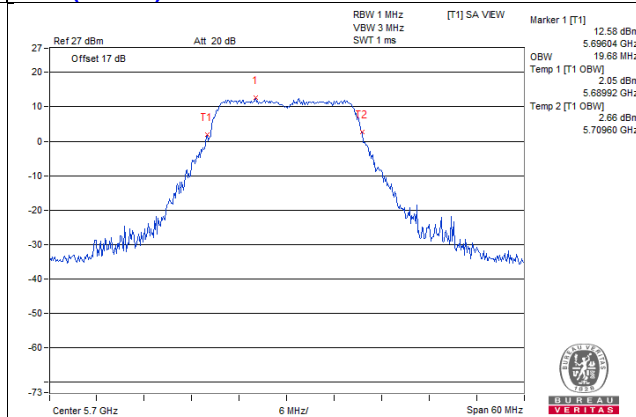

**11ac (20MHz) 1S4T CDD CH116 Chain3**

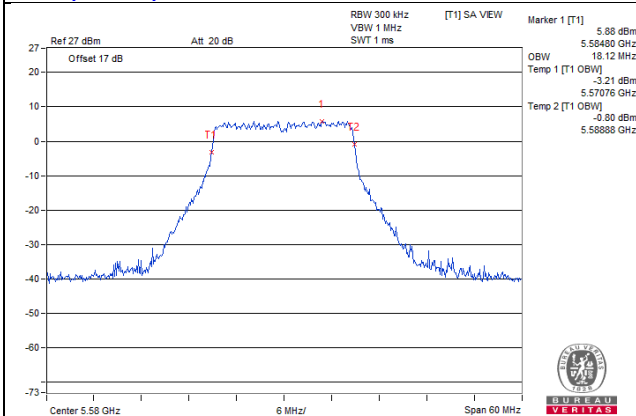

**11ac (20MHz) 1S4T CDD CH140 Chain3**

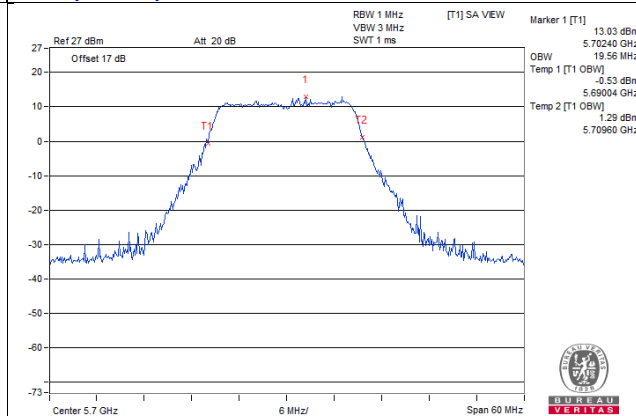

**11ac (20MHz) 1S4T CDD CH116 Chain4**

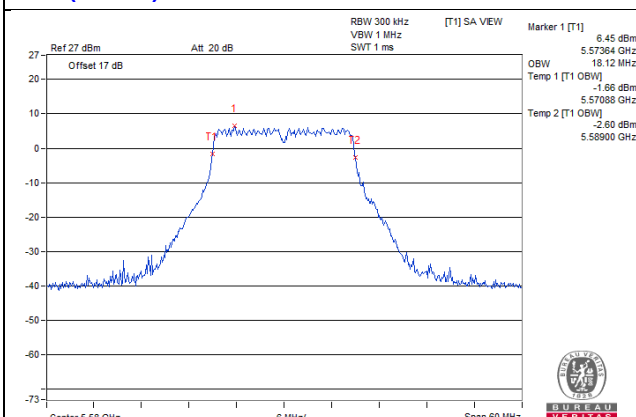

**11ac (20MHz) 1S4T CDD CH140 Chain4**

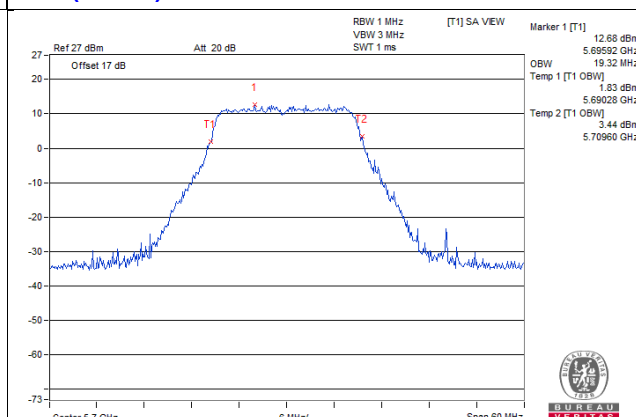

### 99% OCCUPIED BANDWIDTH SPECTRUM PLOT

**11ac (20MHz) 1S4T TXBF CH52 Chain1**

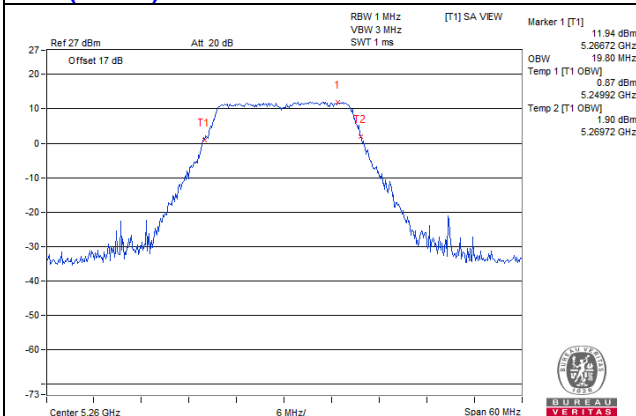

**11ac (20MHz) 1S4T TXBF CH60 Chain1**

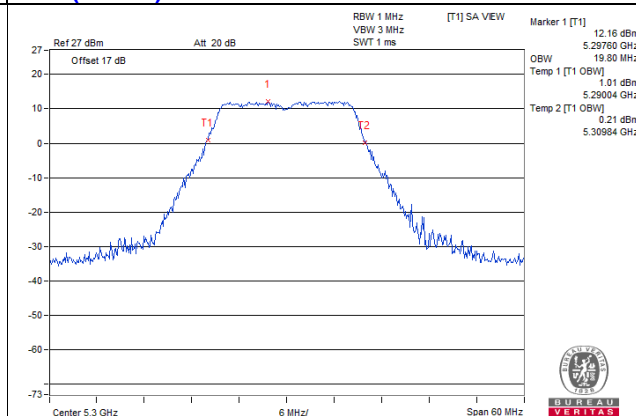

**11ac (20MHz) 1S4T TXBF CH52 Chain2**

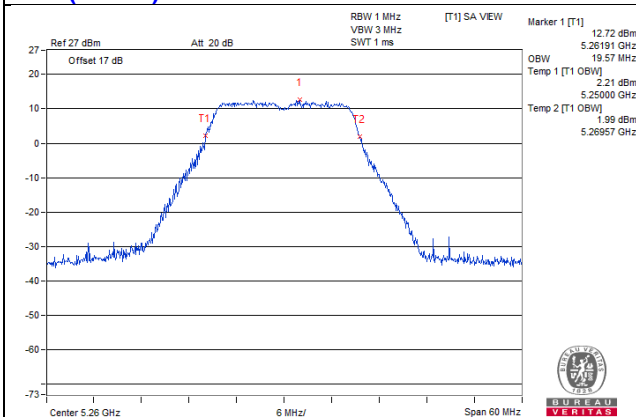

**11ac (20MHz) 1S4T TXBF CH60 Chain2**

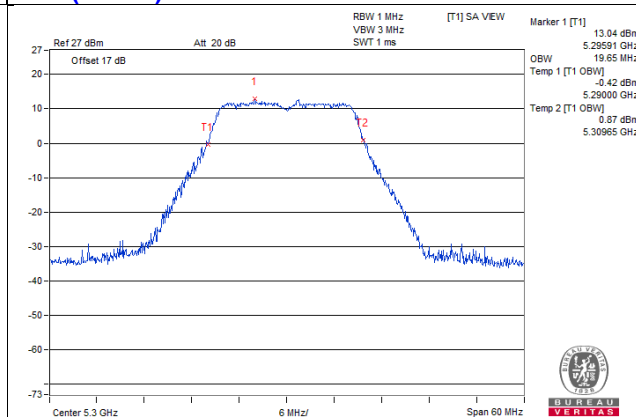

**11ac (20MHz) 1S4T TXBF CH52 Chain3**

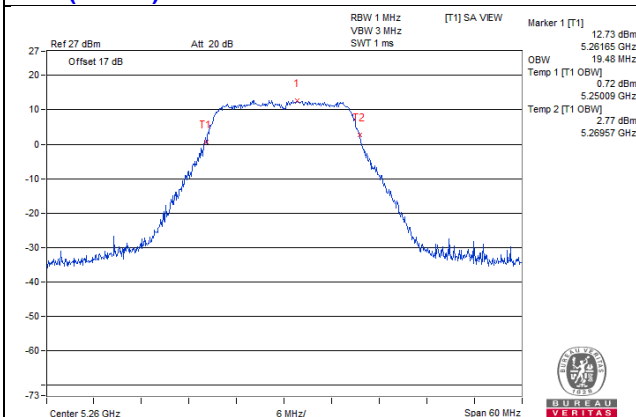

**11ac (20MHz) 1S4T TXBF CH60 Chain3**

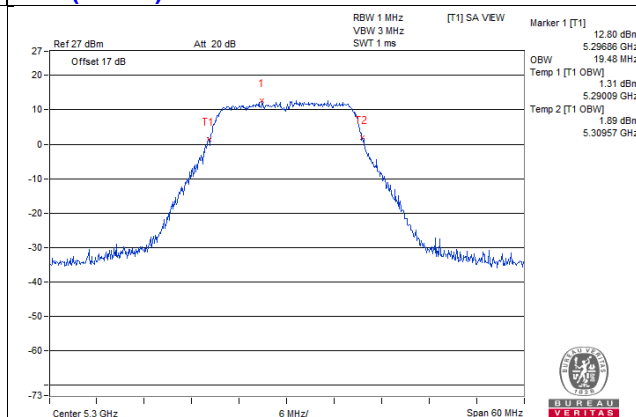

**11ac (20MHz) 1S4T TXBF CH52 Chain4**

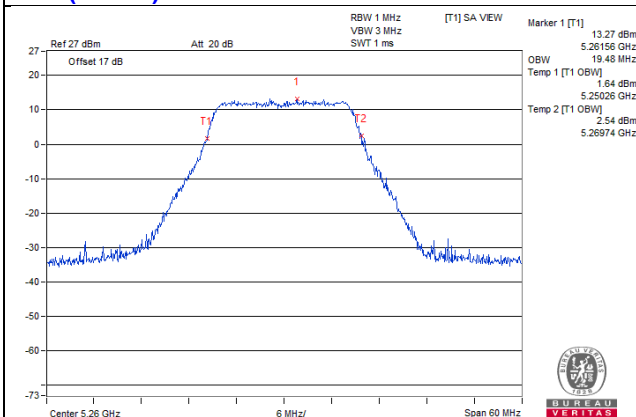

**11ac (20MHz) 1S4T TXBF CH60 Chain4**

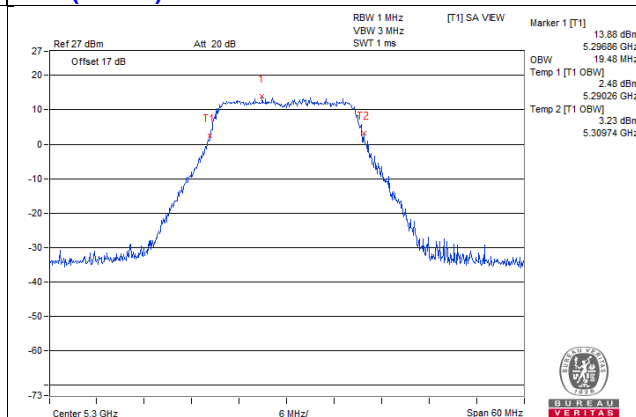



### 99% OCCUPIED BANDWIDTH SPECTRUM PLOT

**11ac (20MHz) 1S4T TXBF CH64 Chain1**

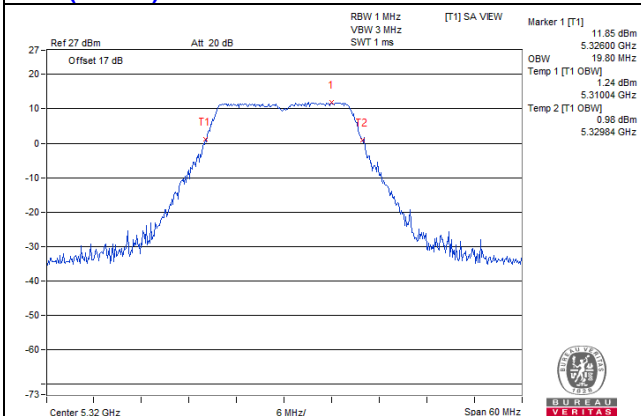

**11ac (20MHz) 1S4T TXBF CH100 Chain1**

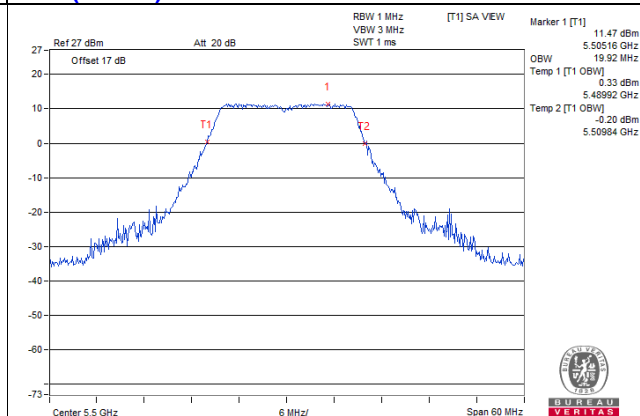

**11ac (20MHz) 1S4T TXBF CH64 Chain2**

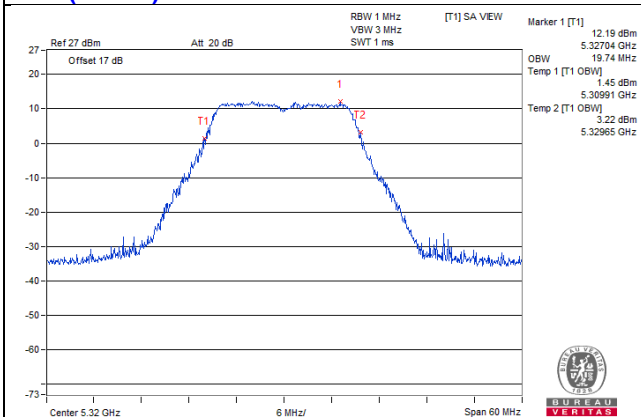

**11ac (20MHz) 1S4T TXBF CH100 Chain2**

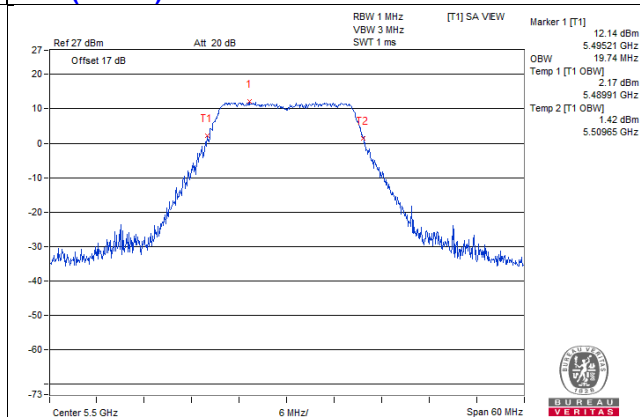

**11ac (20MHz) 1S4T TXBF CH64 Chain3**

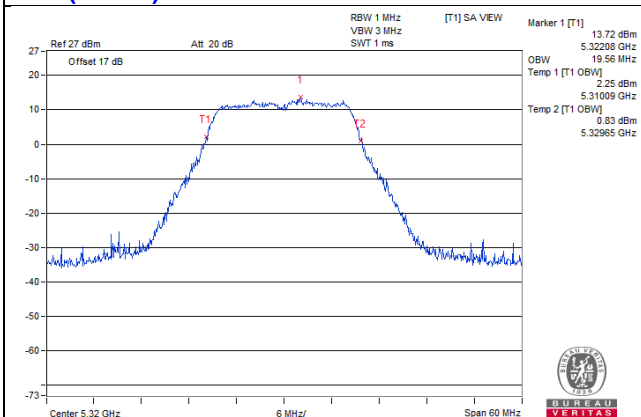

**11ac (20MHz) 1S4T TXBF CH100 Chain3**

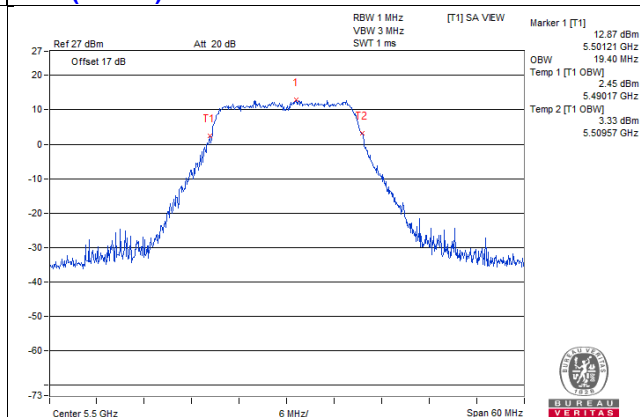

**11ac (20MHz) 1S4T TXBF CH64 Chain4**

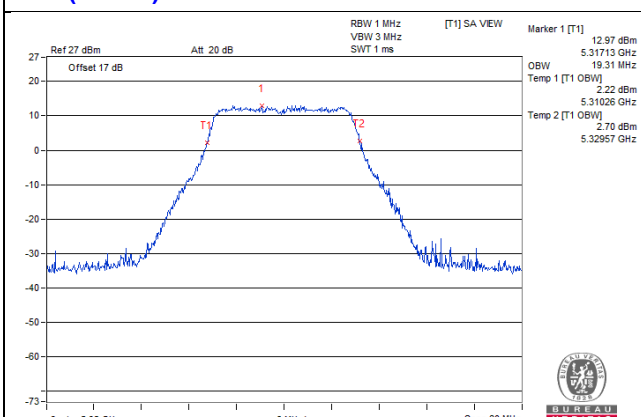

**11ac (20MHz) 1S4T TXBF CH100 Chain4**

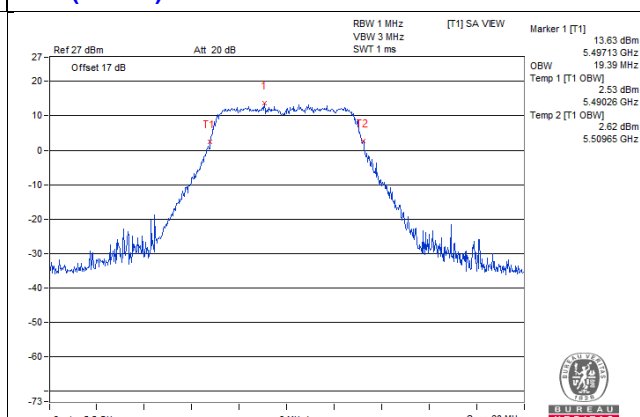

### 99% OCCUPIED BANDWIDTH SPECTRUM PLOT

**11ac (20MHz) 1S4T TXBF CH116 Chain1**

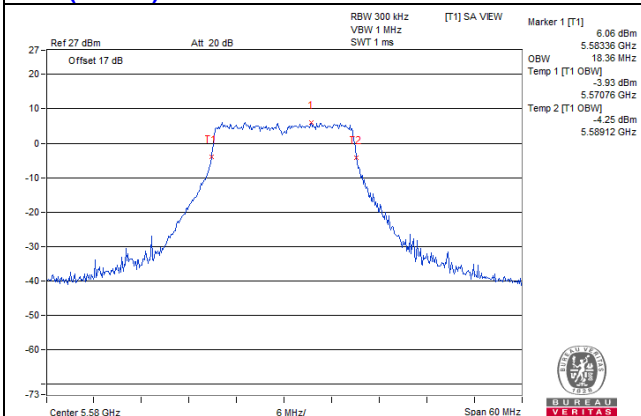

**11ac (20MHz) 1S4T TXBF CH140 Chain1**

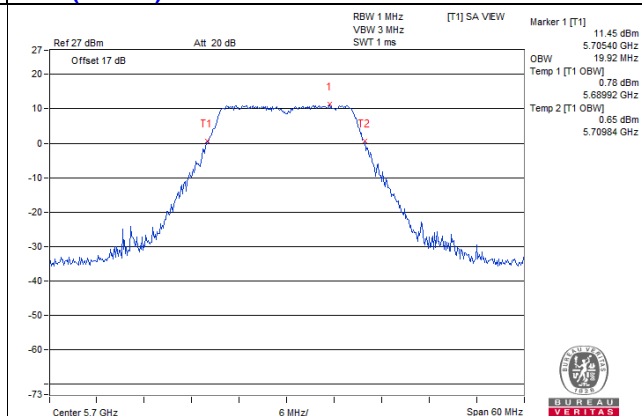

**11ac (20MHz) 1S4T TXBF CH116 Chain2**

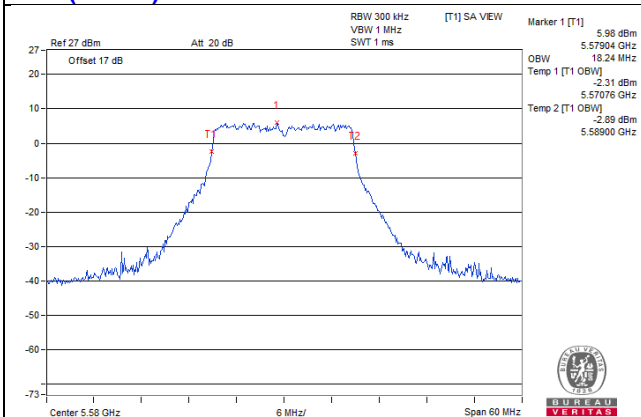

**11ac (20MHz) 1S4T TXBF CH140 Chain2**

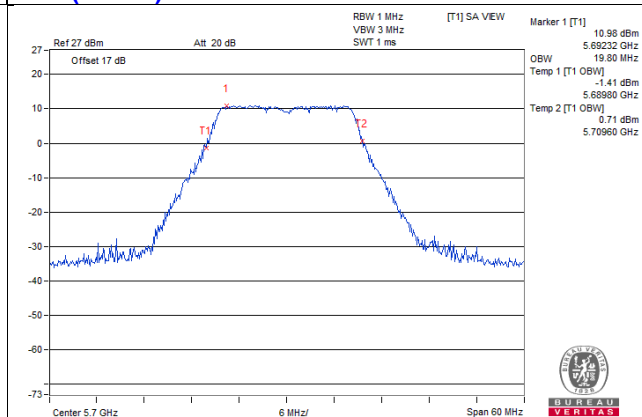

**11ac (20MHz) 1S4T TXBF CH116 Chain3**

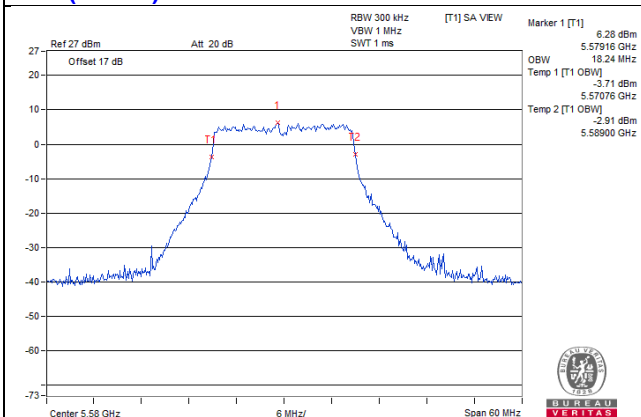

**11ac (20MHz) 1S4T TXBF CH140 Chain3**

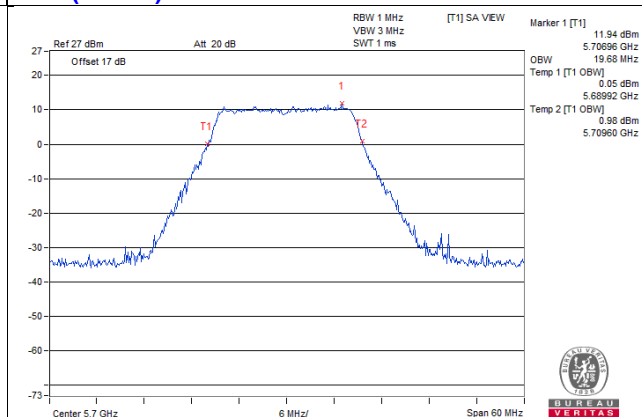

**11ac (20MHz) 1S4T TXBF CH116 Chain4**

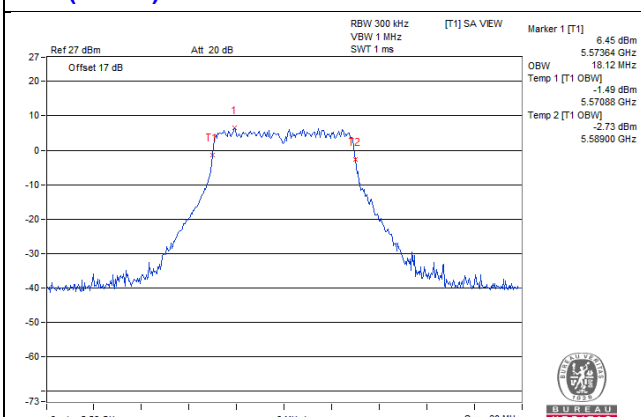

**11ac (20MHz) 1S4T TXBF CH140 Chain4**

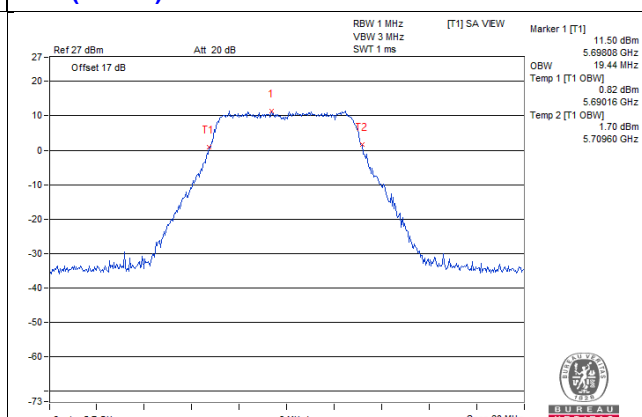

### 99% OCCUPIED BANDWIDTH SPECTRUM PLOT

**11ac (40MHz) 1S4T CDD CH54 Chain1**

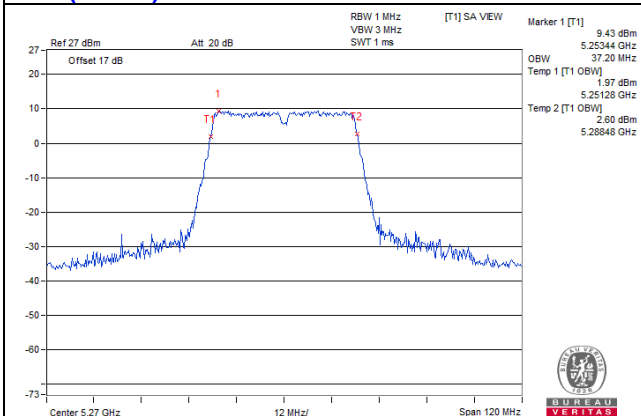

**11ac (40MHz) 1S4T CDD CH62 Chain1**

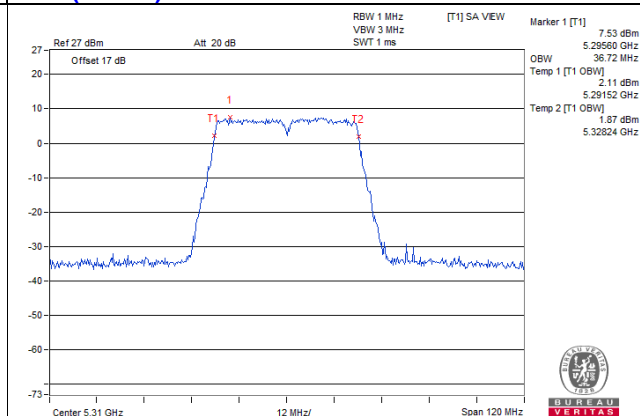

**11ac (40MHz) 1S4T CDD CH54 Chain2**

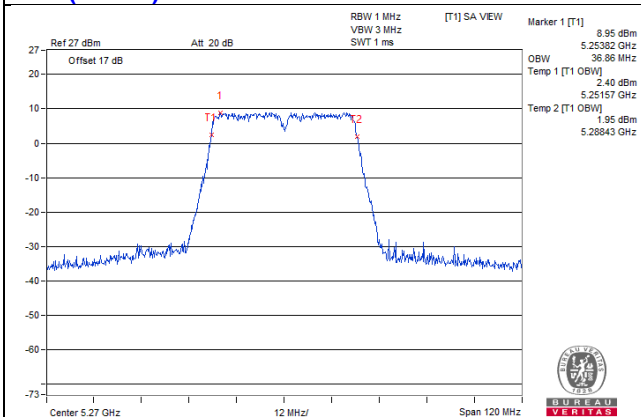

**11ac (40MHz) 1S4T CDD CH62 Chain2**

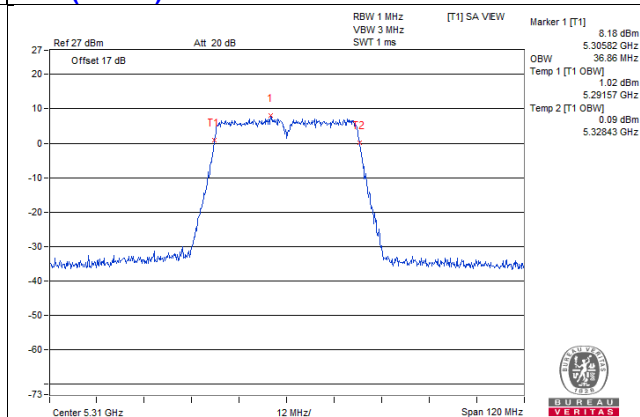

**11ac (40MHz) 1S4T CDD CH54 Chain3**

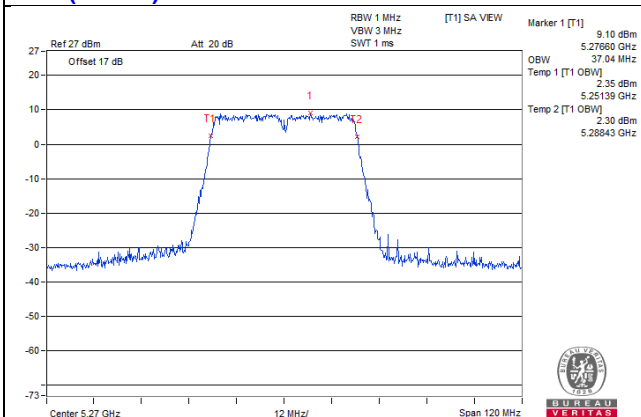

**11ac (40MHz) 1S4T CDD CH62 Chain3**

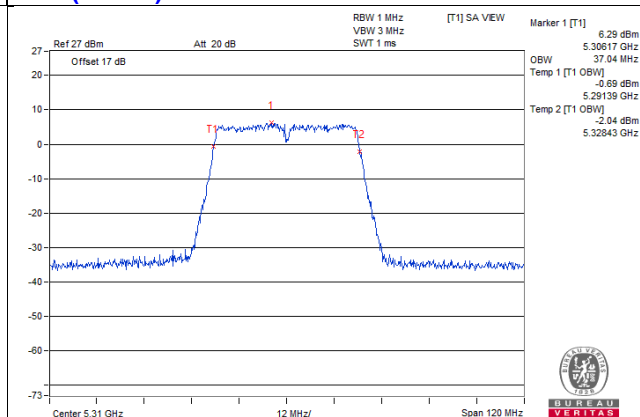

**11ac (40MHz) 1S4T CDD CH54 Chain4**

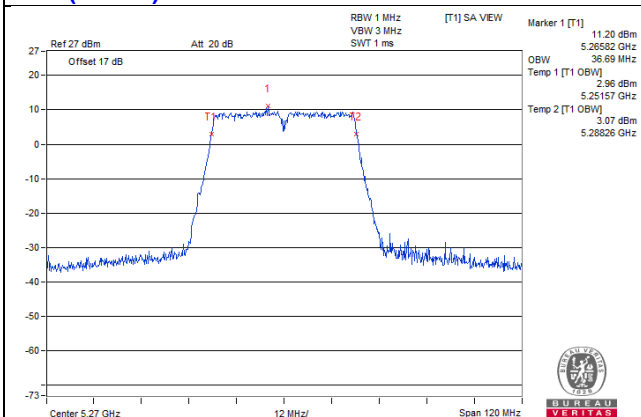

**11ac (40MHz) 1S4T CDD CH62 Chain4**

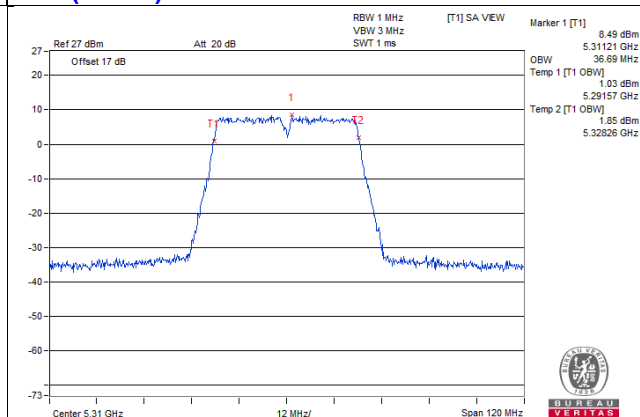

### 99% OCCUPIED BANDWIDTH SPECTRUM PLOT

**11ac (40MHz) 1S4T CDD CH102 Chain1**

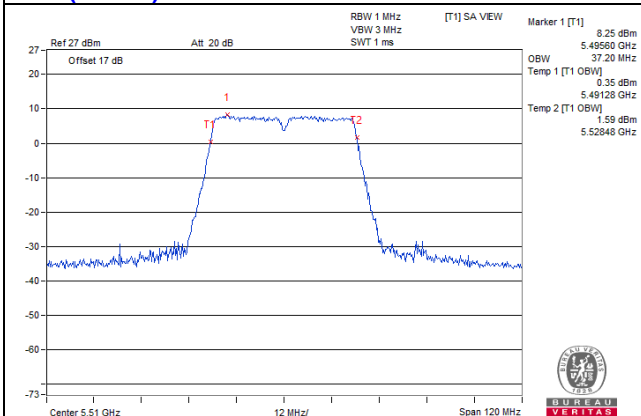

**11ac (40MHz) 1S4T CDD CH110 Chain1**

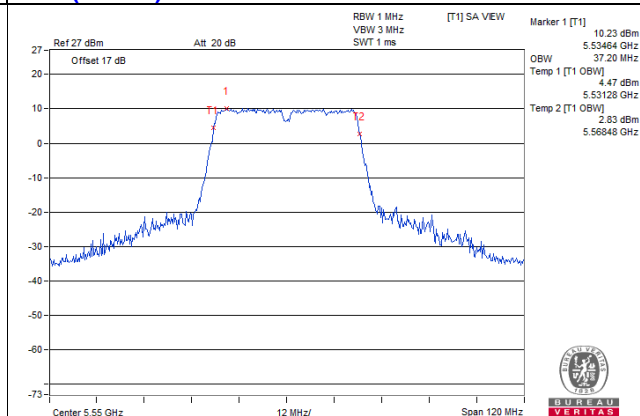

**11ac (40MHz) 1S4T CDD CH102 Chain2**

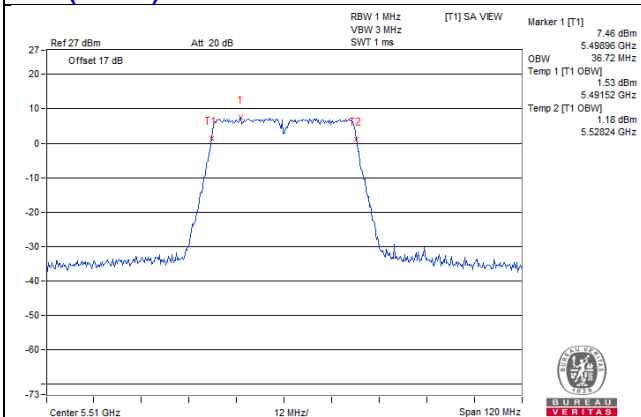

**11ac (40MHz) 1S4T CDD CH110 Chain2**

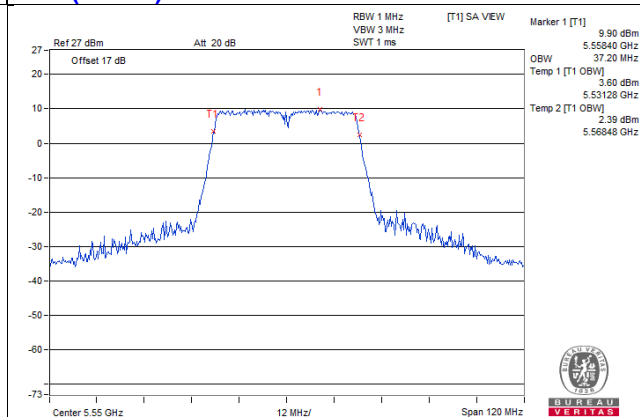

**11ac (40MHz) 1S4T CDD CH102 Chain3**

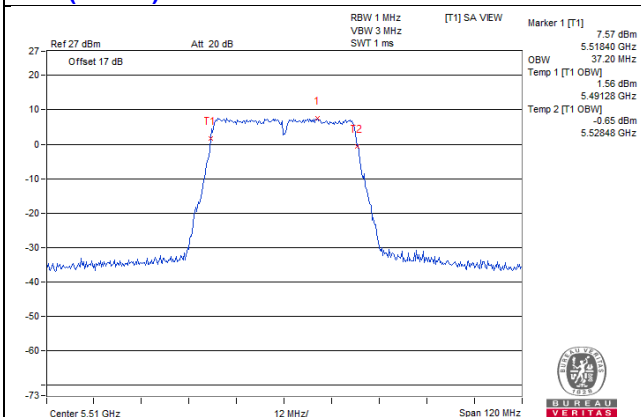

**11ac (40MHz) 1S4T CDD CH110 Chain3**

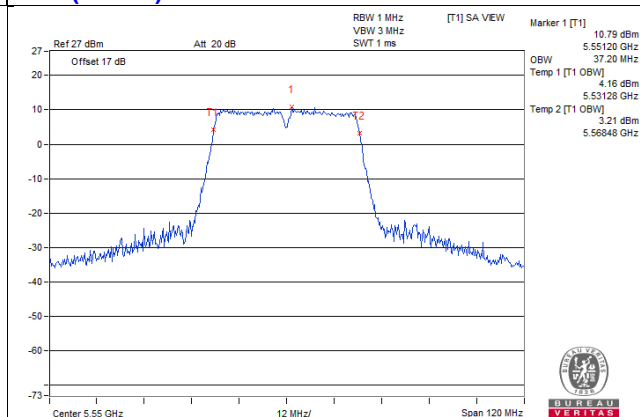

**11ac (40MHz) 1S4T CDD CH102 Chain4**

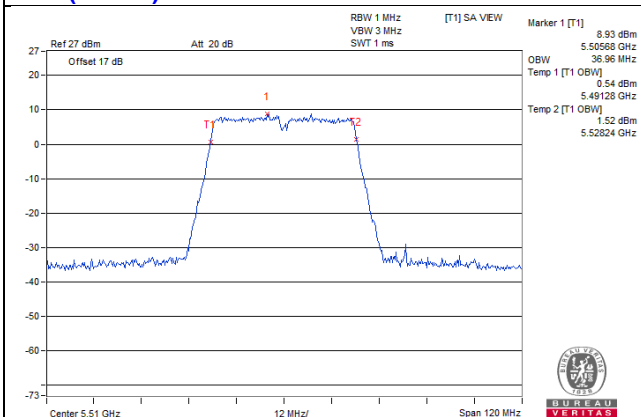

**11ac (40MHz) 1S4T CDD CH110 Chain4**

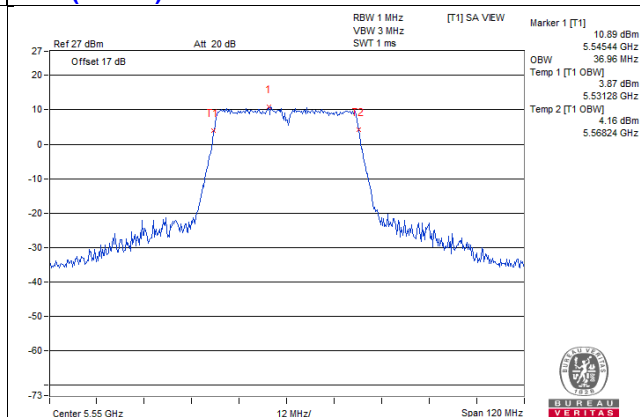

### 99% OCCUPIED BANDWIDTH SPECTRUM PLOT

#### 11ac (40MHz) 1S4T CDD CH134 Chain1

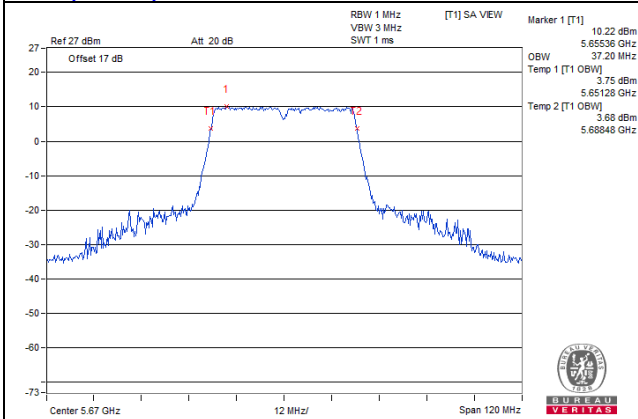

#### 11ac (40MHz) 1S4T CDD CH134 Chain2

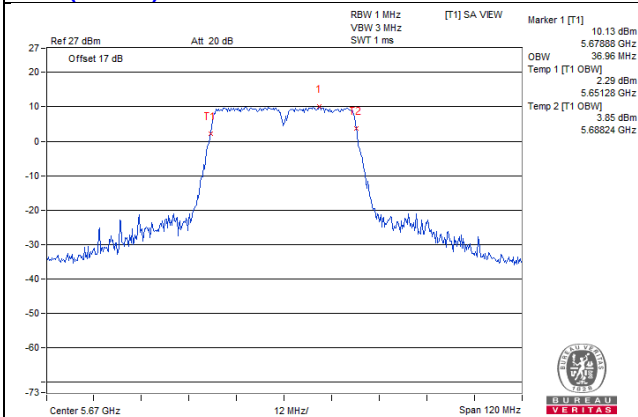

#### 11ac (40MHz) 1S4T CDD CH134 Chain3

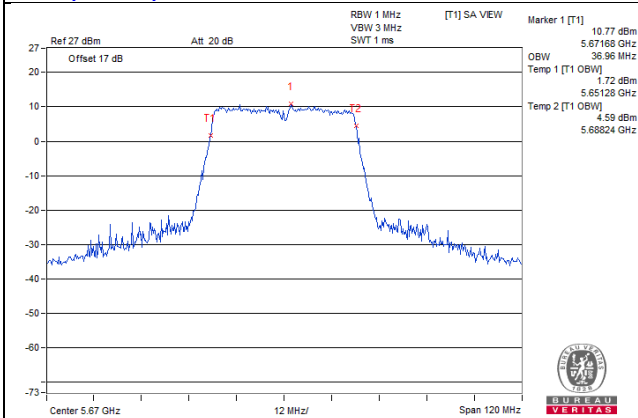

#### 11ac (40MHz) 1S4T CDD CH134 Chain4

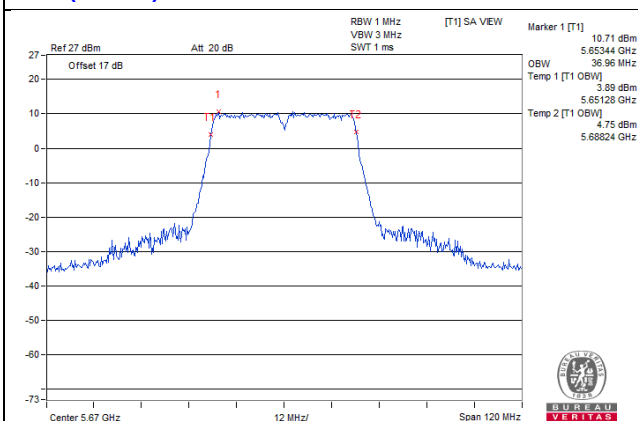

### 99% OCCUPIED BANDWIDTH SPECTRUM PLOT

**11ac (40MHz) 1S4T TxBF CH54 Chain1**

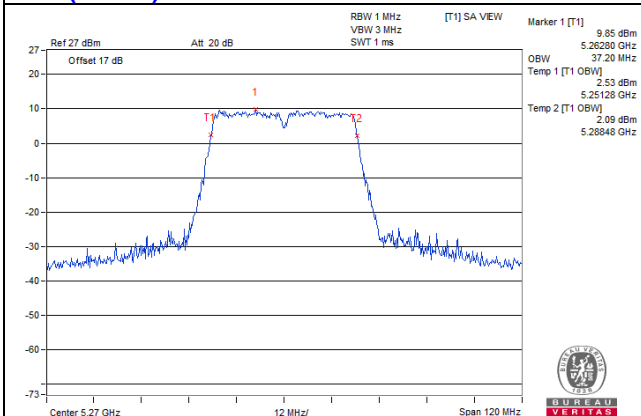

**11ac (40MHz) 1S4T TxBF CH62 Chain1**

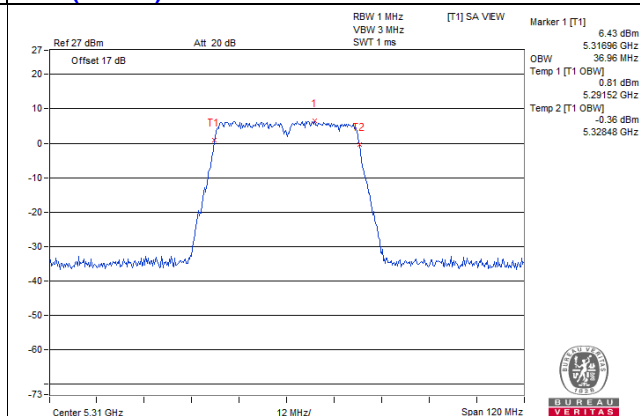

**11ac (40MHz) 1S4T TxBF CH54 Chain2**

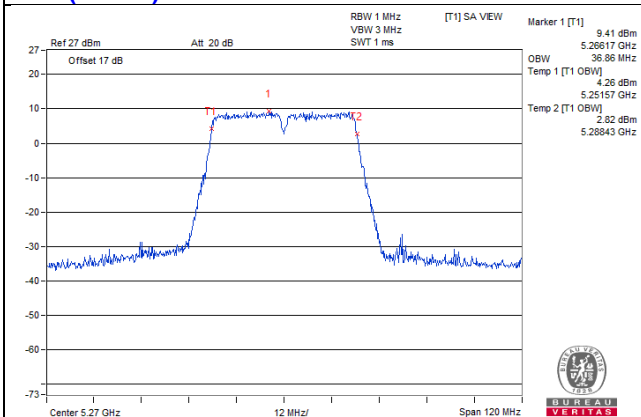

**11ac (40MHz) 1S4T TxBF CH62 Chain2**

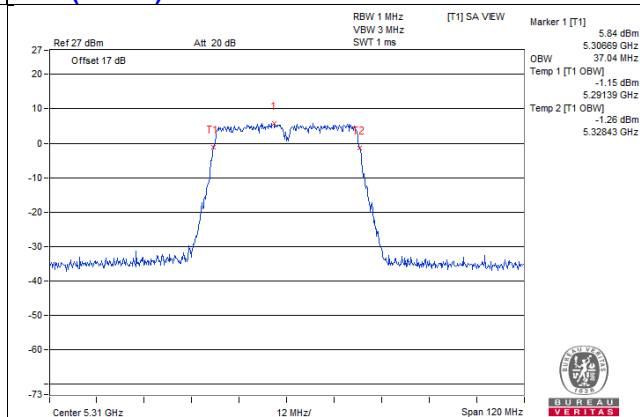

**11ac (40MHz) 1S4T TxBF CH54 Chain3**

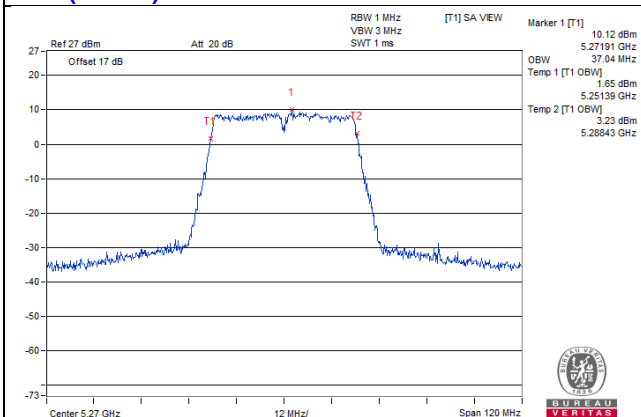

**11ac (40MHz) 1S4T TxBF CH62 Chain3**

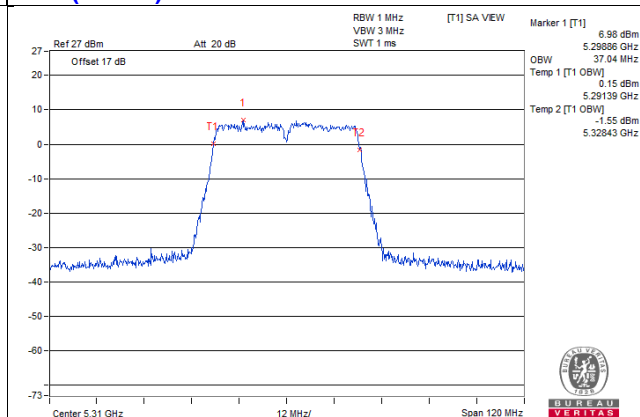

**11ac (40MHz) 1S4T TxBF CH54 Chain4**

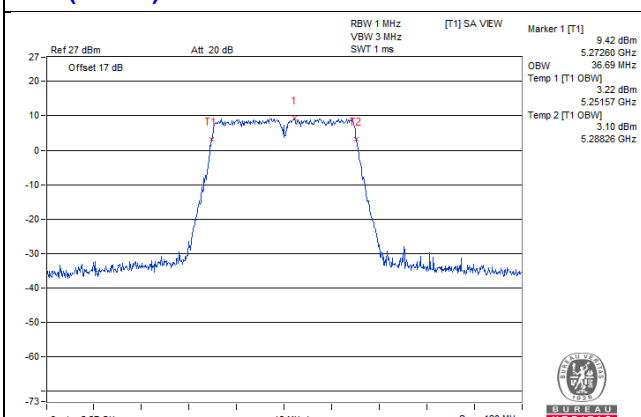

**11ac (40MHz) 1S4T TxBF CH62 Chain4**

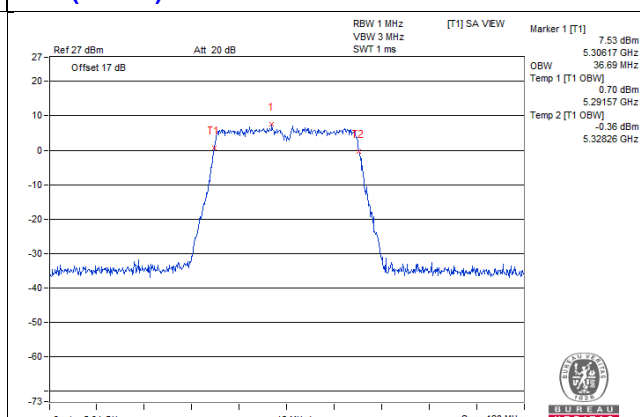

### 99% OCCUPIED BANDWIDTH SPECTRUM PLOT

**11ac (40MHz) 1S4T TxBF CH102 Chain1**

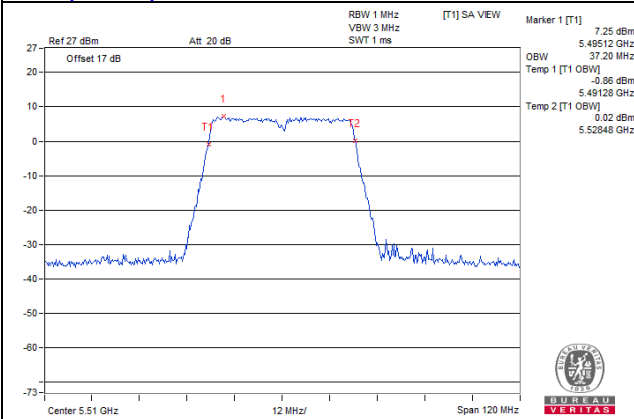

**11ac (40MHz) 1S4T TxBF CH110 Chain1**

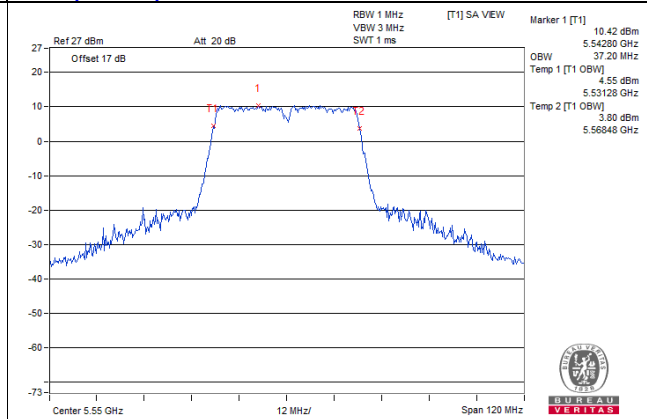

**11ac (40MHz) 1S4T TxBF CH102 Chain2**

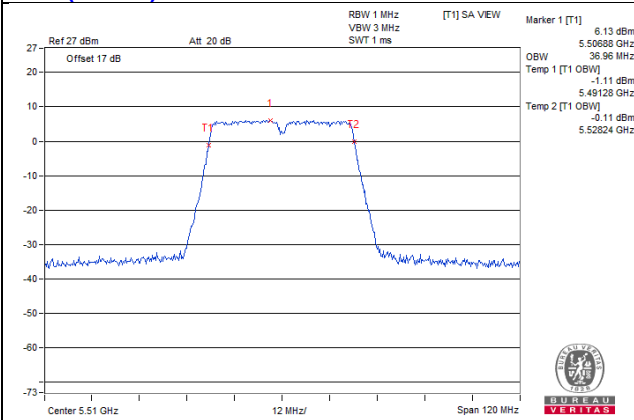

**11ac (40MHz) 1S4T TxBF CH110 Chain2**

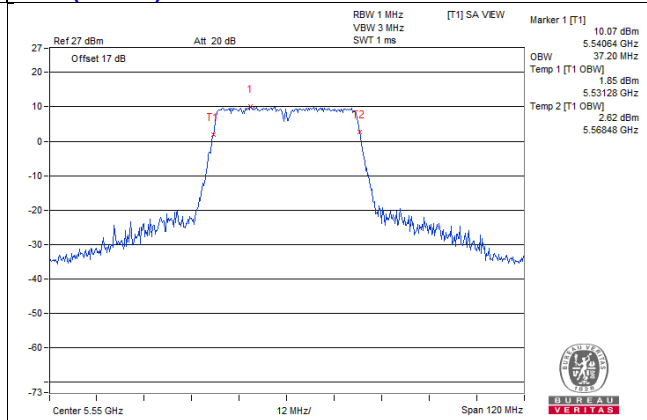

**11ac (40MHz) 1S4T TxBF CH102 Chain3**

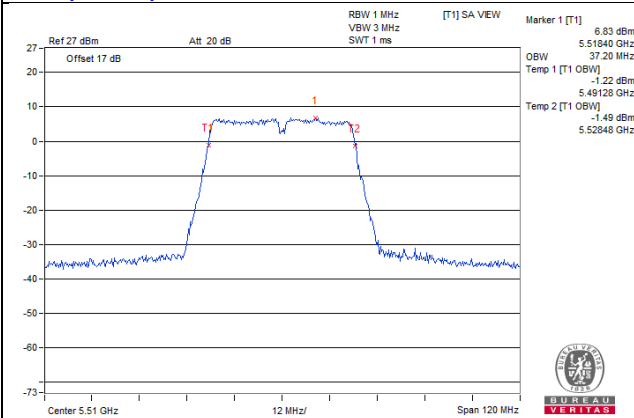

**11ac (40MHz) 1S4T TxBF CH110 Chain3**

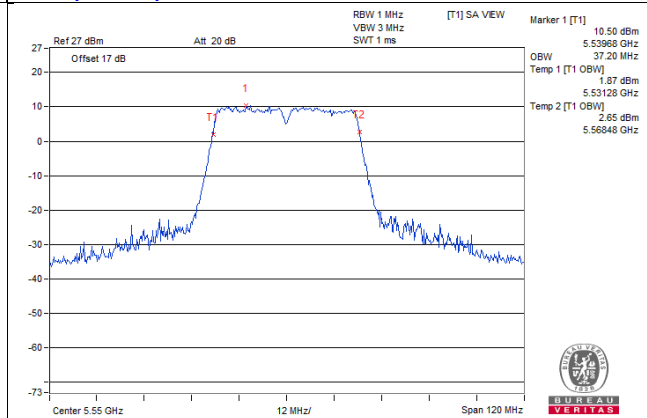

**11ac (40MHz) 1S4T TxBF CH102 Chain4**

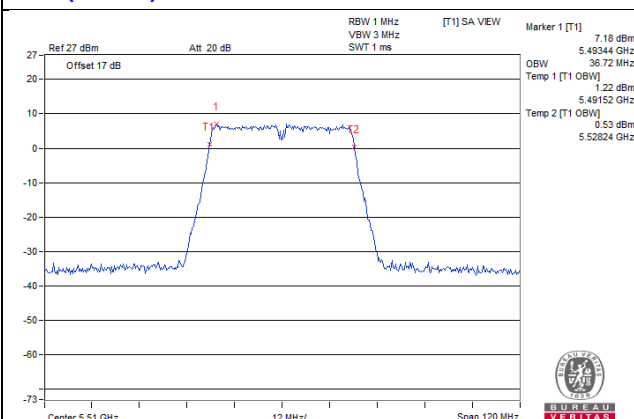

**11ac (40MHz) 1S4T TxBF CH110 Chain4**

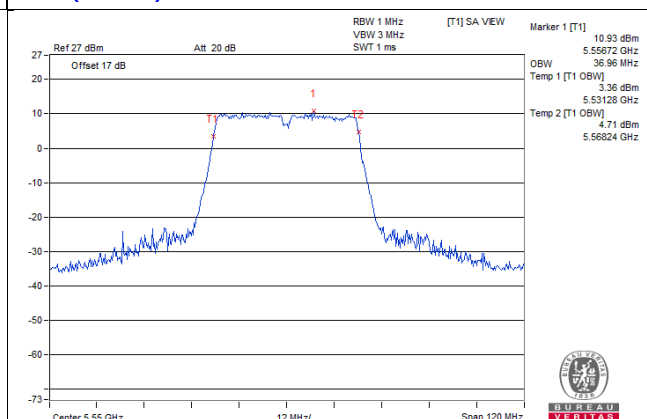

### 99% OCCUPIED BANDWIDTH SPECTRUM PLOT

#### 11ac (40MHz) 1S4T TxBF CH134 Chain1

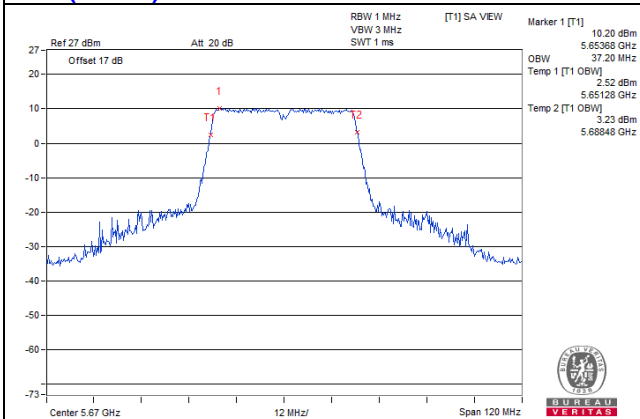

#### 11ac (40MHz) 1S4T TxBF CH134 Chain2

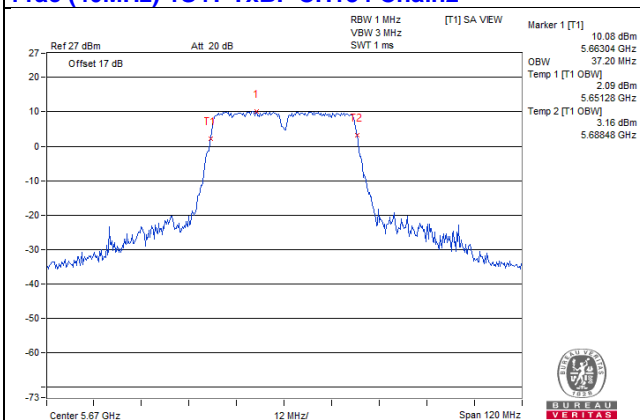

#### 11ac (40MHz) 1S4T TxBF CH134 Chain3

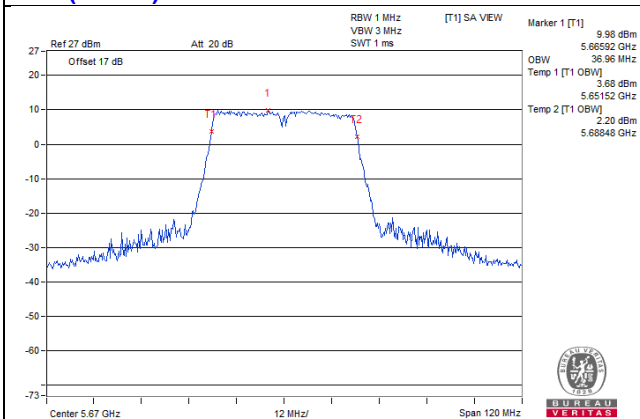

#### 11ac (40MHz) 1S4T TxBF CH134 Chain4

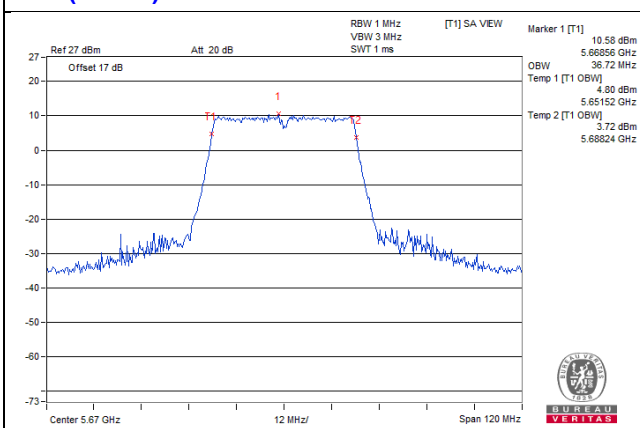



### 99% OCCUPIED BANDWIDTH SPECTRUM PLOT

**11ac (80MHz) 1S4T CDD CH58 Chain1**

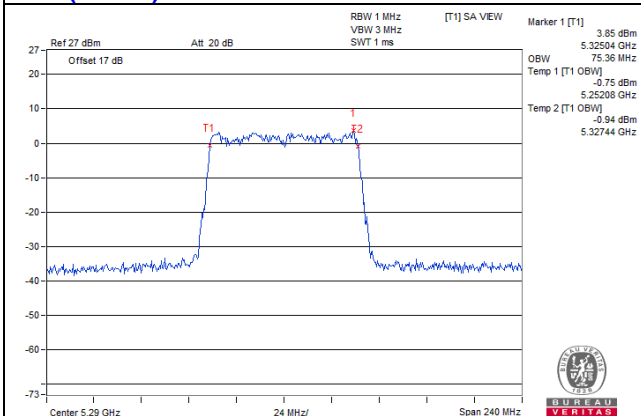

**11ac (80MHz) 1S4T CDD CH106 Chain1**

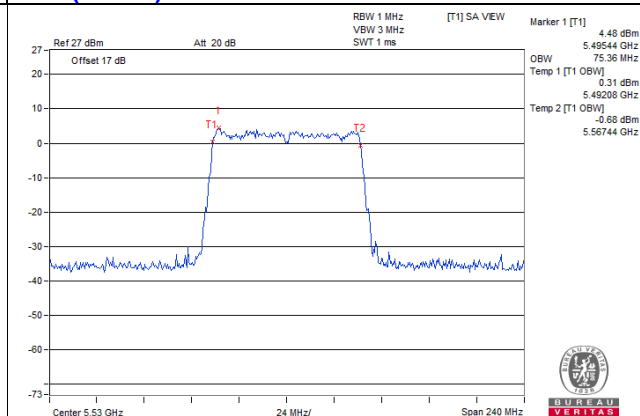

**11ac (80MHz) 1S4T CDD CH58 Chain2**

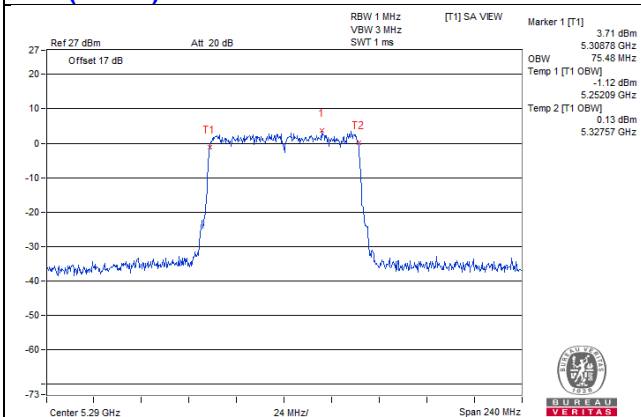

**11ac (80MHz) 1S4T CDD CH106 Chain2**

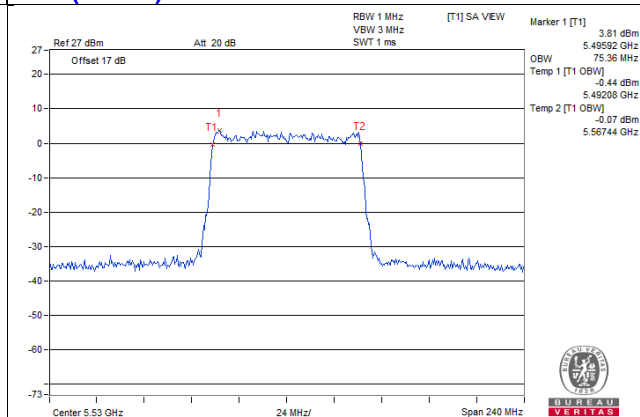

**11ac (80MHz) 1S4T CDD CH58 Chain3**

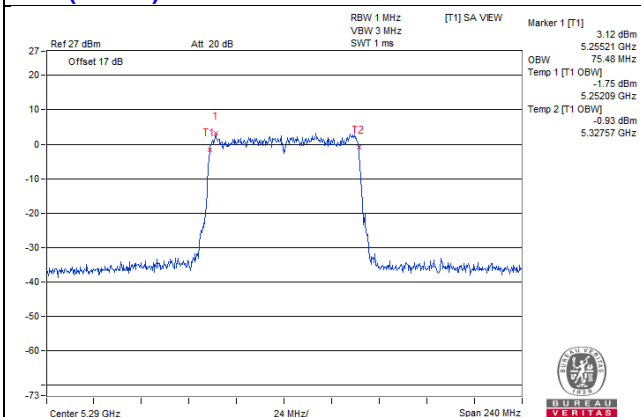

**11ac (80MHz) 1S4T CDD CH106 Chain3**

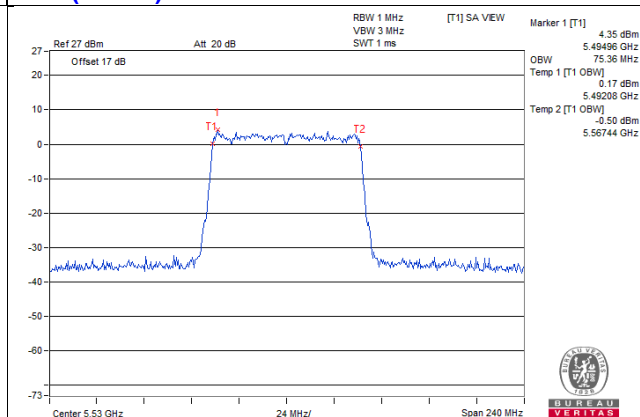

**11ac (80MHz) 1S4T CDD CH58 Chain4**

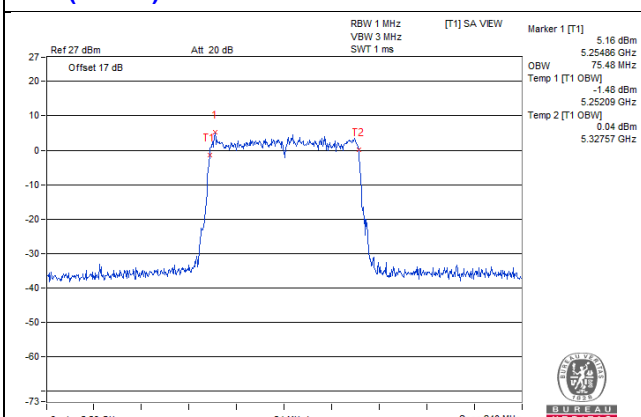

**11ac (80MHz) 1S4T CDD CH106 Chain4**

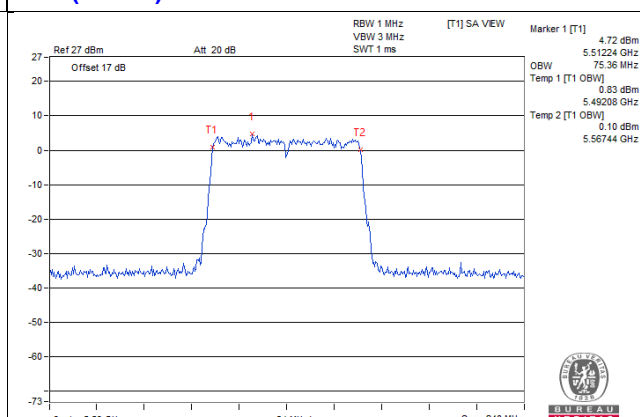

### 99% OCCUPIED BANDWIDTH SPECTRUM PLOT

**11ac (80MHz) 1S4T TxBF CH58 Chain1**

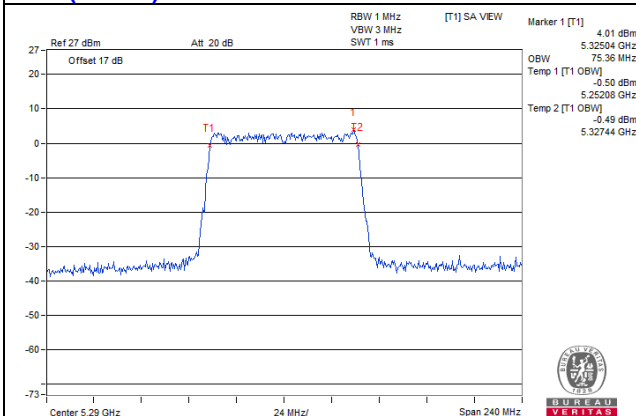

**11ac (80MHz) 1S4T TxBF CH106 Chain1**

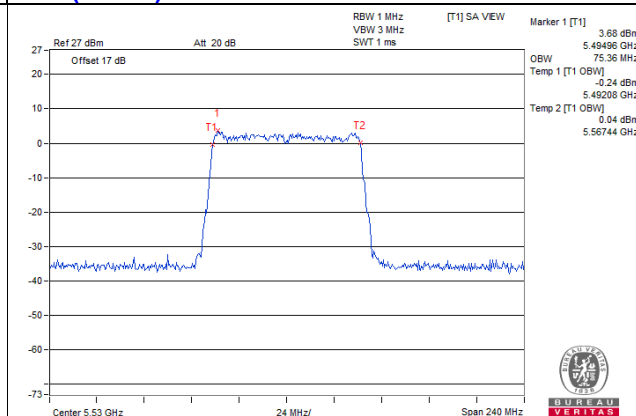

**11ac (80MHz) 1S4T TxBF CH58 Chain2**

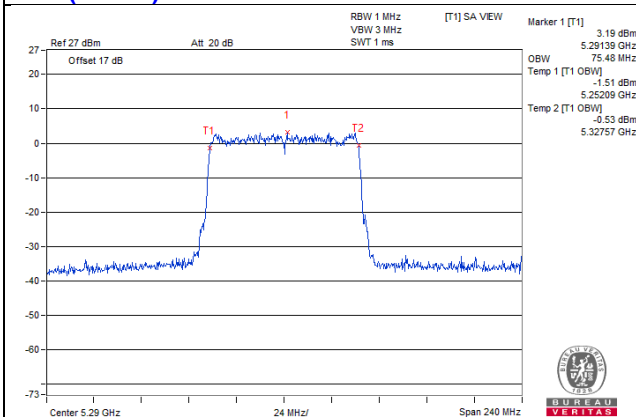

**11ac (80MHz) 1S4T TxBF CH106 Chain2**

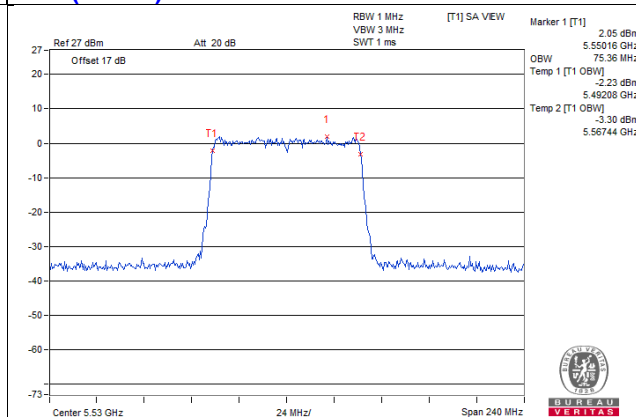

**11ac (80MHz) 1S4T TxBF CH58 Chain3**

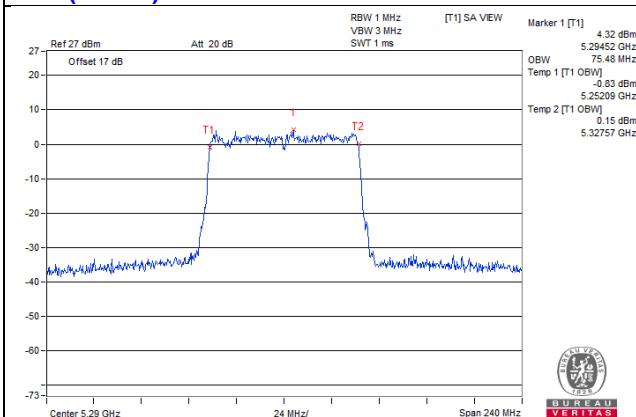

**11ac (80MHz) 1S4T TxBF CH106 Chain3**

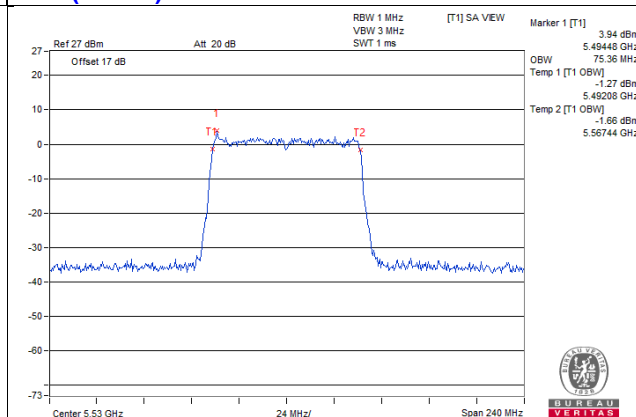

**11ac (80MHz) 1S4T TxBF CH58 Chain4**

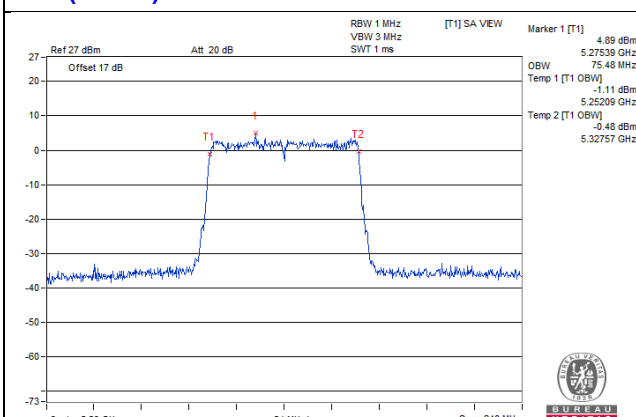

**11ac (80MHz) 1S4T TxBF CH106 Chain4**

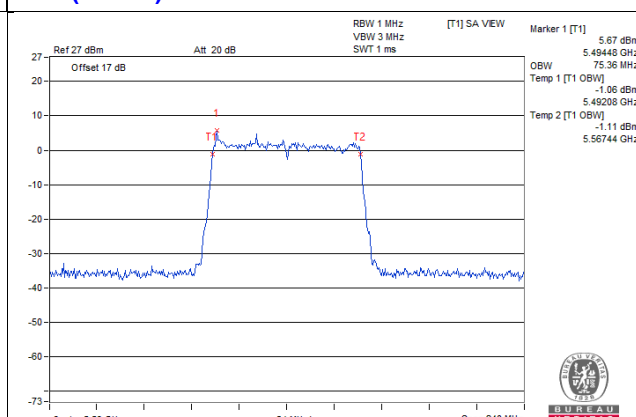

### 4.3 Maximum Conducted Output Power Measurement

#### 4.3.1 Limit

#### Maximum Conducted Output Power

Operation Band	EUT Category		Limit
U-NII-1		Outdoor Access Point	1 Watt (30 dBm) (Max. e.i.r.p $\leq$ 125mW(21 dBm) at any elevation angle above 30 degrees as measured from the horizon)
		Fixed point-to-point Access Point	1 Watt (30 dBm)
		Indoor Access Point	1 Watt (30 dBm)
		Client device	250mW (24 dBm)
U-NII-2A	√		250mW (24 dBm) or 11 dBm+10 log B*
U-NII-2C	√		250mW (24 dBm) or 11 dBm+10 log B*
U-NII-3			1 Watt (30 dBm)

\*B is the 26 dB emission bandwidth in megahertz

Per KDB 662911 Method of conducted output power measurement on IEEE 802.11 devices,

Array Gain = 0 dB (i.e., no array gain) for  $N_{ANT} \leq 4$ ;

Array Gain = 0 dB (i.e., no array gain) for channel widths  $\geq 40$  MHz for any  $N_{ANT}$ ;

Array Gain =  $5 \log(N_{ANT}/N_{SS})$  dB or 3 dB, whichever is less for 20-MHz channel widths with  $N_{ANT} \geq 5$ .

For power measurements on all other devices: Array Gain =  $10 \log(N_{ANT}/N_{SS})$  dB.

#### Transmit Power Control (TPC)

U-NII devices operating in the 5.25-5.35 GHz band and the 5.47-5.725 GHz band shall employ a TPC mechanism. The U-NII device is required to have the capability to operate at least 6 dB below the mean EIRP value of 30 dBm. A TPC mechanism is not required for systems with an e.i.r.p. of less than 500 mW.

#### 4.3.2 Measuring Instruments and Setting

Please refer to section 5 of equipments list in this report. The following table is the setting of the power meter.

Power Meter Parameter	Setting
Filter No.	Auto
Measurement time	8ns
Power Sensor	MA2411B

#### 4.3.3 Test Procedures

##### **Maximum Conducted Output Power**

1. Test was performed in accordance with Measurement of Digital Transmission Systems Operating under KDB789033 D02 General UNII Test Procedures New Rules v01r04, in section “Maximum conducted output power Method (3)”, 05/02/2017.
2. The average power sensor was used on the output port of the EUT. A power meter was used to read the response of the average power sensor to get the all on time transmission. Record the average power level.
3. When measuring maximum conducted output power with multiple antenna systems, add every result of the values by mathematic formula.

##### **Transmit Power Control (TPC)**

1. Test was performed in accordance with Measurement of Digital Transmission Systems Operating under KDB789033 D02 General UNII Test Procedures New Rules v01r04, in section “Maximum conducted output power Method (3)”, 05/02/2017.
2. Set the EUT in RF operation mode, and configure the CH, BW and SSID according to test plan at band 2 and band 3.
3. Use the TPC lowest power level command to measurement the TPC lowest power level.  
`uci set wireless.radio_5G.tx_power_adjust=-7`  
`/etc/init.d/hostapd reload`  
`ubus call wireless.radio get`
4. The average power sensor was used on the output port of the EUT. A power meter was used to read the response of the average power sensor to get the all on time transmission. Record the average power level.
5. When measuring maximum conducted output power with multiple antenna systems, add every result of the values by mathematic formula.

#### 4.3.4 Test Setup Layout

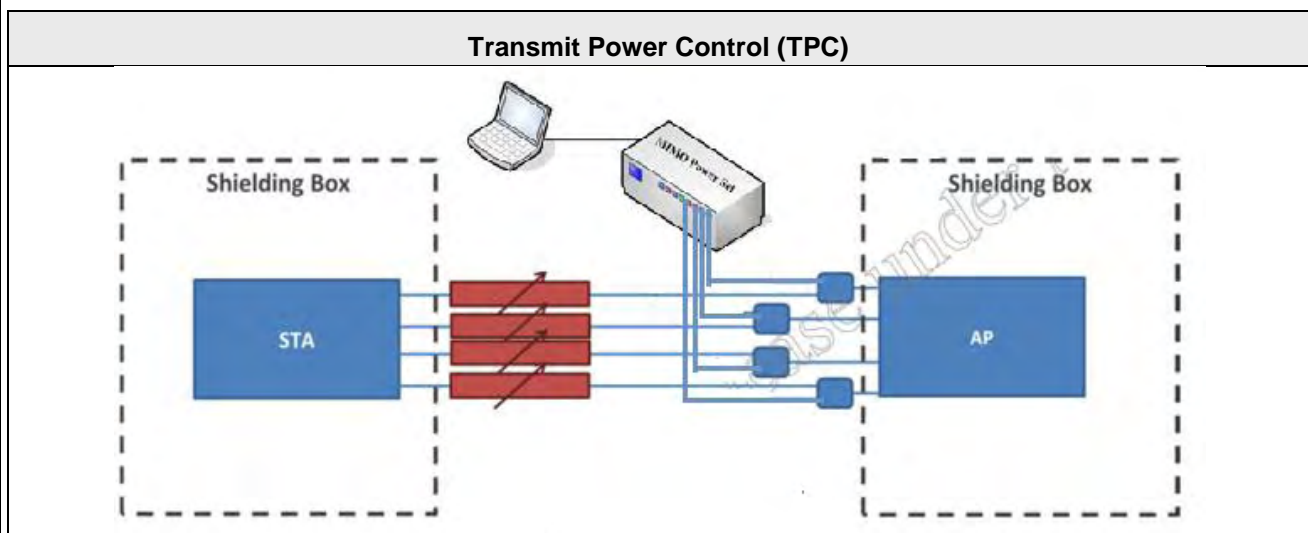
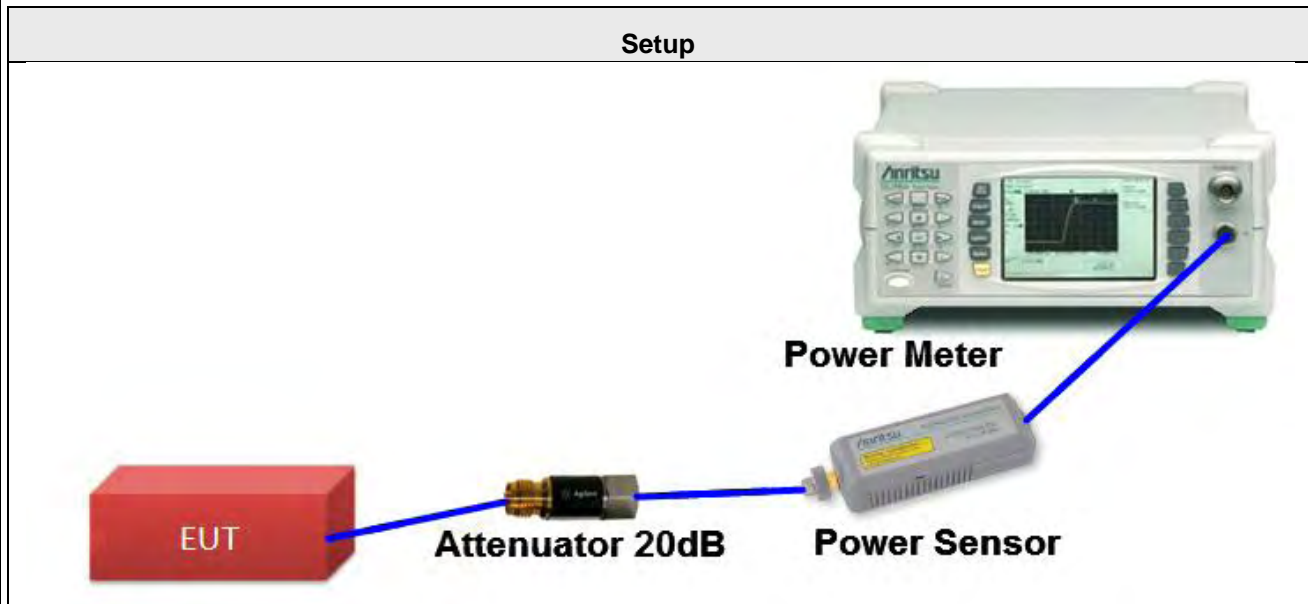

#### 4.3.5 Test Deviation

There are no deviations with the original standard.

#### 4.3.6 EUT Operating Conditions

The EUT was programmed to be in continuously transmitting mode.

#### 4.3.7 Test Results of Maximum Conducted Output Power

Temperature	25°C	Humidity	60%
Test Engineer	Anderson Chen		

#### 11a 1S4T CDD

Channel	Frequency	Conducted Power (dBm)				Total Conducted Power (dBm)	Directional Gain(dBi)	MAX. Limit (dBm)	Result
		Chain1	Chain2	Chain3	Chain4				
52	5260 MHz	15.18	14.97	15.36	15.02	21.16	6.81	23.19	PASS
60	5300 MHz	15.45	14.82	14.98	14.92	21.07	7.75	22.25	PASS
64	5320 MHz	15.35	14.76	15.01	15.11	21.08	6.85	23.15	PASS
100	5500 MHz	15.55	15.23	15.61	15.57	21.51	6.74	23.26	PASS
116	5580 MHz	15.36	15.57	15.22	15.57	21.45	8.04	21.96	PASS
140	5700 MHz	15.28	15.81	15.01	15.12	21.34	6.87	23.13	PASS

- Note: 1. For 5260MHz: Directional gain =  $10 \log[(10^{G1/20} + 10^{G2/20} + \dots + 10^{GN/20})^2/4]$  = 6.81dBi > 6dBi, so the power limit shall be reduced to  $24-(6.81-6) = 23.19\text{dBm}$ .
2. For 5300MHz: Directional gain =  $10 \log[(10^{G1/20} + 10^{G2/20} + \dots + 10^{GN/20})^2/4]$  = 7.75dBi > 6dBi, so the power limit shall be reduced to  $24-(7.75-6) = 22.25\text{dBm}$ .
3. For 5320MHz: Directional gain =  $10 \log[(10^{G1/20} + 10^{G2/20} + \dots + 10^{GN/20})^2/4]$  = 6.85dBi > 6dBi, so the power limit shall be reduced to  $24-(6.85-6) = 23.15\text{dBm}$ .
4. For 5500MHz: Directional gain =  $10 \log[(10^{G1/20} + 10^{G2/20} + \dots + 10^{GN/20})^2/4]$  = 6.74dBi > 6dBi, so the power limit shall be reduced to  $24-(6.74-6) = 23.26\text{dBm}$ .
5. For 5580MHz: Directional gain =  $10 \log[(10^{G1/20} + 10^{G2/20} + \dots + 10^{GN/20})^2/4]$  = 8.04dBi > 6dBi, so the power limit shall be reduced to  $24-(8.04-6) = 21.96\text{dBm}$ .
6. For 5700MHz: Directional gain =  $10 \log[(10^{G1/20} + 10^{G2/20} + \dots + 10^{GN/20})^2/4]$  = 6.87dBi > 6dBi, so the power limit shall be reduced to  $24-(6.87-6) = 23.13\text{dBm}$ .

## 11ac (20MHz) 1S4T CDD

Channel	Frequency	Conducted Power (dBm)				Total Conducted Power (dBm)	Directional Gain(dBi)	MAX. Limit (dBm)	Result
		Chain1	Chain2	Chain3	Chain4				
52	5260 MHz	15.09	14.81	15.21	15.16	21.09	6.81	23.19	PASS
60	5300 MHz	15.12	14.82	15.04	14.92	21.00	7.75	22.25	PASS
64	5320 MHz	15.42	14.73	14.96	14.71	20.99	6.85	23.15	PASS
100	5500 MHz	15.49	15.47	15.26	15.78	21.52	6.74	23.26	PASS
116	5580 MHz	15.39	15.31	15.39	15.21	21.35	8.04	21.96	PASS
140	5700 MHz	15.43	15.14	15.48	15.35	21.37	6.87	23.13	PASS

- Note: 1. For 5260MHz: Directional gain =  $10 \log[(10^{G1/20} + 10^{G2/20} + \dots + 10^{GN/20})^2/4] = 6.81\text{dBi} > 6\text{dBi}$ , so the power limit shall be reduced to  $24-(6.81-6) = 23.19\text{dBm}$ .
2. For 5300MHz: Directional gain =  $10 \log[(10^{G1/20} + 10^{G2/20} + \dots + 10^{GN/20})^2/4] = 7.75\text{dBi} > 6\text{dBi}$ , so the power limit shall be reduced to  $24-(7.75-6) = 22.25\text{dBm}$ .
3. For 5320MHz: Directional gain =  $10 \log[(10^{G1/20} + 10^{G2/20} + \dots + 10^{GN/20})^2/4] = 6.85\text{dBi} > 6\text{dBi}$ , so the power limit shall be reduced to  $24-(6.85-6) = 23.15\text{dBm}$ .
4. For 5500MHz: Directional gain =  $10 \log[(10^{G1/20} + 10^{G2/20} + \dots + 10^{GN/20})^2/4] = 6.74\text{dBi} > 6\text{dBi}$ , so the power limit shall be reduced to  $24-(6.74-6) = 23.26\text{dBm}$ .
5. For 5580MHz: Directional gain =  $10 \log[(10^{G1/20} + 10^{G2/20} + \dots + 10^{GN/20})^2/4] = 8.04\text{dBi} > 6\text{dBi}$ , so the power limit shall be reduced to  $24-(8.04-6) = 21.96\text{dBm}$ .
6. For 5700MHz: Directional gain =  $10 \log[(10^{G1/20} + 10^{G2/20} + \dots + 10^{GN/20})^2/4] = 6.87\text{dBi} > 6\text{dBi}$ , so the power limit shall be reduced to  $24-(6.87-6) = 23.13\text{dBm}$ .

Channel	Frequency	Conducted Power (dBm)				Total Conducted Power (dBm)	Directional Gain(dBi)	TPC Low Power EIRP (dBm)	TPC Low Power EIRP Limit (dBm)	Result
		Chain1	Chain2	Chain3	Chain4					
52	5260 MHz	8.54	7.58	7.81	8.29	14.09	6.81	20.90	24.00	PASS
60	5300 MHz	8.16	7.66	7.98	8.28	14.05	7.75	21.80	24.00	PASS
64	5320 MHz	8.44	7.55	7.62	7.97	13.93	6.85	20.78	24.00	PASS
100	5500 MHz	9.45	7.79	8.86	9.42	14.95	6.74	21.69	24.00	PASS
116	5580 MHz	9.37	7.99	8.79	9.1	14.86	8.04	22.90	24.00	PASS
140	5700 MHz	9.24	8.14	8.89	8.91	14.83	6.87	21.70	24.00	PASS

### 11ac (20MHz) 2S4T CDD

Channel	Frequency	Conducted Power (dBm)				Total Conducted Power (dBm)	Directional Gain(dBi)	MAX. Limit (dBm)	Result
		Chain1	Chain2	Chain3	Chain4				
52	5260 MHz	15.07	14.78	15.18	15.09	21.05	3.88	24.00	PASS
60	5300 MHz	15.09	14.8	15.01	14.91	20.97	4.83	24.00	PASS
64	5320 MHz	15.38	14.71	14.94	14.68	20.96	3.94	24.00	PASS
100	5500 MHz	15.46	15.45	15.24	15.76	21.50	4.03	24.00	PASS
116	5580 MHz	15.37	15.29	15.38	15.58	21.43	5.27	24.00	PASS
140	5700 MHz	15.41	15.47	15.45	15.29	21.43	4.05	24.00	PASS

### 11ac (20MHz) 4S4T SDM

Channel	Frequency	Conducted Power (dBm)				Total Conducted Power (dBm)	Directional Gain(dBi)	MAX. Limit (dBm)	Result
		Chain1	Chain2	Chain3	Chain4				
52	5260 MHz	15.01	14.73	15.13	15.01	20.99	0.95	24.00	PASS
60	5300 MHz	15.02	14.75	14.95	14.82	20.91	1.90	24.00	PASS
64	5320 MHz	15.34	14.66	14.87	14.64	20.91	0.99	24.00	PASS
100	5500 MHz	15.41	15.39	15.19	15.71	21.45	1.03	24.00	PASS
116	5580 MHz	15.32	15.23	15.29	15.53	21.36	2.29	24.00	PASS
140	5700 MHz	15.35	15.41	15.39	15.18	21.35	1.07	24.00	PASS



### 11ac (20MHz) 1S4T TxBF

Channel	Frequency	Conducted Power (dBm)				Total Conducted Power (dBm)	Directional Gain(dBi)	MAX. Limit (dBm)	Result
		Chain1	Chain2	Chain3	Chain4				
52	5260 MHz	14.86	15.29	15.55	15.55	21.34	6.81	23.19	PASS
60	5300 MHz	14.61	14.68	15.37	15.21	21.00	7.75	22.25	PASS
64	5320 MHz	14.74	14.77	15.6	15.28	21.13	6.85	23.15	PASS
100	5500 MHz	15.91	15.72	15.63	15.68	21.76	6.74	23.26	PASS
116	5580 MHz	15.38	15.41	15.39	15.51	21.44	8.04	21.96	PASS
140	5700 MHz	14.81	14.62	14.15	14.68	20.59	6.87	23.13	PASS

- Note: 1. For 5260MHz: Directional gain =  $10 \log[(10^{G1/20} + 10^{G2/20} + \dots + 10^{GN/20})^2/4] = 6.81\text{dBi} > 6\text{dBi}$ , so the power limit shall be reduced to  $24-(6.81-6) = 23.19\text{dBm}$ .
2. For 5300MHz: Directional gain =  $10 \log[(10^{G1/20} + 10^{G2/20} + \dots + 10^{GN/20})^2/4] = 7.75\text{dBi} > 6\text{dBi}$ , so the power limit shall be reduced to  $24-(7.75-6) = 22.25\text{dBm}$ .
3. For 5320MHz: Directional gain =  $10 \log[(10^{G1/20} + 10^{G2/20} + \dots + 10^{GN/20})^2/4] = 6.85\text{dBi} > 6\text{dBi}$ , so the power limit shall be reduced to  $24-(6.85-6) = 23.15\text{dBm}$ .
4. For 5500MHz: Directional gain =  $10 \log[(10^{G1/20} + 10^{G2/20} + \dots + 10^{GN/20})^2/4] = 6.74\text{dBi} > 6\text{dBi}$ , so the power limit shall be reduced to  $24-(6.74-6) = 23.26\text{dBm}$ .
5. For 5580MHz: Directional gain =  $10 \log[(10^{G1/20} + 10^{G2/20} + \dots + 10^{GN/20})^2/4] = 8.04\text{dBi} > 6\text{dBi}$ , so the power limit shall be reduced to  $24-(8.04-6) = 21.96\text{dBm}$ .
6. For 5700MHz: Directional gain =  $10 \log[(10^{G1/20} + 10^{G2/20} + \dots + 10^{GN/20})^2/4] = 6.87\text{dBi} > 6\text{dBi}$ , so the power limit shall be reduced to  $24-(6.87-6) = 23.13\text{dBm}$ .

### 11ac (20MHz) 2S4T TxBF

Channel	Frequency	Conducted Power (dBm)				Total Conducted Power (dBm)	Directional Gain(dBi)	MAX. Limit (dBm)	Result
		Chain1	Chain2	Chain3	Chain4				
52	5260 MHz	14.82	15.25	15.51	15.51	21.30	3.88	24.00	PASS
60	5300 MHz	14.57	14.63	15.33	15.18	20.96	4.83	24.00	PASS
64	5320 MHz	14.68	14.75	15.54	15.24	21.09	3.94	24.00	PASS
100	5500 MHz	15.86	15.68	15.58	15.65	21.71	4.03	24.00	PASS
116	5580 MHz	15.36	15.34	15.3	15.42	21.38	5.27	24.00	PASS
140	5700 MHz	13.62	13.86	13.82	13.95	19.83	4.05	24.00	PASS

## 11ac (20MHz) 3S4T TxBF

Channel	Frequency	Conducted Power (dBm)				Total Conducted Power (dBm)	Directional Gain(dBi)	MAX. Limit (dBm)	Result
		Chain1	Chain2	Chain3	Chain4				
52	5260 MHz	14.78	15.23	15.48	15.49	21.27	2.20	24.00	PASS
60	5300 MHz	14.52	14.6	15.28	15.14	20.92	3.15	24.00	PASS
64	5320 MHz	14.63	14.69	15.49	15.2	21.04	2.23	24.00	PASS
100	5500 MHz	15.82	15.64	15.54	15.61	21.67	2.28	24.00	PASS
116	5580 MHz	15.31	15.31	15.27	15.38	21.34	3.54	24.00	PASS
140	5700 MHz	13.58	13.68	13.78	13.91	19.76	2.32	24.00	PASS

### 11ac (40MHz) 1S4T CDD

Channel	Frequency	Conducted Power (dBm)				Total Conducted Power (dBm)	Directional Gain(dBi)	MAX. Limit (dBm)	Result
		Chain1	Chain2	Chain3	Chain4				
54	5270 MHz	15.55	14.98	15.47	15.25	21.34	7.89	22.11	PASS
62	5310 MHz	13.76	12.92	13.34	13.65	19.45	7.32	22.68	PASS
102	5510 MHz	14.55	13.89	13.77	14.18	20.13	6.74	23.26	PASS
110	5550 MHz	16.45	16.68	16.12	16.34	22.42	7.07	22.93	PASS
134	5670 MHz	16.32	16.82	16.67	16.63	22.63	6.49	23.51	PASS

### 11ac (40MHz) 2S4T CDD

Channel	Frequency	Conducted Power (dBm)				Total Conducted Power (dBm)	Directional Gain(dBi)	MAX. Limit (dBm)	Result
		Chain1	Chain2	Chain3	Chain4				
54	5270 MHz	15.52	14.95	15.44	15.21	21.31	5.00	24.00	PASS
62	5310 MHz	13.73	12.89	13.31	13.62	19.42	4.47	24.00	PASS
102	5510 MHz	14.53	13.85	13.74	14.15	20.10	3.99	24.00	PASS
110	5550 MHz	16.42	16.65	16.08	16.31	22.39	4.11	24.00	PASS
134	5670 MHz	16.28	16.78	16.65	16.59	22.60	3.59	24.00	PASS

### 11ac (40MHz) 4S4T SDM

Channel	Frequency	Conducted Power (dBm)				Total Conducted Power (dBm)	Directional Gain(dBi)	MAX. Limit (dBm)	Result
		Chain1	Chain2	Chain3	Chain4				
54	5270 MHz	15.42	14.86	15.29	15.11	21.20	2.09	24.00	PASS
62	5310 MHz	13.65	12.78	13.16	13.51	19.31	1.52	24.00	PASS
102	5510 MHz	14.45	13.75	13.65	14.08	20.01	1.01	24.00	PASS
110	5550 MHz	16.31	16.56	15.98	16.21	22.29	1.10	24.00	PASS
134	5670 MHz	16.21	16.68	16.55	16.51	22.51	0.72	24.00	PASS

### 11ac (40MHz) 1S4T TxBF

Channel	Frequency	Conducted Power (dBm)				Total Conducted Power (dBm)	Directional Gain(dBi)	MAX. Limit (dBm)	Result
		Chain1	Chain2	Chain3	Chain4				
54	5270 MHz	15.62	15.35	15.47	15.15	21.42	7.89	22.11	PASS
62	5310 MHz	12.58	12.62	12.35	12.41	18.51	7.32	22.68	PASS
102	5510 MHz	13.02	12.93	13.07	13.44	19.14	6.74	23.26	PASS
110	5550 MHz	16.22	16.56	16.35	16.46	22.42	7.07	22.93	PASS
134	5670 MHz	16.34	17.02	16.25	16.62	22.59	6.49	23.51	PASS

- Note: 1. For 5270MHz: Directional gain =  $10 \log[(10^{G1/20} + 10^{G2/20} + \dots + 10^{GN/20})^2/4] = 7.89\text{dBi} > 6\text{dBi}$ , so the power limit shall be reduced to  $24-(7.89-6) = 22.11\text{dBm}$ .
2. For 5310MHz: Directional gain =  $10 \log[(10^{G1/20} + 10^{G2/20} + \dots + 10^{GN/20})^2/4] = 7.32\text{dBi} > 6\text{dBi}$ , so the power limit shall be reduced to  $24-(7.32-6) = 22.68\text{dBm}$ .
3. For 5510MHz: Directional gain =  $10 \log[(10^{G1/20} + 10^{G2/20} + \dots + 10^{GN/20})^2/4] = 6.74\text{dBi} > 6\text{dBi}$ , so the power limit shall be reduced to  $24-(6.74-6) = 23.26\text{dBm}$ .
4. For 5550MHz: Directional gain =  $10 \log[(10^{G1/20} + 10^{G2/20} + \dots + 10^{GN/20})^2/4] = 7.07\text{dBi} > 6\text{dBi}$ , so the power limit shall be reduced to  $24-(7.07-6) = 22.93\text{dBm}$ .
5. For 5670MHz: Directional gain =  $10 \log[(10^{G1/20} + 10^{G2/20} + \dots + 10^{GN/20})^2/4] = 6.49\text{dBi} > 6\text{dBi}$ , so the power limit shall be reduced to  $24-(6.49-6) = 23.51\text{dBm}$ .

### 11ac (40MHz) 2S4T TxBF

Channel	Frequency	Conducted Power (dBm)				Total Conducted Power (dBm)	Directional Gain(dBi)	MAX. Limit (dBm)	Result
		Chain1	Chain2	Chain3	Chain4				
54	5270 MHz	15.56	15.31	15.44	15.11	21.38	5.00	24.00	PASS
62	5310 MHz	12.53	12.58	12.31	12.38	18.47	4.47	24.00	PASS
102	5510 MHz	12.98	12.89	12.99	13.41	19.09	3.99	24.00	PASS
110	5550 MHz	16.19	16.51	16.31	16.42	22.38	4.11	24.00	PASS
134	5670 MHz	16.31	16.98	16.2	16.58	22.55	3.59	24.00	PASS

### 11ac (40MHz) 3S4T TxBF

Channel	Frequency	Conducted Power (dBm)				Total Conducted Power (dBm)	Directional Gain(dBi)	MAX. Limit (dBm)	Result
		Chain1	Chain2	Chain3	Chain4				
54	5270 MHz	15.52	15.26	15.37	15.06	21.33	3.33	24.00	PASS
62	5310 MHz	12.48	12.52	12.26	12.32	18.42	2.76	24.00	PASS
102	5510 MHz	12.95	12.81	12.92	13.34	19.03	2.25	24.00	PASS
110	5550 MHz	16.12	16.38	16.24	16.36	22.30	2.35	24.00	PASS
134	5670 MHz	16.28	16.92	16.12	16.51	22.49	2.63	24.00	PASS

### 11ac (80MHz) 1S4T CDD

Channel	Frequency	Conducted Power (dBm)				Total Conducted Power (dBm)	Directional Gain(dBi)	MAX. Limit (dBm)	Result
		Chain1	Chain2	Chain3	Chain4				
58	5290 MHz	12.94	11.81	12.23	12.22	18.34	7.31	22.69	PASS
106	5530 MHz	13.12	13.04	13.07	13.32	19.16	6.99	23.01	PASS

- Note: 1. For 5290MHz: Directional gain =  $10 \log[(10^{G1/20} + 10^{G2/20} + \dots + 10^{GN/20})^2/4] = 7.31\text{dBi} > 6\text{dBi}$ , so the power limit shall be reduced to  $24-(7.31-6) = 22.69\text{dBm}$ .
2. For 5530MHz: Directional gain =  $10 \log[(10^{G1/20} + 10^{G2/20} + \dots + 10^{GN/20})^2/4] = 6.99\text{dBi} > 6\text{dBi}$ , so the power limit shall be reduced to  $24-(6.99-6) = 23.01\text{dBm}$ .

### 11ac (80MHz) 2S4T CDD

Channel	Frequency	Conducted Power (dBm)				Total Conducted Power (dBm)	Directional Gain(dBi)	MAX. Limit (dBm)	Result
		Chain1	Chain2	Chain3	Chain4				
58	5290 MHz	12.92	11.78	12.19	12.11	18.29	4.40	24.00	PASS
106	5530 MHz	13.05	12.98	13.02	13.25	19.10	4.03	24.00	PASS

### 11ac (80MHz) 4S4T SDM

Channel	Frequency	Conducted Power (dBm)				Total Conducted Power (dBm)	Directional Gain(dBi)	MAX. Limit (dBm)	Result
		Chain1	Chain2	Chain3	Chain4				
58	5290 MHz	12.84	11.69	12.06	12.01	18.19	1.47	24.00	PASS
106	5530 MHz	12.98	12.88	12.92	13.18	19.01	1.05	24.00	PASS

### 11ac (80MHz) 1S4T TxBF

Channel	Frequency	Conducted Power (dBm)				Total Conducted Power (dBm)	Directional Gain(dBi)	MAX. Limit (dBm)	Result
		Chain1	Chain2	Chain3	Chain4				
58	5290 MHz	12.52	12.01	12.42	11.93	18.25	7.31	22.69	PASS
106	5530 MHz	12.21	11.62	12.06	12.24	18.06	6.99	23.01	PASS

- Note: 1. For 5290MHz: Directional gain =  $10 \log[(10^{G1/20} + 10^{G2/20} + \dots + 10^{GN/20})^2/4] = 7.31\text{dBi} > 6\text{dBi}$ , so the power limit shall be reduced to  $24-(7.31-6) = 22.69\text{dBm}$ .
2. For 5530MHz: Directional gain =  $10 \log[(10^{G1/20} + 10^{G2/20} + \dots + 10^{GN/20})^2/4] = 6.99\text{dBi} > 6\text{dBi}$ , so the power limit shall be reduced to  $24-(6.99-6) = 23.01\text{dBm}$ .

### 11ac (80MHz) 2S4T TxBF

Channel	Frequency	Conducted Power (dBm)				Total Conducted Power (dBm)	Directional Gain(dBi)	MAX. Limit (dBm)	Result
		Chain1	Chain2	Chain3	Chain4				
58	5290 MHz	12.46	11.95	12.35	11.89	18.19	4.40	24.00	PASS
106	5530 MHz	12.15	11.58	11.98	12.18	18.00	4.03	24.00	PASS

### 11ac (80MHz) 3S4T TxBF

Channel	Frequency	Conducted Power (dBm)				Total Conducted Power (dBm)	Directional Gain(dBi)	MAX. Limit (dBm)	Result
		Chain1	Chain2	Chain3	Chain4				
58	5290 MHz	12.42	11.92	12.3	11.83	18.15	2.72	24.00	PASS
106	5530 MHz	12.13	11.52	11.92	12.14	17.96	2.29	24.00	PASS

#### 4.4 Power Spectral Density Measurement

##### 4.4.1 Limit

Operation Band	EUT Category		Limit
U-NII-1		Outdoor Access Point	17dBm/ MHz
		Fixed point-to-point Access Point	
		Indoor Access Point	
		Client device	11dBm/ MHz
U-NII-2A	√		11dBm/ MHz
U-NII-2C	√		11dBm/ MHz
U-NII-3			30dBm/ 500kHz

##### 4.4.2 Measuring Instruments and Setting

Please refer to section 5 of equipments list in this report. The following table is the setting of the spectrum analyzer.

Spectrum Parameter Setting	Setting
Attenuation	Auto
Span Frequency	Encompass the entire emissions bandwidth (EBW) of the signal
RBW	1 MHz
VBW	≥ 3 MHz
Detector	RMS
Trace	Average
Sweep Time	Auto, trigger set to "free run"
Trace average	100 times

#### 4.4.3 Test Procedure

- 1 The transmitter output (antenna port) was connected RF switch to the spectrum analyzer.
- 2 For U-NII-1, U-NII-2A & U-NII-2C Bands, PSD Measure was performed in accordance with 789033 D02 General UNII Test Procedures New Rules v01r04, in section “Maximum conducted output power (E)(2)(d) Method SA-2”, 05/02/2017.
- 3 For U-NII-3 Band, PSD Measure was performed in accordance with 789033 D02 General UNII Test Procedures New Rules v01r04, in section “Maximum Power Spectral Density (F)(5)”, 05/02/2017
- 4 Multiple antenna systems was performed in accordance 662911 D01 Multiple Transmitter Output v02r01 in-Band Power Spectral Density (PSD) Measurements (a) Measure and sum the spectra across the outputs (bin-by-bin summing).
- 5 When measuring first spectral bin of output 1 is summed with that in the first spectral bin of output 2 and that from the first spectral bin of output 3 and so on up to the Nth output to obtain the value for the first frequency bin of the summed spectrum.
- 6 The summed spectrum value for each of the other frequency bins is computed in the same way.

#### 4.4.4 Test Setup Layout

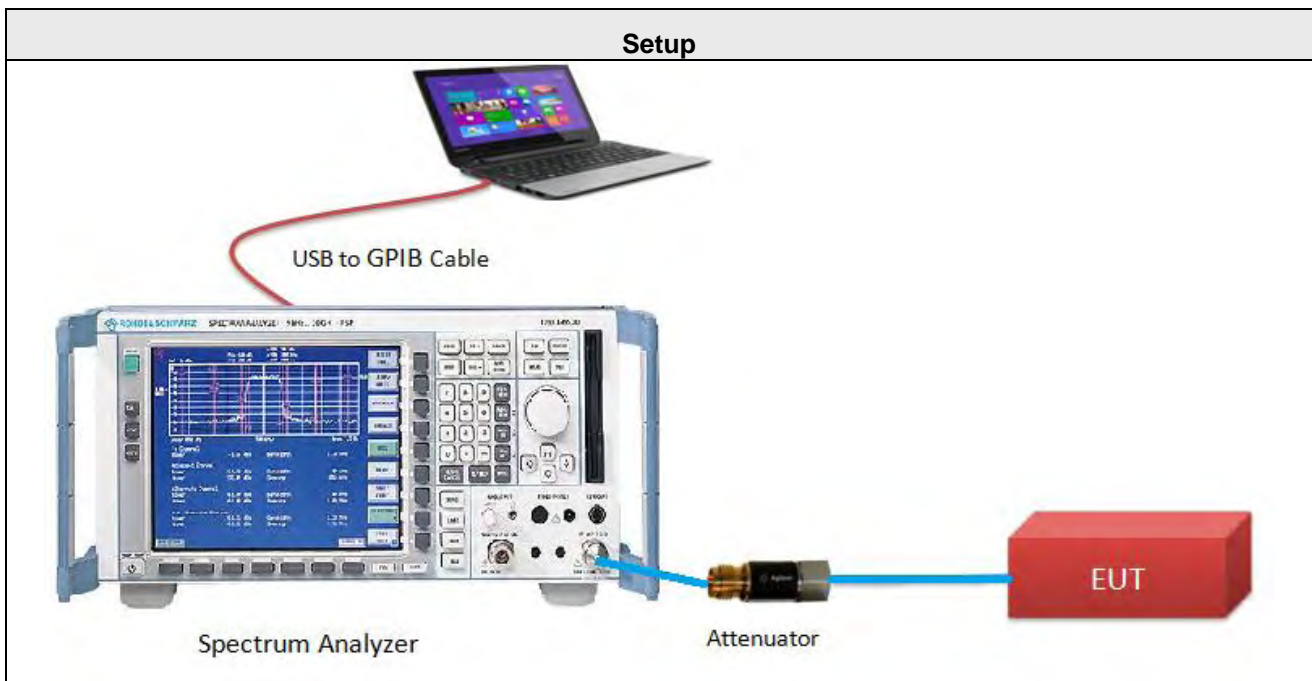

#### 4.4.5 Test Deviation

There are no deviations with the original standard.

#### 4.4.6 EUT Operating Conditions

The EUT was programmed to be in continuously transmitting mode.



#### 4.4.7 Test Results

Temperature	25°C	Humidity	60%
Test Engineer	Robert Cheng		

#### 11a 1S4T CDD

Chan.	Chan. Freq. (MHz)	PSD (dBm/MHz)	Duty Factor (dB)	Total PSD with duty factor (dBm/MHz)	Directional Gain(dBi)	MAX. Limit (dBm/MHz)	Result
52	5260	8.68	0.41	9.09	6.81	10.19	Pass
60	5300	8.14	0.41	8.55	7.75	9.25	Pass
64	5320	8.44	0.41	8.85	6.85	10.15	Pass
100	5500	8.34	0.41	8.75	6.74	10.26	Pass
116	5580	8.29	0.41	8.70	8.04	8.96	Pass
140	5700	8.44	0.41	8.85	6.87	10.13	Pass

- Note:
- Total PSD (dBm/MHz) = PSD(dBm/MHz) + Duty Factor (dB)
  - For 5260MHz: Directional gain =  $10 \log[(10^{G1/20} + 10^{G2/20} + \dots + 10^{GN/20})^2/4]$  = 6.81dBi < 6dBi, so the power density limit shall be reduced to  $11-(6.81-6) = 10.19\text{dBm}$ .
  - For 5300MHz: Directional gain =  $10 \log[(10^{G1/20} + 10^{G2/20} + \dots + 10^{GN/20})^2/4]$  = 7.75dBi > 6dBi, so the power density limit shall be reduced to  $11-(7.75-6) = 9.25\text{dBm}$ .
  - For 5320MHz: Directional gain =  $10 \log[(10^{G1/20} + 10^{G2/20} + \dots + 10^{GN/20})^2/4]$  = 6.85dBi > 6dBi, so the power density limit shall be reduced to  $11-(6.85-6) = 10.15\text{dBm}$ .
  - For 5500MHz: Directional gain =  $10 \log[(10^{G1/20} + 10^{G2/20} + \dots + 10^{GN/20})^2/4]$  = 6.74dBi > 6dBi, so the power density limit shall be reduced to  $24-(6.74-6) = 10.26\text{dBm}$ .
  - For 5580MHz: Directional gain =  $10 \log[(10^{G1/20} + 10^{G2/20} + \dots + 10^{GN/20})^2/4]$  = 8.04dBi > 6dBi, so the power density limit shall be reduced to  $24-(8.04-6) = 8.96\text{dBm}$ .
  - For 5700MHz: Directional gain =  $10 \log[(10^{G1/20} + 10^{G2/20} + \dots + 10^{GN/20})^2/4]$  = 6.87dBi > 6dBi, so the power density limit shall be reduced to  $24-(6.87-6) = 10.13\text{dBm}$ .

**11ac (20MHz) 1S4T CDD**

Chan.	Chan. Freq. (MHz)	PSD (dBm/MHz)	Duty Factor (dB)	Total PSD with duty factor (dBm/MHz)	Directional Gain(dBi)	MAX. Limit (dBm/MHz)	Result
52	5260	8.62	0.00	8.62	6.81	10.19	Pass
60	5300	8.34	0.00	8.34	7.75	9.25	Pass
64	5320	8.34	0.00	8.34	6.85	10.15	Pass
100	5500	8.51	0.00	8.51	6.74	10.26	Pass
116	5580	8.13	0.00	8.13	8.04	8.96	Pass
140	5700	8.46	0.00	8.46	6.87	10.13	Pass

Note: 1. Total PSD (dBm/MHz) = PSD(dBm/MHz) + Duty Factor (dB)

2. For 5260MHz: Directional gain =  $10 \log[(10^{G1/20} + 10^{G2/20} + \dots + 10^{GN/20})^2/4] = 6.81\text{dBi} > 6\text{dBi}$ , so the power density limit shall be reduced to  $11-(6.81-6) = 10.19\text{dBm}$ .
3. For 5300MHz: Directional gain =  $10 \log[(10^{G1/20} + 10^{G2/20} + \dots + 10^{GN/20})^2/4] = 7.75\text{dBi} > 6\text{dBi}$ , so the power density limit shall be reduced to  $11-(7.75-6) = 9.25\text{dBm}$ .
4. For 5320MHz: Directional gain =  $10 \log[(10^{G1/20} + 10^{G2/20} + \dots + 10^{GN/20})^2/4] = 6.85\text{dBi} > 6\text{dBi}$ , so the power density limit shall be reduced to  $11-(6.85-6) = 10.15\text{dBm}$ .
5. For 5500MHz: Directional gain =  $10 \log[(10^{G1/20} + 10^{G2/20} + \dots + 10^{GN/20})^2/4] = 6.74\text{dBi} > 6\text{dBi}$ , so the power density limit shall be reduced to  $11-(6.74-6) = 10.26\text{dBm}$ .
6. For 5580MHz: Directional gain =  $10 \log[(10^{G1/20} + 10^{G2/20} + \dots + 10^{GN/20})^2/4] = 8.04\text{dBi} > 6\text{dBi}$ , so the power density limit shall be reduced to  $11-(8.04-6) = 8.96\text{dBm}$ .
7. For 5700MHz: Directional gain =  $10 \log[(10^{G1/20} + 10^{G2/20} + \dots + 10^{GN/20})^2/4] = 6.87\text{dBi} > 6\text{dBi}$ , so the power density limit shall be reduced to  $11-(6.87-6) = 10.13\text{dBm}$ .

**11ac (20MHz) 1S4T TxBF**

Chan.	Chan. Freq. (MHz)	PSD (dBm/MHz)	Duty Factor (dB)	Total PSD with duty factor (dBm/MHz)	Directional Gain(dBi)	MAX. Limit (dBm/MHz)	Result
52	5260	8.65	0.00	8.65	6.81	10.19	Pass
60	5300	8.34	0.00	8.34	7.75	9.25	Pass
64	5320	8.24	0.00	8.24	6.85	10.15	Pass
100	5500	8.11	0.00	8.11	6.74	10.26	Pass
116	5580	8.03	0.00	8.03	8.04	8.96	Pass
140	5700	7.33	0.00	7.33	6.87	10.13	Pass

Note: 1. Total PSD (dBm/MHz) = PSD(dBm/MHz) + Duty Factor (dB)

2. For 5260MHz: Directional gain =  $10 \log[(10^{G1/20} + 10^{G2/20} + \dots + 10^{GN/20})^2/4] = 6.81\text{dBi} > 6\text{dBi}$ , so the power density limit shall be reduced to  $11-(6.81-6) = 10.19\text{dBm}$ .
3. For 5300MHz: Directional gain =  $10 \log[(10^{G1/20} + 10^{G2/20} + \dots + 10^{GN/20})^2/4] = 7.75\text{dBi} > 6\text{dBi}$ , so the power density limit shall be reduced to  $11-(7.75-6) = 9.25\text{dBm}$ .
4. For 5320MHz: Directional gain =  $10 \log[(10^{G1/20} + 10^{G2/20} + \dots + 10^{GN/20})^2/4] = 6.85\text{dBi} > 6\text{dBi}$ , so the power density limit shall be reduced to  $11-(6.85-6) = 10.15\text{dBm}$ .
5. For 5500MHz: Directional gain =  $10 \log[(10^{G1/20} + 10^{G2/20} + \dots + 10^{GN/20})^2/4] = 6.74\text{dBi} > 6\text{dBi}$ , so the power density limit shall be reduced to  $11-(6.74-6) = 10.26\text{dBm}$ .
6. For 5580MHz: Directional gain =  $10 \log[(10^{G1/20} + 10^{G2/20} + \dots + 10^{GN/20})^2/4] = 8.04\text{dBi} > 6\text{dBi}$ , so the power density limit shall be reduced to  $11-(8.04-6) = 8.96\text{dBm}$ .
7. For 5700MHz: Directional gain =  $10 \log[(10^{G1/20} + 10^{G2/20} + \dots + 10^{GN/20})^2/4] = 6.87\text{dBi} > 6\text{dBi}$ , so the power density limit shall be reduced to  $11-(6.87-6) = 10.13\text{dBm}$ .

### 11ac (40MHz) 1S4T CDD

Chan.	Chan. Freq. (MHz)	PSD (dBm/MHz)	Duty Factor (dB)	Total PSD with duty factor (dBm/MHz)	Directional Gain(dBi)	MAX. Limit (dBm/MHz)	Result
54	5270	5.73	0.00	5.73	7.89	9.11	Pass
62	5310	3.86	0.00	3.86	7.32	9.68	Pass
102	5510	3.75	0.00	3.75	6.74	10.26	Pass
110	5550	6.33	0.00	6.33	7.07	9.93	Pass
134	5670	6.34	0.00	6.34	6.49	10.51	Pass

Note: 1. Total PSD (dBm/MHz) = PSD(dBm/MHz) + Duty Factor (dB)

- For 5270MHz: Directional gain =  $10 \log[(10^{G1/20} + 10^{G2/20} + \dots + 10^{GN/20})^2/4] = 7.89\text{dBi} > 6\text{dBi}$ , so the power density limit shall be reduced to  $11-(7.89-6) = 9.11\text{dBm}$ .
- For 5310MHz: Directional gain =  $10 \log[(10^{G1/20} + 10^{G2/20} + \dots + 10^{GN/20})^2/4] = 7.32\text{dBi} > 6\text{dBi}$ , so the power density limit shall be reduced to  $11-(7.32-6) = 9.68\text{dBm}$ .
- For 5510MHz: Directional gain =  $10 \log[(10^{G1/20} + 10^{G2/20} + \dots + 10^{GN/20})^2/4] = 6.74\text{dBi} > 6\text{dBi}$ , so the power density limit shall be reduced to  $11-(6.74-6) = 10.26\text{dBm}$ .
- For 5550MHz: Directional gain =  $10 \log[(10^{G1/20} + 10^{G2/20} + \dots + 10^{GN/20})^2/4] = 7.07\text{dBi} > 6\text{dBi}$ , so the power density limit shall be reduced to  $11-(7.07-6) = 9.93\text{dBm}$ .
- For 5670MHz: Directional gain =  $10 \log[(10^{G1/20} + 10^{G2/20} + \dots + 10^{GN/20})^2/4] = 6.49\text{dBi} > 6\text{dBi}$ , so the power density limit shall be reduced to  $11-(6.49-6) = 10.51\text{dBm}$ .

### 11ac (40MHz) 1S4T TxBF

Chan.	Chan. Freq. (MHz)	PSD (dBm/MHz)	Duty Factor (dB)	Total PSD with duty factor (dBm/MHz)	Directional Gain(dBi)	MAX. Limit (dBm/MHz)	Result
54	5270	5.73	0.00	5.73	7.89	9.11	Pass
62	5310	2.68	0.00	2.68	7.32	9.68	Pass
102	5510	2.88	0.00	2.88	6.74	10.26	Pass
110	5550	6.37	0.00	6.37	7.07	9.93	Pass
134	5670	6.21	0.00	6.21	6.49	10.51	Pass

Note: 1. Total PSD (dBm/MHz) = PSD(dBm/MHz) + Duty Factor (dB)

- For 5270MHz: Directional gain =  $10 \log[(10^{G1/20} + 10^{G2/20} + \dots + 10^{GN/20})^2/4] = 7.89\text{dBi} > 6\text{dBi}$ , so the power density limit shall be reduced to  $11-(7.89-6) = 9.11\text{dBm}$ .
- For 5310MHz: Directional gain =  $10 \log[(10^{G1/20} + 10^{G2/20} + \dots + 10^{GN/20})^2/4] = 7.32\text{dBi} > 6\text{dBi}$ , so the power density limit shall be reduced to  $11-(7.32-6) = 9.68\text{dBm}$ .
- For 5510MHz: Directional gain =  $10 \log[(10^{G1/20} + 10^{G2/20} + \dots + 10^{GN/20})^2/4] = 6.74\text{dBi} > 6\text{dBi}$ , so the power density limit shall be reduced to  $11-(6.74-6) = 10.26\text{dBm}$ .
- For 5550MHz: Directional gain =  $10 \log[(10^{G1/20} + 10^{G2/20} + \dots + 10^{GN/20})^2/4] = 7.07\text{dBi} > 6\text{dBi}$ , so the power density limit shall be reduced to  $11-(7.07-6) = 9.93\text{dBm}$ .
- For 5670MHz: Directional gain =  $10 \log[(10^{G1/20} + 10^{G2/20} + \dots + 10^{GN/20})^2/4] = 6.49\text{dBi} > 6\text{dBi}$ , so the power density limit shall be reduced to  $11-(6.49-6) = 10.51\text{dBm}$ .

### 11ac (80MHz) 1S4T CDD

Chan.	Chan. Freq. (MHz)	PSD (dBm/MHz)	Duty Factor (dB)	Total PSD with duty factor (dBm/MHz)	Directional Gain(dBi)	MAX. Limit (dBm/MHz)	Result
58	5290	0.13	0.00	0.13	7.31	9.69	Pass
106	5530	0.37	0.00	0.37	6.99	10.01	Pass

- Note:
- Total PSD (dBm/MHz) = PSD(dBm/MHz) + Duty Factor (dB)
  - For 5290MHz: Directional gain =  $10 \log[(10^{G1/20} + 10^{G2/20} + \dots + 10^{GN/20})^2/4]$  = 7.31dBi > 6dBi, so the power density limit shall be reduced to  $11-(7.31-6) = 9.69$ dBm.
  - For 5530MHz: Directional gain =  $10 \log[(10^{G1/20} + 10^{G2/20} + \dots + 10^{GN/20})^2/4]$  = 6.99dBi > 6dBi, so the power density limit shall be reduced to  $11-(6.99-6) = 10.01$ dBm.

### 11ac (80MHz) 1S4T TxBF

Chan.	Chan. Freq. (MHz)	PSD (dBm/MHz)	Duty Factor (dB)	Total PSD with duty factor (dBm/MHz)	Directional Gain(dBi)	MAX. Limit (dBm/MHz)	Result
58	5290	0.08	0.00	0.08	7.31	9.69	Pass
106	5530	-0.52	0.00	-0.52	6.99	10.01	Pass

- Note:
- Total PSD (dBm/MHz) = PSD(dBm/MHz) + Duty Factor (dB)
  - For 5290MHz: Directional gain =  $10 \log[(10^{G1/20} + 10^{G2/20} + \dots + 10^{GN/20})^2/4]$  = 7.31dBi > 6dBi, so the power density limit shall be reduced to  $11-(7.31-6) = 9.69$ dBm.
  - For 5530MHz: Directional gain =  $10 \log[(10^{G1/20} + 10^{G2/20} + \dots + 10^{GN/20})^2/4]$  = 6.99dBi > 6dBi, so the power density limit shall be reduced to  $11-(6.99-6) = 10.01$ dBm.

### PSD SPECTRUM PLOT

**11a 1S4T CDD CH52**

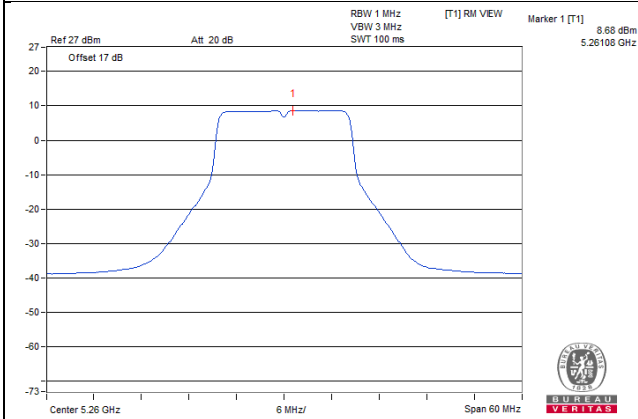

**11a 1S4T CDD CH60**

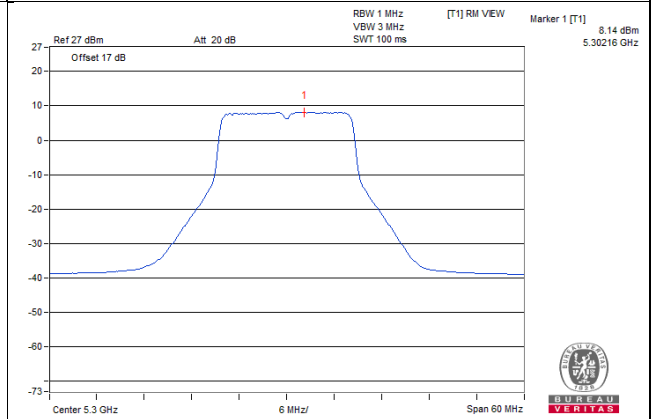

**11a 1S4T CDD CH64**

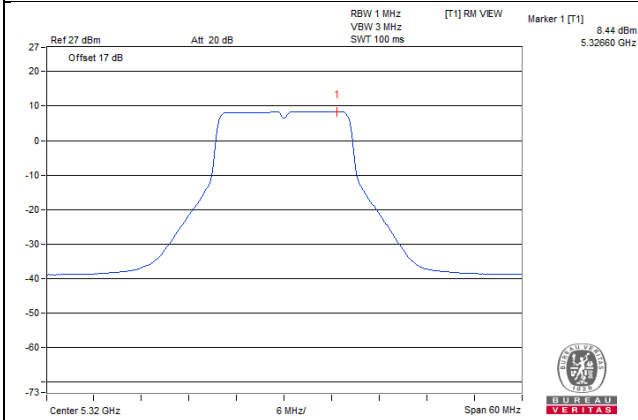

**11a 1S4T CDD CH100**

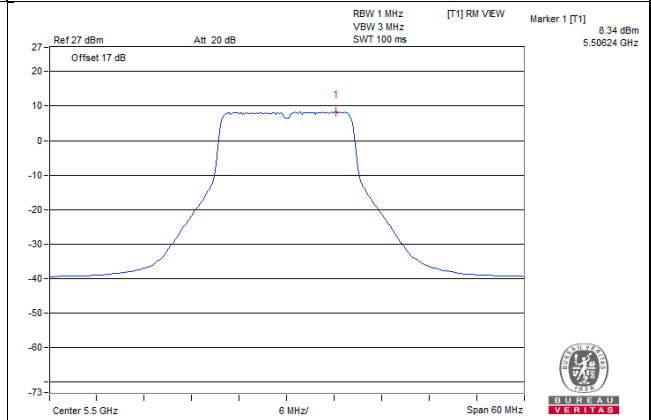

**11a 1S4T CDD CH116**

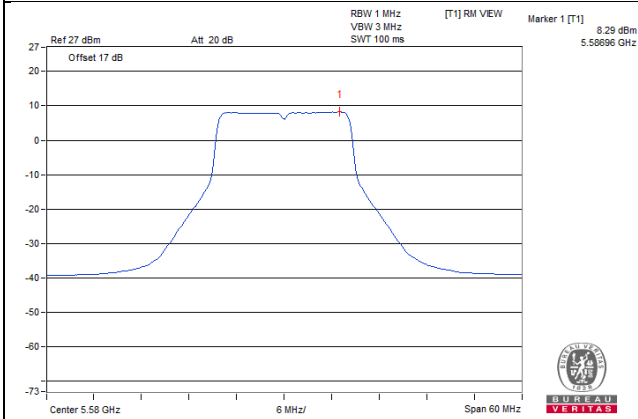

**11a 1S4T CDD CH140**

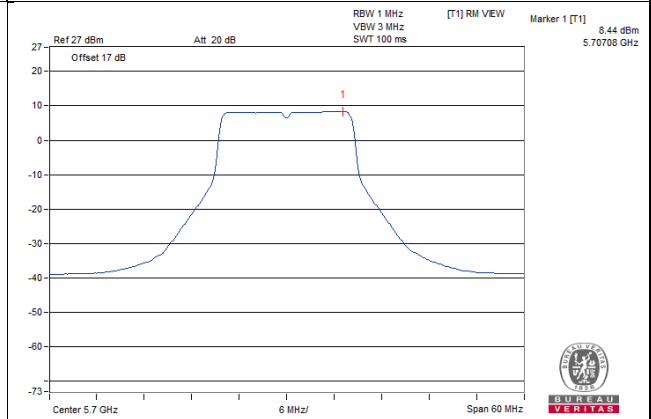

### PSD SPECTRUM PLOT

**11ac (20MHz) 1S4T CDD CH52**

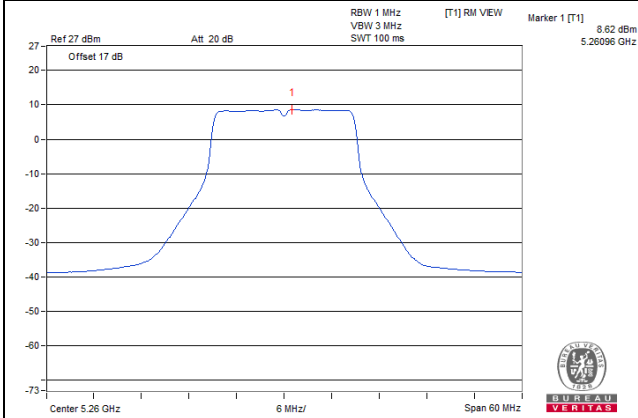

**11ac (20MHz) 1S4T CDD CH60**

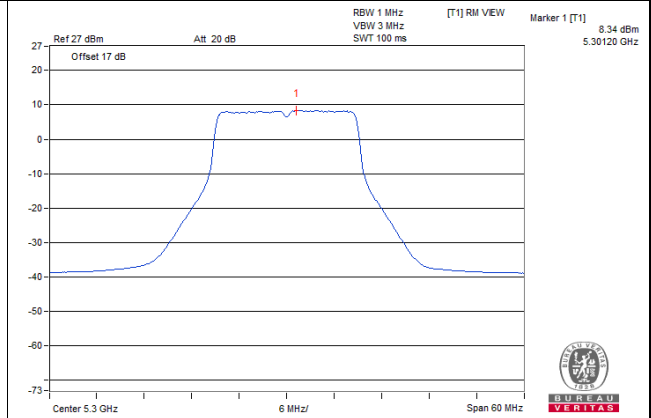

**11ac (20MHz) 1S4T CDD CH64**

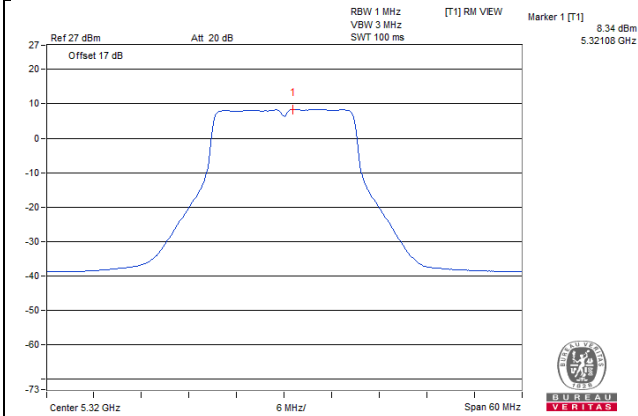

**11ac (20MHz) 1S4T CDD CH100**

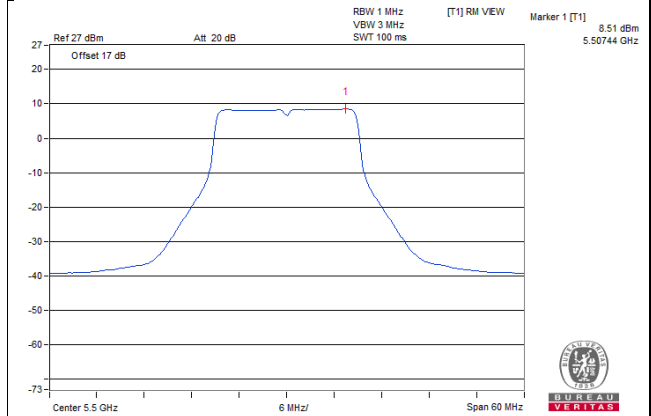

**11ac (20MHz) 1S4T CDD CH116**

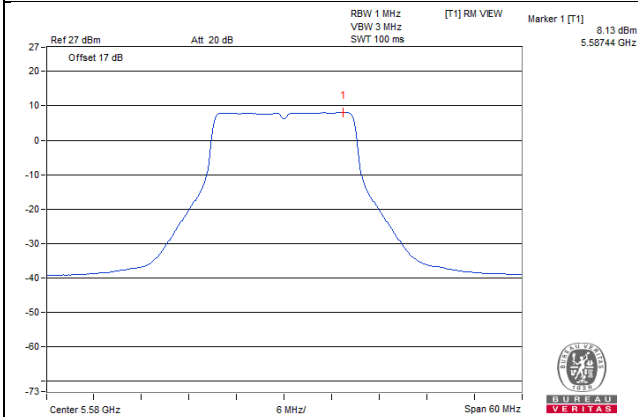

**11ac (20MHz) 1S4T CDD CH140**

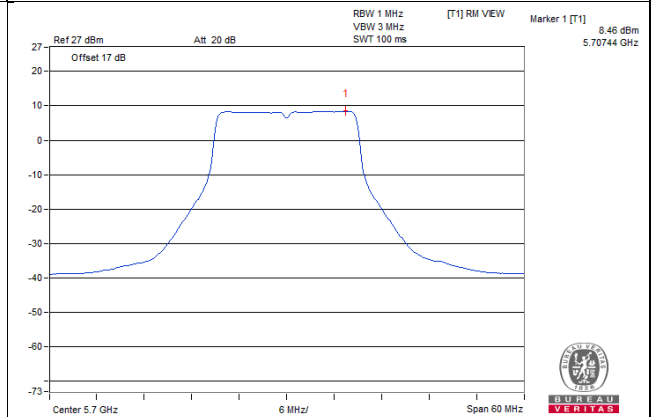

### PSD SPECTRUM PLOT

**11ac (20MHz) 1S4T TxBF CH52**

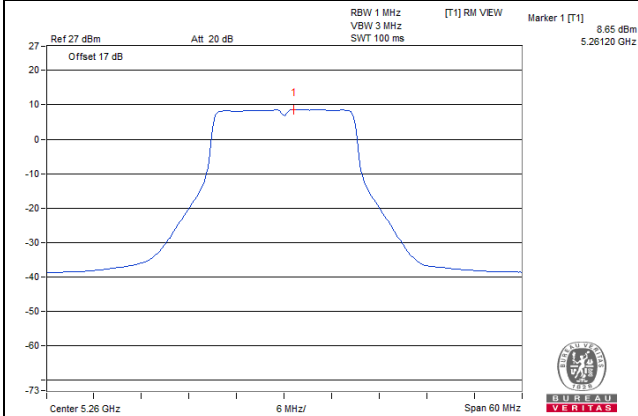

**11ac (20MHz) 1S4T TxBF CH60**

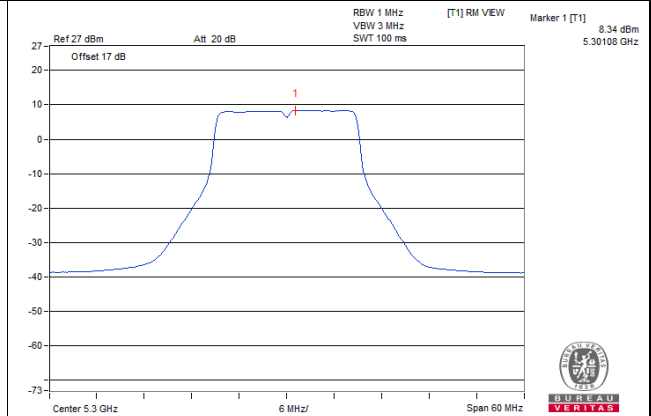

**11ac (20MHz) 1S4T TxBF CH64**

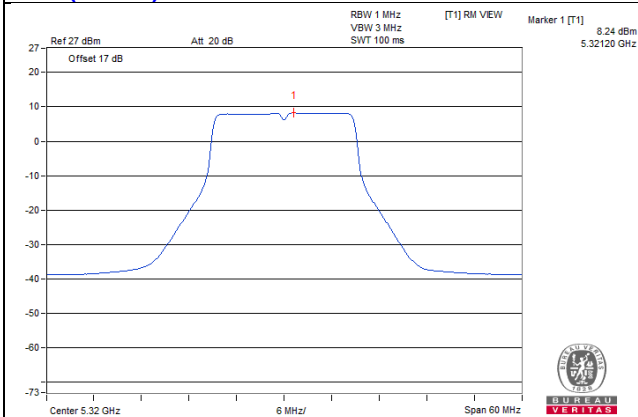

**11ac (20MHz) 1S4T TxBF CH100**

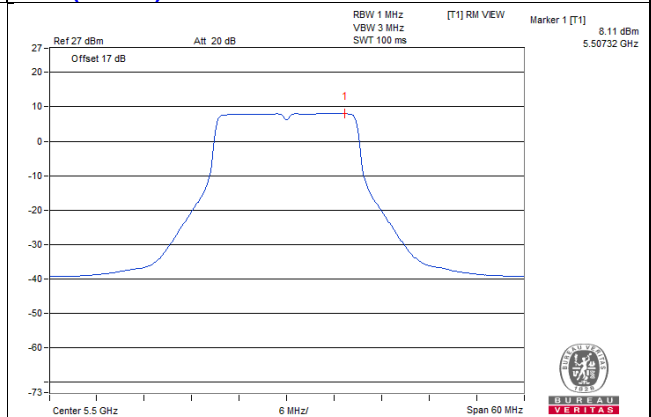

**11ac (20MHz) 1S4T TxBF CH116**

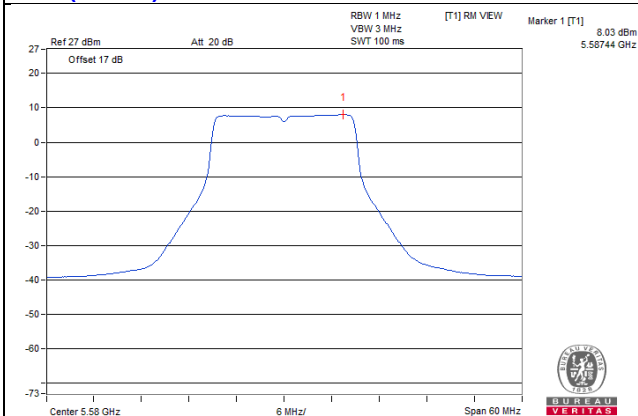

**11ac (20MHz) 1S4T TxBF CH140**

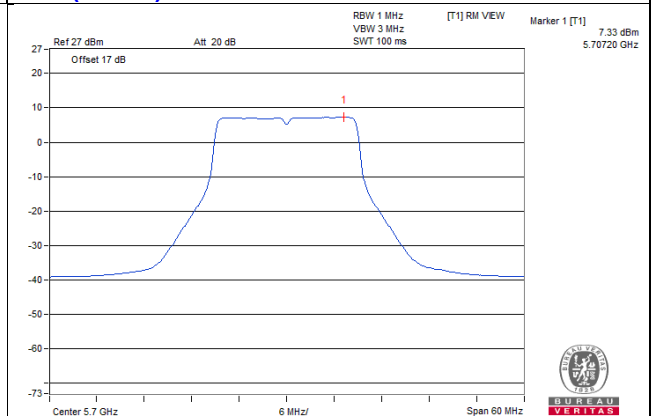



### PSD SPECTRUM PLOT

**11ac (40MHz) 1S4T CDD CH54**

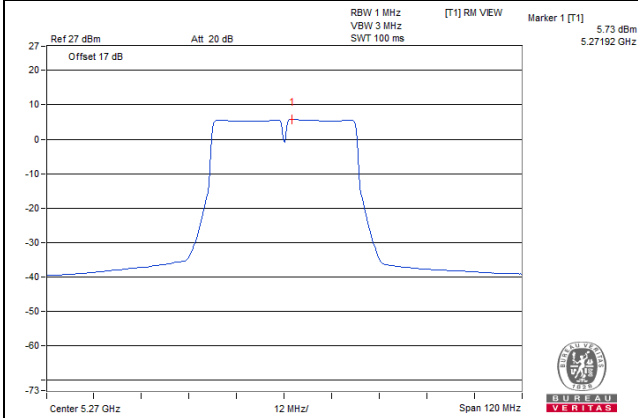

**11ac (40MHz) 1S4T CDD CH62**

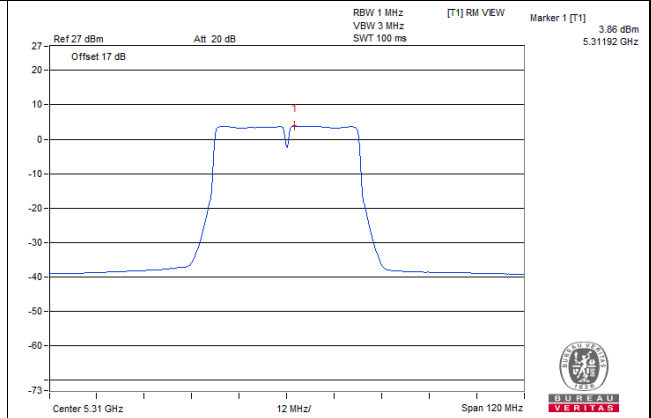

**11ac (40MHz) 1S4T CDD CH102**

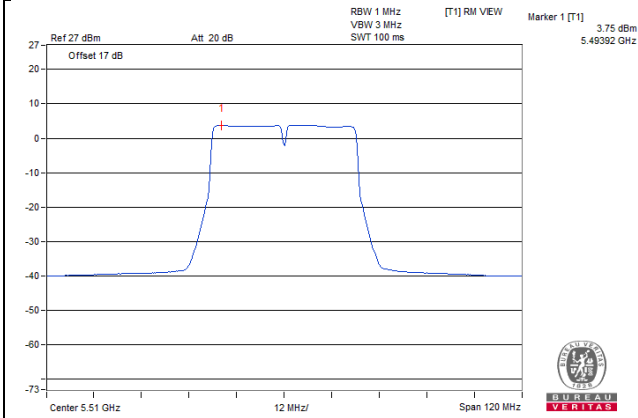

**11ac (40MHz) 1S4T CDD CH110**

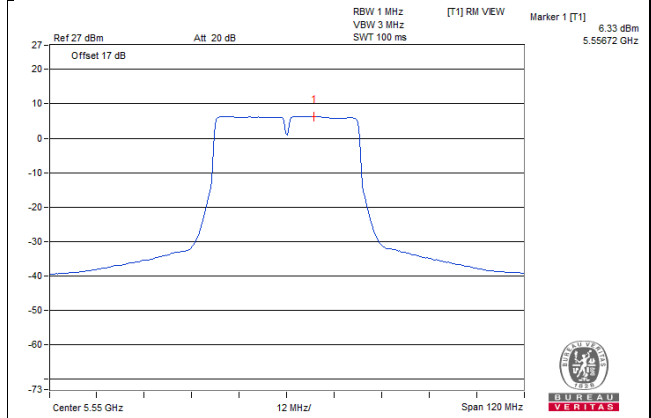

**11ac (40MHz) 1S4T CDD CH134**

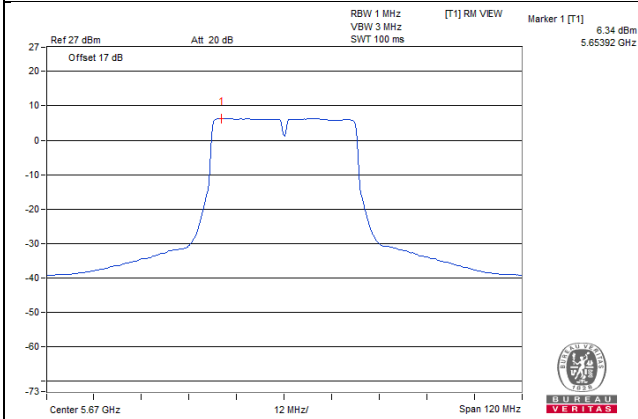

### PSD SPECTRUM PLOT

**11ac (40MHz) 1S4T TxBF CH54**

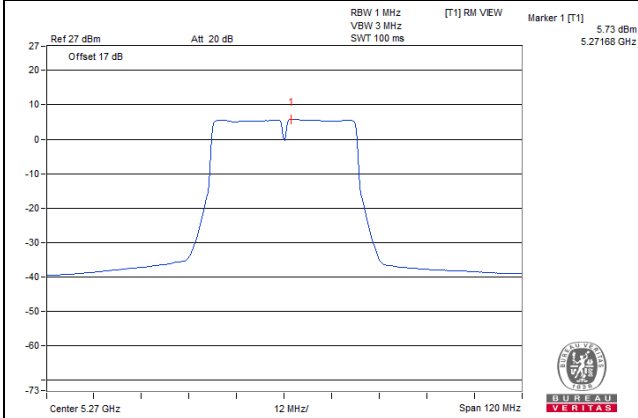

**11ac (40MHz) 1S4T TxBF CH62**

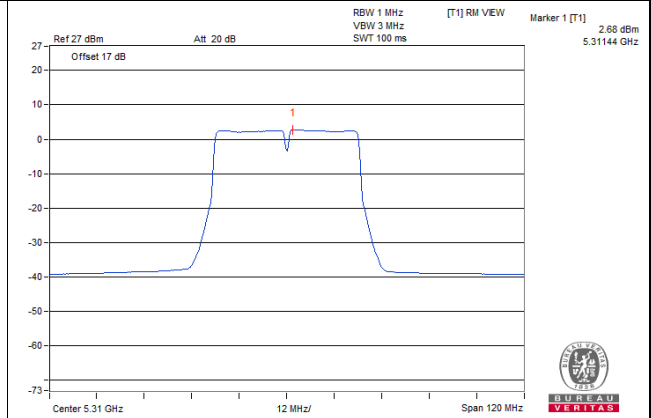

**11ac (40MHz) 1S4T TxBF CH102**

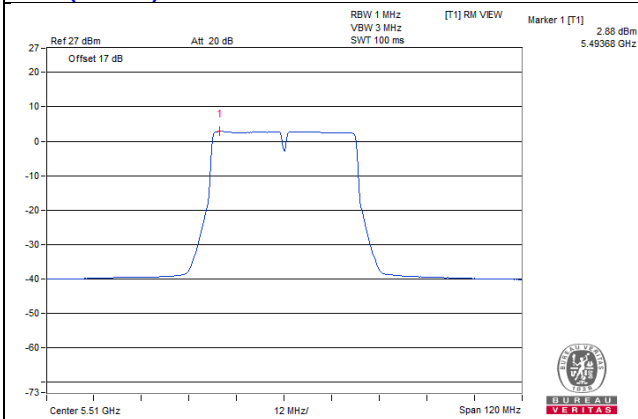

**11ac (40MHz) 1S4T TxBF CH110**

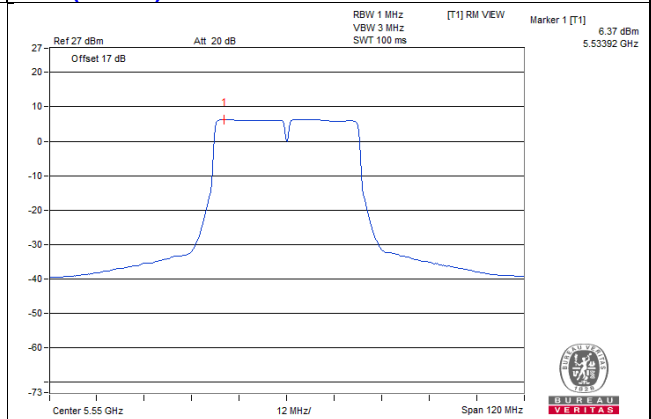

**11ac (40MHz) 1S4T TxBF CH134**

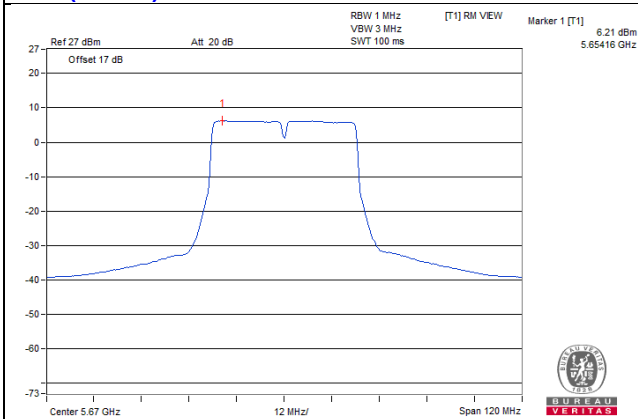

### PSD SPECTRUM PLOT

**11ac (80MHz) 1S4T CDD CH58**

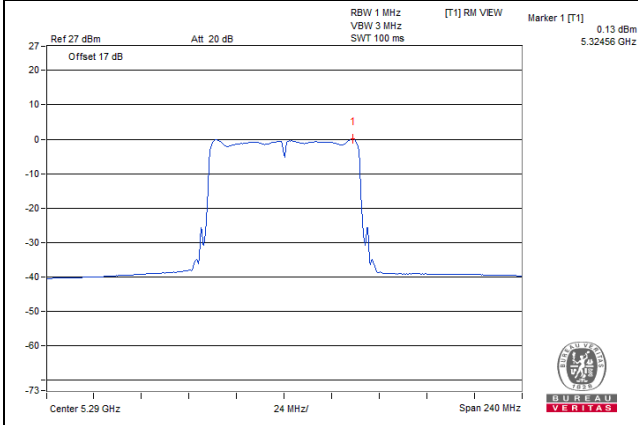

**11ac (80MHz) 1S4T CDD CH106**

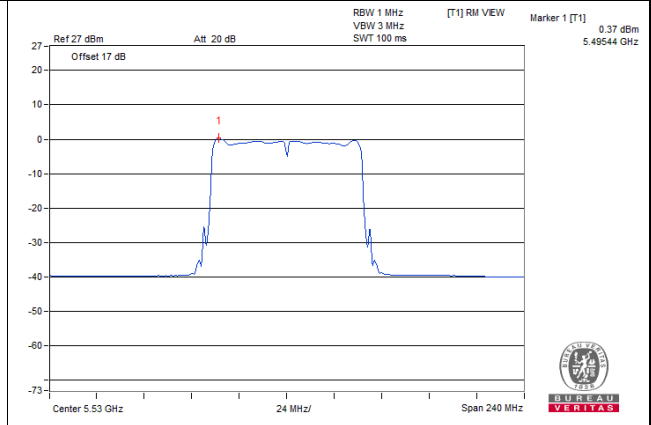

### PSD SPECTRUM PLOT

**11ac (80MHz) 1S4T TxBF CH58**

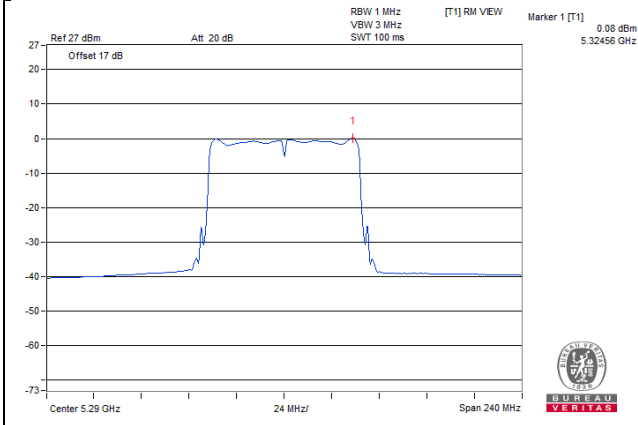

**11ac (80MHz) 1S4T TxBF CH106**

