

FCC Test Report (WLAN 2.4GHz)

Report No.: RF170526E11B

FCC ID: RSE-OWA0130

Equipment Name: Technicolor Wi-Fi Video Bridge & Extender

Trade Name: technicolor

Model Number: OWA0130

Received Date: June 05, 2018

Test Date: June 13 to 21, 2018

Issued Date: Oct. 01, 2018

Applicant: Technicolor Delivery Technologies Belgium

Address: Prins Boudewijnlaan 47, 2650 Edegem Belgium

Issued By: Bureau Veritas Consumer Products Services (H.K.) Ltd., Taoyuan Branch
Hsin Chu Laboratory

Lab Address: E-2, No.1, Li Hsin 1st Road, Hsinchu Science Park, Hsinchu City 300,
Taiwan R.O.C.

Test Location: E-2, No.1, Li Hsin 1st Road, Hsinchu Science Park, Hsinchu City 300,
Taiwan R.O.C.

**FCC Registration /
Designation Number:** 723255 / TW2022



This report is for your exclusive use. Any copying or replication of this report to or for any other person or entity, or use of our name or trademark, is permitted only with our prior written permission. This report sets forth our findings solely with respect to the test samples identified herein. The results set forth in this report are not indicative or representative of the quality or characteristics of the lot from which a test sample was taken or any similar or identical product unless specifically and expressly noted. Our report includes all of the tests requested by you and the results thereof based upon the information that you provided to us. You have 60 days from date of issuance of this report to notify us of any material error or omission caused by our negligence, provided, however, that such notice shall be in writing and shall specifically address the issue you wish to raise. A failure to raise such issue within the prescribed time shall constitute your unqualified acceptance of the completeness of this report, the tests conducted and the correctness of the report contents. Unless specific mention, the uncertainty of measurement has been explicitly taken into account to declare the compliance or non-compliance to the specification. The report must not be used by the client to claim product certification, approval, or endorsement by TAF or any government agencies.

Table of Contents

Release Control Record	4
1 Certificate of Conformity	5
2 Summary of Test Results	6
2.1 Measurement Uncertainty	6
2.2 Modification Record	6
3 General Information	7
3.1 Basic Description of Equipment Under Test (WLAN 2.4GHz)	7
3.2 Accessories	9
3.3 Feature of Equipment under Test	9
3.4 Information Provided by the Manufacturer	9
3.5 General Description of Applied Standards	10
3.6 Cabling Attached to the Equipment	11
3.7 Panel Drawing	12
3.8 Transmit Operating Mode	13
3.9 Antenna Requirements	13
3.10 Antenna Information	14
3.11 Table for Carrier Frequency	16
3.12 Table for Test Modes	17
3.13 Parameters of Test Software Setting	19
3.14 On Time and Duty Cycle	20
3.15 Testing Location Information	22
3.16 EUT Diagram and Support Equipment	23
4 Test Types and Results	25
4.1 AC Power Conducted Emissions Measurement	25
4.1.1 Limit	25
4.1.2 Measuring Instruments and Setting	25
4.1.3 Test Procedures	25
4.1.4 Test Setup Layout	26
4.1.5 Test Deviation	26
4.1.6 EUT Operating during Test	27
4.1.7 Test Results of AC Power Conducted Emissions	27
4.2 Maximum Conducted Output Power Measurement	29
4.2.1 Limit	29
4.2.2 Measuring Instruments and Setting	29
4.2.3 Test Procedures	29
4.2.4 Test Setup Layout	30
4.2.5 Test Deviation	30
4.2.6 EUT Operating Conditions	30
4.2.7 Test Results of Maximum Conducted Output Power	31
4.3 Power Spectral Density Measurement	34
4.3.1 Limit	34
4.3.2 Measuring Instruments and Setting	34
4.3.3 Test Procedures	34
4.3.4 Test Setup Layout	35
4.3.5 Test Deviation	35
4.3.6 EUT Operating Conditions	35
4.3.7 Test Results of Power Spectral Density	36
4.4 6dB Bandwidth Measurement	45
4.4.1 Limit	45
4.4.2 Measuring Instruments and Setting	45
4.4.3 Test Procedures	45
4.4.4 Test Setup Layout	46
4.4.5 Test Deviation	46

4.4.6	EUT Operating Conditions.....	46
4.4.7	Test Results of 6dB Bandwidth.....	47
4.5	Occupied Bandwidth Measurement.....	52
4.5.1	Measuring Instruments and Setting.....	52
4.5.2	Test Procedure.....	52
4.5.3	Test Setup Layout.....	52
4.5.4	Test Deviation.....	53
4.5.5	EUT Operating Conditions.....	53
4.5.6	Test Results of Occupied Bandwidth.....	54
4.6	Radiated Emissions Measurement.....	59
4.6.1	Limit.....	59
4.6.2	Measuring Instruments and Setting.....	59
4.6.3	Test Procedure.....	60
4.6.4	Test Setup Layout.....	61
4.6.5	Test Deviation.....	62
4.6.6	EUT Operating Conditions.....	62
4.6.7	Test Results of Radiated Emissions.....	63
4.7	Band Edge and Fundamental Emissions Measurement.....	103
4.7.1	Limit.....	103
4.7.2	Measuring Instruments and Setting.....	103
4.7.3	Test Procedure.....	103
4.7.4	Test Setup Layout.....	104
4.7.5	Test Deviation.....	104
4.7.6	EUT Operating Conditions.....	104
4.7.7	Test Results of Band Edge and Fundamental Emissions.....	105
4.7.8	Test Results of Band Edge and Emissions not in Restricted Bands.....	141
5	List of Test Instruments.....	150
	Appendix - Information on the Testing Laboratories.....	152

Release Control Record

Issue No.	Description	Date Issued
RF170526E11B	Original release.	Oct. 01, 2018

1 Certificate of Conformity

Equipment Name: Technicolor Wi-Fi Video Bridge & Extender

Trade Name: technicolor

Test Model: OWA0130

Sample Status: Product Unit

Applicant: Technicolor Delivery Technologies Belgium

Test Date: June 13 to 21, 2018

Standards: 47 CFR FCC Part 15, Subpart C (Section 15.247)
ANSI C63.10: 2013

The above equipment has been tested by **Bureau Veritas Consumer Products Services (H.K.) Ltd., Taoyuan Branch**, and found compliance with the requirement of the above standards. The test record, data evaluation & Equipment Under Test (EUT) configurations represented herein are true and accurate accounts of the measurements of the sample's RF EMI characteristics under the conditions specified in this report.

Prepared by : Wendy Wu , **Date:** Oct. 01, 2018
Wendy Wu / Specialist

Approved by : May Chen , **Date:** Oct. 01, 2018
May Chen / Manager

2 Summary of Test Results

Applied Standard: 47 CFR FCC Part 15 Subpart C					
Section	Ref. Std. Clause	Description	Measured	Limit	Result
3.9	15.203	Antenna Requirements	-	-	PASS
4.1	15.207	AC Power Conducted Emissions	Margin is -9.52dB at 0.16172MHz.	15.207	PASS
4.2	15.247(b)(3)	Maximum Conducted Output Power	Power [dBm]: 11b: 17.32 dBm 11g: 17.69 dBm 11n(20M): 19.61 dBm 11n(40M): 18.59 dBm	30 dBm	PASS
4.3	15.247(e)	Power Spectral Density	PSD [dBm]: 11b: -11.66 dBm/3kHz 11g: -13.89 dBm/3kHz 11n(20M): -12.25 dBm/3kHz 11n(40M): -15.75 dBm/3kHz	8dBm/3kHz	PASS
4.4	15.247(a)(2)	6dB Spectrum Bandwidth	Bandwidth [MHz]: 11b: 8.10 MHz 11g: 15.16 MHz 11n(20M): 14.69 MHz 11n(40M): 31.39 MHz	≥500kHz	PASS
4.5	-	Occupied Bandwidth	Bandwidth [MHz]: 11b: 10.32 MHz 11g: 16.68 MHz 11n(20M): 17.64 MHz 11n(40M): 36.24 MHz	-	-
4.6	15.247(d)	Radiated Emissions	Margin is -3.0dB at 624.99MHz and 625.00MHz	-	PASS
4.7	15.247(a)(2)	Band Edge Emissions	Margin is -9.2dB at 2483.50MHz.	-	PASS

2.1 Measurement Uncertainty

Where relevant, the following measurement uncertainty levels have been estimated for tests performed on the EUT as specified in CISPR 16-4-2:

Measurement	Frequency	Expanded Uncertainty (k=2) (±)
Conducted Emissions at mains ports	150kHz ~ 30MHz	1.84 dB
Radiated Emissions up to 1 GHz	30MHz ~ 1GHz	5.53 dB
Radiated Emissions above 1 GHz	1GHz ~ 6GHz	5.08 dB
	6GHz ~ 18GHz	4.98 dB
	18GHz ~ 40GHz	5.19 dB

2.2 Modification Record

There were no modifications required for compliance.

3 General Information

3.1 Basic Description of Equipment Under Test (WLAN 2.4GHz)

Items	Description		
Equipment Name	Technicolor Wi-Fi Video Bridge & Extender		
Trade Name	technicolor		
Model Number	OWA0130		
FCC ID	RSE-OWA0130		
Power Type	From power adapter		
Antenna	Refer section 3.10		
EUT Stage	<input checked="" type="checkbox"/>	Product Unit	<input type="checkbox"/> Pre-Sample
Operating Band and Conducted Output Power	2400~2483.5MHz		<input checked="" type="checkbox"/> IEEE 802.11b: 17.32 dBm
			<input checked="" type="checkbox"/> IEEE 802.11g: 17.69 dBm
			<input checked="" type="checkbox"/> IEEE 802.11n (20MHz): 19.61 dBm
			<input checked="" type="checkbox"/> IEEE 802.11n (40MHz): 18.59dBm
Product Type	For IEEE 802.11b: WLAN(1TX, 2RX) For IEEE 802.11g: WLAN(1TX, 2RX) For IEEE 802.11n: WLAN(1TX/2TX, 2RX)		
Nominal Bandwidth	20MHz / 40MHz		
Modulation	802.11b: DSSS (DBPSK, DQPSK, CCK) 802.11g: OFDM (BPSK / QPSK / 16QAM / 64QAM) 802.11n: OFDM (BPSK / QPSK / 16QAM / 64QAM) See the below table		
Data Rate (Mbps)	802.11b mode :DSSS (1/2/5.5/11) 802.11g mode :OFDM (6/9/12/18/24/36/48/54) 802.11n(20MHz) mode(MCS0~MCS15); 802.11n(40MHz) mode(MCS0~MCS15) See the below table		
I/O Ports	LAN Port x 2 DC JACK x 1		
Hardware Version	Lab2		
Software Version	12.1.4.3.AA		

IEEE Std. 802.11n modulation and data rate information

MCS Index	Spatial Streams	Modulation Type	Coding Rate	Data Rate (Mbit/s)			
				20 MHz channel		40 MHz channel	
				800ns GI	400ns GI	800ns GI	400ns GI
0	1	BPSK	1/2	6.5	7.2	13.5	15
1		QPSK	1/2	13	14.4	27	30
2		QPSK	3/4	19.5	21.7	40.5	45
3		16-QAM	1/2	26	28.9	54	60
4		16-QAM	3/4	39	43.3	81	90
5		64-QAM	2/3	52	57.8	108	120
6		64-QAM	3/4	58.5	65	121.5	135
7		64-QAM	5/6	65	72.2	135	150
8	2	BPSK	1/2	13	14.4	27	30
9		QPSK	1/2	26	28.9	54	60
10		QPSK	3/4	39	43.3	81	90
11		16-QAM	1/2	52	57.8	108	120
12		16-QAM	3/4	78	86.7	162	180
13		64-QAM	2/3	104	115.6	216	240
14		64-QAM	3/4	117	130	243	270
15		64-QAM	5/6	130	144.4	270	300

Note: GI means guard interval.

3.2 Accessories

Power supply:

Power Adaptor	
Brand	AcBel
Model	WAG027
P/N	DSL37647540
Input Power	100-240Vac, 50/60Hz, 0.6A max
Output Power	12Vdc, 1.5A
Cable Length	1.5m

3.3 Feature of Equipment under Test

Please refer to user manual.

3.4 Information Provided by the Manufacturer

Interface Availability

Interface Model	DC Power	Ethernet LAN 1000Mbps	WLAN IEEE 802.11n (2.4GHz)	WLAN IEEE 802.11n/ac (5GHz)
OWA0130	●(1.5A)	●(2 port)	●	●

●: Equipped

○: Not Equipped

3.5 General Description of Applied Standards

The EUT is a RF Product. According to the specifications of the manufacturer, it must comply with the requirements of the following standards:

FCC Part 15, Subpart C (15.247)

KDB 558074 D01 15.247 Meas Guidance v05, 08/24/2018

KDB 662911 D01 Multiple Transmitter Output v02r01, 10/31/2013

ANSI C63.10-2013

All test items have been performed and recorded as per the above standards.

3.6 Cabling Attached to the Equipment

Cable and Interconnection

Interface	Cable type	Cable length delivered with the modem	"Real life" Cable length that can be attached to this type of interface	Cable length to be used for testing	Internal/ external connection
Ethernet	UTP Cat 5	2 meter	> 10 meter	one 10 meter cables;	Internal
AC power		1.5 meter			External

3.7 Panel Drawing



Label of Power adapter



3.8 Transmit Operating Mode

Transmit Operating Mode				Transmit Multiple Antennas						
<input checked="" type="checkbox"/>	Operating mode 1 (single antenna)			<input checked="" type="checkbox"/>	1TX					
<input checked="" type="checkbox"/>	Operating mode 2 (multiple antenna, no beam forming)			<input checked="" type="checkbox"/>	2TX	<input type="checkbox"/>	3TX	<input type="checkbox"/>	4TX	
<input type="checkbox"/>	Operating mode 3 (multiple antenna, with beam forming)			<input type="checkbox"/>	2TX	<input type="checkbox"/>	3TX	<input type="checkbox"/>	4TX	
<input checked="" type="checkbox"/>	802.11b	Operating mode	<input checked="" type="checkbox"/>	1TX	<input type="checkbox"/>	2TX	<input type="checkbox"/>	3TX	<input type="checkbox"/>	Cyclic shift
<input checked="" type="checkbox"/>	802.11g	Operating mode	<input checked="" type="checkbox"/>	1TX	<input type="checkbox"/>	2TX	<input type="checkbox"/>	3TX	<input type="checkbox"/>	Cyclic shift
<input checked="" type="checkbox"/>	802.11n(20MHz)	Operating mode	<input checked="" type="checkbox"/>	1TX	<input checked="" type="checkbox"/>	2TX	<input type="checkbox"/>	3TX	<input type="checkbox"/>	Cyclic shift
<input checked="" type="checkbox"/>	802.11n(40MHz)	Operating mode	<input checked="" type="checkbox"/>	1TX	<input checked="" type="checkbox"/>	2TX	<input type="checkbox"/>	3TX	<input type="checkbox"/>	Cyclic shift

Note:

For IEEE802.11b, 1Mbps~11Mbps: 1TX

For IEEE802.11g, 6Mbps~54Mbps: 1TX

For IEEE802.11n 20MHz/40MHz, MCS0~MCS7: 1 Stream 1TX; MCS8~MCS15: 2 Stream 2TX;

3.9 Antenna Requirements

Except for special regulations, the Low-power Radio-frequency Devices must not be equipped with any jacket for installing an antenna with extension cable. An intentional radiator shall be designed to ensure that no antenna other than that furnished by the responsible party shall be used with the device. The use of a permanently attached antenna or of an antenna that uses a unique coupling to the intentional radiator shall be considered sufficient to comply with the provisions of this Section. The manufacturer may design the unit so that the user can replace a broken antenna, but the use of a standard antenna jack or electrical connector is prohibited. Further, this requirement does not apply to intentional radiators that must be professionally installed.

3.10 Antenna Information

Ant.	Brand	Model Name	Antenna Type	Connector
1	technicolor	--	Printed Antenna	Murata
2	technicolor	--	Printed Antenna	Murata

Antenna & Bandwidth for 2400~2483.5MHz

Antenna	1st (TX)		2nd (TX)	
	20 MHz	40 MHz	20 MHz	40 MHz
802.11b	V	X	X	X
802.11g	V	X	X	X
802.11n	V	V	V	V

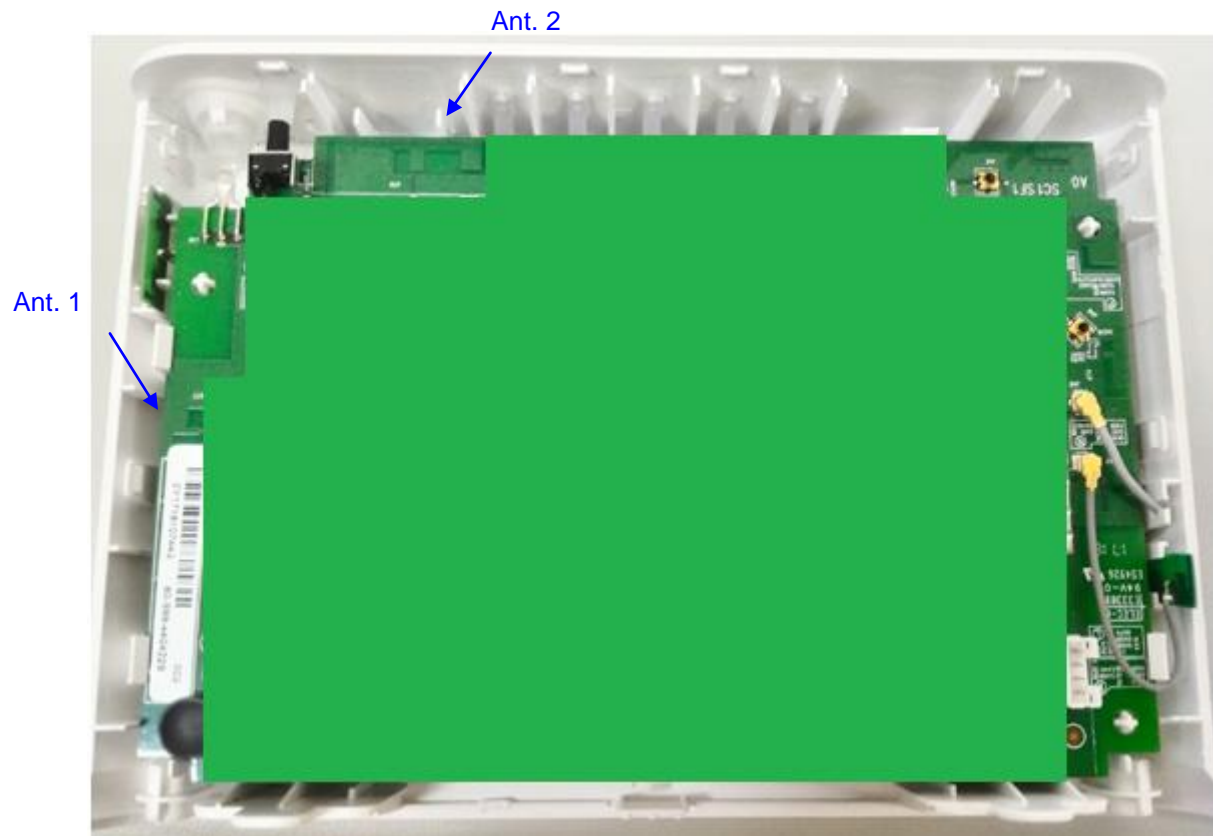

For 2400~2483.5MHz

Frequency	Antenna Gain (dBi)			
	Ant. 1 (W1)		Ant. 2 (W2)	
	20 MHz	40 MHz	20 MHz	40 MHz
2412MHz	2.60	-	3.70	-
2422MHz	-	2.70	-	3.60
2437MHz	2.70	2.70	3.00	3.00
2452MHz	-	2.60	-	3.00
2462MHz	2.60	-	3.10	-

Frequency	Maximum Gain (dBi) for CDD mode	
	SDM mode (2 Stream 2 TX) for Power & PSD Gain (KDB 662911 Option 2)	
	20 MHz	40 MHz
2412MHz	4.78	-
2422MHz	-	4.68
2437MHz	4.63	4.63
2452MHz	-	4.73
2462MHz	4.69	-

Note:

1. Antenna Gain refer to antenna report.
2. Maximum Correlated Directional Gain = $10 \log[(10^{G1/20} + 10^{G2/20} + \dots + 10^{GN/20})^2 / N_{ANT}]$ dBi
3. Maximum Uncorrelated Directional Gain = $10 \log[(10^{G1/10} + 10^{G2/10} + \dots + 10^{GN/10}) / N_{ANT}]$ dBi

Frequency	Maximum Gain (dBi) for SDM mode	
	SDM mode (2 Stream 2 TX) for Power & PSD Gain (KDB 662911 Option 2)	
	20 MHz	40 MHz
2412MHz	2.00	-
2422MHz	-	1.89
2437MHz	1.71	1.71
2452MHz	-	1.76
2462MHz	1.72	-

Note:

1. Antenna Gain refer to antenna report.
2. Maximum Correlated Directional Gain = $10 \log[(10^{G1/20} + 10^{G2/20} + \dots + 10^{GN/20})^2 / N_{ANT}]$ dBi
3. Maximum Uncorrelated Directional Gain = $10 \log[(10^{G1/10} + 10^{G2/10} + \dots + 10^{GN/10}) / N_{ANT}]$ dBi

3.11 Table for Carrier Frequency

Eleven channels are provided for 802.11b, 802.11g, 802.11n (20MHz):

Frequency Band	Channel No.	Frequency	Channel No.	Frequency
2400MHz ~ 2483.5 MHz	1	2412 MHz	7	2442MHz
	2	2417MHz	8	2447MHz
	3	2422MHz	9	2452MHz
	4	2427MHz	10	2457MHz
	5	2432MHz	11	2462MHz
	6	2437MHz		

Seven channels are provided for 802.11n (40MHz):

Frequency Band	Channel No.	Frequency	Channel No.	Frequency
2400MHz ~ 2483.5 MHz	3	2422 MHz	7	2442MHz
	4	2427MHz	8	2447MHz
	5	2432MHz	9	2452MHz
	6	2437MHz		

3.12 Table for Test Modes

Investigation has been done on all the possible configurations for searching the worst cases. The following table is a list of the test modes shown in this test report.

Test Items	Mode	Note	Channel	Data Rate	Antenna
AC Power Line Conducted Emissions	802.11n(40MHz)	OFDM/BPSK	6	-	1
Maximum Average Output Power	802.11b	DSSS/DBPSK	1/6/11	1 Mbps	1
	802.11g	OFDM/BPSK	1/6/11	6 Mbps	1
	802.11n(20MHz)		1/6/11	MCS0	1
				MCS0	2
				MCS0 1S2T CDD	1+2
				MCS8 2S2T SDM	1+2
	802.11n(40MHz)		3/6/9	MCS0	1
				MCS0	2
				MCS0 1S2T CDD	1+2
		MCS8 2S2T SDM		1+2	
Power Spectral Density	802.11b	DSSS/DBPSK	1/6/11	1 Mbps	1
	802.11g	OFDM/BPSK	1/6/11	6 Mbps	1
	802.11n(20MHz)		1/6/11	MCS0	2
				MCS0 1S2T CDD	1+2
	802.11n(40MHz)		3/6/9	MCS0	2
		MCS0 1S2T CDD		1+2	
6dB Spectrum Bandwidth	802.11b	DSSS/DBPSK	1/6/11	1 Mbps	1
	802.11g	OFDM/BPSK	1/6/11	6 Mbps	1
	802.11n(20MHz)		1/6/11	MCS0 1S2T CDD	1+2
	802.11n(40MHz)		3/6/9	MCS0 1S2T CDD	1+2
Band Edge Emissions (Radiated)	802.11b	DSSS/DBPSK	1/6/11	1 Mbps	1
	802.11g	OFDM/BPSK	1/6/11	6 Mbps	1
	802.11n(20MHz)		1/6/11	MCS0	2
				MCS0 1S2T CDD	1+2
	802.11n(40MHz)		3/6/9	MCS0	2
		MCS0 1S2T CDD		1+2	
Radiated Emissions Above 1GHz(Radiated)	802.11b	DSSS/DBPSK	1/6/11	1 Mbps	1
	802.11g	OFDM/BPSK	1/6/11	6 Mbps	1
	802.11n(20MHz)		1/6/11	MCS0	2
				MCS0 1S2T CDD	1+2
	802.11n(40MHz)		3/6/9	MCS0	2
		MCS0 1S2T CDD		1+2	
Radiated Emissions Below 1GHz(Radiated)	802.11n(20MHz)	OFDM/BPSK	6	-	1+2
	802.11n(40MHz)	OFDM/BPSK	6	-	1+2

Note:

1. The device with multiple operating mode, measurements on the middle channel were tested to determine the worst case mode. (Each modulation family were tested in band edge, spurious emission and in band PSD after investigate worst case mode)
2. Base on txcore command, the 11b/g default mode is 1S1T SISO Ant1, the 802.11n 20MHz/40MHz default mode are 1S1T SISO Ant1, 2S2T SDM Ant1+2.

wl -i wl0 txcore

txcore enabled bitmap (Nsts {4..1}) 0x0f 0x07 0x03 0x01

txcore mask OFDM 0x01 CCK 0x01

3. Base on same power setting with 802.11n mode, the 802.11g mode were only tested the "Maximum Conducted Output Power" , "Power Spectral Density" and "Bandwidth".

3.13 Parameters of Test Software Setting

During testing, Channel & Power Controlling Software provided by the customer was used to control the operating channel as well as the output power level. The RF output power selection is for the setting of RF output power expected by the customer and is going to be fixed on the firmware of the final end product.

The Power Setting Parameter					
Test Software Version	12.1.4.3.AA				
Worst Modulation Mode	Number of Transmit Chains (NTX)	Frequency (MHz)	Maximum Output Power (dBm)	Power Setting	Data Rate / MCS
802.11b, Ant. 1	1Stream 1TX	2412	17.02	Default(16.75)	1Mbps
802.11b, Ant. 1	1Stream 1TX	2437	17.32	Default(16)	1Mbps
802.11b, Ant. 1	1Stream 1TX	2462	16.75	Default(16.5)	1Mbps
802.11g, Ant. 1	1Stream 1TX	2412	16.78	Default(16.75)	6Mbps
802.11g, Ant. 1	1Stream 1TX	2437	17.69	Default(16.75)	6Mbps
802.11g, Ant. 1	1Stream 1TX	2462	16.91	Default(16.75)	6Mbps
802.11n 20MHz, Ant. 1	1Stream 1TX	2412	16.39	Default(16.5)	MCS0
802.11n 20MHz, Ant. 1	1Stream 1TX	2437	17.23	Default(16.5)	MCS0
802.11n 20MHz, Ant. 1	1Stream 1TX	2462	16.67	Default(16.5)	MCS0
802.11n 20MHz, Ant. 2	1Stream 1TX	2412	16.83	Default(16.5)	MCS0
802.11n 20MHz, Ant. 2	1Stream 1TX	2437	17.88	Default(16.5)	MCS0
802.11n 20MHz, Ant. 2	1Stream 1TX	2462	16.68	Default(16.5)	MCS0
802.11n 20MHz, Ant. 1+2 (CDD)	2Stream 2TX	2412	18.68	Default(15.5)	MCS8
802.11n 20MHz, Ant. 1+2 (CDD)	2Stream 2TX	2437	19.61	Default(15.5)	MCS8
802.11n 20MHz, Ant. 1+2 (CDD)	2Stream 2TX	2462	18.39	Default(15.5)	MCS8
802.11n 20MHz, Ant. 1+2 (SDM)	2Stream 2TX	2412	18.51	Default(15.5)	MCS8
802.11n 20MHz, Ant. 1+2 (SDM)	2Stream 2TX	2437	19.47	Default(15.5)	MCS8
802.11n 20MHz, Ant. 1+2 (SDM)	2Stream 2TX	2462	18.29	Default(15.5)	MCS8
802.11n 40MHz, Ant. 1	1Stream 1TX	2422	16.25	Default(16)	MCS0
802.11n 40MHz, Ant. 1	1Stream 1TX	2437	16.91	Default(16)	MCS0
802.11n 40MHz, Ant. 1	1Stream 1TX	2437	16.44	Default(16)	MCS0
802.11n 40MHz, Ant. 2	1Stream 1TX	2422	16.74	Default(16)	MCS0
802.11n 40MHz, Ant. 2	1Stream 1TX	2437	16.69	Default(16)	MCS0
802.11n 40MHz, Ant. 2	1Stream 1TX	2437	16.48	Default(16)	MCS0
802.11n 40MHz, Ant. 1+2 (CDD)	2Stream 2TX	2422	18.34	Default(15)	MCS8
802.11n 40MHz, Ant. 1+2 (CDD)	2Stream 2TX	2437	18.59	Default(15)	MCS8
802.11n 40MHz, Ant. 1+2 (CDD)	2Stream 2TX	2452	18.40	Default(15)	MCS8
802.11n 40MHz, Ant. 1+2 (SDM)	2Stream 2TX	2422	18.27	Default(15)	MCS8
802.11n 40MHz, Ant. 1+2 (SDM)	2Stream 2TX	2437	18.40	Default(15)	MCS8
802.11n 40MHz, Ant. 1+2 (SDM)	2Stream 2TX	2452	18.09	Default(15)	MCS8

Investigation has been done on all the possible configurations for searching the worst cases. The following table is a list of the test modes shown in this test report.

3.14 On Time and Duty Cycle

Mode	On Time (ms)	Period (ms)	Duty Cycle (%)	Duty Cycle Correction Factor (dB)	1/T Minimum VBW (kHz)
802.11b 1Tx Chain1	12.469	12.5	99.8	-	-
802.11g 1Tx Chain1	2.064	2.096	98.5	-	-
802.11n (20MHz) 1Tx Chain1	1.918	1.951	98.3	-	-
802.11n (20MHz) 1Tx Chain2	1.918	1.951	98.3	-	-
802.11n (20MHz) 2Tx CDD	1.918	1.951	98.3	-	-
802.11n (20MHz) 2Tx SDM	1.918	1.951	98.3	-	-
802.11n (40MHz) 1Tx Chain1	0.942	0.973	96.8	0.14	3
802.11n (40MHz) 1Tx Chain2	0.942	0.973	96.8	0.14	3
802.11n (40MHz) 2Tx CDD	0.942	0.973	96.8	0.14	3
802.11n (40MHz) 2Tx SDM	0.942	0.973	96.8	0.14	3

Note: Power measurement using sweep trigger and gating of the power meter, duty factor is not required.

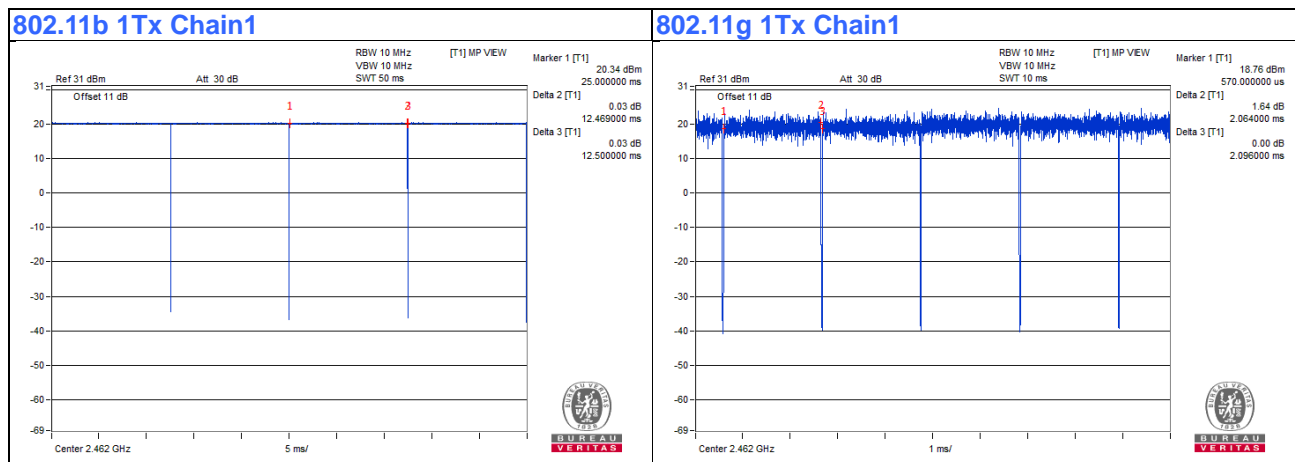

802.11n (20MHz) 1Tx Chain1

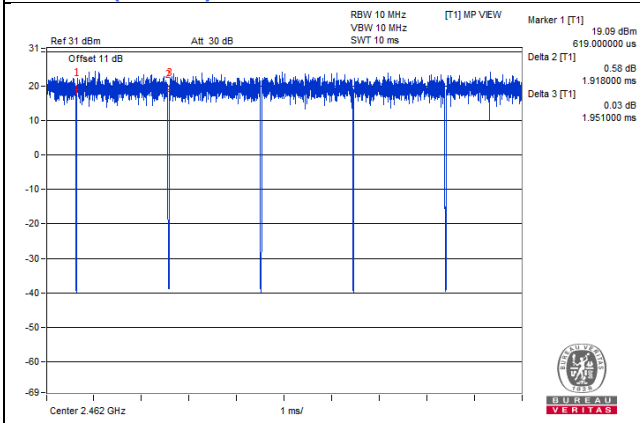

802.11n (20MHz) 1Tx Chain2

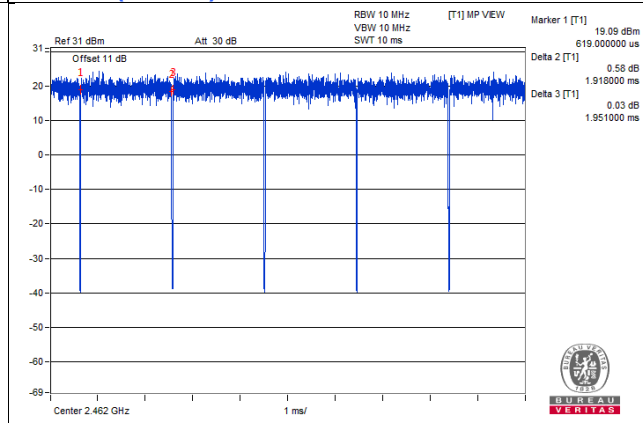

802.11n (20MHz) 2Tx CDD

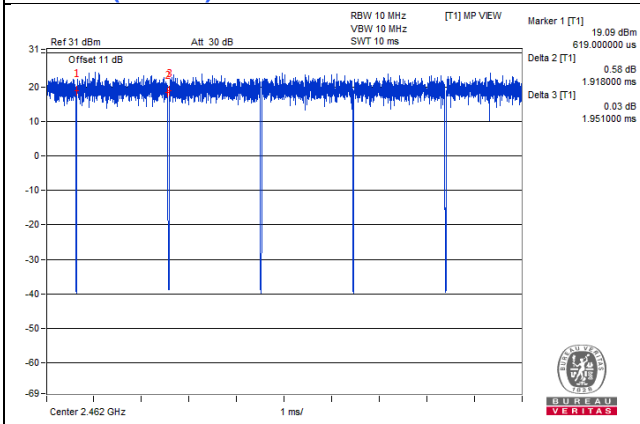

802.11n (20MHz) 2Tx SDM

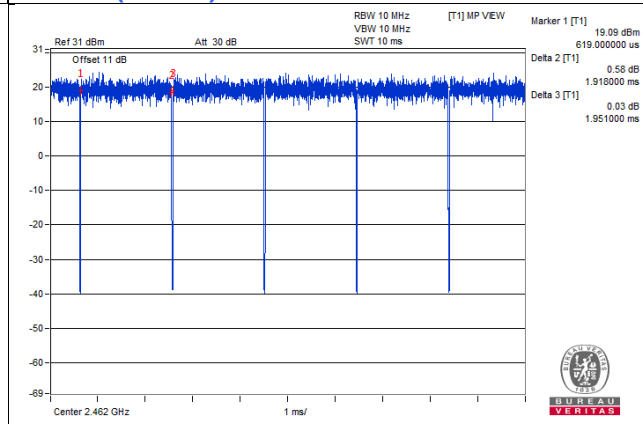

802.11n (40MHz) 1Tx Chain1

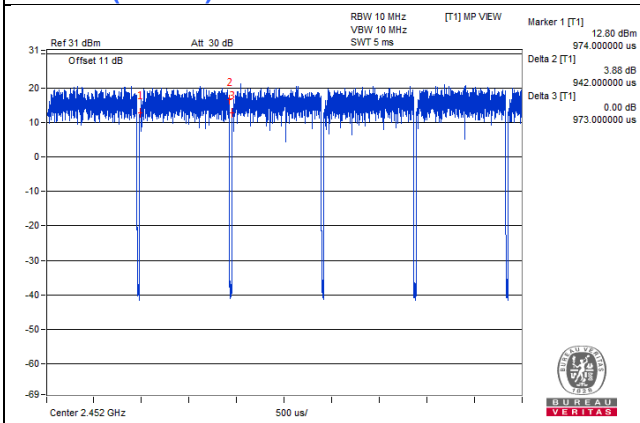

802.11n (40MHz) 1Tx Chain2

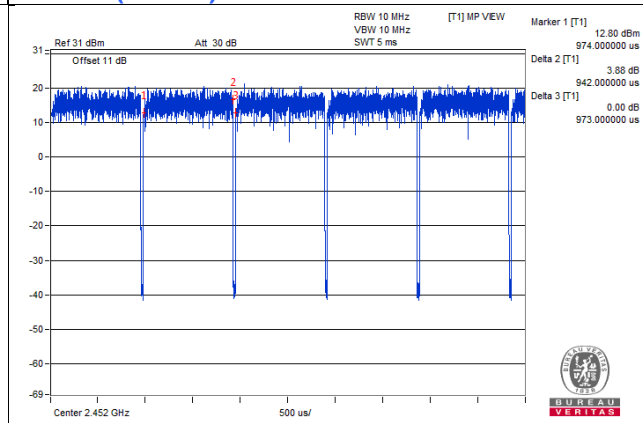

802.11n (40MHz) 2Tx CDD

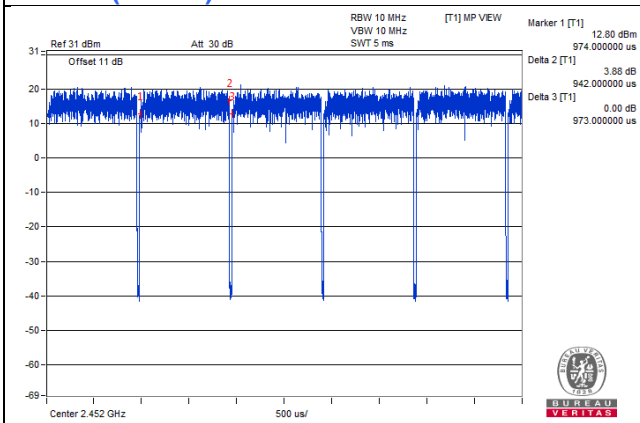

802.11n (40MHz) 2Tx SDM

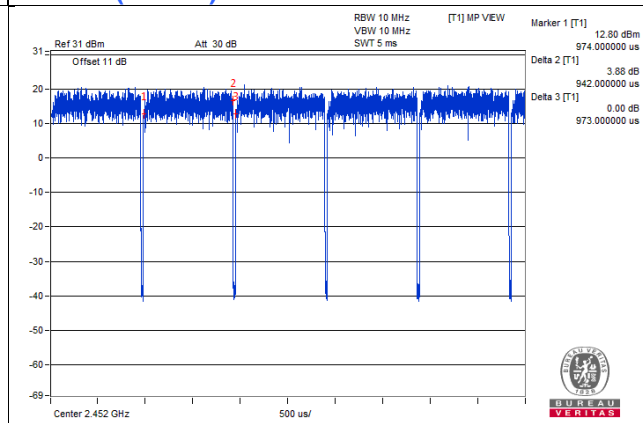

3.15 Testing Location Information

Test Site Location				
Address	(1) E-2, No.1, Li Hsin 1st Road, Hsinchu Science Park, Hsinchu City 300, Taiwan R.O.C.			
TEL	886-3-6668565			
FAX	886-3-6668323			
Test Site No.	Site Category	Location	IC Reg. No.	VCCI Reg. No
Conduction 1	Conduction	Hsinchu	-	-
Chamber 3	966 Chamber	Hsinchu	20331-1	-
Oven 2	Oven	Hsinchu	-	-

3.16 EUT Diagram and Support Equipment

The EUT has been tested as an independent unit together with other necessary accessories or support units. The following support units or accessories were used to form a representative test configuration during the tests.

ID	Product	Brand	Model No.	Serial No.	FCC ID	Remarks
A.	Laptop	DELL	E6420	B92T3R1	FCC DoC	Provided by Lab

Note:

- All power cords of the above support units are non-shielded (1.8m).

ID	Descriptions	Qty.	Length (m)	Shielding (Yes/No)	Cores (Qty.)	Remarks
1.	RJ-45 Cable	1	10	No	0	Provided by Lab
2.	DC Cable	1	1.5	No	0	Supplied by client

EUT Diagram

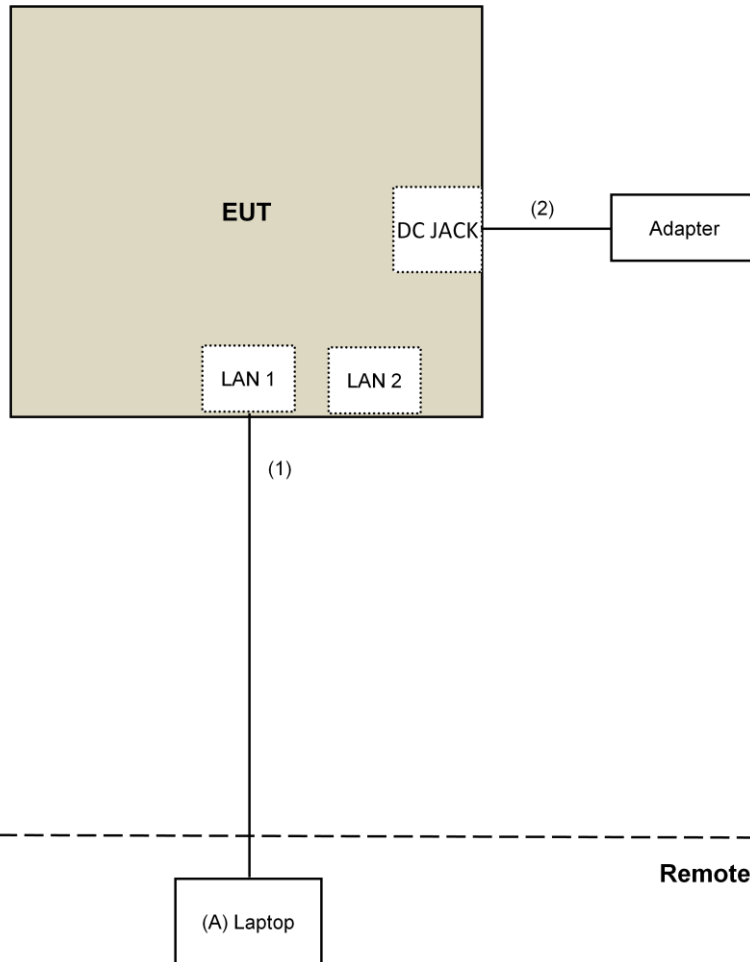

4 Test Types and Results

4.1 AC Power Conducted Emissions Measurement

4.1.1 Limit

For this product which is designed to be connected to the AC power line, the radio frequency voltage that is conducted back onto the AC power line on any frequency or frequencies within the band 150 kHz to 30 MHz shall not exceed below limits table.

Frequency (MHz)	Conducted Limit (dBuV)	
	Quasi-peak	Average
0.15 - 0.5	66 - 56	56 - 46
0.50 - 5.0	56	46
5.0 - 30.0	60	50

4.1.2 Measuring Instruments and Setting

Please refer to section 5 of equipments list in this report. The following table is the setting of the receiver

Receiver Parameters	Setting
Attenuation	10 dB
Start Frequency	0.15 MHz
Stop Frequency	30 MHz
IF Bandwidth	9 kHz

4.1.3 Test Procedures

1. Configure the EUT according to ANSI C63.10. The EUT or host of EUT has to be placed 0.4 meter far from the conducting wall of the shielding room and at least 80 centimeters from any other grounded conducting surface.
2. Connect EUT or host of EUT to the power mains through a line impedance stabilization network (LISN).
3. All the support units are connected to the other LISNs. The LISN should provide 50uH/50ohms coupling impedance.
4. The frequency range from 150 kHz to 30 MHz was searched.
5. Set the test-receiver system to Peak Detect Function and Specified Bandwidth with Maximum Hold Mode.
6. The measurement has to be done between each power line and ground at the power terminal.

4.1.4 Test Setup Layout

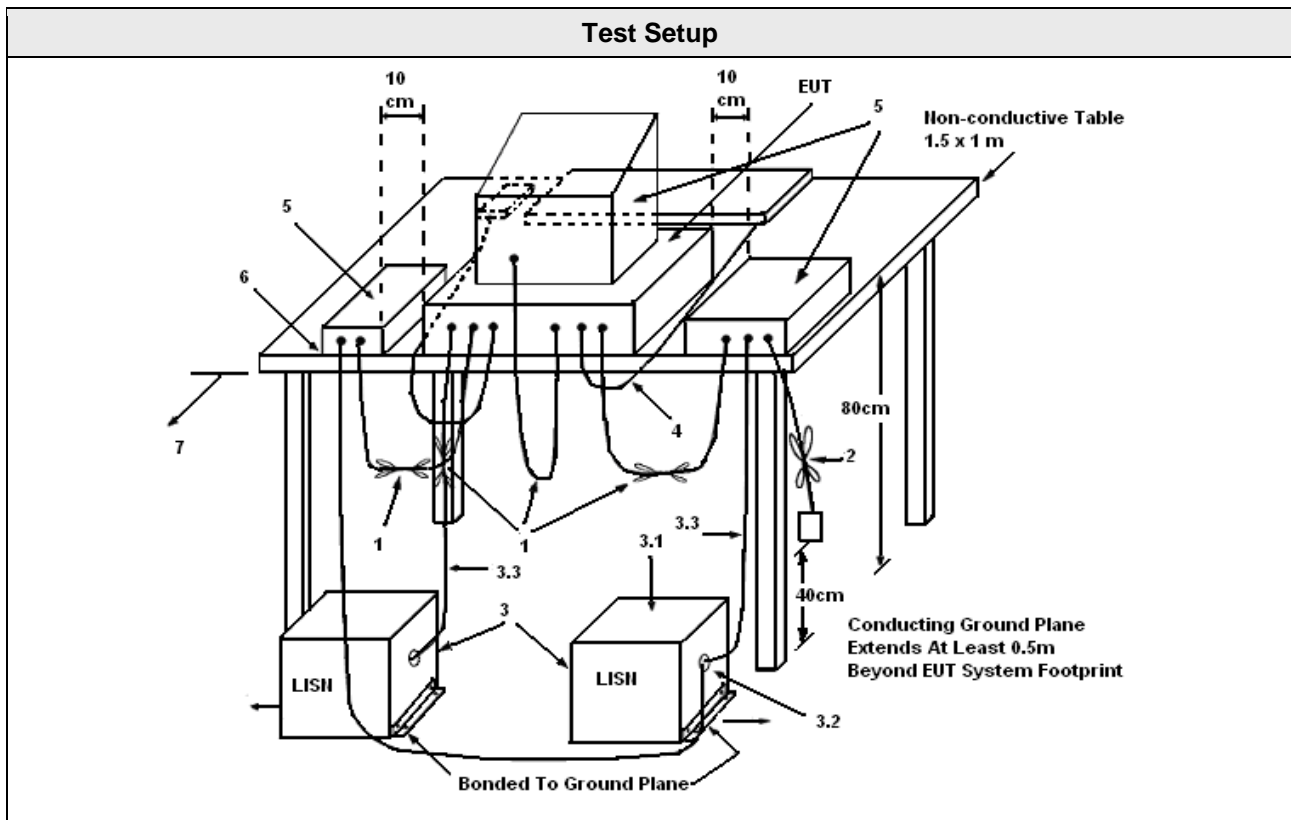

1. Interconnecting cables that hang closer than 40 cm to the ground plane shall be folded back and forth in the center forming a bundle 30 to 40 cm long.
2. I/O cables that are not connected to a peripheral shall be bundled in the center. The end of the cable may be terminated, if required, using the correct terminating impedance. The overall length shall not exceed 1 m.
3. EUT connected to one LISN. Unused LISN measuring port connectors shall be terminated in 50 Ω . LISN can be placed on top of, or immediately beneath, reference ground plane.
4. All other equipment powered from additional LISN(s).
5. Multiple outlet strip can be used for multiple power cords of non-EUT equipment.
6. LISN at least 80 cm from nearest part of EUT chassis.
7. Cables of hand-operated devices, such as keyboards, mice, etc., shall be placed as for normal use.
8. Non-EUT components of EUT system being tested.
9. Rear of EUT, including peripherals, shall all be aligned and flush with rear of tabletop.
10. Rear of tabletop shall be 40 cm removed from a vertical conducting plane that is bonded to the ground plane.

4.1.5 Test Deviation

There are no deviations with the original standard.

4.1.6 EUT Operating during Test

The EUT was placed on the test table and programmed in normal function.

4.1.7 Test Results of AC Power Conducted Emissions

Frequency Range	150kHz ~ 30MHz	Detector Function & Resolution Bandwidth	Quasi-Peak (QP) / Average (AV), 9kHz
Input Power	120Vac, 60Hz	Environmental Conditions	25°C, 75%RH
Tested by	Andy Ho		

Phase Of Power : Line (L)										
No	Frequency (MHz)	Correction Factor (dB)	Reading Value (dBuV)		Emission Level (dBuV)		Limit (dBuV)		Margin (dB)	
			Q.P.	AV.	Q.P.	AV.	Q.P.	AV.	Q.P.	AV.
1	0.16172	10.05	45.81	32.04	55.86	42.09	65.38	55.38	-9.52	-13.29
2	0.20859	10.07	37.07	22.85	47.14	32.92	63.26	53.26	-16.12	-20.34
3	0.60313	10.14	27.28	20.39	37.42	30.53	56.00	46.00	-18.58	-15.47
4	2.33984	10.24	9.82	0.10	20.06	10.34	56.00	46.00	-35.94	-35.66
5	7.49609	10.56	17.22	10.08	27.78	20.64	60.00	50.00	-32.22	-29.36
6	21.73047	11.42	21.95	16.40	33.37	27.82	60.00	50.00	-26.63	-22.18

Remarks:

1. Q.P. and AV. are abbreviations of quasi-peak and average individually.
2. The emission levels of other frequencies were very low against the limit.
3. Margin value = Emission level – Limit value
4. Correction factor = Insertion loss + Cable loss
5. Emission Level = Correction Factor + Reading Value

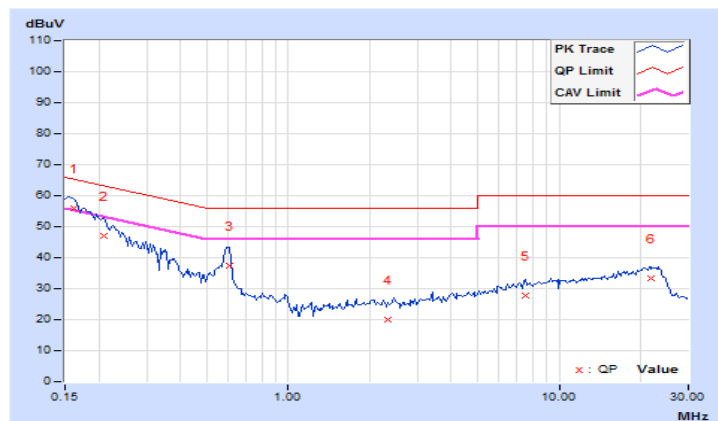

Frequency Range	150kHz ~ 30MHz	Detector Function & Resolution Bandwidth	Quasi-Peak (QP) / Average (AV), 9kHz
Input Power	120Vac, 60Hz	Environmental Conditions	25°C, 75%RH
Tested by	Andy Ho		

Phase Of Power : Neutral (N)										
No	Frequency (MHz)	Correction Factor (dB)	Reading Value (dBuV)		Emission Level (dBuV)		Limit (dBuV)		Margin (dB)	
			Q.P.	AV.	Q.P.	AV.	Q.P.	AV.	Q.P.	AV.
1	0.15000	9.95	44.35	27.35	54.30	37.30	66.00	56.00	-11.70	-18.70
2	0.17344	9.96	41.21	25.52	51.17	35.48	64.79	54.79	-13.62	-19.31
3	0.30234	10.00	27.07	14.45	37.07	24.45	60.18	50.18	-23.11	-25.73
4	0.59141	10.03	26.93	20.23	36.96	30.26	56.00	46.00	-19.04	-15.74
5	6.46094	10.33	17.01	9.46	27.34	19.79	60.00	50.00	-32.66	-30.21
6	22.76563	11.20	23.15	18.07	34.35	29.27	60.00	50.00	-25.65	-20.73

Remarks:

1. Q.P. and AV. are abbreviations of quasi-peak and average individually.
2. The emission levels of other frequencies were very low against the limit.
3. Margin value = Emission level – Limit value
4. Correction factor = Insertion loss + Cable loss
5. Emission Level = Correction Factor + Reading Value

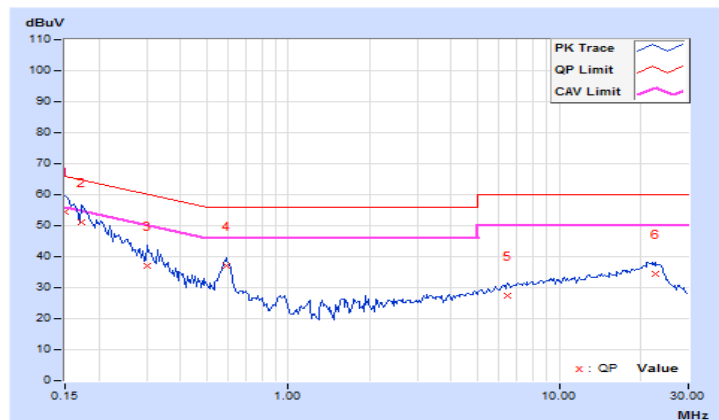

4.2 Maximum Conducted Output Power Measurement

4.2.1 Limit

For systems using digital modulation in the 2400–2483.5 MHz bands: 1 Watt (30dBm). The limit has to be reduced by the amount in dB that the gain of the antenna exceeds 6dBi. For point-to-point operation, the limit has to be reduced by 1dB for every 3dB that the directional gain of the antenna exceeds 6dBi.

4.2.2 Measuring Instruments and Setting

Please refer to section 5 of equipments list in this report. The following table is the setting of the power meter.

Power Meter Parameter	Setting
Power Measurement	Auto
Rise Time	8ns
Sensor Model	MA2411B

4.2.3 Test Procedures

- 1 Test was performed in accordance with Measurement of Digital Transmission Systems Operating under KDB558074 D01 DTS Meas Guidance v04, in section "Maximum conducted output power Method AVGPM-G", 04/05/2017
- 2 The average power sensor was used on the output port of the EUT. A power meter was used to read the response of the average power sensor and enable the trigger function to get the all on time transmission. Record the average power level.
- 3 When measuring maximum conducted output power with multiple antenna systems, add every result of the values by mathematic formula.

4.2.4 Test Setup Layout

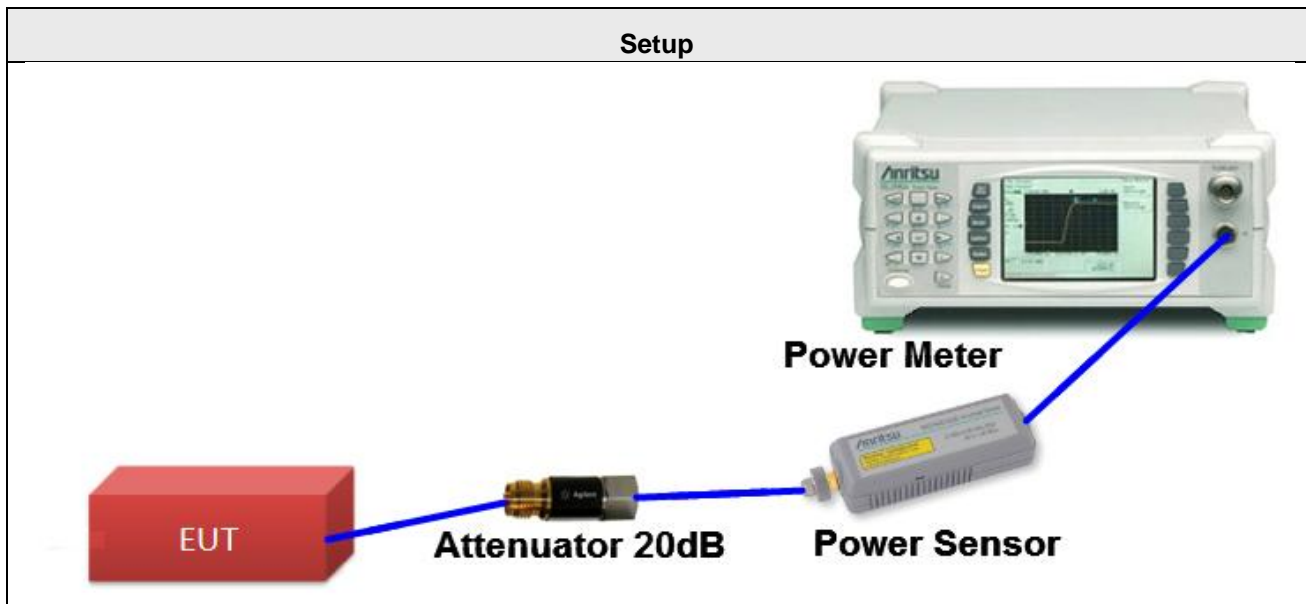

4.2.5 Test Deviation

There are no deviations with the original standard.

4.2.6 EUT Operating Conditions

The EUT was programmed to be in continuously transmitting mode.

4.2.7 Test Results of Maximum Conducted Output Power

Temperature	25°C	Humidity	60%
Test Engineer	Anderson Chen		

FOR AVERAGE POWER

802.11b 1Tx Chain1

Channel	Frequency (MHz)	Conducted Power (dBm)	Directional Gain (dBi)	Max. Limit (dBm)	Result
1	2412	17.02	2.60	30	PASS
6	2437	17.32	2.70	30	PASS
11	2462	16.75	2.60	30	PASS

802.11g 1Tx Chain1

Channel	Frequency (MHz)	Conducted Power (dBm)	Directional Gain (dBi)	Max. Limit (dBm)	Result
1	2412	16.78	2.60	30	PASS
6	2437	17.69	2.70	30	PASS
11	2462	16.91	2.60	30	PASS

802.11n (20MHz) 1Tx Chain1

Channel	Frequency (MHz)	Conducted Power (dBm)	Directional Gain (dBi)	Max. Limit (dBm)	Result
1	2412	16.39	2.60	30	PASS
6	2437	17.23	2.70	30	PASS
11	2462	16.67	2.60	30	PASS

802.11n (20MHz) 1Tx Chain2

Channel	Frequency (MHz)	Conducted Power (dBm)	Directional Gain (dBi)	Max. Limit (dBm)	Result
1	2412	16.83	3.70	30	PASS
6	2437	17.88	3.00	30	PASS
11	2462	16.68	3.10	30	PASS

802.11n (20MHz) 2Tx CDD

Channel	Frequency (MHz)	Conducted Power (dBm)			Directional Gain (dBi)	Max. Limit (dBm)	Result
		Chain 1	Chain 2	Total			
1	2412	15.64	15.69	18.68	4.78	30	PASS
6	2437	16.58	16.62	19.61	4.63	30	PASS
11	2462	15.29	15.46	18.39	4.69	30	PASS

Note:

1. Total Conducted Power = Conducted Power [TX 1(unit in W) + TX 2(unit in W)](unit in dBm)
2. Directional Gain <6dBi, so the limit doesn't reduce.

802.11n (20MHz) 2Tx SDM

Channel	Frequency (MHz)	Conducted Power (dBm)			Directional Gain (dBi)	Max. Limit (dBm)	Result
		Chain 1	Chain 2	Total			
1	2412	15.56	15.43	18.51	2.00	30	PASS
6	2437	16.51	16.41	19.47	1.71	30	PASS
11	2462	15.22	15.34	18.29	1.72	30	PASS

Note:

1. Total Conducted Power = Conducted Power [TX 1(unit in W) + TX 2(unit in W)](unit in dBm)
2. Directional Gain <6dBi, so the limit doesn't reduce.

802.11n (40MHz) 1Tx Chain1

Channel	Frequency (MHz)	Conducted Power (dBm)	Directional Gain (dBi)	Max. Limit (dBm)	Result
3	2422	16.25	2.70	30	PASS
6	2437	16.91	2.70	30	PASS
9	2452	16.44	2.60	30	PASS

802.11n (40MHz) 1Tx Chain2

Channel	Frequency (MHz)	Conducted Power (dBm)	Directional Gain (dBi)	Max. Limit (dBm)	Result
3	2422	16.74	3.60	30	PASS
6	2437	16.69	3.00	30	PASS
9	2452	16.48	3.00	30	PASS

802.11n (40MHz) 2Tx CDD

Channel	Frequency (MHz)	Conducted Power (dBm)			Directional Gain (dBi)	Max. Limit (dBm)	Result
		Chain 1	Chain 2	Total			
3	2422	15.25	15.41	18.34	4.68	30	PASS
6	2437	15.46	15.7	18.59	4.63	30	PASS
9	2452	15.24	15.53	18.40	4.73	30	PASS

Note:

1. Total Conducted Power = Conducted Power [TX 1(unit in W) + TX 2(unit in W)](unit in dBm)
2. Directional Gain <6dBi, so the limit doesn't reduce.

802.11n (40MHz) 2Tx SDM

Channel	Frequency (MHz)	Conducted Power (dBm)			Directional Gain (dBi)	Max. Limit (dBm)	Result
		Chain 1	Chain 2	Total			
3	2422	15.17	15.34	18.27	1.89	30	PASS
6	2437	15.4	15.38	18.40	1.71	30	PASS
9	2452	15.03	15.13	18.09	1.76	30	PASS

Note:

1. Total Conducted Power = Conducted Power [TX 1(unit in W) + TX 2(unit in W)](unit in dBm)
2. Directional Gain <6dBi, so the limit doesn't reduce.

4.3 Power Spectral Density Measurement

4.3.1 Limit

For digitally modulated systems, the conductive measured power spectral density(PSD) shall not be greater than 8 dBm in any 3 kHz bandwidth during any time interval of continuous transmission.

4.3.2 Measuring Instruments and Setting

Please refer to section 5 of equipments list in this report. The following table is the setting of the spectrum analyzer.

Spectrum Parameter	Setting
Attenuation	Auto
Span Frequency	Set the span to 1.5 times the DTS channel bandwidth.
RBW	Set the RBW \geq 3 kHz
VBW	Set the VBW \geq 3 x RBW
Detector	RMS
Trace	Average sweep count 100
Sweep Time	Auto couple

4.3.3 Test Procedures

- 1 The transmitter output (antenna port) was connected to the spectrum analyzer.
- 2 Test was performed in accordance with Measurement of Digital Transmission Systems Operating under KDB558074 D01 DTS Meas Guidance v04, in section "Maximum power spectral density level in the fundamental emissions Method AVGPS-1", 04/05/2017.
- 3 Multiple antenna systems was performed in accordance KDB 662911 D01 v02r01 in-Band Power Spectral Density (PSD) Measurements (a) Measure and sum the spectra across the outputs (bin-by-bin summing).
- 4 This procedure may be used when the maximum (average) conducted output power was used to demonstrate compliance to the output power limit. The EUT must be configured to transmit continuously (duty cycle \geq 98%) to ensure that measurements are made only when the EUT is transmitting at its maximum power control level (no transmitter off time is to be considered).
- 5 Ensure that the number of measurement points in the sweep \geq 2 x span/RBW (use of a greater number of measurement points than this minimum requirement is recommended).
- 6 When measuring first spectral bin of output 1 is summed with that in the first spectral bin of output 2 and so on up to the Nth output to obtain the value for the first frequency bin of the summed spectrum. The summed spectrum value for each of the other frequency bins is computed in the same way.

4.3.4 Test Setup Layout

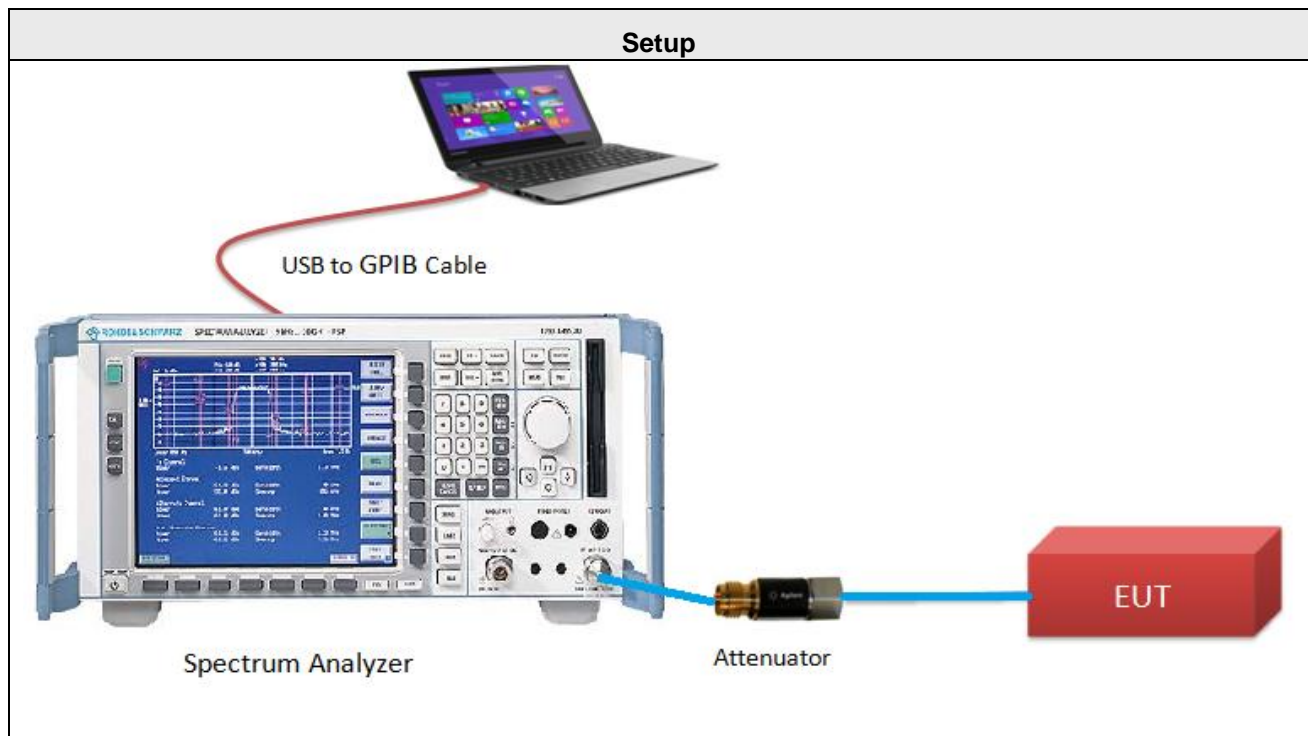

4.3.5 Test Deviation

There are no deviations with the original standard.

4.3.6 EUT Operating Conditions

The EUT was programmed to be in continuously transmitting mode.

4.3.7 Test Results of Power Spectral Density

Temperature	25°C	Humidity	60%
Test Engineer	Anderson Chen		

802.11b 1Tx Chain1

Channel	Frequency (MHz)	Power Density (dBm/3kHz)	Directional Gain (dBi)	Limit (dBm/3kHz)	Result
1	2412	-12.95	2.60	8	PASS
6	2437	-11.66	2.70	8	PASS
11	2462	-12.81	2.60	8	PASS

Note: Directional Gain <6dBi, so the limit doesn't reduce.

802.11g 1Tx Chain1

Channel	Frequency (MHz)	Power Density (dBm/3kHz)	Directional Gain (dBi)	Limit (dBm/3kHz)	Result
1	2412	-13.99	2.60	8	PASS
6	2437	-14.95	2.70	8	PASS
11	2462	-13.89	2.60	8	PASS

Note: Directional Gain <6dBi, so the limit doesn't reduce.

802.11n (20MHz) 1Tx Chain2

Channel	Frequency (MHz)	Power Density (dBm/3kHz)	Directional Gain (dBi)	Limit (dBm/3kHz)	Result
1	2412	-15.92	3.70	8	PASS
6	2437	-15.53	3.00	8	PASS
11	2462	-14.10	3.10	8	PASS

Note: Directional Gain <6dBi, so the limit doesn't reduce.

802.11n (20MHz) 2Tx CDD

Channel	Frequency (MHz)	Power Density (dBm/3kHz)	Directional Gain (dBi)	Limit (dBm/3kHz)	Result
1	2412	-12.88	4.78	8	PASS
6	2437	-12.25	4.63	8	PASS
11	2462	-16.86	4.69	8	PASS

Note: Directional Gain <6dBi, so the limit doesn't reduce.

Note: Method a) of power density measurement of KDB 662911 is using for calculating total power density. Total power density is summing entire spectra across corresponding frequency bins on the various outputs by computer.

802.11n (40MHz) 1Tx Chain2

Channel	Frequency (MHz)	PSD w/o Duty Factor (dBm/3kHz)	Duty Factor (dB)	PSD With Duty Factor (dBm/3kHz)	Directional Gain (dBi)	Limit (dBm/3kHz)	Result
3	2422	-18.31	0.14	-18.17	3.60	8	PASS
6	2437	-20.57	0.14	-20.43	3.00	8	PASS
9	2452	-18.32	0.14	-18.18	3.00	8	PASS

Note: Directional Gain <6dBi, so the limit doesn't reduce.

802.11n (40MHz) 2Tx CDD

Channel	Frequency (MHz)	PSD w/o Duty Factor (dBm/3kHz)	Duty Factor (dB)	PSD With Duty Factor (dBm/3kHz)	Directional Gain (dBi)	Limit (dBm/3kHz)	Result
3	2422	-15.89	0.14	-15.75	4.68	8	PASS
6	2437	-16.47	0.14	-16.33	4.63	8	PASS
9	2452	-17.11	0.14	-16.97	4.73	8	PASS

Note: Directional Gain <6dBi, so the limit doesn't reduce.

Note: Method a) of power density measurement of KDB 662911 is using for calculating total power density. Total power density is summing entire spectra across corresponding frequency bins on the various outputs by computer.

SPECTRUM PLOT

802.11b 1Tx Chain1 2412 MHz

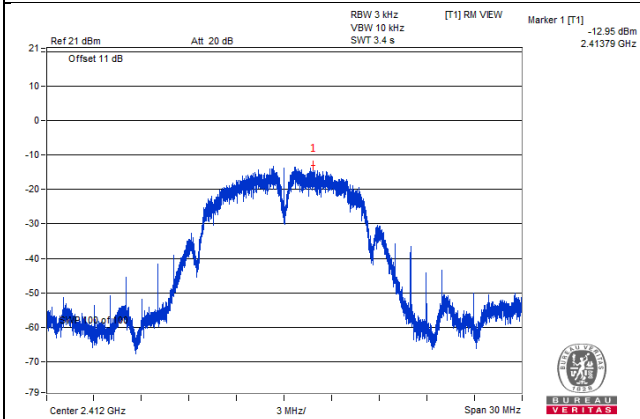

802.11b 1Tx Chain1 2437 MHz

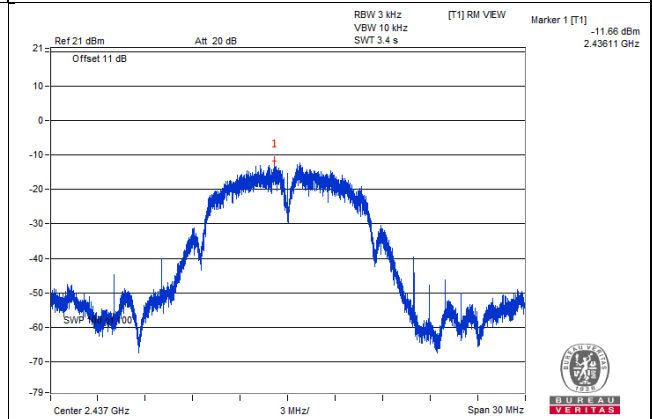

802.11b 1Tx Chain1 2462 MHz

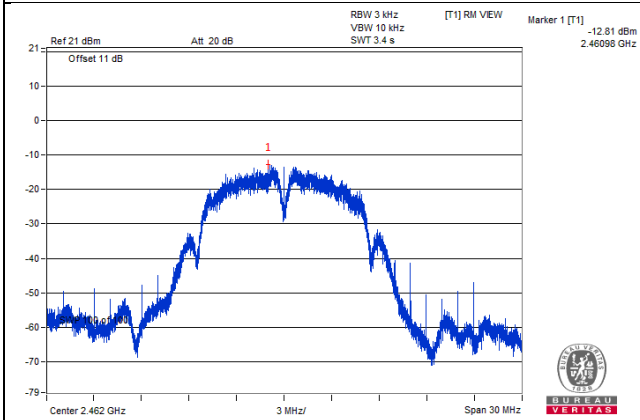

SPECTRUM PLOT

802.11g 1Tx Chain1 2412 MHz

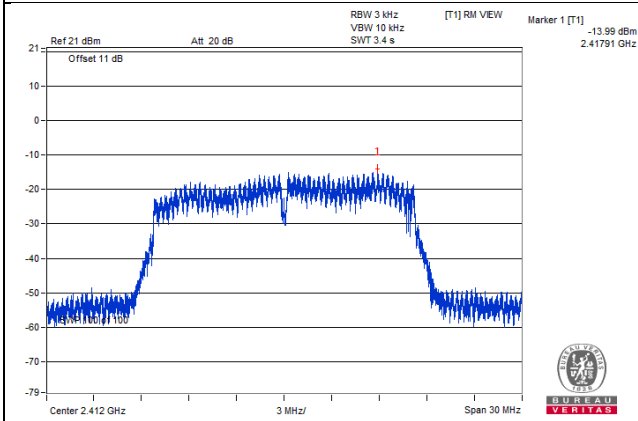

802.11g 1Tx Chain1 2437 MHz

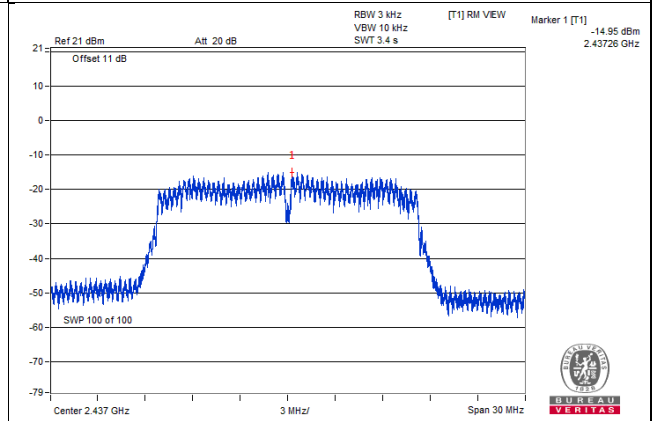

802.11g 1Tx Chain1 2462 MHz

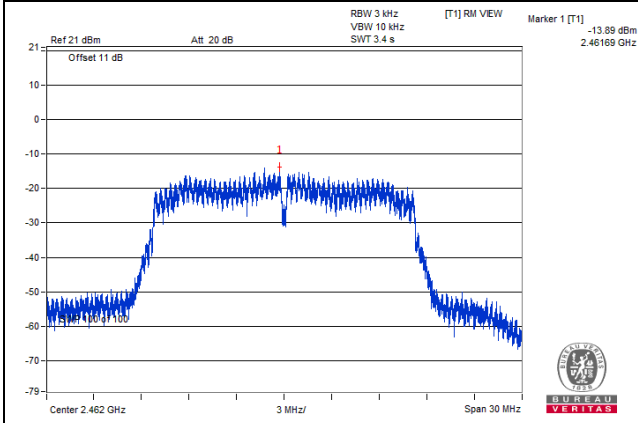

SPECTRUM PLOT

802.11n (20MHz) 1Tx Chain2 2412 MHz

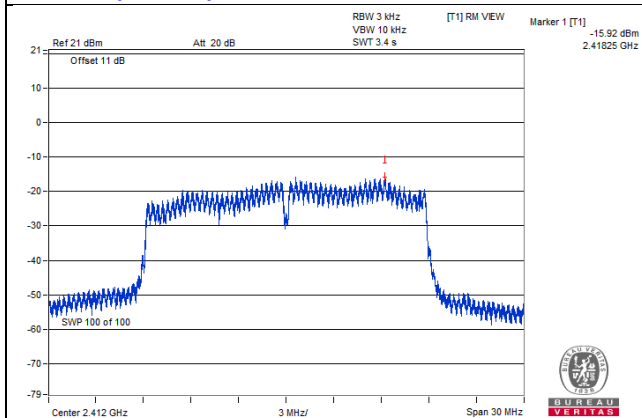

802.11n (20MHz) 1Tx Chain2 2437 MHz

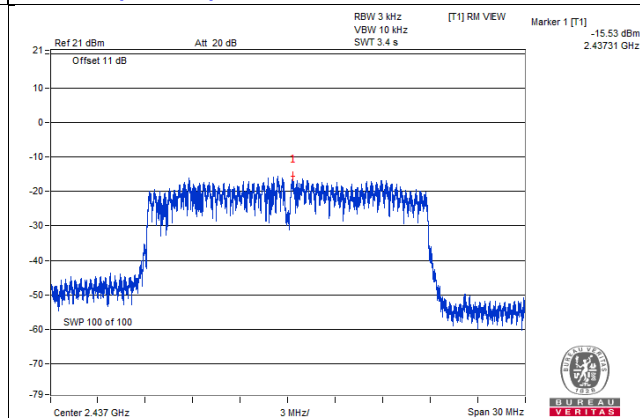

802.11n (20MHz) 1Tx Chain2 2462 MHz

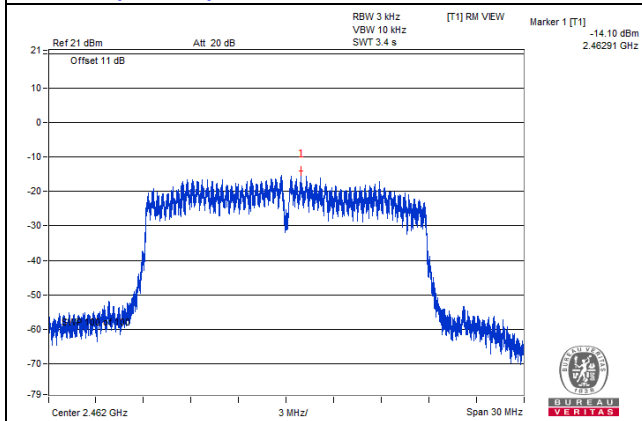

SPECTRUM PLOT

802.11n (20MHz) 2Tx CDD 2412 MHz

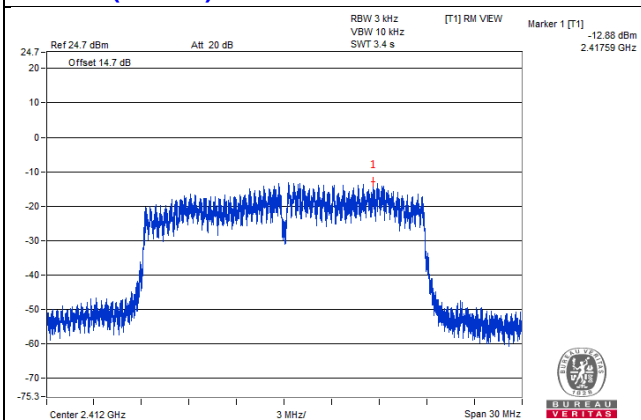

802.11n (20MHz) 2Tx CDD 2437 MHz

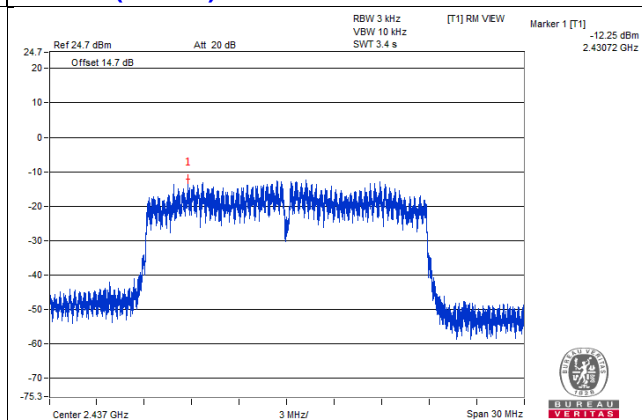

802.11n (20MHz) 2Tx CDD 2462 MHz

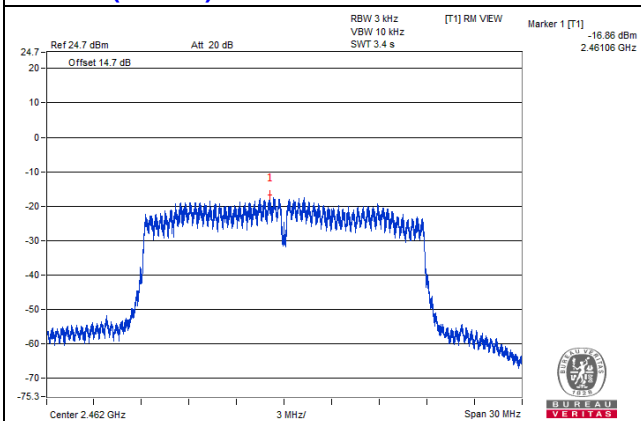

SPECTRUM PLOT

802.11n (40MHz) 1Tx Chain2 2422 MHz

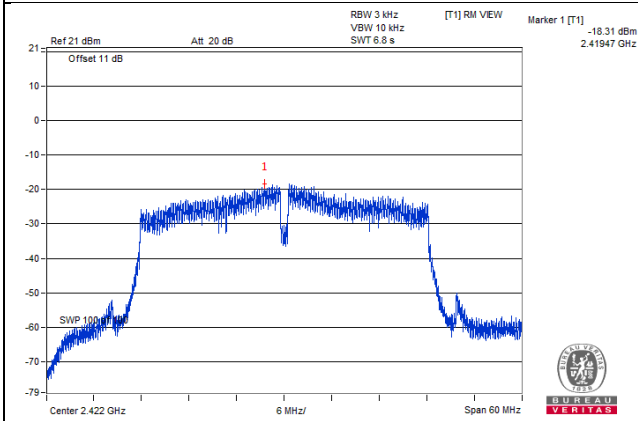

802.11n (40MHz) 1Tx Chain2 2437 MHz

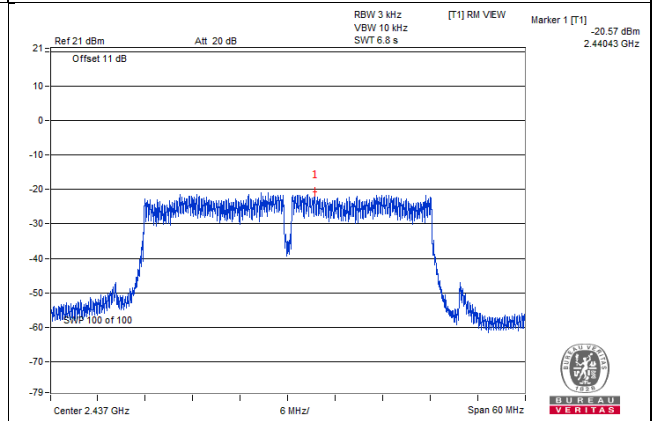

802.11n (40MHz) 1Tx Chain2 2452 MHz

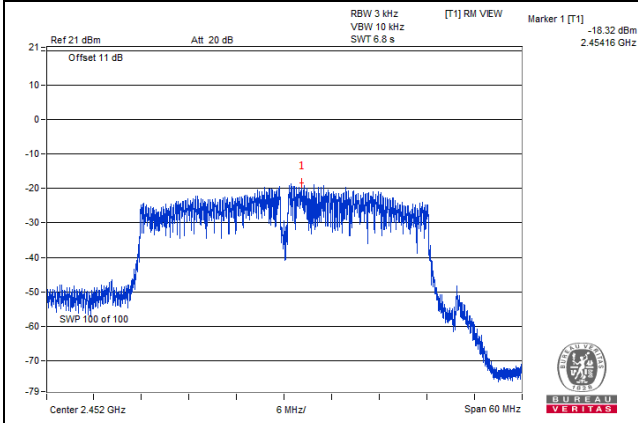

SPECTRUM PLOT

802.11n (40MHz) 2Tx CDD 2422 MHz

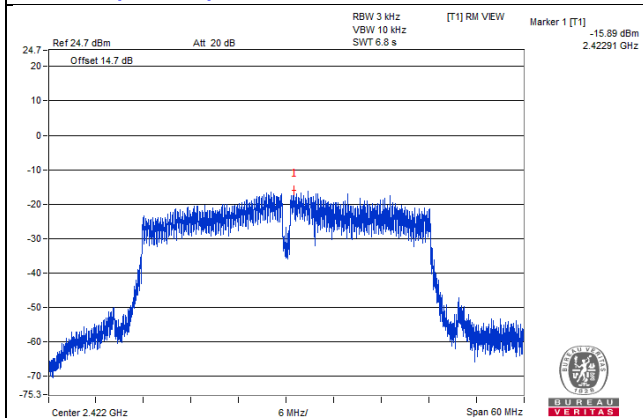

802.11n (40MHz) 2Tx CDD 2437 MHz

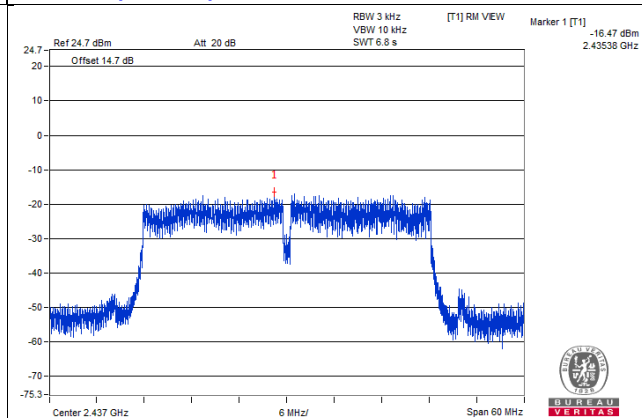

802.11n (40MHz) 2Tx CDD 2452 MHz

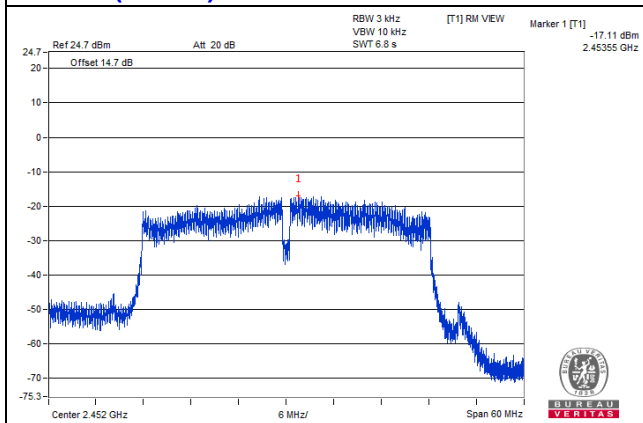

4.4 6dB Bandwidth Measurement

4.4.1 Limit

For digital modulation systems, the minimum 6dB bandwidth shall be at least 500 kHz

4.4.2 Measuring Instruments and Setting

The following table is the setting of the Spectrum Analyzer.

Spectrum Parameter	Setting
Attenuation	Auto
Span Frequency	> 6dB Bandwidth
RBW	100 kHz.
VBW	$\geq 3 \times \text{RBW}$
Detector	Peak
Trace	Max Hold
Sweep Time	Auto couple

4.4.3 Test Procedures

- 1 The transmitter output (antenna port) was connected to the spectrum analyzer in peak hold mode.
- 2 For each RF output channel investigated, the spectrum analyzer center frequency was set to the channel carrier frequency. A peak reading was taken; two markers were set 6 dB below the maximum level on the right and the left side of the emissions.
- 3 The 6dB bandwidth is the frequency difference between the two markers.

4.4.4 Test Setup Layout

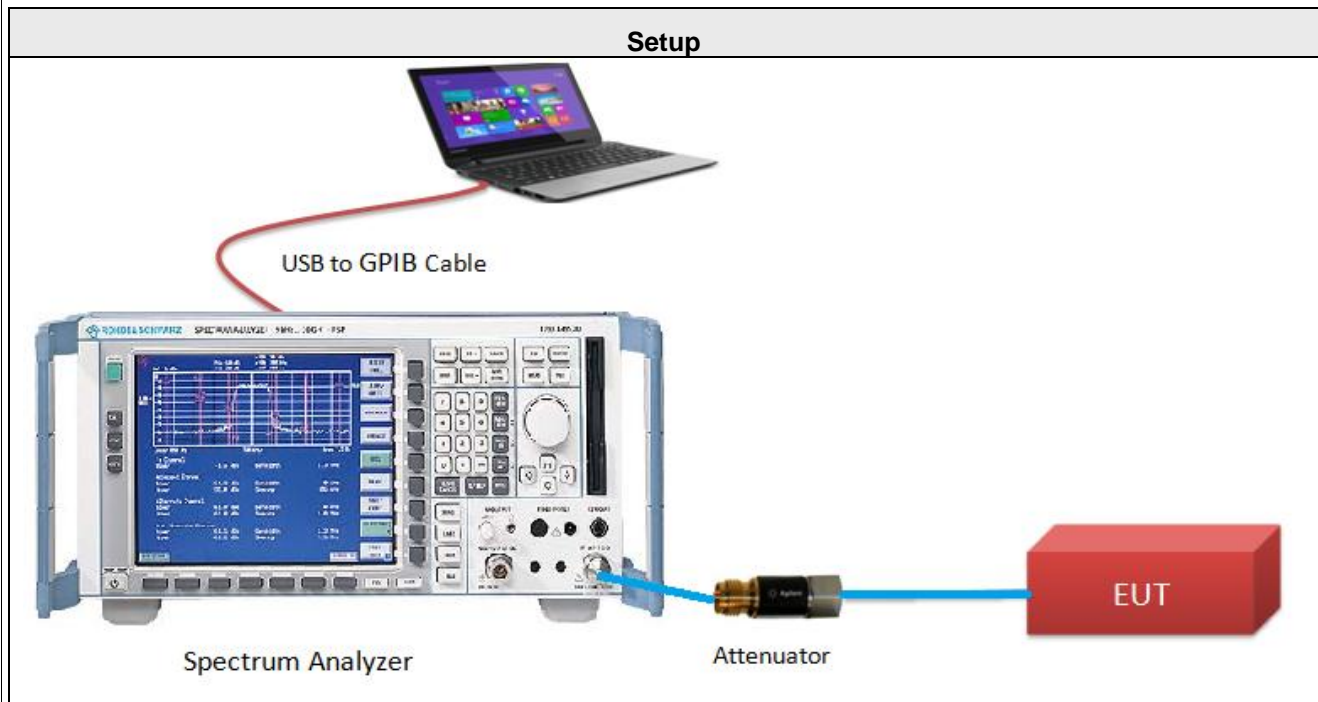

4.4.5 Test Deviation

There are no deviations with the original standard.

4.4.6 EUT Operating Conditions

The EUT was programmed to be in continuously transmitting mode.

4.4.7 Test Results of 6dB Bandwidth

Temperature	25°C	Humidity	60%
Test Engineer	Anderson Chen		

802.11b 1Tx Chain1

CHANNEL	FREQUENCY (MHz)	6dB BANDWIDTH (MHz)	MINIMUM LIMIT (MHz)	PASS / FAIL
1	2412	8.12	0.5	PASS
6	2437	8.10	0.5	PASS
11	2462	8.13	0.5	PASS

802.11g 1Tx Chain1

CHANNEL	FREQUENCY (MHz)	6dB BANDWIDTH (MHz)	MINIMUM LIMIT (MHz)	PASS / FAIL
1	2412	15.65	0.5	PASS
6	2437	15.18	0.5	PASS
11	2462	15.16	0.5	PASS

802.11n (20MHz) 2Tx CDD

CHANNEL	FREQUENCY (MHz)	6dB BANDWIDTH (MHz)		MINIMUM LIMIT (MHz)	PASS / FAIL
		CHAIN 1	CHAIN 2		
1	2412	16.11	14.69	0.5	PASS
6	2437	15.15	17.11	0.5	PASS
11	2462	15.11	15.11	0.5	PASS

802.11n (40MHz) 2Tx CDD

CHANNEL	FREQUENCY (MHz)	6dB BANDWIDTH (MHz)		MINIMUM LIMIT (MHz)	PASS / FAIL
		CHAIN 1	CHAIN 2		
3	2422	32.75	32.56	0.5	PASS
6	2437	35.78	36.57	0.5	PASS
9	2452	35.18	31.39	0.5	PASS

SPECTRUM PLOT

802.11b 1Tx Chain1 CH1

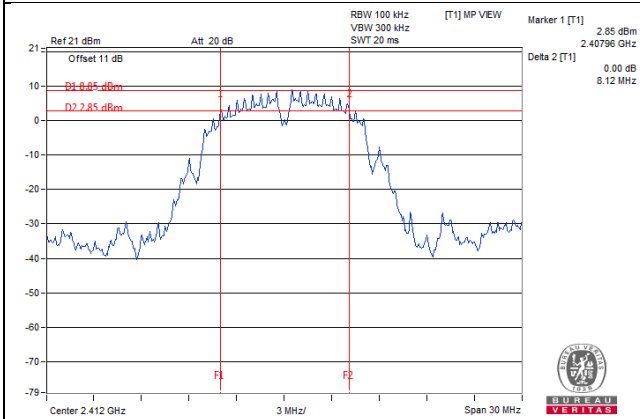

802.11b 1Tx Chain1 CH6

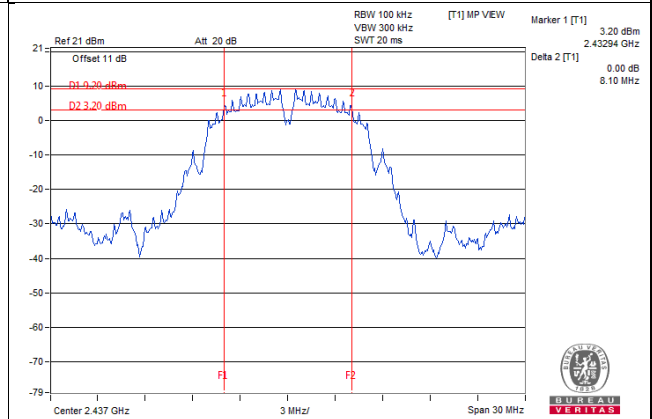

802.11b 1Tx Chain1 CH11

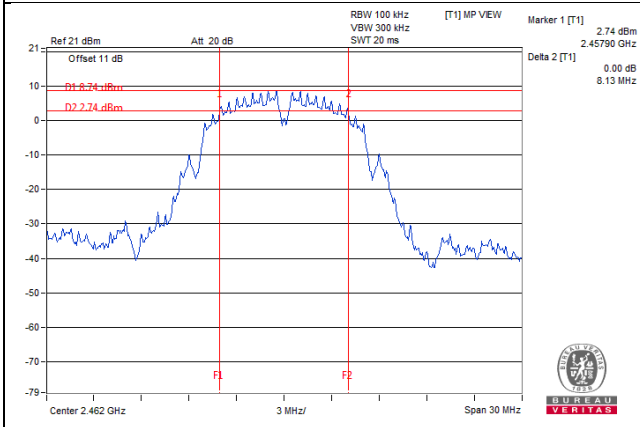

SPECTRUM PLOT

802.11g 1Tx Chain1 CH1

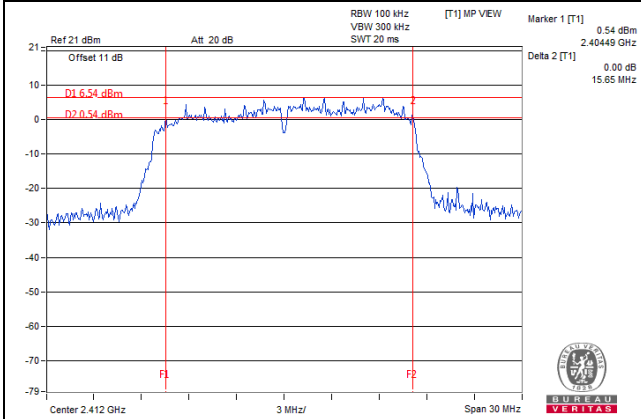

802.11g 1Tx Chain1 CH6

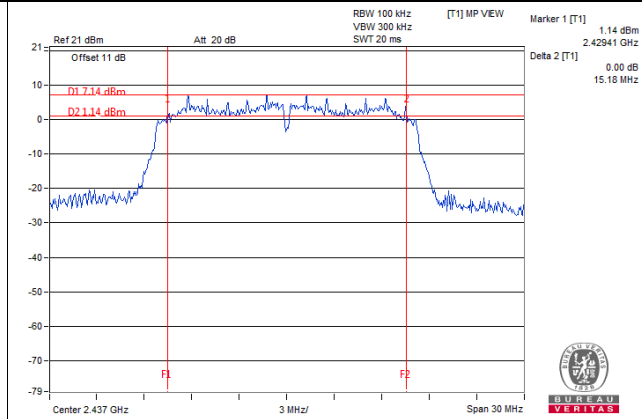

802.11g 1Tx Chain1 CH11

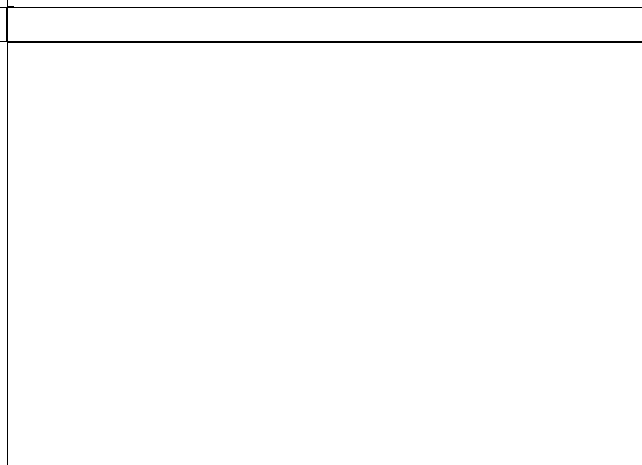
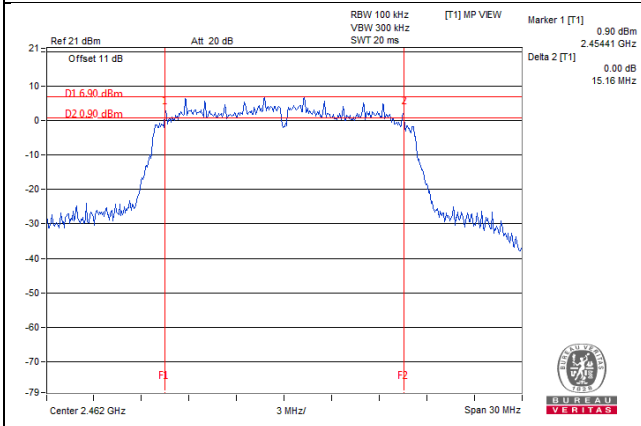

SPECTRUM PLOT

802.11n (20MHz) 2Tx CDD mode Chain1 CH1

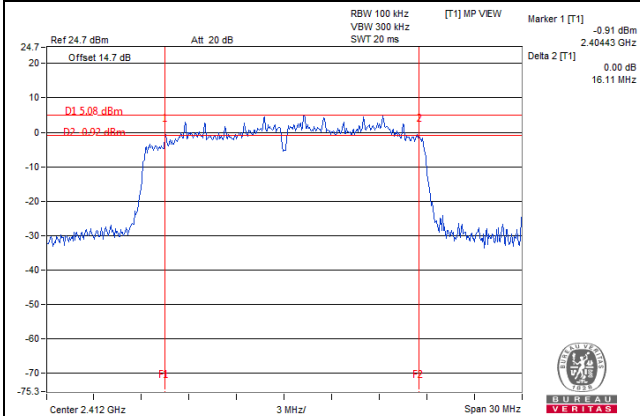

802.11n (20MHz) 2Tx CDD mode Chain2 CH1

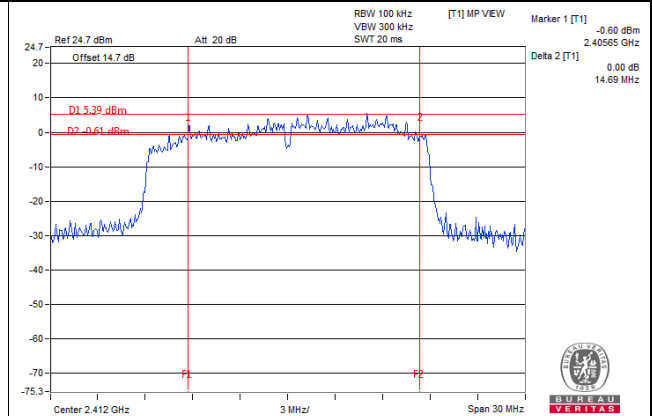

802.11n (20MHz) 2Tx CDD mode Chain1 CH6

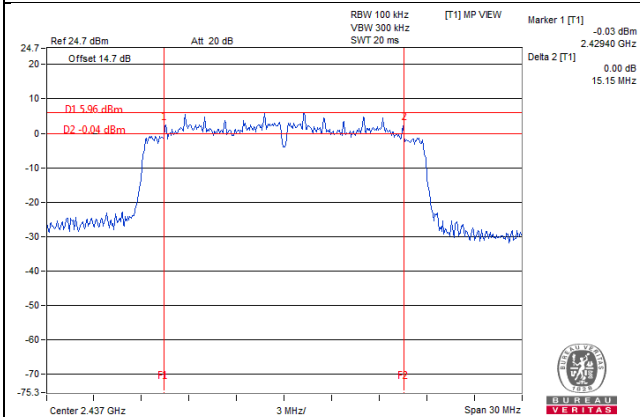

802.11n (20MHz) 2Tx CDD mode Chain2 CH6

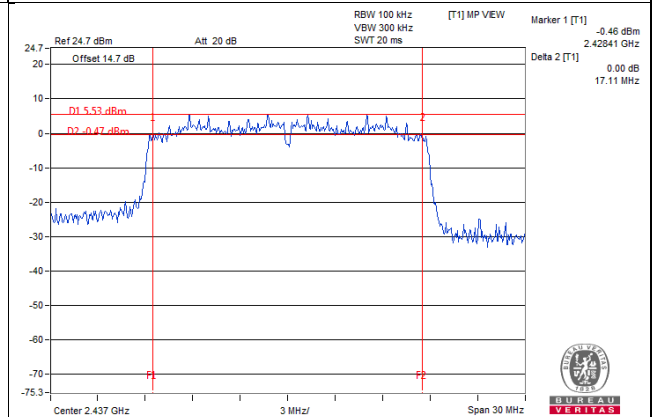

802.11n (20MHz) 2Tx CDD mode Chain1 CH11

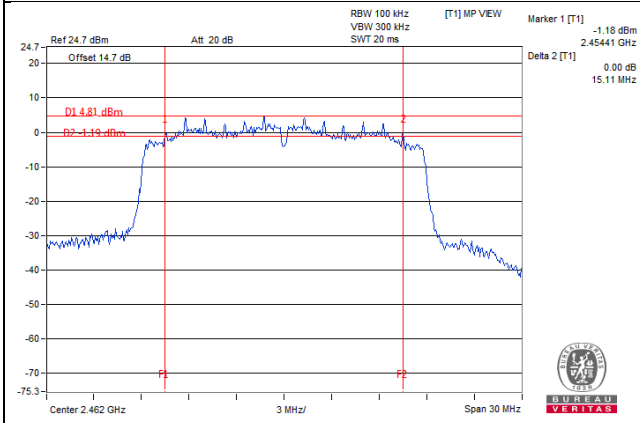

802.11n (20MHz) 2Tx CDD mode Chain2 CH11

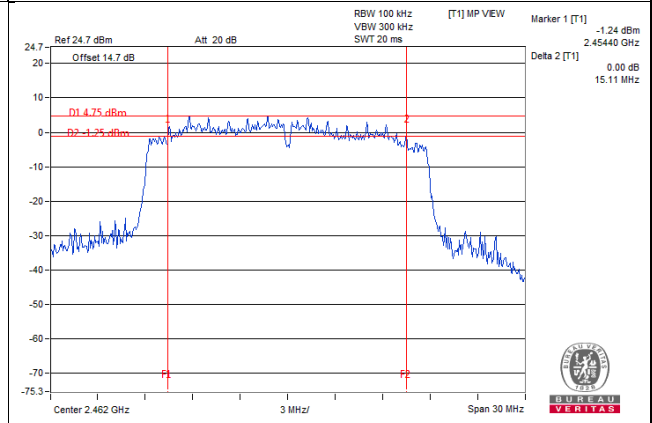

SPECTRUM PLOT

802.11n (40MHz) 2Tx CDD mode Chain1 CH3

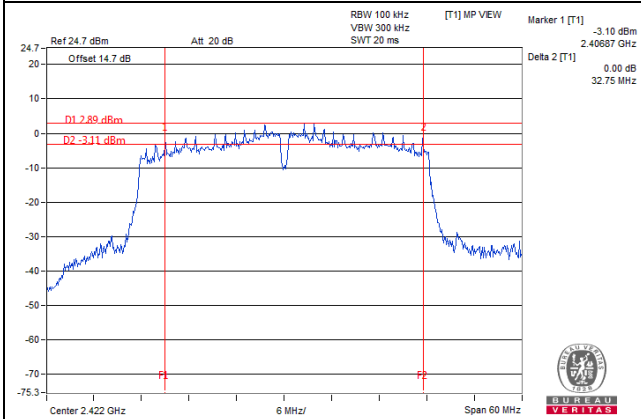

802.11n (40MHz) 2Tx CDD mode Chain2 CH3

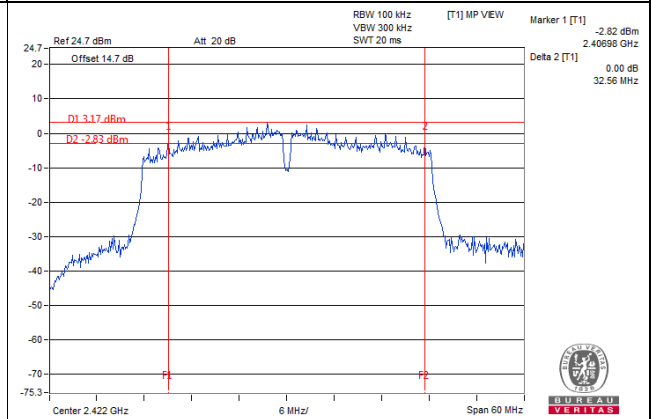

802.11n (40MHz) 2Tx CDD mode Chain1 CH6

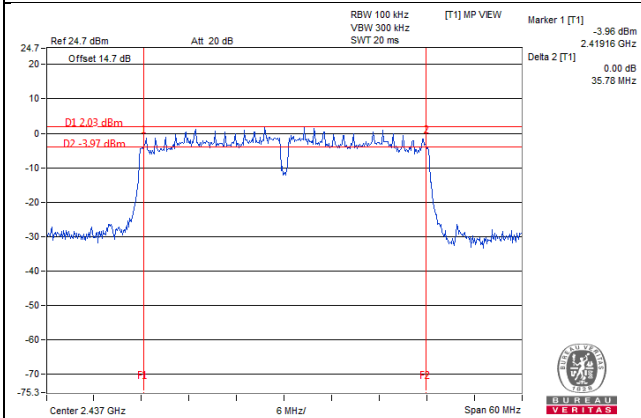

802.11n (40MHz) 2Tx CDD mode Chain2 CH6

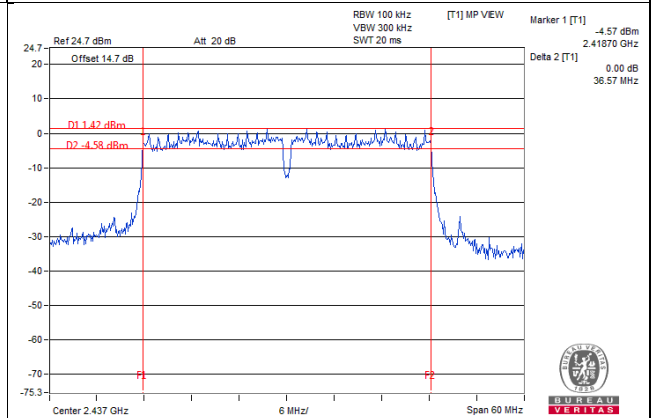

802.11n (40MHz) 2Tx CDD mode Chain1 CH9

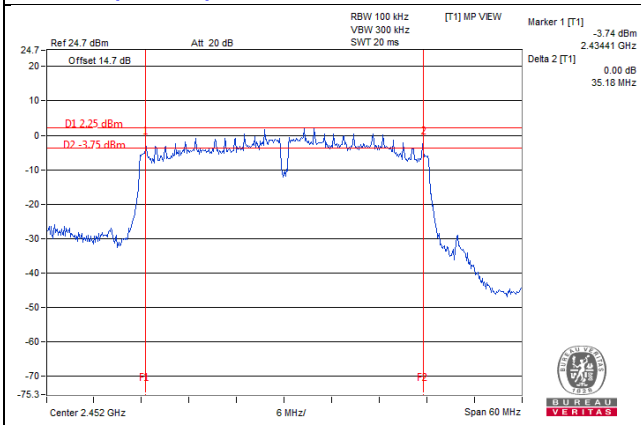

802.11n (40MHz) 2Tx CDD mode Chain2 CH9

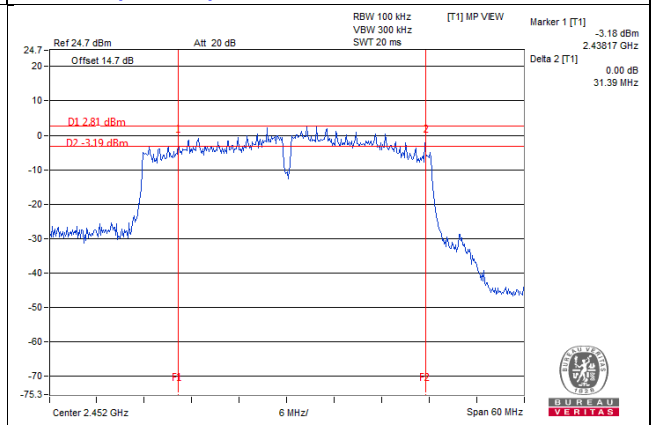

4.5 Occupied Bandwidth Measurement

4.5.1 Measuring Instruments and Setting

The following table is the setting of the Spectrum Analyzer.

Spectrum Parameter	Setting
Attenuation	Auto
RBW	1% to 5% of the anticipated emission bandwidth
VBW	$\geq 3 \times \text{RBW}$
Detector	Peak
Trace	Max Hold
Sweep Time	Auto couple

4.5.2 Test Procedure

- 1 The transmitter output (antenna port) was connected to the spectrum analyzer in peak, Max hold mode.
- 2 For each RF output channel investigated, the spectrum analyzer center frequency was set to the channel carrier frequency. The bandwidth of the fundamental frequency was measured by spectrum analyzer with resolution bandwidth in the range of 1% to 5% of the anticipated emission bandwidth, and a video bandwidth at least 3x the resolution bandwidth and set the detector to peak.
- 3 The width of a frequency band such that, below the lower and above the upper frequency limits, the mean powers emitted are each equal to a specified percentage 0.5 %of the total mean power of a given emission.

4.5.3 Test Setup Layout

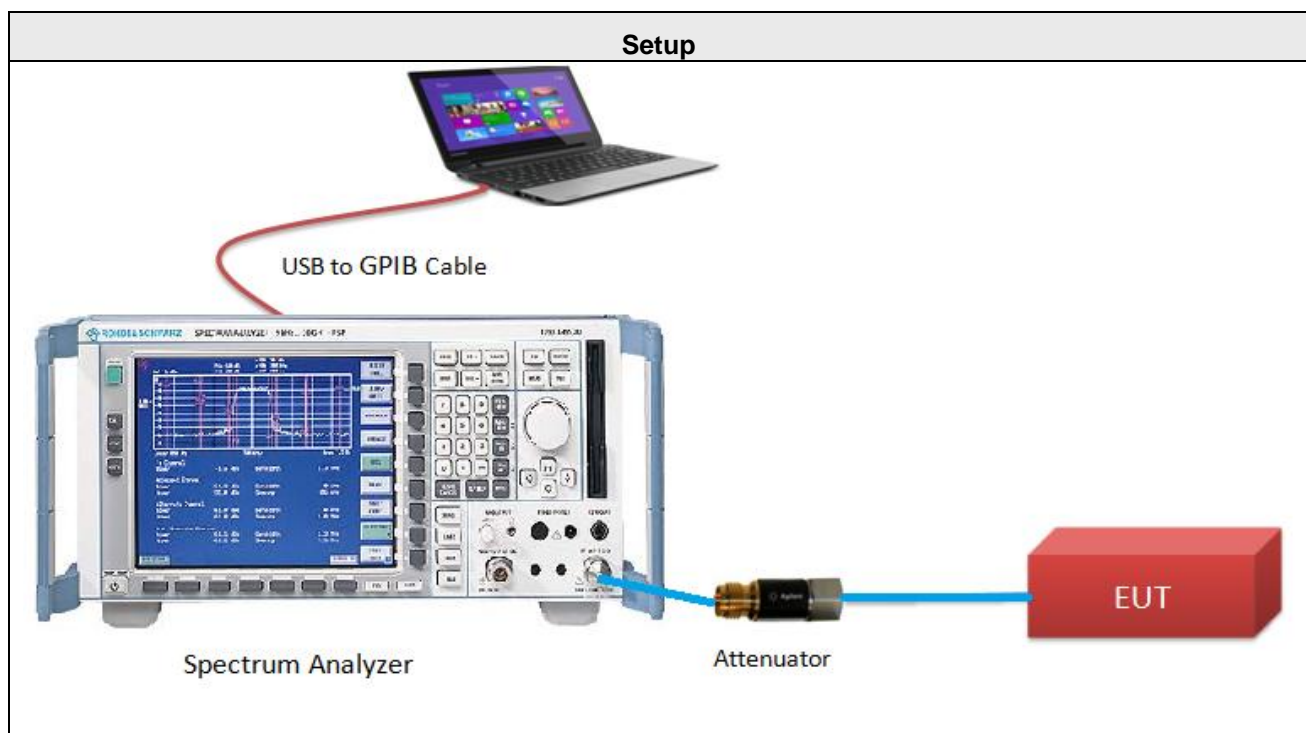

4.5.4 Test Deviation

There are no deviations with the original standard.

4.5.5 EUT Operating Conditions

The EUT was programmed to be in continuously transmitting mode.

4.5.6 Test Results of Occupied Bandwidth

Temperature	25°C	Humidity	60%
Test Engineer	Anderson Chen		

802.11b 1Tx Chain1

CHANNEL	FREQUENCY (MHz)	OCCUPIED BANDWIDTH (MHz)
1	2412	10.20
6	2437	10.32
11	2462	10.20

802.11g 1Tx Chain1

CHANNEL	FREQUENCY (MHz)	OCCUPIED BANDWIDTH (MHz)
1	2412	16.56
6	2437	16.68
11	2462	16.32

802.11n (20MHz) 2Tx CDD

CHANNEL	FREQUENCY (MHz)	OCCUPIED BANDWIDTH (MHz)	
		CHAIN 1	CHAIN 2
1	2412	17.52	17.52
6	2437	17.64	17.64
11	2462	17.52	17.52

802.11n (40MHz) 2Tx CDD

CHANNEL	FREQUENCY (MHz)	OCCUPIED BANDWIDTH (MHz)	
		CHAIN 1	CHAIN 2
3	2422	36.24	36.24
6	2437	36.72	36.96
9	2452	36.48	36.24

SPECTRUM PLOT

802.11b 1Tx Chain1 CH1

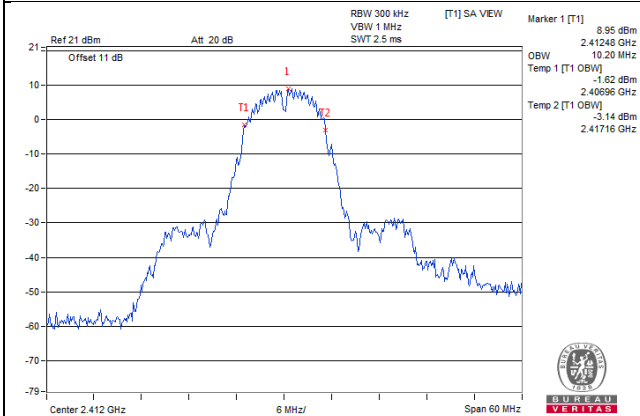

802.11b 1Tx Chain1 CH6

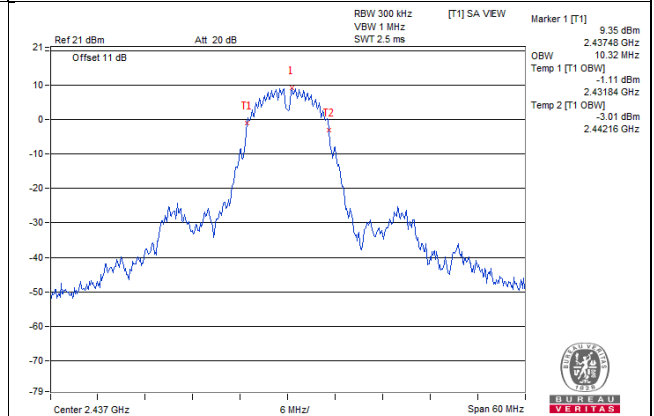

802.11b 1Tx Chain1 CH11

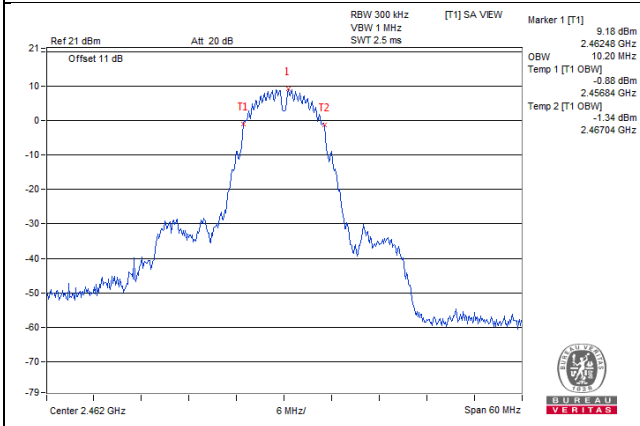

SPECTRUM PLOT

802.11g 1Tx Chain1 CH1

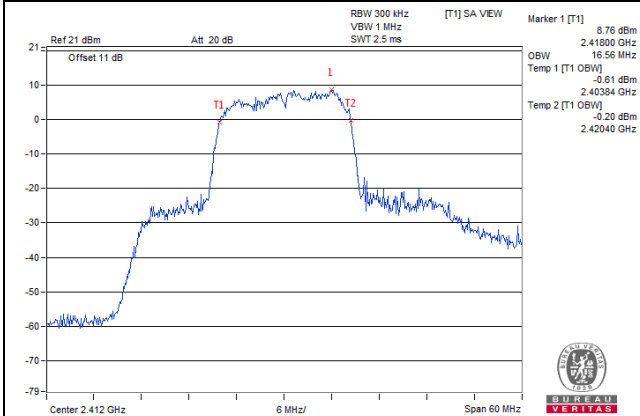

802.11g 1Tx Chain1 CH6

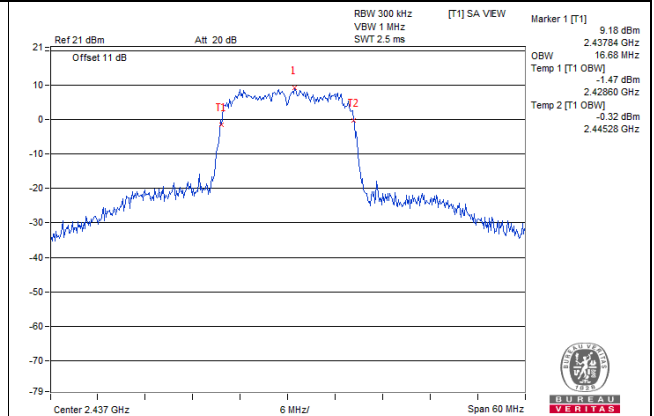

802.11g 1Tx Chain1 CH11

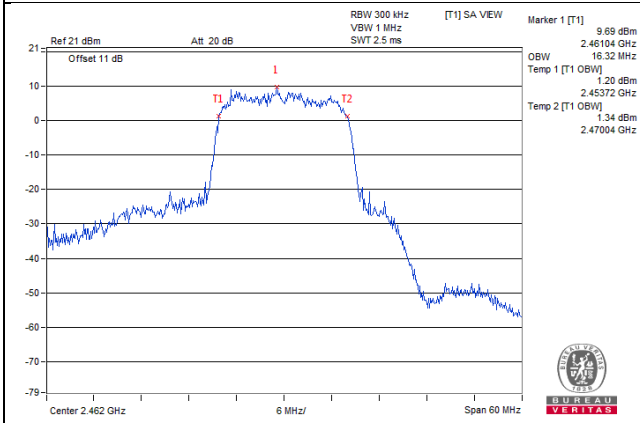

SPECTRUM PLOT

802.11n (20MHz) 2Tx CDD mode Chain1 CH1

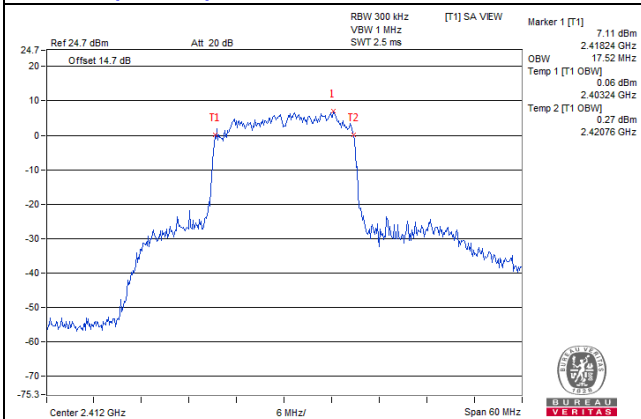

802.11n (20MHz) 2Tx CDD mode Chain2 CH1

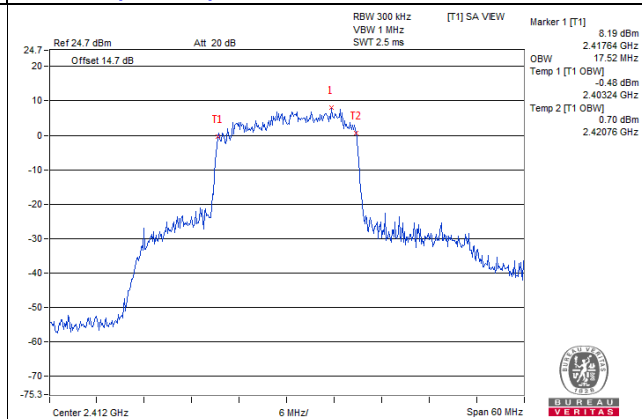

802.11n (20MHz) 2Tx CDD mode Chain1 CH6

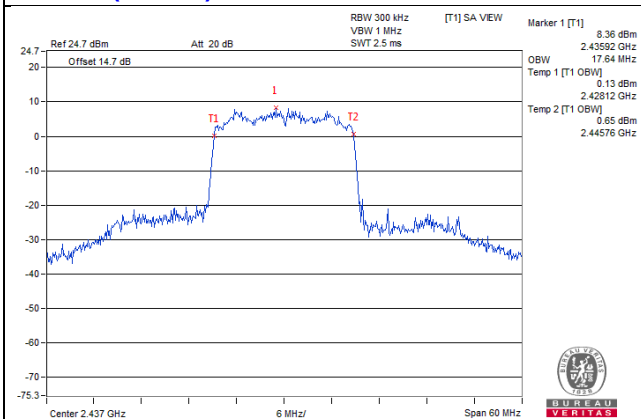

802.11n (20MHz) 2Tx CDD mode Chain2 CH6

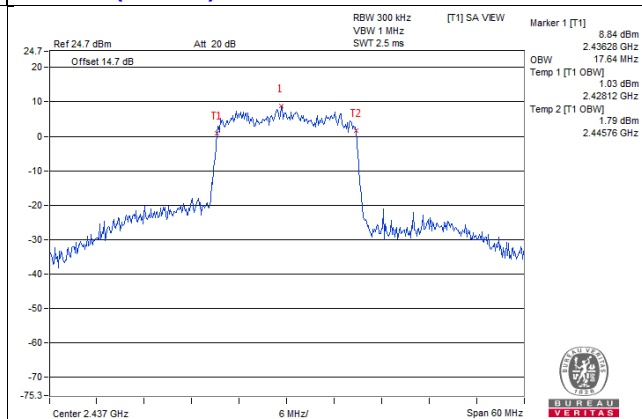

802.11n (20MHz) 2Tx CDD mode Chain1 CH11

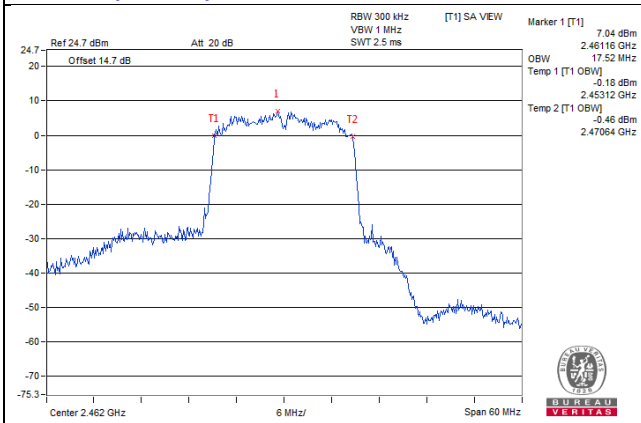

802.11n (20MHz) 2Tx CDD mode Chain2 CH11

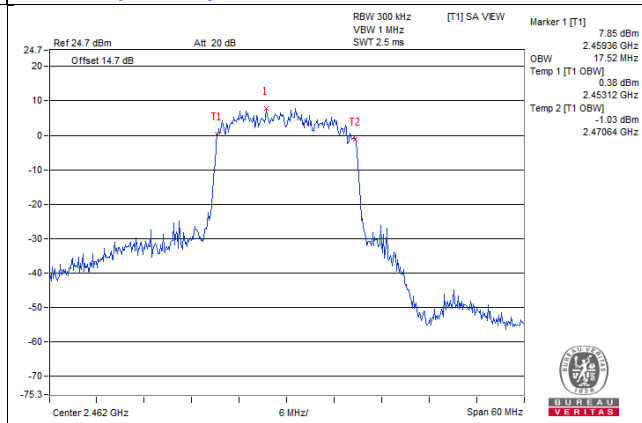

SPECTRUM PLOT

802.11n (40MHz) 2Tx CDD mode Chain1 CH3

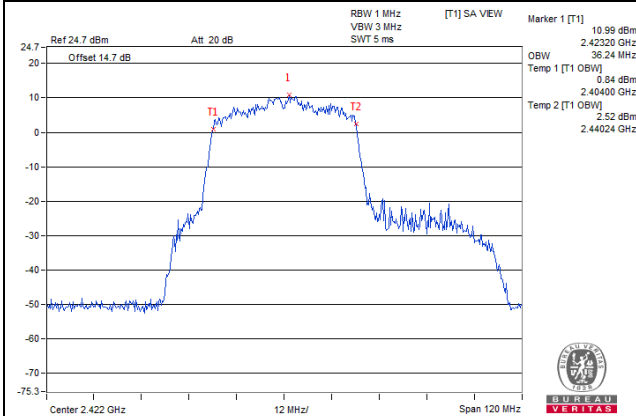

802.11n (40MHz) 2Tx CDD mode Chain2 CH3

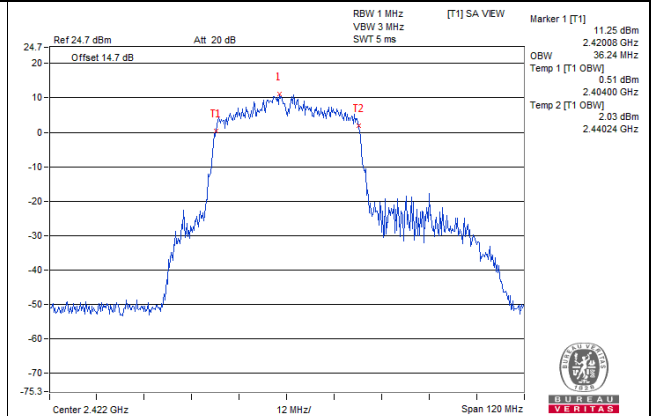

802.11n (40MHz) 2Tx CDD mode Chain1 CH6

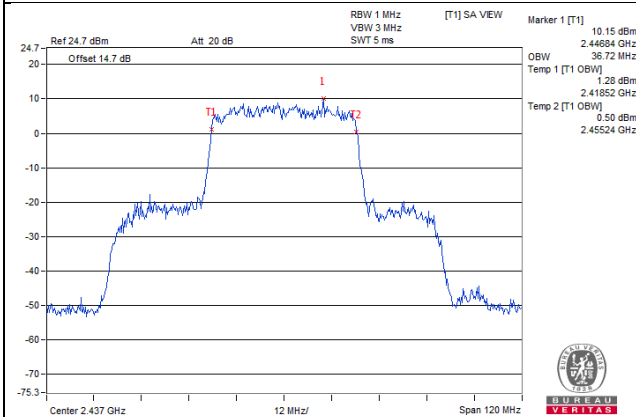

802.11n (40MHz) 2Tx CDD mode Chain2 CH6

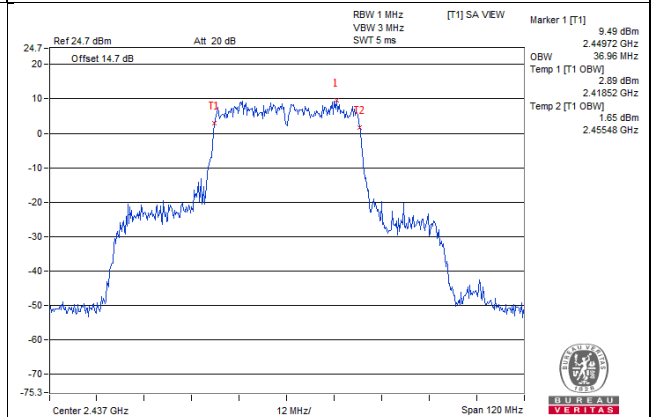

802.11n (40MHz) 2Tx CDD mode Chain1 CH9

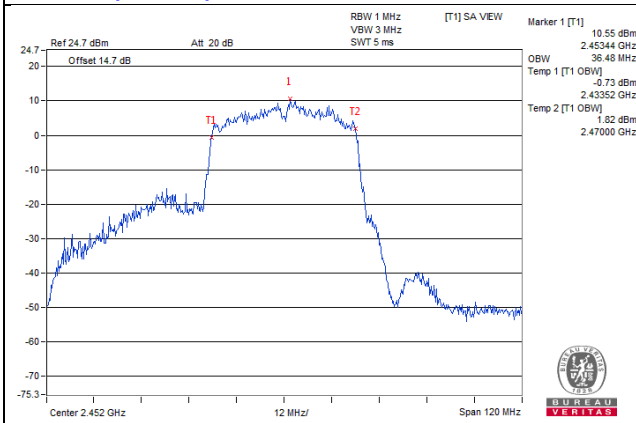

802.11n (40MHz) 2Tx CDD mode Chain2 CH9

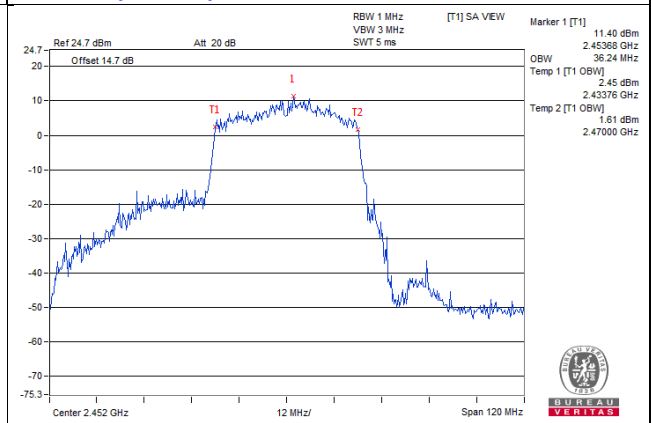

4.6 Radiated Emissions Measurement

4.6.1 Limit

30dBc in any 100 kHz bandwidth outside the operating frequency band. In case the emissions fall within the restricted band specified on 15.205(a), then the 15.209(a) limit in the table below has to be followed.

Frequency Range (MHz)	Field Strength (microvolts/meter)	Measurement Distance (meters)
0.009 ~ 0.490	2400/F(kHz)	300
0.490 ~ 1.705	24000/F(kHz)	30
1.705 ~ 30.0	30	30
30 ~ 88	100	3
88 ~ 216	150	3
216 ~ 960	200	3
Above 960	500	3

4.6.2 Measuring Instruments and Setting

Please refer to section 5 of equipments list in this report. The following table is the setting of spectrum analyzer and receiver.

Spectrum Parameter	Setting
Attenuation	Auto
Start Frequency	1000 MHz
Stop Frequency	10th carrier harmonic
RBW / VBW (Emissions in restricted band)	1MHz / 3MHz for Peak, 1 MHz / 1/T for Average
RBW / VBW (Emissions in non-restricted band)	100kHz / 300kHz for peak

Receiver Parameter	Setting
Attenuation	Auto
Start ~ Stop Frequency	9kHz~150kHz / RBW 200Hz for QP
Start ~ Stop Frequency	150kHz~30MHz / RBW 9kHz for QP
Start ~ Stop Frequency	30MHz~1000MHz / RBW 120kHz for QP

4.6.3 Test Procedure

- 1 Configure the EUT according to ANSI C63.10. The EUT was placed on the top of a rotating table 0.8 meters (for below 1GHz) / 1.5 meters (for above 1GHz) above the ground. The phase center of the receiving antenna mounted on the top of a height-variable antenna tower was placed 3 meters far away from the turntable.
- 2 Power on the EUT and all the supporting units. The turntable was rotated by 360 degrees to determine the position of the highest radiation.
- 3 The height of the broadband receiving antenna was varied between one meter and four meters above ground to find the maximum emissions field strength of both horizontal and vertical polarization.
- 4 For each suspected emissions, the antenna tower was scan (from 1 m to 4 m) and then the turntable was rotated (from 0 degree to 360 degrees) to find the maximum reading.
- 5 Set the test-receiver system to Peak or CISPR quasi-peak Detect Function with specified bandwidth under Maximum Hold Mode
- 6 For emissions above 1GHz, use 1MHz RBW and 3MHz VBW for peak reading. Then 1MHz RBW and 10Hz VBW for average reading in spectrum analyzer for Duty $\geq 98\%$, 1MHz RBW and VBW is $\geq 1/T$ for average reading in spectrum analyzer for Duty $< 98\%$.
- 7 When the radiated emissions limits are expressed in terms of the average value of the emissions, and pulsed operation is employed, the measurement field strength shall be determined by averaging over one complete pulse train, including blanking intervals, as long as the pulse train does not exceed 0.1 seconds. As an alternative (provided the transmitter operates for longer than 0.1 seconds) or where the pulse train exceeds 0.1 seconds, the measured field strength shall be determined from the average absolute voltage during a 0.1 second interval during which the field strength is at its maximum value.
- 8 If the emissions level of the EUT in peak mode was 3 dB lower than the average limit specified, then testing will be stopped and peak values of EUT will be reported, otherwise, the emissions which do not have 3 dB margin will be repeated one by one using the quasi-peak method for below 1GHz.
- 9 For testing above 1GHz, the emissions level of the EUT in peak mode was lower than average limit (that means the emissions level in peak mode also PASS with the limit in average mode), then testing will be stopped and peak values of EUT will be reported, otherwise, the emissions will be measured in average mode again and reported.
- 10 As the emission is lower than 30MHz, loop antenna has to be used for measurement and the recorded data should be QP measured by receiver. High – Low scan is not required in this case.

4.6.4 Test Setup Layout

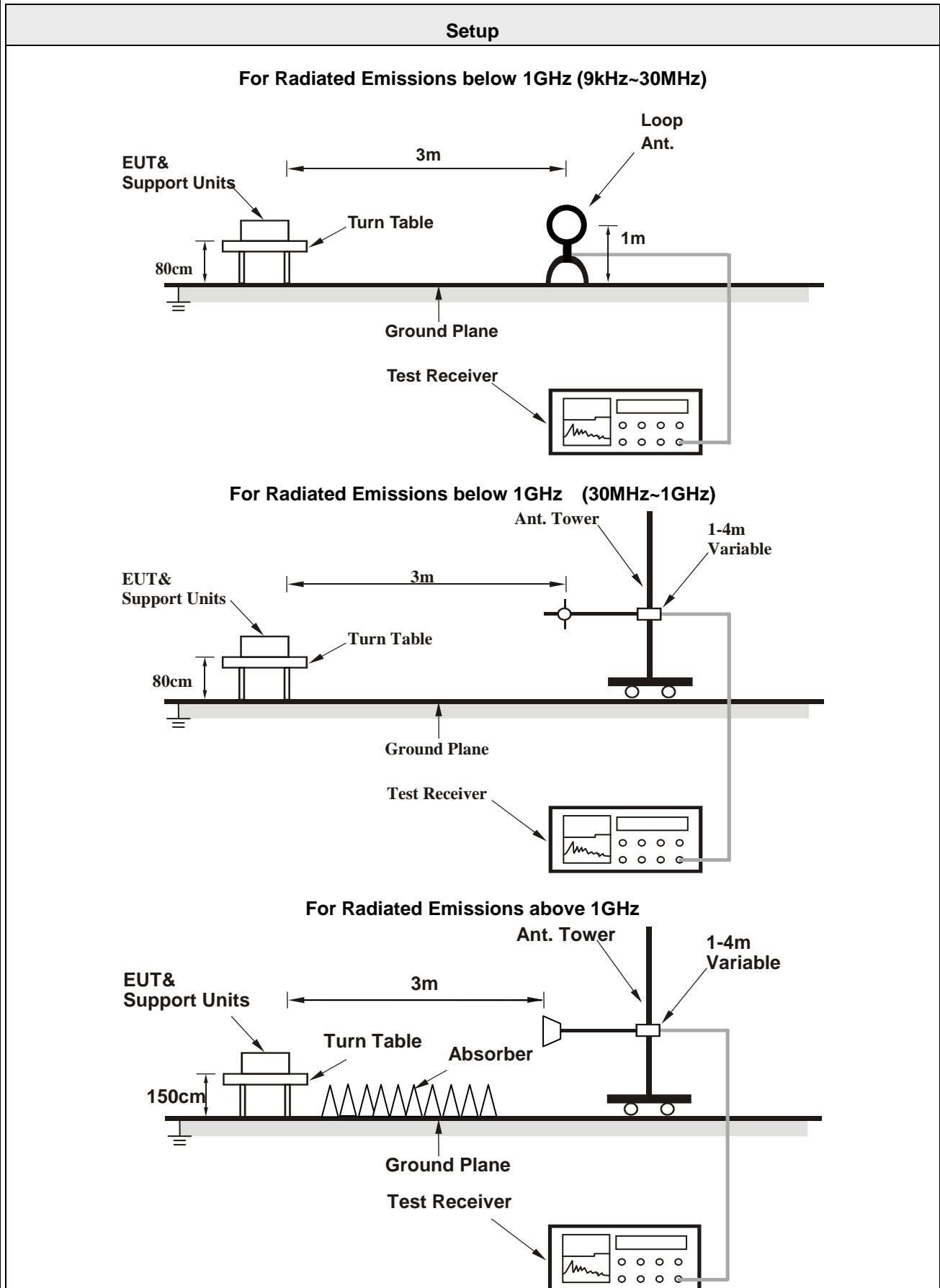

4.6.5 Test Deviation

There are no deviations with the original standard.

4.6.6 EUT Operating Conditions

The EUT was programmed to be in continuously transmitting mode.

4.6.7 Test Results of Radiated Emissions

Temperature	22°C	Humidity	67%
Test Engineer	Frank Chuang		

Radiated Emissions Range 9kHz~30MHz

The amplitude of spurious emissions which are attenuated by more than 20 dB below the permissible value has no need to be reported.

Radiated Emissions Range 30MHz~1GHz

802.11n (20MHz)

CHANNEL	TX Channel 6	DETECTOR FUNCTION	Quasi-Peak (QP)
FREQUENCY RANGE	9kHz ~ 1GHz		

ANTENNA POLARITY & TEST DISTANCE: HORIZONTAL AT 3 M

NO.	FREQ. (MHz)	EMISSION LEVEL (dBuV/m)	LIMIT (dBuV/m)	MARGIN (dB)	ANTENNA HEIGHT (m)	TABLE ANGLE (Degree)	RAW VALUE (dBuV)	CORRECTION FACTOR (dB/m)
1	250.00	42.2 QP	46.0	-3.8	1.00 H	285	51.1	-8.9
2	375.00	39.5 QP	46.0	-6.5	1.00 H	50	44.5	-5.0
3	499.99	35.7 QP	46.0	-10.3	2.00 H	30	37.7	-2.0
4	625.01	42.9 QP	46.0	-3.1	1.50 H	39	42.0	0.9
5	874.99	40.2 QP	46.0	-5.8	2.00 H	360	35.7	4.5
6	1000.00	41.7 QP	54.0	-12.3	2.00 H	360	35.7	6.0

REMARKS:

1. Emission Level(dBuV/m) = Raw Value(dBuV) + Correction Factor(dB/m)
2. Correction Factor(dB/m) = Antenna Factor(dB/m) + Cable Factor(dB) – Pre-Amplifier Factor(dB)
3. The other emission levels were very low against the limit.
4. Margin value = Emission Level – Limit value

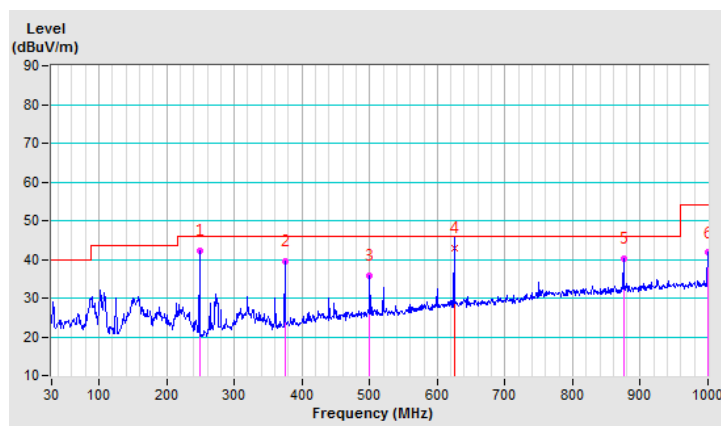

CHANNEL	TX Channel 6	DETECTOR FUNCTION	Quasi-Peak (QP)
FREQUENCY RANGE	9kHz ~ 1GHz		

ANTENNA POLARITY & TEST DISTANCE: VERTICAL AT 3 M

NO.	FREQ. (MHz)	EMISSION LEVEL (dBuV/m)	LIMIT (dBuV/m)	MARGIN (dB)	ANTENNA HEIGHT (m)	TABLE ANGLE (Degree)	RAW VALUE (dBuV)	CORRECTION FACTOR (dB/m)
1	42.96	34.4 QP	40.0	-5.6	1.50 V	360	42.5	-8.1
2	68.65	34.3 QP	40.0	-5.7	1.00 V	181	44.1	-9.8
3	250.00	40.6 QP	46.0	-5.4	2.00 V	39	49.5	-8.9
4	375.00	37.7 QP	46.0	-8.3	1.00 V	0	42.7	-5.0
5	625.00	42.4 QP	46.0	-3.6	1.00 V	64	41.5	0.9
6	874.99	37.3 QP	46.0	-8.7	1.50 V	360	32.8	4.5

REMARKS:

1. Emission Level(dBuV/m) = Raw Value(dBuV) + Correction Factor(dB/m)
2. Correction Factor(dB/m) = Antenna Factor(dB/m) + Cable Factor(dB) – Pre-Amplifier Factor(dB)
3. The other emission levels were very low against the limit.
4. Margin value = Emission Level – Limit value

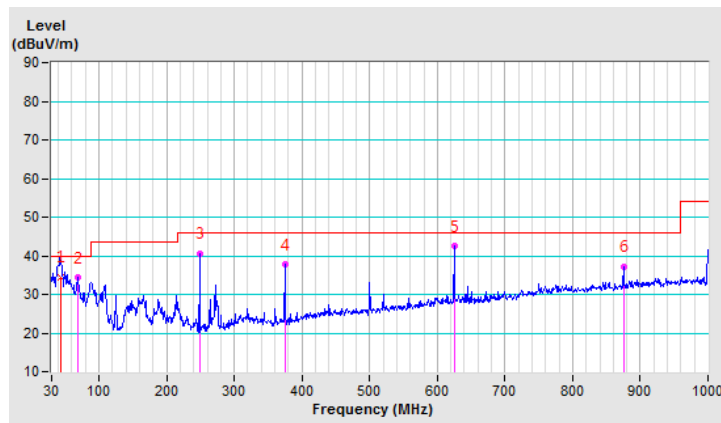

802.11n (40MHz)

CHANNEL	TX Channel 6	DETECTOR FUNCTION	Quasi-Peak (QP)
FREQUENCY RANGE	9kHz ~ 1GHz		

ANTENNA POLARITY & TEST DISTANCE: HORIZONTAL AT 3 M								
NO.	FREQ. (MHz)	EMISSION LEVEL (dBuV/m)	LIMIT (dBuV/m)	MARGIN (dB)	ANTENNA HEIGHT (m)	TABLE ANGLE (Degree)	RAW VALUE (dBuV)	CORRECTION FACTOR (dB/m)
1	250.00	42.3 QP	46.0	-3.7	1.00 H	280	51.2	-8.9
2	375.00	39.4 QP	46.0	-6.6	1.00 H	44	44.4	-5.0
3	499.99	35.1 QP	46.0	-10.9	2.00 H	42	37.1	-2.0
4	624.99	43.0 QP	46.0	-3.0	1.50 H	360	42.1	0.9
5	874.99	39.4 QP	46.0	-6.6	1.50 H	360	34.9	4.5
6	1000.00	43.0 QP	54.0	-11.0	1.50 H	28	37.0	6.0

REMARKS:

1. Emission Level(dBuV/m) = Raw Value(dBuV) + Correction Factor(dB/m)
2. Correction Factor(dB/m) = Antenna Factor(dB/m) + Cable Factor(dB) – Pre-Amplifier Factor(dB)
3. The other emission levels were very low against the limit.
4. Margin value = Emission Level – Limit value

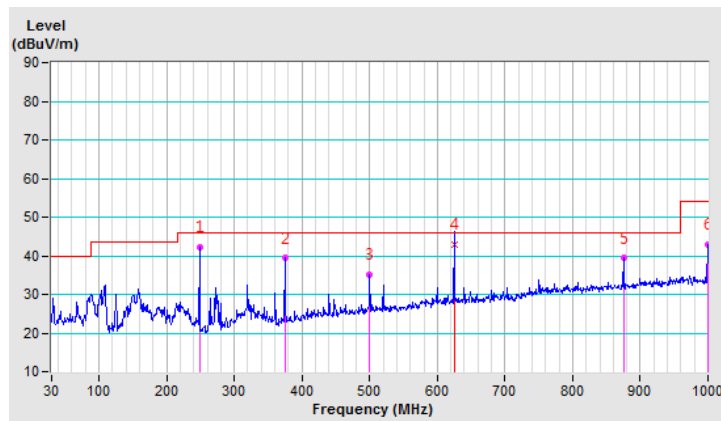

CHANNEL	TX Channel 6	DETECTOR FUNCTION	Quasi-Peak (QP)
FREQUENCY RANGE	9kHz ~ 1GHz		

ANTENNA POLARITY & TEST DISTANCE: VERTICAL AT 3 M

NO.	FREQ. (MHz)	EMISSION LEVEL (dBuV/m)	LIMIT (dBuV/m)	MARGIN (dB)	ANTENNA HEIGHT (m)	TABLE ANGLE (Degree)	RAW VALUE (dBuV)	CORRECTION FACTOR (dB/m)
1	42.91	34.3 QP	40.0	-5.7	1.50 V	0	42.4	-8.1
2	108.01	33.8 QP	43.5	-9.7	1.50 V	0	44.7	-10.9
3	250.00	40.5 QP	46.0	-5.5	2.00 V	37	49.4	-8.9
4	375.00	37.6 QP	46.0	-8.4	1.50 V	0	42.6	-5.0
5	625.00	43.0 QP	46.0	-3.0	1.00 V	68	42.1	0.9
6	874.99	37.5 QP	46.0	-8.5	1.50 V	0	33.0	4.5

REMARKS:

1. Emission Level(dBuV/m) = Raw Value(dBuV) + Correction Factor(dB/m)
2. Correction Factor(dB/m) = Antenna Factor(dB/m) + Cable Factor(dB) – Pre-Amplifier Factor(dB)
3. The other emission levels were very low against the limit.
4. Margin value = Emission Level – Limit value

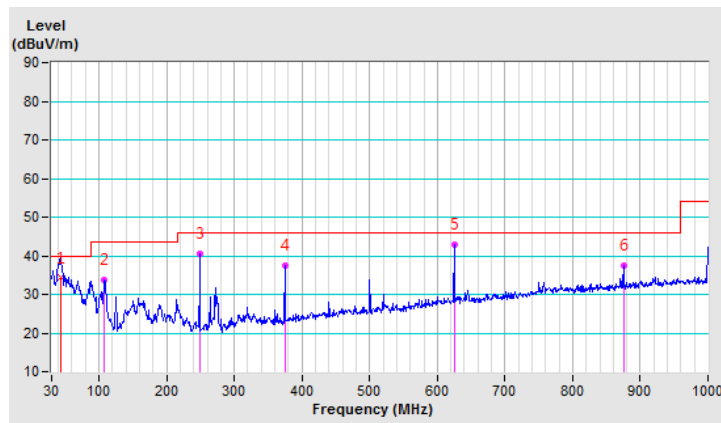

Radiated Emission Range 1GHz~10th Harmonic

1TX

802.11b

CHANNEL	TX Channel 1	DETECTOR FUNCTION	Peak (PK)
FREQUENCY RANGE	1GHz ~ 25GHz		Average (AV)

ANTENNA POLARITY & TEST DISTANCE: HORIZONTAL AT 3 M

NO.	FREQ. (MHz)	EMISSION LEVEL (dBuV/m)	LIMIT (dBuV/m)	MARGIN (dB)	ANTENNA HEIGHT (m)	TABLE ANGLE (Degree)	RAW VALUE (dBuV)	CORRECTION FACTOR (dB/m)
1	4824.00	43.8 PK	74.0	-30.2	1.23 H	49	41.7	2.1
2	4824.00	40.3 AV	54.0	-13.7	1.23 H	49	38.2	2.1

REMARKS:

1. Emission Level(dBuV/m) = Raw Value(dBuV) + Correction Factor(dB/m)
2. Correction Factor(dB/m) = Antenna Factor(dB/m) + Cable Factor(dB) – Pre-Amplifier Factor(dB)
3. The other emission levels were very low against the limit.
4. Margin value = Emission Level – Limit value

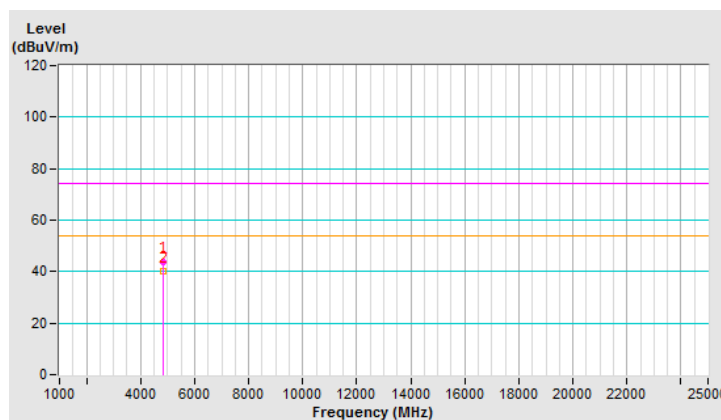

CHANNEL	TX Channel 1	DETECTOR FUNCTION	Peak (PK)
FREQUENCY RANGE	1GHz ~ 25GHz		Average (AV)

ANTENNA POLARITY & TEST DISTANCE: VERTICAL AT 3 M

NO.	FREQ. (MHz)	EMISSION LEVEL (dBuV/m)	LIMIT (dBuV/m)	MARGIN (dB)	ANTENNA HEIGHT (m)	TABLE ANGLE (Degree)	RAW VALUE (dBuV)	CORRECTION FACTOR (dB/m)
1	4824.00	40.2 PK	74.0	-33.8	1.39 V	9	38.1	2.1
2	4824.00	35.1 AV	54.0	-18.9	1.39 V	9	33.0	2.1

REMARKS:

1. Emission Level(dBuV/m) = Raw Value(dBuV) + Correction Factor(dB/m)
2. Correction Factor(dB/m) = Antenna Factor(dB/m) + Cable Factor(dB) – Pre-Amplifier Factor(dB)
3. The other emission levels were very low against the limit.
4. Margin value = Emission Level – Limit value

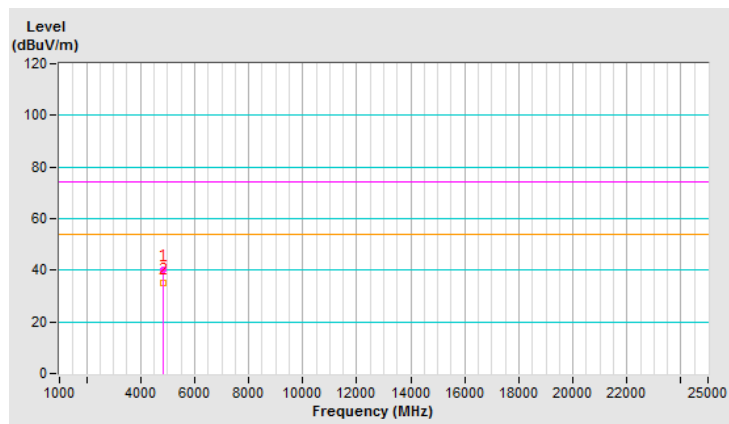

CHANNEL	TX Channel 6	DETECTOR FUNCTION	Peak (PK)
FREQUENCY RANGE	1GHz ~ 25GHz		Average (AV)

ANTENNA POLARITY & TEST DISTANCE: HORIZONTAL AT 3 M

NO.	FREQ. (MHz)	EMISSION LEVEL (dBuV/m)	LIMIT (dBuV/m)	MARGIN (dB)	ANTENNA HEIGHT (m)	TABLE ANGLE (Degree)	RAW VALUE (dBuV)	CORRECTION FACTOR (dB/m)
1	4874.00	43.8 PK	74.0	-30.2	1.24 H	65	41.7	2.1
2	4874.00	40.3 AV	54.0	-13.7	1.24 H	65	38.2	2.1
3	7311.00	45.2 PK	74.0	-28.8	1.68 H	59	37.0	8.2
4	7311.00	33.8 AV	54.0	-20.2	1.68 H	59	25.6	8.2

REMARKS:

1. Emission Level(dBuV/m) = Raw Value(dBuV) + Correction Factor(dB/m)
2. Correction Factor(dB/m) = Antenna Factor(dB/m) + Cable Factor(dB) – Pre-Amplifier Factor(dB)
3. The other emission levels were very low against the limit.
4. Margin value = Emission Level – Limit value

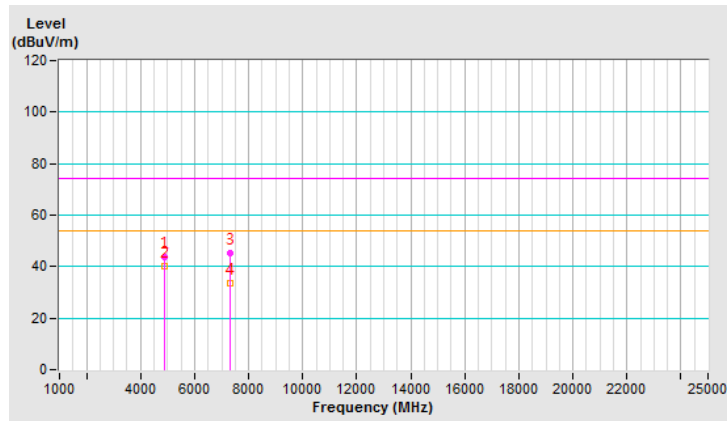

CHANNEL	TX Channel 6	DETECTOR FUNCTION	Peak (PK)
FREQUENCY RANGE	1GHz ~ 25GHz		Average (AV)

ANTENNA POLARITY & TEST DISTANCE: VERTICAL AT 3 M

NO.	FREQ. (MHz)	EMISSION LEVEL (dBuV/m)	LIMIT (dBuV/m)	MARGIN (dB)	ANTENNA HEIGHT (m)	TABLE ANGLE (Degree)	RAW VALUE (dBuV)	CORRECTION FACTOR (dB/m)
1	4874.00	40.5 PK	74.0	-33.5	1.29 V	13	38.4	2.1
2	4874.00	35.0 AV	54.0	-19.0	1.29 V	13	32.9	2.1
3	7311.00	42.6 PK	74.0	-31.4	3.07 V	2	34.4	8.2
4	7311.00	31.9 AV	54.0	-22.1	3.07 V	2	23.7	8.2

REMARKS:

1. Emission Level(dBuV/m) = Raw Value(dBuV) + Correction Factor(dB/m)
2. Correction Factor(dB/m) = Antenna Factor(dB/m) + Cable Factor(dB) – Pre-Amplifier Factor(dB)
3. The other emission levels were very low against the limit.
4. Margin value = Emission Level – Limit value

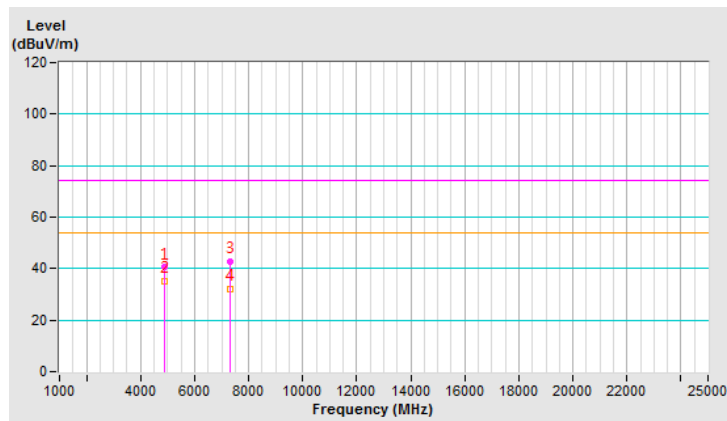

CHANNEL	TX Channel 11	DETECTOR FUNCTION	Peak (PK)
FREQUENCY RANGE	1GHz ~ 25GHz		Average (AV)

ANTENNA POLARITY & TEST DISTANCE: HORIZONTAL AT 3 M

NO.	FREQ. (MHz)	EMISSION LEVEL (dBuV/m)	LIMIT (dBuV/m)	MARGIN (dB)	ANTENNA HEIGHT (m)	TABLE ANGLE (Degree)	RAW VALUE (dBuV)	CORRECTION FACTOR (dB/m)
1	4924.00	42.3 PK	74.0	-31.7	1.23 H	52	40.1	2.2
2	4924.00	38.6 AV	54.0	-15.4	1.23 H	52	36.4	2.2
3	7386.00	44.1 PK	74.0	-29.9	1.68 H	75	35.8	8.3
4	7386.00	32.2 AV	54.0	-21.8	1.68 H	75	23.9	8.3

REMARKS:

1. Emission Level(dBuV/m) = Raw Value(dBuV) + Correction Factor(dB/m)
2. Correction Factor(dB/m) = Antenna Factor(dB/m) + Cable Factor(dB) – Pre-Amplifier Factor(dB)
3. The other emission levels were very low against the limit.
4. Margin value = Emission Level – Limit value

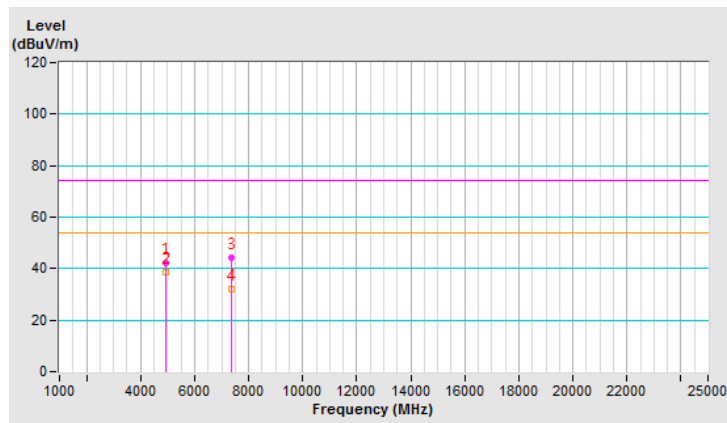

CHANNEL	TX Channel 11	DETECTOR FUNCTION	Peak (PK)
FREQUENCY RANGE	1GHz ~ 25GHz		Average (AV)

ANTENNA POLARITY & TEST DISTANCE: VERTICAL AT 3 M

NO.	FREQ. (MHz)	EMISSION LEVEL (dBuV/m)	LIMIT (dBuV/m)	MARGIN (dB)	ANTENNA HEIGHT (m)	TABLE ANGLE (Degree)	RAW VALUE (dBuV)	CORRECTION FACTOR (dB/m)
1	4924.00	39.6 PK	74.0	-34.4	1.05 V	4	37.4	2.2
2	4924.00	32.1 AV	54.0	-21.9	1.05 V	4	29.9	2.2
3	7386.00	42.5 PK	74.0	-31.5	1.86 V	2	34.2	8.3
4	7386.00	31.7 AV	54.0	-22.3	1.86 V	2	23.4	8.3

REMARKS:

1. Emission Level(dBuV/m) = Raw Value(dBuV) + Correction Factor(dB/m)
2. Correction Factor(dB/m) = Antenna Factor(dB/m) + Cable Factor(dB) – Pre-Amplifier Factor(dB)
3. The other emission levels were very low against the limit.
4. Margin value = Emission Level – Limit value

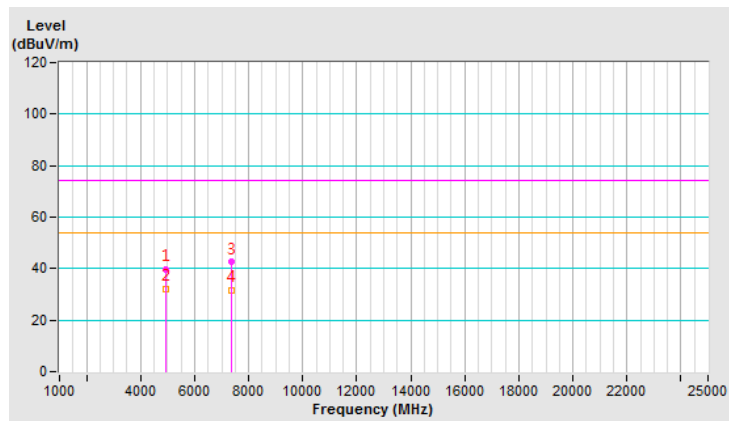

802.11g

CHANNEL	TX Channel 1	DETECTOR FUNCTION	Peak (PK)
FREQUENCY RANGE	1GHz ~ 25GHz		Average (AV)

ANTENNA POLARITY & TEST DISTANCE: HORIZONTAL AT 3 M								
NO.	FREQ. (MHz)	EMISSION LEVEL (dBuV/m)	LIMIT (dBuV/m)	MARGIN (dB)	ANTENNA HEIGHT (m)	TABLE ANGLE (Degree)	RAW VALUE (dBuV)	CORRECTION FACTOR (dB/m)
1	4824.00	41.9 PK	74.0	-32.1	3.79 H	312	39.8	2.1
2	4824.00	30.2 AV	54.0	-23.8	3.79 H	312	28.1	2.1

REMARKS:

1. Emission Level(dBuV/m) = Raw Value(dBuV) + Correction Factor(dB/m)
2. Correction Factor(dB/m) = Antenna Factor(dB/m) + Cable Factor(dB) – Pre-Amplifier Factor(dB)
3. The other emission levels were very low against the limit.
4. Margin value = Emission Level – Limit value

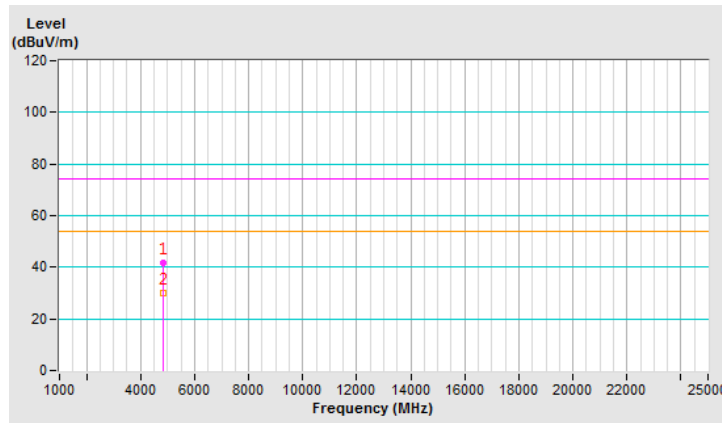

CHANNEL	TX Channel 1	DETECTOR FUNCTION	Peak (PK)
FREQUENCY RANGE	1GHz ~ 25GHz		Average (AV)

ANTENNA POLARITY & TEST DISTANCE: VERTICAL AT 3 M

NO.	FREQ. (MHz)	EMISSION LEVEL (dBuV/m)	LIMIT (dBuV/m)	MARGIN (dB)	ANTENNA HEIGHT (m)	TABLE ANGLE (Degree)	RAW VALUE (dBuV)	CORRECTION FACTOR (dB/m)
1	4824.00	40.1 PK	74.0	-33.9	3.89 V	194	38.0	2.1
2	4824.00	28.2 AV	54.0	-25.8	3.89 V	194	26.1	2.1

REMARKS:

1. Emission Level(dBuV/m) = Raw Value(dBuV) + Correction Factor(dB/m)
2. Correction Factor(dB/m) = Antenna Factor(dB/m) + Cable Factor(dB) – Pre-Amplifier Factor(dB)
3. The other emission levels were very low against the limit.
4. Margin value = Emission Level – Limit value

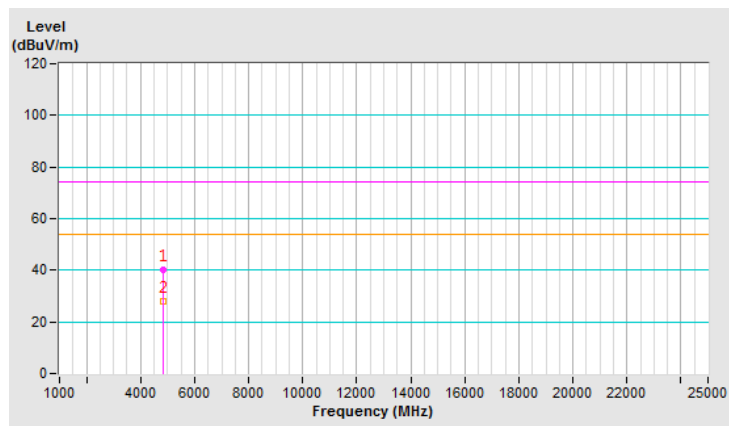

CHANNEL	TX Channel 6	DETECTOR FUNCTION	Peak (PK)
FREQUENCY RANGE	1GHz ~ 25GHz		Average (AV)

ANTENNA POLARITY & TEST DISTANCE: HORIZONTAL AT 3 M

NO.	FREQ. (MHz)	EMISSION LEVEL (dBuV/m)	LIMIT (dBuV/m)	MARGIN (dB)	ANTENNA HEIGHT (m)	TABLE ANGLE (Degree)	RAW VALUE (dBuV)	CORRECTION FACTOR (dB/m)
1	4874.00	41.6 PK	74.0	-32.4	3.83 H	326	39.5	2.1
2	4874.00	29.7 AV	54.0	-24.3	3.83 H	326	27.6	2.1
3	7311.00	42.8 PK	74.0	-31.2	2.65 H	312	34.6	8.2
4	7311.00	31.4 AV	54.0	-22.6	2.65 H	312	23.2	8.2

REMARKS:

1. Emission Level(dBuV/m) = Raw Value(dBuV) + Correction Factor(dB/m)
2. Correction Factor(dB/m) = Antenna Factor(dB/m) + Cable Factor(dB) – Pre-Amplifier Factor(dB)
3. The other emission levels were very low against the limit.
4. Margin value = Emission Level – Limit value

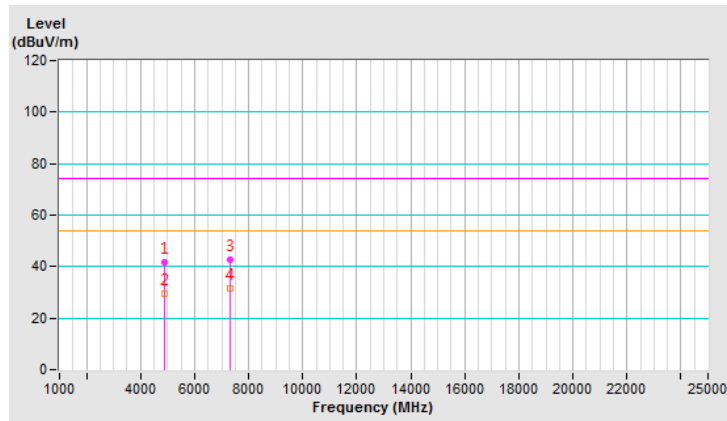

CHANNEL	TX Channel 6	DETECTOR FUNCTION	Peak (PK)
FREQUENCY RANGE	1GHz ~ 25GHz		Average (AV)

ANTENNA POLARITY & TEST DISTANCE: VERTICAL AT 3 M

NO.	FREQ. (MHz)	EMISSION LEVEL (dBuV/m)	LIMIT (dBuV/m)	MARGIN (dB)	ANTENNA HEIGHT (m)	TABLE ANGLE (Degree)	RAW VALUE (dBuV)	CORRECTION FACTOR (dB/m)
1	4874.00	39.8 PK	74.0	-34.2	1.14 V	15	37.7	2.1
2	4874.00	27.5 AV	54.0	-26.5	1.14 V	15	25.4	2.1
3	7311.00	42.3 PK	74.0	-31.7	1.57 V	92	34.1	8.2
4	7311.00	30.9 AV	54.0	-23.1	1.57 V	92	22.7	8.2

REMARKS:

1. Emission Level(dBuV/m) = Raw Value(dBuV) + Correction Factor(dB/m)
2. Correction Factor(dB/m) = Antenna Factor(dB/m) + Cable Factor(dB) – Pre-Amplifier Factor(dB)
3. The other emission levels were very low against the limit.
4. Margin value = Emission Level – Limit value

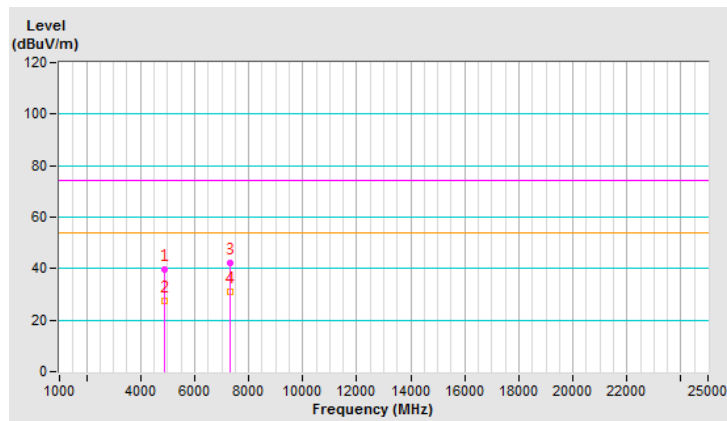

CHANNEL	TX Channel 11	DETECTOR FUNCTION	Peak (PK)
FREQUENCY RANGE	1GHz ~ 25GHz		Average (AV)

ANTENNA POLARITY & TEST DISTANCE: HORIZONTAL AT 3 M

NO.	FREQ. (MHz)	EMISSION LEVEL (dBuV/m)	LIMIT (dBuV/m)	MARGIN (dB)	ANTENNA HEIGHT (m)	TABLE ANGLE (Degree)	RAW VALUE (dBuV)	CORRECTION FACTOR (dB/m)
1	4924.00	42.0 PK	74.0	-32.0	3.87 H	339	39.8	2.2
2	4924.00	30.0 AV	54.0	-24.0	3.87 H	339	27.8	2.2
3	7386.00	42.5 PK	74.0	-31.5	2.62 H	321	34.2	8.3
4	7386.00	31.8 AV	54.0	-22.2	2.62 H	321	23.5	8.3

REMARKS:

1. Emission Level(dBuV/m) = Raw Value(dBuV) + Correction Factor(dB/m)
2. Correction Factor(dB/m) = Antenna Factor(dB/m) + Cable Factor(dB) – Pre-Amplifier Factor(dB)
3. The other emission levels were very low against the limit.
4. Margin value = Emission Level – Limit value

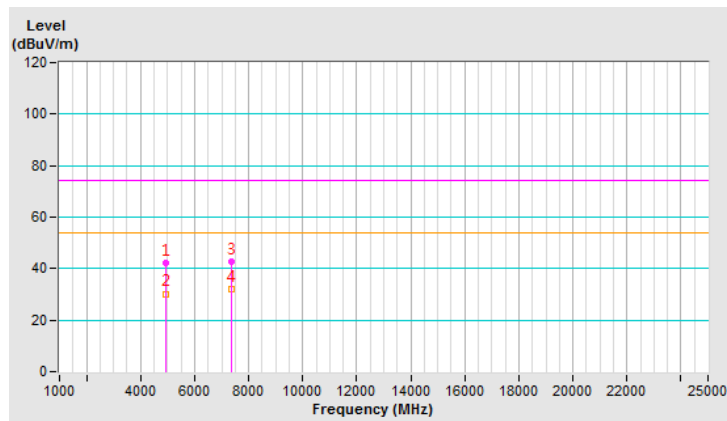

CHANNEL	TX Channel 11	DETECTOR FUNCTION	Peak (PK)
FREQUENCY RANGE	1GHz ~ 25GHz		Average (AV)

ANTENNA POLARITY & TEST DISTANCE: VERTICAL AT 3 M								
NO.	FREQ. (MHz)	EMISSION LEVEL (dBuV/m)	LIMIT (dBuV/m)	MARGIN (dB)	ANTENNA HEIGHT (m)	TABLE ANGLE (Degree)	RAW VALUE (dBuV)	CORRECTION FACTOR (dB/m)
1	4924.00	40.9 PK	74.0	-33.1	3.70 V	311	38.7	2.2
2	4924.00	28.1 AV	54.0	-25.9	3.70 V	311	25.9	2.2
3	7386.00	42.6 PK	74.0	-31.4	1.69 V	88	34.3	8.3
4	7386.00	31.2 AV	54.0	-22.8	1.69 V	88	22.9	8.3

REMARKS:

1. Emission Level(dBuV/m) = Raw Value(dBuV) + Correction Factor(dB/m)
2. Correction Factor(dB/m) = Antenna Factor(dB/m) + Cable Factor(dB) – Pre-Amplifier Factor(dB)
3. The other emission levels were very low against the limit.
4. Margin value = Emission Level – Limit value

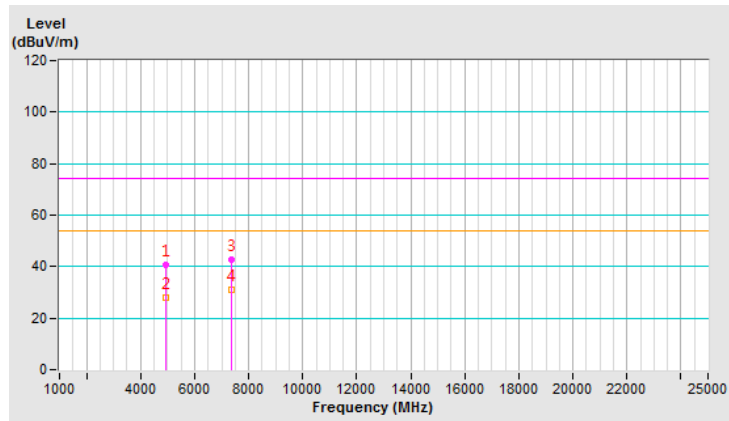

802.11n (20MHz)

CHANNEL	TX Channel 1	DETECTOR FUNCTION	Peak (PK)
FREQUENCY RANGE	1GHz ~ 25GHz		Average (AV)

ANTENNA POLARITY & TEST DISTANCE: HORIZONTAL AT 3 M

NO.	FREQ. (MHz)	EMISSION LEVEL (dBuV/m)	LIMIT (dBuV/m)	MARGIN (dB)	ANTENNA HEIGHT (m)	TABLE ANGLE (Degree)	RAW VALUE (dBuV)	CORRECTION FACTOR (dB/m)
1	4824.00	48.1 PK	74.0	-25.9	2.32 H	24	46.0	2.1
2	4824.00	36.1 AV	54.0	-17.9	2.32 H	24	34.0	2.1

REMARKS:

1. Emission Level(dBuV/m) = Raw Value(dBuV) + Correction Factor(dB/m)
2. Correction Factor(dB/m) = Antenna Factor(dB/m) + Cable Factor(dB) – Pre-Amplifier Factor(dB)
3. The other emission levels were very low against the limit.
4. Margin value = Emission Level – Limit value

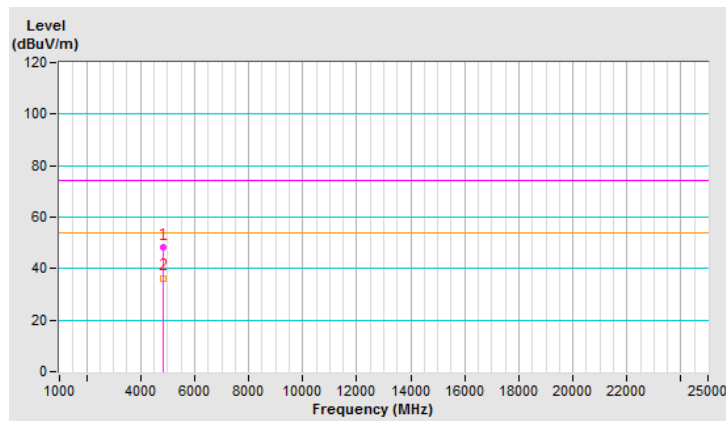

CHANNEL	TX Channel 1	DETECTOR FUNCTION	Peak (PK)
FREQUENCY RANGE	1GHz ~ 25GHz		Average (AV)

ANTENNA POLARITY & TEST DISTANCE: VERTICAL AT 3 M

NO.	FREQ. (MHz)	EMISSION LEVEL (dBuV/m)	LIMIT (dBuV/m)	MARGIN (dB)	ANTENNA HEIGHT (m)	TABLE ANGLE (Degree)	RAW VALUE (dBuV)	CORRECTION FACTOR (dB/m)
1	4824.00	44.8 PK	74.0	-29.2	2.60 V	343	42.7	2.1
2	4824.00	31.2 AV	54.0	-22.8	2.60 V	343	29.1	2.1

REMARKS:

1. Emission Level(dBuV/m) = Raw Value(dBuV) + Correction Factor(dB/m)
2. Correction Factor(dB/m) = Antenna Factor(dB/m) + Cable Factor(dB) – Pre-Amplifier Factor(dB)
3. The other emission levels were very low against the limit.
4. Margin value = Emission Level – Limit value

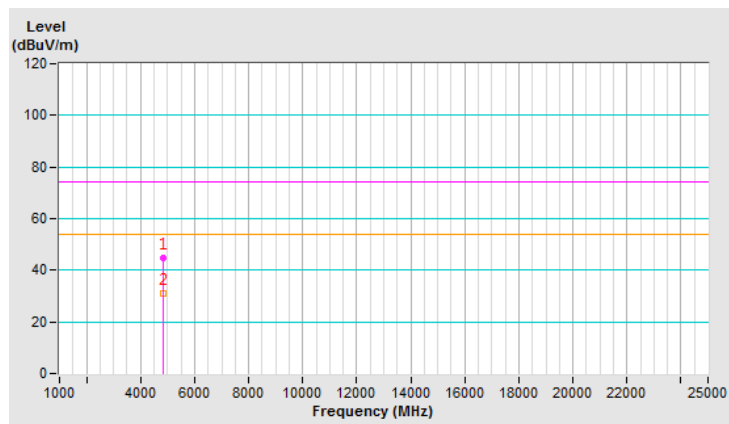

CHANNEL	TX Channel 6	DETECTOR FUNCTION	Peak (PK)
FREQUENCY RANGE	1GHz ~ 25GHz		Average (AV)

ANTENNA POLARITY & TEST DISTANCE: HORIZONTAL AT 3 M

NO.	FREQ. (MHz)	EMISSION LEVEL (dBuV/m)	LIMIT (dBuV/m)	MARGIN (dB)	ANTENNA HEIGHT (m)	TABLE ANGLE (Degree)	RAW VALUE (dBuV)	CORRECTION FACTOR (dB/m)
1	4874.00	48.0 PK	74.0	-26.0	2.26 H	36	45.9	2.1
2	4874.00	36.2 AV	54.0	-17.8	2.26 H	36	34.1	2.1
3	7311.00	42.9 PK	74.0	-31.1	1.20 H	316	34.7	8.2
4	7311.00	30.9 AV	54.0	-23.1	1.20 H	316	22.7	8.2

REMARKS:

1. Emission Level(dBuV/m) = Raw Value(dBuV) + Correction Factor(dB/m)
2. Correction Factor(dB/m) = Antenna Factor(dB/m) + Cable Factor(dB) – Pre-Amplifier Factor(dB)
3. The other emission levels were very low against the limit.
4. Margin value = Emission Level – Limit value

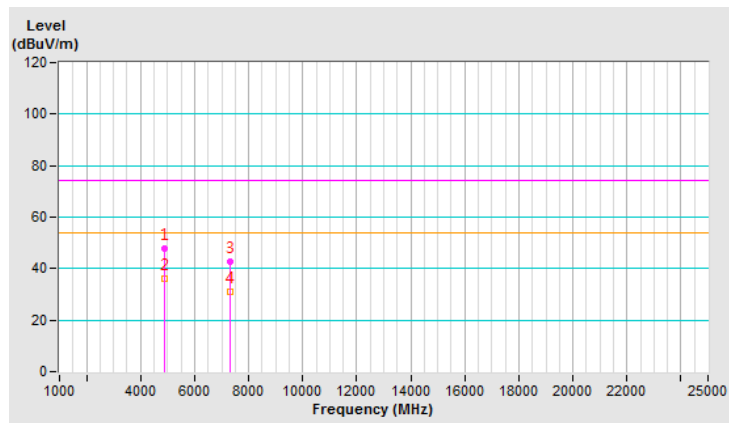

CHANNEL	TX Channel 6	DETECTOR FUNCTION	Peak (PK)
FREQUENCY RANGE	1GHz ~ 25GHz		Average (AV)

ANTENNA POLARITY & TEST DISTANCE: VERTICAL AT 3 M

NO.	FREQ. (MHz)	EMISSION LEVEL (dBuV/m)	LIMIT (dBuV/m)	MARGIN (dB)	ANTENNA HEIGHT (m)	TABLE ANGLE (Degree)	RAW VALUE (dBuV)	CORRECTION FACTOR (dB/m)
1	4874.00	43.3 PK	74.0	-30.7	1.15 V	355	41.2	2.1
2	4874.00	30.7 AV	54.0	-23.3	1.15 V	355	28.6	2.1
3	7311.00	42.8 PK	74.0	-31.2	1.30 V	243	34.6	8.2
4	7311.00	30.8 AV	54.0	-23.2	1.30 V	243	22.6	8.2

REMARKS:

1. Emission Level(dBuV/m) = Raw Value(dBuV) + Correction Factor(dB/m)
2. Correction Factor(dB/m) = Antenna Factor(dB/m) + Cable Factor(dB) – Pre-Amplifier Factor(dB)
3. The other emission levels were very low against the limit.
4. Margin value = Emission Level – Limit value

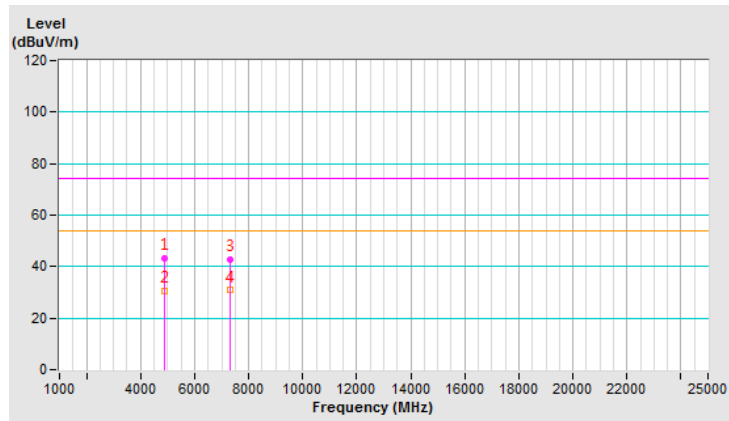

CHANNEL	TX Channel 11	DETECTOR FUNCTION	Peak (PK)
FREQUENCY RANGE	1GHz ~ 25GHz		Average (AV)

ANTENNA POLARITY & TEST DISTANCE: HORIZONTAL AT 3 M

NO.	FREQ. (MHz)	EMISSION LEVEL (dBuV/m)	LIMIT (dBuV/m)	MARGIN (dB)	ANTENNA HEIGHT (m)	TABLE ANGLE (Degree)	RAW VALUE (dBuV)	CORRECTION FACTOR (dB/m)
1	4924.00	46.5 PK	74.0	-27.5	2.28 H	29	44.3	2.2
2	4924.00	34.6 AV	54.0	-19.4	2.28 H	29	32.4	2.2
3	7386.00	43.3 PK	74.0	-30.7	1.26 H	332	35.0	8.3
4	7386.00	31.1 AV	54.0	-22.9	1.26 H	332	22.8	8.3

REMARKS:

1. Emission Level(dBuV/m) = Raw Value(dBuV) + Correction Factor(dB/m)
2. Correction Factor(dB/m) = Antenna Factor(dB/m) + Cable Factor(dB) – Pre-Amplifier Factor(dB)
3. The other emission levels were very low against the limit.
4. Margin value = Emission Level – Limit value

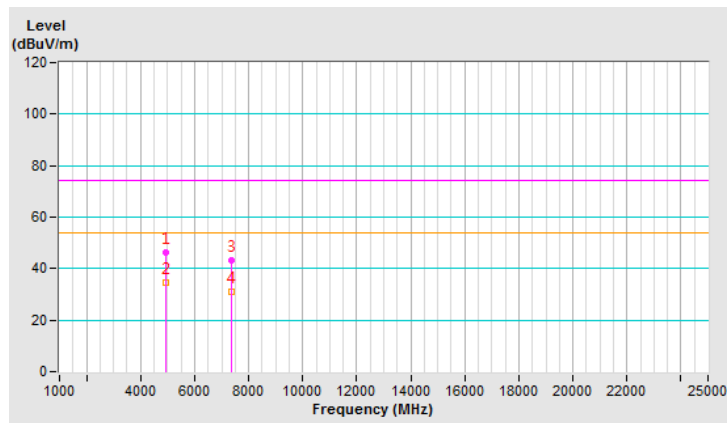

CHANNEL	TX Channel 11	DETECTOR FUNCTION	Peak (PK)
FREQUENCY RANGE	1GHz ~ 25GHz		Average (AV)

ANTENNA POLARITY & TEST DISTANCE: VERTICAL AT 3 M

NO.	FREQ. (MHz)	EMISSION LEVEL (dBuV/m)	LIMIT (dBuV/m)	MARGIN (dB)	ANTENNA HEIGHT (m)	TABLE ANGLE (Degree)	RAW VALUE (dBuV)	CORRECTION FACTOR (dB/m)
1	4924.00	40.6 PK	74.0	-33.4	1.31 V	201	38.4	2.2
2	4924.00	28.7 AV	54.0	-25.3	1.31 V	201	26.5	2.2
3	7386.00	44.9 PK	74.0	-29.1	1.35 V	226	36.6	8.3
4	7386.00	31.2 AV	54.0	-22.8	1.35 V	226	22.9	8.3

REMARKS:

1. Emission Level(dBuV/m) = Raw Value(dBuV) + Correction Factor(dB/m)
2. Correction Factor(dB/m) = Antenna Factor(dB/m) + Cable Factor(dB) – Pre-Amplifier Factor(dB)
3. The other emission levels were very low against the limit.
4. Margin value = Emission Level – Limit value

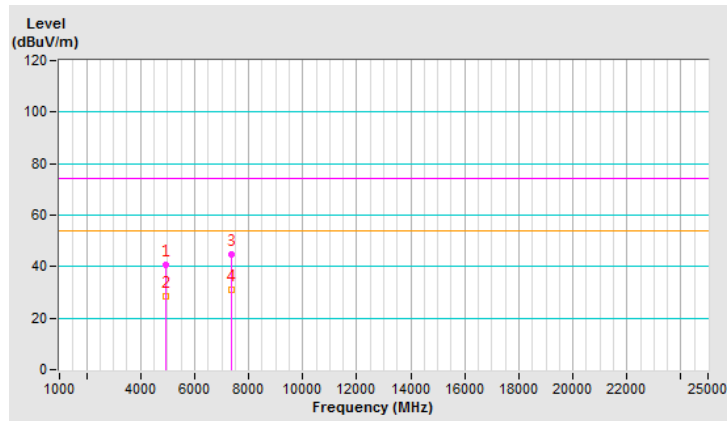

802.11n (40MHz)

CHANNEL	TX Channel 3	DETECTOR FUNCTION	Peak (PK)
FREQUENCY RANGE	1GHz ~ 25GHz		Average (AV)

ANTENNA POLARITY & TEST DISTANCE: HORIZONTAL AT 3 M								
NO.	FREQ. (MHz)	EMISSION LEVEL (dBuV/m)	LIMIT (dBuV/m)	MARGIN (dB)	ANTENNA HEIGHT (m)	TABLE ANGLE (Degree)	RAW VALUE (dBuV)	CORRECTION FACTOR (dB/m)
1	4844.00	42.7 PK	74.0	-31.3	1.65 H	13	40.6	2.1
2	4844.00	29.8 AV	54.0	-24.2	1.65 H	13	27.7	2.1
3	7266.00	42.5 PK	74.0	-31.5	1.68 H	336	34.2	8.3
4	7266.00	30.3 AV	54.0	-23.7	1.68 H	336	22.0	8.3

REMARKS:

1. Emission Level(dBuV/m) = Raw Value(dBuV) + Correction Factor(dB/m)
2. Correction Factor(dB/m) = Antenna Factor(dB/m) + Cable Factor(dB) – Pre-Amplifier Factor(dB)
3. The other emission levels were very low against the limit.
4. Margin value = Emission Level – Limit value

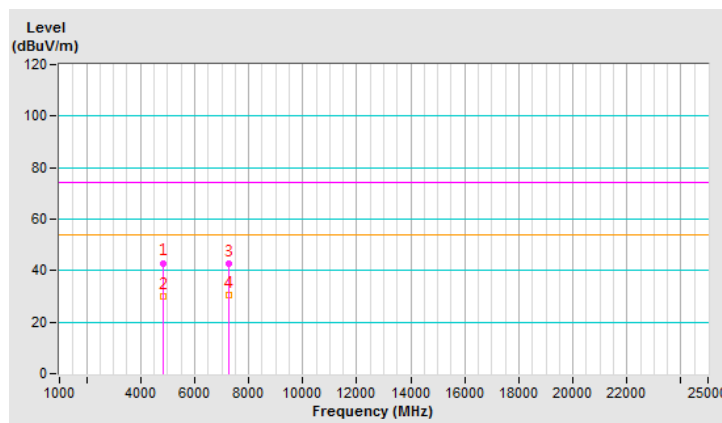

CHANNEL	TX Channel 3	DETECTOR FUNCTION	Peak (PK)
FREQUENCY RANGE	1GHz ~ 25GHz		Average (AV)

ANTENNA POLARITY & TEST DISTANCE: VERTICAL AT 3 M

NO.	FREQ. (MHz)	EMISSION LEVEL (dBuV/m)	LIMIT (dBuV/m)	MARGIN (dB)	ANTENNA HEIGHT (m)	TABLE ANGLE (Degree)	RAW VALUE (dBuV)	CORRECTION FACTOR (dB/m)
1	4844.00	39.5 PK	74.0	-34.5	1.04 V	357	37.4	2.1
2	4844.00	26.7 AV	54.0	-27.3	1.04 V	357	24.6	2.1
3	7266.00	42.8 PK	74.0	-31.2	2.03 V	78	34.5	8.3
4	7266.00	30.9 AV	54.0	-23.1	2.03 V	78	22.6	8.3

REMARKS:

1. Emission Level(dBuV/m) = Raw Value(dBuV) + Correction Factor(dB/m)
2. Correction Factor(dB/m) = Antenna Factor(dB/m) + Cable Factor(dB) – Pre-Amplifier Factor(dB)
3. The other emission levels were very low against the limit.
4. Margin value = Emission Level – Limit value

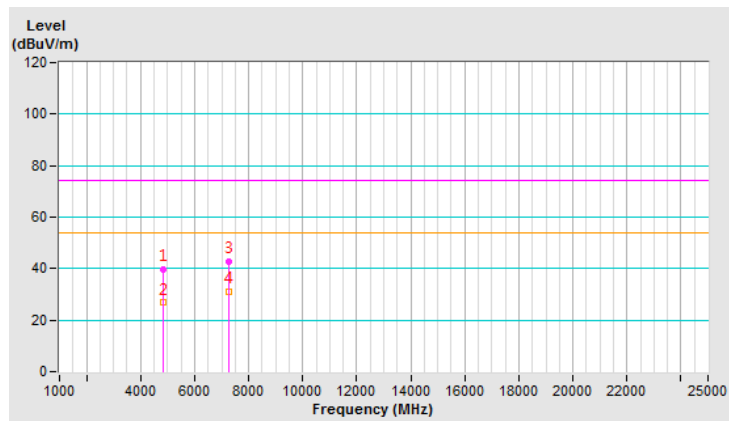

CHANNEL	TX Channel 6	DETECTOR FUNCTION	Peak (PK)
FREQUENCY RANGE	1GHz ~ 25GHz		Average (AV)

ANTENNA POLARITY & TEST DISTANCE: HORIZONTAL AT 3 M

NO.	FREQ. (MHz)	EMISSION LEVEL (dBuV/m)	LIMIT (dBuV/m)	MARGIN (dB)	ANTENNA HEIGHT (m)	TABLE ANGLE (Degree)	RAW VALUE (dBuV)	CORRECTION FACTOR (dB/m)
1	4874.00	43.1 PK	74.0	-30.9	1.68 H	21	41.0	2.1
2	4874.00	30.4 AV	54.0	-23.6	1.68 H	21	28.3	2.1
3	7311.00	42.5 PK	74.0	-31.5	1.69 H	335	34.3	8.2
4	7311.00	30.3 AV	54.0	-23.7	1.69 H	335	22.1	8.2

REMARKS:

1. Emission Level(dBuV/m) = Raw Value(dBuV) + Correction Factor(dB/m)
2. Correction Factor(dB/m) = Antenna Factor(dB/m) + Cable Factor(dB) – Pre-Amplifier Factor(dB)
3. The other emission levels were very low against the limit.
4. Margin value = Emission Level – Limit value

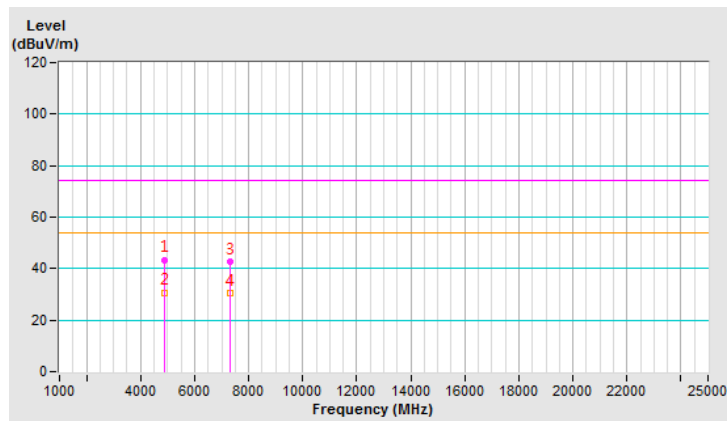

CHANNEL	TX Channel 6	DETECTOR FUNCTION	Peak (PK)
FREQUENCY RANGE	1GHz ~ 25GHz		Average (AV)

ANTENNA POLARITY & TEST DISTANCE: VERTICAL AT 3 M

NO.	FREQ. (MHz)	EMISSION LEVEL (dBuV/m)	LIMIT (dBuV/m)	MARGIN (dB)	ANTENNA HEIGHT (m)	TABLE ANGLE (Degree)	RAW VALUE (dBuV)	CORRECTION FACTOR (dB/m)
1	4874.00	39.6 PK	74.0	-34.4	2.32 V	251	37.5	2.1
2	4874.00	27.7 AV	54.0	-26.3	2.32 V	251	25.6	2.1
3	7311.00	43.0 PK	74.0	-31.0	1.29 V	22	34.8	8.2
4	7311.00	31.1 AV	54.0	-22.9	1.29 V	22	22.9	8.2

REMARKS:

1. Emission Level(dBuV/m) = Raw Value(dBuV) + Correction Factor(dB/m)
2. Correction Factor(dB/m) = Antenna Factor(dB/m) + Cable Factor(dB) – Pre-Amplifier Factor(dB)
3. The other emission levels were very low against the limit.
4. Margin value = Emission Level – Limit value

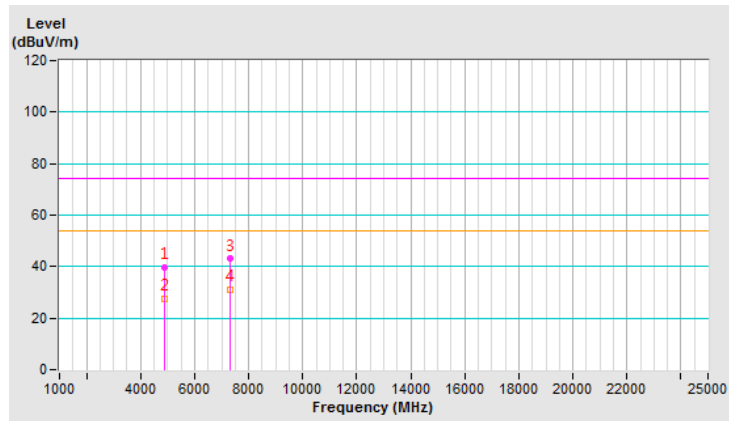

CHANNEL	TX Channel 9	DETECTOR FUNCTION	Peak (PK)
FREQUENCY RANGE	1GHz ~ 25GHz		Average (AV)

ANTENNA POLARITY & TEST DISTANCE: HORIZONTAL AT 3 M

NO.	FREQ. (MHz)	EMISSION LEVEL (dBuV/m)	LIMIT (dBuV/m)	MARGIN (dB)	ANTENNA HEIGHT (m)	TABLE ANGLE (Degree)	RAW VALUE (dBuV)	CORRECTION FACTOR (dB/m)
1	4904.00	43.7 PK	74.0	-30.3	1.63 H	6	41.5	2.2
2	4904.00	31.5 AV	54.0	-22.5	1.63 H	6	29.3	2.2
3	7356.00	42.4 PK	74.0	-31.6	1.66 H	334	34.1	8.3
4	7356.00	30.0 AV	54.0	-24.0	1.66 H	334	21.7	8.3

REMARKS:

1. Emission Level(dBuV/m) = Raw Value(dBuV) + Correction Factor(dB/m)
2. Correction Factor(dB/m) = Antenna Factor(dB/m) + Cable Factor(dB) – Pre-Amplifier Factor(dB)
3. The other emission levels were very low against the limit.
4. Margin value = Emission Level – Limit value

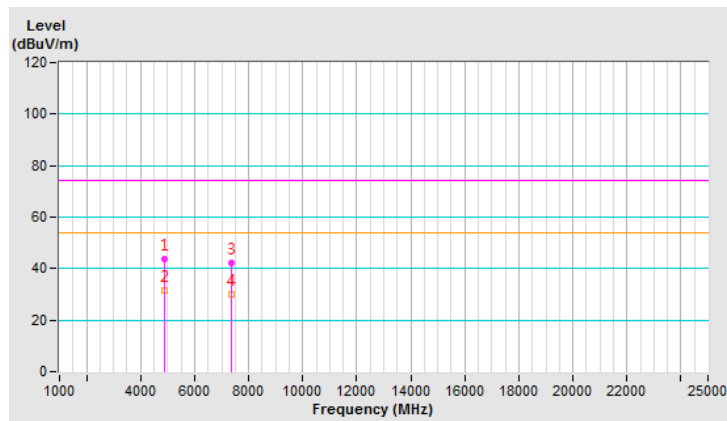

CHANNEL	TX Channel 9	DETECTOR FUNCTION	Peak (PK)
FREQUENCY RANGE	1GHz ~ 25GHz		Average (AV)

ANTENNA POLARITY & TEST DISTANCE: VERTICAL AT 3 M

NO.	FREQ. (MHz)	EMISSION LEVEL (dBuV/m)	LIMIT (dBuV/m)	MARGIN (dB)	ANTENNA HEIGHT (m)	TABLE ANGLE (Degree)	RAW VALUE (dBuV)	CORRECTION FACTOR (dB/m)
1	4904.00	41.6 PK	74.0	-32.4	2.53 V	355	39.4	2.2
2	4904.00	29.2 AV	54.0	-24.8	2.53 V	355	27.0	2.2
3	7356.00	43.6 PK	74.0	-30.4	1.58 V	112	35.3	8.3
4	7356.00	31.2 AV	54.0	-22.8	1.58 V	112	22.9	8.3

REMARKS:

1. Emission Level(dBuV/m) = Raw Value(dBuV) + Correction Factor(dB/m)
2. Correction Factor(dB/m) = Antenna Factor(dB/m) + Cable Factor(dB) – Pre-Amplifier Factor(dB)
3. The other emission levels were very low against the limit.
4. Margin value = Emission Level – Limit value

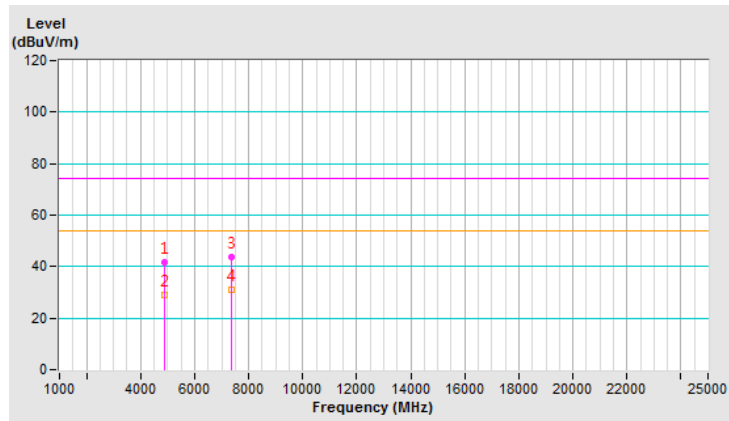

2TX

802.11n (20MHz)

CHANNEL	TX Channel 1	DETECTOR FUNCTION	Peak (PK)
FREQUENCY RANGE	1GHz ~ 25GHz		Average (AV)

ANTENNA POLARITY & TEST DISTANCE: HORIZONTAL AT 3 M

NO.	FREQ. (MHz)	EMISSION LEVEL (dBuV/m)	LIMIT (dBuV/m)	MARGIN (dB)	ANTENNA HEIGHT (m)	TABLE ANGLE (Degree)	RAW VALUE (dBuV)	CORRECTION FACTOR (dB/m)
1	4824.00	48.1 PK	74.0	-25.9	2.29 H	27	46.0	2.1
2	4824.00	35.6 AV	54.0	-18.4	2.29 H	27	33.5	2.1

REMARKS:

1. Emission Level(dBuV/m) = Raw Value(dBuV) + Correction Factor(dB/m)
2. Correction Factor(dB/m) = Antenna Factor(dB/m) + Cable Factor(dB) – Pre-Amplifier Factor(dB)
3. The other emission levels were very low against the limit.
4. Margin value = Emission Level – Limit value

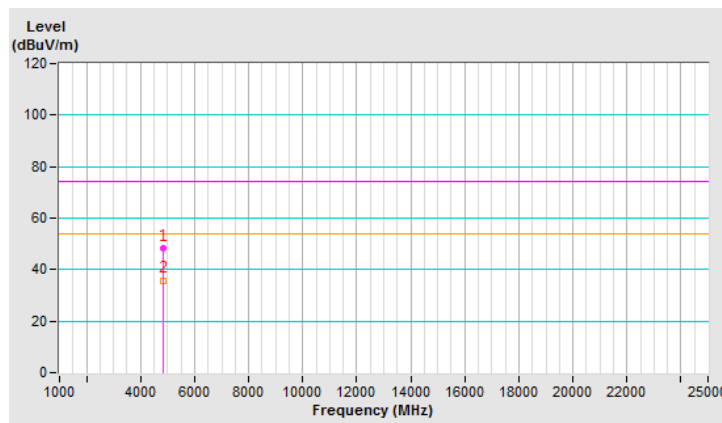

CHANNEL	TX Channel 1	DETECTOR FUNCTION	Peak (PK)
FREQUENCY RANGE	1GHz ~ 25GHz		Average (AV)

ANTENNA POLARITY & TEST DISTANCE: VERTICAL AT 3 M

NO.	FREQ. (MHz)	EMISSION LEVEL (dBuV/m)	LIMIT (dBuV/m)	MARGIN (dB)	ANTENNA HEIGHT (m)	TABLE ANGLE (Degree)	RAW VALUE (dBuV)	CORRECTION FACTOR (dB/m)
1	4824.00	45.3 PK	74.0	-28.7	2.66 V	108	43.2	2.1
2	4824.00	31.5 AV	54.0	-22.5	2.66 V	108	29.4	2.1

REMARKS:

1. Emission Level(dBuV/m) = Raw Value(dBuV) + Correction Factor(dB/m)
2. Correction Factor(dB/m) = Antenna Factor(dB/m) + Cable Factor(dB) – Pre-Amplifier Factor(dB)
3. The other emission levels were very low against the limit.
4. Margin value = Emission Level – Limit value

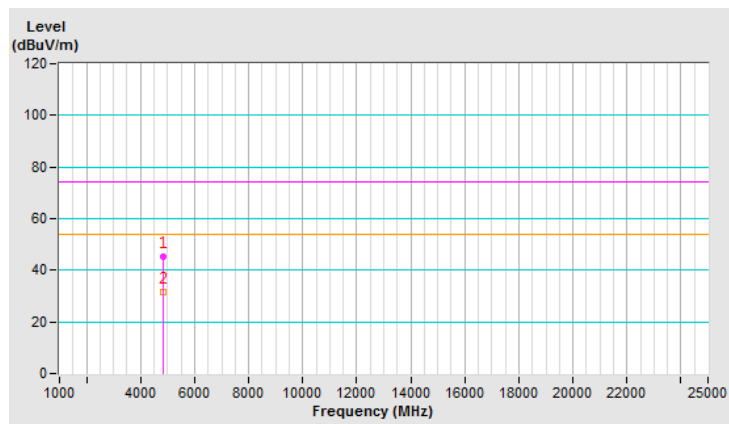

CHANNEL	TX Channel 6	DETECTOR FUNCTION	Peak (PK)
FREQUENCY RANGE	1GHz ~ 25GHz		Average (AV)

ANTENNA POLARITY & TEST DISTANCE: HORIZONTAL AT 3 M

NO.	FREQ. (MHz)	EMISSION LEVEL (dBuV/m)	LIMIT (dBuV/m)	MARGIN (dB)	ANTENNA HEIGHT (m)	TABLE ANGLE (Degree)	RAW VALUE (dBuV)	CORRECTION FACTOR (dB/m)
1	4874.00	47.8 PK	74.0	-26.2	2.24 H	20	45.7	2.1
2	4874.00	35.5 AV	54.0	-18.5	2.24 H	20	33.4	2.1
3	7311.00	43.4 PK	74.0	-30.6	1.16 H	315	35.2	8.2
4	7311.00	31.3 AV	54.0	-22.7	1.16 H	315	23.1	8.2

REMARKS:

1. Emission Level(dBuV/m) = Raw Value(dBuV) + Correction Factor(dB/m)
2. Correction Factor(dB/m) = Antenna Factor(dB/m) + Cable Factor(dB) – Pre-Amplifier Factor(dB)
3. The other emission levels were very low against the limit.
4. Margin value = Emission Level – Limit value

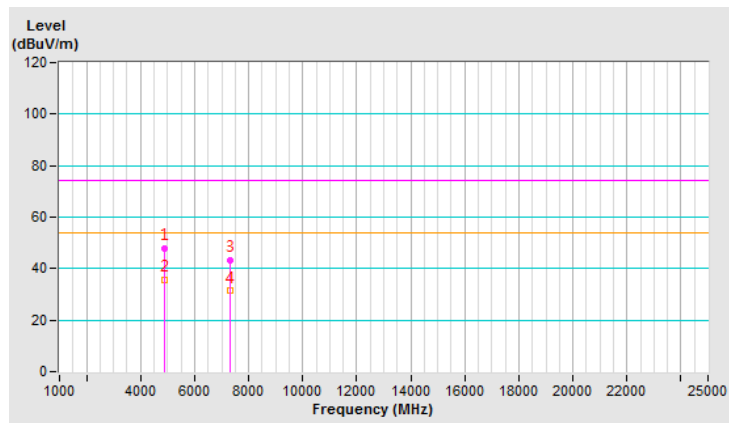

CHANNEL	TX Channel 6	DETECTOR FUNCTION	Peak (PK)
FREQUENCY RANGE	1GHz ~ 25GHz		Average (AV)

ANTENNA POLARITY & TEST DISTANCE: VERTICAL AT 3 M								
NO.	FREQ. (MHz)	EMISSION LEVEL (dBuV/m)	LIMIT (dBuV/m)	MARGIN (dB)	ANTENNA HEIGHT (m)	TABLE ANGLE (Degree)	RAW VALUE (dBuV)	CORRECTION FACTOR (dB/m)
1	4874.00	43.1 PK	74.0	-30.9	1.19 V	360	41.0	2.1
2	4874.00	30.5 AV	54.0	-23.5	1.19 V	360	28.4	2.1
3	7311.00	43.3 PK	74.0	-30.7	1.33 V	229	35.1	8.2
4	7311.00	31.0 AV	54.0	-23.0	1.33 V	229	22.8	8.2

REMARKS:

1. Emission Level(dBuV/m) = Raw Value(dBuV) + Correction Factor(dB/m)
2. Correction Factor(dB/m) = Antenna Factor(dB/m) + Cable Factor(dB) – Pre-Amplifier Factor(dB)
3. The other emission levels were very low against the limit.
4. Margin value = Emission Level – Limit value

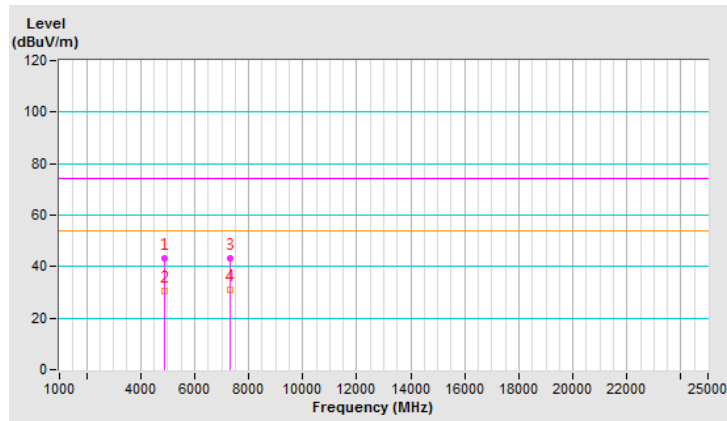

CHANNEL	TX Channel 11	DETECTOR FUNCTION	Peak (PK)
FREQUENCY RANGE	1GHz ~ 25GHz		Average (AV)

ANTENNA POLARITY & TEST DISTANCE: HORIZONTAL AT 3 M

NO.	FREQ. (MHz)	EMISSION LEVEL (dBuV/m)	LIMIT (dBuV/m)	MARGIN (dB)	ANTENNA HEIGHT (m)	TABLE ANGLE (Degree)	RAW VALUE (dBuV)	CORRECTION FACTOR (dB/m)
1	4924.00	47.4 PK	74.0	-26.6	2.26 H	27	45.2	2.2
2	4924.00	35.1 AV	54.0	-18.9	2.26 H	27	32.9	2.2
3	7386.00	43.4 PK	74.0	-30.6	1.12 H	330	35.1	8.3
4	7386.00	31.1 AV	54.0	-22.9	1.12 H	330	22.8	8.3

REMARKS:

1. Emission Level(dBuV/m) = Raw Value(dBuV) + Correction Factor(dB/m)
2. Correction Factor(dB/m) = Antenna Factor(dB/m) + Cable Factor(dB) – Pre-Amplifier Factor(dB)
3. The other emission levels were very low against the limit.
4. Margin value = Emission Level – Limit value

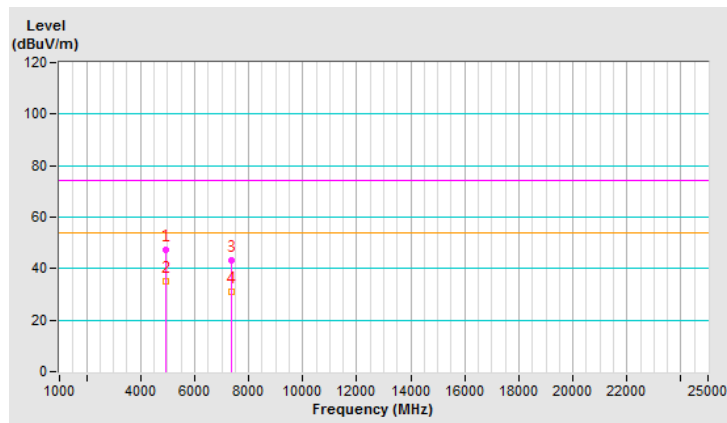

CHANNEL	TX Channel 11	DETECTOR FUNCTION	Peak (PK)
FREQUENCY RANGE	1GHz ~ 25GHz		Average (AV)

ANTENNA POLARITY & TEST DISTANCE: VERTICAL AT 3 M

NO.	FREQ. (MHz)	EMISSION LEVEL (dBuV/m)	LIMIT (dBuV/m)	MARGIN (dB)	ANTENNA HEIGHT (m)	TABLE ANGLE (Degree)	RAW VALUE (dBuV)	CORRECTION FACTOR (dB/m)
1	4924.00	41.7 PK	74.0	-32.3	2.53 V	356	39.5	2.2
2	4924.00	29.1 AV	54.0	-24.9	2.53 V	356	26.9	2.2
3	7386.00	44.2 PK	74.0	-29.8	1.57 V	108	35.9	8.3
4	7386.00	31.7 AV	54.0	-22.3	1.57 V	108	23.4	8.3

REMARKS:

1. Emission Level(dBuV/m) = Raw Value(dBuV) + Correction Factor(dB/m)
2. Correction Factor(dB/m) = Antenna Factor(dB/m) + Cable Factor(dB) – Pre-Amplifier Factor(dB)
3. The other emission levels were very low against the limit.
4. Margin value = Emission Level – Limit value

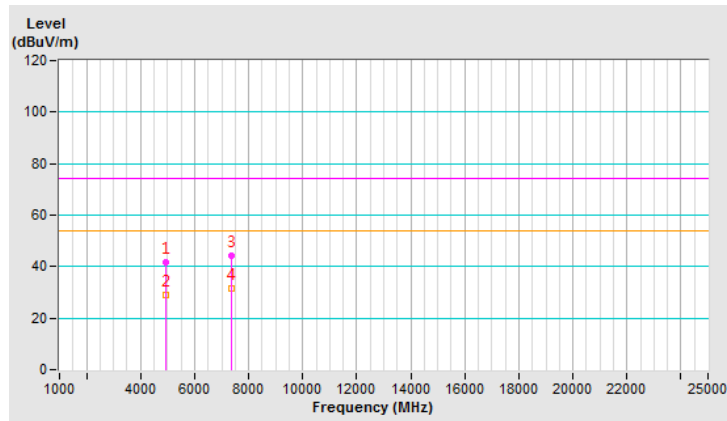

802.11n (40MHz)

CHANNEL	TX Channel 3	DETECTOR FUNCTION	Peak (PK)
FREQUENCY RANGE	1GHz ~ 25GHz		Average (AV)

ANTENNA POLARITY & TEST DISTANCE: HORIZONTAL AT 3 M								
NO.	FREQ. (MHz)	EMISSION LEVEL (dBuV/m)	LIMIT (dBuV/m)	MARGIN (dB)	ANTENNA HEIGHT (m)	TABLE ANGLE (Degree)	RAW VALUE (dBuV)	CORRECTION FACTOR (dB/m)
1	4844.00	42.6 PK	74.0	-31.4	1.61 H	11	40.5	2.1
2	4844.00	29.4 AV	54.0	-24.6	1.61 H	11	27.3	2.1
3	7266.00	42.1 PK	74.0	-31.9	1.63 H	327	33.8	8.3
4	7266.00	29.8 AV	54.0	-24.2	1.63 H	327	21.5	8.3

REMARKS:

1. Emission Level(dBuV/m) = Raw Value(dBuV) + Correction Factor(dB/m)
2. Correction Factor(dB/m) = Antenna Factor(dB/m) + Cable Factor(dB) – Pre-Amplifier Factor(dB)
3. The other emission levels were very low against the limit.
4. Margin value = Emission Level – Limit value

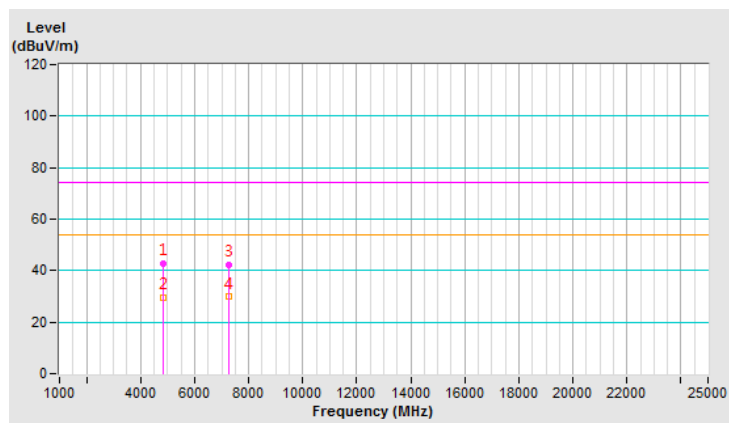

CHANNEL	TX Channel 3	DETECTOR FUNCTION	Peak (PK)
FREQUENCY RANGE	1GHz ~ 25GHz		Average (AV)

ANTENNA POLARITY & TEST DISTANCE: VERTICAL AT 3 M

NO.	FREQ. (MHz)	EMISSION LEVEL (dBuV/m)	LIMIT (dBuV/m)	MARGIN (dB)	ANTENNA HEIGHT (m)	TABLE ANGLE (Degree)	RAW VALUE (dBuV)	CORRECTION FACTOR (dB/m)
1	4844.00	38.5 PK	74.0	-35.5	1.00 V	356	36.4	2.1
2	4844.00	26.9 AV	54.0	-27.1	1.00 V	356	24.8	2.1
3	7266.00	42.3 PK	74.0	-31.7	1.69 V	349	34.0	8.3
4	7266.00	31.0 AV	54.0	-23.0	1.69 V	349	22.7	8.3

REMARKS:

1. Emission Level(dBuV/m) = Raw Value(dBuV) + Correction Factor(dB/m)
2. Correction Factor(dB/m) = Antenna Factor(dB/m) + Cable Factor(dB) – Pre-Amplifier Factor(dB)
3. The other emission levels were very low against the limit.
4. Margin value = Emission Level – Limit value

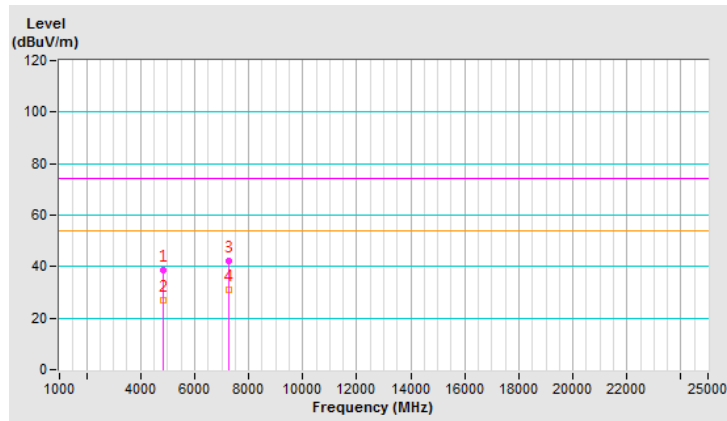

CHANNEL	TX Channel 6	DETECTOR FUNCTION	Peak (PK)
FREQUENCY RANGE	1GHz ~ 25GHz		Average (AV)

ANTENNA POLARITY & TEST DISTANCE: HORIZONTAL AT 3 M

NO.	FREQ. (MHz)	EMISSION LEVEL (dBuV/m)	LIMIT (dBuV/m)	MARGIN (dB)	ANTENNA HEIGHT (m)	TABLE ANGLE (Degree)	RAW VALUE (dBuV)	CORRECTION FACTOR (dB/m)
1	4874.00	43.5 PK	74.0	-30.5	1.69 H	6	41.4	2.1
2	4874.00	30.8 AV	54.0	-23.2	1.69 H	6	28.7	2.1
3	7311.00	43.0 PK	74.0	-31.0	1.73 H	340	34.8	8.2
4	7311.00	30.6 AV	54.0	-23.4	1.73 H	340	22.4	8.2

REMARKS:

1. Emission Level(dBuV/m) = Raw Value(dBuV) + Correction Factor(dB/m)
2. Correction Factor(dB/m) = Antenna Factor(dB/m) + Cable Factor(dB) – Pre-Amplifier Factor(dB)
3. The other emission levels were very low against the limit.
4. Margin value = Emission Level – Limit value

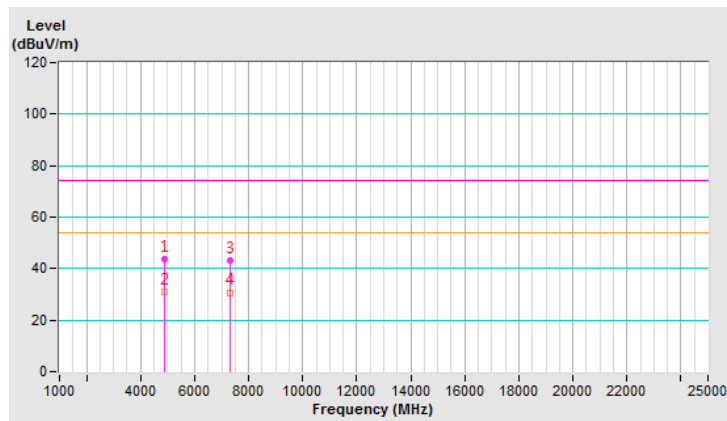

CHANNEL	TX Channel 6	DETECTOR FUNCTION	Peak (PK)
FREQUENCY RANGE	1GHz ~ 25GHz		Average (AV)

ANTENNA POLARITY & TEST DISTANCE: VERTICAL AT 3 M

NO.	FREQ. (MHz)	EMISSION LEVEL (dBuV/m)	LIMIT (dBuV/m)	MARGIN (dB)	ANTENNA HEIGHT (m)	TABLE ANGLE (Degree)	RAW VALUE (dBuV)	CORRECTION FACTOR (dB/m)
1	4874.00	39.7 PK	74.0	-34.3	1.01 V	353	37.6	2.1
2	4874.00	27.8 AV	54.0	-26.2	1.01 V	353	25.7	2.1
3	7311.00	42.2 PK	74.0	-31.8	2.25 V	235	34.0	8.2
4	7311.00	30.9 AV	54.0	-23.1	2.25 V	235	22.7	8.2

REMARKS:

1. Emission Level(dBuV/m) = Raw Value(dBuV) + Correction Factor(dB/m)
2. Correction Factor(dB/m) = Antenna Factor(dB/m) + Cable Factor(dB) – Pre-Amplifier Factor(dB)
3. The other emission levels were very low against the limit.
4. Margin value = Emission Level – Limit value

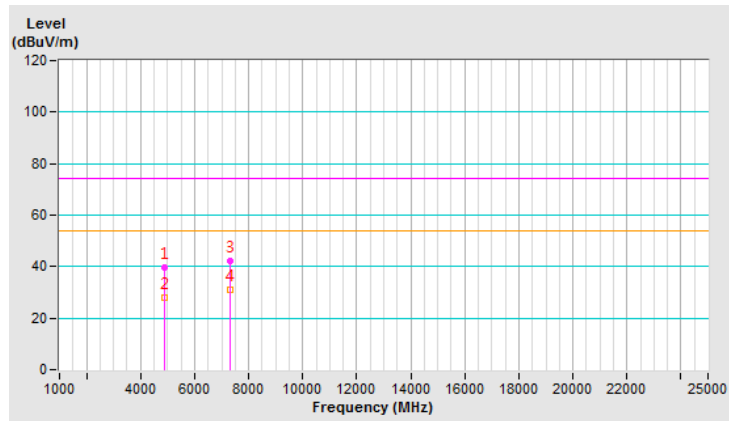

CHANNEL	TX Channel 9	DETECTOR FUNCTION	Peak (PK)
FREQUENCY RANGE	1GHz ~ 25GHz		Average (AV)

ANTENNA POLARITY & TEST DISTANCE: HORIZONTAL AT 3 M

NO.	FREQ. (MHz)	EMISSION LEVEL (dBuV/m)	LIMIT (dBuV/m)	MARGIN (dB)	ANTENNA HEIGHT (m)	TABLE ANGLE (Degree)	RAW VALUE (dBuV)	CORRECTION FACTOR (dB/m)
1	4904.00	43.7 PK	74.0	-30.3	1.59 H	0	41.5	2.2
2	4904.00	31.6 AV	54.0	-22.4	1.59 H	0	29.4	2.2
3	7356.00	42.5 PK	74.0	-31.5	1.70 H	325	34.2	8.3
4	7356.00	29.8 AV	54.0	-24.2	1.70 H	325	21.5	8.3

REMARKS:

1. Emission Level(dBuV/m) = Raw Value(dBuV) + Correction Factor(dB/m)
2. Correction Factor(dB/m) = Antenna Factor(dB/m) + Cable Factor(dB) – Pre-Amplifier Factor(dB)
3. The other emission levels were very low against the limit.
4. Margin value = Emission Level – Limit value

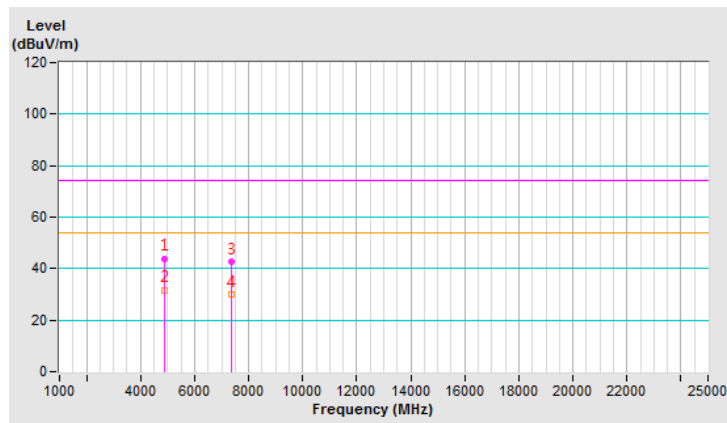

CHANNEL	TX Channel 9	DETECTOR FUNCTION	Peak (PK)
FREQUENCY RANGE	1GHz ~ 25GHz		Average (AV)

ANTENNA POLARITY & TEST DISTANCE: VERTICAL AT 3 M

NO.	FREQ. (MHz)	EMISSION LEVEL (dBuV/m)	LIMIT (dBuV/m)	MARGIN (dB)	ANTENNA HEIGHT (m)	TABLE ANGLE (Degree)	RAW VALUE (dBuV)	CORRECTION FACTOR (dB/m)
1	4904.00	40.1 PK	74.0	-33.9	2.66 V	354	37.9	2.2
2	4904.00	28.6 AV	54.0	-25.4	2.66 V	354	26.4	2.2
3	7356.00	42.9 PK	74.0	-31.1	1.48 V	323	34.6	8.3
4	7356.00	31.2 AV	54.0	-22.8	1.48 V	323	22.9	8.3

REMARKS:

1. Emission Level(dBuV/m) = Raw Value(dBuV) + Correction Factor(dB/m)
2. Correction Factor(dB/m) = Antenna Factor(dB/m) + Cable Factor(dB) – Pre-Amplifier Factor(dB)
3. The other emission levels were very low against the limit.
4. Margin value = Emission Level – Limit value

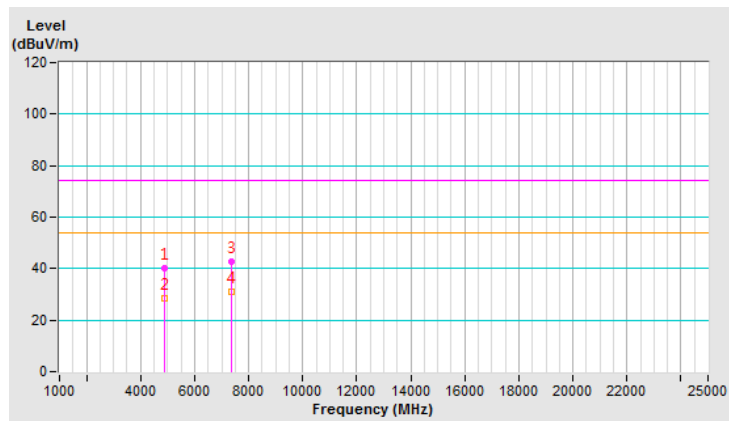

4.7 Band Edge and Fundamental Emissions Measurement

4.7.1 Limit

30dBc in any 100 kHz bandwidth outside the operating frequency band. In case the emissions fall within the restricted band specified on 15.205(a), then the 15.209(a) limit in the table below has to be followed

Frequency range (MHz)	Field Strength (mV/meter)	Measurement Distance (m)
0.009~0.490	2400/F(kHz)	300
0.490~1.705	24000/F(kHz)	30
1.705~30.0	30	30
30~88	100	3
88~216	150	3
216~960	200	3
Above 960	500	3

4.7.2 Measuring Instruments and Setting

Please refer to section 5 of equipments list in this report. The following table is the setting of spectrum analyzer and receiver.

Spectrum Parameter	Setting
Attenuation	Auto
Start Frequency	1000 MHz
Stop Frequency	10th carrier harmonic
RBW / VBW (Emissions in restricted band)	1MHz / 3MHz for Peak, 1 MHz / 1/T for Average
RBW / VBW (Emissions in non-restricted band)	100kHz / 300kHz for peak

4.7.3 Test Procedure

- 1 The test procedure is the same as section 4.6.3; only the frequency range investigated is 2310MHz to 2500MHz
- 2 Test for Emissions in non-restricted band was performed in accordance with KDB 558074 D01 v04 for Performing Compliance Measurements on Digital Transmission Systems (DTS) Operating Under §15.247 section 11 Unwanted Emissions into Non-Restricted Frequency Bands Measurement Procedure.

4.7.4 Test Setup Layout

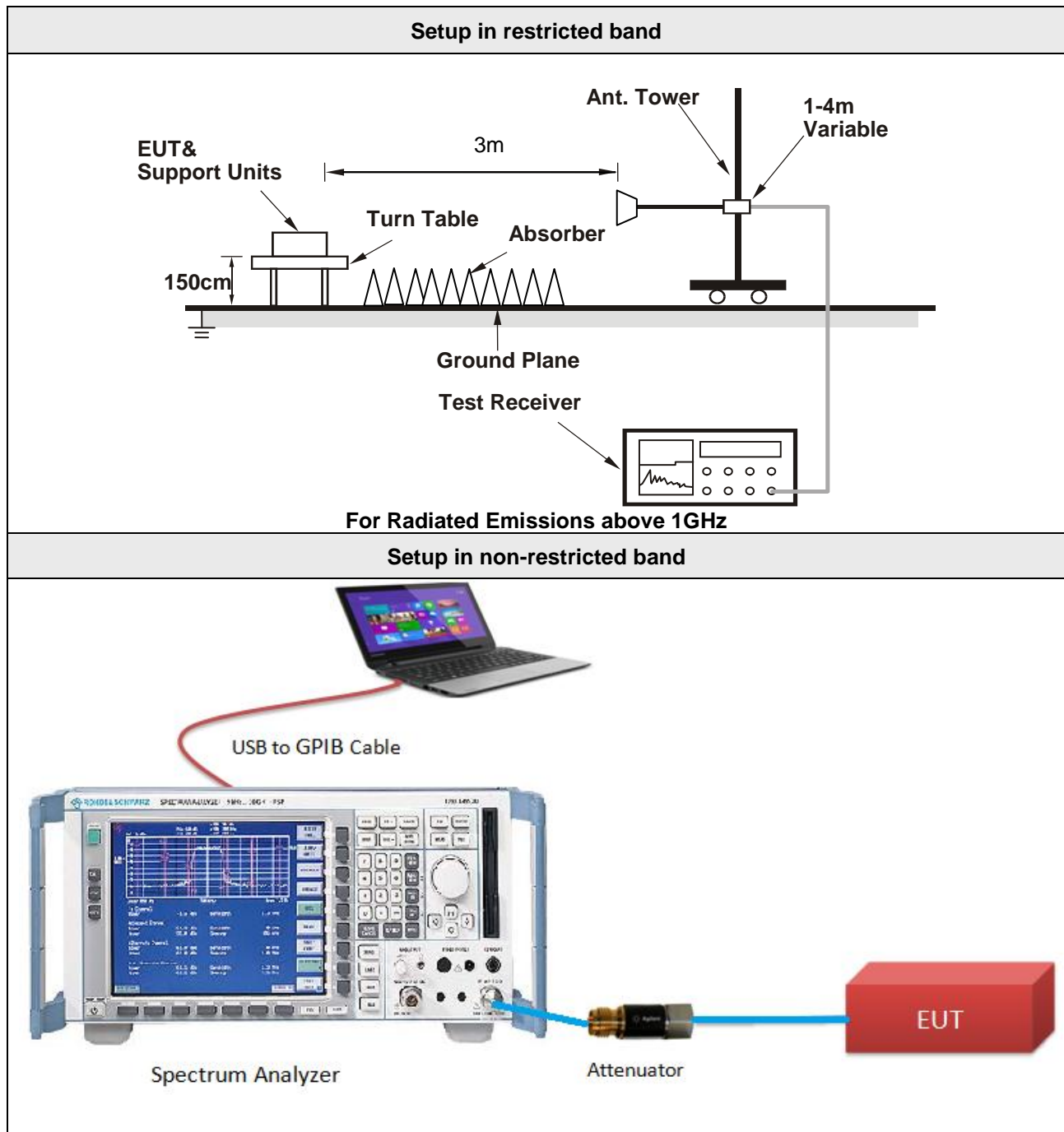

4.7.5 Test Deviation

There are no deviations with the original standard.

4.7.6 EUT Operating Conditions

The EUT was programmed to be in continuously transmitting mode.

4.7.7 Test Results of Band Edge and Fundamental Emissions

Temperature	24°C	Humidity	68%
Test Engineer	Andy Ho		

1TX

802.11b

CHANNEL	TX Channel 1	DETECTOR FUNCTION	Peak (PK)
FREQUENCY RANGE	1GHz ~ 25GHz		Average (AV)

ANTENNA POLARITY & TEST DISTANCE: HORIZONTAL AT 3 M

NO.	FREQ. (MHz)	EMISSION LEVEL (dBuV/m)	LIMIT (dBuV/m)	MARGIN (dB)	ANTENNA HEIGHT (m)	TABLE ANGLE (Degree)	RAW VALUE (dBuV)	CORRECTION FACTOR (dB/m)
1	2390.00	55.4 PK	74.0	-18.6	2.51 H	328	57.6	-2.2
2	2390.00	41.7 AV	54.0	-12.3	2.51 H	328	43.9	-2.2
3	*2412.00	102.8 PK			2.51 H	328	105.1	-2.3
4	*2412.00	100.1 AV			2.51 H	328	102.4	-2.3

REMARKS:

1. Emission Level(dBuV/m) = Raw Value(dBuV) + Correction Factor(dB/m)
2. Correction Factor(dB/m) = Antenna Factor(dB/m) + Cable Factor(dB) – Pre-Amplifier Factor(dB)
3. The other emission levels were very low against the limit.
4. Margin value = Emission Level – Limit value
5. " * ": Fundamental frequency.

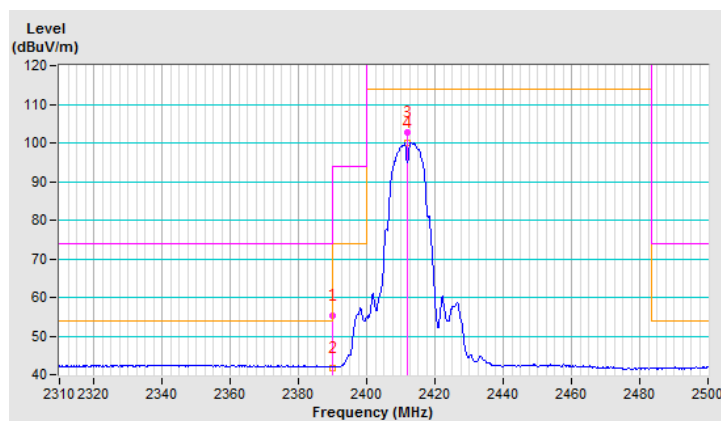

CHANNEL	TX Channel 1	DETECTOR FUNCTION	Peak (PK)
FREQUENCY RANGE	1GHz ~ 25GHz		Average (AV)

ANTENNA POLARITY & TEST DISTANCE: VERTICAL AT 3 M

NO.	FREQ. (MHz)	EMISSION LEVEL (dBuV/m)	LIMIT (dBuV/m)	MARGIN (dB)	ANTENNA HEIGHT (m)	TABLE ANGLE (Degree)	RAW VALUE (dBuV)	CORRECTION FACTOR (dB/m)
1	2390.00	55.0 PK	74.0	-19.0	3.03 V	303	57.2	-2.2
2	2390.00	41.8 AV	54.0	-12.2	3.03 V	303	44.0	-2.2
3	*2412.00	107.8 PK			3.03 V	303	110.1	-2.3
4	*2412.00	105.2 AV			3.03 V	303	107.5	-2.3

REMARKS:

1. Emission Level(dBuV/m) = Raw Value(dBuV) + Correction Factor(dB/m)
2. Correction Factor(dB/m) = Antenna Factor(dB/m) + Cable Factor(dB) – Pre-Amplifier Factor(dB)
3. The other emission levels were very low against the limit.
4. Margin value = Emission Level – Limit value
5. " * ": Fundamental frequency.

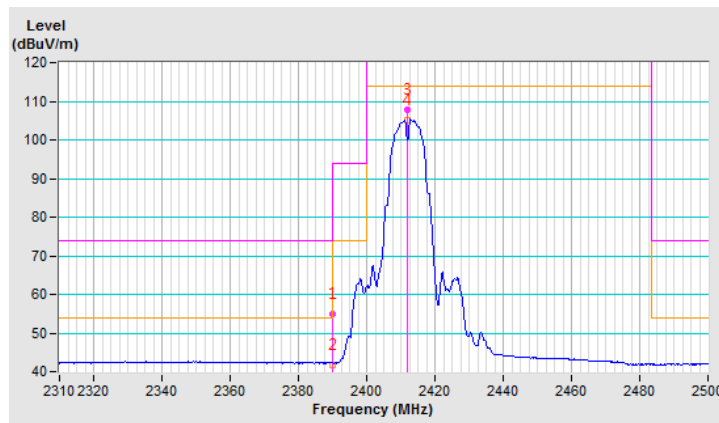

CHANNEL	TX Channel 6	DETECTOR FUNCTION	Peak (PK)
FREQUENCY RANGE	1GHz ~ 25GHz		Average (AV)

ANTENNA POLARITY & TEST DISTANCE: HORIZONTAL AT 3 M

NO.	FREQ. (MHz)	EMISSION LEVEL (dBuV/m)	LIMIT (dBuV/m)	MARGIN (dB)	ANTENNA HEIGHT (m)	TABLE ANGLE (Degree)	RAW VALUE (dBuV)	CORRECTION FACTOR (dB/m)
1	2390.00	55.9 PK	74.0	-18.1	2.68 H	332	58.1	-2.2
2	2390.00	41.7 AV	54.0	-12.3	2.68 H	332	43.9	-2.2
3	*2437.00	101.8 PK			2.68 H	332	104.4	-2.6
4	*2437.00	99.2 AV			2.68 H	332	101.8	-2.6
5	2483.50	54.3 PK	74.0	-19.7	2.68 H	332	56.8	-2.5
6	2483.50	41.3 AV	54.0	-12.7	2.68 H	332	43.8	-2.5

REMARKS:

1. Emission Level(dBuV/m) = Raw Value(dBuV) + Correction Factor(dB/m)
2. Correction Factor(dB/m) = Antenna Factor(dB/m) + Cable Factor(dB) – Pre-Amplifier Factor(dB)
3. The other emission levels were very low against the limit.
4. Margin value = Emission Level – Limit value
5. " * ": Fundamental frequency.

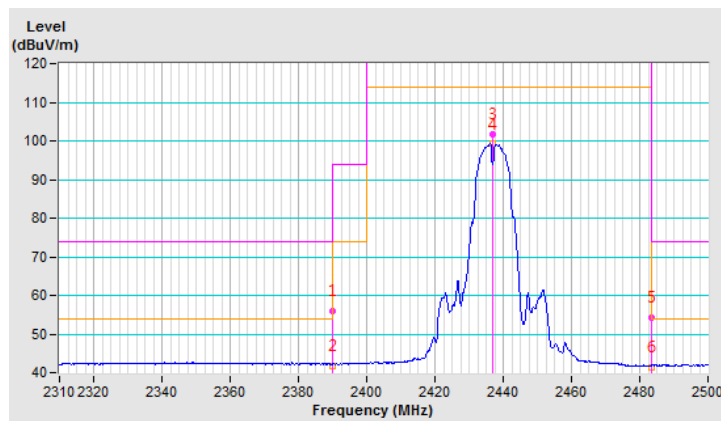

CHANNEL	TX Channel 6	DETECTOR FUNCTION	Peak (PK)
FREQUENCY RANGE	1GHz ~ 25GHz		Average (AV)

ANTENNA POLARITY & TEST DISTANCE: VERTICAL AT 3 M

NO.	FREQ. (MHz)	EMISSION LEVEL (dBuV/m)	LIMIT (dBuV/m)	MARGIN (dB)	ANTENNA HEIGHT (m)	TABLE ANGLE (Degree)	RAW VALUE (dBuV)	CORRECTION FACTOR (dB/m)
1	2390.00	55.4 PK	74.0	-18.6	2.58 V	30	57.6	-2.2
2	2390.00	41.6 AV	54.0	-12.4	2.58 V	30	43.8	-2.2
3	*2437.00	104.8 PK			2.58 V	30	107.4	-2.6
4	*2437.00	102.3 AV			2.58 V	30	104.9	-2.6
5	2483.50	54.7 PK	74.0	-19.3	2.58 V	30	57.2	-2.5
6	2483.50	41.5 AV	54.0	-12.5	2.58 V	30	44.0	-2.5

REMARKS:

1. Emission Level(dBuV/m) = Raw Value(dBuV) + Correction Factor(dB/m)
2. Correction Factor(dB/m) = Antenna Factor(dB/m) + Cable Factor(dB) – Pre-Amplifier Factor(dB)
3. The other emission levels were very low against the limit.
4. Margin value = Emission Level – Limit value
5. " * ": Fundamental frequency.

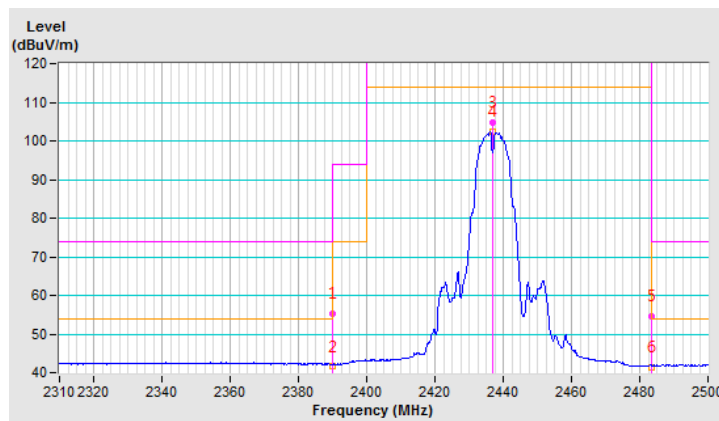

CHANNEL	TX Channel 11	DETECTOR FUNCTION	Peak (PK)
FREQUENCY RANGE	1GHz ~ 25GHz		Average (AV)

ANTENNA POLARITY & TEST DISTANCE: HORIZONTAL AT 3 M

NO.	FREQ. (MHz)	EMISSION LEVEL (dBuV/m)	LIMIT (dBuV/m)	MARGIN (dB)	ANTENNA HEIGHT (m)	TABLE ANGLE (Degree)	RAW VALUE (dBuV)	CORRECTION FACTOR (dB/m)
1	*2462.00	102.2 PK			2.16 H	328	104.7	-2.5
2	*2462.00	99.6 AV			2.16 H	328	102.1	-2.5
3	2483.50	54.7 PK	74.0	-19.3	2.16 H	328	57.2	-2.5
4	2483.50	41.4 AV	54.0	-12.6	2.16 H	328	43.9	-2.5

REMARKS:

1. Emission Level(dBuV/m) = Raw Value(dBuV) + Correction Factor(dB/m)
2. Correction Factor(dB/m) = Antenna Factor(dB/m) + Cable Factor(dB) – Pre-Amplifier Factor(dB)
3. The other emission levels were very low against the limit.
4. Margin value = Emission Level – Limit value
5. " * ": Fundamental frequency.

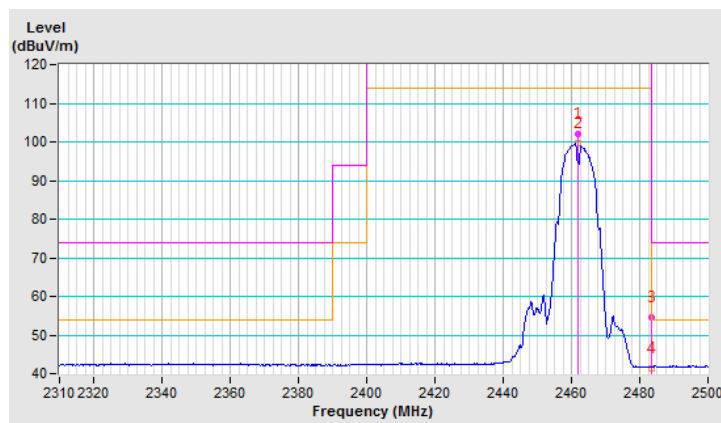

CHANNEL	TX Channel 11	DETECTOR FUNCTION	Peak (PK)
FREQUENCY RANGE	1GHz ~ 25GHz		Average (AV)

ANTENNA POLARITY & TEST DISTANCE: VERTICAL AT 3 M

NO.	FREQ. (MHz)	EMISSION LEVEL (dBuV/m)	LIMIT (dBuV/m)	MARGIN (dB)	ANTENNA HEIGHT (m)	TABLE ANGLE (Degree)	RAW VALUE (dBuV)	CORRECTION FACTOR (dB/m)
1	*2462.00	105.5 PK			2.63 V	302	108.0	-2.5
2	*2462.00	103.0 AV			2.63 V	302	105.5	-2.5
3	2483.50	54.9 PK	74.0	-19.1	2.63 V	302	57.4	-2.5
4	2483.50	41.5 AV	54.0	-12.5	2.63 V	302	44.0	-2.5

REMARKS:

1. Emission Level(dBuV/m) = Raw Value(dBuV) + Correction Factor(dB/m)
2. Correction Factor(dB/m) = Antenna Factor(dB/m) + Cable Factor(dB) – Pre-Amplifier Factor(dB)
3. The other emission levels were very low against the limit.
4. Margin value = Emission Level – Limit value
5. " * ": Fundamental frequency.

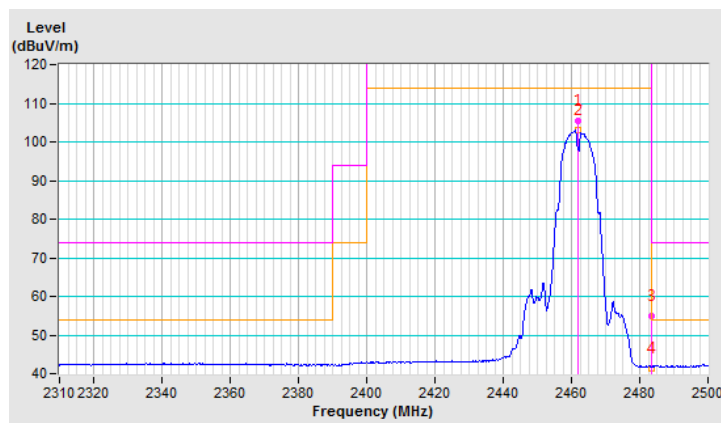

802.11g

CHANNEL	TX Channel 1	DETECTOR FUNCTION	Peak (PK)
FREQUENCY RANGE	1GHz ~ 25GHz		Average (AV)

ANTENNA POLARITY & TEST DISTANCE: HORIZONTAL AT 3 M								
NO.	FREQ. (MHz)	EMISSION LEVEL (dBuV/m)	LIMIT (dBuV/m)	MARGIN (dB)	ANTENNA HEIGHT (m)	TABLE ANGLE (Degree)	RAW VALUE (dBuV)	CORRECTION FACTOR (dB/m)
1	2390.00	55.1 PK	74.0	-18.9	2.65 H	347	57.3	-2.2
2	2390.00	41.7 AV	54.0	-12.3	2.65 H	347	43.9	-2.2
3	*2412.00	106.1 PK			2.65 H	347	108.4	-2.3
4	*2412.00	95.1 AV			2.65 H	347	97.4	-2.3

REMARKS:

1. Emission Level(dBuV/m) = Raw Value(dBuV) + Correction Factor(dB/m)
2. Correction Factor(dB/m) = Antenna Factor(dB/m) + Cable Factor(dB) – Pre-Amplifier Factor(dB)
3. The other emission levels were very low against the limit.
4. Margin value = Emission Level – Limit value
5. " * ": Fundamental frequency.

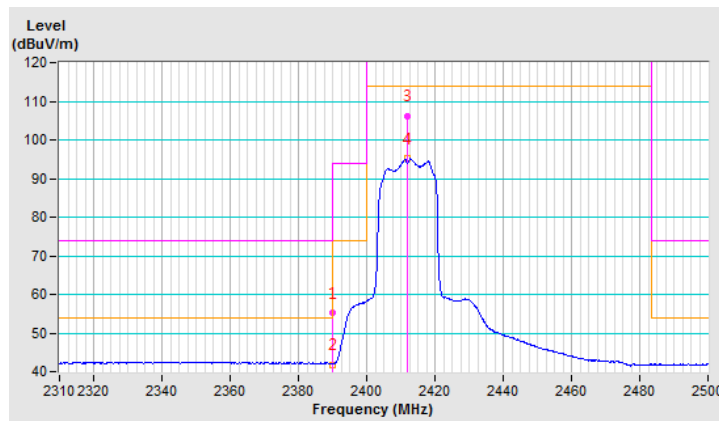

CHANNEL	TX Channel 1	DETECTOR FUNCTION	Peak (PK)
FREQUENCY RANGE	1GHz ~ 25GHz		Average (AV)

ANTENNA POLARITY & TEST DISTANCE: VERTICAL AT 3 M

NO.	FREQ. (MHz)	EMISSION LEVEL (dBuV/m)	LIMIT (dBuV/m)	MARGIN (dB)	ANTENNA HEIGHT (m)	TABLE ANGLE (Degree)	RAW VALUE (dBuV)	CORRECTION FACTOR (dB/m)
1	2390.00	55.5 PK	74.0	-18.5	3.02 V	306	57.7	-2.2
2	2390.00	41.7 AV	54.0	-12.3	3.02 V	306	43.9	-2.2
3	*2412.00	111.1 PK			3.02 V	306	113.4	-2.3
4	*2412.00	100.8 AV			3.02 V	306	103.1	-2.3

REMARKS:

1. Emission Level(dBuV/m) = Raw Value(dBuV) + Correction Factor(dB/m)
2. Correction Factor(dB/m) = Antenna Factor(dB/m) + Cable Factor(dB) – Pre-Amplifier Factor(dB)
3. The other emission levels were very low against the limit.
4. Margin value = Emission Level – Limit value
5. " * ": Fundamental frequency.

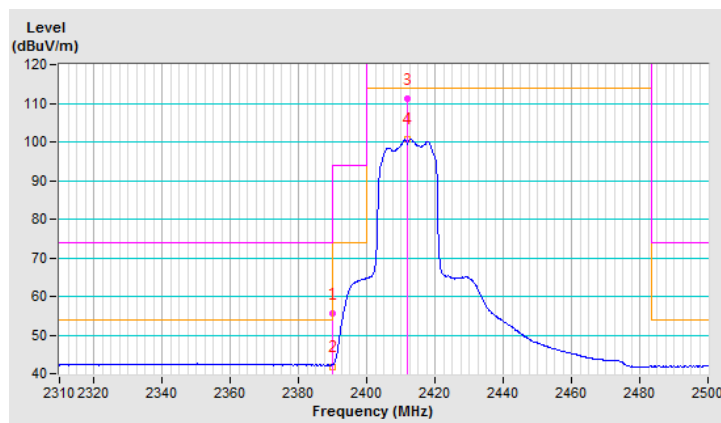

CHANNEL	TX Channel 6	DETECTOR FUNCTION	Peak (PK)
FREQUENCY RANGE	1GHz ~ 25GHz		Average (AV)

ANTENNA POLARITY & TEST DISTANCE: HORIZONTAL AT 3 M

NO.	FREQ. (MHz)	EMISSION LEVEL (dBuV/m)	LIMIT (dBuV/m)	MARGIN (dB)	ANTENNA HEIGHT (m)	TABLE ANGLE (Degree)	RAW VALUE (dBuV)	CORRECTION FACTOR (dB/m)
1	2390.00	54.8 PK	74.0	-19.2	2.20 H	326	57.0	-2.2
2	2390.00	41.7 AV	54.0	-12.3	2.20 H	326	43.9	-2.2
3	*2437.00	106.4 PK			2.20 H	326	109.0	-2.6
4	*2437.00	96.0 AV			2.20 H	326	98.6	-2.6
5	2483.50	55.1 PK	74.0	-18.9	2.20 H	326	57.6	-2.5
6	2483.50	41.4 AV	54.0	-12.6	2.20 H	326	43.9	-2.5

REMARKS:

1. Emission Level(dBuV/m) = Raw Value(dBuV) + Correction Factor(dB/m)
2. Correction Factor(dB/m) = Antenna Factor(dB/m) + Cable Factor(dB) – Pre-Amplifier Factor(dB)
3. The other emission levels were very low against the limit.
4. Margin value = Emission Level – Limit value
5. " * ": Fundamental frequency.

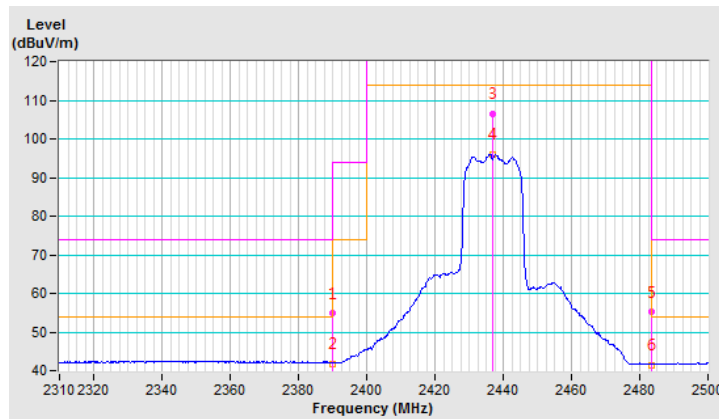

CHANNEL	TX Channel 6	DETECTOR FUNCTION	Peak (PK)
FREQUENCY RANGE	1GHz ~ 25GHz		Average (AV)

ANTENNA POLARITY & TEST DISTANCE: VERTICAL AT 3 M

NO.	FREQ. (MHz)	EMISSION LEVEL (dBuV/m)	LIMIT (dBuV/m)	MARGIN (dB)	ANTENNA HEIGHT (m)	TABLE ANGLE (Degree)	RAW VALUE (dBuV)	CORRECTION FACTOR (dB/m)
1	2390.00	56.2 PK	74.0	-17.8	2.96 V	302	58.4	-2.2
2	2390.00	41.8 AV	54.0	-12.2	2.96 V	302	44.0	-2.2
3	*2437.00	110.8 PK			2.96 V	302	113.4	-2.6
4	*2437.00	100.6 AV			2.96 V	302	103.2	-2.6
5	2483.50	54.3 PK	74.0	-19.7	2.96 V	302	56.8	-2.5
6	2483.50	41.4 AV	54.0	-12.6	2.96 V	302	43.9	-2.5

REMARKS:

1. Emission Level(dBuV/m) = Raw Value(dBuV) + Correction Factor(dB/m)
2. Correction Factor(dB/m) = Antenna Factor(dB/m) + Cable Factor(dB) – Pre-Amplifier Factor(dB)
3. The other emission levels were very low against the limit.
4. Margin value = Emission Level – Limit value
5. " * ": Fundamental frequency.

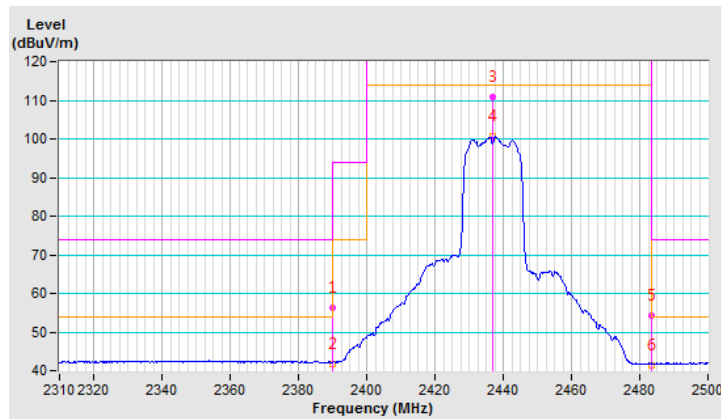

CHANNEL	TX Channel 11	DETECTOR FUNCTION	Peak (PK)
FREQUENCY RANGE	1GHz ~ 25GHz		Average (AV)

ANTENNA POLARITY & TEST DISTANCE: HORIZONTAL AT 3 M

NO.	FREQ. (MHz)	EMISSION LEVEL (dBuV/m)	LIMIT (dBuV/m)	MARGIN (dB)	ANTENNA HEIGHT (m)	TABLE ANGLE (Degree)	RAW VALUE (dBuV)	CORRECTION FACTOR (dB/m)
1	*2462.00	105.7 PK			2.49 H	345	108.2	-2.5
2	*2462.00	95.9 AV			2.49 H	345	98.4	-2.5
3	2483.50	55.7 PK	74.0	-18.3	2.49 H	345	58.2	-2.5
4	2483.50	43.9 AV	54.0	-10.1	2.49 H	345	46.4	-2.5

REMARKS:

1. Emission Level(dBuV/m) = Raw Value(dBuV) + Correction Factor(dB/m)
2. Correction Factor(dB/m) = Antenna Factor(dB/m) + Cable Factor(dB) – Pre-Amplifier Factor(dB)
3. The other emission levels were very low against the limit.
4. Margin value = Emission Level – Limit value
5. " * ": Fundamental frequency.

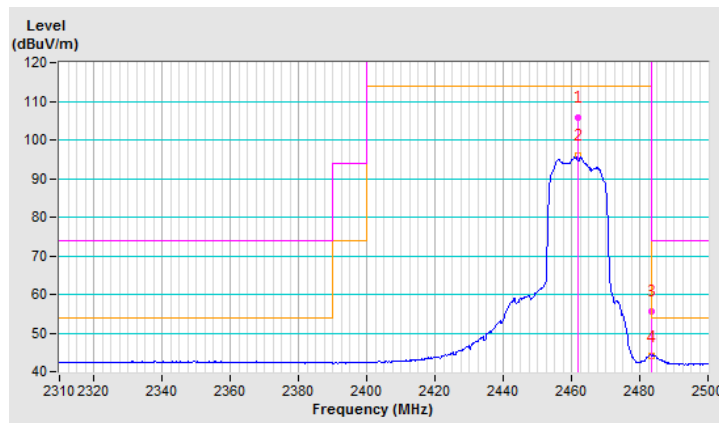

CHANNEL	TX Channel 11	DETECTOR FUNCTION	Peak (PK)
FREQUENCY RANGE	1GHz ~ 25GHz		Average (AV)

ANTENNA POLARITY & TEST DISTANCE: VERTICAL AT 3 M

NO.	FREQ. (MHz)	EMISSION LEVEL (dBuV/m)	LIMIT (dBuV/m)	MARGIN (dB)	ANTENNA HEIGHT (m)	TABLE ANGLE (Degree)	RAW VALUE (dBuV)	CORRECTION FACTOR (dB/m)
1	*2462.00	108.0 PK			2.66 V	302	110.5	-2.5
2	*2462.00	98.1 AV			2.66 V	302	100.6	-2.5
3	2483.50	57.2 PK	74.0	-16.8	2.66 V	302	59.7	-2.5
4	2483.50	44.3 AV	54.0	-9.7	2.66 V	302	46.8	-2.5

REMARKS:

1. Emission Level(dBuV/m) = Raw Value(dBuV) + Correction Factor(dB/m)
2. Correction Factor(dB/m) = Antenna Factor(dB/m) + Cable Factor(dB) – Pre-Amplifier Factor(dB)
3. The other emission levels were very low against the limit.
4. Margin value = Emission Level – Limit value
5. " * ": Fundamental frequency.

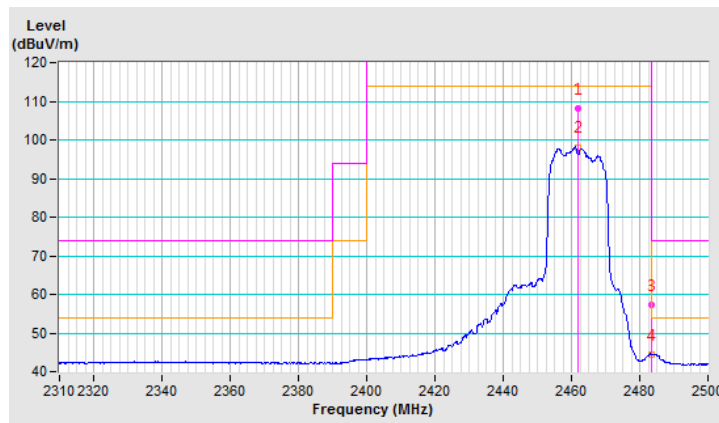

802.11n (20MHz)

CHANNEL	TX Channel 1	DETECTOR FUNCTION	Peak (PK)
FREQUENCY RANGE	1GHz ~ 25GHz		Average (AV)

ANTENNA POLARITY & TEST DISTANCE: HORIZONTAL AT 3 M

NO.	FREQ. (MHz)	EMISSION LEVEL (dBuV/m)	LIMIT (dBuV/m)	MARGIN (dB)	ANTENNA HEIGHT (m)	TABLE ANGLE (Degree)	RAW VALUE (dBuV)	CORRECTION FACTOR (dB/m)
1	2390.00	55.0 PK	74.0	-19.0	1.04 H	53	57.2	-2.2
2	2390.00	41.5 AV	54.0	-12.5	1.04 H	53	43.7	-2.2
3	*2412.00	109.7 PK			1.04 H	53	112.0	-2.3
4	*2412.00	99.5 AV			1.04 H	53	101.8	-2.3

REMARKS:

1. Emission Level(dBuV/m) = Raw Value(dBuV) + Correction Factor(dB/m)
2. Correction Factor(dB/m) = Antenna Factor(dB/m) + Cable Factor(dB) – Pre-Amplifier Factor(dB)
3. The other emission levels were very low against the limit.
4. Margin value = Emission Level – Limit value
5. " * ": Fundamental frequency.

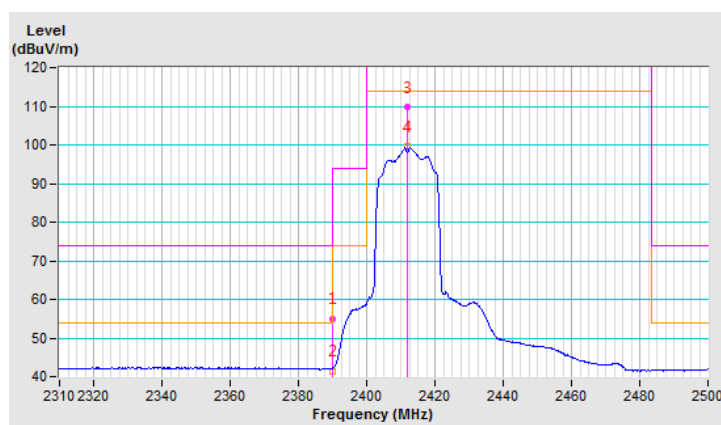

CHANNEL	TX Channel 1	DETECTOR FUNCTION	Peak (PK)
FREQUENCY RANGE	1GHz ~ 25GHz		Average (AV)

ANTENNA POLARITY & TEST DISTANCE: VERTICAL AT 3 M								
NO.	FREQ. (MHz)	EMISSION LEVEL (dBuV/m)	LIMIT (dBuV/m)	MARGIN (dB)	ANTENNA HEIGHT (m)	TABLE ANGLE (Degree)	RAW VALUE (dBuV)	CORRECTION FACTOR (dB/m)
1	2390.00	55.2 PK	74.0	-18.8	2.43 V	100	57.4	-2.2
2	2390.00	41.3 AV	54.0	-12.7	2.43 V	100	43.5	-2.2
3	*2412.00	110.6 PK			2.43 V	100	112.9	-2.3
4	*2412.00	100.4 AV			2.43 V	100	102.7	-2.3

REMARKS:

1. Emission Level(dBuV/m) = Raw Value(dBuV) + Correction Factor(dB/m)
2. Correction Factor(dB/m) = Antenna Factor(dB/m) + Cable Factor(dB) – Pre-Amplifier Factor(dB)
3. The other emission levels were very low against the limit.
4. Margin value = Emission Level – Limit value
5. " * ": Fundamental frequency.

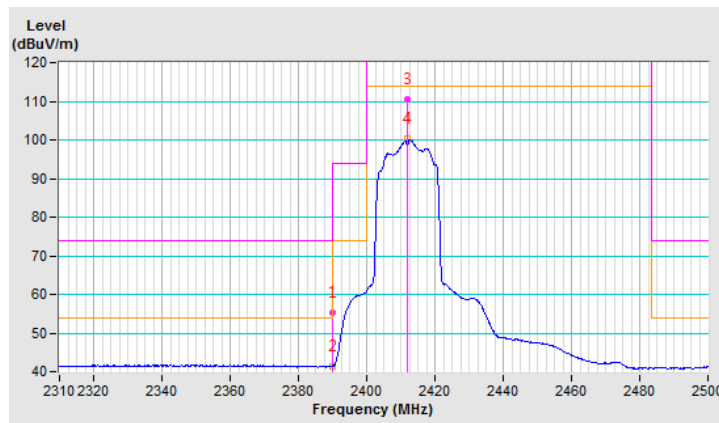

CHANNEL	TX Channel 6	DETECTOR FUNCTION	Peak (PK)
FREQUENCY RANGE	1GHz ~ 25GHz		Average (AV)

ANTENNA POLARITY & TEST DISTANCE: HORIZONTAL AT 3 M

NO.	FREQ. (MHz)	EMISSION LEVEL (dBuV/m)	LIMIT (dBuV/m)	MARGIN (dB)	ANTENNA HEIGHT (m)	TABLE ANGLE (Degree)	RAW VALUE (dBuV)	CORRECTION FACTOR (dB/m)
1	2390.00	55.0 PK	74.0	-19.0	1.04 H	51	57.2	-2.2
2	2390.00	41.2 AV	54.0	-12.8	1.04 H	51	43.4	-2.2
3	*2437.00	108.2 PK			1.04 H	51	110.8	-2.6
4	*2437.00	97.7 AV			1.04 H	51	100.3	-2.6
5	2483.50	54.3 PK	74.0	-19.7	1.04 H	51	56.8	-2.5
6	2483.50	41.1 AV	54.0	-12.9	1.04 H	51	43.6	-2.5

REMARKS:

1. Emission Level(dBuV/m) = Raw Value(dBuV) + Correction Factor(dB/m)
2. Correction Factor(dB/m) = Antenna Factor(dB/m) + Cable Factor(dB) – Pre-Amplifier Factor(dB)
3. The other emission levels were very low against the limit.
4. Margin value = Emission Level – Limit value
5. " * ": Fundamental frequency.

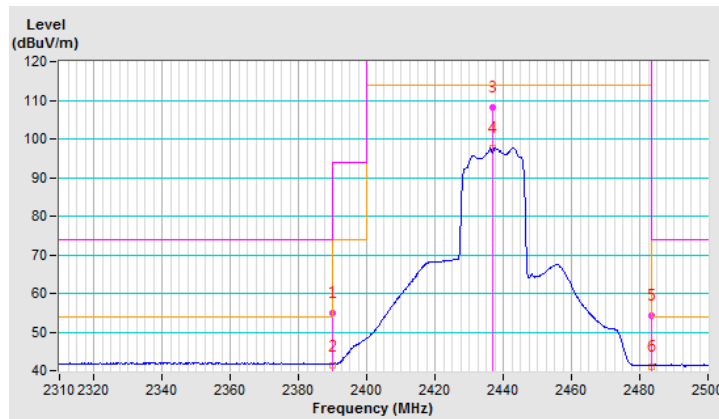

CHANNEL	TX Channel 6	DETECTOR FUNCTION	Peak (PK)
FREQUENCY RANGE	1GHz ~ 25GHz		Average (AV)

ANTENNA POLARITY & TEST DISTANCE: VERTICAL AT 3 M

NO.	FREQ. (MHz)	EMISSION LEVEL (dBuV/m)	LIMIT (dBuV/m)	MARGIN (dB)	ANTENNA HEIGHT (m)	TABLE ANGLE (Degree)	RAW VALUE (dBuV)	CORRECTION FACTOR (dB/m)
1	2390.00	54.5 PK	74.0	-19.5	2.35 V	85	56.7	-2.2
2	2390.00	41.3 AV	54.0	-12.7	2.35 V	85	43.5	-2.2
3	*2437.00	109.2 PK			2.35 V	85	111.8	-2.6
4	*2437.00	98.0 AV			2.35 V	85	100.6	-2.6
5	2483.50	55.0 PK	74.0	-19.0	2.35 V	85	57.5	-2.5
6	2483.50	41.1 AV	54.0	-12.9	2.35 V	85	43.6	-2.5

REMARKS:

1. Emission Level(dBuV/m) = Raw Value(dBuV) + Correction Factor(dB/m)
2. Correction Factor(dB/m) = Antenna Factor(dB/m) + Cable Factor(dB) – Pre-Amplifier Factor(dB)
3. The other emission levels were very low against the limit.
4. Margin value = Emission Level – Limit value
5. " * ": Fundamental frequency.

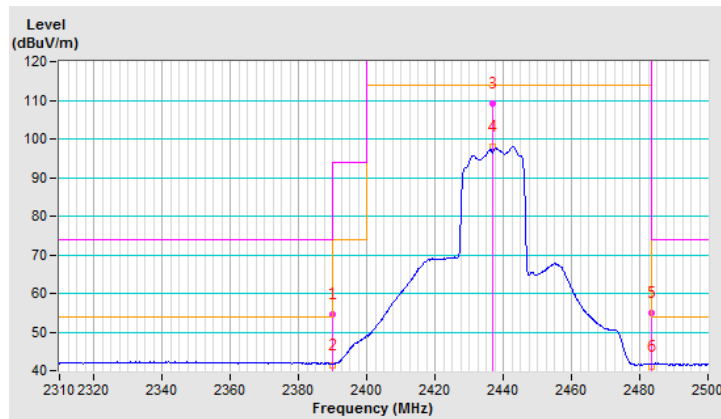

CHANNEL	TX Channel 11	DETECTOR FUNCTION	Peak (PK)
FREQUENCY RANGE	1GHz ~ 25GHz		Average (AV)

ANTENNA POLARITY & TEST DISTANCE: HORIZONTAL AT 3 M

NO.	FREQ. (MHz)	EMISSION LEVEL (dBuV/m)	LIMIT (dBuV/m)	MARGIN (dB)	ANTENNA HEIGHT (m)	TABLE ANGLE (Degree)	RAW VALUE (dBuV)	CORRECTION FACTOR (dB/m)
1	*2462.00	109.3 PK			1.19 H	50	111.8	-2.5
2	*2462.00	99.4 AV			1.19 H	50	101.9	-2.5
3	2483.50	57.5 PK	74.0	-16.5	1.19 H	50	60.0	-2.5
4	2483.50	43.9 AV	54.0	-10.1	1.19 H	50	46.4	-2.5

REMARKS:

1. Emission Level(dBuV/m) = Raw Value(dBuV) + Correction Factor(dB/m)
2. Correction Factor(dB/m) = Antenna Factor(dB/m) + Cable Factor(dB) – Pre-Amplifier Factor(dB)
3. The other emission levels were very low against the limit.
4. Margin value = Emission Level – Limit value
5. " * ": Fundamental frequency.

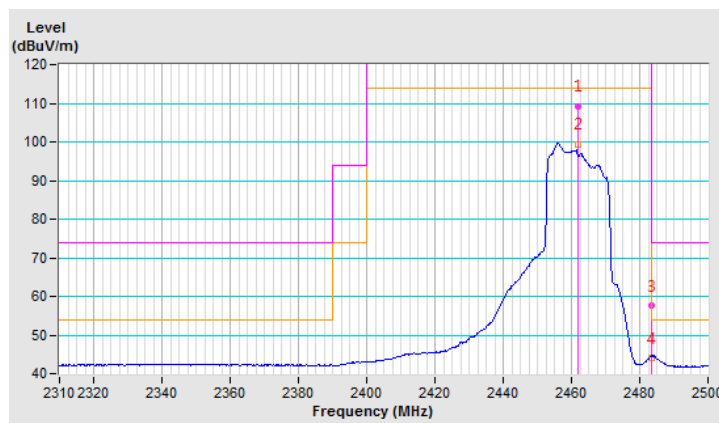

CHANNEL	TX Channel 11	DETECTOR FUNCTION	Peak (PK)
FREQUENCY RANGE	1GHz ~ 25GHz		Average (AV)

ANTENNA POLARITY & TEST DISTANCE: VERTICAL AT 3 M

NO.	FREQ. (MHz)	EMISSION LEVEL (dBuV/m)	LIMIT (dBuV/m)	MARGIN (dB)	ANTENNA HEIGHT (m)	TABLE ANGLE (Degree)	RAW VALUE (dBuV)	CORRECTION FACTOR (dB/m)
1	*2462.00	109.2 PK			2.50 V	103	111.7	-2.5
2	*2462.00	98.8 AV			2.50 V	103	101.3	-2.5
3	2483.50	58.4 PK	74.0	-15.6	2.50 V	103	60.9	-2.5
4	2483.50	44.8 AV	54.0	-9.2	2.50 V	103	47.3	-2.5

REMARKS:

1. Emission Level(dBuV/m) = Raw Value(dBuV) + Correction Factor(dB/m)
2. Correction Factor(dB/m) = Antenna Factor(dB/m) + Cable Factor(dB) – Pre-Amplifier Factor(dB)
3. The other emission levels were very low against the limit.
4. Margin value = Emission Level – Limit value
5. " * ": Fundamental frequency.

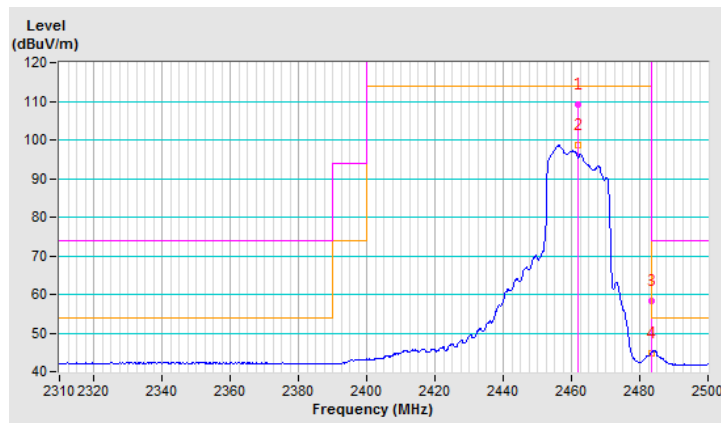

802.11n (40MHz)

CHANNEL	TX Channel 3	DETECTOR FUNCTION	Peak (PK)
FREQUENCY RANGE	1GHz ~ 25GHz		Average (AV)

ANTENNA POLARITY & TEST DISTANCE: HORIZONTAL AT 3 M

NO.	FREQ. (MHz)	EMISSION LEVEL (dBuV/m)	LIMIT (dBuV/m)	MARGIN (dB)	ANTENNA HEIGHT (m)	TABLE ANGLE (Degree)	RAW VALUE (dBuV)	CORRECTION FACTOR (dB/m)
1	2390.00	54.7 PK	74.0	-19.3	1.03 H	54	56.9	-2.2
2	2390.00	41.2 AV	54.0	-12.8	1.03 H	54	43.4	-2.2
3	*2422.00	104.7 PK			1.03 H	54	107.2	-2.5
4	*2422.00	94.2 AV			1.03 H	54	96.7	-2.5

REMARKS:

1. Emission Level(dBuV/m) = Raw Value(dBuV) + Correction Factor(dB/m)
2. Correction Factor(dB/m) = Antenna Factor(dB/m) + Cable Factor(dB) – Pre-Amplifier Factor(dB)
3. The other emission levels were very low against the limit.
4. Margin value = Emission Level – Limit value
5. " * ": Fundamental frequency.

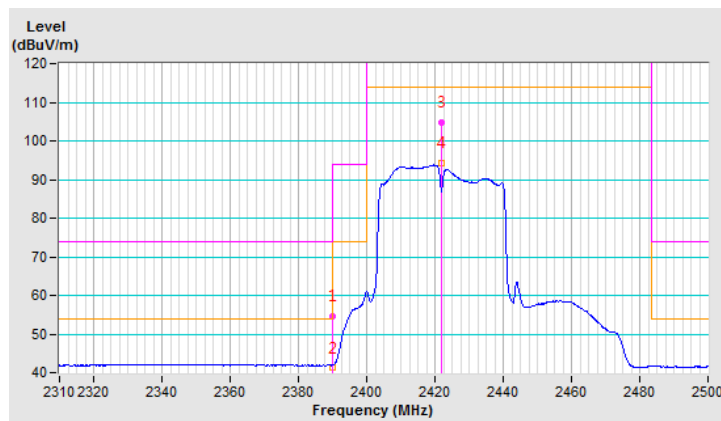

CHANNEL	TX Channel 3	DETECTOR FUNCTION	Peak (PK)
FREQUENCY RANGE	1GHz ~ 25GHz		Average (AV)

ANTENNA POLARITY & TEST DISTANCE: VERTICAL AT 3 M								
NO.	FREQ. (MHz)	EMISSION LEVEL (dBuV/m)	LIMIT (dBuV/m)	MARGIN (dB)	ANTENNA HEIGHT (m)	TABLE ANGLE (Degree)	RAW VALUE (dBuV)	CORRECTION FACTOR (dB/m)
1	2390.00	55.0 PK	74.0	-19.0	2.51 V	84	57.2	-2.2
2	2390.00	41.6 AV	54.0	-12.4	2.51 V	84	43.8	-2.2
3	*2422.00	105.7 PK			2.51 V	84	108.2	-2.5
4	*2422.00	95.2 AV			2.51 V	84	97.7	-2.5

REMARKS:

1. Emission Level(dBuV/m) = Raw Value(dBuV) + Correction Factor(dB/m)
2. Correction Factor(dB/m) = Antenna Factor(dB/m) + Cable Factor(dB) – Pre-Amplifier Factor(dB)
3. The other emission levels were very low against the limit.
4. Margin value = Emission Level – Limit value
5. " * ": Fundamental frequency.

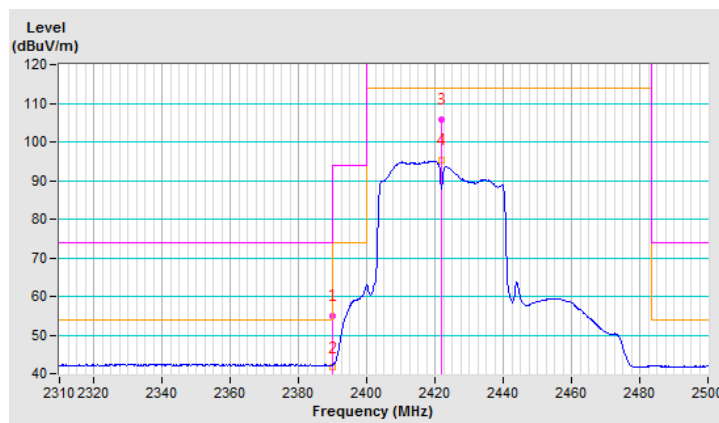

CHANNEL	TX Channel 6	DETECTOR FUNCTION	Peak (PK)
FREQUENCY RANGE	1GHz ~ 25GHz		Average (AV)

ANTENNA POLARITY & TEST DISTANCE: HORIZONTAL AT 3 M

NO.	FREQ. (MHz)	EMISSION LEVEL (dBuV/m)	LIMIT (dBuV/m)	MARGIN (dB)	ANTENNA HEIGHT (m)	TABLE ANGLE (Degree)	RAW VALUE (dBuV)	CORRECTION FACTOR (dB/m)
1	2390.00	55.4 PK	74.0	-18.6	1.29 H	52	57.6	-2.2
2	2390.00	41.6 AV	54.0	-12.4	1.29 H	52	43.8	-2.2
3	*2437.00	105.3 PK			1.29 H	52	107.9	-2.6
4	*2437.00	94.7 AV			1.29 H	52	97.3	-2.6
5	2483.50	55.3 PK	74.0	-18.7	1.29 H	52	57.8	-2.5
6	2483.50	42.6 AV	54.0	-11.4	1.29 H	52	45.1	-2.5

REMARKS:

1. Emission Level(dBuV/m) = Raw Value(dBuV) + Correction Factor(dB/m)
2. Correction Factor(dB/m) = Antenna Factor(dB/m) + Cable Factor(dB) – Pre-Amplifier Factor(dB)
3. The other emission levels were very low against the limit.
4. Margin value = Emission Level – Limit value
5. " * " : Fundamental frequency.

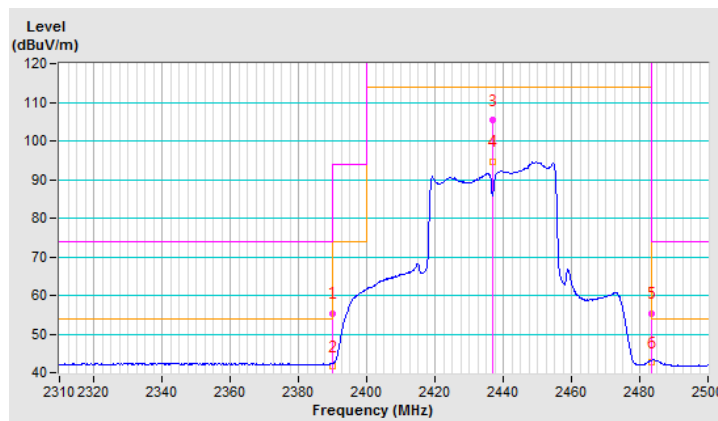

CHANNEL	TX Channel 6	DETECTOR FUNCTION	Peak (PK)
FREQUENCY RANGE	1GHz ~ 25GHz		Average (AV)

ANTENNA POLARITY & TEST DISTANCE: VERTICAL AT 3 M

NO.	FREQ. (MHz)	EMISSION LEVEL (dBuV/m)	LIMIT (dBuV/m)	MARGIN (dB)	ANTENNA HEIGHT (m)	TABLE ANGLE (Degree)	RAW VALUE (dBuV)	CORRECTION FACTOR (dB/m)
1	2390.00	54.8 PK	74.0	-19.2	2.63 V	92	57.0	-2.2
2	2390.00	41.4 AV	54.0	-12.6	2.63 V	92	43.6	-2.2
3	*2437.00	105.8 PK			2.63 V	92	108.4	-2.6
4	*2437.00	94.5 AV			2.63 V	92	97.1	-2.6
5	2483.50	55.5 PK	74.0	-18.5	2.63 V	92	58.0	-2.5
6	2483.50	42.6 AV	54.0	-11.4	2.63 V	92	45.1	-2.5

REMARKS:

1. Emission Level(dBuV/m) = Raw Value(dBuV) + Correction Factor(dB/m)
2. Correction Factor(dB/m) = Antenna Factor(dB/m) + Cable Factor(dB) – Pre-Amplifier Factor(dB)
3. The other emission levels were very low against the limit.
4. Margin value = Emission Level – Limit value
5. " * " : Fundamental frequency.

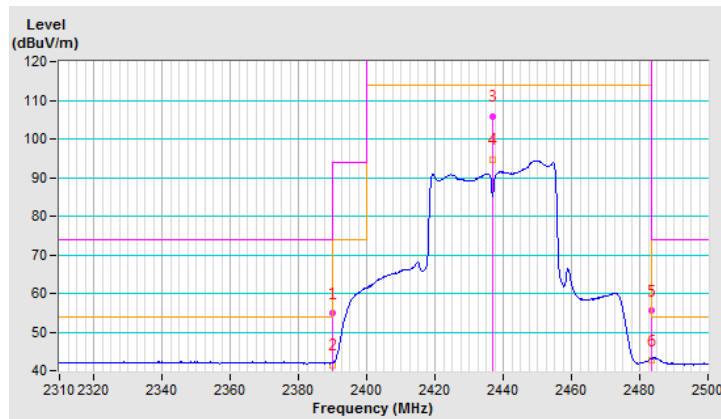

CHANNEL	TX Channel 9	DETECTOR FUNCTION	Peak (PK)
FREQUENCY RANGE	1GHz ~ 25GHz		Average (AV)

ANTENNA POLARITY & TEST DISTANCE: HORIZONTAL AT 3 M

NO.	FREQ. (MHz)	EMISSION LEVEL (dBuV/m)	LIMIT (dBuV/m)	MARGIN (dB)	ANTENNA HEIGHT (m)	TABLE ANGLE (Degree)	RAW VALUE (dBuV)	CORRECTION FACTOR (dB/m)
1	*2452.00	106.7 PK			1.39 H	49	109.3	-2.6
2	*2452.00	95.9 AV			1.39 H	49	98.5	-2.6
3	2483.50	59.1 PK	74.0	-14.9	1.39 H	49	61.6	-2.5
4	2483.50	43.1 AV	54.0	-10.9	1.39 H	49	45.6	-2.5

REMARKS:

1. Emission Level(dBuV/m) = Raw Value(dBuV) + Correction Factor(dB/m)
2. Correction Factor(dB/m) = Antenna Factor(dB/m) + Cable Factor(dB) – Pre-Amplifier Factor(dB)
3. The other emission levels were very low against the limit.
4. Margin value = Emission Level – Limit value
5. " * ": Fundamental frequency.

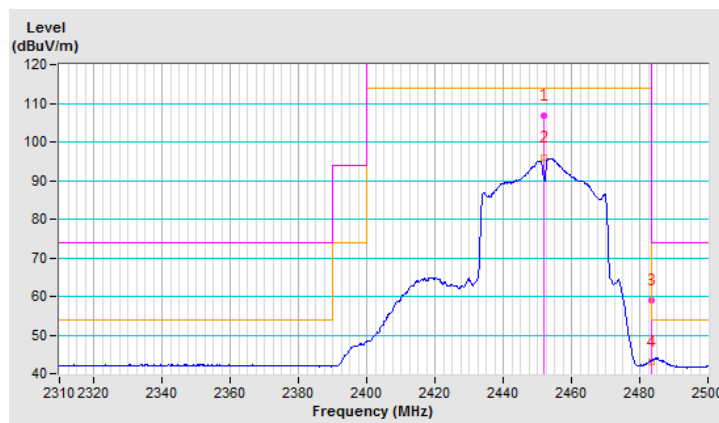

CHANNEL	TX Channel 9	DETECTOR FUNCTION	Peak (PK)
FREQUENCY RANGE	1GHz ~ 25GHz		Average (AV)

ANTENNA POLARITY & TEST DISTANCE: VERTICAL AT 3 M

NO.	FREQ. (MHz)	EMISSION LEVEL (dBuV/m)	LIMIT (dBuV/m)	MARGIN (dB)	ANTENNA HEIGHT (m)	TABLE ANGLE (Degree)	RAW VALUE (dBuV)	CORRECTION FACTOR (dB/m)
1	*2452.00	106.6 PK			2.44 V	92	109.2	-2.6
2	*2452.00	96.1 AV			2.44 V	92	98.7	-2.6
3	2483.50	60.7 PK	74.0	-13.3	2.44 V	92	63.2	-2.5
4	2483.50	43.8 AV	54.0	-10.2	2.44 V	92	46.3	-2.5

REMARKS:

1. Emission Level(dBuV/m) = Raw Value(dBuV) + Correction Factor(dB/m)
2. Correction Factor(dB/m) = Antenna Factor(dB/m) + Cable Factor(dB) – Pre-Amplifier Factor(dB)
3. The other emission levels were very low against the limit.
4. Margin value = Emission Level – Limit value
5. " * ": Fundamental frequency.

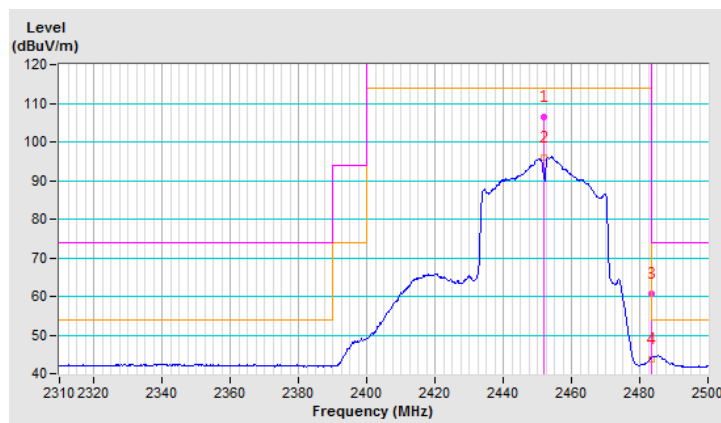

2TX

802.11n (20MHz)

CHANNEL	TX Channel 1	DETECTOR FUNCTION	Peak (PK)
FREQUENCY RANGE	1GHz ~ 25GHz		Average (AV)

ANTENNA POLARITY & TEST DISTANCE: HORIZONTAL AT 3 M

NO.	FREQ. (MHz)	EMISSION LEVEL (dBuV/m)	LIMIT (dBuV/m)	MARGIN (dB)	ANTENNA HEIGHT (m)	TABLE ANGLE (Degree)	RAW VALUE (dBuV)	CORRECTION FACTOR (dB/m)
1	2390.00	55.1 PK	74.0	-18.9	2.47 H	48	57.3	-2.2
2	2390.00	41.7 AV	54.0	-12.3	2.47 H	48	43.9	-2.2
3	*2412.00	110.1 PK			2.47 H	48	112.4	-2.3
4	*2412.00	100.4 AV			2.47 H	48	102.7	-2.3

REMARKS:

1. Emission Level(dBuV/m) = Raw Value(dBuV) + Correction Factor(dB/m)
2. Correction Factor(dB/m) = Antenna Factor(dB/m) + Cable Factor(dB) – Pre-Amplifier Factor(dB)
3. The other emission levels were very low against the limit.
4. Margin value = Emission Level – Limit value
5. " * ": Fundamental frequency.

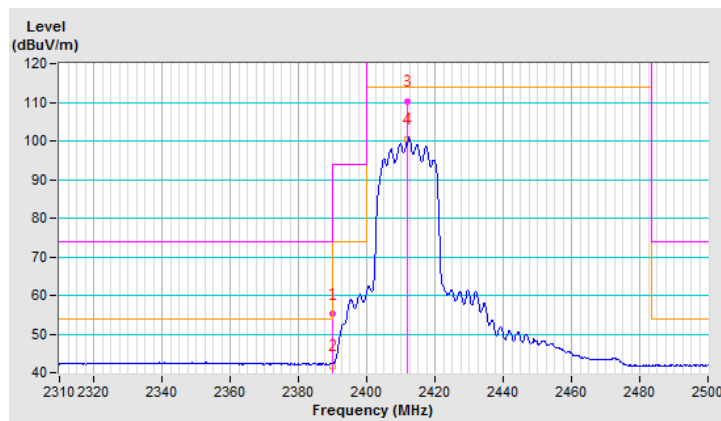

CHANNEL	TX Channel 1	DETECTOR FUNCTION	Peak (PK)
FREQUENCY RANGE	1GHz ~ 25GHz		Average (AV)

ANTENNA POLARITY & TEST DISTANCE: VERTICAL AT 3 M

NO.	FREQ. (MHz)	EMISSION LEVEL (dBuV/m)	LIMIT (dBuV/m)	MARGIN (dB)	ANTENNA HEIGHT (m)	TABLE ANGLE (Degree)	RAW VALUE (dBuV)	CORRECTION FACTOR (dB/m)
1	2390.00	54.5 PK	74.0	-19.5	1.42 V	43	56.7	-2.2
2	2390.00	41.5 AV	54.0	-12.5	1.42 V	43	43.7	-2.2
3	*2412.00	110.8 PK			1.42 V	43	113.1	-2.3
4	*2412.00	100.3 AV			1.42 V	43	102.6	-2.3

REMARKS:

1. Emission Level(dBuV/m) = Raw Value(dBuV) + Correction Factor(dB/m)
2. Correction Factor(dB/m) = Antenna Factor(dB/m) + Cable Factor(dB) – Pre-Amplifier Factor(dB)
3. The other emission levels were very low against the limit.
4. Margin value = Emission Level – Limit value
5. " * ": Fundamental frequency.

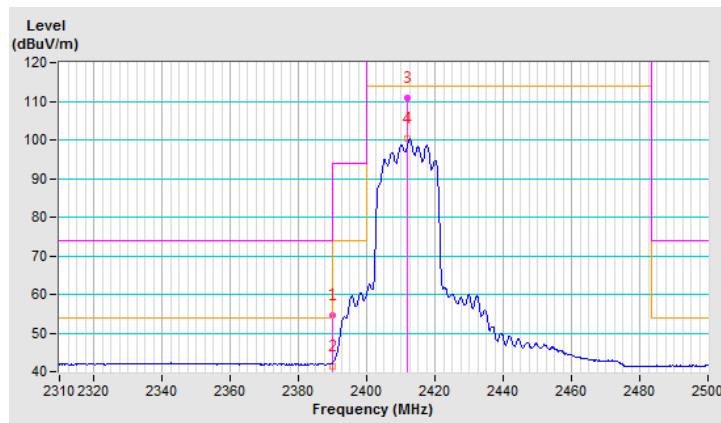

CHANNEL	TX Channel 6	DETECTOR FUNCTION	Peak (PK)
FREQUENCY RANGE	1GHz ~ 25GHz		Average (AV)

ANTENNA POLARITY & TEST DISTANCE: HORIZONTAL AT 3 M

NO.	FREQ. (MHz)	EMISSION LEVEL (dBuV/m)	LIMIT (dBuV/m)	MARGIN (dB)	ANTENNA HEIGHT (m)	TABLE ANGLE (Degree)	RAW VALUE (dBuV)	CORRECTION FACTOR (dB/m)
1	2390.00	55.4 PK	74.0	-18.6	2.58 H	42	57.6	-2.2
2	2390.00	41.5 AV	54.0	-12.5	2.58 H	42	43.7	-2.2
3	*2437.00	109.2 PK			2.58 H	42	111.8	-2.6
4	*2437.00	98.5 AV			2.58 H	42	101.1	-2.6
5	2483.50	54.5 PK	74.0	-19.5	2.58 H	42	57.0	-2.5
6	2483.50	41.4 AV	54.0	-12.6	2.58 H	42	43.9	-2.5

REMARKS:

1. Emission Level(dBuV/m) = Raw Value(dBuV) + Correction Factor(dB/m)
2. Correction Factor(dB/m) = Antenna Factor(dB/m) + Cable Factor(dB) – Pre-Amplifier Factor(dB)
3. The other emission levels were very low against the limit.
4. Margin value = Emission Level – Limit value
5. " * ": Fundamental frequency.

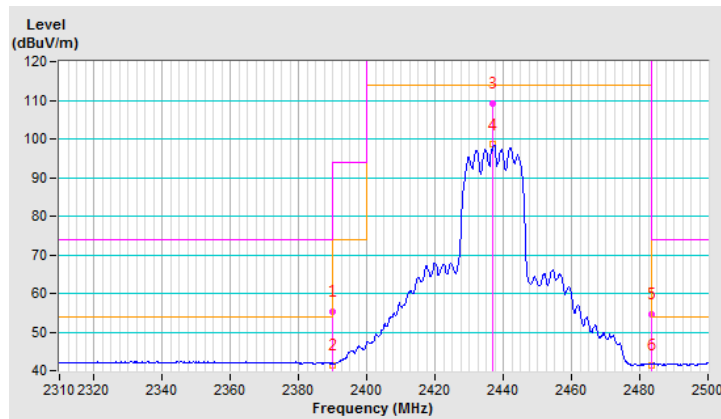

CHANNEL	TX Channel 6	DETECTOR FUNCTION	Peak (PK)
FREQUENCY RANGE	1GHz ~ 25GHz		Average (AV)

ANTENNA POLARITY & TEST DISTANCE: VERTICAL AT 3 M

NO.	FREQ. (MHz)	EMISSION LEVEL (dBuV/m)	LIMIT (dBuV/m)	MARGIN (dB)	ANTENNA HEIGHT (m)	TABLE ANGLE (Degree)	RAW VALUE (dBuV)	CORRECTION FACTOR (dB/m)
1	2390.00	54.6 PK	74.0	-19.4	1.02 V	42	56.8	-2.2
2	2390.00	41.7 AV	54.0	-12.3	1.02 V	42	43.9	-2.2
3	*2437.00	108.9 PK			1.02 V	42	111.5	-2.6
4	*2437.00	98.2 AV			1.02 V	42	100.8	-2.6
5	2483.50	55.0 PK	74.0	-19.0	1.02 V	42	57.5	-2.5
6	2483.50	41.3 AV	54.0	-12.7	1.02 V	42	43.8	-2.5

REMARKS:

1. Emission Level(dBuV/m) = Raw Value(dBuV) + Correction Factor(dB/m)
2. Correction Factor(dB/m) = Antenna Factor(dB/m) + Cable Factor(dB) – Pre-Amplifier Factor(dB)
3. The other emission levels were very low against the limit.
4. Margin value = Emission Level – Limit value
5. " * ": Fundamental frequency.

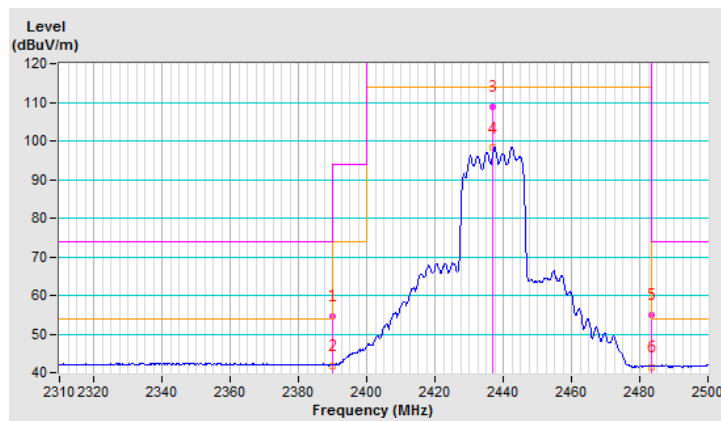

CHANNEL	TX Channel 11	DETECTOR FUNCTION	Peak (PK)
FREQUENCY RANGE	1GHz ~ 25GHz		Average (AV)

ANTENNA POLARITY & TEST DISTANCE: HORIZONTAL AT 3 M

NO.	FREQ. (MHz)	EMISSION LEVEL (dBuV/m)	LIMIT (dBuV/m)	MARGIN (dB)	ANTENNA HEIGHT (m)	TABLE ANGLE (Degree)	RAW VALUE (dBuV)	CORRECTION FACTOR (dB/m)
1	*2462.00	110.4 PK			2.44 H	48	112.9	-2.5
2	*2462.00	99.1 AV			2.44 H	48	101.6	-2.5
3	2483.50	59.7 PK	74.0	-14.3	2.44 H	48	62.2	-2.5
4	2483.50	44.7 AV	54.0	-9.3	2.44 H	48	47.2	-2.5

REMARKS:

1. Emission Level(dBuV/m) = Raw Value(dBuV) + Correction Factor(dB/m)
2. Correction Factor(dB/m) = Antenna Factor(dB/m) + Cable Factor(dB) – Pre-Amplifier Factor(dB)
3. The other emission levels were very low against the limit.
4. Margin value = Emission Level – Limit value
5. " * ": Fundamental frequency.

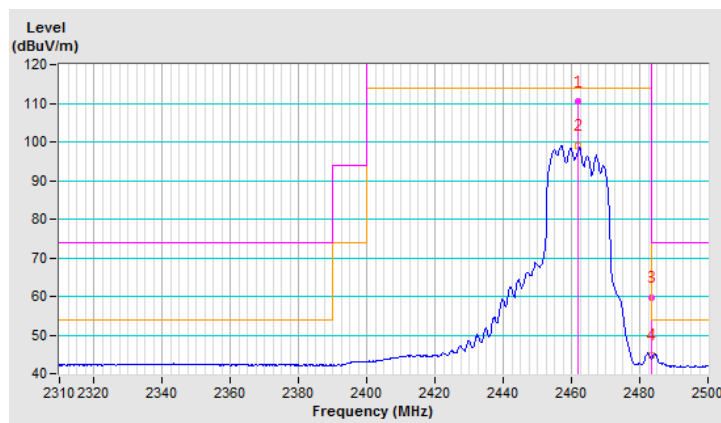

CHANNEL	TX Channel 11	DETECTOR FUNCTION	Peak (PK)
FREQUENCY RANGE	1GHz ~ 25GHz		Average (AV)

ANTENNA POLARITY & TEST DISTANCE: VERTICAL AT 3 M

NO.	FREQ. (MHz)	EMISSION LEVEL (dBuV/m)	LIMIT (dBuV/m)	MARGIN (dB)	ANTENNA HEIGHT (m)	TABLE ANGLE (Degree)	RAW VALUE (dBuV)	CORRECTION FACTOR (dB/m)
1	*2462.00	108.3 PK			2.55 V	47	110.8	-2.5
2	*2462.00	97.9 AV			2.55 V	47	100.4	-2.5
3	2483.50	57.8 PK	74.0	-16.2	2.55 V	47	60.3	-2.5
4	2483.50	43.6 AV	54.0	-10.4	2.55 V	47	46.1	-2.5

REMARKS:

1. Emission Level(dBuV/m) = Raw Value(dBuV) + Correction Factor(dB/m)
2. Correction Factor(dB/m) = Antenna Factor(dB/m) + Cable Factor(dB) – Pre-Amplifier Factor(dB)
3. The other emission levels were very low against the limit.
4. Margin value = Emission Level – Limit value
5. " * ": Fundamental frequency.

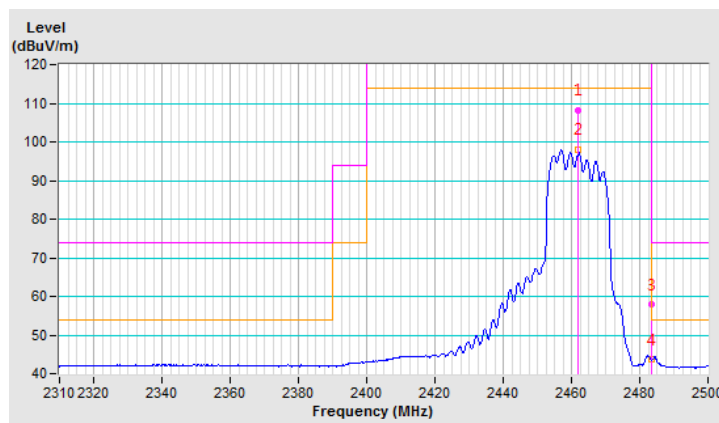

802.11n (40MHz)

CHANNEL	TX Channel 3	DETECTOR FUNCTION	Peak (PK)
FREQUENCY RANGE	1GHz ~ 25GHz		Average (AV)

ANTENNA POLARITY & TEST DISTANCE: HORIZONTAL AT 3 M								
NO.	FREQ. (MHz)	EMISSION LEVEL (dBuV/m)	LIMIT (dBuV/m)	MARGIN (dB)	ANTENNA HEIGHT (m)	TABLE ANGLE (Degree)	RAW VALUE (dBuV)	CORRECTION FACTOR (dB/m)
1	2390.00	54.7 PK	74.0	-19.3	1.45 H	44	56.9	-2.2
2	2390.00	41.4 AV	54.0	-12.6	1.45 H	44	43.6	-2.2
3	*2422.00	106.7 PK			1.45 H	44	109.2	-2.5
4	*2422.00	95.6 AV			1.45 H	44	98.1	-2.5

REMARKS:

1. Emission Level(dBuV/m) = Raw Value(dBuV) + Correction Factor(dB/m)
2. Correction Factor(dB/m) = Antenna Factor(dB/m) + Cable Factor(dB) – Pre-Amplifier Factor(dB)
3. The other emission levels were very low against the limit.
4. Margin value = Emission Level – Limit value
5. " * ": Fundamental frequency.

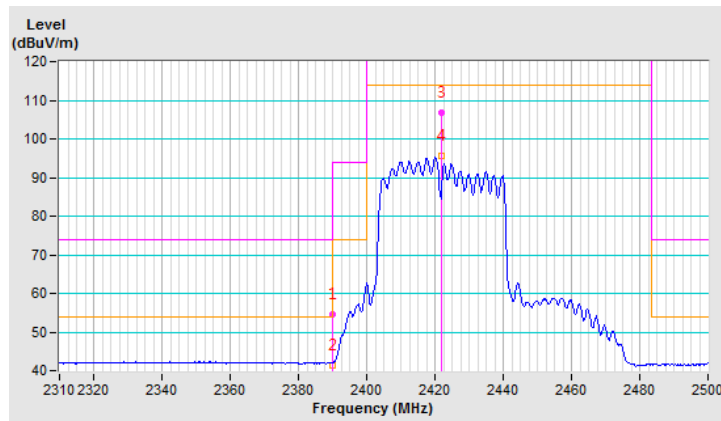

CHANNEL	TX Channel 3	DETECTOR FUNCTION	Peak (PK)
FREQUENCY RANGE	1GHz ~ 25GHz		Average (AV)

ANTENNA POLARITY & TEST DISTANCE: VERTICAL AT 3 M								
NO.	FREQ. (MHz)	EMISSION LEVEL (dBuV/m)	LIMIT (dBuV/m)	MARGIN (dB)	ANTENNA HEIGHT (m)	TABLE ANGLE (Degree)	RAW VALUE (dBuV)	CORRECTION FACTOR (dB/m)
1	2390.00	55.0 PK	74.0	-19.0	2.58 V	74	57.2	-2.2
2	2390.00	41.5 AV	54.0	-12.5	2.58 V	74	43.7	-2.2
3	*2422.00	106.1 PK			2.58 V	74	108.6	-2.5
4	*2422.00	96.2 AV			2.58 V	74	98.7	-2.5

REMARKS:

1. Emission Level(dBuV/m) = Raw Value(dBuV) + Correction Factor(dB/m)
2. Correction Factor(dB/m) = Antenna Factor(dB/m) + Cable Factor(dB) – Pre-Amplifier Factor(dB)
3. The other emission levels were very low against the limit.
4. Margin value = Emission Level – Limit value
5. " * ": Fundamental frequency.

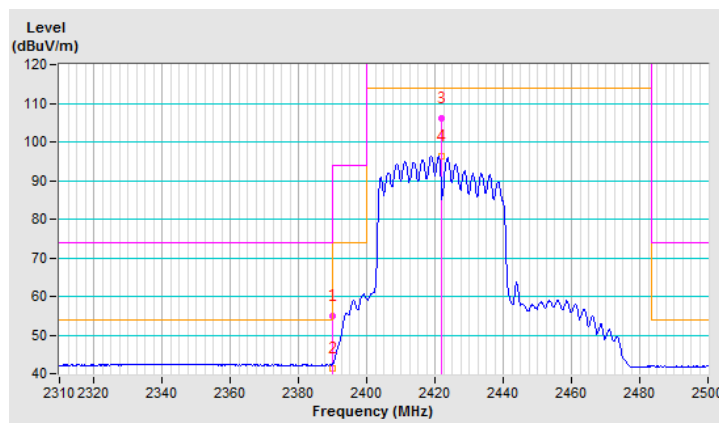

CHANNEL	TX Channel 6	DETECTOR FUNCTION	Peak (PK)
FREQUENCY RANGE	1GHz ~ 25GHz		Average (AV)

ANTENNA POLARITY & TEST DISTANCE: HORIZONTAL AT 3 M

NO.	FREQ. (MHz)	EMISSION LEVEL (dBuV/m)	LIMIT (dBuV/m)	MARGIN (dB)	ANTENNA HEIGHT (m)	TABLE ANGLE (Degree)	RAW VALUE (dBuV)	CORRECTION FACTOR (dB/m)
1	2390.00	54.2 PK	74.0	-19.8	1.50 H	48	56.4	-2.2
2	2390.00	41.1 AV	54.0	-12.9	1.50 H	48	43.3	-2.2
3	*2437.00	105.0 PK			1.50 H	48	107.6	-2.6
4	*2437.00	94.8 AV			1.50 H	48	97.4	-2.6
5	2483.50	54.0 PK	74.0	-20.0	1.50 H	48	56.5	-2.5
6	2483.50	41.9 AV	54.0	-12.1	1.50 H	48	44.4	-2.5

REMARKS:

1. Emission Level(dBuV/m) = Raw Value(dBuV) + Correction Factor(dB/m)
2. Correction Factor(dB/m) = Antenna Factor(dB/m) + Cable Factor(dB) – Pre-Amplifier Factor(dB)
3. The other emission levels were very low against the limit.
4. Margin value = Emission Level – Limit value
5. " * ": Fundamental frequency.

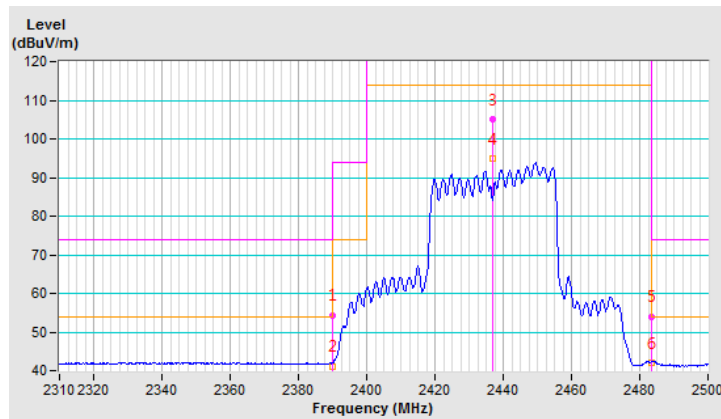

CHANNEL	TX Channel 6	DETECTOR FUNCTION	Peak (PK)
FREQUENCY RANGE	1GHz ~ 25GHz		Average (AV)

ANTENNA POLARITY & TEST DISTANCE: VERTICAL AT 3 M

NO.	FREQ. (MHz)	EMISSION LEVEL (dBuV/m)	LIMIT (dBuV/m)	MARGIN (dB)	ANTENNA HEIGHT (m)	TABLE ANGLE (Degree)	RAW VALUE (dBuV)	CORRECTION FACTOR (dB/m)
1	2390.00	54.2 PK	74.0	-19.8	2.67 V	88	56.4	-2.2
2	2390.00	41.2 AV	54.0	-12.8	2.67 V	88	43.4	-2.2
3	*2437.00	105.6 PK			2.67 V	88	108.2	-2.6
4	*2437.00	95.3 AV			2.67 V	88	97.9	-2.6
5	2483.50	55.6 PK	74.0	-18.4	2.67 V	88	58.1	-2.5
6	2483.50	42.2 AV	54.0	-11.8	2.67 V	88	44.7	-2.5

REMARKS:

1. Emission Level(dBuV/m) = Raw Value(dBuV) + Correction Factor(dB/m)
2. Correction Factor(dB/m) = Antenna Factor(dB/m) + Cable Factor(dB) – Pre-Amplifier Factor(dB)
3. The other emission levels were very low against the limit.
4. Margin value = Emission Level – Limit value
5. " * ": Fundamental frequency.

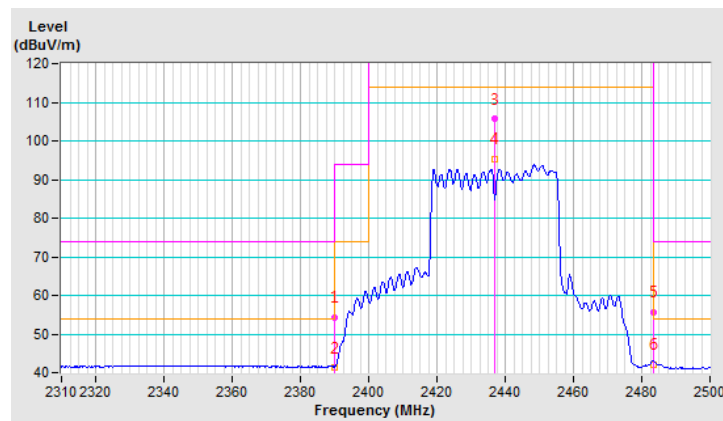

CHANNEL	TX Channel 9	DETECTOR FUNCTION	Peak (PK)
FREQUENCY RANGE	1GHz ~ 25GHz		Average (AV)

ANTENNA POLARITY & TEST DISTANCE: HORIZONTAL AT 3 M

NO.	FREQ. (MHz)	EMISSION LEVEL (dBuV/m)	LIMIT (dBuV/m)	MARGIN (dB)	ANTENNA HEIGHT (m)	TABLE ANGLE (Degree)	RAW VALUE (dBuV)	CORRECTION FACTOR (dB/m)
1	*2452.00	107.8 PK			2.38 H	46	110.4	-2.6
2	*2452.00	96.2 AV			2.38 H	46	98.8	-2.6
3	2483.50	57.8 PK	74.0	-16.2	2.38 H	46	60.3	-2.5
4	2483.50	43.9 AV	54.0	-10.1	2.38 H	46	46.4	-2.5

REMARKS:

1. Emission Level(dBuV/m) = Raw Value(dBuV) + Correction Factor(dB/m)
2. Correction Factor(dB/m) = Antenna Factor(dB/m) + Cable Factor(dB) – Pre-Amplifier Factor(dB)
3. The other emission levels were very low against the limit.
4. Margin value = Emission Level – Limit value
5. " * ": Fundamental frequency.

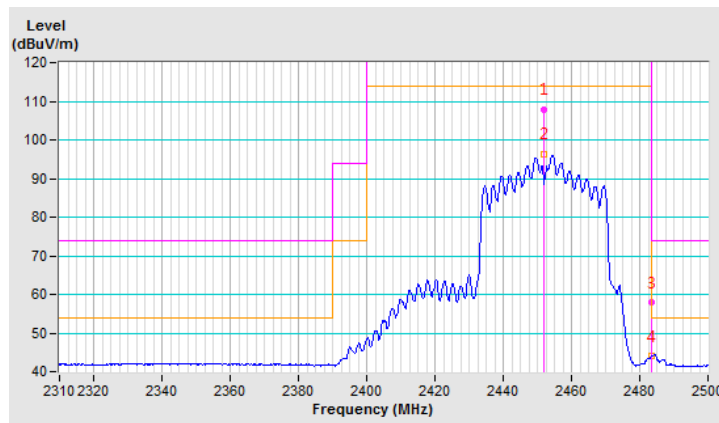

CHANNEL	TX Channel 9	DETECTOR FUNCTION	Peak (PK)
FREQUENCY RANGE	1GHz ~ 25GHz		Average (AV)

ANTENNA POLARITY & TEST DISTANCE: VERTICAL AT 3 M								
NO.	FREQ. (MHz)	EMISSION LEVEL (dBuV/m)	LIMIT (dBuV/m)	MARGIN (dB)	ANTENNA HEIGHT (m)	TABLE ANGLE (Degree)	RAW VALUE (dBuV)	CORRECTION FACTOR (dB/m)
1	*2452.00	109.2 PK			2.93 V	94	111.8	-2.6
2	*2452.00	97.1 AV			2.93 V	94	99.7	-2.6
3	2483.50	58.6 PK	74.0	-15.4	2.93 V	94	61.1	-2.5
4	2483.50	43.7 AV	54.0	-10.3	2.93 V	94	46.2	-2.5

REMARKS:

1. Emission Level(dBuV/m) = Raw Value(dBuV) + Correction Factor(dB/m)
2. Correction Factor(dB/m) = Antenna Factor(dB/m) + Cable Factor(dB) – Pre-Amplifier Factor(dB)
3. The other emission levels were very low against the limit.
4. Margin value = Emission Level – Limit value
5. " * ": Fundamental frequency.

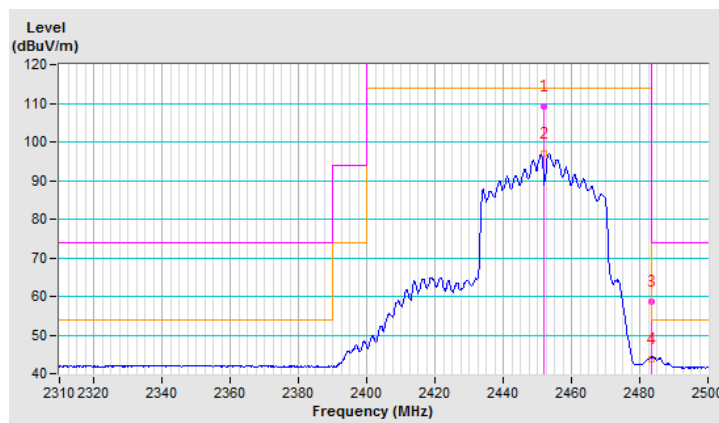

4.7.8 Test Results of Band Edge and Emissions not in Restricted Bands

Below 30dB of the highest emissions level of operating band (in 100kHz Resolution Bandwidth).

802.11b

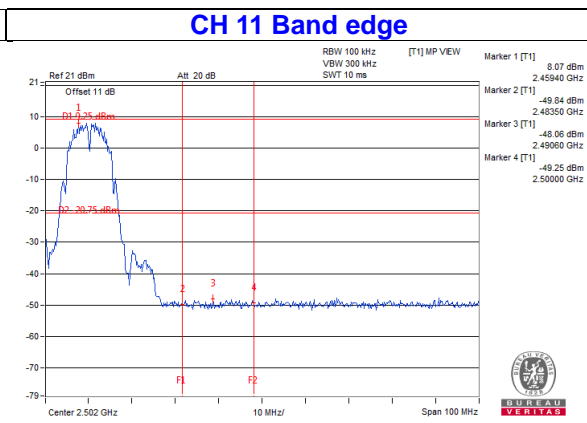
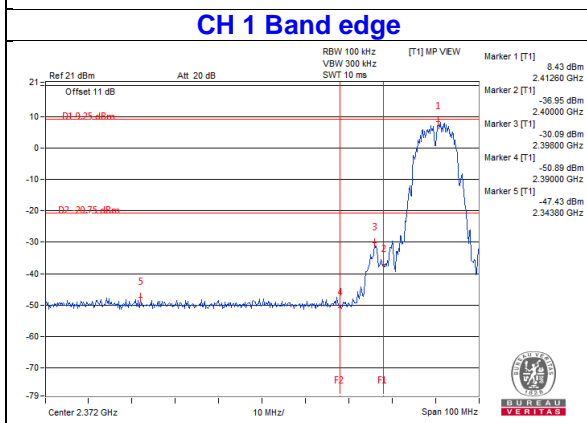
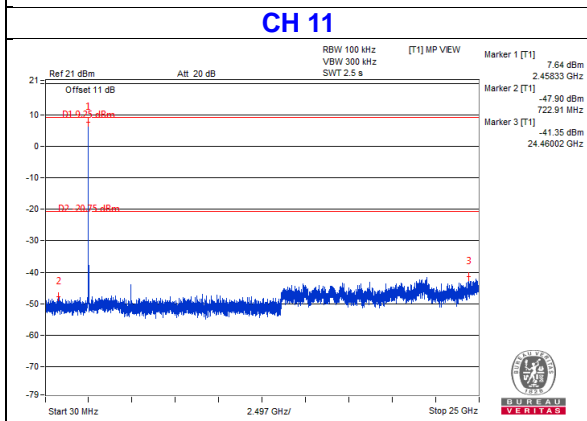
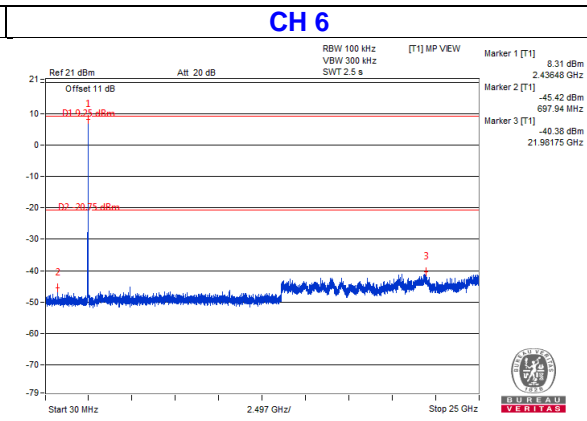
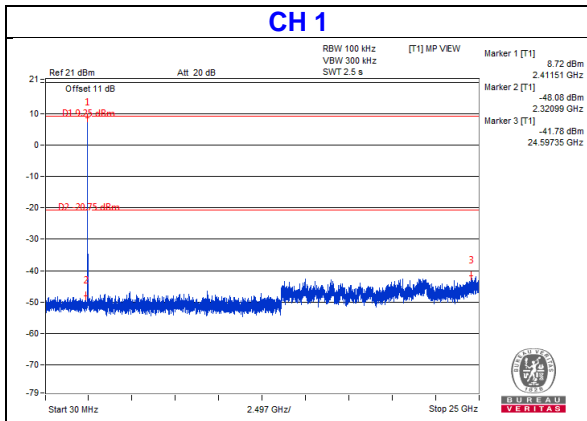
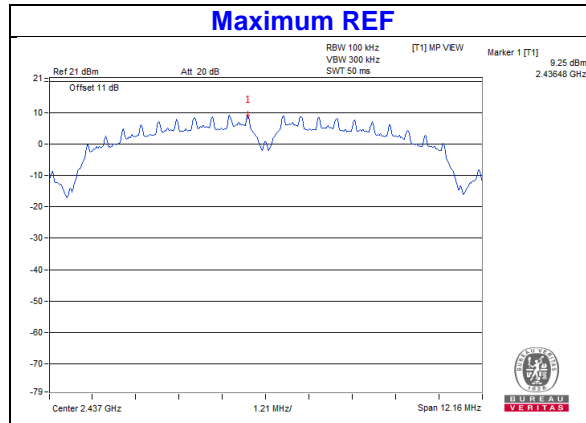

802.11g

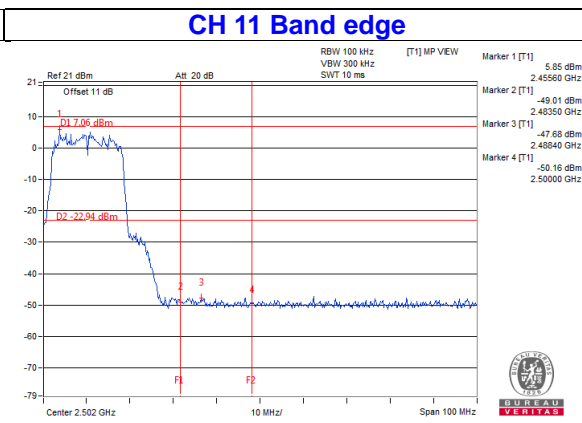
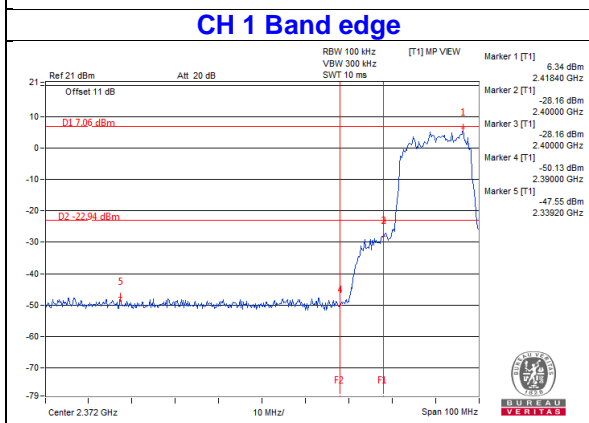
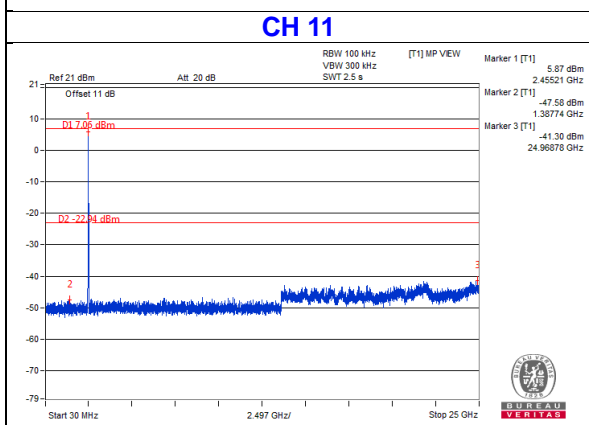
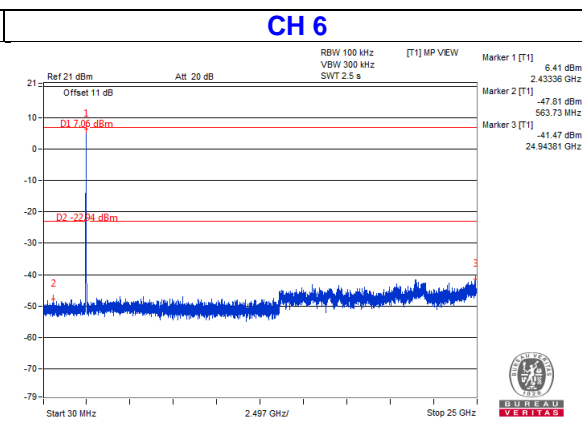
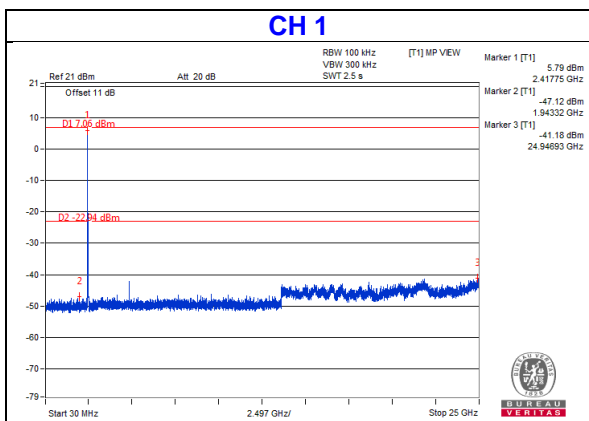
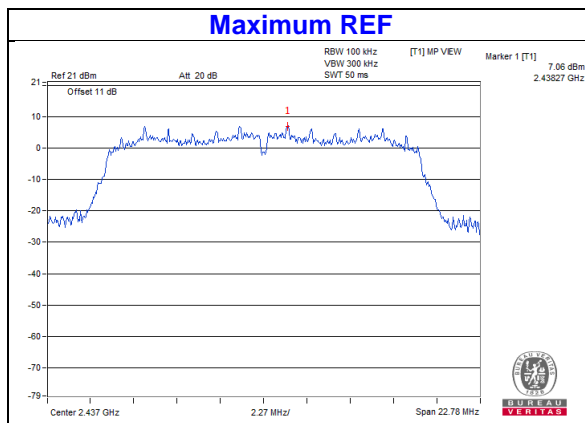

802.11n (20MHz) – 1TX:

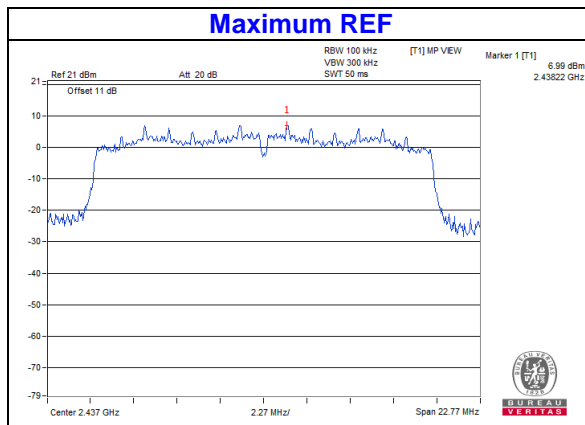

CH 1 **CH 6**

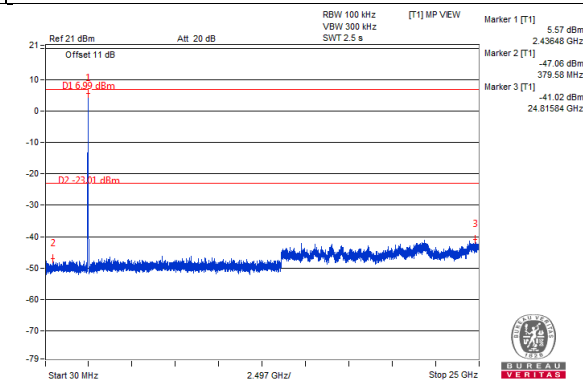
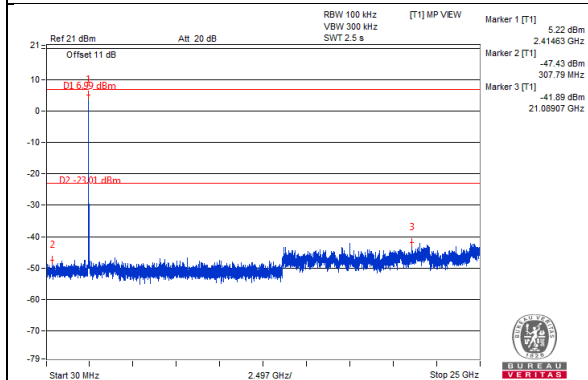

CH 11

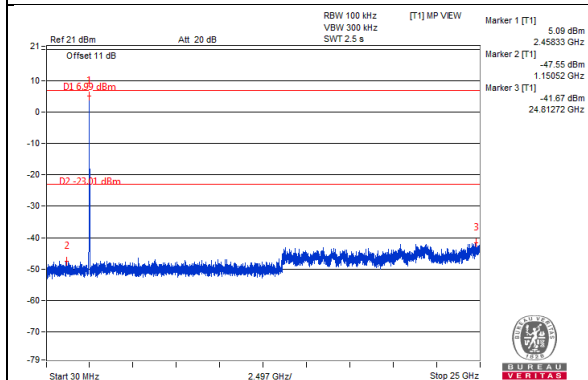

CH 1 Band edge **CH 11 Band edge**

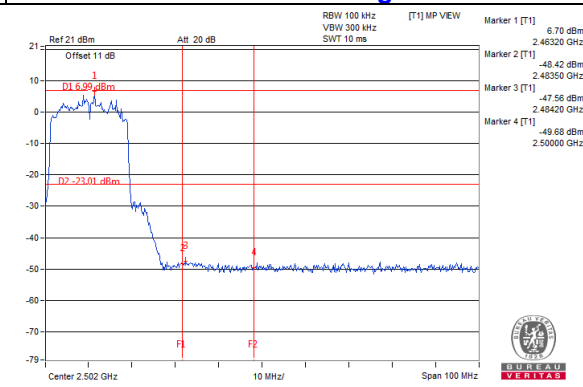
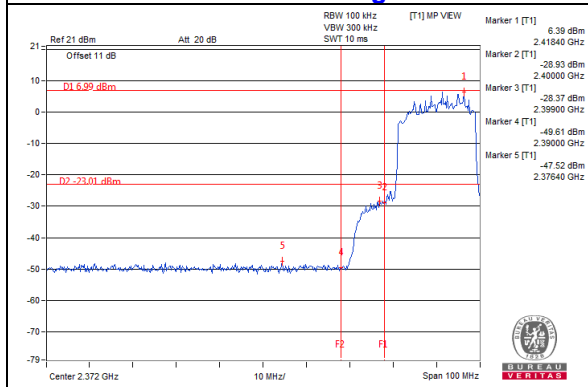

802.11n (20MHz) – 2TX:
Chain 1

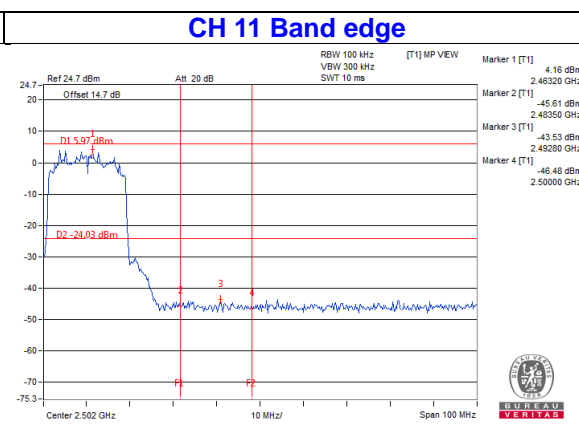
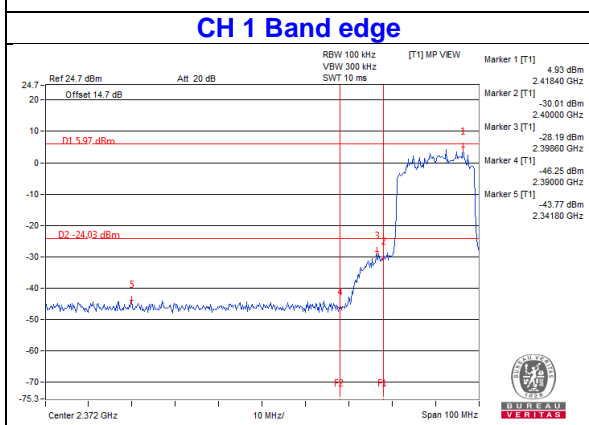
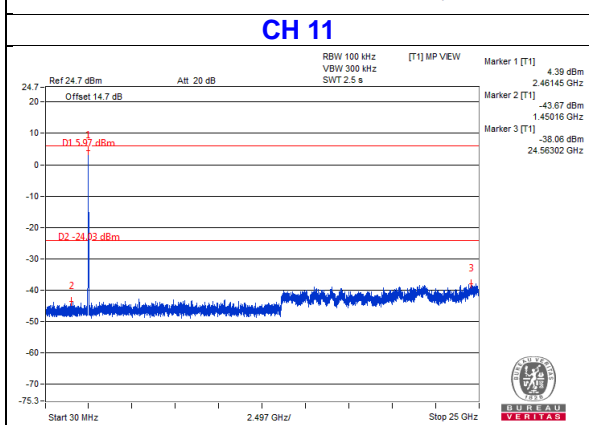
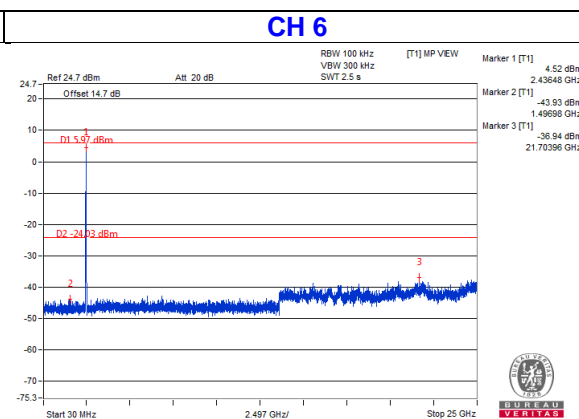
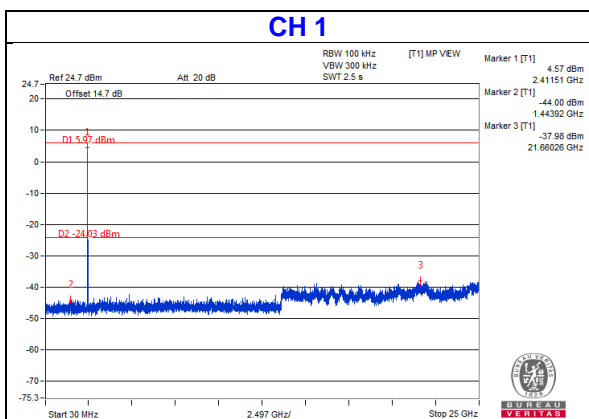
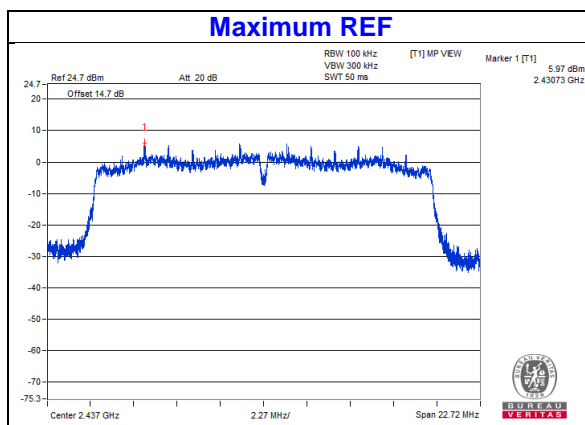

Chain 2

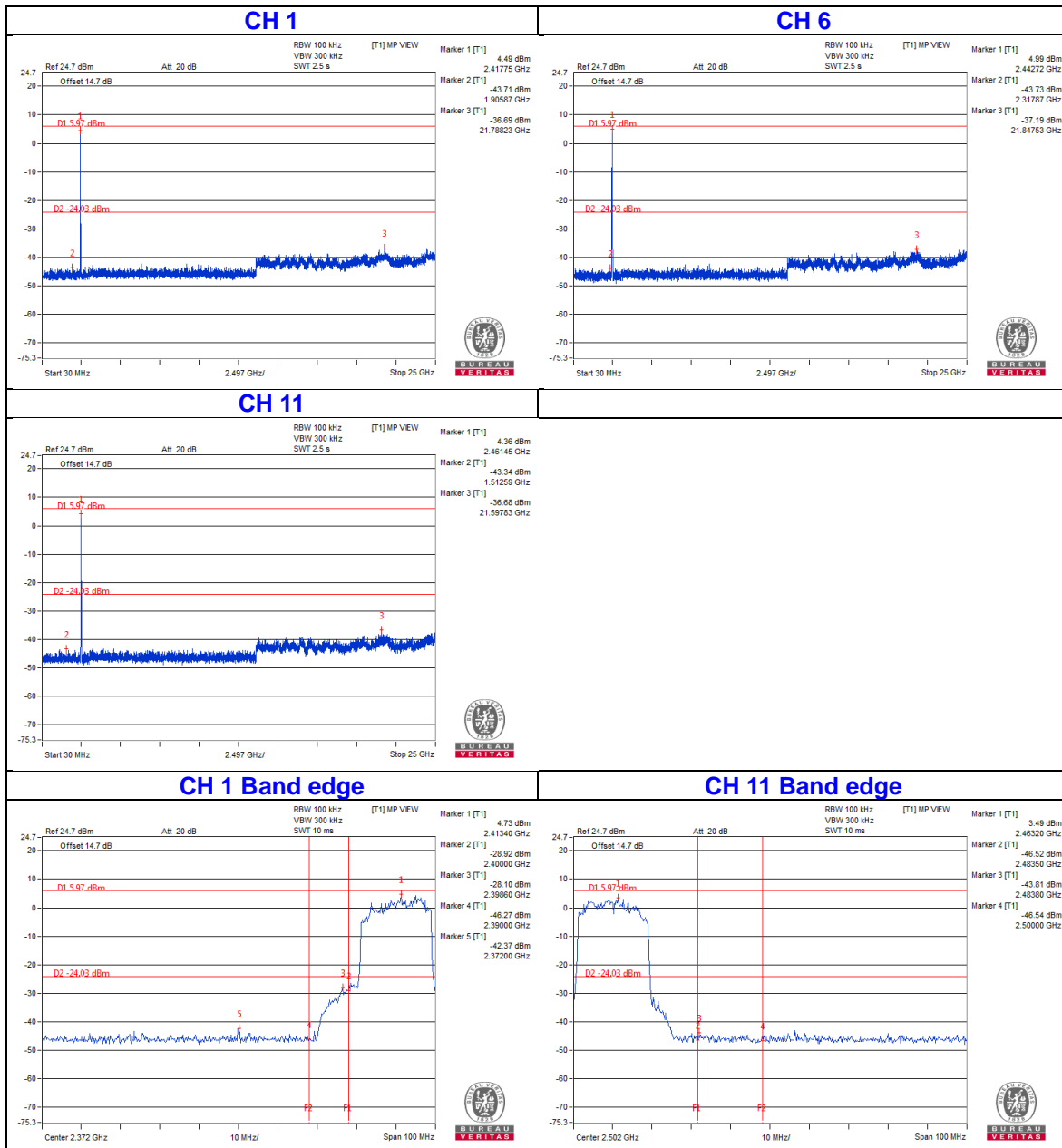

802.11n (40MHz) – 1TX:

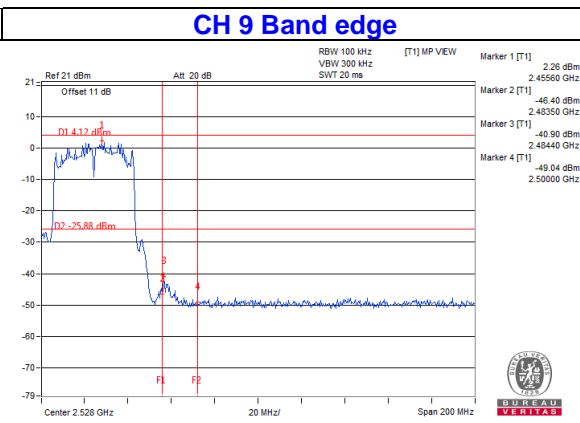
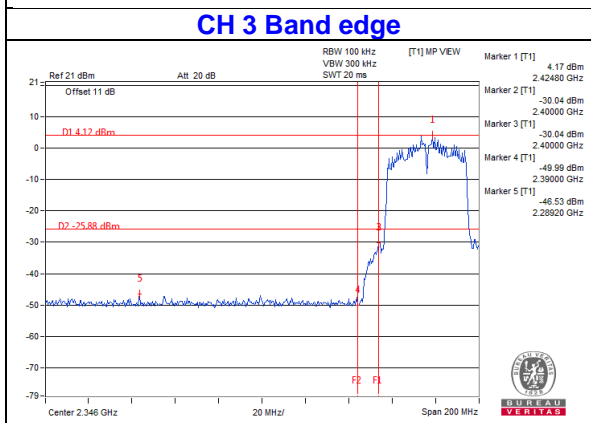
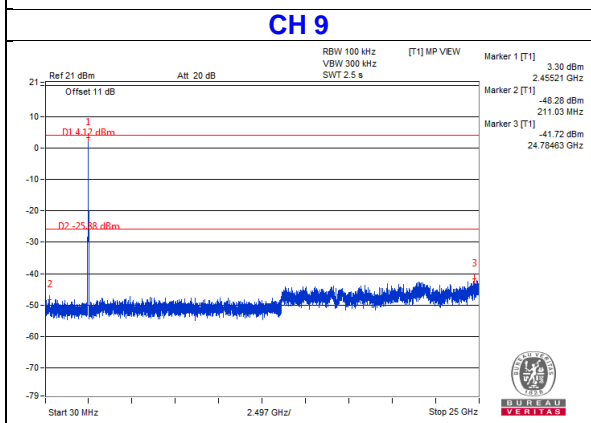
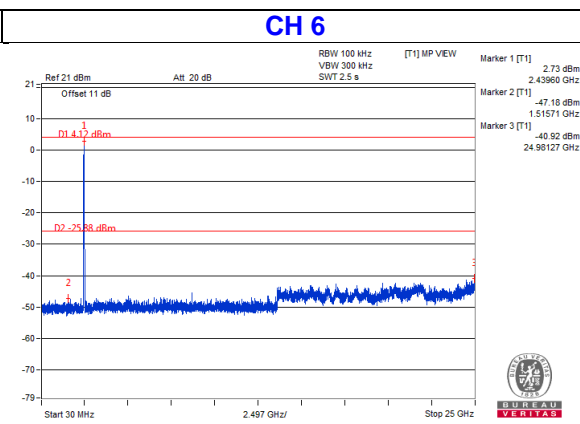
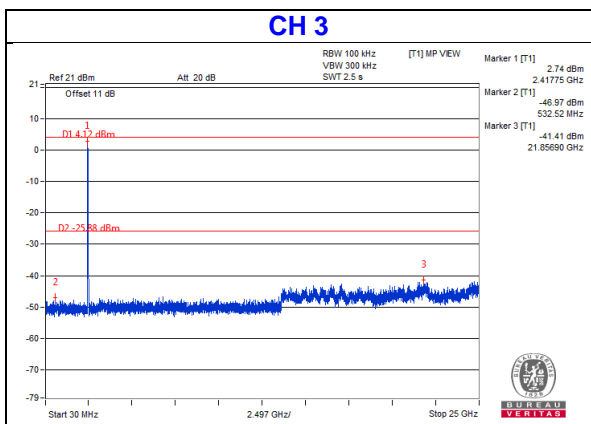
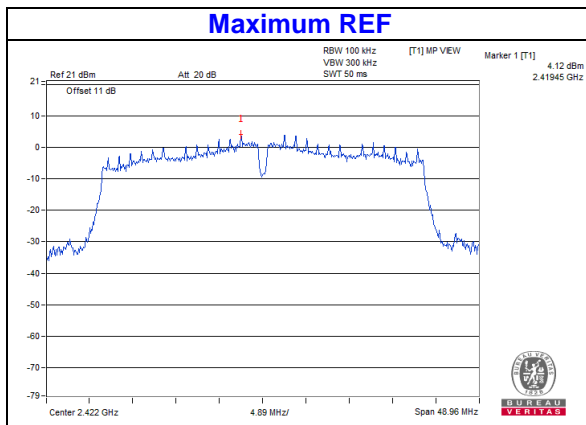

802.11n (40MHz) – 2TX:
Chain 1

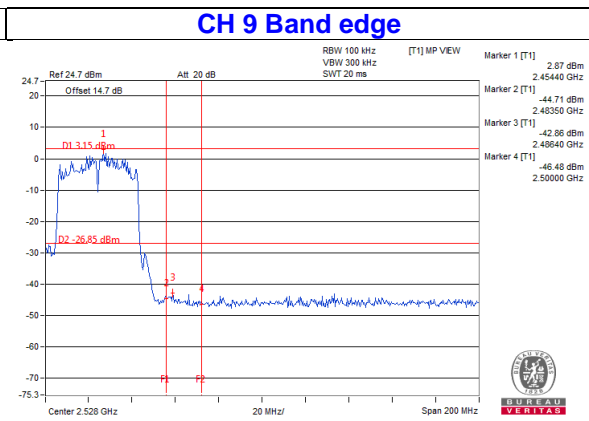
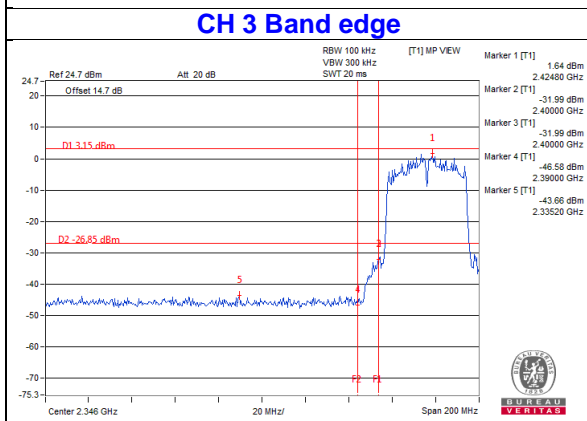
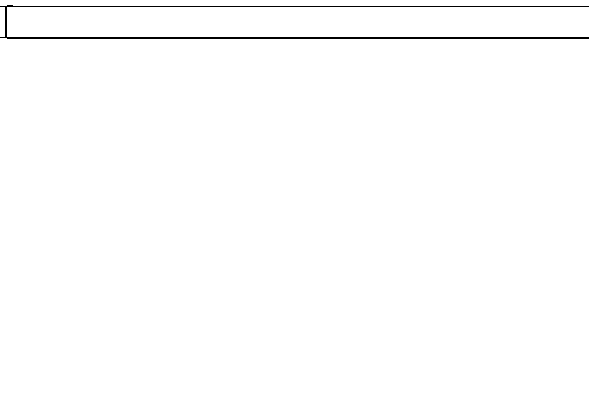
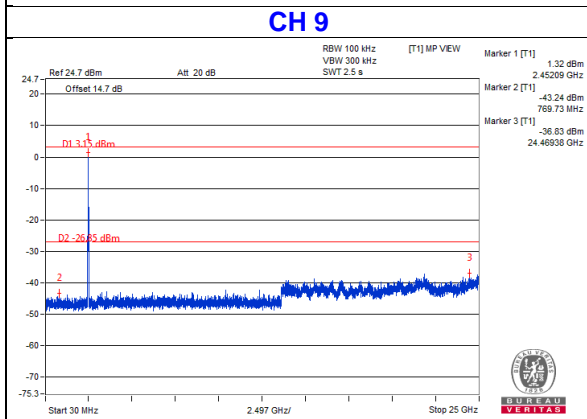
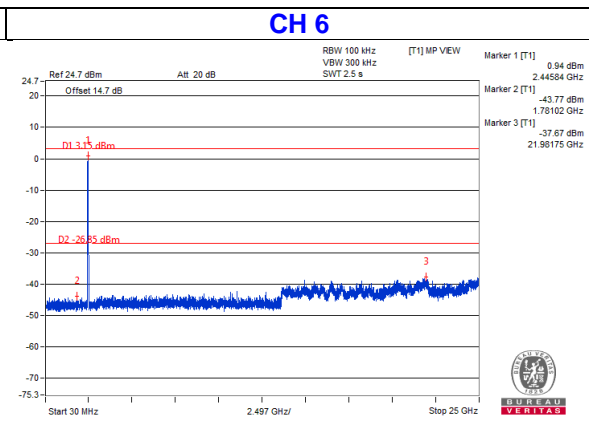
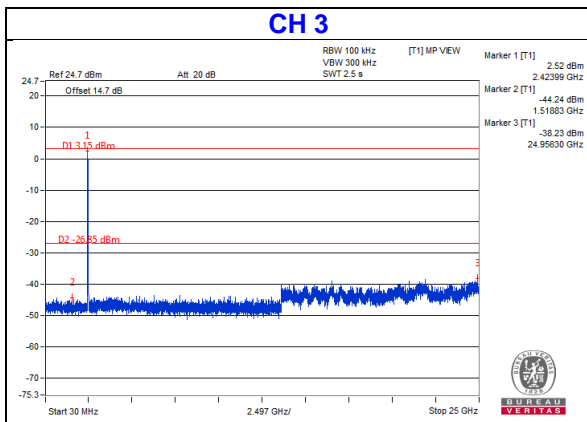
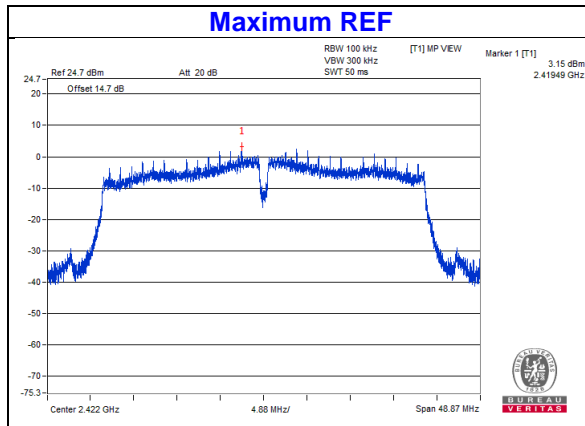

Chain 2

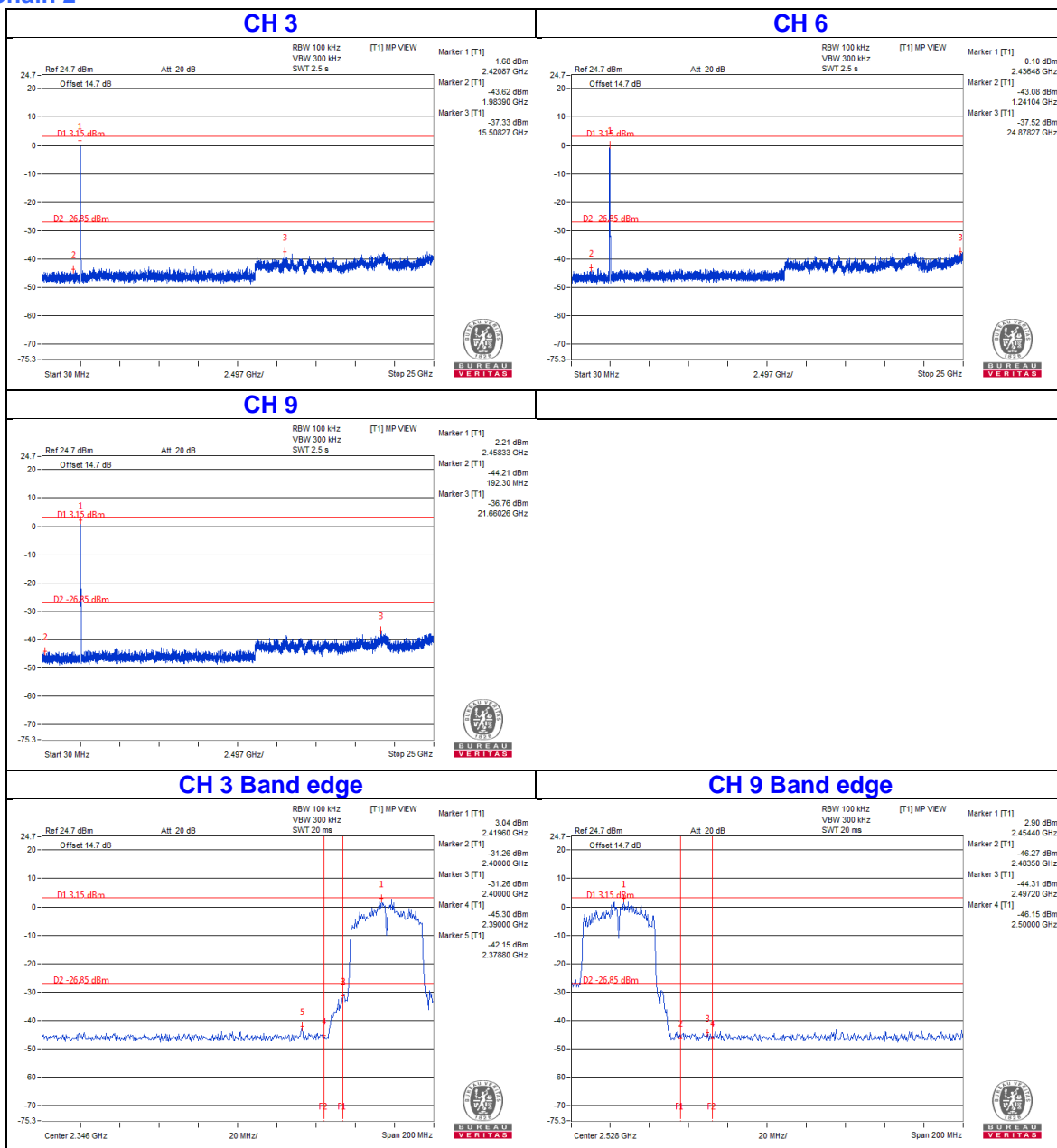

5 List of Test Instruments

DESCRIPTION & MANUFACTURER	MODEL NO.	SERIAL NO.	CALIBRATED DATE	CALIBRATED UNTIL
Test Receiver R&S	ESCS 30	847124/029	Nov. 01, 2017	Oct. 31, 2018
Line-Impedance Stabilization Network (for EUT) R&S	ESH3-Z5	848773/004	Nov. 15, 2017	Nov. 14, 2018
Line-Impedance Stabilization Network (for Peripheral) R&S	ENV216	100072	June 04, 2018	June 03, 2019
50 ohms Terminator	N/A	EMC-02	Sep. 22, 2017	Sep. 21, 2018
RF Cable	5D-FB	COCCAB-001	Sep. 29, 2017	Sep. 28, 2018
Fixed attenuator EMCI	STI02-2200-10	003	Mar. 16, 2018	Mar. 15, 2019
Software BVADT	BVADT_Cond_ V7.3.7.4	NA	NA	NA

Note:

1. The calibration interval of the above test instruments are 12 months and the calibrations are traceable to NML/ROC and NIST/USA.
2. The test was performed in Conduction 1.
3. Tested Date: June 18, 2018

DESCRIPTION & MANUFACTURER	MODEL NO.	SERIAL NO.	CALIBRATED DATE	CALIBRATED UNTIL
Test Receiver Agilent	N9038A	MY50010156	July 12, 2017	July 11, 2018
Pre-Amplifier EMCI	EMC001340	980142	Feb. 09, 2018	Feb. 08, 2019
Loop Antenna ^(*) Electro-Metrics	EM-6879	264	Dec. 16, 2016	Dec. 15, 2018
RF Cable	NA	LOOPCAB-001 LOOPCAB-002	Jan. 15, 2018	Jan. 14, 2019
Pre-Amplifier Mini-Circuits	ZFL-1000VH2 B	AMP-ZFL-05	May 05, 2018	May 04, 2019
Trilog Broadband Antenna SCHWARZBECK	VULB 9168	9168-361	Nov. 29, 2017	Nov. 28, 2018
RF Cable	8D	966-3-1 966-3-2 966-3-3	Mar. 20, 2018	Mar. 19, 2019
Fixed attenuator Mini-Circuits	UNAT-5+	PAD-3m-3-01	Oct. 03, 2017	Oct. 02, 2018
Horn_Antenna SCHWARZBECK	BBHA9120-D	9120D-406	Dec. 12, 2017	Dec. 11, 2018
Pre-Amplifier EMCI	EMC12630SE	980384	Jan. 29, 2018	Jan. 28, 2019
RF Cable	EMC104-SM- SM-1200 EMC104-SM- SM-2000 EMC104-SM- SM-5000	160922 150317 150322	Jan. 29, 2018	Jan. 28, 2019
Spectrum Analyzer Keysight	N9030A	MY54490679	July 25, 2017	July 24, 2018
Pre-Amplifier EMCI	EMC184045S E	980386	Jan. 29, 2018	Jan. 28, 2019
Horn_Antenna SCHWARZBECK	BBHA 9170	BBHA9170608	Dec. 14, 2017	Dec. 13, 2018
RF Cable	EMC102-KM- KM-1200	160924	Jan. 29, 2018	Jan. 28, 2019
Software	ADT_Radiated _V8.7.08	NA	NA	NA
Antenna Tower & Turn Table Max-Full	MF-7802	MF780208406	NA	NA
Boresight Antenna Fixture	FBA-01	FBA-SIP01	NA	NA

Note:

1. The calibration interval of the above test instruments is 12 months and the calibrations are traceable to NML/ROC and NIST/USA.
2. *The calibration interval of the above test instruments is 24 months and the calibrations are traceable to NML/ROC and NIST/USA.
3. The test was performed in 966 Chamber No. 3.
4. The CANADA Site Registration No. is 20331-1
5. Loop antenna was used for all emissions below 30 MHz.
6. Tested Date: June 13 to 18, 2018

Appendix - Information on the Testing Laboratories

We, Bureau Veritas Consumer Products Services (H.K.) Ltd., Taoyuan Branch, were founded in 1988 to provide our best service in EMC, Radio, Telecom and Safety consultation. Our laboratories are accredited and approved according to ISO/IEC 17025.

If you have any comments, please feel free to contact us at the following:

Linko EMC/RF Lab

Tel: 886-2-26052180

Fax: 886-2-26051924

Hsin Chu EMC/RF/Telecom Lab

Tel: 886-3-6668565

Fax: 886-3-6668323

Hwa Ya EMC/RF/Safety

Tel: 886-3-3183232

Fax: 886-3-3270892

Email: service.adt@tw.bureauveritas.com

Web Site: www.bureauveritas-adt.com

The address and road map of all our labs can be found in our web site also.

--- END ---