

FCC RADIO TEST REPORT

according to

47 CFR FCC Part 15 Subpart C § 15.247

Equipment Name : 802.11n WiFi Router
Model Number : C1100T
Product Code BAC1100T
FCC ID RSE-C1100T
Filing Type : New Application
Trade Name : technicolor
Applicant : Technicolor Delivery Technologies Belgium
Prins Boudewijnlaan 47
B-2650 Edegem
Belgium

Statement

Test result included is only for the IEEE 802.11n and IEEE 802.11b/g of the product.

The test result in this report refers exclusively to the presented test model / sample.

Without written approval of SPORTON International Inc., the test report shall not be reproduced except in full.

The measurements and test results shown in this test report were made in accordance with the procedures and found in compliance with the limit given in **ANSI C63.10-2013, 47 CFR FCC Part 15 Subpart C, KDB558074 D01 v03r03, KDB 662911 D01 v02r01.**

The test equipment used to perform the test is calibrated and traceable to NML/ROC.



SPORTON International Inc.

No. 52, Hwa Ya 1st Rd., Kwei-Shan Hsiang, Tao Yuan Hsien, Taiwan, R.O.C.

Table of Contents

1. SUMMARY OF THE TEST RESULT 2

- 1.1. Information provided by the manufacturer..... 3
- 1.2. Cabling attached to the equipment..... 3
- 1.3. Cabling Attached to the Equipment..... 3
- 1.4. Panel Drawing..... 3

2. GENERAL INFORMATION..... 4

- 2.1. Product Details 4
- 2.2. Accessories 4
- 2.3. Table for Filed Antenna 5
- 2.4. Transmit Operating Modes..... 6
- 2.5. Table for Carrier Frequencies 7
- 2.6. Table for Test Modes 8
- 2.7. Table for Testing Locations 8
- 2.8. Table for Supporting Units..... 9
- 2.9. Duty Cycle 9
- 2.10. Table for Parameters of Test Software Setting 9
- 2.11. Test Configuration 10

3. THE TEST RESULT 12

- 3.1. AC Power Line Conducted Emissions Measurement..... 12
- 3.2. Maximum Conducted Output Power Measurement 16
- 3.3. Power Spectral Density Measurement 20
- 3.4. 6dB Spectrum Bandwidth Measurement..... 29
- 3.5. Radiated Emissions Measurement..... 38
- 3.6. Band Edge and Fundamental Emissions Measurement 64
- 3.7. Antenna Requirements..... 85

4. LIST OF MEASURING EQUIPMENTS 86

5. MEASUREMENT UNCERTAINTY 87

APPENDIX A. TEST PHOTO..... A1 ~ A5

APPENDIX B. PHOTOGRAPHS OF EUT B1 ~ B13

APPENDIX C. SSROM VALUE AND CURPOWER VALUE

History of This Test Report

REPORT NO.	VERSION	DESCRIPTION	ISSUED DATE
FR561774	Rev.01	Initial issue of report	Sep. 23, 2015

VERIFICATION OF COMPLIANCE

according to

47 CFR FCC Part 15 Subpart C § 15.247

Equipment Name : 802.11n WiFi Router
Model Number : C1100T
Product Code : BAC1100T
Trade Name : technicolor
Applicant : Technicolor Delivery Technologies Belgium
Prins Boudewijnlaan 47
B-2650 Edegem
Belgium

Sporton International as requested by the applicant to evaluate the EMC performance of the product sample received on Jul. 24, 2015 would like to declare that the tested sample has been evaluated and found to be in compliance with the tested rule parts. The data recorded as well as the test configuration specified is true and accurate for showing the sample's EMC nature.



Sam Chen

SPORTON International Inc.

No. 52, Hwa Ya 1st Rd., Kwei-Shan Hsiang, Tao Yuan Hsien, Taiwan, R.O.C.

1. SUMMARY OF THE TEST RESULT

Applied Standard: 47 CFR FCC Part 15 Subpart C				
Part	Rule Section	Description of Test	Result	Under Limit
3.1	15.207	AC Power Line Conducted Emissions	Complies	9.15 dB
3.2	15.247(b)(3)	Conducted Output Power	Complies	7.24 dB
3.3	15.247(e)	Power Spectral Density	Complies	12.81 dB
3.4	15.247(a)(2)	6dB Spectrum Bandwidth	Complies	-
3.5	15.247(d)	Radiated Emissions	Complies	5.61 dB
3.6	15.247(d)	Band Edge Emissions	Complies	0.04 dB
3.7	15.203	Antenna Requirements	Complies	-

1.1. Information provided by the manufacturer

Equipment Name: 802.11n WiFi Router

Model Number: C1100T

Trade Name: technicolor

Power Supply: Switching-Type, 12Vdc, 1.5A, Manufacturer: AcBel, Model: WAF003, ID: AD0G2

Hardware Version: Lab1

Interface Availability

Interface / Model Number	DC 12Vdc	Ethernet WAN 1000Mbps	Ethernet LAN 1000Mbps	USB 2.0	Phone	DSL	WLAN IEEE 802.11b/g/n (2.4GHz 2*2)
C1100T	• (18W)	• (1 port)	• (4 port)	• (1 port)	• (1 port)	• (1 port)	• (2 ports)

Note : • : Equipped ○ : Not Equipped

1.2. Cabling attached to the equipment

US Standard: 47 CFR FCC Part 15 Subpart C § 15.247

ANSI C63.10-2013

KDB662911 D01 Multiple Transmitter Output v02r01, 10/31/2013

KDB558074 D01 DTS Meas Guidance v03r03, 06/09/2014

1.3. Cabling Attached to the Equipment

Cable and Interconnection

Interface	Cable type	Cable length delivered with the modem	“Real life” Cable length that can be attached to this type of interface	Cable length to be used for testing	Internal / external connection
DSL	UTP Cat 3	2 meter flat cable	> 10 meter	10 meter	External
Eth1, WAN	UTP Cat 5	2 meter	> 10 meter	Two 10 meter cables	Internal
USB	STP	1 meter	< 3 meter	1 meter	Internal
Phone	UTP Cat 3	2 meter flat cable	> 10 meter	10 meter	Internal
AC power	-	-	-	-	Internal

1.4. Panel Drawing

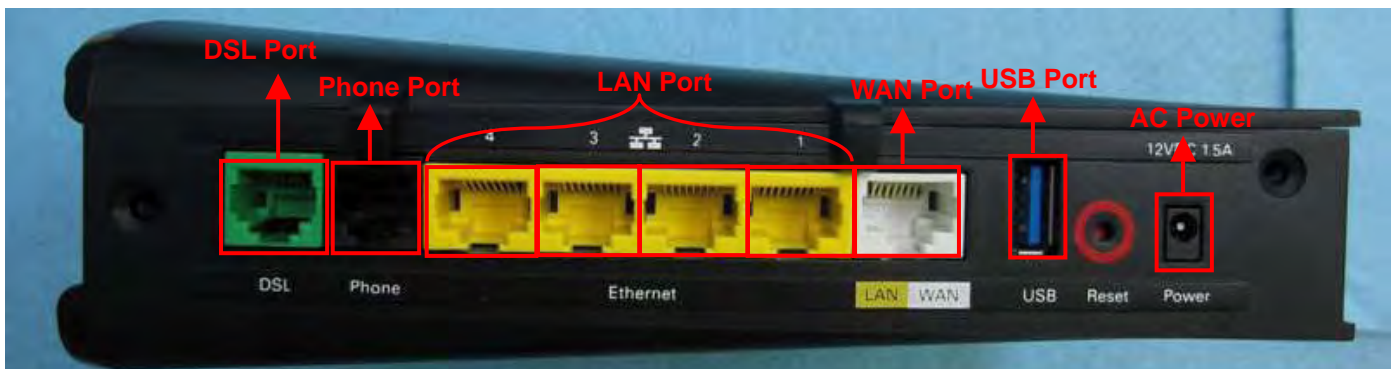

2. GENERAL INFORMATION

2.1. Product Details

Items	Description		
Product	Stand alone		
Model Number	C1100T		
FCC ID	RSE-C1100T		
Power Type	From Power Adapter		
EUT Stage	<input type="checkbox"/> Product Unit	<input checked="" type="checkbox"/>	Pre-Sample
Antenna Type	Please see Section 2.3		
Operating Band, Conducted power	2400~2483.5MHz	<input checked="" type="checkbox"/>	IEEE 802.11b: 22.76 dBm
		<input checked="" type="checkbox"/>	IEEE 802.11g: Note
		<input checked="" type="checkbox"/>	IEEE 802.11n (20MHz): 21.95 dBm
Product Type	For IEEE 802.11b: WLAN(1TX, 1RX) For IEEE 802.11g: WLAN(1/2TX, 2RX) For IEEE 802.11n: WLAN(1/2TX, 2RX)		
Nominal Chennel Bandwidth	20MHz		
Modulation	802.11b: DSSS (DBPSK, DQPSK, CCK) 802.11g: OFDM (BPSK / QPSK / 16QAM / 64QAM) 802.11n: See the below table.		
Data Rate (Mbps)	11b mode :DSSS (1/2/5.5/11) 11g mode :OFDM (6/9/12/18/24/36/48/54) 11n(20MHz) mode(MCS0~MCS15)		
I/O Ports	LAN Port x 4 WAN Port x 1 USB Host Port x 1 Phone Port x 1 DSL Port x 1		
Software Version	1.0.38-112.118-TCH-0.3		
Associated Devices	Switching-Type DC power supply		

Note: 11g SISO mode was exempted from testing because they're covered by 11n 20MHz SISO mode.
11g CDD mode was exempted from testing because they're covered by 11n 20MHz CDD mode.

2.2. Accessories

Power	Brand	Model	Rating
Adapter	Ac Bel	WAF003	INPUT: 100-240V~MAX0.7A, 50/60Hz OUTPUT: 12V, 1.5A

2.3. Table for Filed Antenna

Ant.	Brand	Model Name	Antenna Type	Connector
1	-	-	Print Antenna	N/A
2	-	-	Print Antenna	N/A

Antenna & Bandwidth

Antenna	1st (TX)	2nd (TX)
Bandwidth Mode	20 MHz	20 MHz
802.11b	V	X
802.11g	V	V
802.11n	V	V

Frequency	Antenna Gain (dBi)	
	Ant. 1 (WJ1)	Ant. 2 (WJ2)
	20 MHz	20 MHz
2412MHz	2.46	1.92
2437MHz	2.27	1.96
2462MHz	2.61	2.04

Frequency	Directional Gain (dBi)	
	CDD mode (1 Stream 2 TX) For Power Gain (KDB 662911 Option 1)	CDD mode (1 Stream 2 TX) For PSD Gain (KDB 662911 Option 1)
	20 MHz	20 MHz
2412MHz	2.46	5.47
2437MHz	2.27	5.28
2462MHz	2.61	5.63

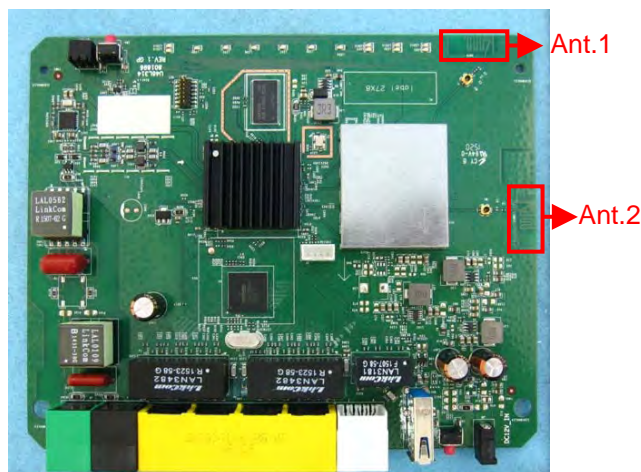

IEEE 802.11n Data Rate spec

Standard	INDEX	Data Rate (Mbps)	
		LGI (800ns)	Sgi (400ns)
11n 20MHz 1 stream	MCS0	6.5	7.2
	MCS1	13	14.4
	MCS2	19.5	21.7
	MCS3	26	28.9
	MCS4	39	43.3
	MCS5	52	57.8
	MCS6	58.5	65
	MCS7	65	72.2
11n 20MHz 2 stream	MCS8	13	14.4
	MCS9	26	28.9
	MCS10	39	43.3
	MCS11	52	57.8
	MCS12	78	86.7
	MCS13	104	115.6
	MCS14	117	130
	MCS15	130	144.4

2.4. Transmit Operating Modes

Transmit Operating Mode				Transmit Multiple Antennas						
<input checked="" type="checkbox"/>	Operating mode 1 (single antenna)			<input checked="" type="checkbox"/>	1TX					
<input checked="" type="checkbox"/>	Operating mode 2 (multiple antenna, no beam forming)			<input checked="" type="checkbox"/>	2TX	<input type="checkbox"/>	3TX	<input type="checkbox"/>	4TX	
<input type="checkbox"/>	Operating mode 3 (multiple antenna, with beam forming)			<input type="checkbox"/>	2TX	<input type="checkbox"/>	3TX	<input type="checkbox"/>	4TX	
<input checked="" type="checkbox"/>	802.11b	Operating mode	<input checked="" type="checkbox"/>	1TX	<input type="checkbox"/>	2TX	<input type="checkbox"/>	3TX	<input type="checkbox"/>	Cyclic shift
<input checked="" type="checkbox"/>	802.11g	Operating mode	<input checked="" type="checkbox"/>	1TX	<input checked="" type="checkbox"/>	2TX	<input type="checkbox"/>	3TX	<input type="checkbox"/>	Cyclic shift
<input checked="" type="checkbox"/>	802.11n(HT20)	Operating mode	<input checked="" type="checkbox"/>	1TX	<input checked="" type="checkbox"/>	2TX	<input type="checkbox"/>	3TX	<input type="checkbox"/>	Cyclic shift
<input type="checkbox"/>	802.11n(HT40)	Operating mode	<input type="checkbox"/>	1TX	<input type="checkbox"/>	2TX	<input type="checkbox"/>	3TX	<input type="checkbox"/>	Cyclic shift

Note1: IEEE802.11n, SISO (1Stream1TX) : MCS0~MCS7; CDD (1Stream2TX) : MCS0~MCS7;
SDM (2Stream2TX) : MCS8~MCS15

2.5. Table for Carrier Frequencies

11 channels are provided for 802.11b, 802.11g, 802.11n (20MHz):

Frequency Band	Channel No.	Frequency	Channel No.	Frequency
2400 ~ 2483.5 MHz	1	2412MHz	7	2442MHz
	2	2417MHz	8	2447MHz
	3	2422MHz	9	2452MHz
	4	2427MHz	10	2457MHz
	5	2432MHz	11	2462MHz
	6	2437MHz	-	-

2.6. Table for Test Modes

Investigation has been done on all the possible configurations for searching the worst cases.

The following table is a list of the test modes shown in this test report.

Test Items	Mode	Note	Channel	Data Rate	Antenna
AC Power Line Conducted Emissions	11n	OFDM/BPSK	6	-	1+2
Maximum Average Output Power	11b	DSSS/DBPSK	1/6/11	1Mbps	2
	11n(20MHz)	OFDM/BPSK	1/6/11	MCS0	2
				MCS0	1+2(CDD)
Power Spectral Density	11b	DSSS/DBPSK	1/6/11	1Mbps	2
	11n(20MHz)	OFDM/BPSK	1/6/11	MCS0	2
				MCS0	1+2(CDD)
6dB Spectrum Bandwidth	11b	DSSS/DBPSK	1/6/11	1Mbps	2
	11n(20MHz)	OFDM/BPSK	1/6/11	MCS0	2
				MCS0	1+2(CDD)
Band Edge Emissions (Radiated)	11b	DSSS/DBPSK	1/6/11	1Mbps	2
	11n(20MHz)	OFDM/BPSK	1/6/11	MCS0	2
				MCS0	1+2(CDD)
Radiated Emissions Above 1GHz (Radiated)	11b	DSSS/DBPSK	1/6/11	1Mbps	2
	11n(20MHz)	OFDM/BPSK	1/6/11	MCS0	2
				MCS0	1+2(CDD)
Radiated Emissions Below 1GHz(Radiated)	11n	OFDM/BPSK	6	-	1+2(CDD)

Note: 11g SISO mode was exempted from testing because they're covered by 11n 20MHz SISO mode.
 11g CDD mode was exempted from testing because they're covered by 11n 20MHz CDD mode.

2.7. Table for Testing Locations

Test Site Location					
Address:	No.8, Lane 724, Bo-ai St., Jhubei City, Hsinchu County 302, Taiwan, R.O.C.				
TEL:	886-3-656-9065				
FAX:	886-3-656-9085				
Test Site No.	Site Category	Location	FCC Reg. No.	IC File No.	VCCI Reg. No
03CH01-CB	SAC	Hsin Chu	262045	IC 4086D	-
CO02-CB	Conduction	Hsin Chu	262045	IC 4086D	-
TH01-CB	OVEN Room	Hsin Chu	-	-	-

Open Area Test Site (OATS); Semi Anechoic Chamber (SAC).

2.8. Table for Supporting Units

For Test Site No: CO02-CB

Support Unit	Brand	Model	FCC ID
Notebook	DELL	E6430	DoC

For Test Site No: TH01-CB and 03CH01-CB

Support Unit	Brand	Model	FCC ID
Notebook	DELL	E4300	DoC

2.9. Duty Cycle

Mode	On Time (ms)	On+Off Time (ms)	Duty Cycle (%)	Duty Factor (dB)	1/T Minimum VBW (kHz)
802.11b Ant. 2	1.000	1.000	100.00%	0.00	0.01
11n(20MHz) Ant. 2	1.899	1.931	98.34%	1.02	0.01
11n(20MHz) Ant.1+2, CDD	1.907	1.931	98.76%	1.01	0.01

2.10. Table for Parameters of Test Software Setting

During testing, Channel & Power Controlling Software provided by the customer was used to control the operating channel as well as the output power level. The RF output power selection is for the setting of RF output power expected by the customer and is going to be fixed on the firmware of the final end product.

The Power Setting Parameter						
Test Software Version		1.0.38-112.118-TCH-0.3				
Worst Modulation Mode		Number of Transmit Chains (NTX)	Frequency (MHz)	Maximum Output Power (dBm)	Power Setting	Data Rate / MCS
Ant. 2	802.11b	1Stream 1TX	2412	22.09	20.75	1Mbps
Ant. 2	802.11b	1Stream 1TX	2437	22.76	21.5	1Mbps
Ant. 2	802.11b	1Stream 1TX	2462	21.09	20	1Mbps
Ant. 2	802.11n 20MHz	1Stream 1TX	2412	15.19	15	MCS0
Ant. 2	802.11n 20MHz	1Stream 1TX	2437	18.40	18.5	MCS0
Ant. 2	802.11n 20MHz	1Stream 1TX	2462	16.07	16.25	MCS0
Ant.1+2, CDD	802.11n 20MHz	1Stream 2TX	2412	17.86	14.5	MCS0
Ant.1+2, CDD	802.11n 20MHz	1Stream 2TX	2437	21.95	19	MCS0
Ant.1+2, CDD	802.11n 20MHz	1Stream 2TX	2462	18.27	15.5	MCS0

2.11. Test Configuration

2.11.1. AC Power Line Conduction Emissions Test Configuration

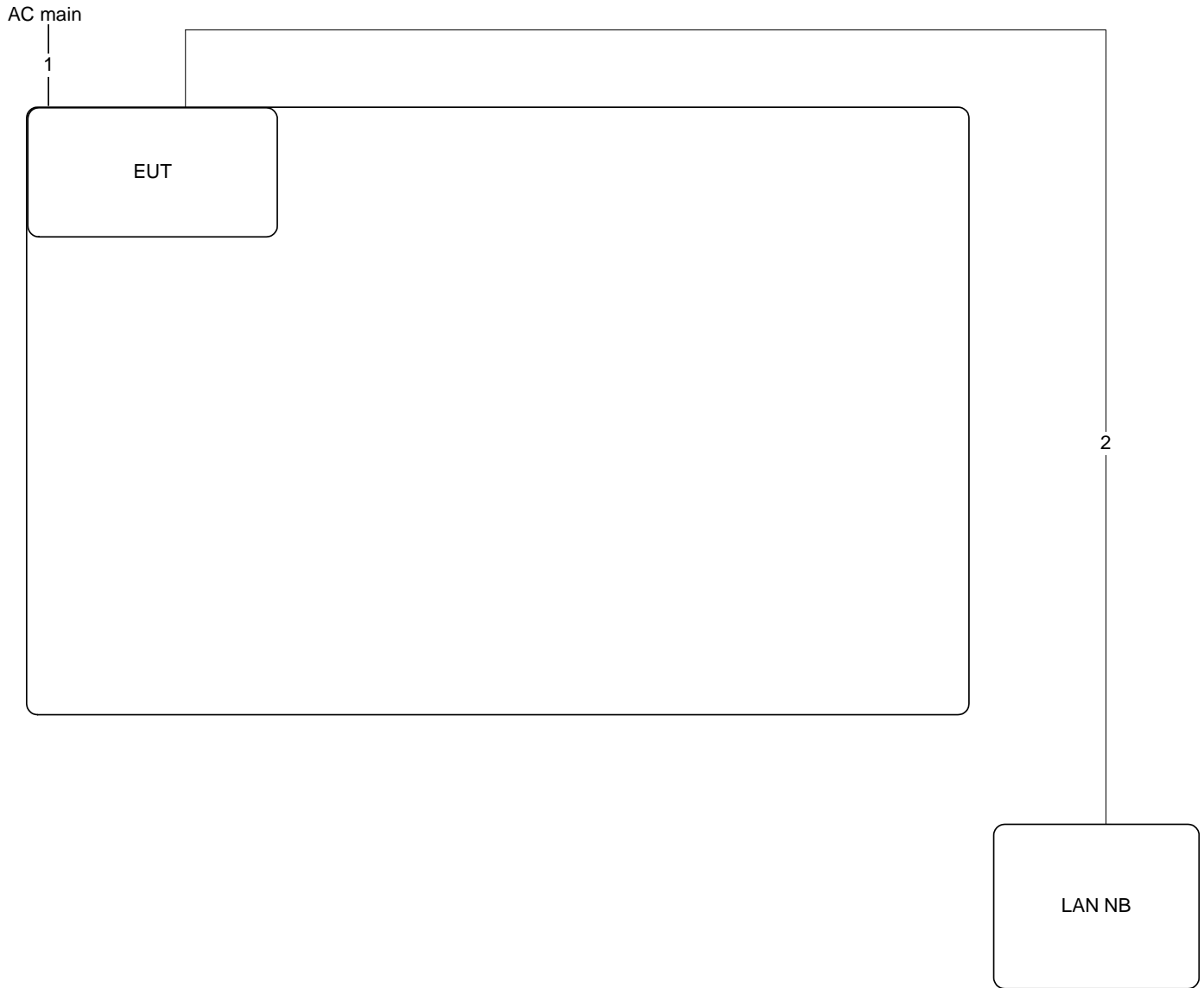

Item	Connection	Shielded	Length
1	Power Cable	No	1.8m
2	RJ-45 Cable	No	10m

2.11.2. Radiation Emissions Test Configuration

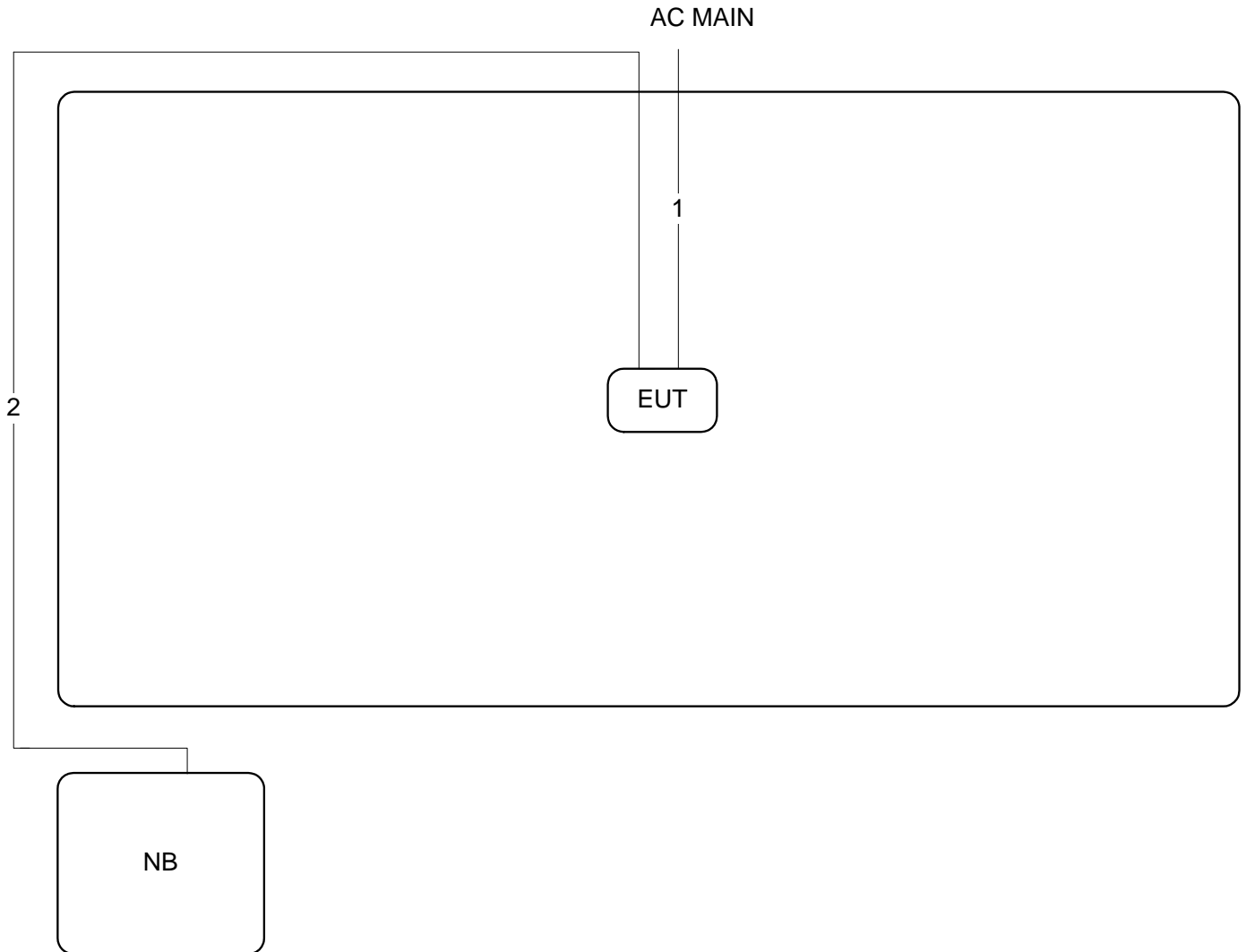

Item	Connection	Shielded	Length
1	Power Cable	No	1.8m
2	RJ-45 Cable	No	10m

3. THE TEST RESULT

3.1. AC Power Line Conducted Emissions Measurement

3.1.1. Limit

For this product which is designed to be connected to the AC power line, the radio frequency voltage that is conducted back onto the AC power line on any frequency or frequencies within the band 150 kHz to 30 MHz shall not exceed below limits table.

Frequency (MHz)	QP Limit (dBuV)	AV Limit (dBuV)
0.15~0.5	66~56	56~46
0.5~5	56	46
5~30	60	50

3.1.2. Measuring Instruments and Setting

Please refer to section 4 of equipments list in this report. The following table is the setting of the receiver.

Receiver Parameters	Setting
Attenuation	10 dB
Start Frequency	0.15 MHz
Stop Frequency	30 MHz
IF Bandwidth	9 kHz

3.1.3. Test Procedures

1. Configure the EUT according to ANSI C63.10. The EUT or host of EUT has to be placed 0.4 meter far from the conducting wall of the shielding room and at least 80 centimeters from any other grounded conducting surface.
2. Connect EUT or host of EUT to the power mains through a line impedance stabilization network (LISN).
3. All the support units are connected to the other LISNs. The LISN should provide 50uH/50ohms coupling impedance.
4. The frequency range from 150 kHz to 30 MHz was searched.
5. Set the test-receiver system to Peak Detect Function and Specified Bandwidth with Maximum Hold Mode.
6. The measurement has to be done between each power line and ground at the power terminal.

3.1.4. Test Setup Layout

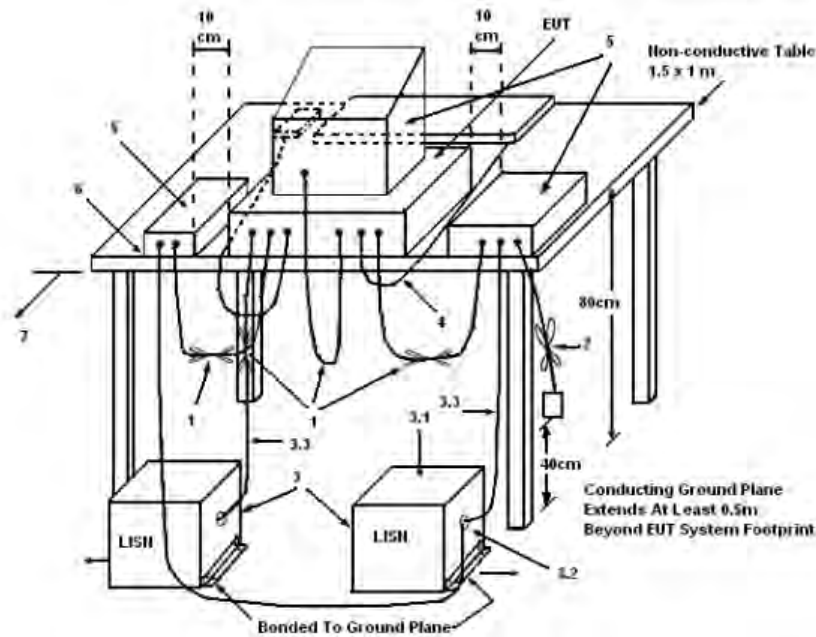

LEGEND:

1. Interconnecting cables that hang closer than 40 cm to the ground plane shall be folded back and forth in the center forming a bundle 30 to 40 cm long.
2. I/O cables that are not connected to a peripheral shall be bundled in the center. The end of the cable may be terminated, if required, using the correct terminating impedance. The overall length shall not exceed 1 m.
3. EUT connected to one LISN. Unused LISN measuring port connectors shall be terminated in 50 Ω. LISN can be placed on top of, or immediately beneath, reference ground plane.
4. All other equipment powered from additional LISN(s).
5. Multiple outlet strip can be used for multiple power cords of non-EUT equipment.
6. LISN at least 80 cm from nearest part of EUT chassis.
7. Cables of hand-operated devices, such as keyboards, mice, etc., shall be placed as for normal use.
8. Non-EUT components of EUT system being tested.
9. Rear of EUT, including peripherals, shall all be aligned and flush with rear of tabletop.
10. Rear of tabletop shall be 40 cm removed from a vertical conducting plane that is bonded to the ground plane.

3.1.5. Test Deviation

There is no deviation with the original standard.

3.1.6. EUT Operation during Test

The EUT was programmed to be in continuously transmitting mode.

3.1.7. Results of AC Power Line Conducted Emissions Measurement

Temperature	23°C	Humidity	60%
Test Engineer	Kane Liu	Phase	Line
Configuration	802.11n		

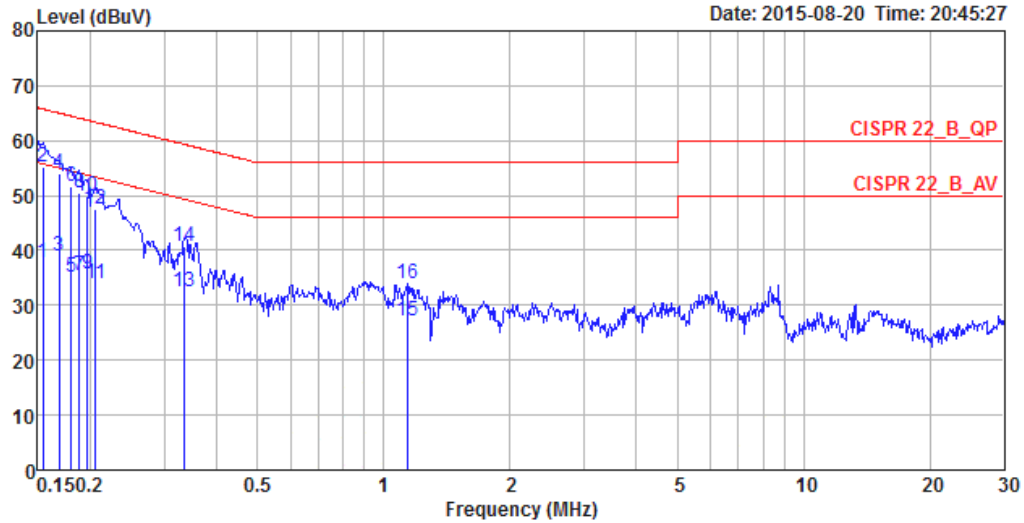

	Freq	Level	Over Limit	Limit Line	Read Level	LISN Factor	Cable Loss	Pol/Phase	Remark
	MHz	dBuV	dB	dBuV	dBuV	dB	dB		
1	0.1540	37.66	-18.12	55.78	27.49	10.00	0.17	LINE	Average
2	0.1540	55.11	-10.67	65.78	44.94	10.00	0.17	LINE	QP
3	0.1685	38.87	-16.16	55.03	28.70	10.00	0.17	LINE	Average
4	0.1685	54.10	-10.93	65.03	43.93	10.00	0.17	LINE	QP
5	0.1806	35.07	-19.39	54.46	24.87	10.01	0.19	LINE	Average
6	0.1806	51.72	-12.74	64.46	41.52	10.01	0.19	LINE	QP
7	0.1884	35.31	-18.80	54.11	25.11	10.01	0.19	LINE	Average
8	0.1884	50.37	-13.74	64.11	40.17	10.01	0.19	LINE	QP
9	0.1965	35.68	-18.08	53.76	25.48	10.01	0.19	LINE	Average
10	0.1965	49.89	-13.87	63.76	39.69	10.01	0.19	LINE	QP
11	0.2061	34.05	-19.31	53.36	23.85	10.01	0.19	LINE	Average
12	0.2061	47.46	-15.90	63.36	37.26	10.01	0.19	LINE	QP
13	0.3338	32.37	-16.98	49.35	22.16	10.01	0.20	LINE	Average
14	0.3338	40.67	-18.68	59.35	30.46	10.01	0.20	LINE	QP
15	1.1352	27.24	-18.76	46.00	17.00	10.04	0.20	LINE	Average
16	1.1352	34.02	-21.98	56.00	23.78	10.04	0.20	LINE	QP

Note 1: The test was passed at the minimum margin that marked by the frame in the following data
 Note 2: The emission levels of other frequencies were very low against the limit.
 Note 3: Q.P. and AV. are abbreviations of quasi-peak and average individually.
 Note 4: Corrected Reading (dBuV) = LISN Factor + Cable Loss + Read Level = Level
 Note 5: Over Limit value = level - Limit value

Temperature	23°C	Humidity	60%
Test Engineer	Kane Liu	Phase	Neutral
Configuration	802.11n		

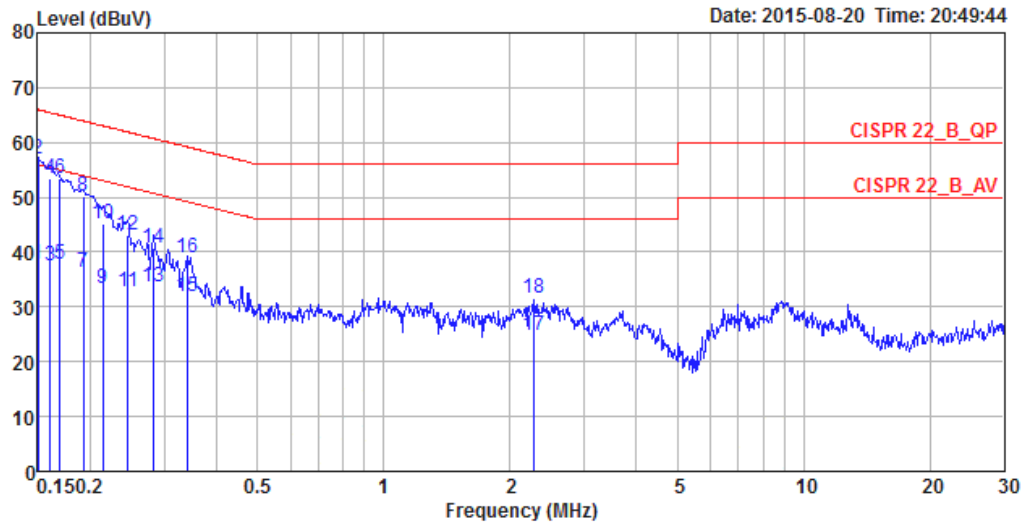

	Freq	Level	Over Limit	Limit Line	Read Level	LISN Factor	Cable Loss	Pol/Phase	Remark
	MHz	dBuV	dB	dBuV	dBuV	dB	dB		
1	0.1500	37.64	-18.36	56.00	27.47	10.00	0.17	NEUTRAL	Average
2	0.1500	56.85	-9.15	66.00	46.68	10.00	0.17	NEUTRAL	QP
3	0.1607	37.40	-18.03	55.43	27.23	10.00	0.17	NEUTRAL	Average
4	0.1607	53.40	-12.03	65.43	43.23	10.00	0.17	NEUTRAL	QP
5	0.1694	37.74	-17.25	54.99	27.57	10.00	0.17	NEUTRAL	Average
6	0.1694	53.43	-11.56	64.99	43.26	10.00	0.17	NEUTRAL	QP
7	0.1924	36.26	-17.67	53.93	26.06	10.01	0.19	NEUTRAL	Average
8	0.1924	50.29	-13.64	63.93	40.09	10.01	0.19	NEUTRAL	QP
9	0.2139	33.40	-19.65	53.05	23.20	10.01	0.19	NEUTRAL	Average
10	0.2139	45.17	-17.88	63.05	34.97	10.01	0.19	NEUTRAL	QP
11	0.2455	32.69	-19.22	51.91	22.49	10.01	0.19	NEUTRAL	Average
12	0.2455	43.12	-18.79	61.91	32.92	10.01	0.19	NEUTRAL	QP
13	0.2818	33.68	-17.08	50.76	23.48	10.01	0.19	NEUTRAL	Average
14	0.2818	40.75	-20.01	60.76	30.55	10.01	0.19	NEUTRAL	QP
15	0.3392	31.75	-17.47	49.22	21.54	10.01	0.20	NEUTRAL	Average
16	0.3392	39.04	-20.18	59.22	28.83	10.01	0.20	NEUTRAL	QP

Note 1: The test was passed at the minimum margin that marked by the frame in the following data
 Note 2: The emission levels of other frequencies were very low against the limit.
 Note 3: Q.P. and AV. are abbreviations of quasi-peak and average individually.
 Note 4: Corrected Reading (dBuV) = LISN Factor + Cable Loss + Read Level = Level
 Note 5: Over Limit value = level - Limit value

3.2. Maximum Conducted Output Power Measurement

3.2.1. Limit

For systems using digital modulation in the 2400-2483.5MHz, the limit for peak output power is 30dBm. The limited has to be reduced by the amount in dB that the gain of the antenna exceed 6dBi. In case of point-to-point operation, the limit has to be reduced by 1dB for every 3dB that the directional gain of the antenna exceeds 6dBi.

3.2.2. Measuring Instruments and Setting

Please refer to section 4 of equipments list in this report. The following table is the setting of spectrum analyzer.

Power Meter Parameter	Setting
Filter No.	Auto
Measurement time	0.135 s ~ 26 s
Power Sensor	U2021XA

3.2.3. Test Procedures

1. Test was performed in accordance with Measurement of Digital Transmission Systems Operating under KDB558074 D01 DTS Meas Guidance v03r03, in section "Maximum conducted output power Method AVGPM", 06/09/2014
2. The average power sensor was used on the output port of the EUT. A power meter was used to read the response of the average power sensor to get the all on time transmission. Record the average power level.
3. When measuring maximum conducted output power with multiple antenna systems, add every result of the values by mathematic formula.
4. Adjust the measurement in dBm by adding $10 \log(1/x)$ where x is the duty cycle. Record the average power level.

3.2.4. Test Setup Layout

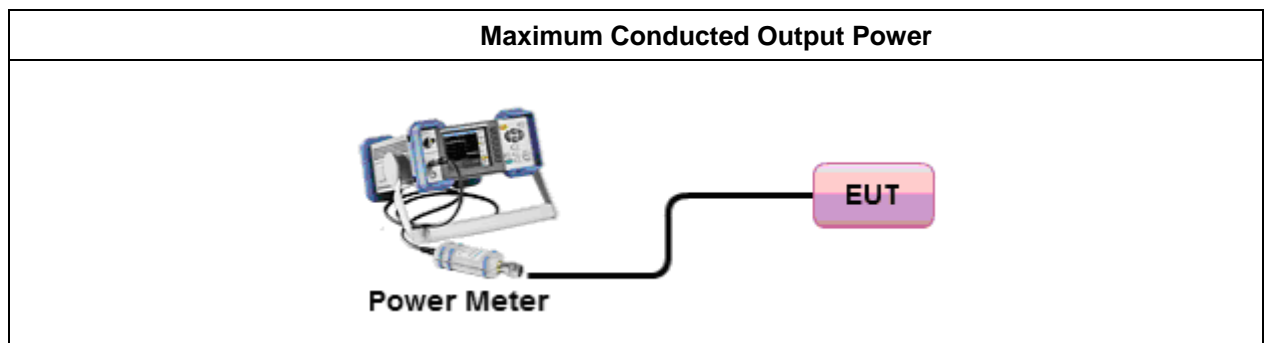

3.2.5. Test Deviation

There is no deviation with the original standard.

3.2.6. EUT Operation during Test

The EUT was programmed to be in continuously transmitting mode.

3.2.7. Test Result for Maximum Conducted Output Power

Test date	Aug. 20, 2015	Test Site No.	TH01-CB
Temperature	25°C	Humidity	51%
Test Engineer	Roki Liu	Configuration	802.11b
Duty Cycle	100%		

Configuration IEEE 802.11b

<Ant. 2>

Channel	Frequency	Conducted Power (dBm)	Antenna Gain (dBi)	Max. Limit (dBm)	Result
1	2412 MHz	22.09	1.92	30.00	Complies
6	2437 MHz	22.76	1.96	30.00	Complies
11	2462 MHz	21.09	2.04	30.00	Complies

Test date	Aug. 20, 2015	Test Site No.	TH01-CB
Temperature	25°C	Humidity	51%
Test Engineer	Roki Liu	Configuration	802.11n 20MHz
Duty Cycle	98.34%		

Configuration of IEEE 802.11n 20MHz

<Ant. 2>

Channel	Frequency	Conducted Power (dBm)	Antenna Gain (dBi)	Max. Limit (dBm)	Result
1	2412 MHz	15.19	1.92	30.00	Complies
6	2437 MHz	18.40	1.96	30.00	Complies
11	2462 MHz	16.07	2.04	30.00	Complies

Test date	Aug. 20, 2015	Test Site No.	TH01-CB
Temperature	25°C	Humidity	51%
Test Engineer	Roki Liu	Configuration	802.11n 20MHz
Duty Cycle	98.76%		

< MCS0, Ant. 1+2, CDD>

Channel	Frequency	Conducted Power (dBm)			Antenna Gain (dBi)	Max. Limit (dBm)	Result
		Ant. 1	Ant. 2	Total			
1	2412 MHz	15.04	14.66	17.86	2.46	30.00	Complies
6	2437 MHz	18.82	19.06	21.95	2.27	30.00	Complies
11	2462 MHz	15.29	15.23	18.27	2.61	30.00	Complies

3.3. Power Spectral Density Measurement

3.3.1. Limit

For digitally modulated systems, the power spectral density conducted from the intentional radiator to the antenna shall not be greater than 8 dBm in any 3 kHz band during any time interval of continuous transmission.

3.3.2. Measuring Instruments and Setting

Please refer to section 4 of equipments list in this report. The following table is the setting of Spectrum Analyzer.

Power Meter Parameter	Setting
Attenuation	Auto
Span Frequency	Set span to at least 1.5 times the OBW.
RBW	10 kHz
VBW	30 kHz
Detector	RMS
Trace	Average
Sweep Time	Auto
Trace Average	100 times

3.3.3. Test Procedures

1. The transmitter output (antenna port) was connected RF switch to the spectrum analyzer.
2. Test was performed in accordance with Measurement of Digital Transmission Systems Operating under 558074 D01 DTS Meas Guidance v03r03, in section “Maximum power spectral density level in the fundamental emission Method AVGPS-1” , 06/09/2014.
3. Multiple antenna systems was performed in accordance KDB 662911 D01 v02 in-Band Power Spectral Density (PSD) Measurements (a) Measure and sum the spectra across the outputs (bin-by-bin summing).
4. This procedure may be used when the maximum (average) conducted output power was used to demonstrate compliance to the output power limit. The EUT must be configured to transmit continuously (duty cycle $\geq 98\%$) to ensure that measurements are made only when the EUT is transmitting at its maximum power control level (no transmitter off time is to be considered)..
5. Ensure that the number of measurement points in the sweep $\geq 2 \times \text{span/RBW}$ (use of a greater number of measurement points than this minimum requirement is recommended).
6. When measuring first spectral bin of output 1 is summed with that in the first spectral bin of output 2 and that from the first spectral bin of output 3 and so on up to the Nth output to obtain the value for the first
7. frequency bin of the summed spectrum. The summed spectrum value for each of the other frequency bins is computed in the same way.

3.3.4. Test Setup Layout

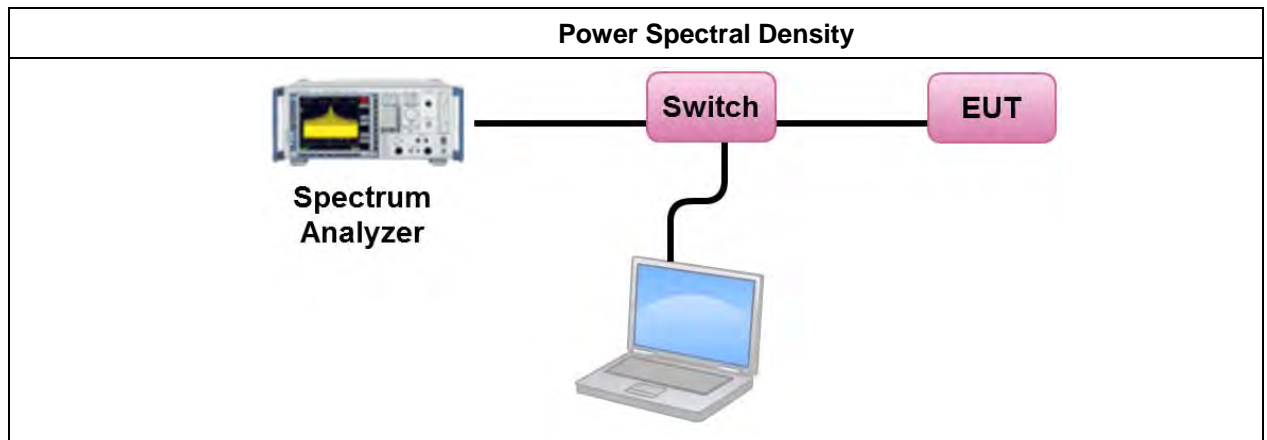

3.3.5. Test Deviation

There is no deviation with the original standard.

3.3.6. EUT Operation during Test

The EUT was programmed to be in continuously transmitting mode.

3.3.7. Test Result of Power Spectral Density

Test date	Aug. 20, 2015	Test Site No.	TH01-CB
Temperature	25°C	Humidity	51%
Test Engineer	Roki Liu	Configuration	802.11b
Duty Cycle	100%		

Configuration IEEE 802.11b

<Ant. 2>

Channel	Frequency	Total Power Density (dBm/10kHz)	Antenna Gain (dBi)	Max. Limit (dBm/3kHz)	Result
1	2412 MHz	-5.35	1.92	8.00	Complies
6	2437 MHz	-4.81	1.96	8.00	Complies
11	2462 MHz	-6.38	2.04	8.00	Complies

Power Density Plot on Configuration IEEE 802.11b / CH 1 / Ant. 2

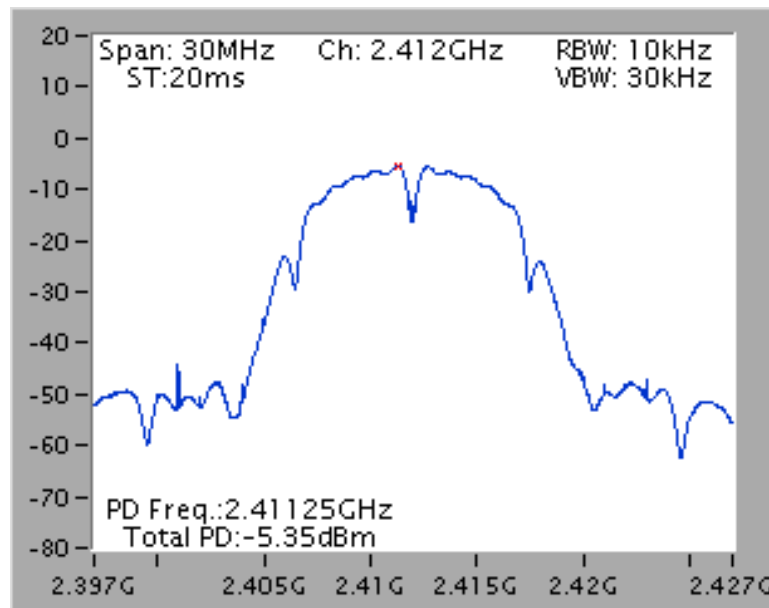

Power Density Plot on Configuration IEEE 802.11b / CH 6 / Ant. 2

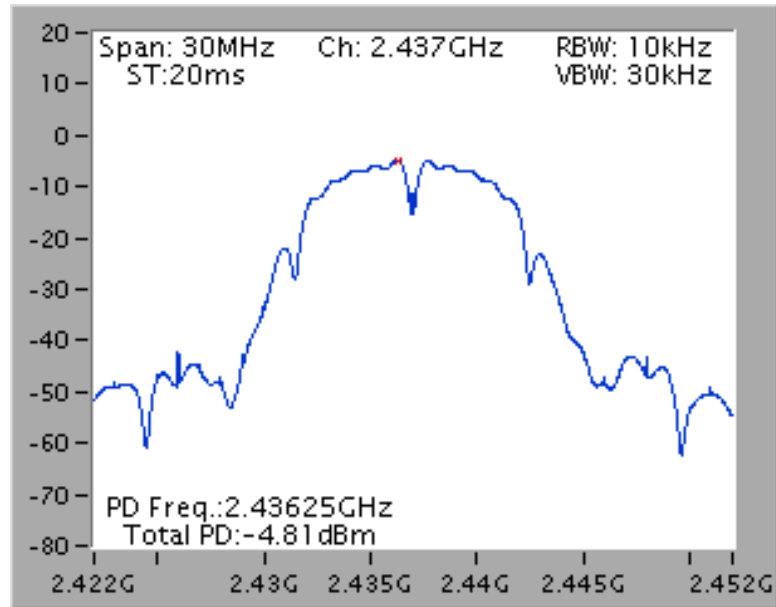

Power Density Plot on Configuration IEEE 802.11b / CH 11 / Ant. 2

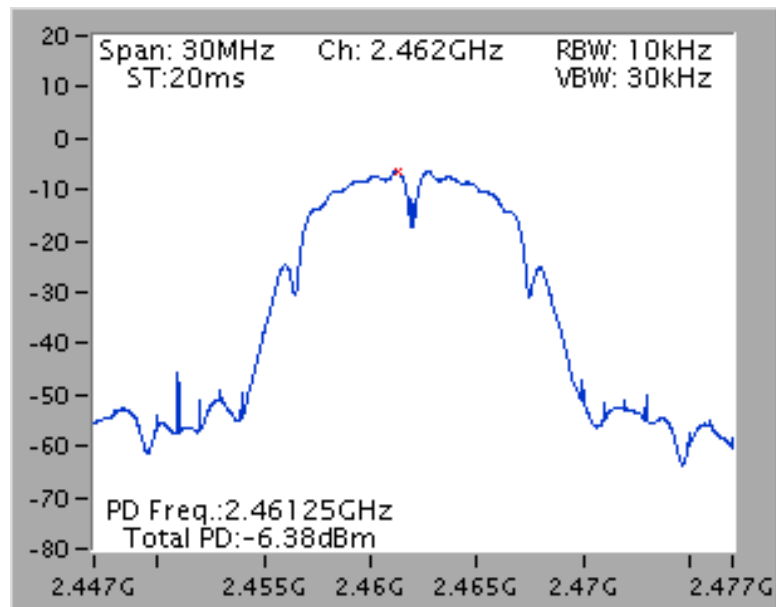

Test date	Aug. 20, 2015	Test Site No.	TH01-CB
Temperature	25°C	Humidity	58%
Test Engineer	Roki Liu	Configuration	802.11n 20MHz
Duty Cycle	98.34%		

Configuration IEEE 802.11n 20MHz

<MCS0, Ant. 2>

Channel	Frequency	Total Power Density (dBm/10kHz)	Antenna Gain (dBi)	Max. Limit (dBm/3kHz)	Result
1	2412 MHz	-14.54	1.92	8.00	Complies
6	2437 MHz	-11.13	1.96	8.00	Complies
11	2462 MHz	-13.33	2.04	8.00	Complies

Power Density Plot on Configuration of IEEE 802.11n 20MHz MCS0 / CH 1 / Ant. 2

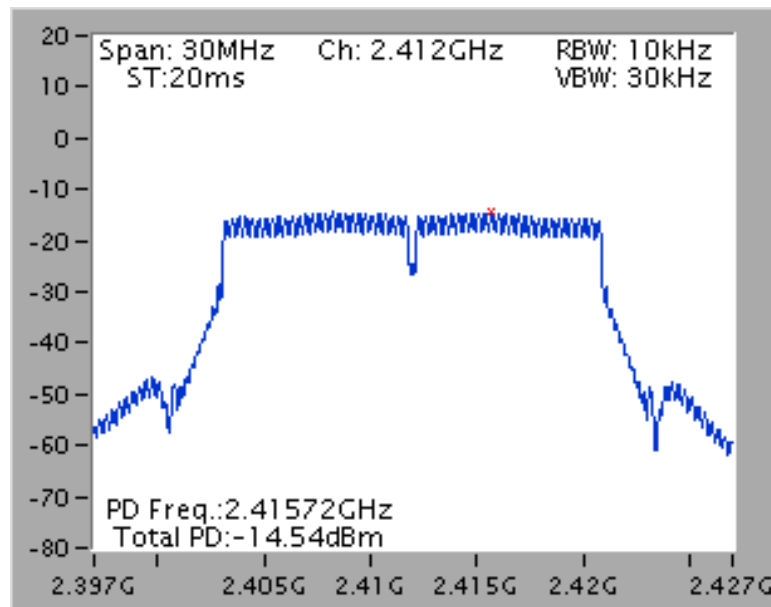

Power Density Plot on Configuration of IEEE 802.11n 20MHz MCS0 / CH 6 / Ant. 2

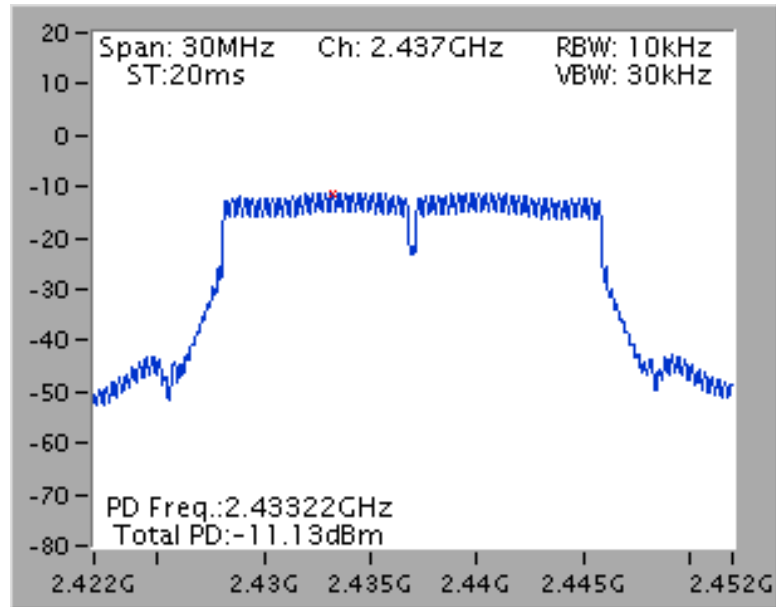

Power Density Plot on Configuration of IEEE 802.11n 20MHz MCS0 / CH 11 / Ant. 2

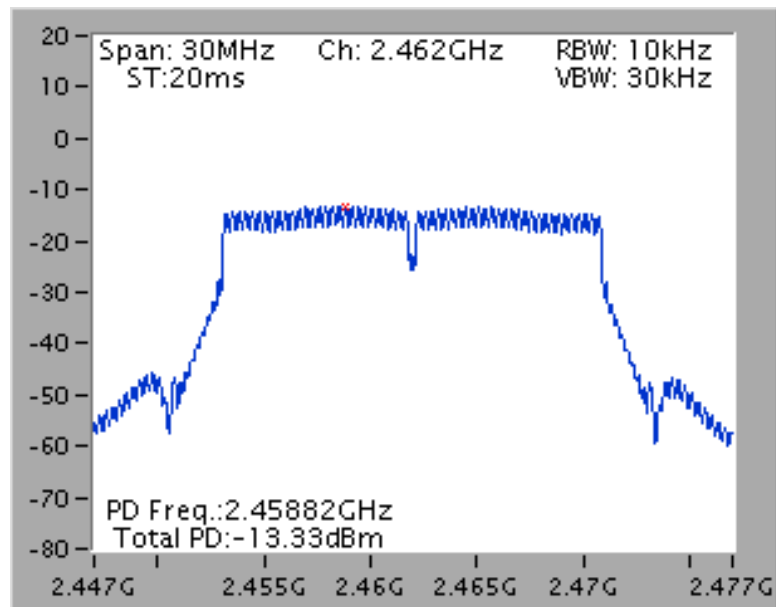

Test date	Aug. 20, 2015	Test Site No.	TH01-CB
Temperature	25°C	Humidity	51%
Test Engineer	Roki Liu	Configuration	802.11n 20MHz
Duty Cycle	98.76%		

<MCS0, Ant. 1+2, CDD>

Channel	Frequency	Total Power Density (dBm/10kHz)	Directional Gain (dBi)	Max. Limit (dBm/3kHz)	Result
1	2412 MHz	-12.27	5.47	8.00	Complies
6	2437 MHz	-8.17	5.28	8.00	Complies
11	2462 MHz	-11.87	5.63	8.00	Complies

Note:

2412 MHz=Directional Gain=5.47dBi <6dBi, so the limit doesn't reduce.

2437 MHz= Directional Gain =5.28dBi <6dBi, so the limit doesn't reduce.

2462 MHz= Directional Gain =5.63dBi <6dBi, so the limit doesn't reduce.

Power Density Plot on Configuration of IEEE 802.11n 20MHz MCS0 / CH 1 / Ant. 1+2, CDD

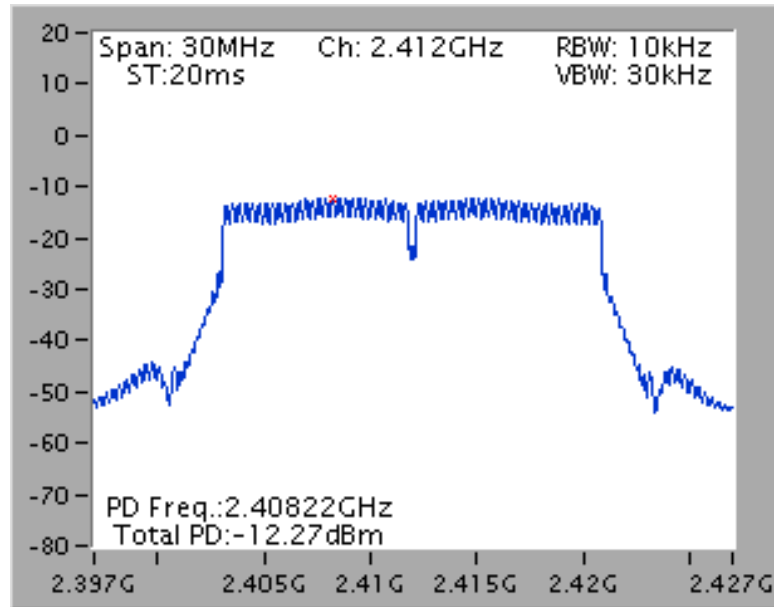

Power Density Plot on Configuration of IEEE 802.11n 20MHz MCS0 / CH 6 / Ant. 1+2, CDD

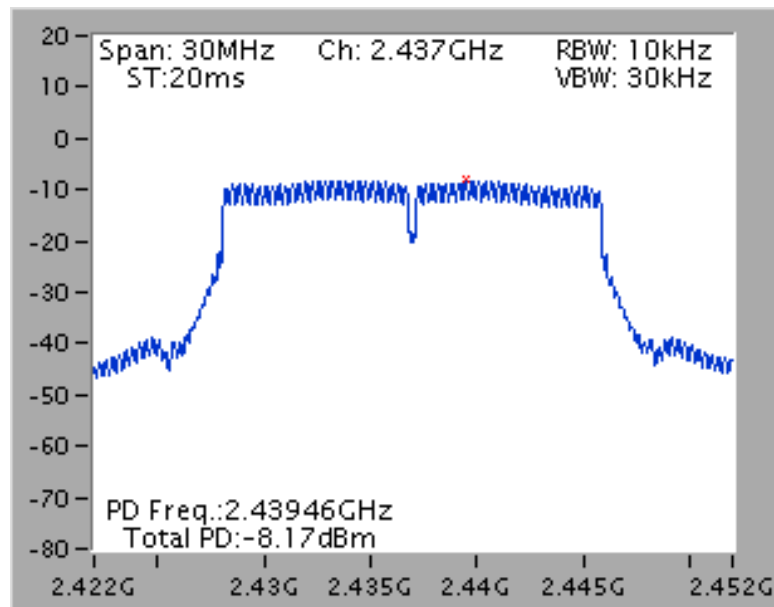

Power Density Plot on Configuration of IEEE 802.11n 20MHz MCS0 / CH 11 / Ant. 1+2, CDD

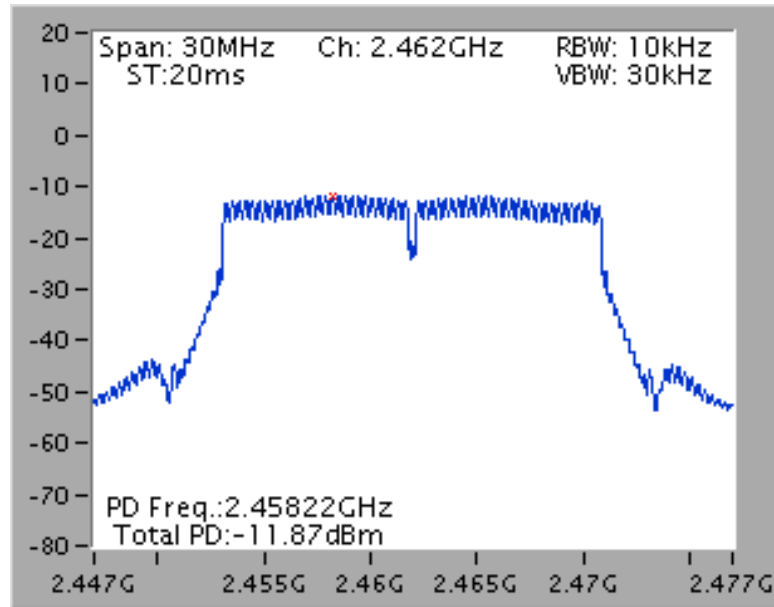

3.4. 6dB Spectrum Bandwidth Measurement

3.4.1. Limit

For digital modulation systems, the minimum 6dB bandwidth shall be at least 500 kHz.

3.4.2. Measuring Instruments and Setting

The following table is the setting of the spectrum analyzer.

Spectrum Parameters	Setting
Attenuation	Auto
Span Frequency	> 6dB Bandwidth
RBW	1-5 % of the emission bandwidth (EBW)
VBW	≥ 3 x RBW
Detector	Peak
Trace	Max Hold
Sweep Time	Auto

3.4.3. Test Procedures

1. The transmitter output (antenna port) was connected to the spectrum analyzer in peak hold mode.
2. The resolution bandwidth of 1-5 % of the emission bandwidth (EBW) and the video bandwidth of ≥ 3 x RBW were used.
3. Measured the spectrum width with power higher than 6d account by this measurement.

3.4.4. Test Setup Layout

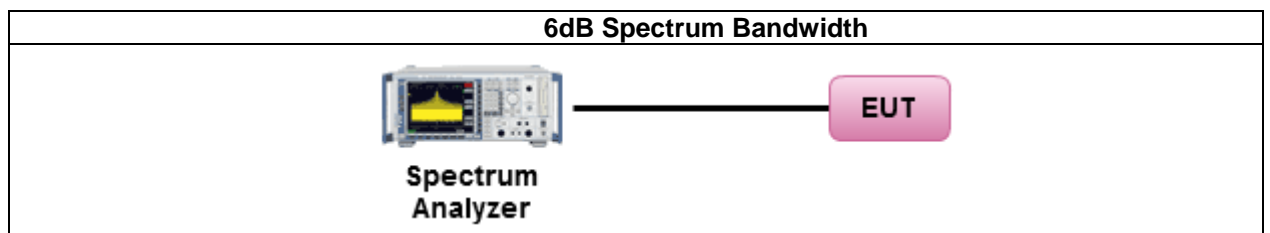

3.4.5. Test Deviation

There is no deviation with the original standard.

3.4.6. EUT Operation during Test

The EUT was programmed to be in continuously transmitting mode.

3.4.7. Test Result of 6dB Spectrum Bandwidth

Test date	Aug. 20, 2015	Test Site No.	TH01-CB
Temperature	25°C	Humidity	51%
Test Engineer	Roki Liu	Configuration	802.11b
Duty Cycle	100%		

Configuration IEEE 802.11b

<Ant. 2>

Channel	Frequency	6dB Bandwidth (MHz)	99% Occupied Bandwidth (MHz)	Min. Limit (kHz)	Test Result
1	2412 MHz	8.06	10.25	500	Complies
6	2437 MHz	8.00	10.33	500	Complies
11	2462 MHz	8.06	10.25	500	Complies

<Ant. 2>

6 dB Bandwidth Plot on Configuration IEEE 802.11b / CH 1 / Ant. 2

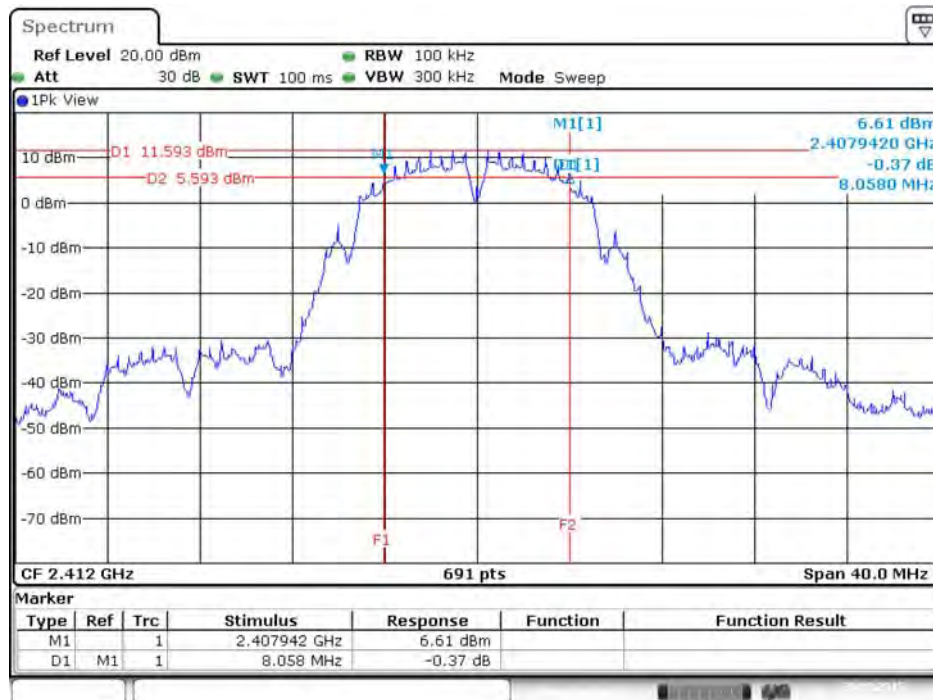

Date: 20.AUG.2015 11:47:24

6 dB Bandwidth Plot on Configuration IEEE 802.11b / CH 6 / Ant. 2

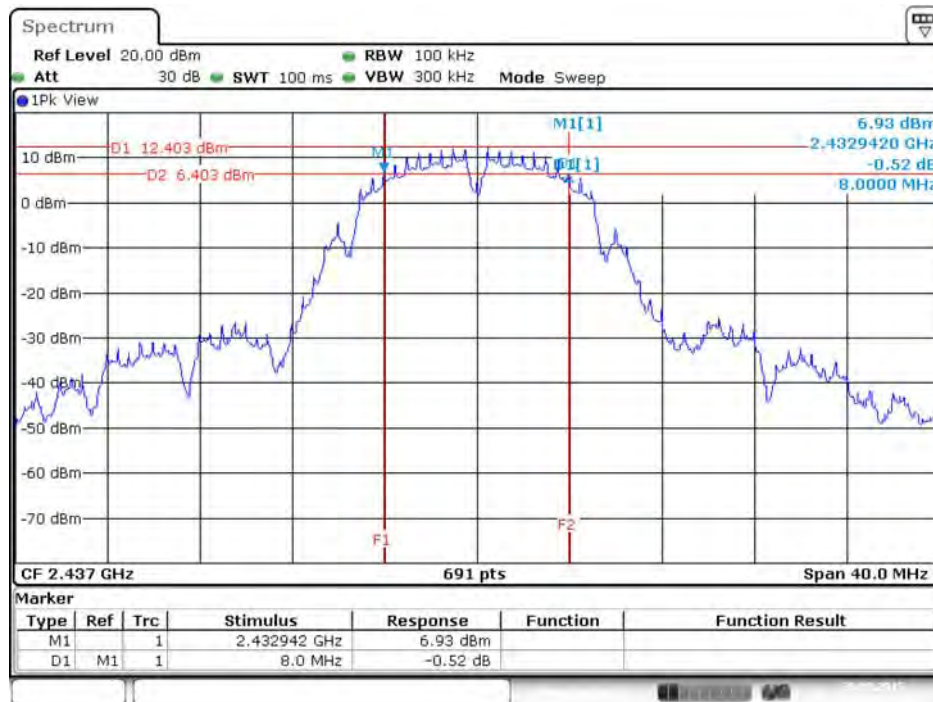

Date: 20.AUG.2015 11:48:02

6 dB Bandwidth Plot on Configuration IEEE 802.11b / CH 11 / Ant. 2

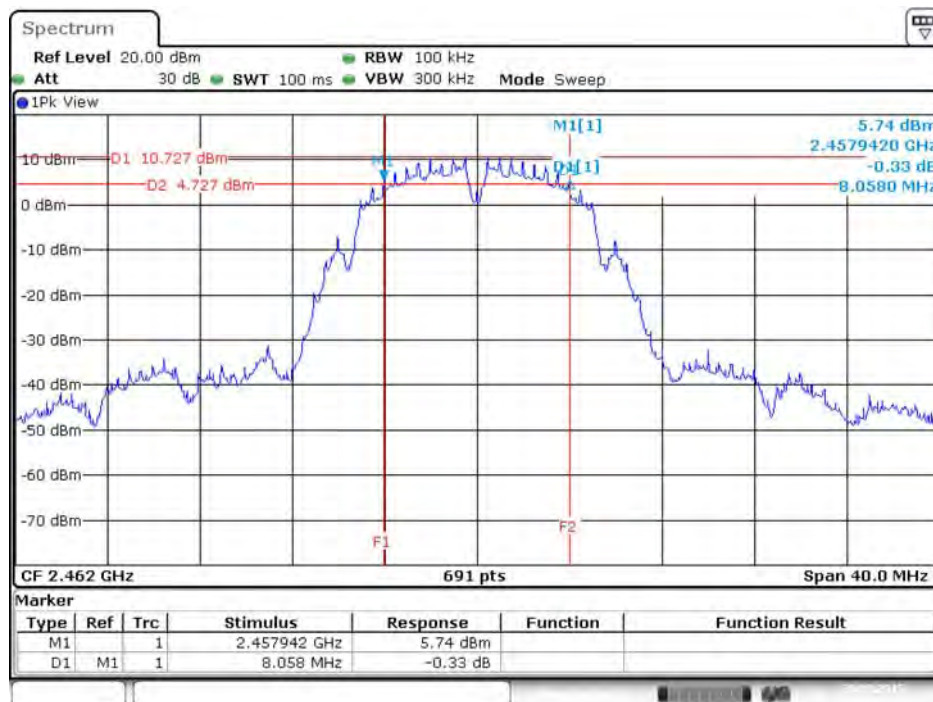

Date: 20.AUG.2015 11:48:37

Test date	Aug. 20, 2015	Test Site No.	TH01-CB
Temperature	25°C	Humidity	58%
Test Engineer	Roki Liu	Configuration	802.11n 20MHz
Duty Cycle	98.34%		

Configuration IEEE 802.11n 20MHz

<Ant. 2>

Channel	Frequency	6dB Bandwidth (MHz)	99% Occupied Bandwidth (MHz)	Min. Limit (kHz)	Test Result
1	2412 MHz	17.57	17.89	500	Complies
6	2437 MHz	17.57	18.06	500	Complies
11	2462 MHz	17.57	17.97	500	Complies

<Ant. 2>

6 dB Bandwidth Plot on Configuration of IEEE 802.11n 20MHz MCS0 / CH 1 / Ant. 2

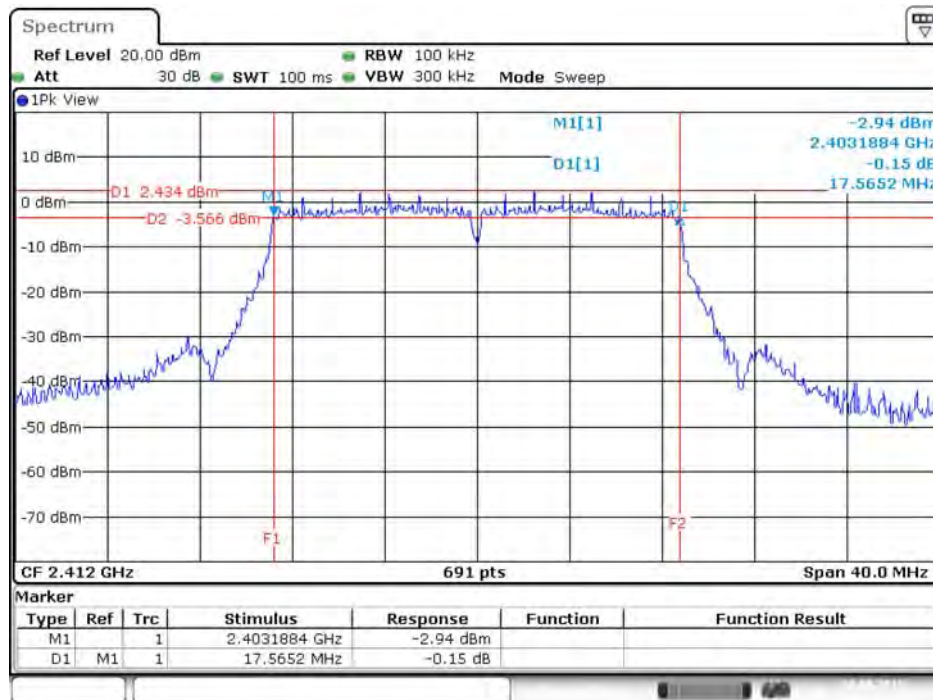

Date: 20.AUG.2015 11:44:35

6 dB Bandwidth Plot on Configuration of IEEE 802.11n 20MHz MCS0 / CH 6 / Ant. 2

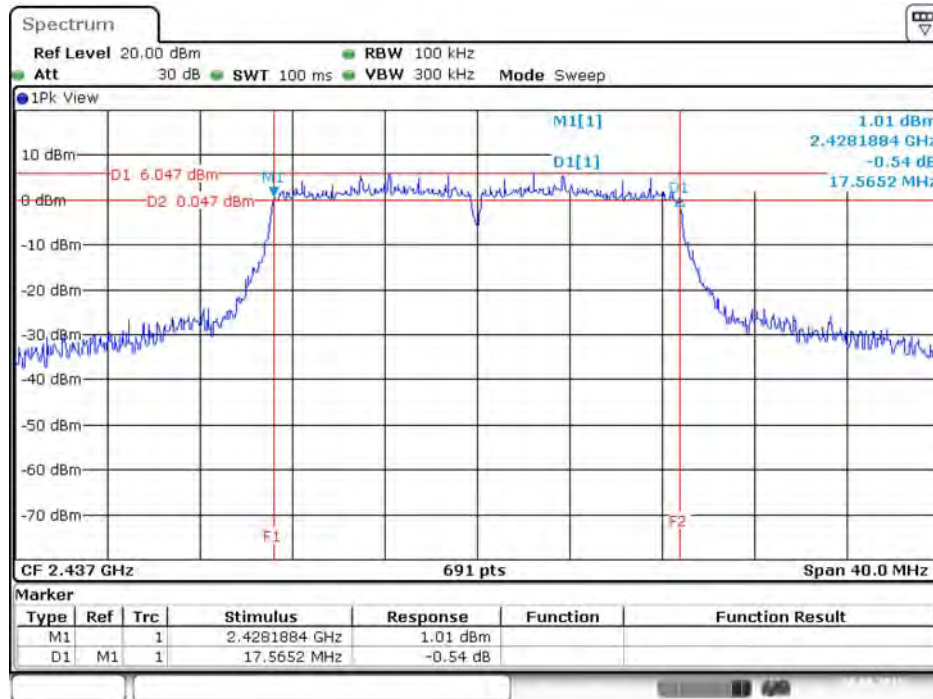

Date: 20.AUG.2015 11:45:28

6 dB Bandwidth Plot on Configuration of IEEE 802.11n 20MHz MCS0 / CH 11 / Ant. 2

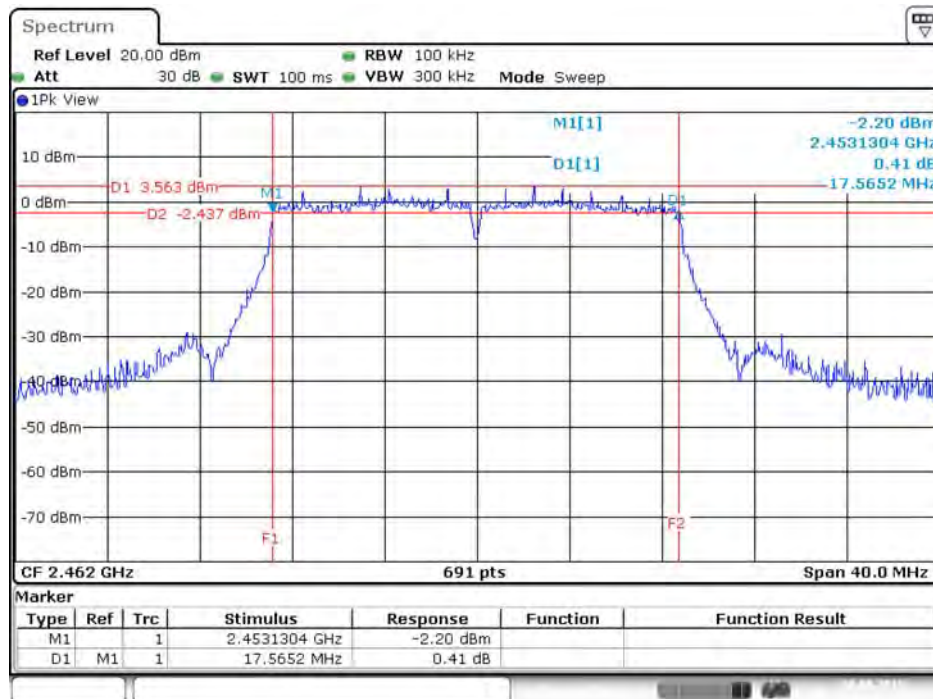

Date: 20.AUG.2015 11:46:12

Test date	Aug. 20, 2015	Test Site No.	TH01-CB
Temperature	25°C	Humidity	58%
Test Engineer	Roki Liu	Configuration	802.11n 20MHz
Duty Cycle	98.76%		

<MCS0, Ant. 1+2, CDD>

Channel	Frequency	6dB Bandwidth (MHz)		99% Occupied Bandwidth (MHz)		Min. Limit (kHz)	Test Result
		Ant. 1	Ant. 2	Ant. 1	Ant. 2		
1	2412 MHz	17.62	17.62	17.89	17.80	500	Complies
6	2437 MHz	17.57	17.62	17.97	17.89	500	Complies
11	2462 MHz	17.62	17.62	17.97	17.80	500	Complies

<MCS0, Ant. 1+2, CDD>

6 dB Bandwidth Plot on Configuration of IEEE 802.11n 20MHz MCS0 / CH 1 / Ant. 1

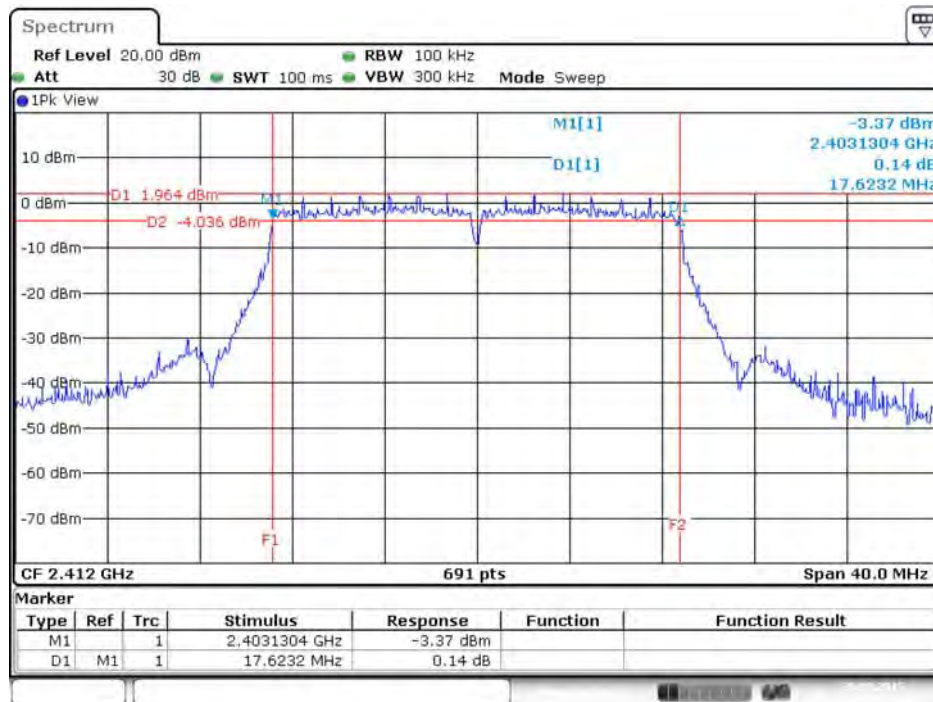

Date: 20.AUG.2015 11:38:45

6 dB Bandwidth Plot on Configuration of IEEE 802.11n 20MHz MCS0 / CH 6 / Ant. 1

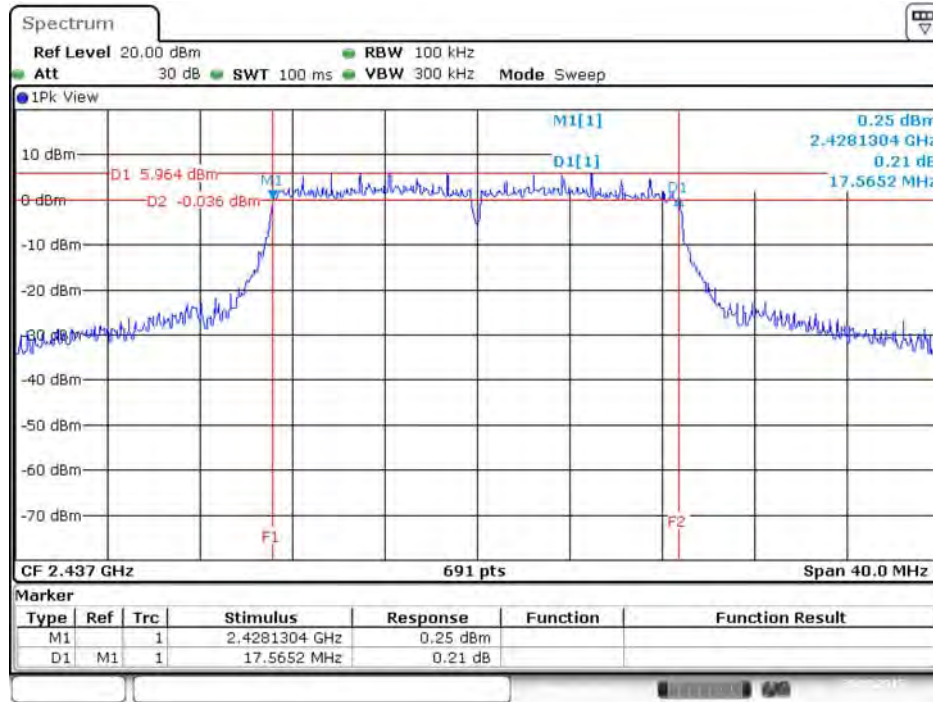

Date: 20.AUG.2015 11:41:16

6 dB Bandwidth Plot on Configuration of IEEE 802.11n 20MHz MCS0 / CH 11 / Ant. 1

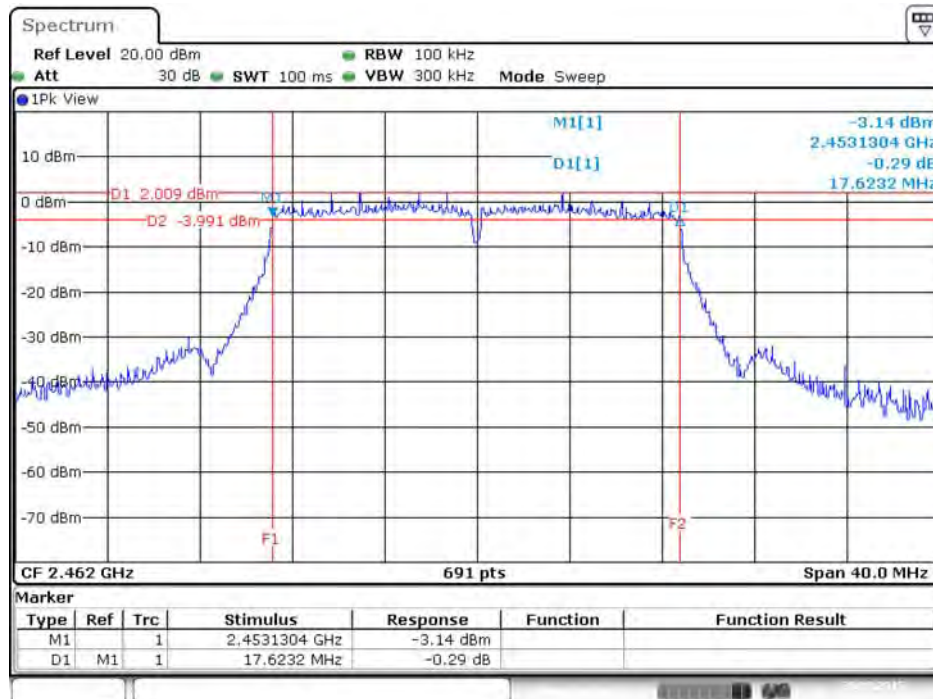

Date: 20.AUG.2015 11:41:57

6 dB Bandwidth Plot on Configuration of IEEE 802.11n 20MHz MCS0 / CH 1 / Ant. 2

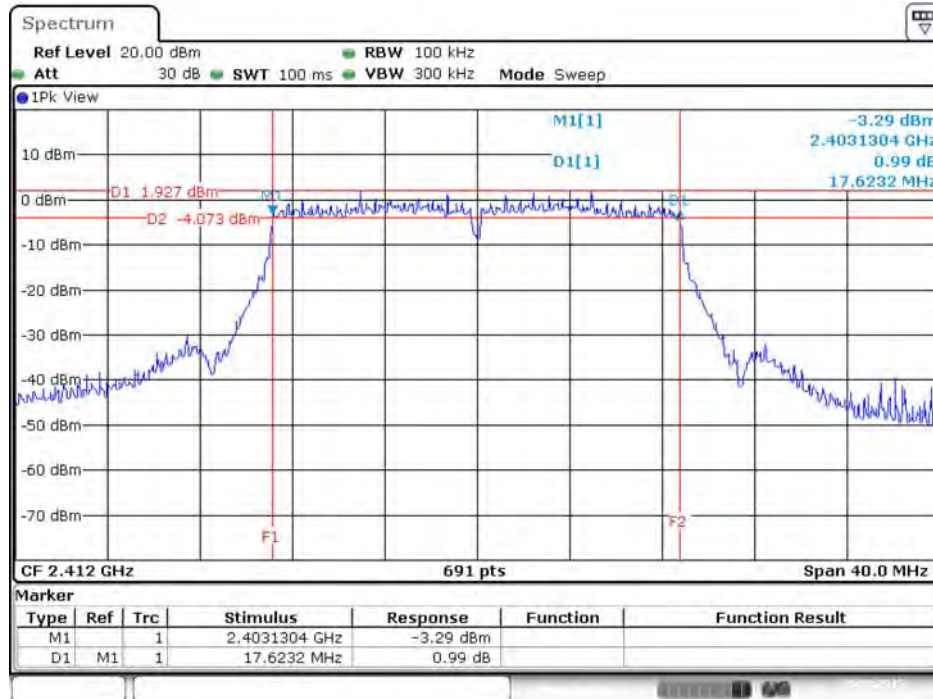

Date: 20.AUG.2015 11:39:34

6 dB Bandwidth Plot on Configuration of IEEE 802.11n 20MHz MCS0 / CH 6 / Ant. 2

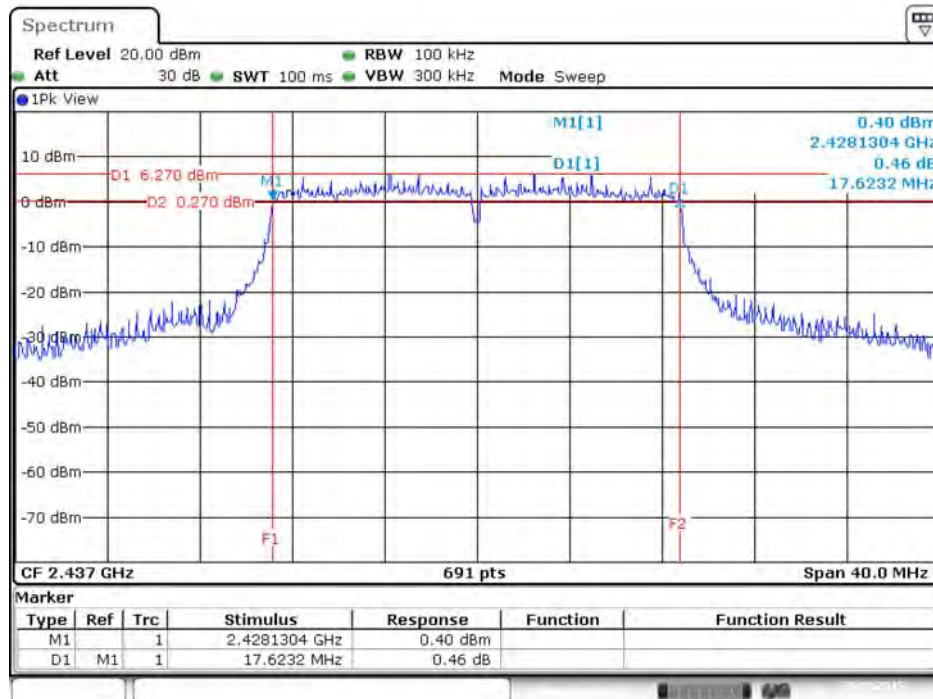

Date: 20.AUG.2015 11:40:31

6 dB Bandwidth Plot on Configuration of IEEE 802.11n 20MHz MCS0 / CH 11 / Ant. 2

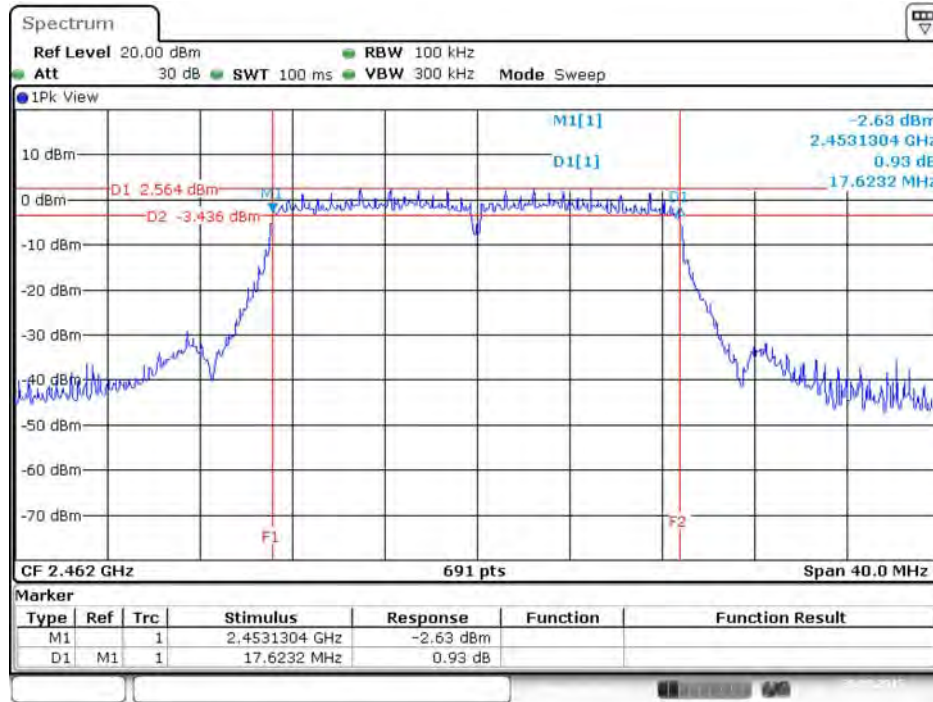

Date: 20.AUG.2015 11:42:36

3.5. Radiated Emissions Measurement

3.5.1. Limit

30dBc in any 100 kHz bandwidth outside the operating frequency band. In case the emission fall within the restricted band specified on 15.205(a), then the 15.209(a) limit in the table below has to be followed.

Frequencies (MHz)	Field Strength (microvolt/meter)	Measurement Distance (meters)
0.009~0.490	2400/F(kHz)	300
0.490~1.705	24000/F(kHz)	30
1.705~30.0	30	30
30~88	100	3
88~216	150	3
216~960	200	3
Above 960	500	3

3.5.2. Measuring Instruments and Setting

Please refer to section 4 of equipments list in this report. The following table is the setting of spectrum analyzer and receiver.

Spectrum Parameter	Setting
Attenuation	Auto
Start Frequency	1GHz
Stop Frequency	10th carrier harmonic
RBW / VBW (Emission in restricted band)	1MHz / 3MHz for Peak, 1MHz / 1/T for Average
RBW / VBW (Emission in non-restricted band)	100kHz / 300kHz for peak

Receiver Parameter	Setting
Attenuation	Auto
Start ~ Stop Frequency	9kHz~150kHz / RBW 200Hz for QP
Start ~ Stop Frequency	150kHz~30MHz / RBW 9kHz for QP
Start ~ Stop Frequency	30MHz~1GHz / RBW 120kHz for QP

3.5.3. Test Procedures

1. Configure the EUT according to ANSI C63.10. The EUT was placed on the top of the turntable 1.5 meter above ground. The phase center of the receiving antenna mounted on the top of a height-variable antenna tower was placed 3 meters far away from the turntable.
2. Power on the EUT and all the supporting units. The turntable was rotated by 360 degrees to determine the position of the highest radiation.
3. The height of the broadband receiving antenna was varied between one meter and four meters above ground to find the maximum emissions field strength of both horizontal and vertical polarization.
4. For each suspected emissions, the antenna tower was scan (from 1 m to 4 m) and then the turntable was rotated (from 0 degree to 360 degrees) to find the maximum reading.
5. Set the test-receiver system to Peak or CISPR quasi-peak Detect Function with specified bandwidth under Maximum Hold Mode.
6. For emissions above 1GHz, use 1MHz VBW and 3MHz RBW for peak reading. Then 1MHz RBW and 1/T VBW for average reading in spectrum analyzer.
7. When the radiated emissions limits are expressed in terms of the average value of the emissions, and pulsed operation is employed, the measurement field strength shall be determined by averaging over one complete pulse train, including blanking intervals, as long as the pulse train does not exceed 0.1 seconds. As an alternative (provided the transmitter operates for longer than 0.1 seconds) or in cases where the pulse train exceeds 0.1 seconds, the measured field strength shall be determined from the average absolute voltage during a 0.1 second interval during which the field strength is at its maximum value.
8. If the emissions level of the EUT in peak mode was 3 dB lower than the average limit specified, then testing will be stopped and peak values of EUT will be reported, otherwise, the emissions which do not have 3 dB margin will be repeated one by one using the quasi-peak method for below 1GHz.
9. For testing above 1GHz, the emissions level of the EUT in peak mode was lower than average limit (that means the emissions level in peak mode also complies with the limit in average mode), then testing will be stopped and peak values of EUT will be reported, otherwise, the emissions will be measured in average mode again and reported.
10. In case the emission is lower than 30MHz, loop antenna has to be used for measurement and the recorded data should be QP measured by receiver. High – Low scan is not required in this case.

3.5.4. Test Setup Layout

For Radiated Emissions below 30MHz (9kHz~30MHz)

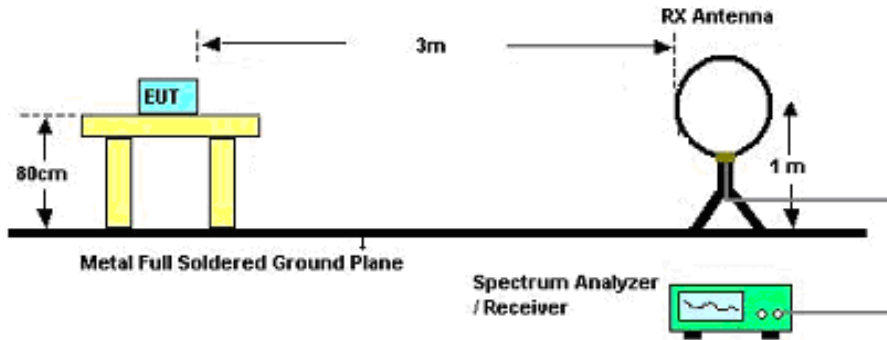

For Radiated Emissions below 1GHz (30MHz~1GHz)

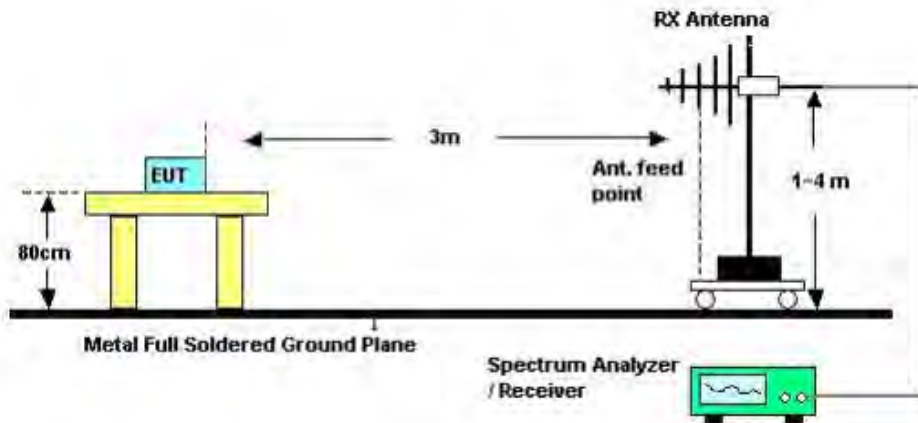

For Radiated Emissions above 1GHz

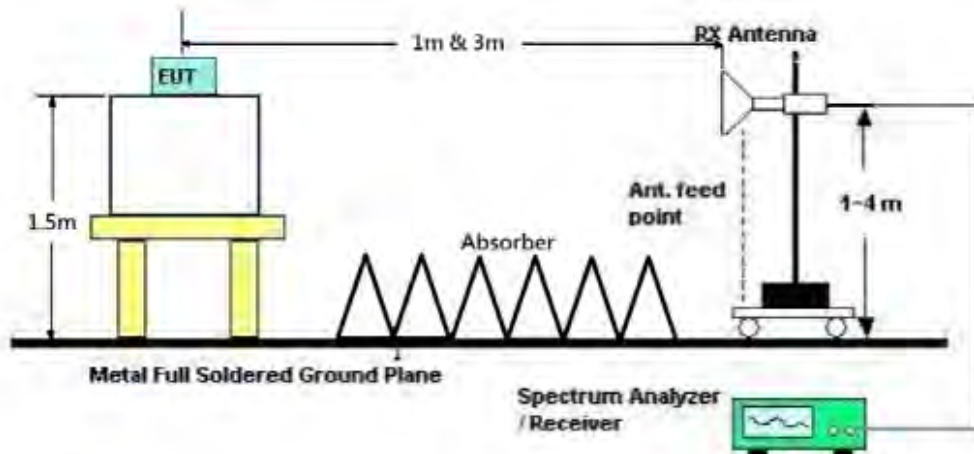

3.5.5. Test Deviation

There are no deviations with the original standard.

3.5.6. EUT Operation during Test

The EUT was programmed to be in continuously transmitting mode.

3.5.7. Results of Radiated Emissions (9kHz~30MHz)

Frequency Range	9kHz~30MHz	Test Site No.	03CH01-CB
Temperature	24.9°C	Humidity	57%
Test Engineer	Eric Fu	Configurations	802.11n
Test Date	Aug. 17, 2015		

Freq. (MHz)	Level (dBuV)	Over Limit (dB)	Limit Line (dBuV)	Remark
-	-	-	-	See Note

Note:

The amplitude of spurious emissions that are attenuated by more than 20 dB below the permissible value has no need to be reported.

Distance extrapolation factor = 40 log (specific distance / test distance) (dB);

Limit line = specific limits (dBuV) + distance extrapolation factor.

3.5.8. Results of Radiated Emissions (30MHz~1GHz)

Frequency Range	30MHz~1GHz	Test Site No.	03CH01-CB
Temperature	24.9°C	Humidity	57%
Test Engineer	Eric Fu	Configurations	802.11n

Horizontal

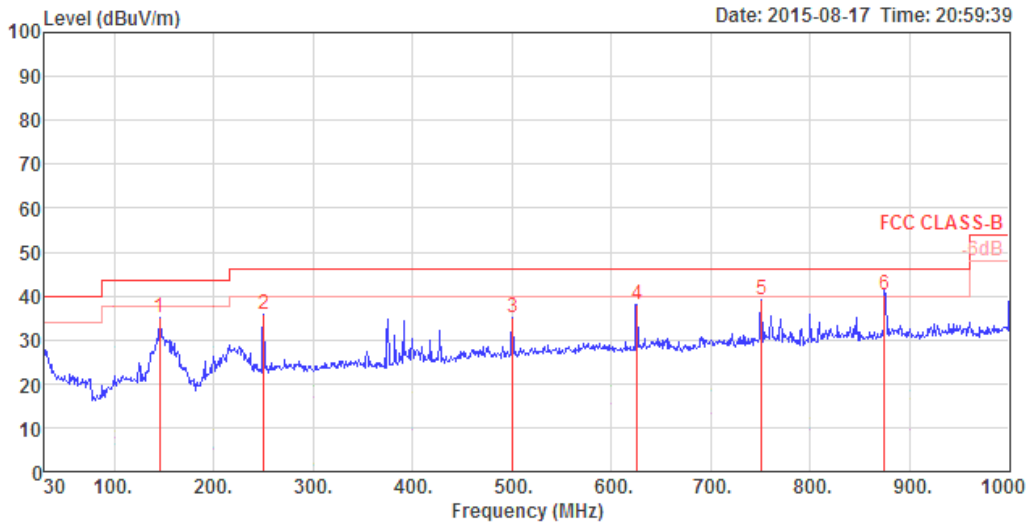

	Freq	Level	Limit	Over	Read	CableAntenna	Preamp	A/Pos	T/Pos	Remark	Pol/Phase
	MHz	dBuV/m	dBuV/m	dB	dBuV	dB	dB/m	dB	cm	deg	
1	145.43	35.10	43.50	-8.40	54.76	1.09	11.61	32.36	200	115	Peak HORIZONTAL
2	250.19	35.75	46.00	-10.25	53.77	1.38	12.90	32.30	100	280	Peak HORIZONTAL
3	500.45	35.02	46.00	-10.98	47.64	1.90	17.83	32.35	100	87	Peak HORIZONTAL
4	625.58	37.99	46.00	-8.01	48.95	2.08	19.36	32.40	175	102	Peak HORIZONTAL
5	750.71	39.11	46.00	-6.89	48.79	2.22	20.40	32.30	125	237	Peak HORIZONTAL
6	874.87	40.39	46.00	-5.61	48.35	2.40	21.50	31.86	125	99	QP HORIZONTAL

Note:

The amplitude of spurious emissions which are attenuated by more than 20 dB below the permissible value has no need to be reported.

Emission level (dBuV/m) = 20 log Emission level (uV/m).

Corrected Reading: Antenna Factor + Cable Loss + Read Level - Preamp Factor = Level.

Vertical

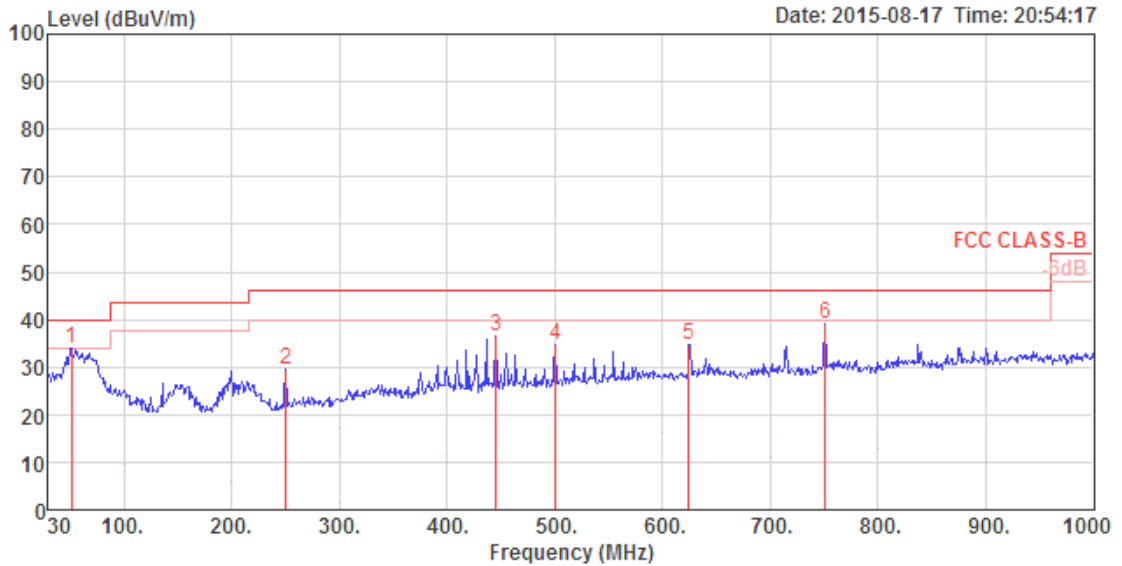

	Freq	Level	Limit Line	Over Limit	Read Level	CableAntenna Loss	Preamp Factor	A/Pos	T/Pos	Remark	Pol/Phase
	MHz	dBuV/m	dBuV/m	dB	dBuV	dB	dB/m	dB	cm	deg	
1	51.34	33.82	40.00	-6.18	56.78	0.73	8.72	32.41	100	296 Peak	VERTICAL
2	250.19	29.68	46.00	-16.32	47.70	1.38	12.90	32.30	200	220 Peak	VERTICAL
3	445.16	36.37	46.00	-9.63	49.85	1.81	17.05	32.34	150	75 Peak	VERTICAL
4	500.45	34.86	46.00	-11.14	47.48	1.90	17.83	32.35	125	300 Peak	VERTICAL
5	624.61	34.83	46.00	-11.17	45.79	2.08	19.36	32.40	100	69 Peak	VERTICAL
6	750.71	39.03	46.00	-6.97	48.71	2.22	20.40	32.30	100	54 Peak	VERTICAL

Note:

The amplitude of spurious emissions which are attenuated by more than 20 dB below the permissible value has no need to be reported.

Emission level (dBuV/m) = 20 log Emission level (uV/m).

Corrected Reading: Antenna Factor + Cable Loss + Read Level - Preamp Factor = Level.

3.5.9. Results for Radiated Emissions (1GHz~10th Harmonic)

Following channel(s) was (were) selected for the final test as listed below.

MODE	TX Chain	TESTED CHANNEL	MODULATION TECHNOLOGY	MODULATION TYPE	DATA RATE (Mbps)
802.11b	Ant. 2	1, 6, 11	DSSS	DBPSK	1
802.11n 20MHz	Ant. 2	1, 6, 11	OFDM	BPSK	MCS0 (6.5)
802.11n 20MHz	Ant. 1+2, CDD	1, 6, 11	OFDM	BPSK	MCS0 (6.5)

Transmitter Radiated Emissions (1GHz~10th Harmonic)					
Operating Mode	IEEE 802.11b / CH 1 / Ant. 2			Polarization	H
Temperature	24.9°C	Humidity	57%	Test Engineer	Eric Fu

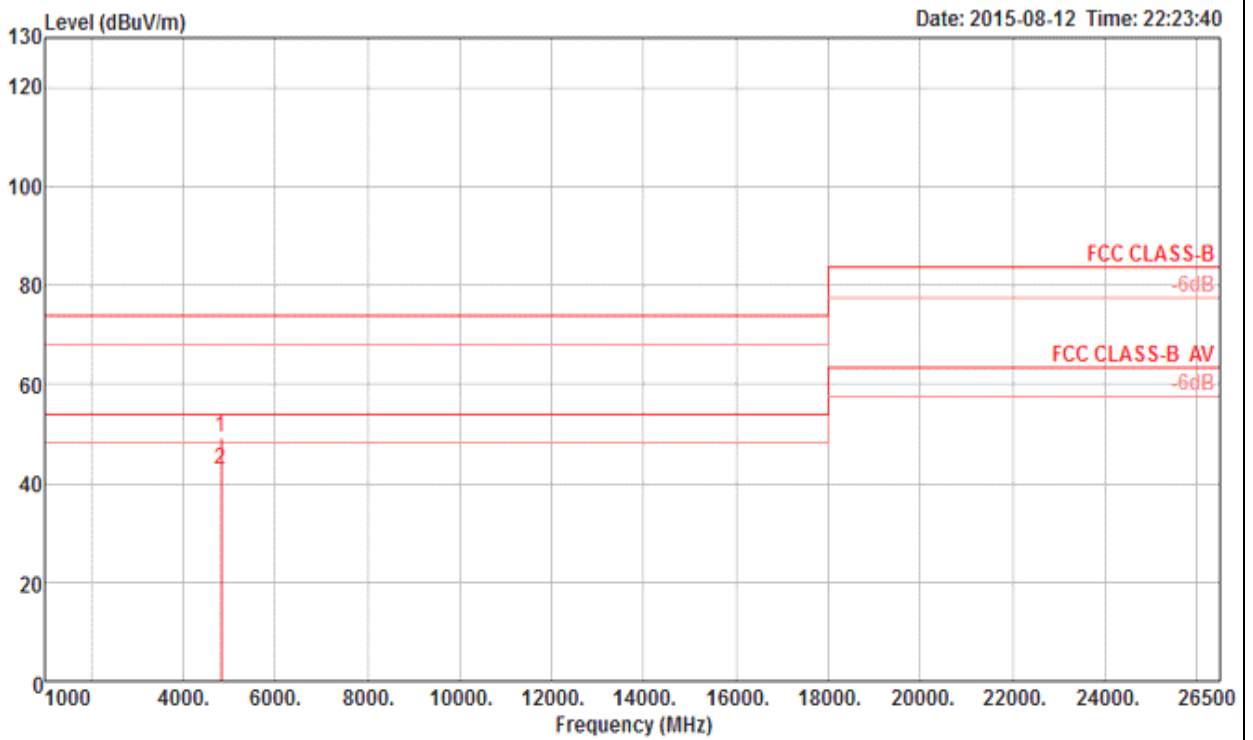

	Freq	Level	Limit	Over	Read	CableAntenna	Preamp	Remark	A/Pos	T/Pos	Pol/Phase
	MHz	dBuV/m	dBuV/m	dB	dBuV	dB	dB/m	dB	cm	deg	
1	4823.66	49.15	74.00	-24.85	44.87	5.87	33.42	35.01 Peak	191	59	HORIZONTAL
2	4823.90	42.80	54.00	-11.20	38.52	5.87	33.42	35.01 Average	191	59	HORIZONTAL

Note 1: The amplitude of spurious emissions which are attenuated by more than 20 dB below the permissible value has no need to be reported.
 Note 2: Emission level (dBuV/m) = 20 log Emission level (uV/m).
 Note 3: Corrected Reading: Antenna Factor + Cable Loss + Read Level - Preamp Factor = Level.
 Note 4: Measurement receive antenna polarization: H (Horizontal), V (Vertical)

Transmitter Radiated Emissions (1GHz~10th Harmonic)					
Operating Mode	IEEE 802.11b / CH 1 / Ant. 2			Polarization	V
Temperature	24.9°C	Humidity	57%	Test Engineer	Eric Fu

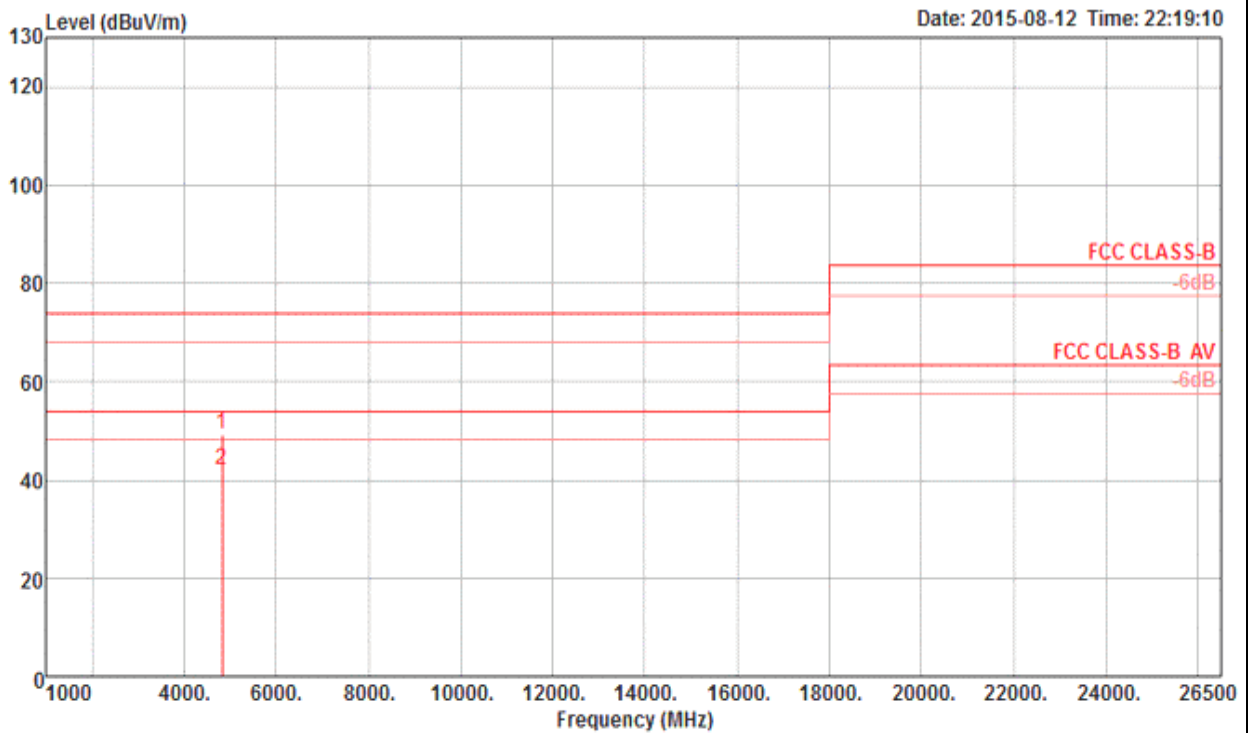

	Freq	Level	Limit	Over	Read	CableAntenna	Preamp	Remark	A/Pos	T/Pos	Pol/Phase
	MHz	dBuV/m	dBuV/m	dB	dBuV	dB	dB/m	dB	cm	deg	
1	4823.80	49.32	74.00	-24.68	45.04	5.87	33.42	35.01 Peak	166	178	VERTICAL
2	4823.92	42.09	54.00	-11.91	37.81	5.87	33.42	35.01 Average	166	178	VERTICAL

Note 1: The amplitude of spurious emissions which are attenuated by more than 20 dB below the permissible value has no need to be reported.
 Note 2: Emission level (dBuV/m) = 20 log Emission level (uV/m).
 Note 3: Corrected Reading: Antenna Factor + Cable Loss + Read Level - Preamp Factor = Level.
 Note 4: Measurement receive antenna polarization: H (Horizontal), V (Vertical)

Transmitter Radiated Emissions (1GHz~10th Harmonic)					
Operating Mode	IEEE 802.11b / CH 6 / Ant. 2			Polarization	H
Temperature	24.9°C	Humidity	57%	Test Engineer	Eric Fu

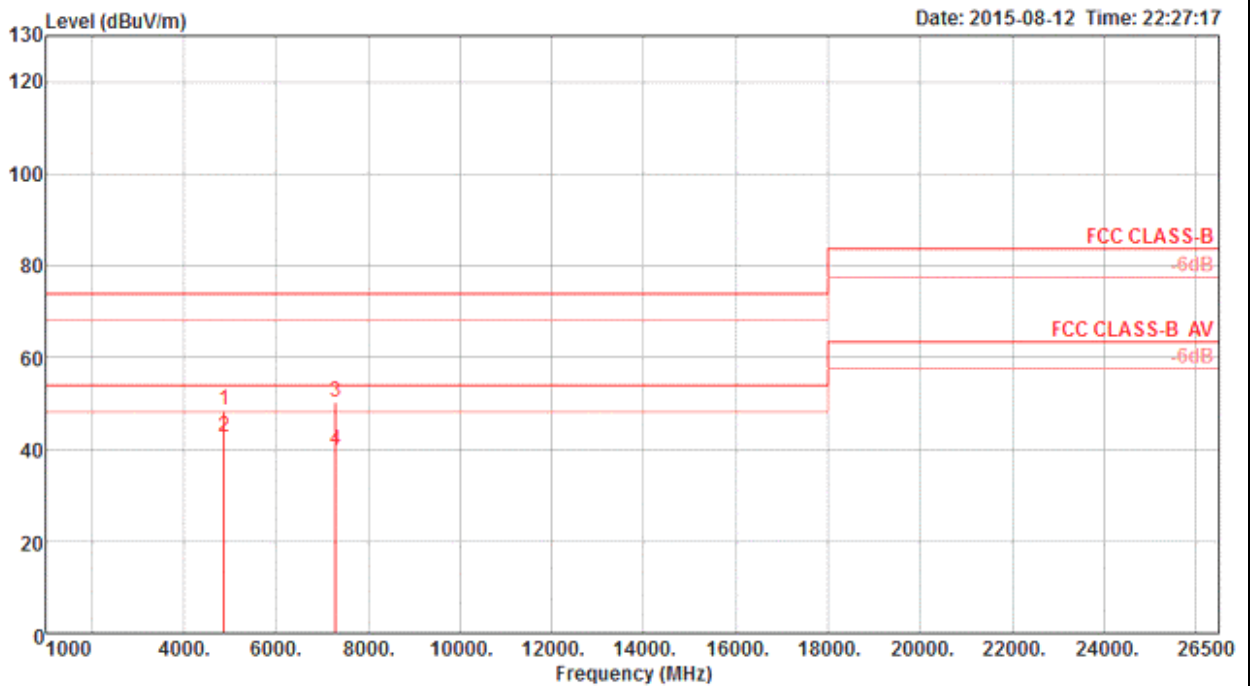

	Freq	Level	Limit	Over	Read	Cable	Antenna	Preamp	Remark	A/Pos	T/Pos	Pol/Phase
	MHz	dBuV/m	dBuV/m	dB	dBuV	dB	dB/m	dB		cm	deg	
1	4873.69	48.51	74.00	-25.49	44.07	5.92	33.53	35.01	Peak	198	60	HORIZONTAL
2	4873.94	42.64	54.00	-11.36	38.20	5.92	33.53	35.01	Average	198	60	HORIZONTAL
3	7309.49	50.31	74.00	-23.69	42.08	7.13	36.38	35.28	Peak	140	107	HORIZONTAL
4	7311.64	39.75	54.00	-14.25	31.52	7.13	36.38	35.28	Average	140	107	HORIZONTAL

Note 1: The amplitude of spurious emissions which are attenuated by more than 20 dB below the permissible value has no need to be reported.
 Note 2: Emission level (dBuV/m) = 20 log Emission level (uV/m).
 Note 3: Corrected Reading: Antenna Factor + Cable Loss + Read Level - Preamp Factor = Level.
 Note 4: Measurement receive antenna polarization: H (Horizontal), V (Vertical)

Transmitter Radiated Emissions (1GHz~10th Harmonic)					
Operating Mode	IEEE 802.11b / CH 6 / Ant. 2			Polarization	V
Temperature	24.9°C	Humidity	57%	Test Engineer	Eric Fu

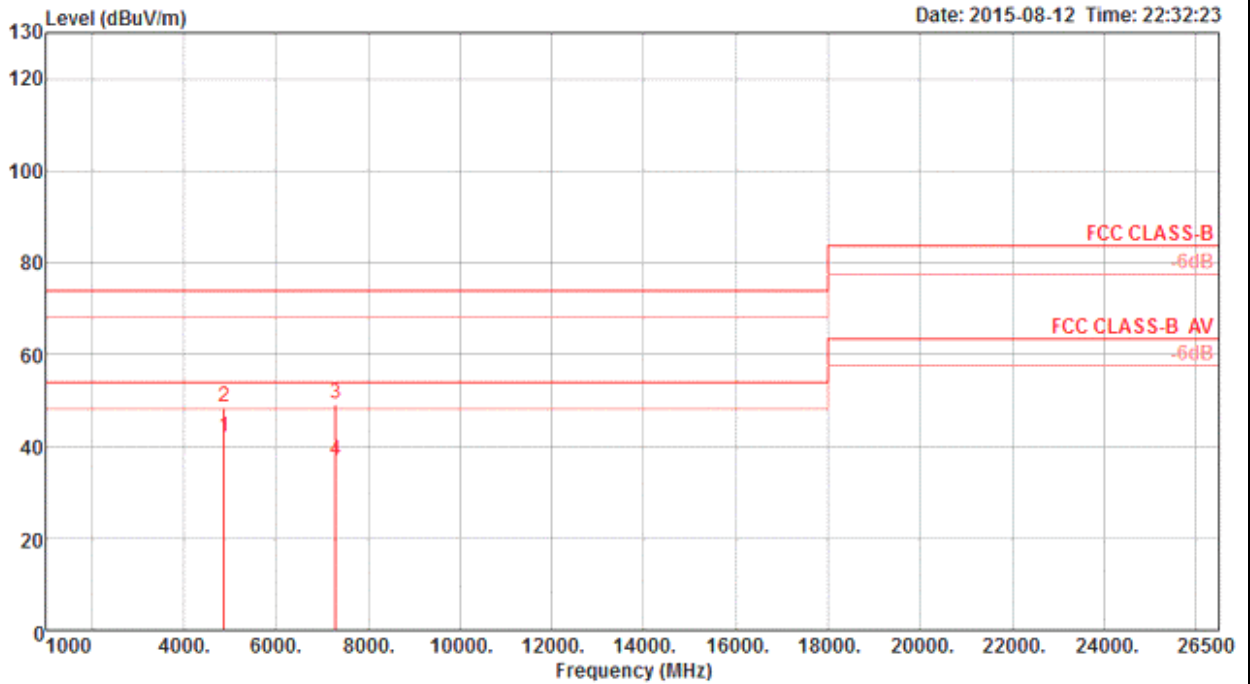

	Freq	Level	Limit	Over	Read	CableAntenna	Preamp	Remark	A/Pos	T/Pos	Pol/Phase
	MHz	dBuV/m	dBuV/m	dB	dBuV	dB	dB/m	dB	cm	deg	
1	4873.86	42.07	54.00	-11.93	37.63	5.92	33.53	35.01 Average	164	184	VERTICAL
2	4873.90	48.41	74.00	-25.59	43.97	5.92	33.53	35.01 Peak	164	184	VERTICAL
3	7304.21	49.17	74.00	-24.83	40.94	7.13	36.38	35.28 Peak	182	248	VERTICAL
4	7310.10	36.78	54.00	-17.22	28.55	7.13	36.38	35.28 Average	182	248	VERTICAL

Note 1: The amplitude of spurious emissions which are attenuated by more than 20 dB below the permissible value has no need to be reported.
 Note 2: Emission level (dBuV/m) = 20 log Emission level (uV/m).
 Note 3: Corrected Reading: Antenna Factor + Cable Loss + Read Level - Preamp Factor = Level.
 Note 4: Measurement receive antenna polarization: H (Horizontal), V (Vertical)

Transmitter Radiated Emissions (1GHz~10th Harmonic)					
Operating Mode	IEEE 802.11b / CH 11 / Ant. 2			Polarization	H
Temperature	24.9°C	Humidity	57%	Test Engineer	Eric Fu

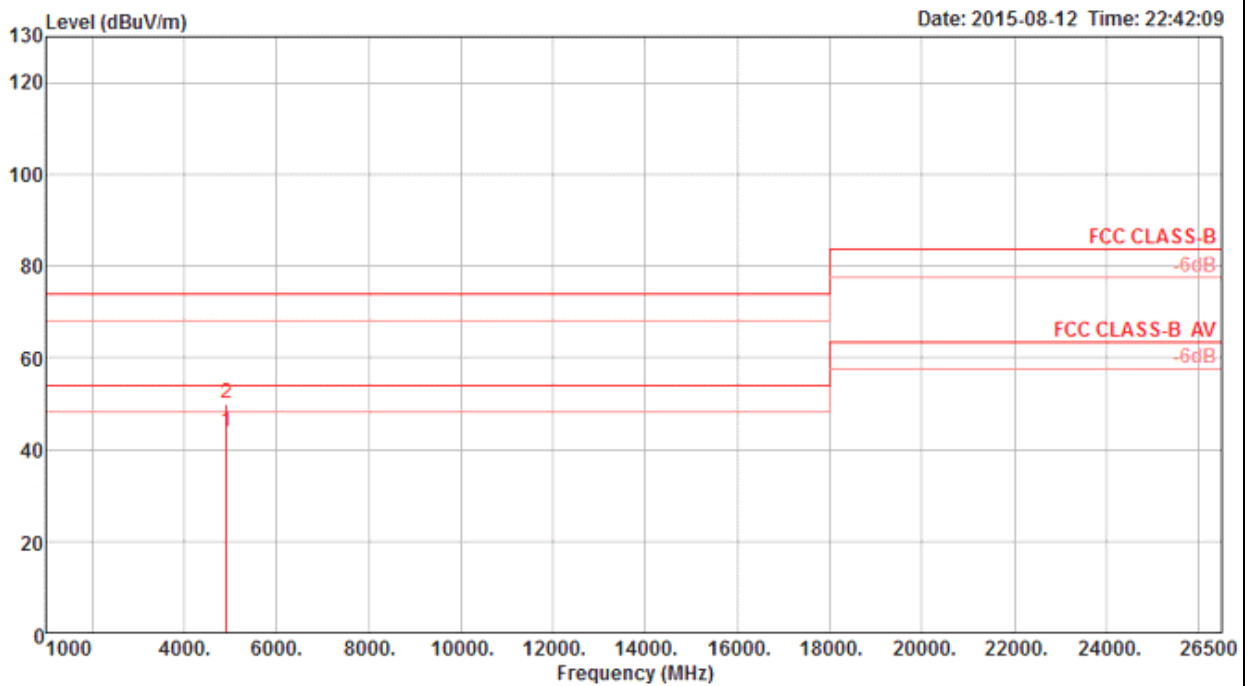

	Freq	Level	Limit	Over	Read	CableAntenna	Preamp	Remark	A/Pos	T/Pos	Pol/Phase
	MHz	dBuV/m	dBuV/m	dB	dBuV	dB	dB/m	dB	cm	deg	
1	4923.85	43.65	54.00	-10.35	39.04	5.97	33.65	35.01 Average	190	71	HORIZONTAL
2	4923.96	50.07	74.00	-23.93	45.46	5.97	33.65	35.01 Peak	190	71	HORIZONTAL

Note 1: The amplitude of spurious emissions which are attenuated by more than 20 dB below the permissible value has no need to be reported.
 Note 2: Emission level (dBUV/m) = 20 log Emission level (uV/m).
 Note 3: Corrected Reading: Antenna Factor + Cable Loss + Read Level - Preamp Factor = Level.
 Note 4: Measurement receive antenna polarization: H (Horizontal), V (Vertical)

Transmitter Radiated Emissions (1GHz~10th Harmonic)					
Operating Mode	IEEE 802.11b / CH 11 / Ant. 2			Polarization	V
Temperature	24.9°C	Humidity	57%	Test Engineer	Eric Fu

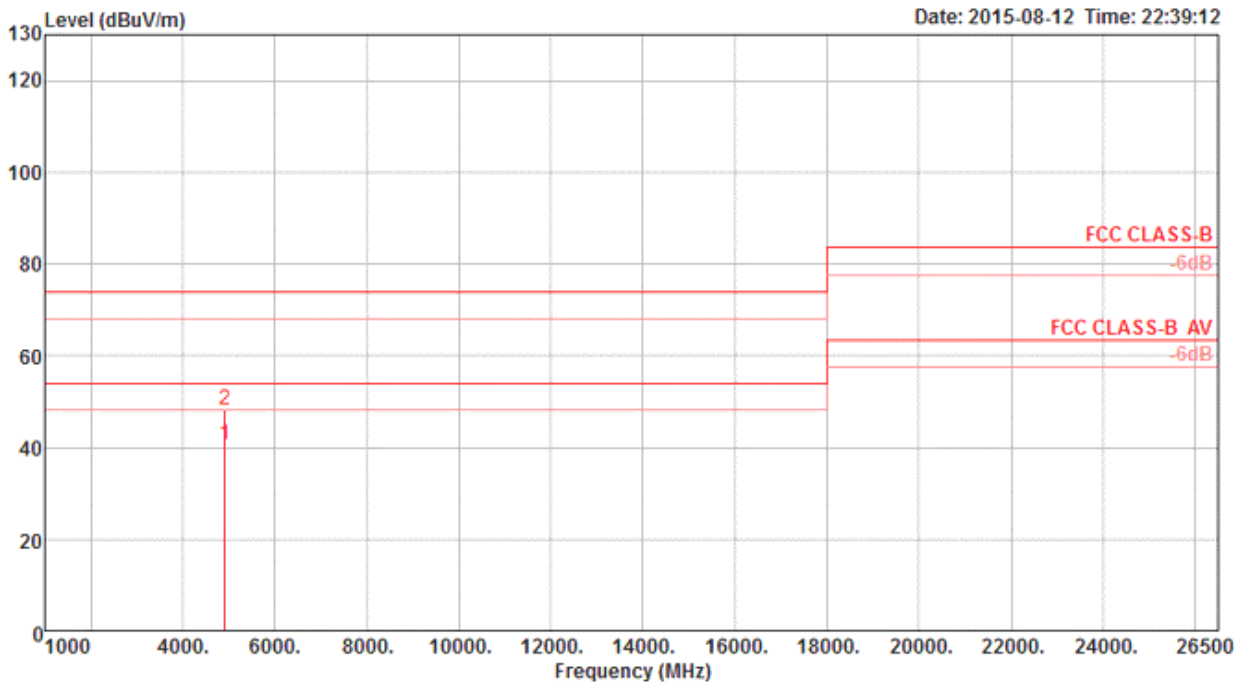

	Freq	Level	Limit	Over	Read	CableAntenna	Preamp	Remark	A/Pos	T/Pos	Pol/Phase	
	MHz	dBuV/m	dBuV/m	dB	dBuV	dB	dB/m	dB	cm	deg		
1	4923.90	40.57	54.00	-13.43	35.96	5.97	33.65	35.01	Average	165	177	VERTICAL
2	4924.02	47.98	74.00	-26.02	43.37	5.97	33.65	35.01	Peak	165	177	VERTICAL

Note 1: The amplitude of spurious emissions which are attenuated by more than 20 dB below the permissible value has no need to be reported.
 Note 2: Emission level (dBuV/m) = 20 log Emission level (uV/m).
 Note 3: Corrected Reading: Antenna Factor + Cable Loss + Read Level - Preamp Factor = Level.
 Note 4: Measurement receive antenna polarization: H (Horizontal), V (Vertical)

Transmitter Radiated Emissions (1GHz~10th Harmonic)					
Operating Mode	IEEE 802.11n 20MHz MCS0 / CH 1 / Ant. 2			Polarization	H
Temperature	24.9°C	Humidity	57%	Test Engineer	Eric Fu

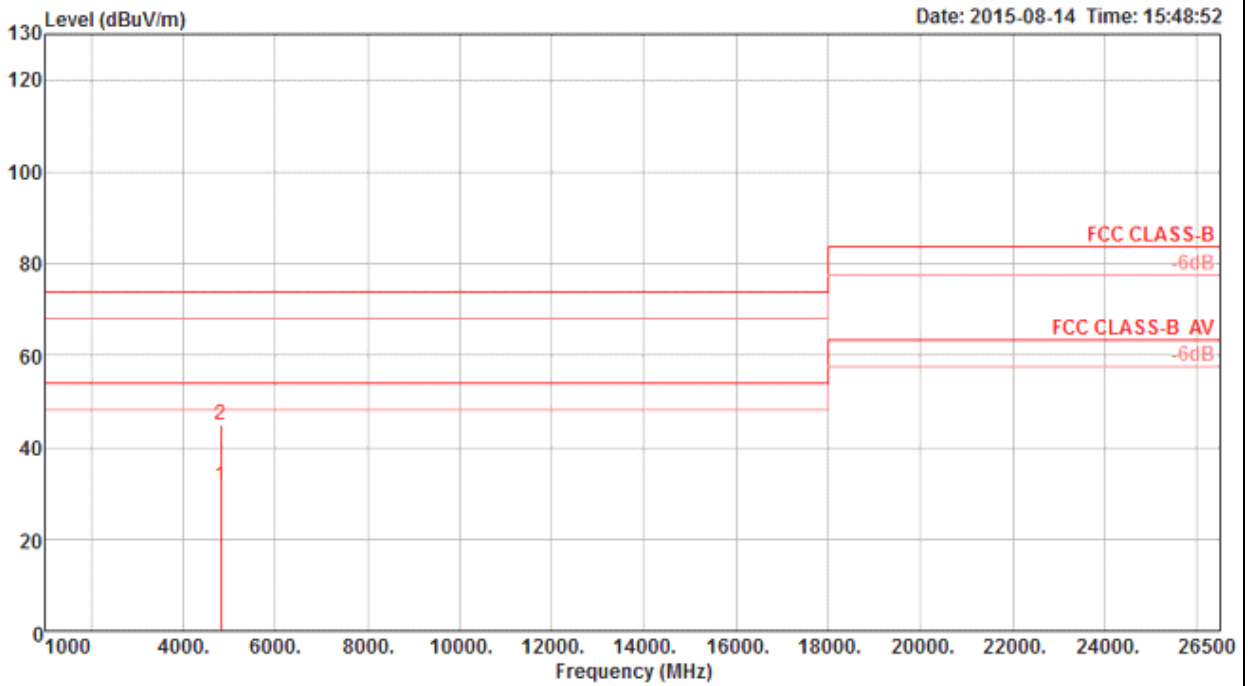

	Freq	Level	Limit	Over	Read	CableAntenna	Preamp	Remark	A/Pos	T/Pos	Pol/Phase
	MHz	dBuV/m	dBuV/m	dB	dBuV	dB	dB/m	dB	cm	deg	
1	4823.87	31.34	54.00	-22.66	27.06	5.87	33.42	35.01 Average	169	263	HORIZONTAL
2	4826.02	44.83	74.00	-29.17	40.55	5.87	33.42	35.01 Peak	169	263	HORIZONTAL

Note 1: The amplitude of spurious emissions which are attenuated by more than 20 dB below the permissible value has no need to be reported.
 Note 2: Emission level (dBuV/m) = 20 log Emission level (uV/m).
 Note 3: Corrected Reading: Antenna Factor + Cable Loss + Read Level - Preamp Factor = Level.
 Note 4: Measurement receive antenna polarization: H (Horizontal), V (Vertical)

Transmitter Radiated Emissions (1GHz~10th Harmonic)					
Operating Mode	IEEE 802.11n 20MHz MCS0 / CH 1 / Ant. 2			Polarization	V
Temperature	24.9°C	Humidity	57%	Test Engineer	Eric Fu

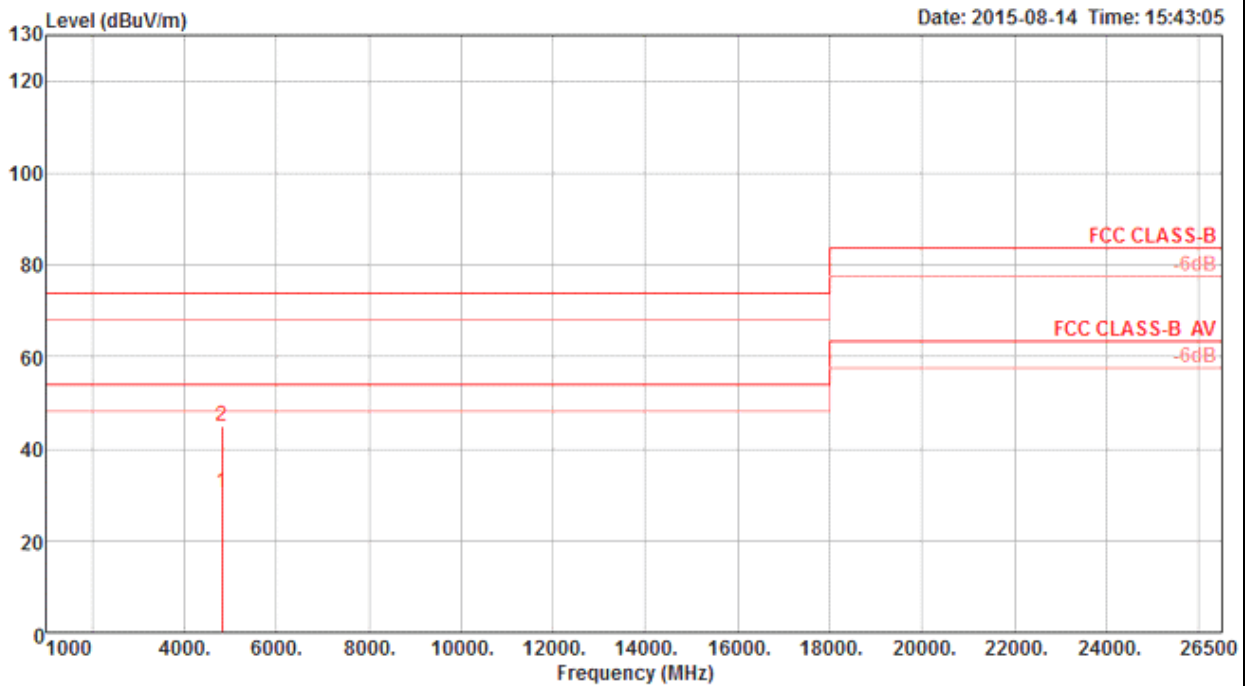

	Freq	Level	Limit	Over	Read	CableAntenna	Preamp	Remark	A/Pos	T/Pos	Pol/Phase
	MHz	dBuV/m	dBuV/m	dB	dBuV	dB	dB/m	dB	cm	deg	
1	4820.36	30.31	54.00	-23.69	26.03	5.87	33.42	35.01	157	274	VERTICAL
2	4823.62	44.95	74.00	-29.05	40.67	5.87	33.42	35.01	157	274	VERTICAL

Note 1: The amplitude of spurious emissions which are attenuated by more than 20 dB below the permissible value has no need to be reported.
 Note 2: Emission level (dBuV/m) = 20 log Emission level (uV/m).
 Note 3: Corrected Reading: Antenna Factor + Cable Loss + Read Level - Preamp Factor = Level.
 Note 4: Measurement receive antenna polarization: H (Horizontal), V (Vertical)

Transmitter Radiated Emissions (1GHz~10th Harmonic)					
Operating Mode	IEEE 802.11n 20MHz MCS0 / CH 6 / Ant. 2			Polarization	H
Temperature	24.9°C	Humidity	57%	Test Engineer	Eric Fu

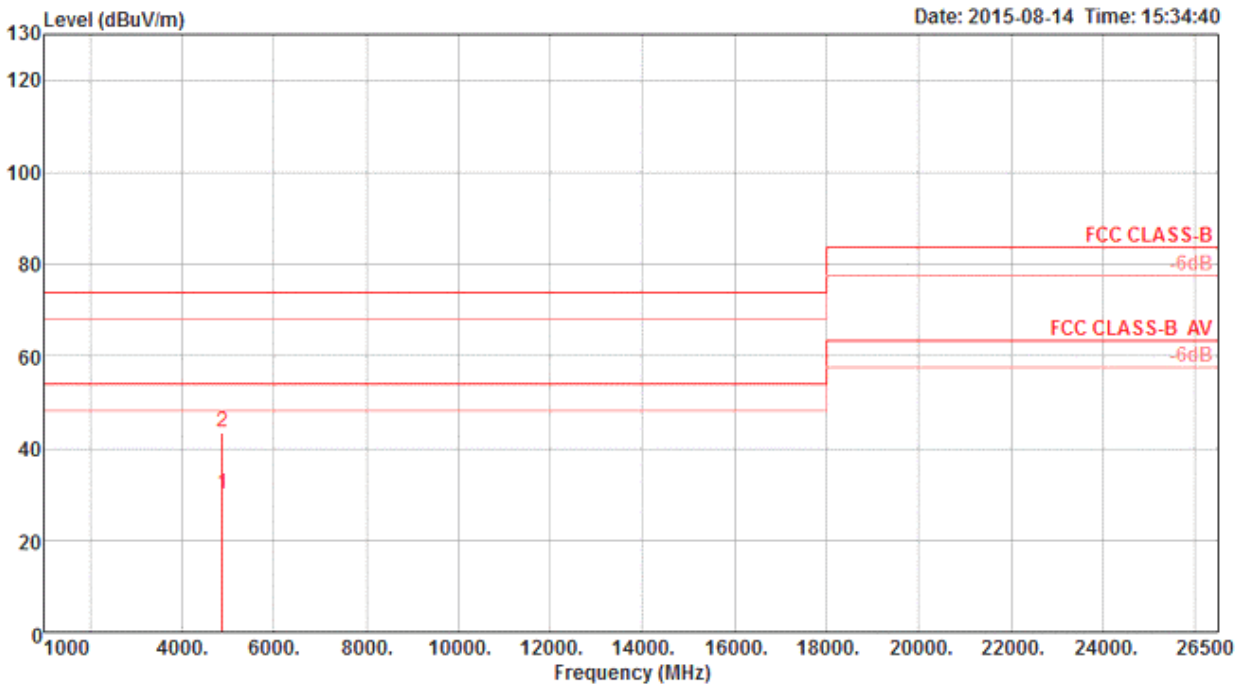

	Freq	Level	Limit	Over	Read	CableAntenna	Preamp	Remark	A/Pos	T/Pos	Pol/Phase
	MHz	dBuV/m	dBuV/m	dB	dBuV	dB	dB/m	dB	cm	deg	
1	4872.97	29.99	54.00	-24.01	25.55	5.92	33.53	35.01 Average	197	289	HORIZONTAL
2	4873.87	43.30	74.00	-30.70	38.86	5.92	33.53	35.01 Peak	197	289	HORIZONTAL

Note 1: The amplitude of spurious emissions which are attenuated by more than 20 dB below the permissible value has no need to be reported.
 Note 2: Emission level (dBuV/m) = 20 log Emission level (uV/m).
 Note 3: Corrected Reading: Antenna Factor + Cable Loss + Read Level - Preamp Factor = Level.
 Note 4: Measurement receive antenna polarization: H (Horizontal), V (Vertical)

Transmitter Radiated Emissions (1GHz~10th Harmonic)					
Operating Mode	IEEE 802.11n 20MHz MCS0 / CH 6 / Ant. 2			Polarization	V
Temperature	24.9°C	Humidity	57%	Test Engineer	Eric Fu

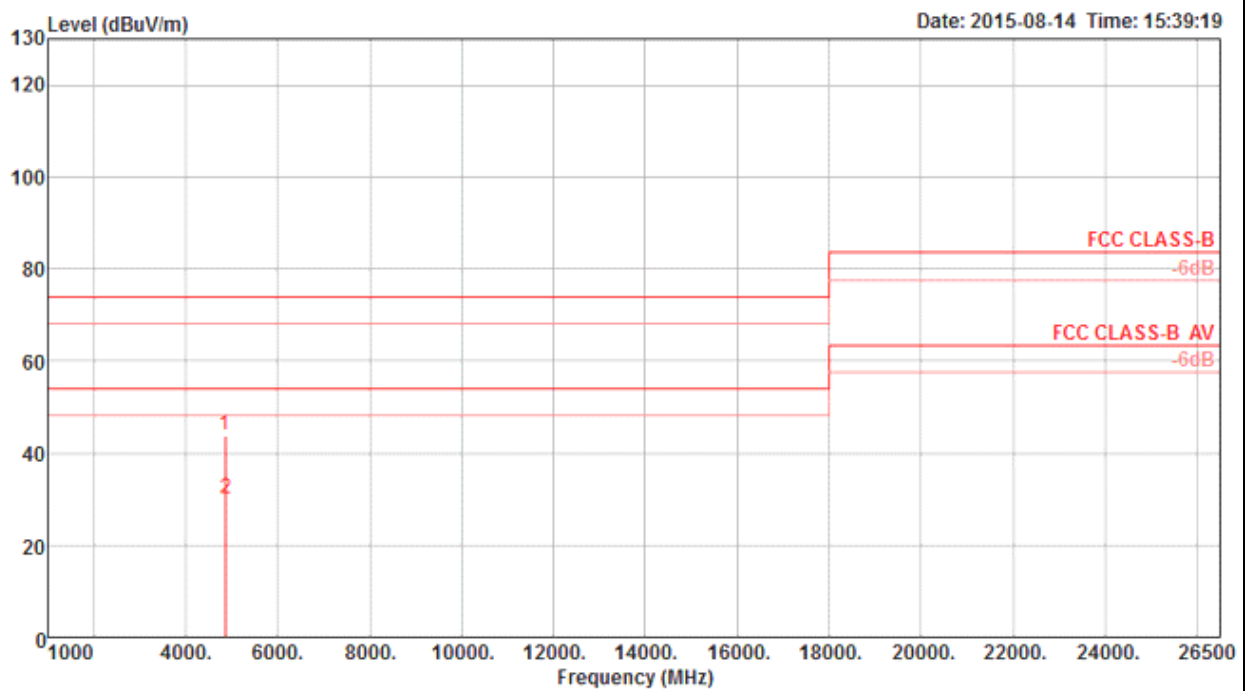

Freq	Level	Limit	Over	Read	CableAntenna	Preamp	Remark	A/Pos	T/Pos	Pol/Phase		
MHz	dBuV/m	dBuV/m	dB	dBuV	dB	dB/m		cm	deg			
1	4869.56	43.83	74.00	-30.17	39.39	5.92	33.53	35.01	Peak	135	123	VERTICAL
2	4873.14	30.04	54.00	-23.96	25.60	5.92	33.53	35.01	Average	135	123	VERTICAL

Note 1: The amplitude of spurious emissions which are attenuated by more than 20 dB below the permissible value has no need to be reported.
 Note 2: Emission level (dBuV/m) = 20 log Emission level (uV/m).
 Note 3: Corrected Reading: Antenna Factor + Cable Loss + Read Level - Preamp Factor = Level.
 Note 4: Measurement receive antenna polarization: H (Horizontal), V (Vertical)

Transmitter Radiated Emissions (1GHz~10th Harmonic)					
Operating Mode	IEEE 802.11n 20MHz MCS0 / CH 11 / Ant. 2			Polarization	H
Temperature	24.9°C	Humidity	57%	Test Engineer	Eric Fu

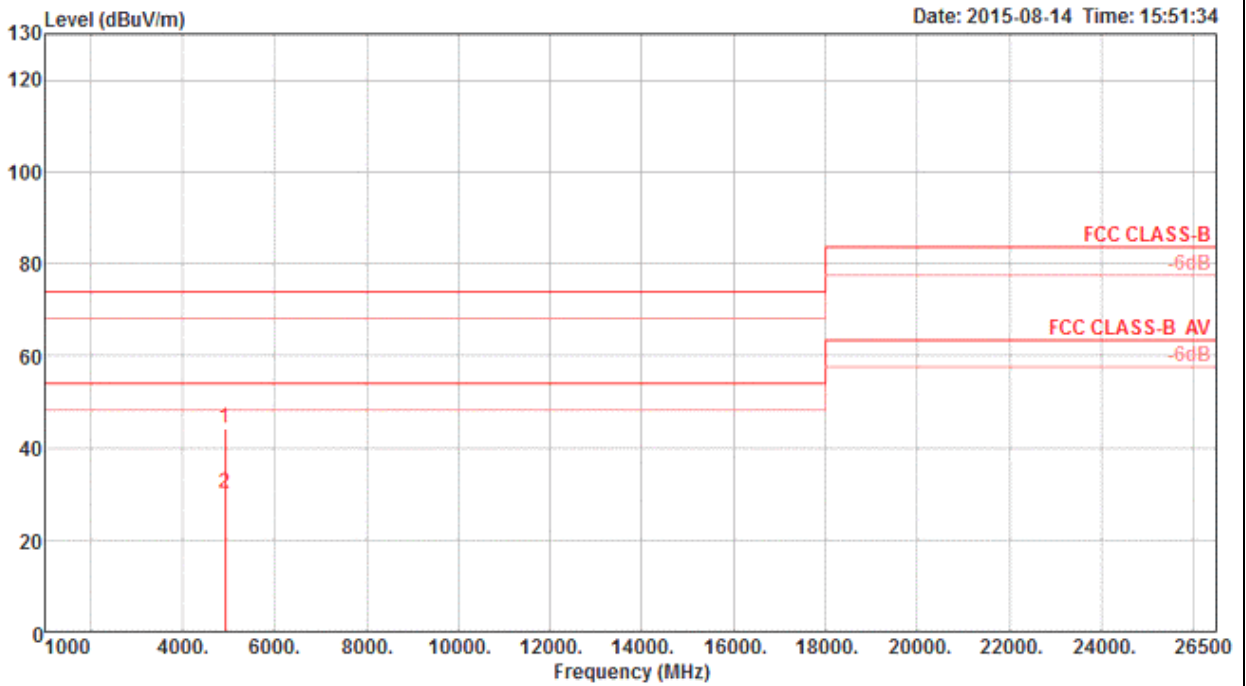

	Freq	Level	Limit	Over	Read	Cable	Antenna	Preamp	Remark	A/Pos	T/Pos	Pol/Phase
	MHz	dBuV/m	dBuV/m	dB	dBuV	dB	dB/m	dB		cm	deg	
1	4924.64	44.28	74.00	-29.72	39.67	5.97	33.65	35.01	Peak	128	230	HORIZONTAL
2	4925.78	30.15	54.00	-23.85	25.54	5.97	33.65	35.01	Average	128	230	HORIZONTAL

Note 1: The amplitude of spurious emissions which are attenuated by more than 20 dB below the permissible value has no need to be reported.
 Note 2: Emission level (dBuV/m) = 20 log Emission level (uV/m).
 Note 3: Corrected Reading: Antenna Factor + Cable Loss + Read Level - Preamp Factor = Level.
 Note 4: Measurement receive antenna polarization: H (Horizontal), V (Vertical)

Transmitter Radiated Emissions (1GHz~10th Harmonic)					
Operating Mode	IEEE 802.11n 20MHz MCS0 / CH 11 / Ant. 2			Polarization	V
Temperature	24.9°C	Humidity	57%	Test Engineer	Eric Fu

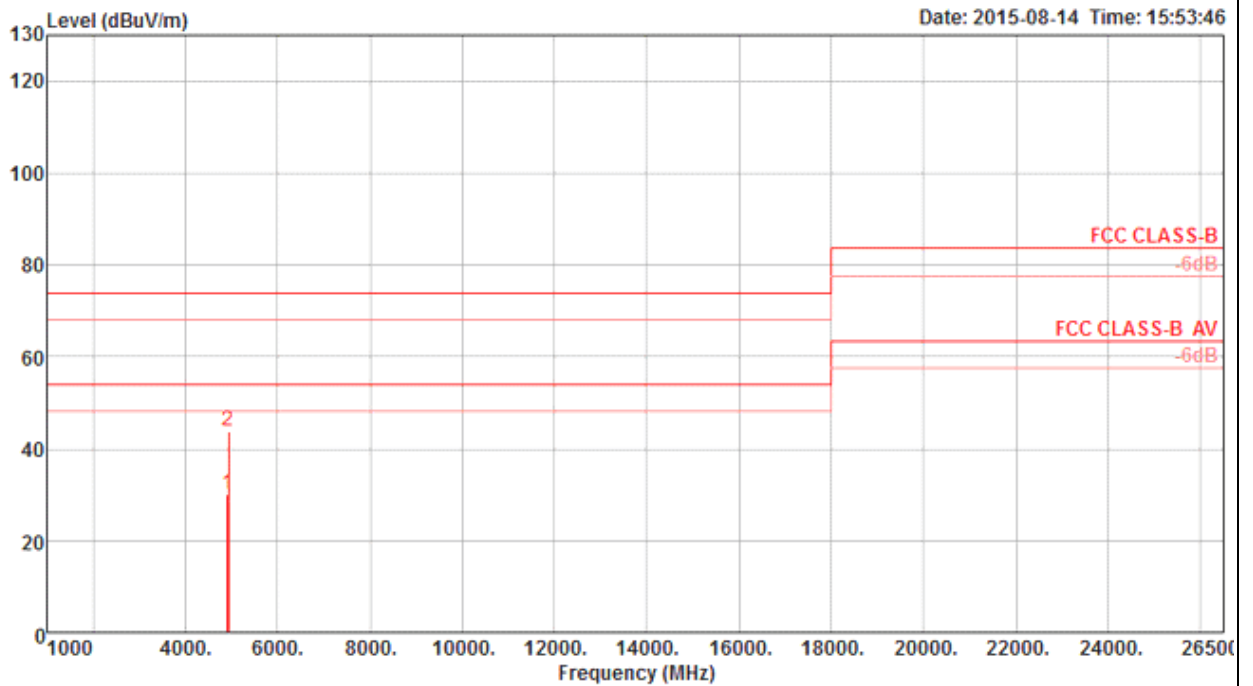

	Freq	Level	Limit	Over	Read	Cable	Antenna	Preamp	Remark	A/Pos	T/Pos	Pol/Phase
	MHz	dBuV/m	dBuV/m	dB	dBuV	dB	dB/m	dB		cm	deg	
1	4923.86	30.16	54.00	-23.84	25.55	5.97	33.65	35.01	Average	169	224	VERTICAL
2	4928.62	43.82	74.00	-30.18	39.21	5.97	33.65	35.01	Peak	169	224	VERTICAL

Note 1: The amplitude of spurious emissions which are attenuated by more than 20 dB below the permissible value has no need to be reported.
 Note 2: Emission level (dBuV/m) = 20 log Emission level (uV/m).
 Note 3: Corrected Reading: Antenna Factor + Cable Loss + Read Level - Preamp Factor = Level.
 Note 4: Measurement receive antenna polarization: H (Horizontal), V (Vertical)

Transmitter Radiated Emissions (1GHz~10th Harmonic)					
Operating Mode	IEEE 802.11n 20MHz MCS0 / CH 1 / Ant. 1+2 (CDD)			Polarization	H
Temperature	24.9°C	Humidity	57%	Test Engineer	Eric Fu

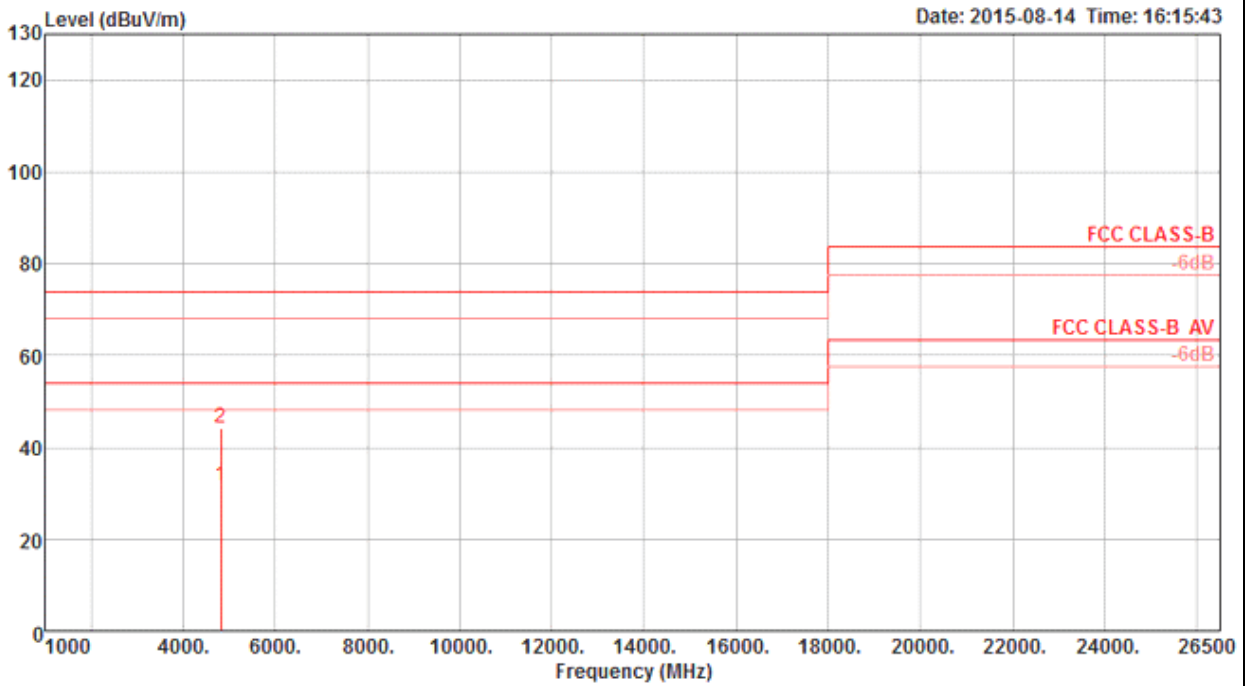

	Freq	Level	Limit	Over	Read	CableAntenna	Preamp	Remark	A/Pos	T/Pos	Pol/Phase
	MHz	dBuV/m	dBuV/m	dB	dBuV	dB	dB/m	dB	cm	deg	
1	4823.87	31.57	54.00	-22.43	27.29	5.87	33.42	35.01	Average	207	90 HORIZONTAL
2	4825.52	44.23	74.00	-29.77	39.95	5.87	33.42	35.01	Peak	207	90 HORIZONTAL

Note 1: The amplitude of spurious emissions which are attenuated by more than 20 dB below the permissible value has no need to be reported.
 Note 2: Emission level (dBuV/m) = 20 log Emission level (uV/m).
 Note 3: Corrected Reading: Antenna Factor + Cable Loss + Read Level - Preamp Factor = Level.
 Note 4: Measurement receive antenna polarization: H (Horizontal), V (Vertical)

Transmitter Radiated Emissions (1GHz~10th Harmonic)					
Operating Mode	IEEE 802.11n 20MHz MCS0 / CH 1 / Ant. 1+2 (CDD)			Polarization	V
Temperature	24.9°C	Humidity	57%	Test Engineer	Eric Fu

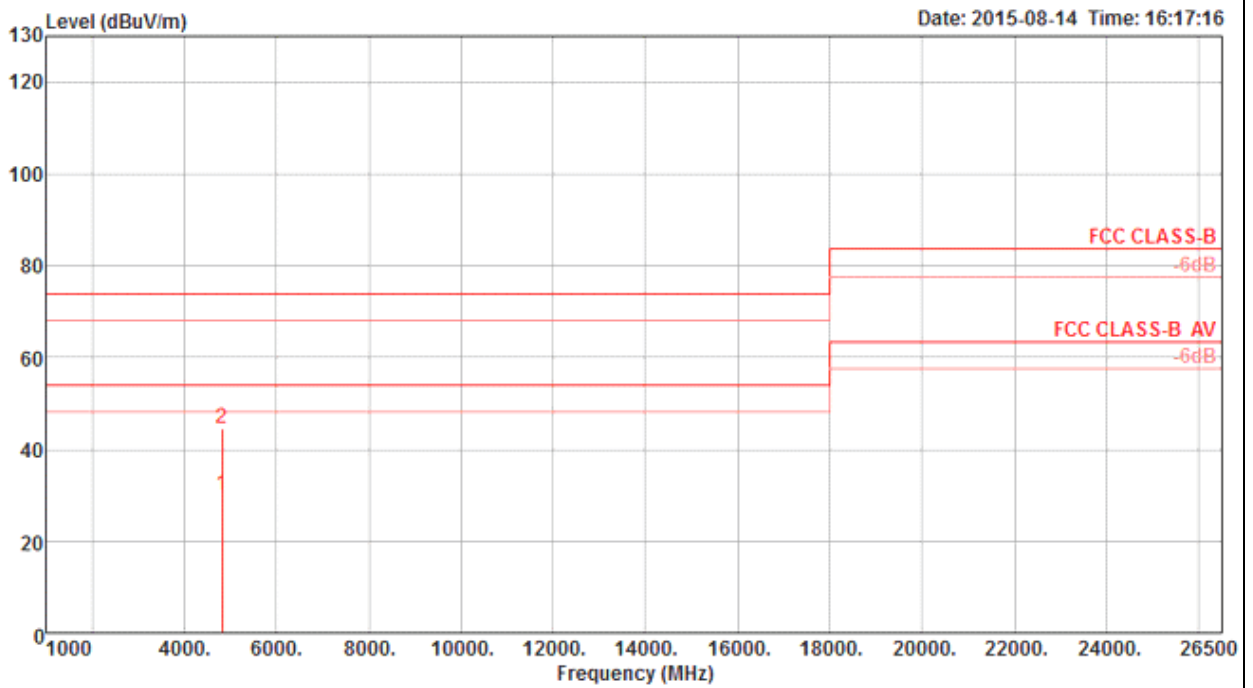

	Freq	Level	Limit	Over	Read	CableAntenna	Preamp	Remark	A/Pos	T/Pos	Pol/Phase
	MHz	dBuV/m	dBuV/m	dB	dBuV	dB	dB/m	dB	cm	deg	
1	4822.01	30.23	54.00	-23.77	25.95	5.87	33.42	35.01 Average	140	253	VERTICAL
2	4825.60	44.46	74.00	-29.54	40.18	5.87	33.42	35.01 Peak	140	253	VERTICAL

Note 1: The amplitude of spurious emissions which are attenuated by more than 20 dB below the permissible value has no need to be reported.
 Note 2: Emission level (dBuV/m) = 20 log Emission level (uV/m).
 Note 3: Corrected Reading: Antenna Factor + Cable Loss + Read Level - Preamp Factor = Level.
 Note 4: Measurement receive antenna polarization: H (Horizontal), V (Vertical)

Transmitter Radiated Emissions (1GHz~10th Harmonic)					
Operating Mode	IEEE 802.11n 20MHz MCS0 / CH 6 / Ant. 1+2 (CDD)			Polarization	H
Temperature	24.9°C	Humidity	57%	Test Engineer	Eric Fu

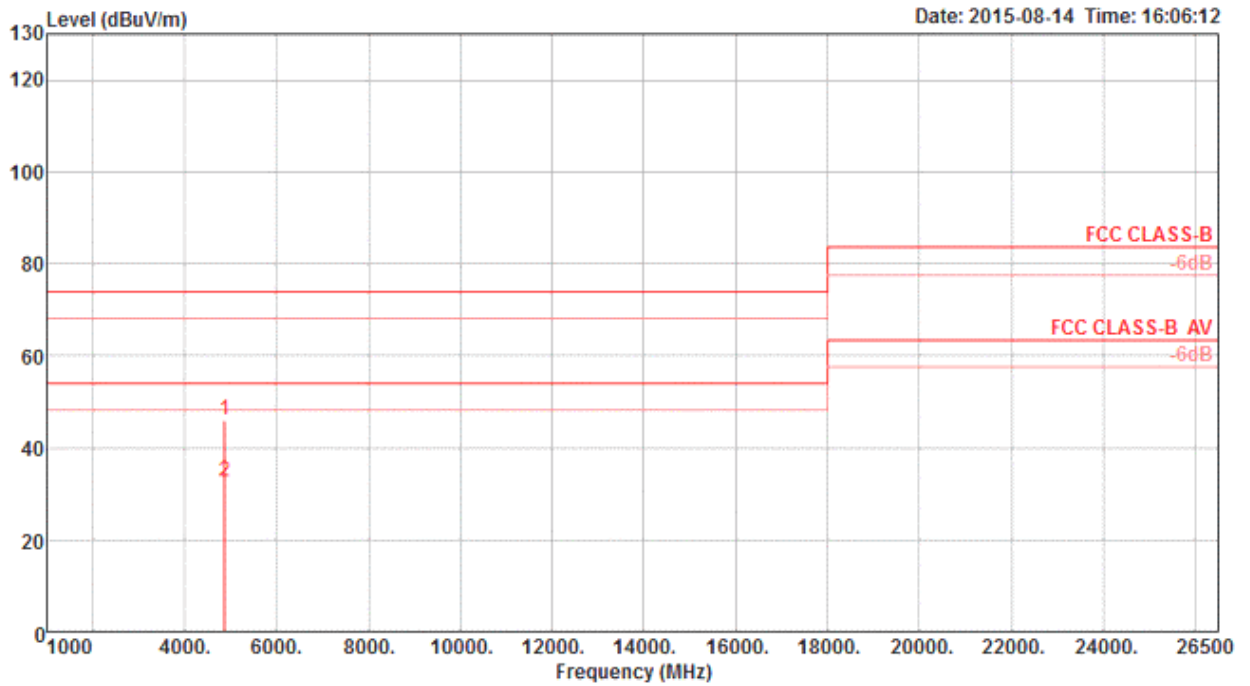

	Freq	Level	Limit	Over	Read	Cable	Antenna	Preamp	Remark	A/Pos	T/Pos	Pol/Phase
	MHz	dBuV/m	dBuV/m	dB	dBuV	dB	dB/m	dB		cm	deg	
1	4870.89	45.97	74.00	-28.03	41.53	5.92	33.53	35.01	Peak	165	82	HORIZONTAL
2	4873.68	32.48	54.00	-21.52	28.04	5.92	33.53	35.01	Average	165	82	HORIZONTAL

Note 1: The amplitude of spurious emissions which are attenuated by more than 20 dB below the permissible value has no need to be reported.
 Note 2: Emission level (dBuV/m) = 20 log Emission level (uV/m).
 Note 3: Corrected Reading: Antenna Factor + Cable Loss + Read Level - Preamp Factor = Level.
 Note 4: Measurement receive antenna polarization: H (Horizontal), V (Vertical)

Transmitter Radiated Emissions (1GHz~10th Harmonic)					
Operating Mode	IEEE 802.11n 20MHz MCS0 / CH 6 / Ant. 1+2 (CDD)			Polarization	V
Temperature	24.9°C	Humidity	57%	Test Engineer	Eric Fu

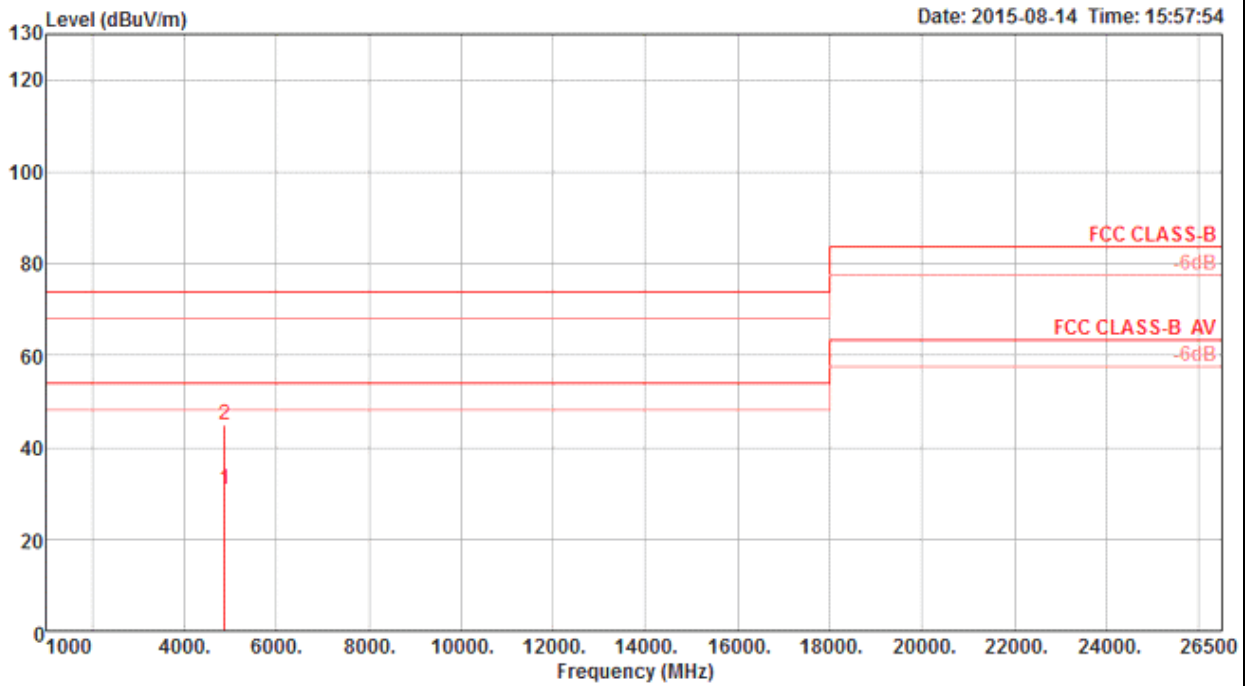

	Freq	Level	Limit	Over	Read	CableAntenna	Preamp	Remark	A/Pos	T/Pos	Pol/Phase
	MHz	dBuV/m	dBuV/m	dB	dBuV	dB	dB/m	dB	cm	deg	
1	4872.88	30.81	54.00	-23.19	26.37	5.92	33.53	35.01 Average	191	168	VERTICAL
2	4872.88	44.87	74.00	-29.13	40.43	5.92	33.53	35.01 Peak	191	168	VERTICAL

Note 1: The amplitude of spurious emissions which are attenuated by more than 20 dB below the permissible value has no need to be reported.
 Note 2: Emission level (dBuV/m) = 20 log Emission level (uV/m).
 Note 3: Corrected Reading: Antenna Factor + Cable Loss + Read Level - Preamp Factor = Level.
 Note 4: Measurement receive antenna polarization: H (Horizontal), V (Vertical)

Transmitter Radiated Emissions (1GHz~10th Harmonic)					
Operating Mode	IEEE 802.11n 20MHz MCS0 / CH 11 / Ant. 1+2 (CDD)			Polarization	H
Temperature	24.9°C	Humidity	57%	Test Engineer	Eric Fu

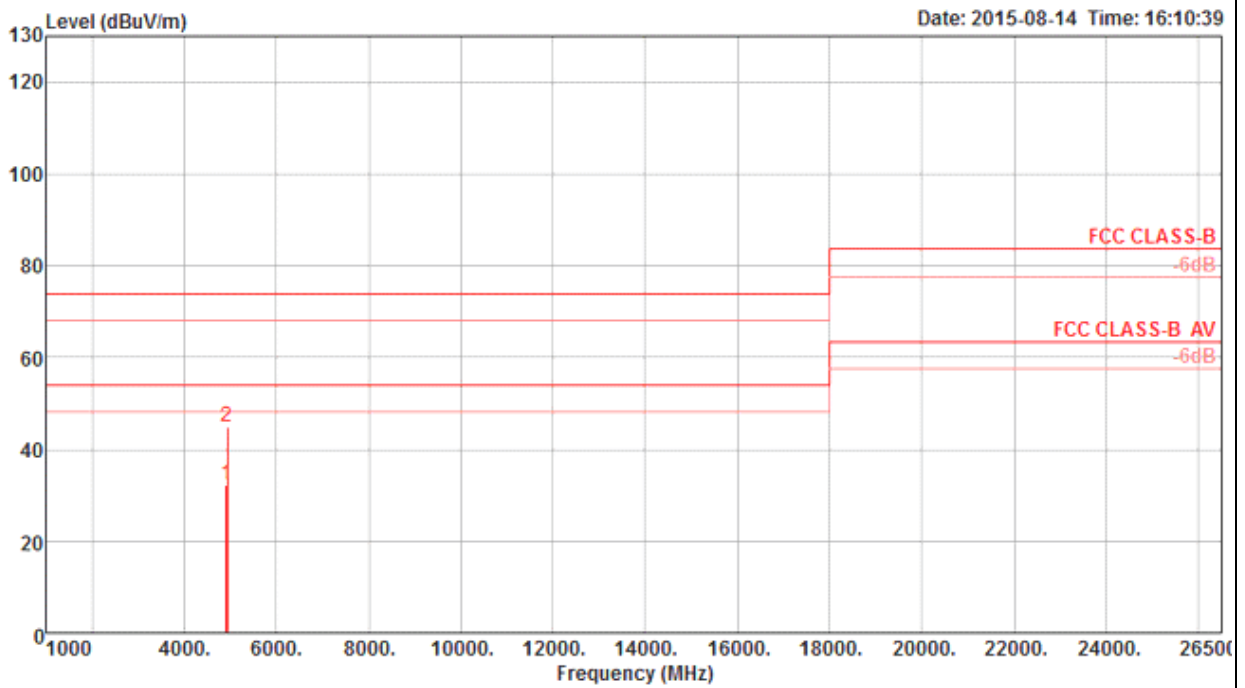

	Freq	Level	Limit	Over	Read	Cable	Antenna	Preamp	Remark	A/Pos	T/Pos	Pol/Phase
	MHz	dBuV/m	dBuV/m	dB	dBuV	dB	dB/m	dB		cm	deg	
1	4923.65	32.21	54.00	-21.79	27.60	5.97	33.65	35.01	Average	214	77	HORIZONTAL
2	4925.73	44.78	74.00	-29.22	40.17	5.97	33.65	35.01	Peak	214	77	HORIZONTAL

Note 1: The amplitude of spurious emissions which are attenuated by more than 20 dB below the permissible value has no need to be reported.
 Note 2: Emission level (dBuV/m) = 20 log Emission level (uV/m).
 Note 3: Corrected Reading: Antenna Factor + Cable Loss + Read Level - Preamp Factor = Level.
 Note 4: Measurement receive antenna polarization: H (Horizontal), V (Vertical)

Transmitter Radiated Emissions (1GHz~10th Harmonic)					
Operating Mode	IEEE 802.11n 20MHz MCS0 / CH 11 / Ant. 1+2 (CDD)			Polarization	V
Temperature	24.9°C	Humidity	57%	Test Engineer	Eric Fu

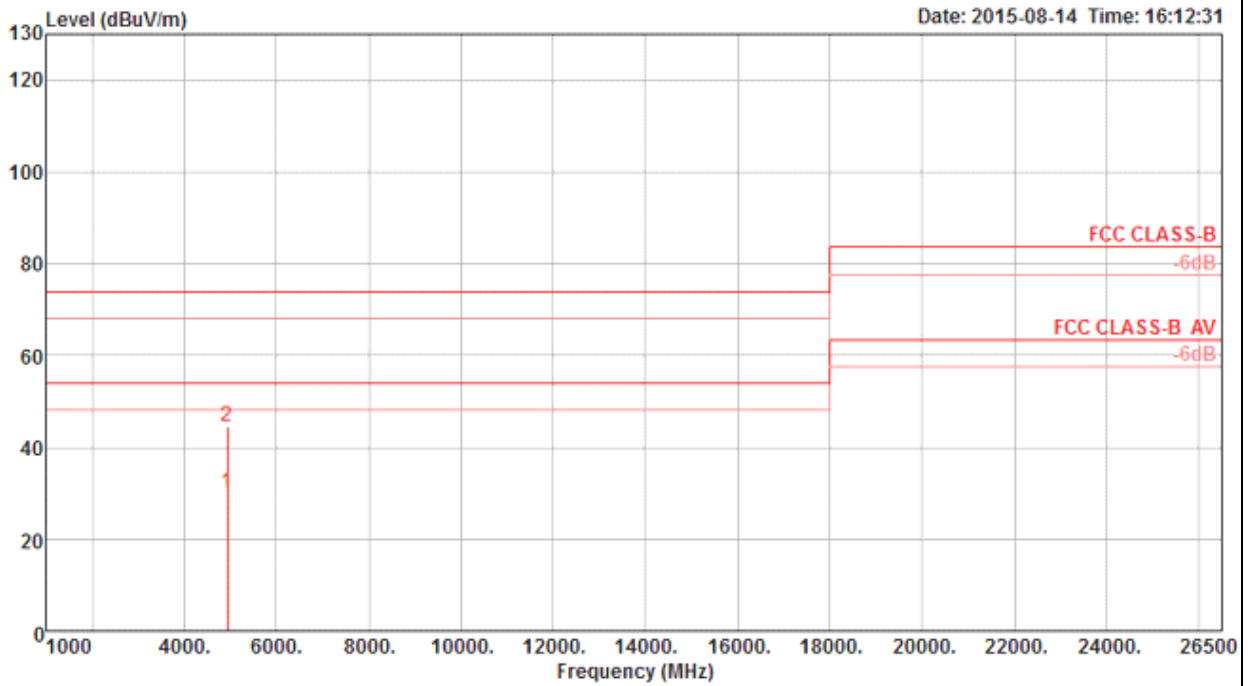

	Freq	Level	Limit	Over	Read	CableAntenna	Preamp	Remark	A/Pos	T/Pos	Pol/Phase
	MHz	dBuV/m	dBuV/m	dB	dBuV	dB	dB/m	dB	cm	deg	
1	4925.57	30.19	54.00	-23.81	25.58	5.97	33.65	35.01 Average	134	83	VERTICAL
2	4926.90	44.56	74.00	-29.44	39.95	5.97	33.65	35.01 Peak	134	83	VERTICAL

Note 1: The amplitude of spurious emissions which are attenuated by more than 20 dB below the permissible value has no need to be reported.
 Note 2: Emission level (dBuV/m) = 20 log Emission level (uV/m).
 Note 3: Corrected Reading: Antenna Factor + Cable Loss + Read Level - Preamp Factor = Level.
 Note 4: Measurement receive antenna polarization: H (Horizontal), V (Vertical)

3.6. Band Edge and Fundamental Emissions Measurement

3.6.1. Limit

30dBc in any 100 kHz bandwidth outside the operating frequency band. In case the emission fall within the restricted band specified on 15.205(a), then the 15.209(a) limit in the table below has to be followed.

Frequencies (MHz)	Field Strength (microvolt/meter)	Measurement Distance (meters)
0.009~0.490	2400/F(kHz)	300
0.490~1.705	24000/F(kHz)	30
1.705~30.0	30	30
30~88	100	3
88~216	150	3
216~960	200	3
Above 960	500	3

3.6.2. Measuring Instruments and Setting

Please refer to section 6 of equipments list in this report. The following table is the setting of the spectrum analyzer.

Spectrum Analyzer	Setting
Attenuation	Auto
Span Frequency	100 MHz
RBW / VBW (Emission in restricted band)	1MHz / 3MHz for Peak, 1MHz / 1/T for Average
RBW / VBW (Emission in non-restricted band)	100 kHz /300 kHz for Peak

3.6.3. Test Procedures

- The test procedure is the same as section 3.5.3, only the frequency range investigated is limited to 100MHz around bandedges.

3.6.4. Test Setup Layout

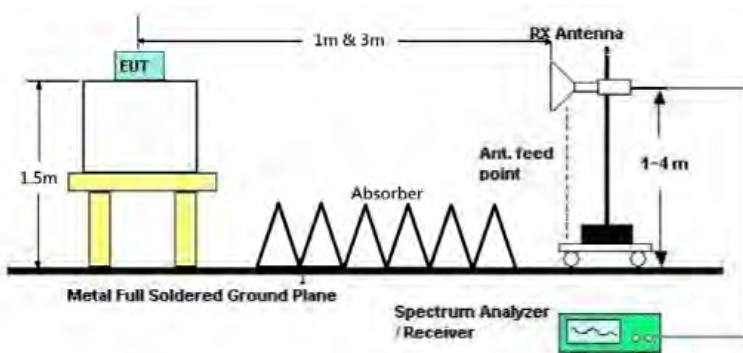

3.6.5. Test Deviation

There is no deviation with the original standard.

3.6.6. EUT Operation during Test

The EUT was programmed to be in continuously transmitting mode.

3.6.7. Test Result of Band Edge and Fundamental Emissions

Following channel(s) was (were) selected for the final test as listed below.

MODE	TX Chain	TESTED CHANNEL	MODULATION TECHNOLOGY	MODULATION TYPE	DATA RATE (Mbps)
802.11b	Ant. 2	1, 6, 11	DSSS	DBPSK	1
802.11n 20MHz	Ant. 2	1, 6, 11	OFDM	BPSK	MCS0 (6.5)
802.11n 20MHz	Ant. 1+2, CDD	1, 6, 11	OFDM	BPSK	MCS0 (6.5)

Band Edge and Fundamental Emissions					
Operating Mode	IEEE 802.11b / CH 1 / Ant. 2			Polarization	H
Temperature	24.9°C	Humidity	57%	Test Engineer	Eric Fu

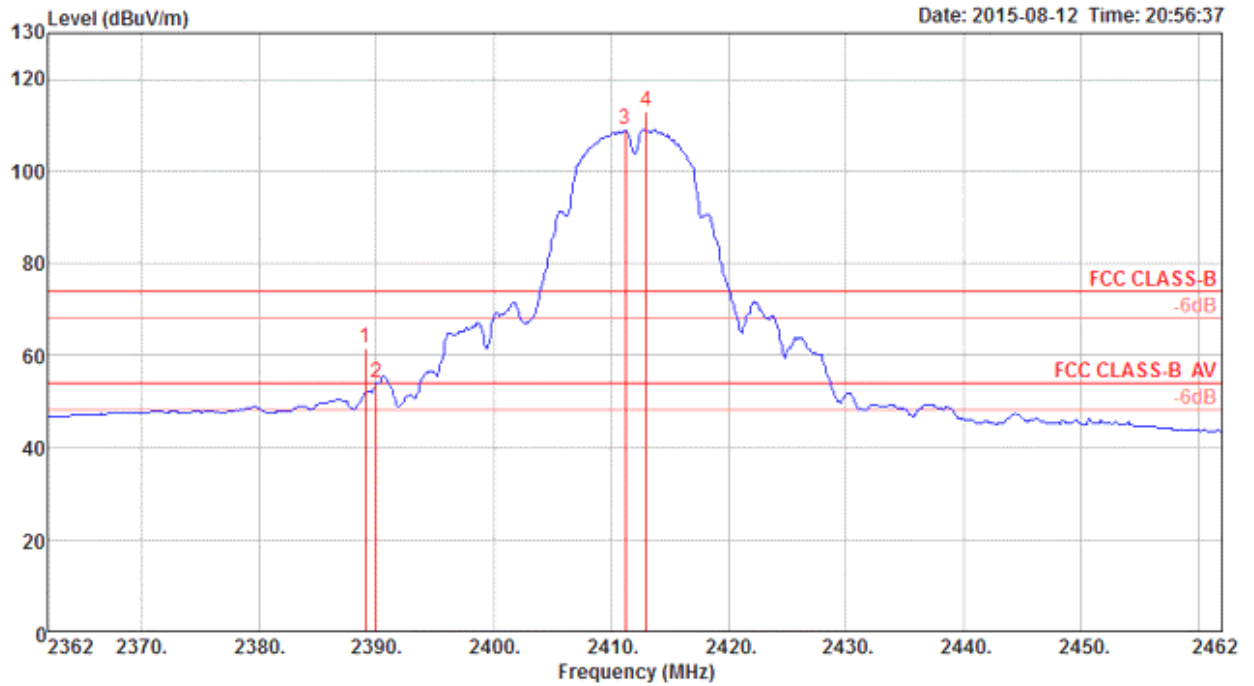

	Freq	Level	Limit Line	Over Limit	Read Level	Cable Loss	Antenna Factor	Preamp Factor	Remark	A/Pos	T/Pos	Pol/Phase
	MHz	dBuV/m	dBuV/m	dB	dBuV	dB	dB/m	dB		cm	deg	
1	2389.08	61.65	74.00	-12.35	29.35	4.09	28.21	0.00	Peak	194	121	HORIZONTAL
2	2390.00	53.96	54.00	-0.04	21.66	4.09	28.21	0.00	Average	194	121	HORIZONTAL
3	2411.20	108.82			76.47	4.11	28.24	0.00	Average	194	121	HORIZONTAL
4	2412.96	112.86			80.51	4.11	28.24	0.00	Peak	194	121	HORIZONTAL

Note 1: Item 3, 4 are the fundamental frequency at 2412 MHz
 Note 2: Emission level (dBuV/m) = 20 log Emission level (uV/m).
 Note 3: Corrected Reading: Antenna Factor + Cable Loss + Read Level - Preamp Factor = Level.
 Note 4: Measurement receive antenna polarization: H (Horizontal), V (Vertical)

Band Edge and Fundamental Emissions					
Operating Mode	IEEE 802.11b / CH 6 / Ant. 2			Polarization	V
Temperature	24.9°C	Humidity	57%	Test Engineer	Eric Fu

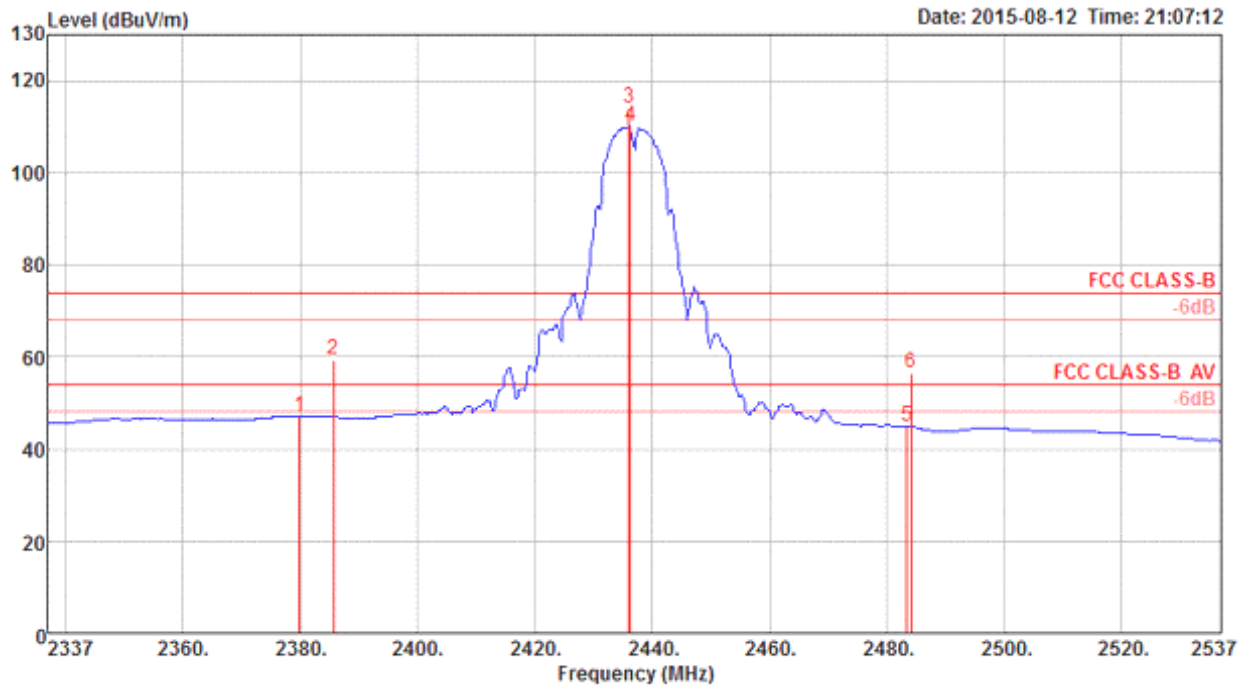

Item	Freq	Level	Limit	Over	Read	Cable	Antenna	Preamp	Remark	A/Pos	T/Pos	Pol/Phase
	MHz	dBuV/m	dBuV/m	dB	dBuV	dB	dB/m	dB		cm	deg	
1	2379.95	47.07	54.00	-6.93	14.81	4.08	28.18	0.00	Average	142	166	VERTICAL
2	2385.72	59.50	74.00	-14.50	27.20	4.09	28.21	0.00	Peak	142	166	VERTICAL
3	2436.04	113.89			81.49	4.12	28.28	0.00	Peak	142	166	VERTICAL
4	2436.36	110.05			77.65	4.12	28.28	0.00	Average	142	166	VERTICAL
5	2483.50	44.85	54.00	-9.15	12.32	4.16	28.37	0.00	Average	142	166	VERTICAL
6	2484.12	56.54	74.00	-17.46	24.01	4.16	28.37	0.00	Peak	142	166	VERTICAL

Note 1: Item 3, 4 are the fundamental frequency at 2437 MHz
 Note 2: Emission level (dBuV/m) = 20 log Emission level (uV/m).
 Note 3: Corrected Reading: Antenna Factor + Cable Loss + Read Level - Preamp Factor = Level.
 Note 4: Measurement receive antenna polarization: H (Horizontal), V (Vertical)

Band Edge and Fundamental Emissions					
Operating Mode	IEEE 802.11b / CH 11 / Ant. 2			Polarization	V
Temperature	24.9°C	Humidity	57%	Test Engineer	Eric Fu

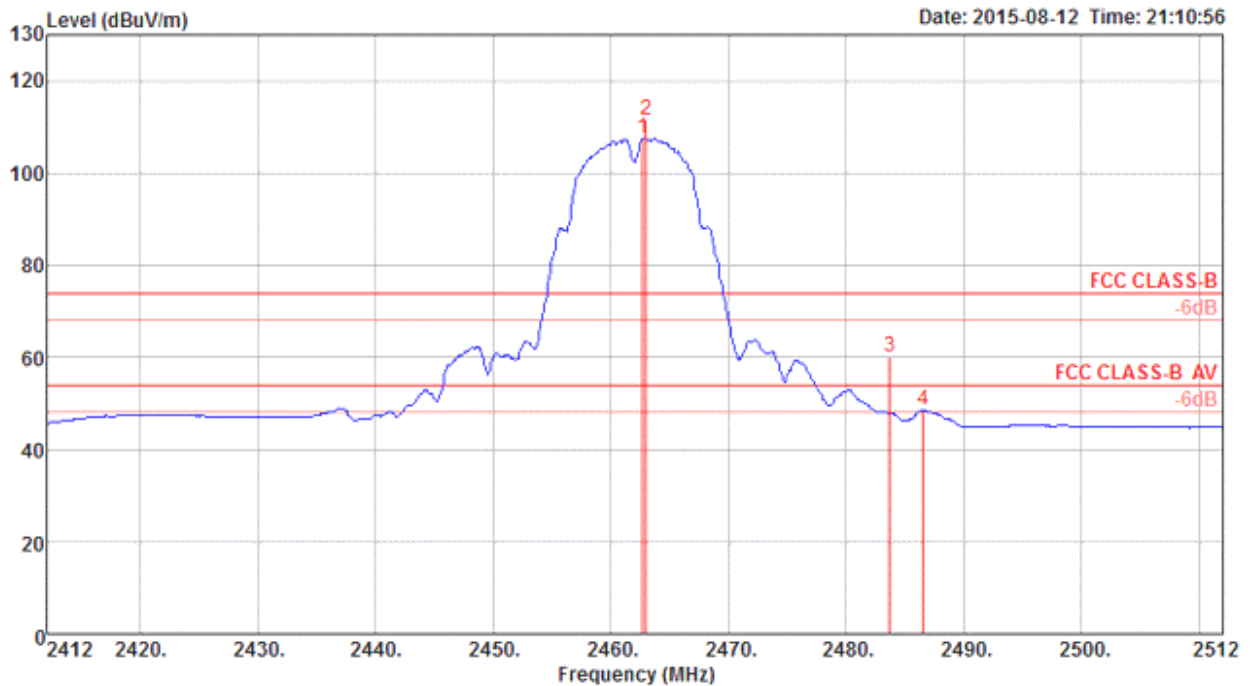

	Freq	Level	Limit Line	Over Limit	Read Level	Cable Loss	Antenna Factor	Preamp Factor	Remark	A/Pos	T/Pos	Pol/Phase
	MHz	dBUV/m	dBUV/m	dB	dBUV	dB	dB/m	dB		cm	deg	
1	2462.64	107.40			74.92	4.14	28.34	0.00	Average	134	175	VERTICAL
2	2462.96	111.48			79.00	4.14	28.34	0.00	Peak	134	175	VERTICAL
3	2483.64	60.12	74.00	-13.88	27.59	4.16	28.37	0.00	Peak	134	175	VERTICAL
4	2486.52	48.39	54.00	-5.61	15.86	4.16	28.37	0.00	Average	134	175	VERTICAL

Note 1: Item 1, 2 are the fundamental frequency at 2462 MHz
 Note 2: Emission level (dBUV/m) = 20 log Emission level (uV/m).
 Note 3: Corrected Reading: Antenna Factor + Cable Loss + Read Level - Preamp Factor = Level.
 Note 4: Measurement receive antenna polarization: H (Horizontal), V (Vertical)

Band Edge and Fundamental Emissions					
Operating Mode	IEEE 802.11n 20MHz MCS0 / CH 1 / Ant. 2			Polarization	V
Temperature	24.9°C	Humidity	57%	Test Engineer	Eric Fu

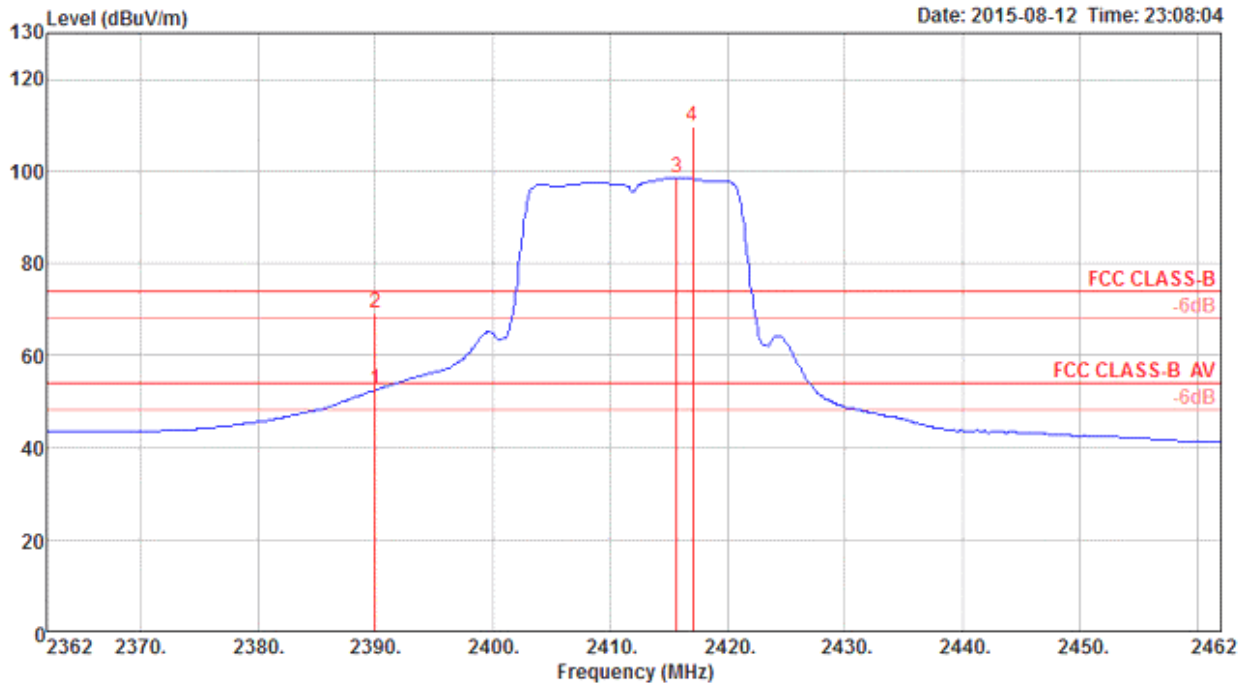

	Freq	Level	Limit Line	Over Limit	Read Level	CableAntenna Loss	Preamp Factor	Remark	A/Pos	T/Pos	Pol/Phase
	MHz	dBuV/m	dBuV/m	dB	dBuV	dB	dB/m	dB	cm	deg	
1	2390.00	52.49	54.00	-1.51	20.19	4.09	28.21	0.00 Average	148	168	VERTICAL
2	2390.00	69.00	74.00	-5.00	36.70	4.09	28.21	0.00 Peak	148	168	VERTICAL
3	2415.69	98.61			66.26	4.11	28.24	0.00 Average	148	168	VERTICAL
4	2416.97	109.60			77.25	4.11	28.24	0.00 Peak	148	168	VERTICAL

Note 1: Item 3, 4 are the fundamental frequency at 2412 MHz
 Note 2: Emission level (dBuV/m) = 20 log Emission level (uV/m).
 Note 3: Corrected Reading: Antenna Factor + Cable Loss + Read Level - Preamp Factor = Level.
 Note 4: Measurement receive antenna polarization: H (Horizontal), V (Vertical)

Band Edge and Fundamental Emissions					
Operating Mode	IEEE 802.11n 20MHz MCS0 / CH 6 / Ant. 2			Polarization	V
Temperature	24.9°C	Humidity	57%	Test Engineer	Eric Fu

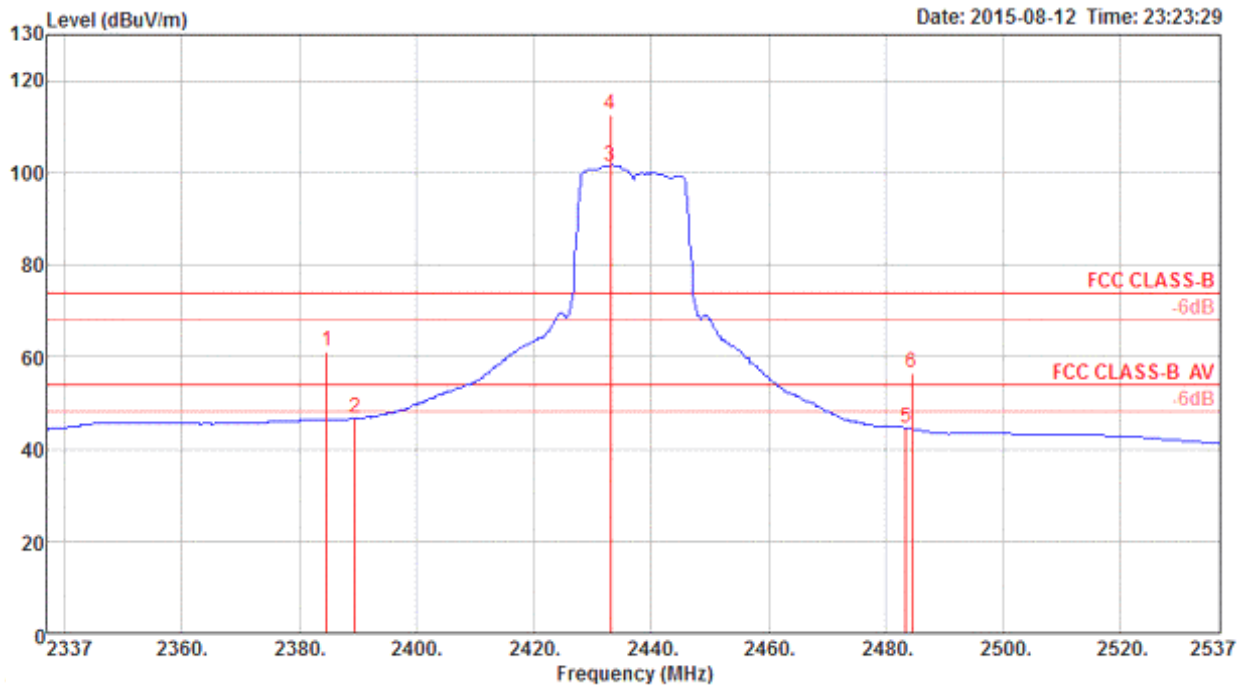

	Freq	Level	Limit	Over	Read	Cable	Antenna	Preamp	Remark	A/Pos	T/Pos	Pol/Phase
	MHz	dBuV/m	dBuV/m	dB	dBuV	dB	dB/m	dB		cm	deg	
1	2384.76	61.36	74.00	-12.64	29.10	4.08	28.18	0.00	Peak	139	168	VERTICAL
2	2389.56	46.55	54.00	-7.45	14.25	4.09	28.21	0.00	Average	139	168	VERTICAL
3	2433.15	101.56			69.16	4.12	28.28	0.00	Average	139	168	VERTICAL
4	2433.15	112.44			80.04	4.12	28.28	0.00	Peak	139	168	VERTICAL
5	2483.50	44.54	54.00	-9.46	12.01	4.16	28.37	0.00	Average	139	168	VERTICAL
6	2484.44	56.60	74.00	-17.40	24.07	4.16	28.37	0.00	Peak	139	168	VERTICAL

Note 1: Item 3, 4 are the fundamental frequency at 2437 MHz
 Note 2: Emission level (dBuV/m) = 20 log Emission level (uV/m).
 Note 3: Corrected Reading: Antenna Factor + Cable Loss + Read Level - Preamp Factor = Level.
 Note 4: Measurement receive antenna polarization: H (Horizontal), V (Vertical)

Band Edge and Fundamental Emissions					
Operating Mode	IEEE 802.11n 20MHz MCS0 / CH 11 / Ant. 2			Polarization	V
Temperature	24.9°C	Humidity	57%	Test Engineer	Eric Fu

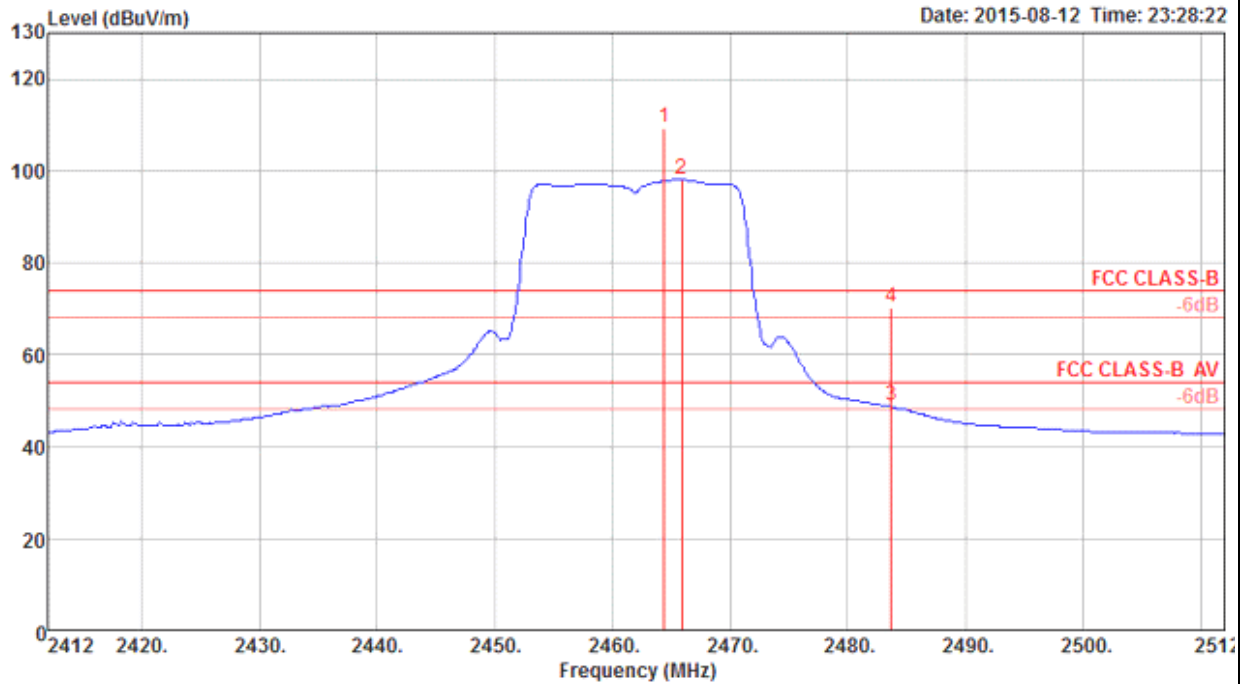

	Freq	Level	Limit Line	Over Limit	Read Level	Cable Loss	Antenna Factor	Preamp Factor	Remark	A/Pos	T/Pos	Pol/Phase
	MHz	dBuV/m	dBuV/m	dB	dBuV	dB	dB/m	dB		cm	deg	
1	2464.40	109.18			76.70	4.14	28.34	0.00	Peak	135	174	VERTICAL
2	2465.85	98.02			65.54	4.14	28.34	0.00	Average	135	174	VERTICAL
3	2483.64	48.72	54.00	-5.28	16.19	4.16	28.37	0.00	Average	135	174	VERTICAL
4	2483.64	70.23	74.00	-3.77	37.70	4.16	28.37	0.00	Peak	135	174	VERTICAL

Note 1: Item 1, 2 are the fundamental frequency at 2462 MHz
 Note 2: Emission level (dBuV/m) = 20 log Emission level (uV/m).
 Note 3: Corrected Reading: Antenna Factor + Cable Loss + Read Level - Preamp Factor = Level.
 Note 4: Measurement receive antenna polarization: H (Horizontal), V (Vertical)

Band Edge and Fundamental Emissions					
Operating Mode	IEEE 802.11n 20MHz MCS0 / CH 1 / Ant. 1+2 (CDD)			Polarization	V
Temperature	24.9°C	Humidity	57%	Test Engineer	Eric Fu

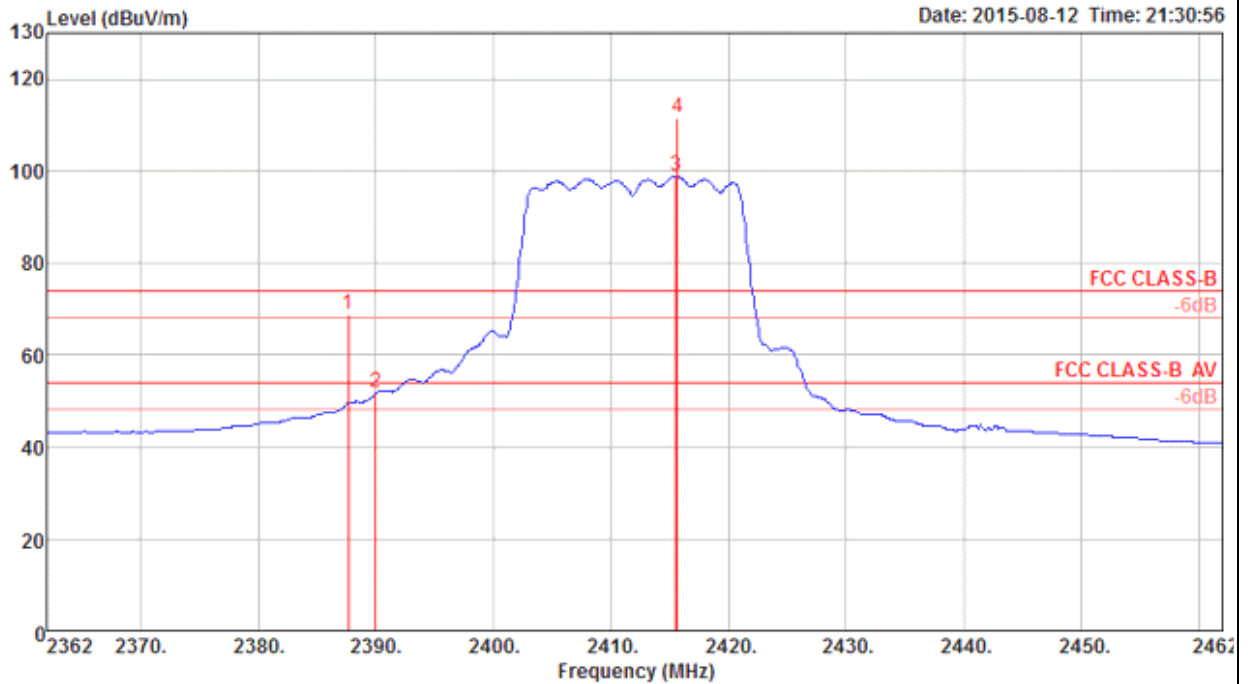

	Freq	Level	Limit Line	Over Limit	Read Level	Cable Loss	Antenna Factor	Preamp Factor	Remark	A/Pos	T/Pos	Pol/Phase
	MHz	dBuV/m	dBuV/m	dB	dBuV	dB	dB/m	dB		cm	deg	
1	2387.64	68.81	74.00	-5.19	36.51	4.09	28.21	0.00	Peak	145	168	VERTICAL
2	2390.00	51.76	54.00	-2.24	19.46	4.09	28.21	0.00	Average	145	168	VERTICAL
3	2415.53	98.96			66.61	4.11	28.24	0.00	Average	145	168	VERTICAL
4	2415.69	111.38			79.03	4.11	28.24	0.00	Peak	145	168	VERTICAL

Note 1: Item 3, 4 are the fundamental frequency at 2412 MHz
 Note 2: Emission level (dBuV/m) = 20 log Emission level (uV/m).
 Note 3: Corrected Reading: Antenna Factor + Cable Loss + Read Level - Preamp Factor = Level.
 Note 4: Measurement receive antenna polarization: H (Horizontal), V (Vertical)

Band Edge and Fundamental Emissions					
Operating Mode	IEEE 802.11n 20MHz MCS0 / CH 6 / Ant. 1+2 (CDD)			Polarization	V
Temperature	24.9°C	Humidity	57%	Test Engineer	Eric Fu

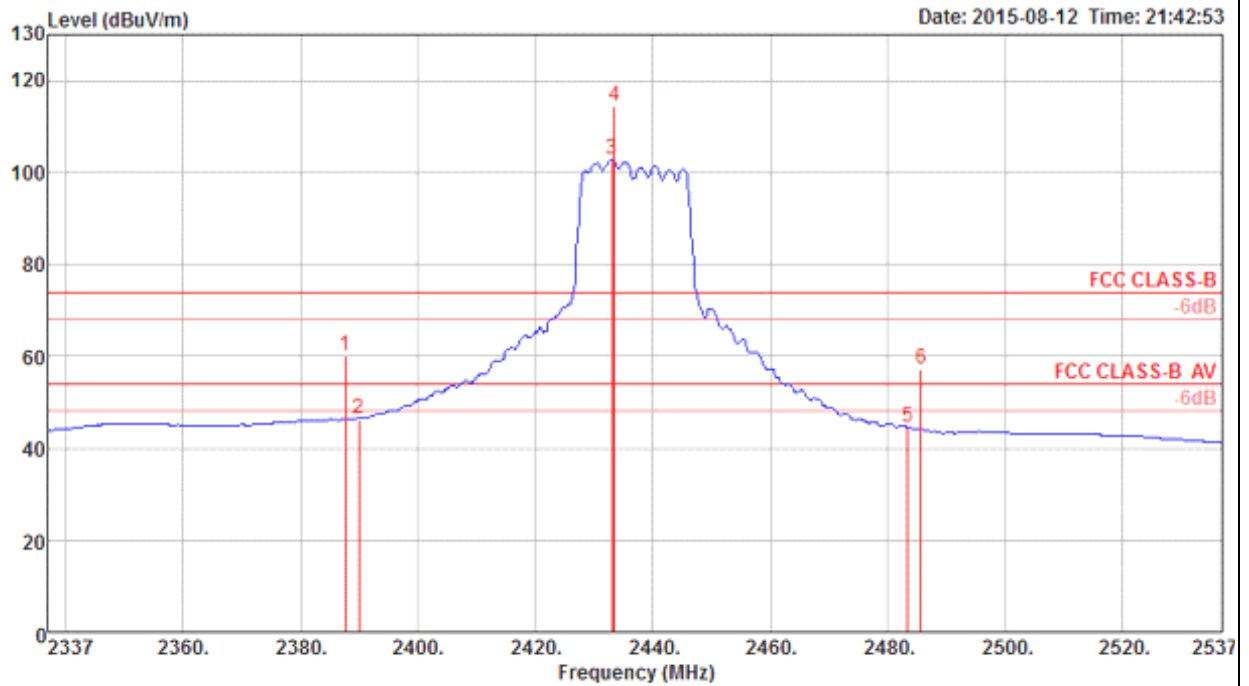

	Freq	Level	Limit	Over	Read	Cable	Antenna	Preamp	Remark	A/Pos	T/Pos	Pol/Phase
	MHz	dBuV/m	dBuV/m	dB	dBuV	dB	dB/m	dB		cm	deg	
1	2387.64	60.29	74.00	-13.71	27.99	4.09	28.21	0.00	Peak	138	169	VERTICAL
2	2390.00	46.43	54.00	-7.57	14.13	4.09	28.21	0.00	Average	138	169	VERTICAL
3	2433.15	102.87			70.47	4.12	28.28	0.00	Average	138	169	VERTICAL
4	2433.47	114.32			81.92	4.12	28.28	0.00	Peak	138	169	VERTICAL
5	2483.50	44.58	54.00	-9.42	12.05	4.16	28.37	0.00	Average	138	169	VERTICAL
6	2485.72	57.16	74.00	-16.84	24.63	4.16	28.37	0.00	Peak	138	169	VERTICAL

Note 1: Item 3, 4 are the fundamental frequency at 2437 MHz
 Note 2: Emission level (dBuV/m) = 20 log Emission level (uV/m).
 Note 3: Corrected Reading: Antenna Factor + Cable Loss + Read Level - Preamp Factor = Level.
 Note 4: Measurement receive antenna polarization: H (Horizontal), V (Vertical)

Band Edge and Fundamental Emissions					
Operating Mode	IEEE 802.11n 20MHz MCS0 / CH 11 / Ant. 1+2 (CDD)			Polarization	V
Temperature	24.9°C	Humidity	57%	Test Engineer	Eric Fu

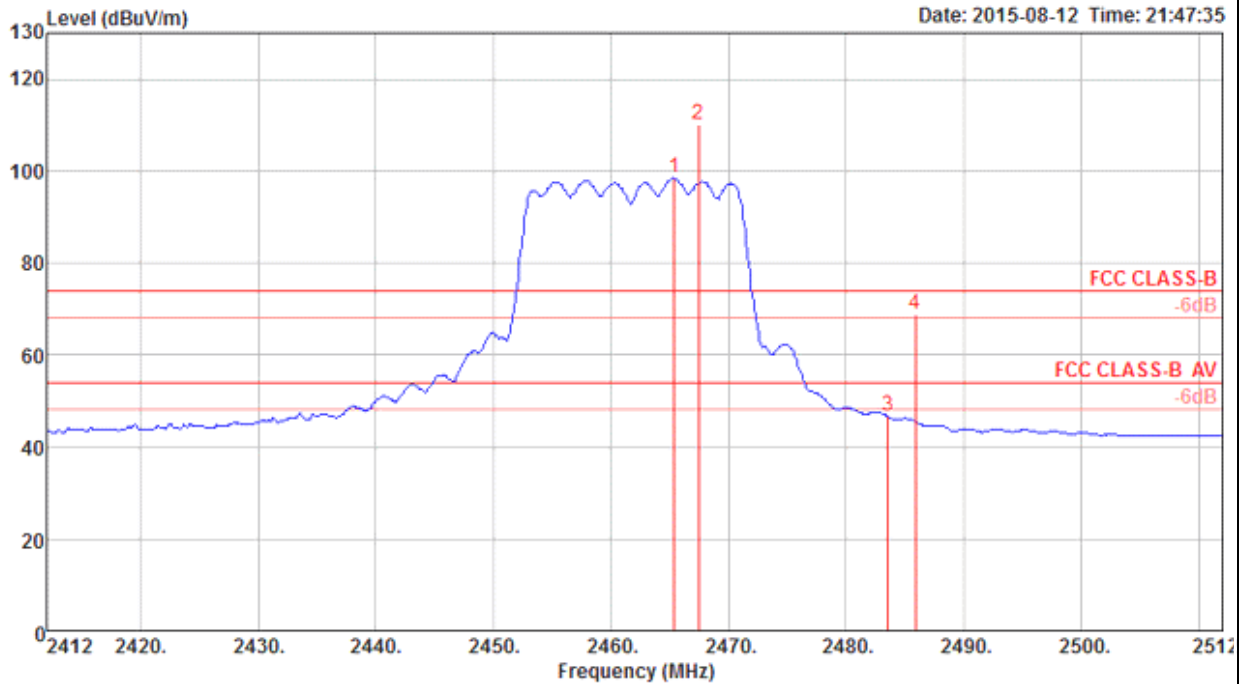

	Freq	Level	Limit Line	Over Limit	Read Level	Cable Loss	Antenna Factor	Preamp Factor	Remark	A/Pos	T/Pos	Pol/Phase
	MHz	dBuV/m	dBuV/m	dB	dBuV	dB	dB/m	dB		cm	deg	
1	2465.37	98.38			65.90	4.14	28.34	0.00	Average	154	170	VERTICAL
2	2467.45	109.94			77.46	4.14	28.34	0.00	Peak	154	170	VERTICAL
3	2483.50	46.64	54.00	-7.36	14.11	4.16	28.37	0.00	Average	154	170	VERTICAL
4	2485.88	68.76	74.00	-5.24	36.23	4.16	28.37	0.00	Peak	154	170	VERTICAL

Note 1: Item 1, 2 are the fundamental frequency at 2462 MHz
 Note 2: Emission level (dBuV/m) = 20 log Emission level (uV/m).
 Note 3: Corrected Reading: Antenna Factor + Cable Loss + Read Level - Preamp Factor = Level.
 Note 4: Measurement receive antenna polarization: H (Horizontal), V (Vertical)

3.6.8. Results of Emission not in Restricted Band

Following channel(s) was (were) selected for the final test as listed below.

MODE	TX Chain	TESTED CHANNEL	MODULATION TECHNOLOGY	MODULATION TYPE	DATA RATE (Mbps)
802.11b	Ant. 2	1, 6, 11	DSSS	DBPSK	1
802.11n 20MHz	Ant. 2	1, 6, 11	OFDM	BPSK	MCS0 (6.5)
802.11n 20MHz	Ant. 1+2, CDD	1, 6, 11	OFDM	BPSK	MCS0 (6.5)

Low Band Edge Plot on Configuration IEEE 802.11b / Reference Level / Ant. 2

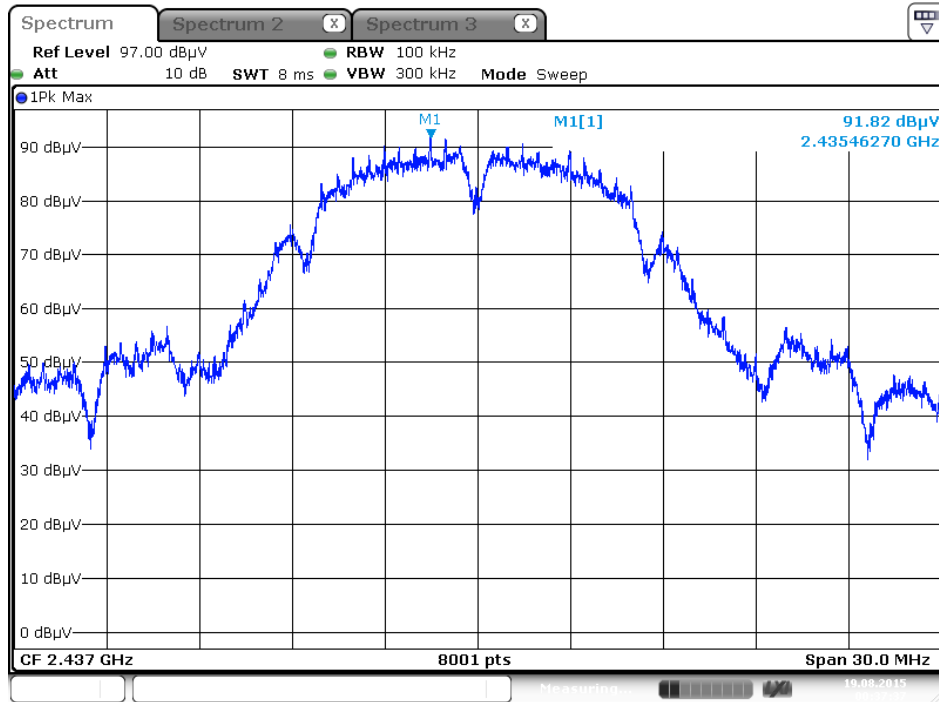

Low Band Edge Plot on Configuration IEEE 802.11b / CH 1 / Ant. 2 / 30MHz~2400MHz (down 30dBc)

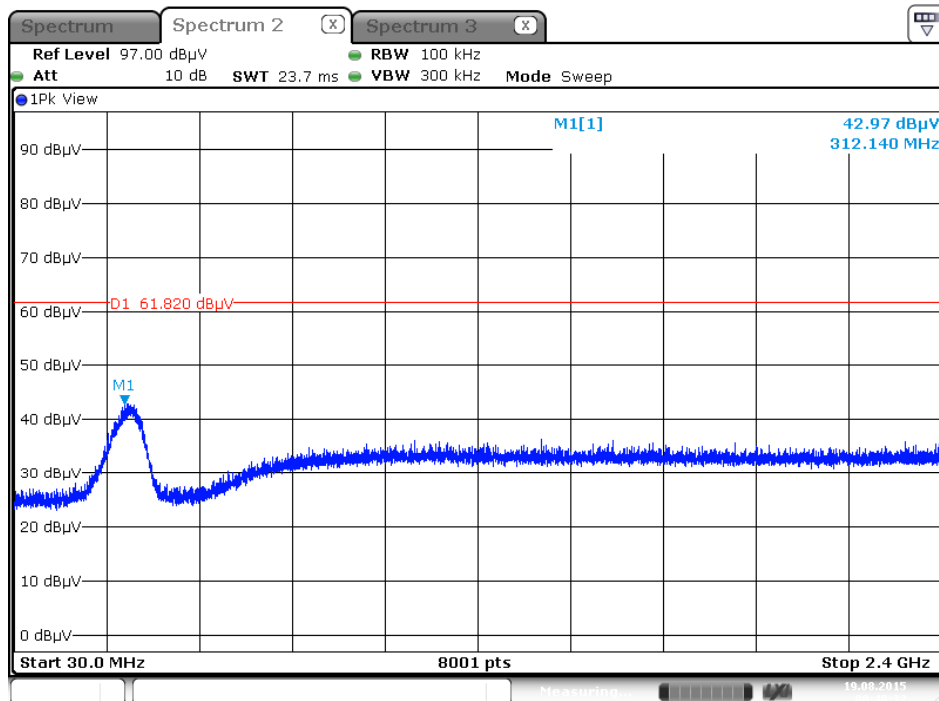

Low Band Edge Plot on Configuration IEEE 802.11b / CH 1 / Ant. 2 / 2500MHz~26500MHz (down 30dBc)

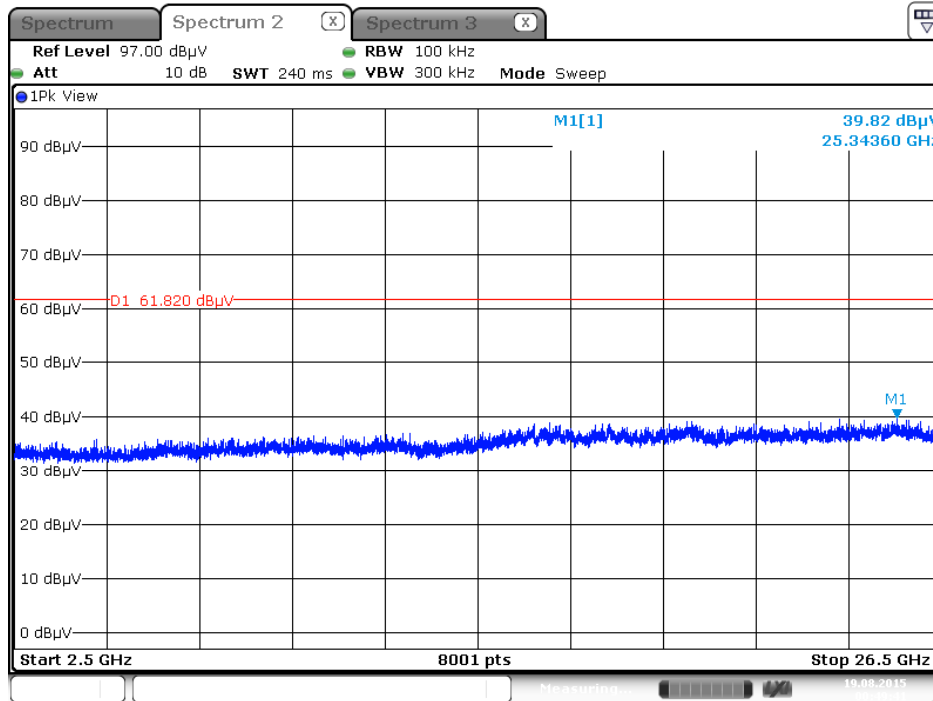

Date: 19 AUG 2015 00:49:41

Low Band Edge Plot on Configuration IEEE 802.11b / CH 11 / Ant. 2 / 30MHz~2400MHz (down 30dBc)

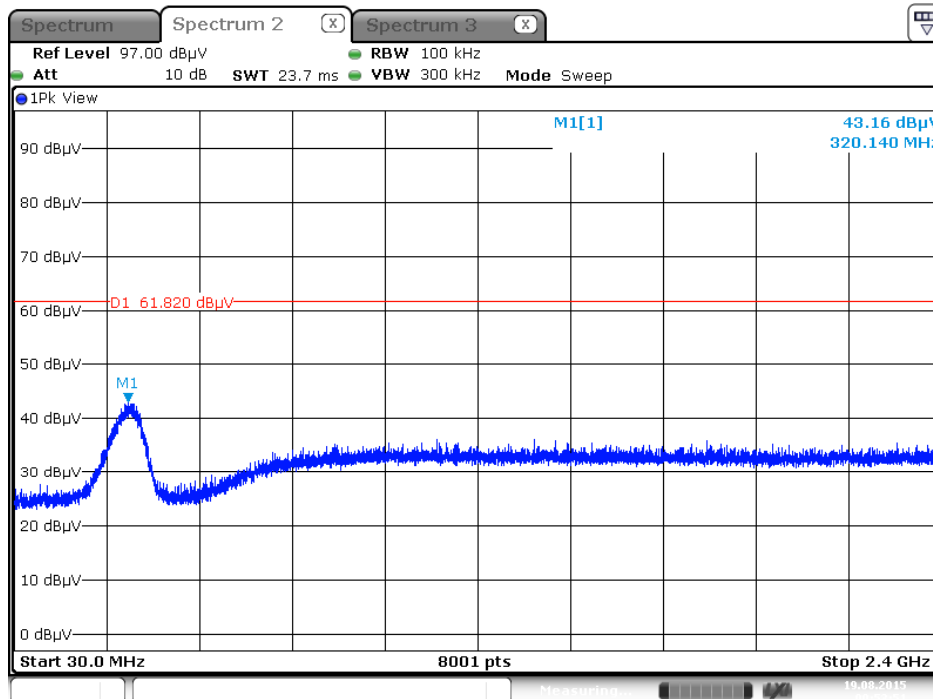

Date: 19 AUG 2015 00:53:51

Low Band Edge Plot on Configuration IEEE 802.11b / CH 11 / Ant. 2 / 2500MHz~26500MHz (down 30dBc)

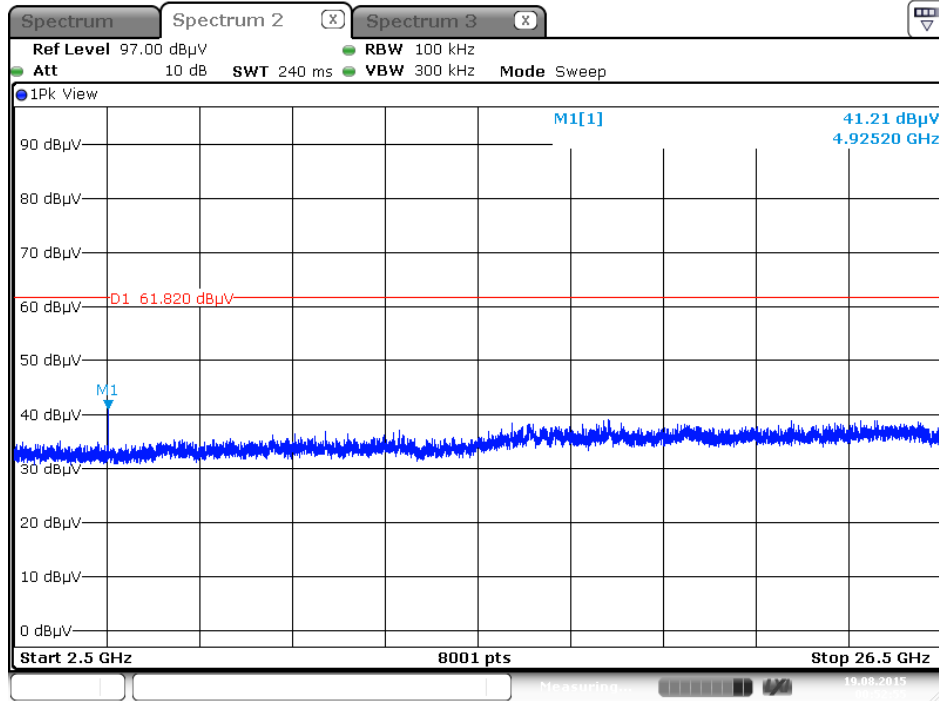

Date: 19 AUG 2015 00:52:55

Low Band Edge Plot on Configuration IEEE 802.11n 20MHz MCS0 / Reference Level / Ant. 2

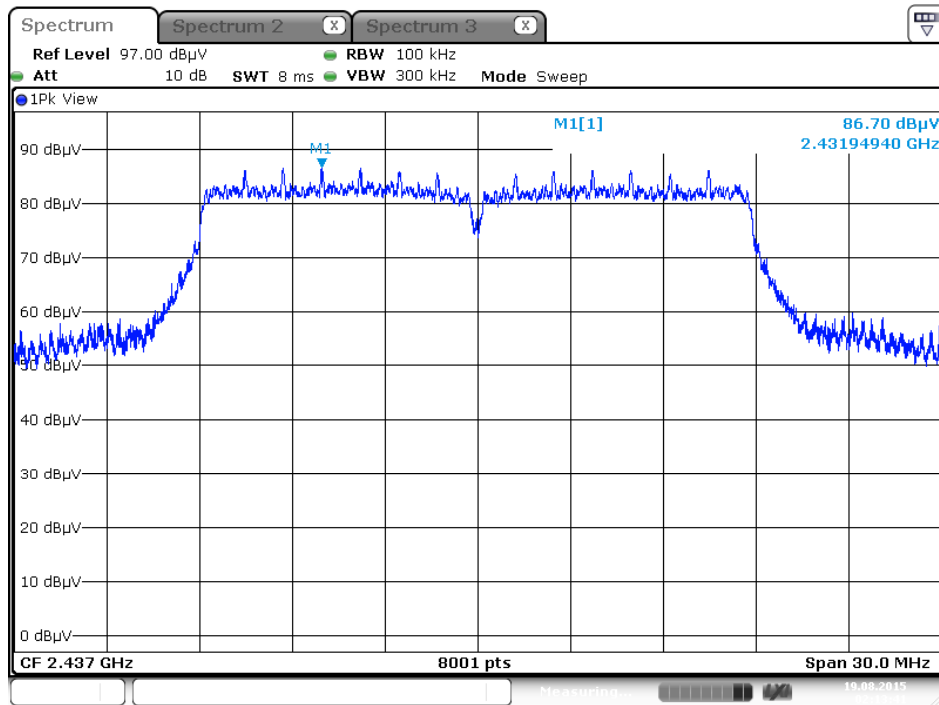

Date: 19 AUG. 2015 02:13:40

Low Band Edge Plot on Configuration IEEE 802.11n 20MHz MCS0 / CH 1 / Ant. 2 / 30MHz~2400MHz (down 30dBc)

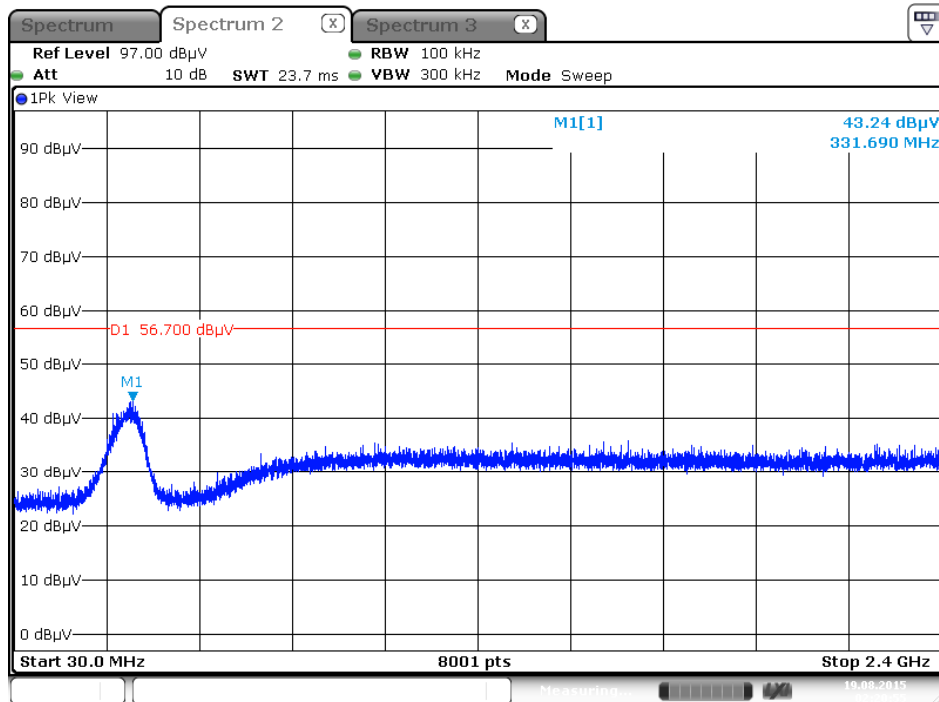

Date: 19 AUG. 2015 02:20:54

Low Band Edge Plot on Configuration IEEE 802.11n 20MHz MCS0 / CH 1 / Ant. 2 /
2500MHz~26500MHz (down 30dBc)

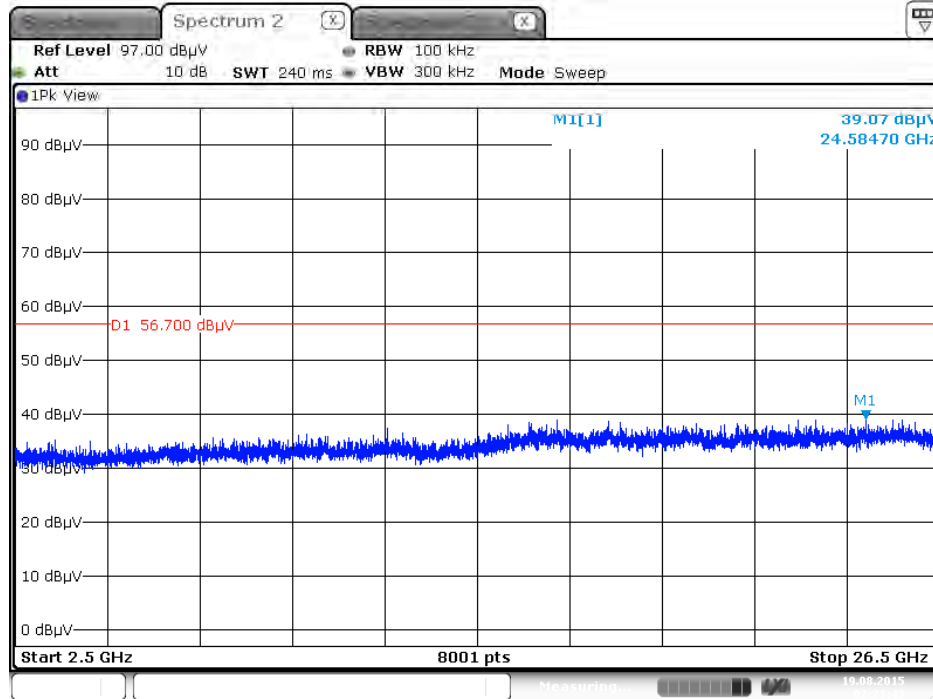

Date: 19 AUG. 2015 02:21:43

Low Band Edge Plot on Configuration IEEE 802.11n 20MHz MCS0 / CH 11 / Ant. 2 / 30MHz~2400MHz
(down 30dBc)

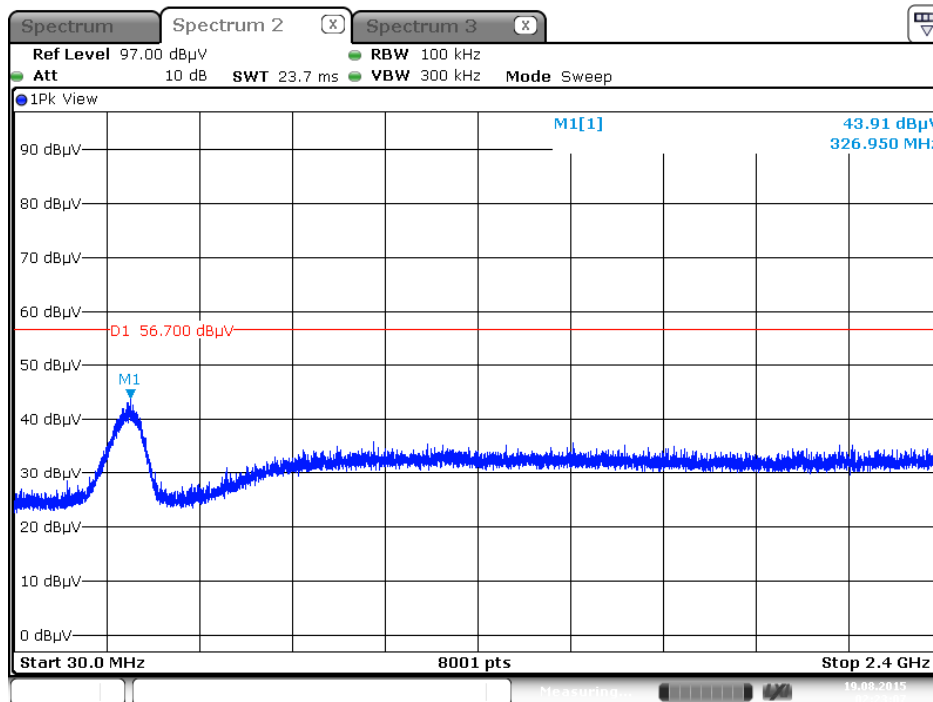

Date: 19 AUG. 2015 02:23:07

Low Band Edge Plot on Configuration IEEE 802.11n 20MHz MCS0 / CH 11 / Ant. 2 /
2500MHz~26500MHz (down 30dBc)

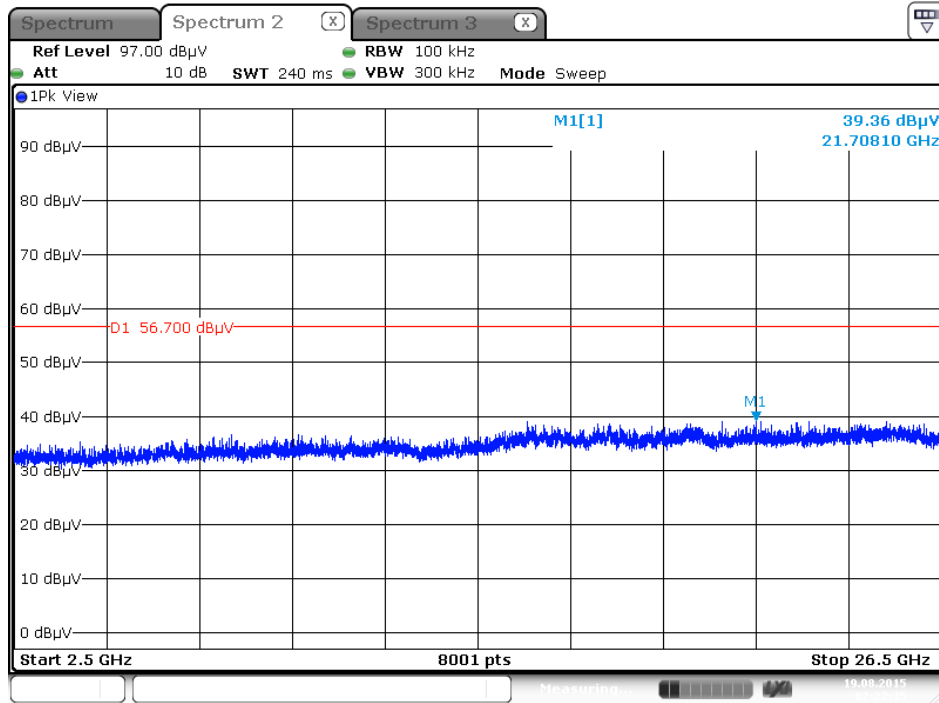

Date: 19 AUG 2015 02:22:35

Low Band Edge Plot on Configuration IEEE 802.11n 20MHz MCS0 / Reference Level / Ant. 1+2 (CDD)

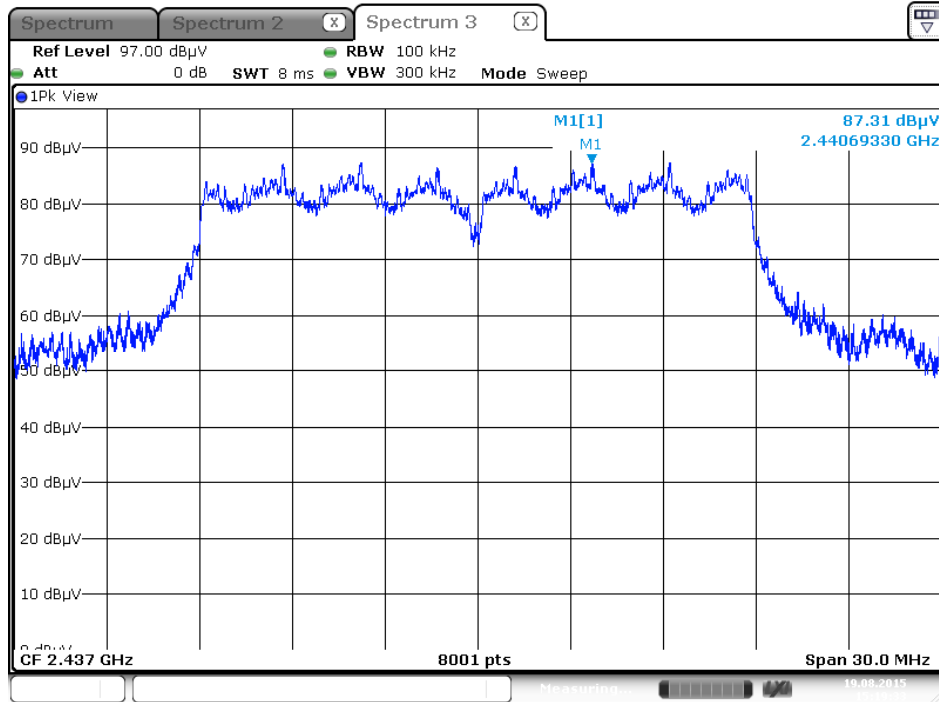

Date: 19 AUG 2015 15:19:33

Low Band Edge Plot on Configuration IEEE 802.11n 20MHz MCS0 / CH 1 / Ant. 1+2 (CDD) / 30MHz~2400MHz (down 30dBc)

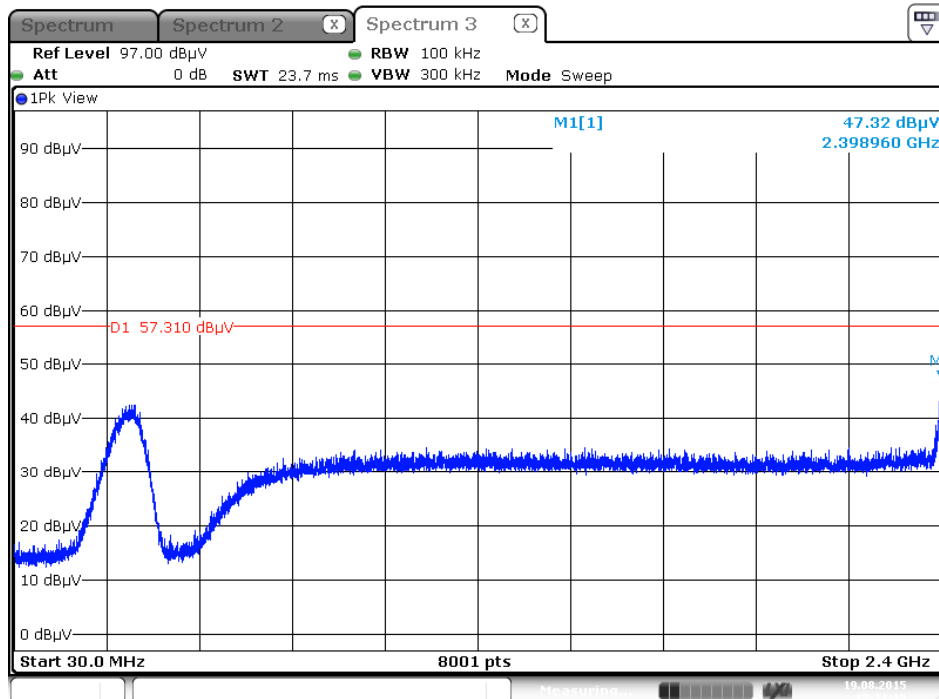

Date: 19 AUG 2015 15:21:15

Low Band Edge Plot on Configuration IEEE 802.11n 20MHz MCS0 / CH 1 / Ant. 1+2 (CDD) / 2500MHz~26500MHz (down 30dBc)

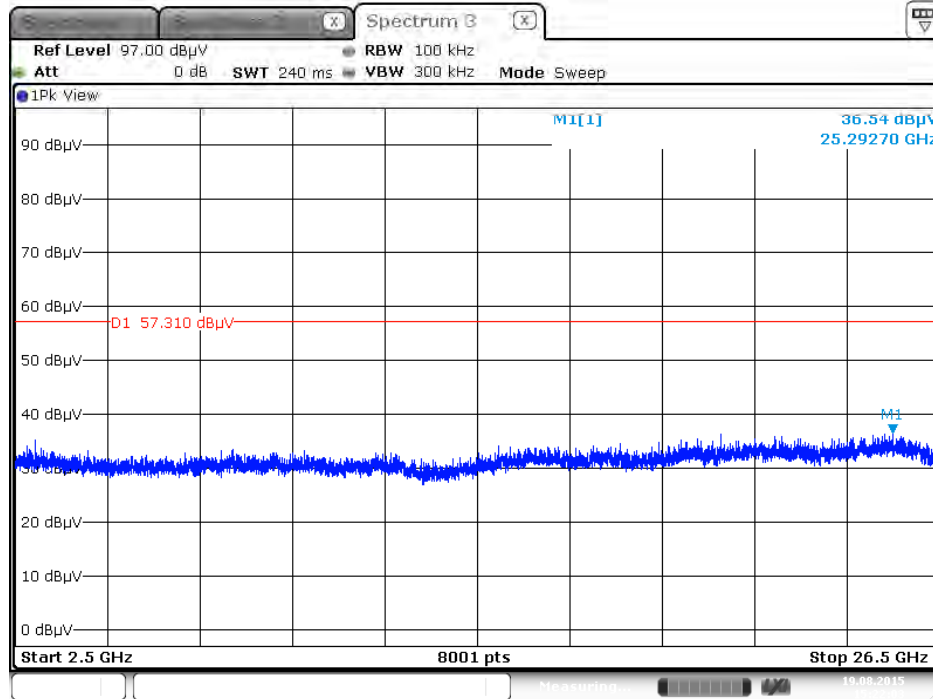

Date: 19 AUG. 2015 15:22:02

Low Band Edge Plot on Configuration IEEE 802.11n 20MHz MCS0 / CH 11 / Ant. 1+2 (CDD) / 30MHz~2400MHz (down 30dBc)

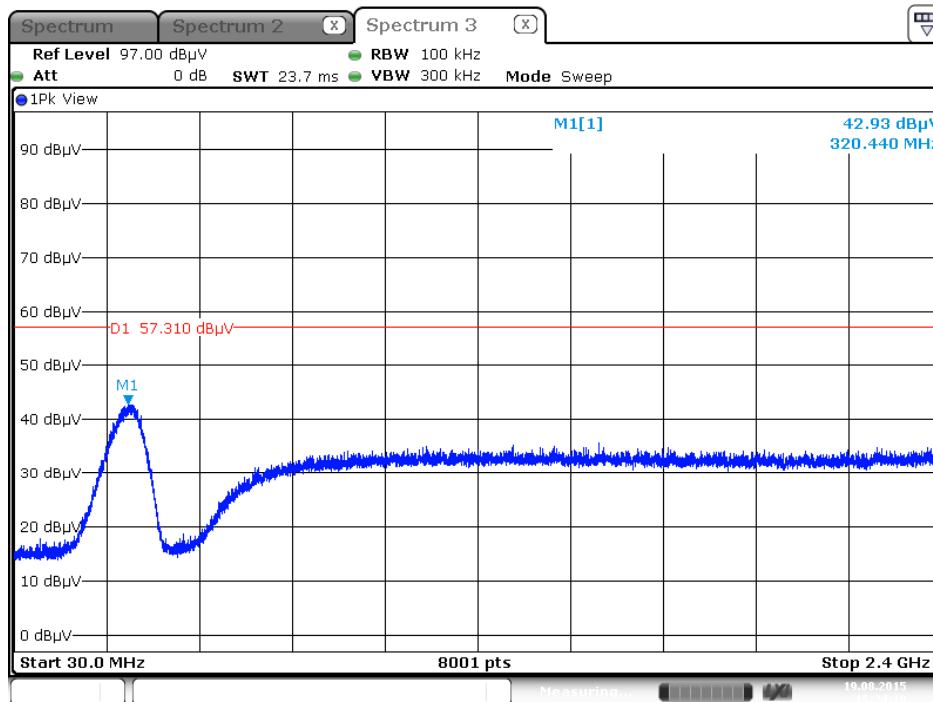

Date: 19 AUG. 2015 15:24:18

Low Band Edge Plot on Configuration IEEE 802.11n 20MHz MCS0 / CH 11 / Ant. 1+2 (CDD) / 2500MHz~26500MHz (down 30dBc)

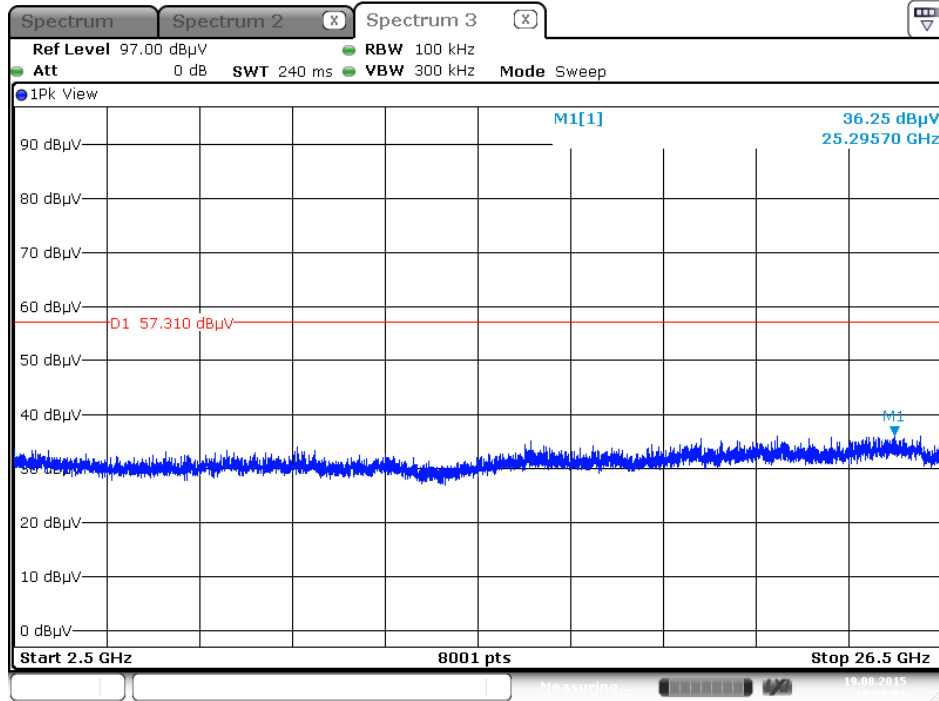

Date: 19 AUG 2015 15:23:01

3.7. Antenna Requirements

3.7.1. Limit

Except for special regulations, the Low-power Radio-frequency Devices must not be equipped with any jacket for installing an antenna with extension cable. An intentional radiator shall be designed to ensure that no antenna other than that furnished by the responsible party shall be used with the device. The use of a permanently attached antenna or of an antenna that uses a unique coupling to the intentional radiator shall be considered sufficient to comply with the provisions of this Section. The manufacturer may design the unit so that the user can replace a broken antenna, but the use of a standard antenna jack or electrical connector is prohibited. Further, this requirement does not apply to intentional radiators that must be professionally installed.

3.7.2. Antenna Connector Construction

Please refer to section 2.3 in this test report; antenna connector complied with the requirements.

4. LIST OF MEASURING EQUIPMENTS

Instrument	Manufacturer	Model No.	Serial No.	Characteristics	Calibration Date	Remark
LISN	Schwarzbeck	NSLK 8127	8127650	9kHz ~ 30MHz	Nov. 17, 2014	Conduction (CO02-CB)
LISN	Schwarzbeck	NSLK 8127	8127478	9kHz ~ 30MHz	Nov. 17, 2014	Conduction (CO02-CB)
EMI Receiver	Agilent	N9038A	MY52260140	9kHz ~ 8.4GHz	Jan. 13, 2015	Conduction (CO02-CB)
COND Cable	Woken	Cable	01	0.15MHz ~ 30MHz	Dec. 01, 2014	Conduction (CO02-CB)
Software	Audix	E3	5.410e	-	N.C.R.	Conduction (CO02-CB)
Pulse Limiter	Schwarzbeck	VTSD 9561F	9561-F073	9kHz ~ 30MHz	Sep. 26, 2014	Conduction (CO02-CB)
BILOG ANTENNA	Schaffner	CBL6112D	22021	20MHz ~ 2GHz	May 06, 2015	Radiation (03CH01-CB)
Horn Antenna	EMCO	3115	00075790	750MHz ~ 18GHz	Oct. 28, 2014	Radiation (03CH01-CB)
Horn Antenna	Schwarzbeck	BBHA 9170	BBHA9170252	15GHz ~ 40GHz	Aug. 22, 2014	Radiation (03CH01-CB)
Pre-Amplifier	Agilent	8447D	2944A10991	0.1MHz ~ 1.3GHz	Feb. 24, 2015	Radiation (03CH01-CB)
Pre-Amplifier	Agilent	8449B	3008A02310	1GHz ~ 26.5GHz	Jan. 12, 2015	Radiation (03CH01-CB)
Spectrum Analyzer	R&S	FSP40	100056	9kHz ~ 40GHz	Nov. 06, 2014	Radiation (03CH01-CB)
EMI Receiver	Agilent	N9038A	MY52260123	9kHz ~ 8.4GHz	Jan. 21, 2015	Radiation (03CH01-CB)
Loop Antenna	Teseq	HLA 6120	24155	9kHz - 30 MHz	Mar. 12, 2015	Radiation (03CH01-CB)
RF Cable-low	Woken	Low Cable-1	N/A	30 MHz ~ 1 GHz	Nov. 15, 2014	Radiation (03CH01-CB)
RF Cable-high	Woken	High Cable-40G-1	N/A	1 GHz ~ 40 GHz	Nov. 15, 2014	Radiation (03CH01-CB)
RF Cable-high	Woken	High Cable-40G-2	N/A	1 GHz ~ 40 GHz	Nov. 15, 2014	Radiation (03CH01-CB)
Spectrum analyzer	R&S	FSV40	100979	9kHz~40GHz	Dec. 12, 2014	Conducted (TH01-CB)
RF Cable-high	Woken	RG402	High Cable-7	1 GHz – 26.5 GHz	Nov. 15, 2014	Conducted (TH01-CB)
RF Cable-high	Woken	RG402	High Cable-8	1 GHz – 26.5 GHz	Nov. 15, 2014	Conducted (TH01-CB)
RF Cable-high	Woken	RG402	High Cable-9	1 GHz – 26.5 GHz	Nov. 15, 2014	Conducted (TH01-CB)
RF Cable-high	Woken	RG402	High Cable-10	1 GHz – 26.5 GHz	Nov. 15, 2014	Conducted (TH01-CB)
RF Cable-high	Woken	RG402	High Cable-6	1 GHz – 26.5 GHz	Nov. 15, 2014	Conducted (TH01-CB)
Power Sensor	Agilent	U2021XA	MY54320015	50MHz-18GHz	Mar. 23, 2015	Conducted (TH01-CB)

Note: Calibration Interval of instruments listed above is one year.

N.C.R. means Non-Calibration required.

5. MEASUREMENT UNCERTAINTY

Test Items	Uncertainty	Remark
Conducted Emission (150kHz ~ 30MHz)	2.4 dB	Confidence levels of 95%
Radiated Emission (30MHz ~ 1,000MHz)	3.6 dB	Confidence levels of 95%
Radiated Emission (1GHz ~ 18GHz)	3.7 dB	Confidence levels of 95%
Radiated Emission (18GHz ~ 40GHz)	3.5 dB	Confidence levels of 95%
Conducted Emission	1.7 dB	Confidence levels of 95%