



FCC TEST REPORT

FCC ID:RSBPARTYSYSTEMDRU

Product Name	Amplifier Speaker
Model Name	Party System Drum BK-361D10/BK-363D10/BK-366D10/BK-380D10
Brand Name	EDISON PROFESSIONAL, BOOK
Report No.	PTC19051605201E-FC01
Prepared for	
BK Pride Electronics Co.,Ltd.	
Book Digital Industry Park Meilin District,Dalingshan Town,Dongguan City,Guangdong Province	
Prepared by	
Dongguan Precise Testing & Certification Corp., Ltd.	
Building D, Baoding Technology Park, Guangming Road 2, Guangming Community, Dongcheng District, Dongguan, Guangdong, China	

**1TEST RESULT CERTIFICATION**

Applicant's name	:	BK Pride Electronics Co.,Ltd.
Address	:	Book Digital Industry Park Meilin District,Dalingshan Town,Dongguan City,Guangdong Province
Manufacture's name	:	BK Pride Electronics Co.,Ltd.
Address	:	Book Digital Industry Park Meilin District,Dalingshan Town,Dongguan City,Guangdong Province
Product name	:	Amplifier Speaker
Model name	:	Party System Drum/ BK-361D10/BK-363D10/BK-366D10/BK-380D10
Standards	:	FCC CFR47 Part 15 Section 15.247
Test procedure	:	ANSI C63.10:2013
Test Date	:	June 08, 2019 to June 21, 2019
Date of Issue	:	June 24, 2019
Test Result	:	Pass

This device described above has been tested by PTC, and the test results show that the equipment under test (EUT) is in compliance with the FCC requirements. And it is applicable only to the tested sample identified in the report.
This report shall not be reproduced except in full, without the written approval of PTC, this document may be altered or revised by PTC, personal only, and shall be noted in the revision of the document.

Test Engineer:

Leo Yang / Engineer

Technical Manager:

Chris Du / Manager



CONTENTS

1 TEST RESULT CERTIFICATION.....	2
1. SUMMARY OF TEST RESULTS.....	6
2. GENERAL TEST INFORMATION.....	7
2.1. DESCRIPTION OF EUT.....	7
2.2. ACCESSORIES OF EUT.....	7
2.3. ASSISTANT EQUIPMENT USED FOR TEST.....	7
2.4. BLOCK DIAGRAM OF EUT CONFIGURATION FOR TEST.....	7
2.5. TEST ENVIRONMENT CONDITIONS.....	8
2.6. TEST FACILITY.....	8
2.7. Equipments List.....	9
2.8. MEASUREMENT UNCERTAINTY.....	10
3. MAXIMUM PEAK OUTPUT POWER.....	11
3.1. TEST Requirement.....	11
3.2. BLOCK DIAGRAM OF TEST SETUP.....	11
3.3. Test Procedure.....	11
3.4. TEST RESULT.....	11
4. 20DB BANDWIDTH.....	12
4.1. TEST Requirement.....	12
4.2. BLOCK DIAGRAM OF TEST SETUP.....	12
4.3. LIMITS.....	12
4.4. TEST PROCEDURE.....	12
4.5. TEST RESULT.....	13
4.6. ORIGINAL TEST DATA.....	13
5. CARRIER FREQUENCY SEPARATION.....	17
5.1. BLOCK DIAGRAM OF TEST SETUP.....	17
5.2. LIMITS.....	17
5.3. TEST PROCEDURE.....	17
5.4. TEST RESULT.....	17
5.5. ORIGINAL TEST DATA.....	17



6. NUMBER OF HOPPING CHANNEL.....	19
6.1. TEST RequireMENT.....	19
6.2. BLOCK DIAGRAM OF TEST SETUP.....	19
6.3. LIMITS.....	19
6.4. TEST PROCEDURE.....	19
6.5. TEST RESULT.....	19
6.6. ORIGINAL TEST DATA.....	20
7. DWELL TIME.....	22
7.1. TEST REQUIreMENT.....	22
7.2. BLOCK DIAGRAM OF TEST SETUP.....	22
7.3. LIMITS.....	22
7.4. TEST PROCEDURE.....	22
7.5. TEST RESULT.....	23
7.6. ORIGINAL TEST DATA.....	23
8. RADIATED EMISSION.....	30
8.1. TEST Requirement.....	30
8.2. TEST SETUP AND PROCEDURE.....	30
8.3. LIMIT.....	33
8.4. TEST DATA.....	33
9. BAND EDGE COMPLIANCE.....	37
9.1. TEST REQuirement.....	37
9.2. BLOCK DIAGRAM OF TEST SETUP.....	37
9.3. LIMIT.....	37
9.4. TEST PROCEDURE.....	37
9.5. TEST RESULT AND DATA.....	38
9.6. ORIGINAL TEST DATA.....	38
10. BAND EDGE COMPLIANCE (CONDUCTED METHOD).....	40
10.1. TEST REQUIreMENT.....	40
10.2. BLOCK DIAGRAM OF TEST SETUP.....	40
10.3. LIMIT.....	40
10.4. TEST RESULT.....	40
10.5. ORIGINAL TEST DATA.....	40
11. POWER LINE CONDUCTED EMISSION.....	45
11.1. TEST EQUIPMENT.....	45
11.2. TEST SETUP AND PROCEDURE.....	45



11.3. POWER LINE CONDUCTED EMISSION LIMITS(CLASS B).....	45
11.4. TEST DATA.....	46
12. ANTENNA REQUIREMENTS.....	49
12.1. LIMIT.....	49
12.2. RESULT.....	49



1. Summary of test results

Description of Test Item	Standard	Results
Maximum Peak Output Power	FCC Part 15: 15.247(b)(1) ANSI C63.10 :2013	PASS
20dB Bandwidth	FCC Part 15: 15.215 ANSI C63.10 :2013	PASS
Carrier Frequency Separation	FCC Part 15: 15.247(a)(1) ANSI C63.10 :2013	PASS
Number Of Hopping Channel	FCC Part 15: 15.247(a)(1)(iii) ANSI C63.10 :2013	PASS
Dwell Time	FCC Part 15: 15.247(a)(1)(iii) ANSI C63.10 :2013	PASS
Radiated Emission	FCC Part 15: 15.209 FCC Part 15: 15.247(d) ANSI C63.10 :2013	PASS
Band Edge Compliance	FCC Part 15: 15.247(d) ANSI C63.10 :2013	PASS
Power Line Conducted Emissions	FCC Part 15: 15.207 ANSI C63.10 :2013	PASS
Antenna requirement	FCC Part 15: 15.203	PASS

2. General test information

2.1. Description of EUT

EUT* Name	:	Amplifier Speaker
Model Number	:	Party System Drum BK-361D10/BK-363D10/BK-366D10/BK-380D10
Trade Mark	:	EDISON PROFESSIONAL, BOOK
EUT function description	:	Please reference user manual of this device
Power supply	:	AC 120V 50Hz
Radio Specification	:	Bluetooth V2.1+EDR
Operation frequency	:	2402MHz -2480MHz
Modulation	:	GFSK, $\pi/4$ -DQPSK, 8-DPSK
Data rate	:	1Mbps, 2Mbps, 3Mbps
Antenna Type	:	Integrated antenna, maximum PK gain:0dBi
Date of Receipt	:	June. 07, 2019
Sample Type	:	Series models

Note: EUT is the abbr.of equipment under test.

2.2. Accessories of EUT

Description of Accessories	Manufacturer	Model number or Type	Other
Power adapter	Shenzhen Zhongling Electronic Technology Co.,Ltd.	ZAU-B050050A-04	/

2.3. Assistant equipment used for test

Description of Assistant	Manufacturer	Model number or Type	EMC Compliance	SN
Notebook	DELL	Latitude D610	FCC DOC	00045-534-136-300

2.4. Block diagram of EUT configuration for test

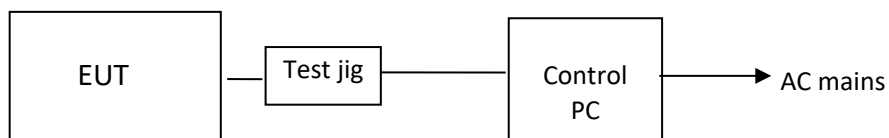

EUT's Bluetooth module was connected to a special test jig provided by manufacturer which has a



standard RSS-232 connector to connect to control PC, and the control PC will run a special test software "RF Control Kit v1.0.exe" provided by manufacturer to control EUT work in test mode as blow table.

Tested mode, channel, information		
Mode	Channel	Frequency (MHz)
GFSK hopping on Tx Mode	CH0 to CH78	2402 to 2480
8-DPSK hopping on Tx Mode	CH0 to CH78	2402 to 2480
GFSK hopping off Tx Mode	CH0	2402
	CH39	2441
	CH78	2480
$\pi/4$ -DQPSK hopping off Tx Mode	CH0	2402
	CH39	2441
	CH78	2480
8-DPSK hopping off Tx Mode	CH0	2402
	CH39	2441
	CH78	2480

Note1: Some modes not apply for all the test items.

Note2: For $\pi/4$ -DQPSK its same modulation type with 8-DPSK, and based exploratory test, there is no significant difference of that two types test result, so except output power, all other items final test were only performed with 8-DPSK and GFSK.

2.5. Test environment conditions

During the measurement the environmental conditions were within the listed ranges:

Temperature range:	21-25°C
Humidity range:	40-75%
Pressure range:	86-106kPa

2.6. Test Facility

Test Location	Dongguan Precise Testing & Certification Corp., Ltd.
Address	Building D, Baoding Technology Park, Guangming Road2, Dongcheng District, Dongguan, Guangdong, China
Accreditation Certificate	FCC Registration Number: 790290 A2LA Certificate No.: 4408.01 IC Registration Number: 12191A-1



2.7. Equipments List

RF Conducted Test

Name of Equipment	Manufacturer	Model	Serial No.	Characteristics	Calibration Due
MXG Signal Analyzer	Agilent	N9020A	MY56070279	10Hz-30GHz	Sep.19, 2019
Coaxial Cable	CDS	79254	46107086	10Hz-30GHz	Sep.19, 2019
Antenna Connector	Florida RF Labs	N/A	RF01#	N/A	Sep.19, 2019
Power Meter	Anritsu	ML2495A	0949003	N/A	Sep.19, 2019
Power Sensor	Anritsu	MA2411B	0917017	N/A	Sep.19, 2019

Remark: The temporary antenna connector is soldered on the PCB board in order to perform conducted tests and this temporary antenna connector is listed in the equipment list.

Radiated Emissions

Name of Equipment	Manufacturer	Model	Serial No.	Characteristics	Calibration Due
EMI Test Receiver	Rohde&Schwarz	ESCI	101417	9KHz-3GHz	Sep.19, 2019
Loop Antenna	Schwarzbeck	FMZB 1519	012	9 KHz -30MHz	Sep.19, 2019
Bilog Antenna	SCHWARZBECK	VULB9160	9160-3355	25MHz-2GHz	Sep.19, 2019
Preamplifier (low frequency)	SCHWARZBECK	BBV 9475	9745-0013	1MHz-1GHz	Sep.19, 2019
Cable	Schwarzbeck	PLF-100	549489	9KHz-3GHz	Sep.19, 2019
Spectrum Analyzer	Agilent	E4407B	MY45109572	9KHz-40GHz	Sep.19, 2019
Horn Antenna	SCHWARZBECK	9120D	9120D-1246	1GHz-18GHz	Sep.19, 2019
Power Amplifier	LUNAR EM	LNA1G18-40	J10100000081	1GHz-26.5GHz	Sep.19, 2019
Horn Antenna	SCHWARZBECK	BBHA 9170	9170-181	14GHz-40GHz	Sep.25, 2019
Amplifier	SCHWARZBECK	BBV 9721	9721-205	18GHz-40GHz	Sep.19, 2019
Cable	H+S	CBL-26	N/A	1GHz-26.5GHz	Sep.19, 2019
RF Cable	R&S	R204	R21X	1GHz-40GHz	Sep.19, 2019



Conducted Emissions

Name of Equipment	Manufacturer	Model	Serial No.	Characteristics	Calibration Due
EMI Test Receiver	Rohde&Schwarz	ESCI	101417	9KHz-3GHz	Sep.19, 2019
Artificial Mains Network	Rohde&Schwarz	L2-16B	000WX31025	9KHz-300MHz	Sep.19, 2019
Artificial Mains Network	Rohde&Schwarz	ENV216	101342	9KHz-300MHz	Sep.19, 2019

2.8. Measurement uncertainty

Parameter	Uncertainty
RF output power, conducted	±1.0dB
Power Spectral Density, conducted	±2.2dB
Radio Frequency	± 1 x 10 ⁻⁶
Bandwidth	± 1.5 x 10 ⁻⁶
Time	±2%
Duty Cycle	±2%
Temperature	±1°C
Humidity	±5%
DC and low frequency voltages	±3%
Conducted Emissions (150kHz~30MHz)	±3.64dB
Radiated Emission(30MHz~1GHz)	±5.03dB
Radiated Emission(1GHz~25GHz)	±4.74dB
Remark: The coverage Factor (k=2), and measurement Uncertainty for a level of Confidence of 95%	



3. Maximum Peak Output Power

3.1. Test Requirement

Test Requirement : FCC CFR47 Part 15 Section 15.247
 Test Method : ANSI C63.10:2013
 Test Limit : Regulation 15.247 (b)(1), For frequency hopping systems operating in the 2400-2483.5 MHz band employing at least 75 non-overlapping hopping channels, and all frequency hopping systems in the 5725-5850 MHz band: 1 watt (30dBm). For all other frequency hopping systems in the 2400-2483.5 MHz band: 0.125 watts.
 Refer to the result “Number of Hopping Frequency” of this document. The 0.125watts (20.97 dBm) limit applies.

3.2. Block diagram of test setup



3.3. Test Procedure

(1) The EUT tested system was configured as the statements of 2.4 Unless otherwise a special operating condition is specified in the follows during the testing.

3.4. Test Result

EUT: Amplifier Speaker		M/N: Party System Drum		
Mode	Freq (MHz)	Result (dBm)	Limit (dBm)	Conclusion
GFSK	2402	1.23	30	PASS
	2441	1.45	30	PASS
	2480	1.67	30	PASS
$\pi/4$ -DQPSK	2402	1.01	21	PASS
	2441	1.23	21	PASS
	2480	1.45	21	PASS
8-DPSK	2402	0.56	21	PASS
	2441	0.67	21	PASS
	2480	0.89	21	PASS



4. 20dB Bandwidth

4.1. Test Requirement

Test Requirement : FCC CFR47 Part 15 Section 15.247

Test Method : ANSI C63.10:2013

4.2. Block diagram of test setup

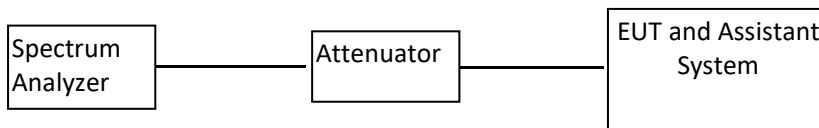

4.3. Limits

Intentional radiators operating under the alternative provisions to the general emission limits, as contained in § 15.217 through 15.257 and in Subpart E of this part, must be designed to ensure that the 20 dB bandwidth of the emission, or whatever bandwidth may otherwise be specified in the specific rule section under which the equipment operates, is contained within the frequency band designated in the rule section under which the equipment is operated.

4.4. Test Procedure

- (1) Configure EUT and assistant system according clause 2.4 and 4.2
- (2) Connect EUT's antenna output to spectrum analyzer by RF cable and through a 10dB attenuator.
- (3) Configure EUT work in test mode as stated in clause 2.4.
- (4) The bandwidth of the fundamental frequency was measured by spectrum analyzer with 30kHz RBW and 100kHz VBW. The 20dB bandwidth is defined as the total spectrum the power of which is higher than peak power minus 20dB.



4.5. Test Result

EUT: Amplifier Speaker		M/N: Party System Drum			
Mode	Freq (MHz)	Result (MHz)	Limit (MHz)	Margin (MHz)	Conclusion
GFSK	2402	0.729	/	/	PASS
	2441	0.729	/	/	PASS
	2480	0.729	/	/	PASS
8-DPSK	2402	1.138	/	/	PASS
	2441	1.138	/	/	PASS
	2480	1.138	/	/	PASS

4.6. Original test data

GFSK Mode

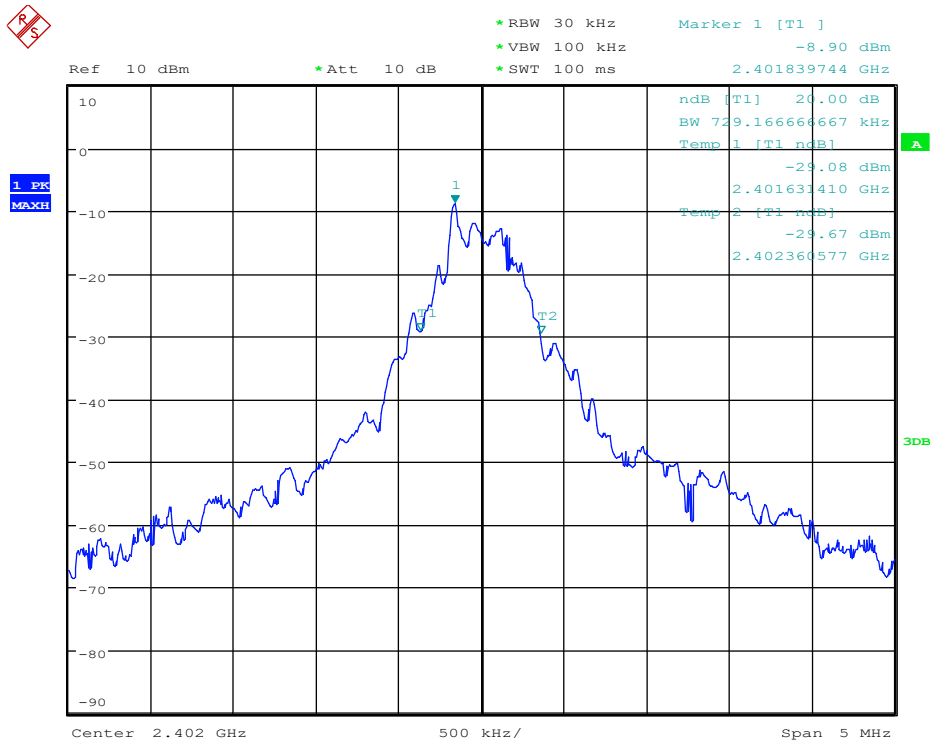

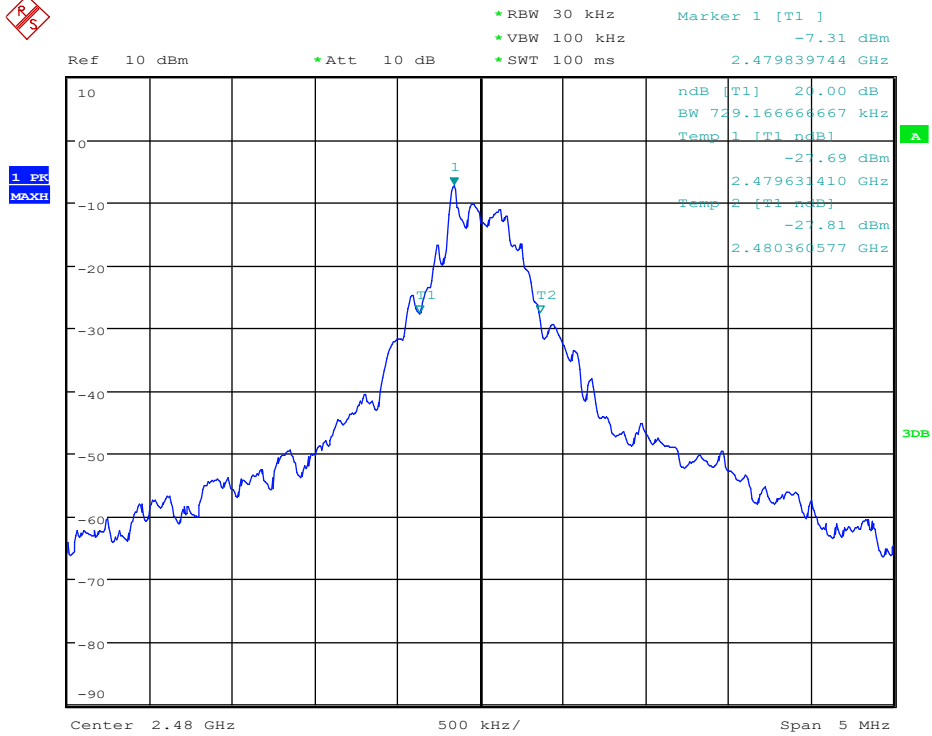
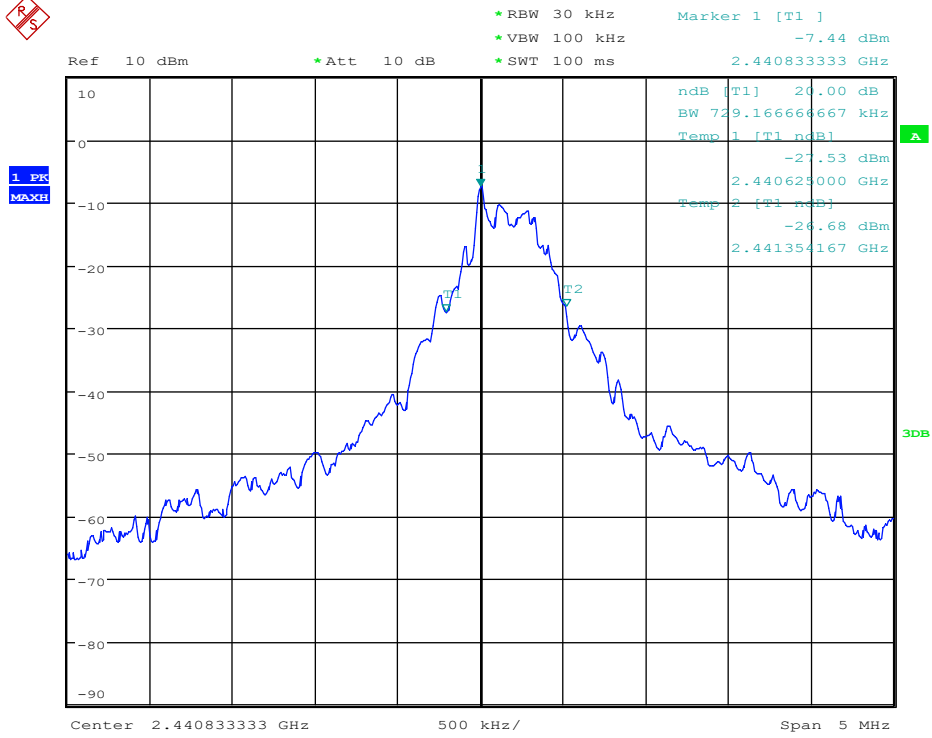



8-DPSK Mode

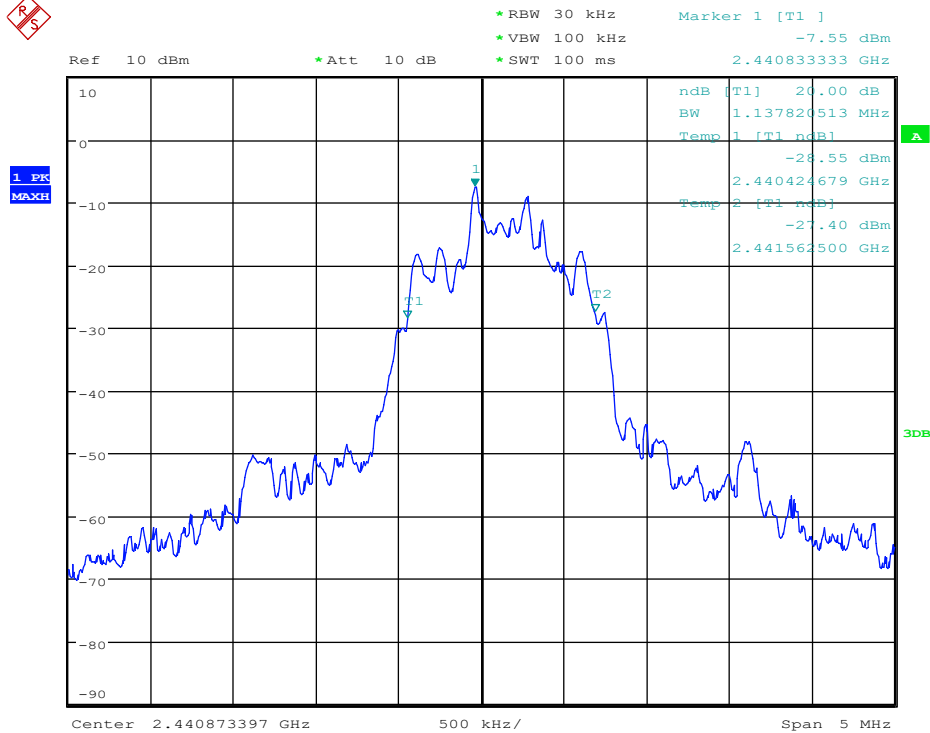
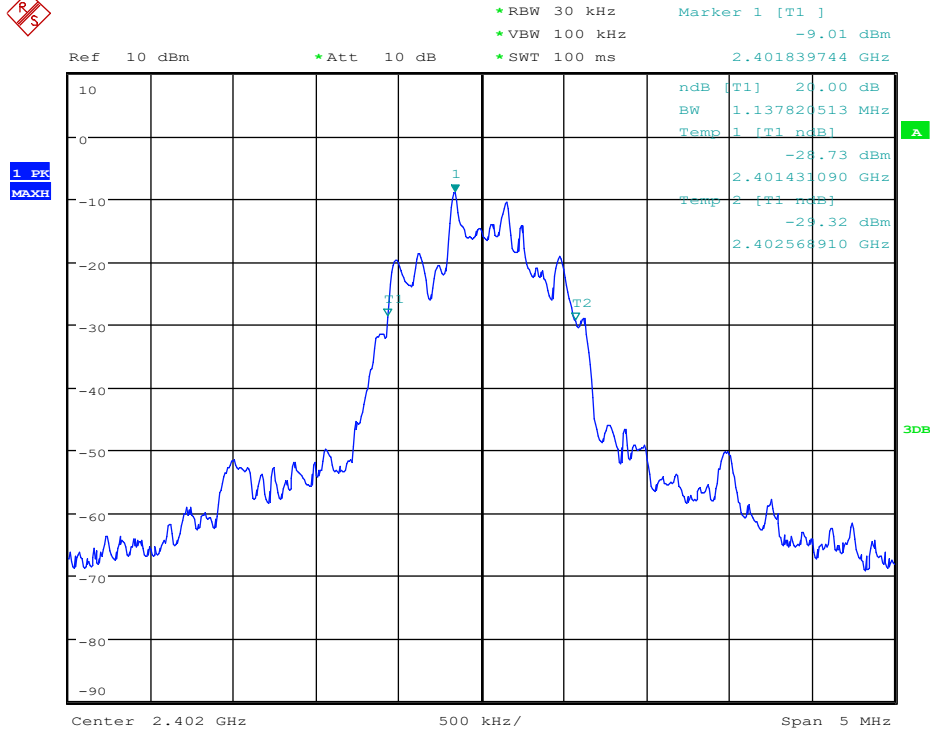



*RBW 30 kHz Marker 1 [T1]
*VBW 100 kHz -7.58 dBm
*SWT 100 ms 2.479831731 GHz

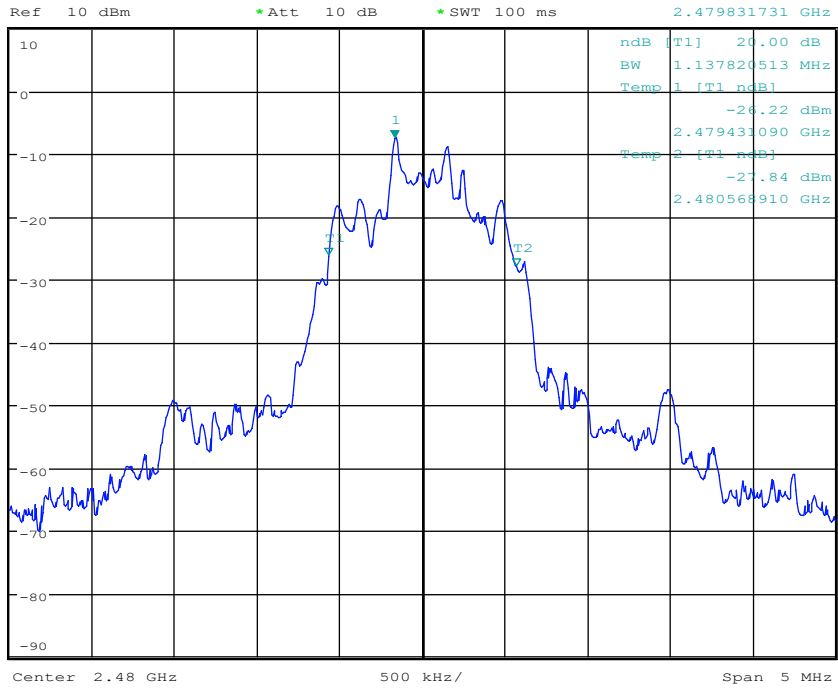

5. Carrier Frequency Separation

5.1. Block diagram of test setup

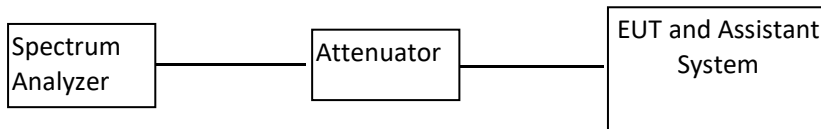

5.2. Limits

Frequency hopping systems shall have hopping channel carrier frequencies separated by a minimum of 25 kHz or the 20 dB bandwidth of the hopping channel, whichever is greater. Alternatively, frequency hopping systems operating in the 2400-2483.5 MHz band may have hopping channel carrier frequencies that are separated by 25 kHz or two-thirds of the 20 dB bandwidth of the hopping channel, whichever is greater, provided the systems operate with an output power no greater than 125 mW.

5.3. Test Procedure

- (1) Configure EUT and assistant system according clause 2.4 and 5.2
- (2) Connect EUT's antenna output to spectrum analyzer by RF cable and through a 10dB attenuator.
- (3) Configure EUT work in test mode as stated in clause 2.4.
- (4) The carrier frequency was measured by spectrum analyzer with 30kHz RBW and 100kHz VBW.

5.4. Test Result

EUT: Amplifier Speaker		M/N: Party System Drum		
Mode	Channel separation (MHz)	20dB Bandwidth (MHz)	Limit (MHz) 2/3 of 20dB bandwidth	Conclusion
GFSK	1.0	0.729	0.486	PASS
8-DPSK	1.0	1.138	0.759	PASS

5.5. Original test data

GFSK

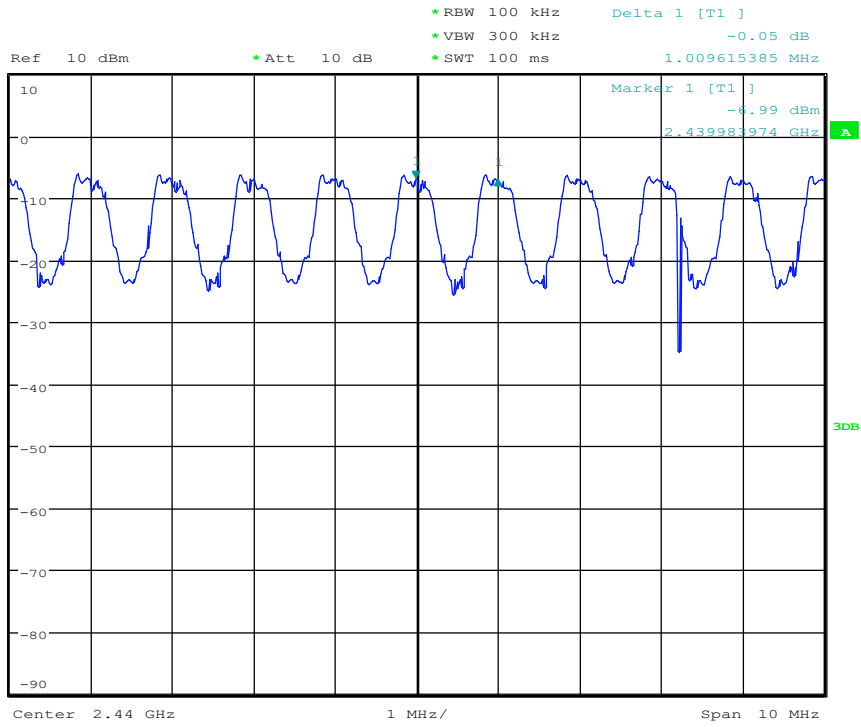

8-DPSK

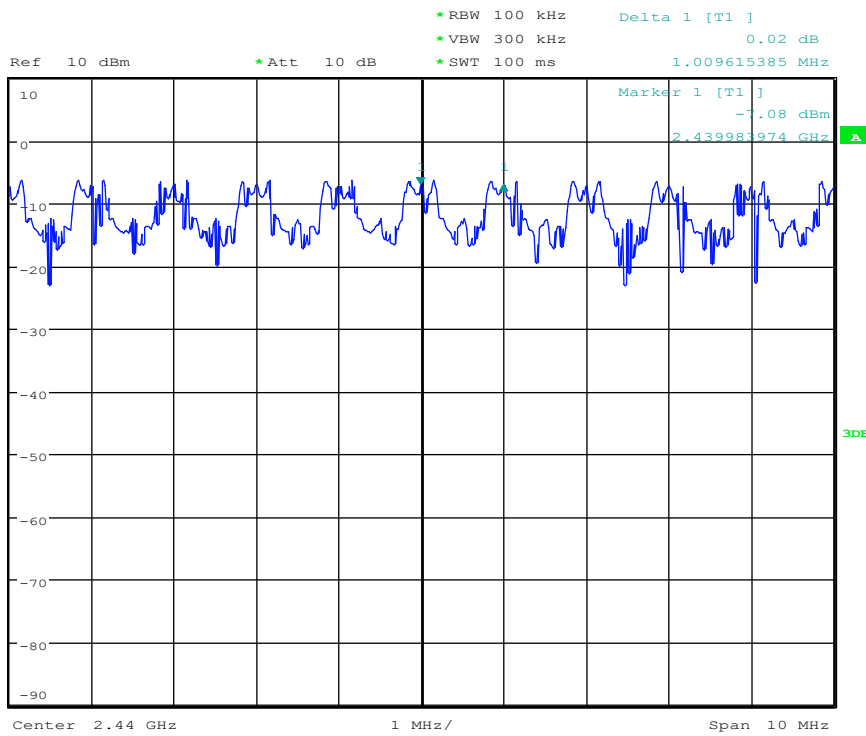



6. Number Of Hopping Channel

6.1. Test Requirement

Test Requirement : FCC CFR47 Part 15 Section 15.247
 Test Method : ANSI C63.10:2013
 Test Limit : Regulation 15.247 (a)(1)(iii) Frequency hopping systems in the 2400-2483.5 MHz band shall use at least 15 channels.
 Test Mode : Hopping

6.2. Block diagram of test setup

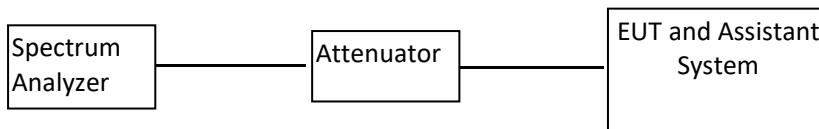

6.3. Limits

Frequency hopping systems in the 2400-2483.5 MHz band shall use at least 15 channels.

6.4. Test Procedure

- (1) Configure EUT and assistant system according clause 2.4 and 6.2
- (2) Connect EUT's antenna output to spectrum analyzer by RF cable and through a 10dB attenuator.
- (3) Configure EUT work in test mode as stated in clause 2.4.
- (4) The number of hopping channel was measured by spectrum analyzer with 300 kHz RBW and 1MHz VBW.

6.5. Test Result

EUT: Amplifier Speaker		M/N: Party System Drum	
Mode	Number of hopping channel	Limit	Conclusion
GFSK	79	>15	PASS
8-DPSK	79	>15	PASS



6.6. Original test data

GFSK:

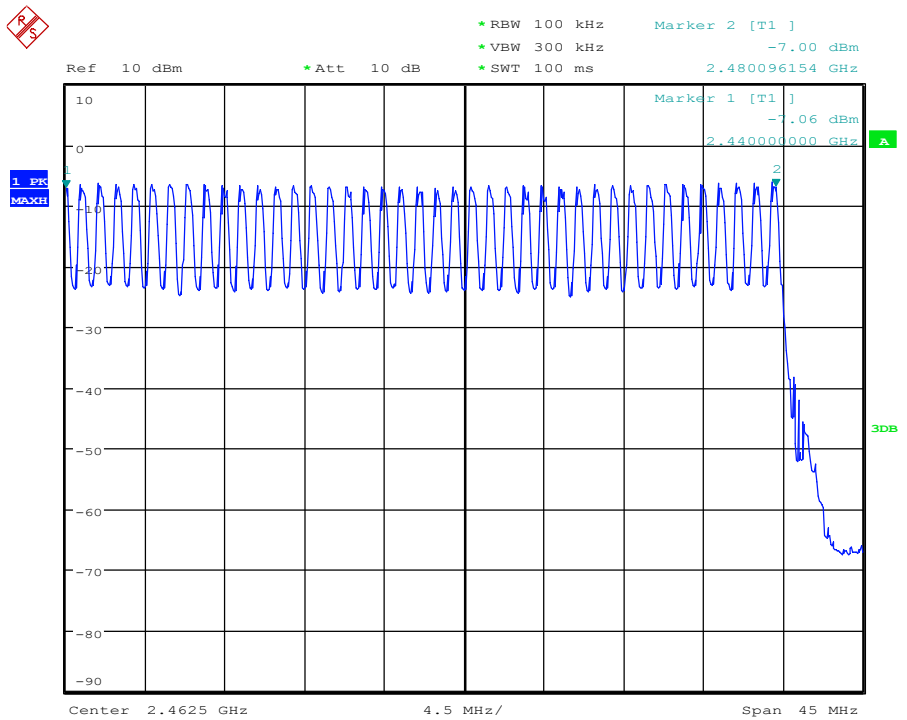
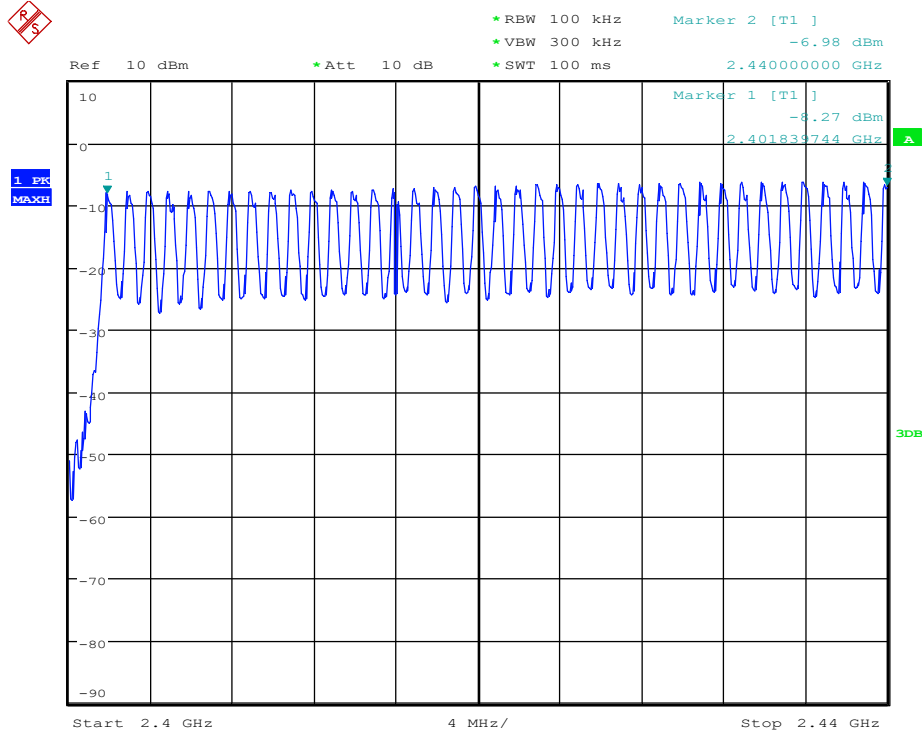



8-DPSK:

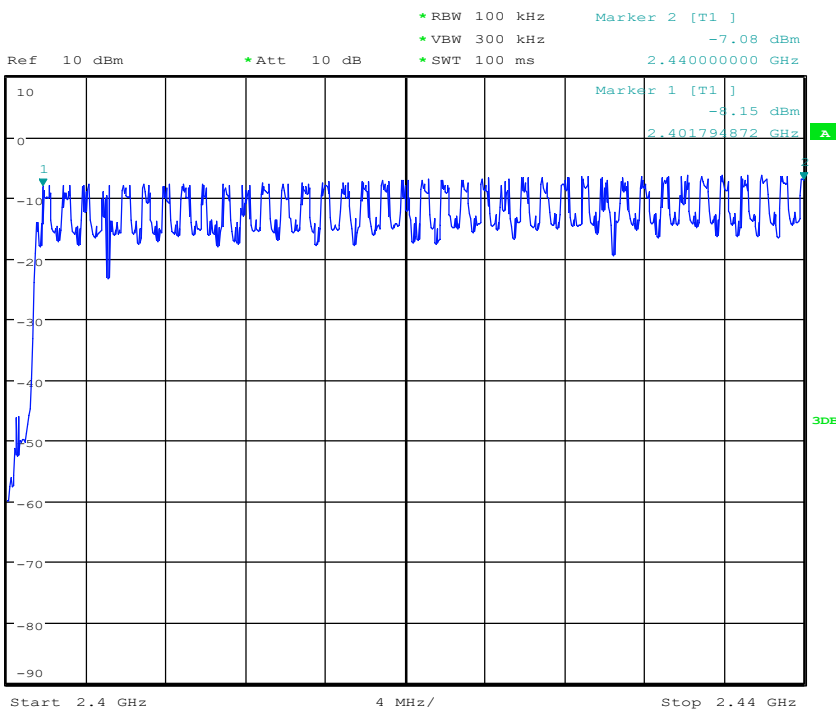
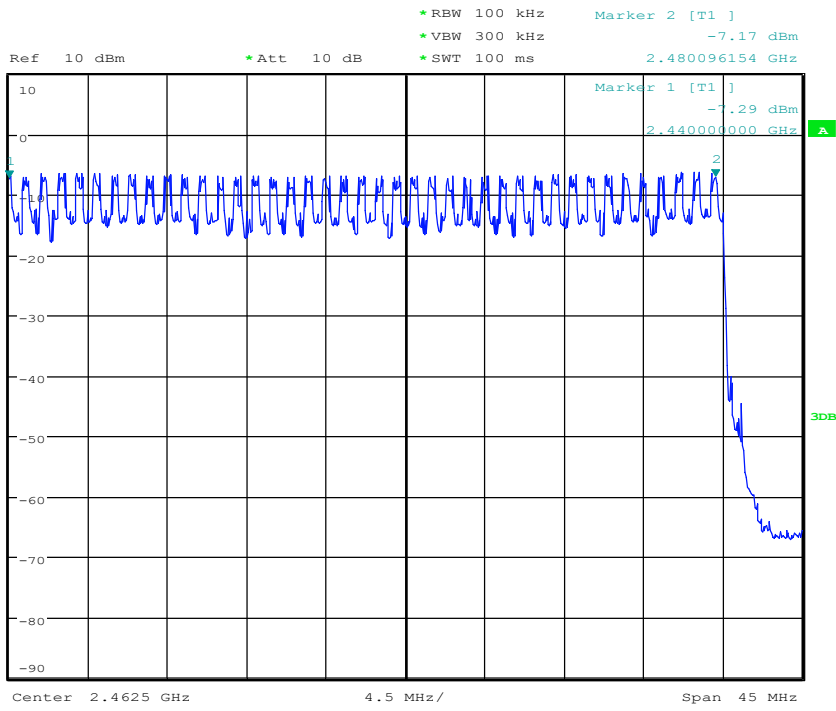



7. Dwell Time

7.1. Test Requirement

Test Requirement	: FCC CFR47 Part 15 Section 15.247
Test Method	: ANSI C63.10:2013
Test Limit	: Regulation 15.247(a)(1)(iii) Frequency hopping systems in the 2400-2483.5 MHz band shall use at least 15 channels. The average time of occupancy on any channel shall not be greater than 0.4 seconds within a period of 0.4 seconds multiplied by the number of hopping channels employed.
Test Mode	: The test data was recorded

7.2. Block diagram of test setup

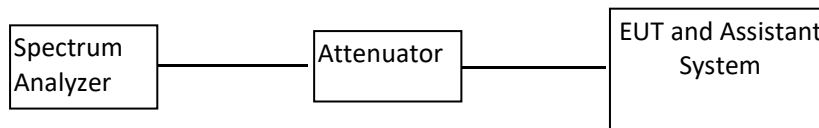

7.3. Limits

The average time of occupancy on any channel shall not be greater than 0.4 seconds within a period of 0.4 seconds multiplied by the number of hopping channels employed.

7.4. Test Procedure

- (1) Connect EUT's antenna output to spectrum analyzer by RF cable.
- (2) Measure the hopping number and on time of each pulse with spectrum analyzer in zero span set, and calculate dwell time with formula $\text{Dwell time} = \text{total hops} * \text{pulse's on time}$.

DH1 Packet permit maximum $1600 / 79 / 2 = 10.12$ hops per second in each channel (1 time slot RX, 1 time slot TX). So, total hops is $10.12 \times 31.6 = 320$.

DH3 Packet permit maximum $1600 / 79 / 4 = 5.06$ hops per second in each channel (3 time slots RX, 1 time slot TX). So, total hops is $5.06 \times 31.6 = 160$.

DH5 Packet permit maximum $1600 / 79 / 6 = 3.37$ hops per second in each channel (5 time slots RX, 1 time slot TX). So, total hops is $3.37 \times 31.6 = 106.6$.

3DH1 Packet permit maximum $1600 / 79 / 2 = 10.12$ hops per second in each channel (1 time slot RX, 1 time slot TX). So, total hops is $10.12 \times 31.6 = 320$.

3DH3 Packet permit maximum $1600 / 79 / 4 = 5.06$ hops per second in each channel (3 time slots RX, 1 time slot TX). So, total hops is $5.06 \times 31.6 = 160$.

3DH5 Packet permit maximum $1600 / 79 / 6 = 3.37$ hops per second in each channel (5 time slots RX, 1



time slot TX). So, total hops is $3.37 \times 31.6 = 106.6$.

7.5. Test Result

Mode	Pulse's on time (ms)	Total hops	Dwell time (s)	Limit	Conclusion
DH1	0.41	320	0.131	<400ms	PASS
DH3	1.67	160	0.267	<400ms	PASS
DH5	2.93	106.6	0.312	<400ms	PASS
3-DH1	0.43	320	0.138	<400ms	PASS
3-DH3	1.68	160	0.269	<400ms	PASS
3-DH5	2.39	106.6	0.255	<400ms	PASS

Note: Dwell time = total hops *pulse's on time.

7.6. Original test data

DH1

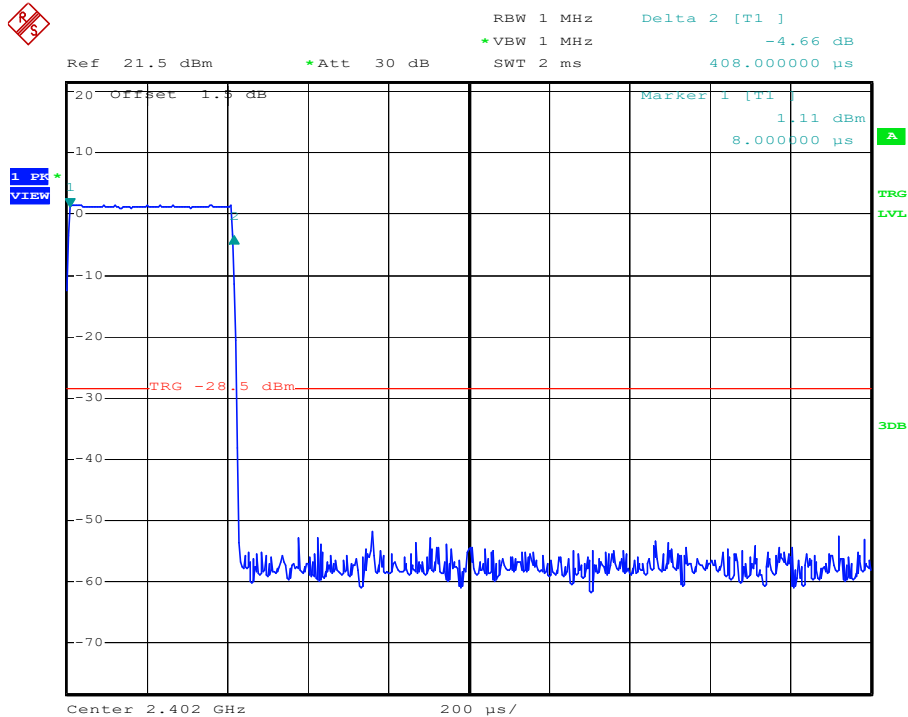

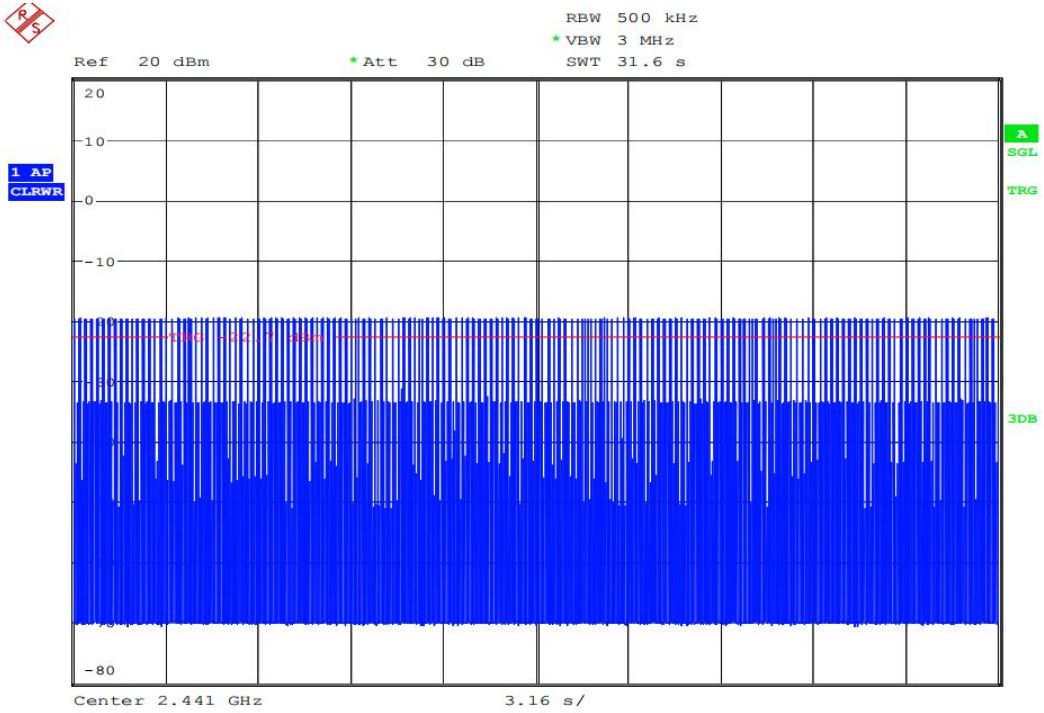

DH3

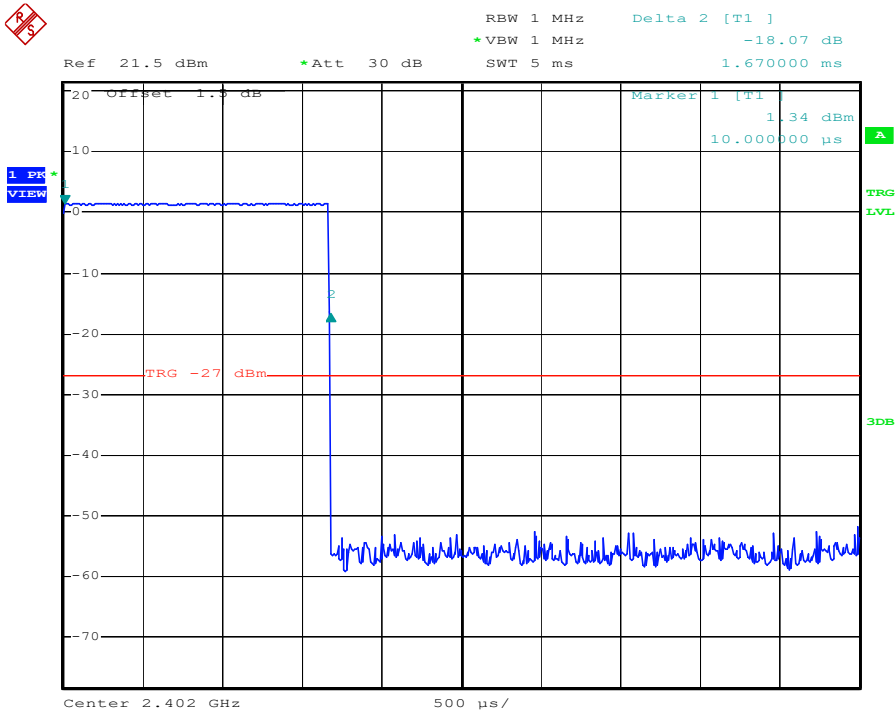

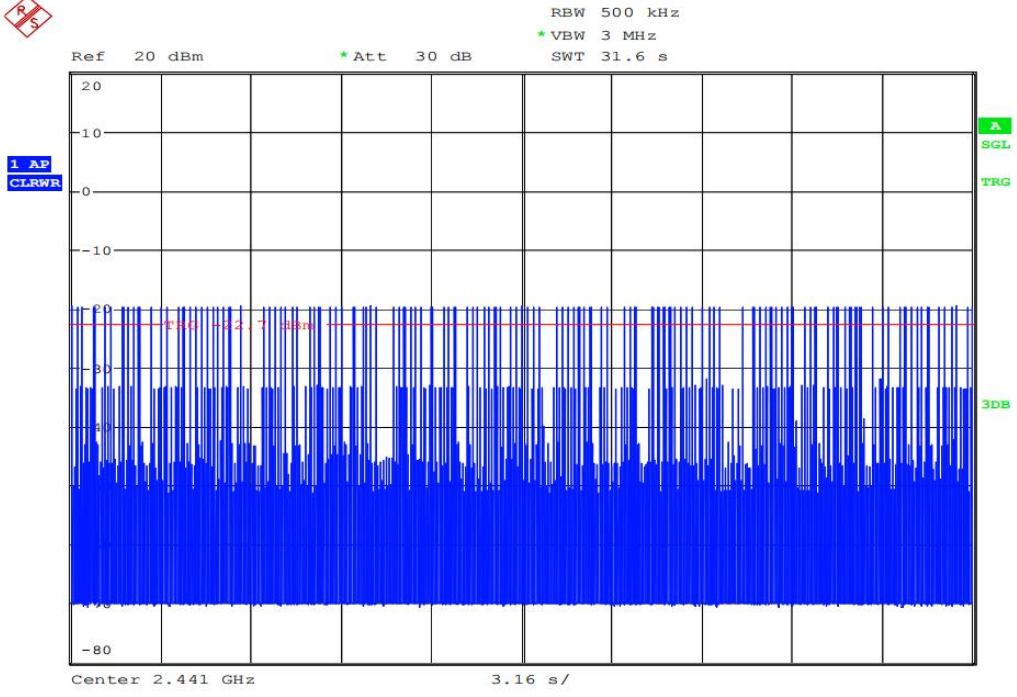

DH5

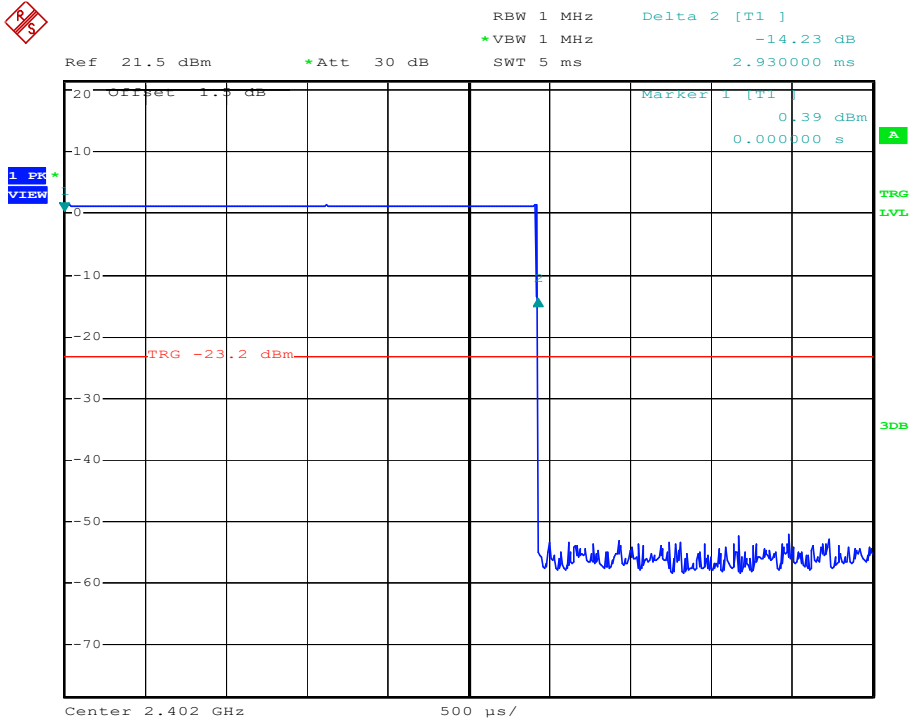

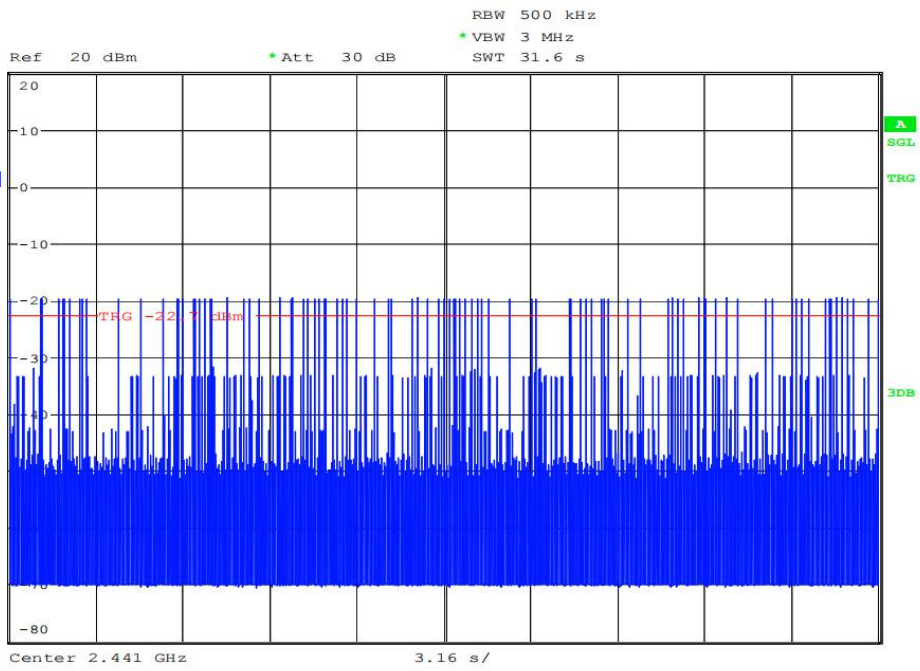

3-DH1

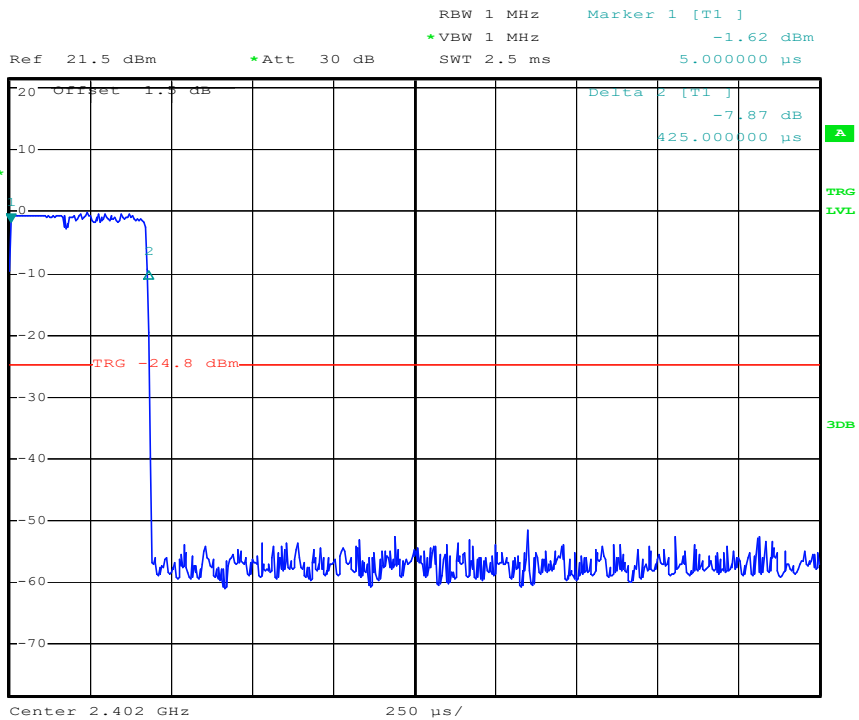

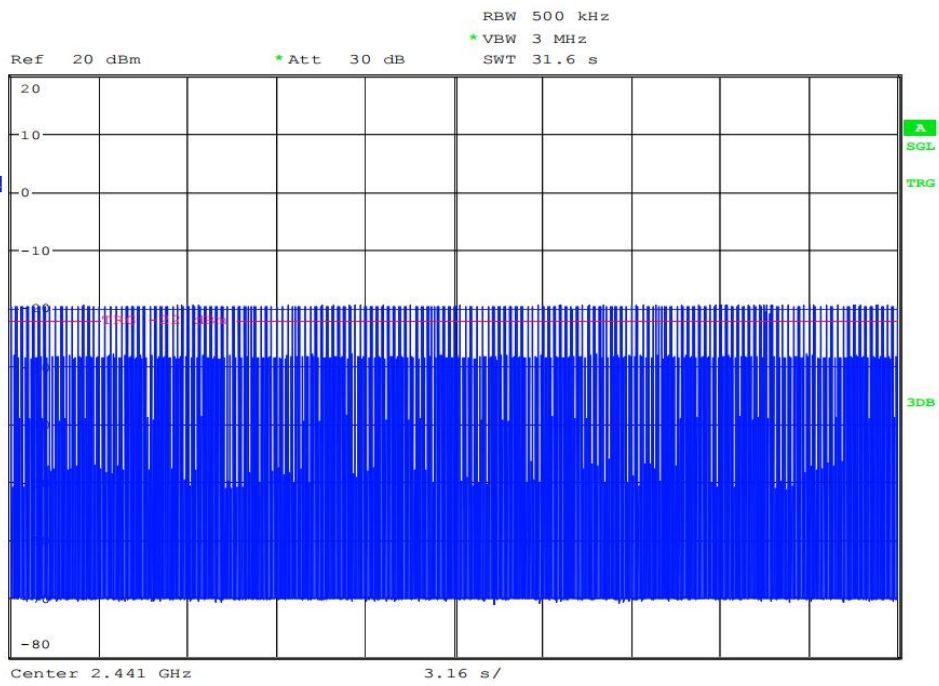

3-DH3

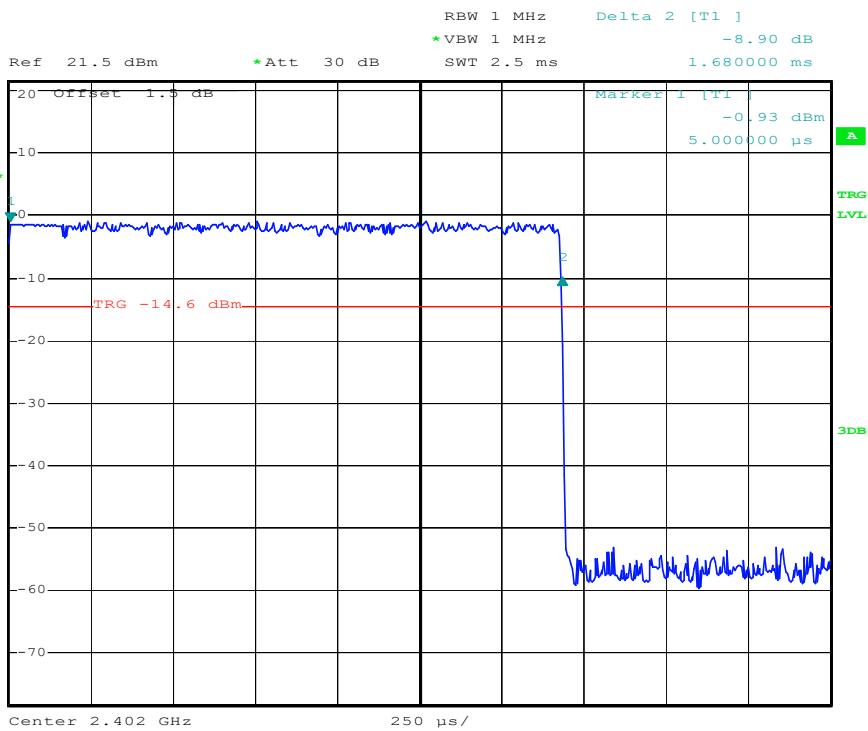

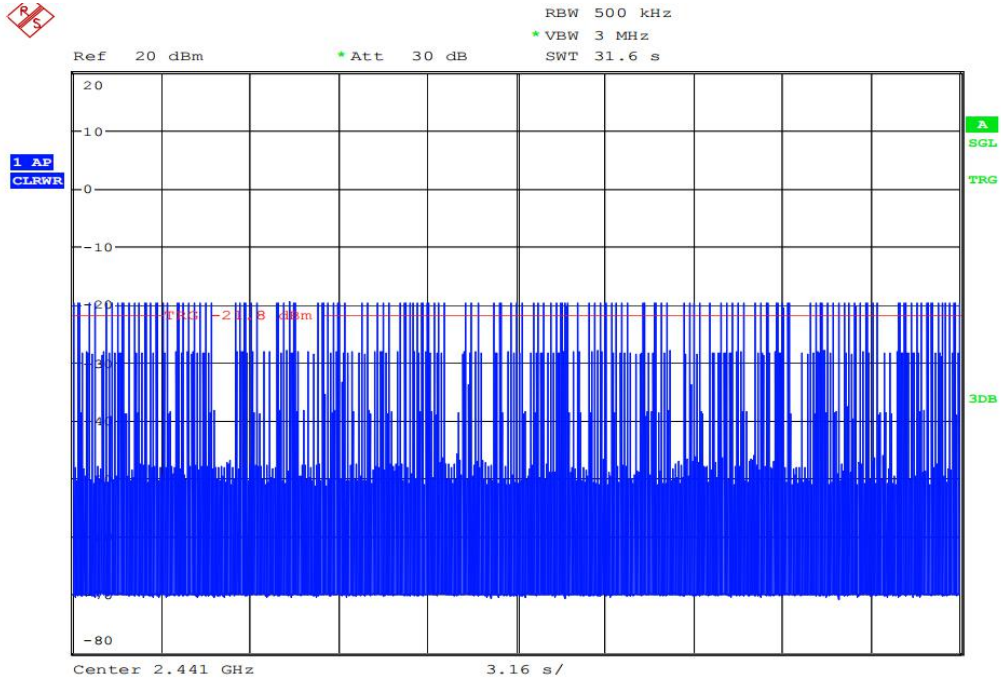

3-DH5

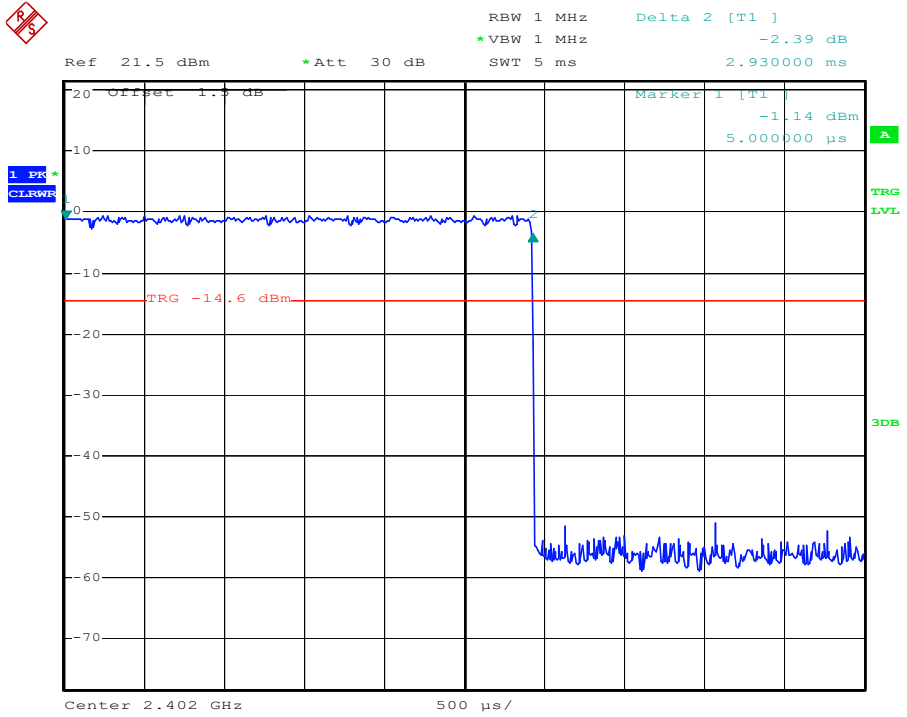



RBW 500 kHz
* VBW 3 MHz
SWT 31.6 s

Ref 20 dBm

* Att 30 dB

1 AP
CLRWR

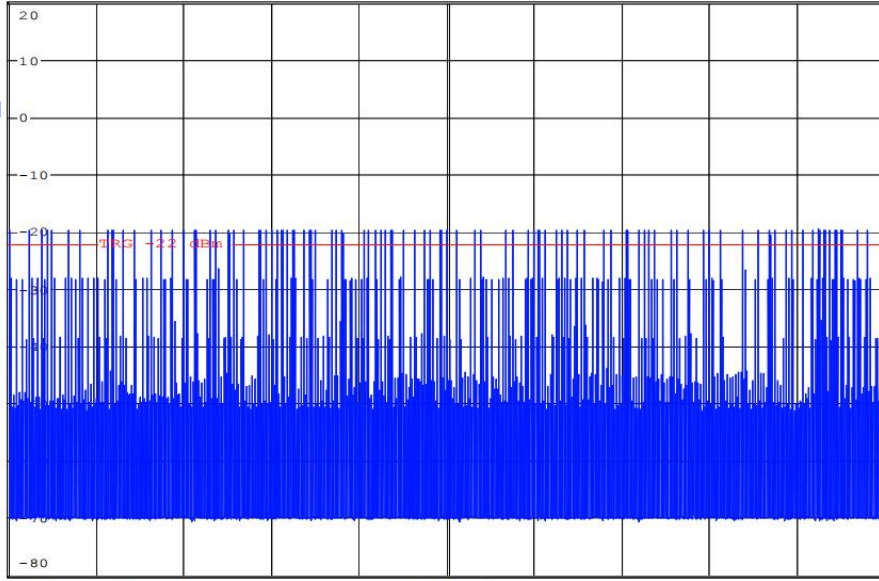

Center 2.441 GHz

3.16 s/

8. Radiated emission

8.1. Test Requirement

Test Requirement : FCC CFR47 Part 15 Section 15.209 & 15.247
 Test Method : ANSI C63.10:2013
 Test Result : PASS
 Measurement Distance : 3m
 Limit : See the follow table

Frequency (MHz)	Field Strength		Field Strength Limit at 3m Measurement Dist	
	uV/m	Distance (m)	uV/m	dBuV/m
0.009 ~ 0.490	$2400/F(\text{kHz})$	300	$10000 * 2400/F(\text{kHz})$	$20\log^{(2400/F(\text{kHz}))} + 80$
0.490 ~ 1.705	$24000/F(\text{kHz})$	30	$100 * 24000/F(\text{kHz})$	$20\log^{(24000/F(\text{kHz}))} + 40$
1.705 ~ 30	30	30	$100 * 30$	$20\log^{(30)} + 40$
30 ~ 88	100	3	100	$20\log^{(100)}$
88 ~ 216	150	3	150	$20\log^{(150)}$
216 ~ 960	200	3	200	$20\log^{(200)}$
Above 960	500	3	500	$20\log^{(500)}$

8.2. Test setup and procedure

The radiated emission tests were performed in the 3m Semi- Anechoic Chamber test site
 The test setup for emission measurement below 30MHz.

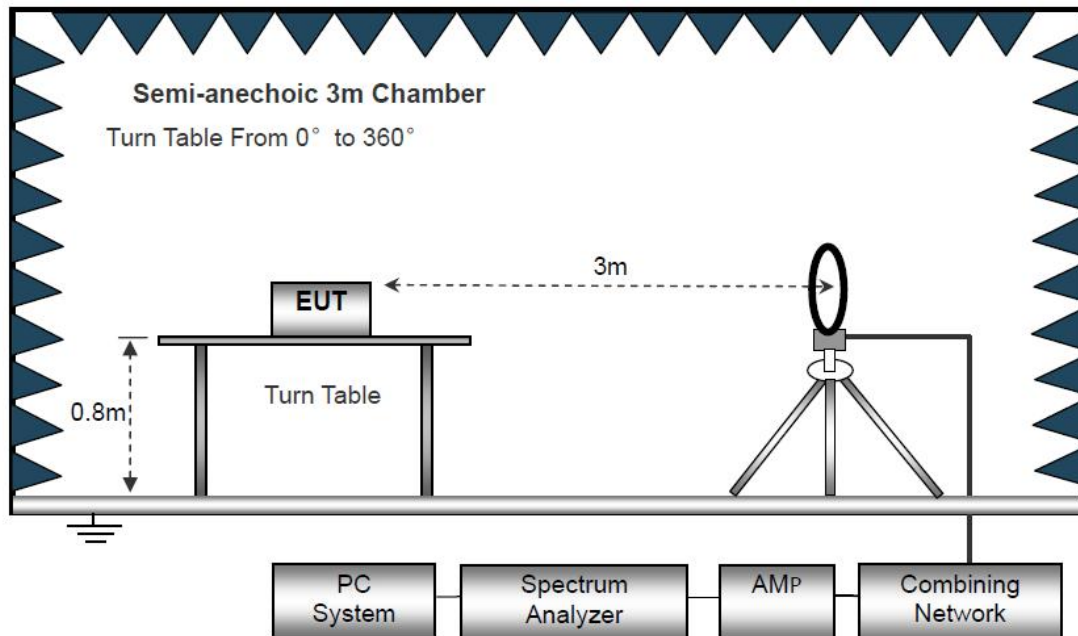

The test setup for emission measurement from 30 MHz to 1 GHz.

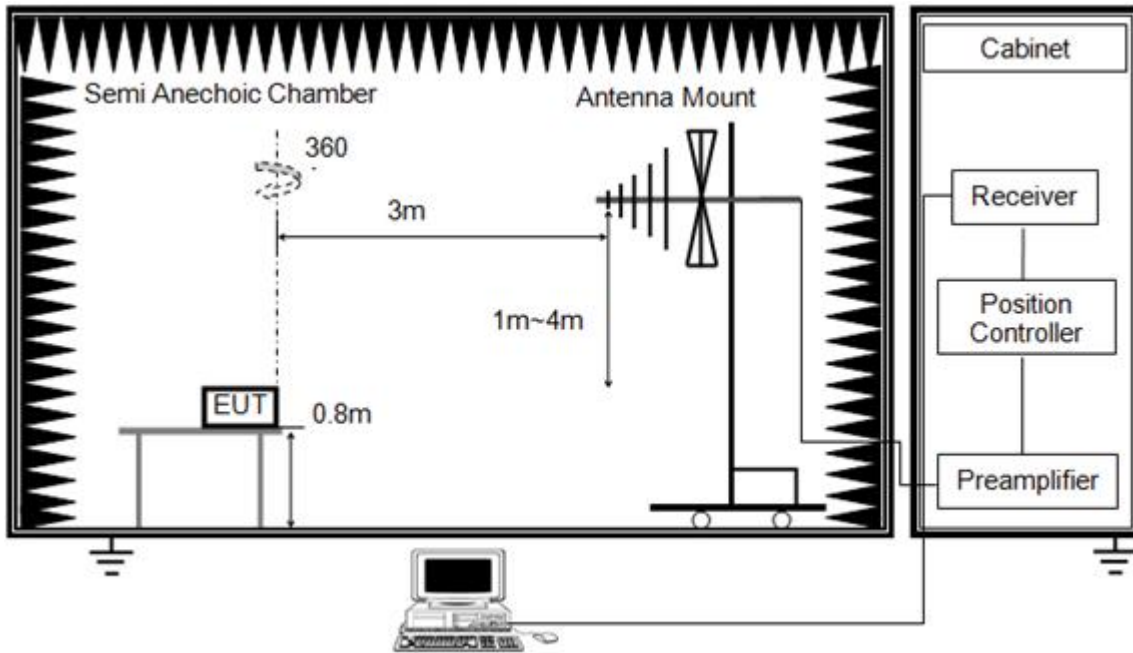

The test setup for emission measurement above 1 GHz.

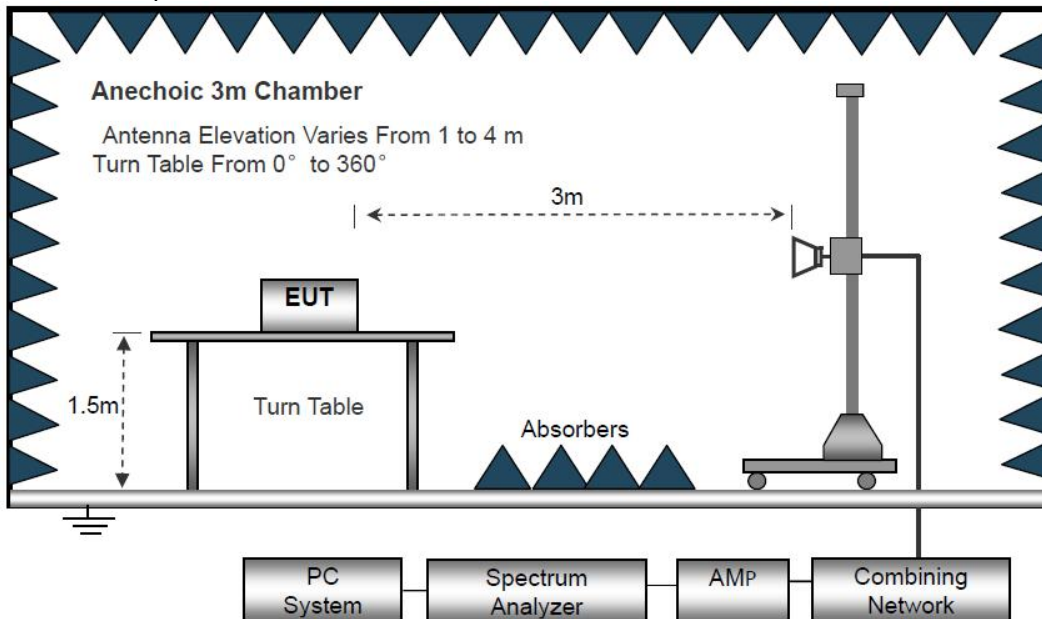

The setting of the spectrum analyser

Spectrum Parameter	Setting
Attenuation	Auto
Start Frequency	1000 MHz
Stop Frequency	10th carrier harmonic
RB / VB (emission in restricted band)	1 MHz / 1 MHz for Peak, 1 MHz / 10Hz for Average



Receiver Parameter	Setting
Attenuation	Auto
Start ~ Stop Frequency	9kHz~150kHz / RB 200Hz for QP
Start ~ Stop Frequency	150kHz~30MHz / RB 9kHz for QP
Start ~ Stop Frequency	30MHz~1000MHz / RB 120kHz for QP

1. The testing follows the guidelines in ANSI C63.10-2013.
2. The EUT was arranged to its worst case and then tune the antenna tower (from 1 m to 4 m) and turntable (from 0 degree to 360 degrees) to find the maximum reading. A pre-amp and a high pass filter are used for the test in order to get better signal level. Both horizontal and vertical polarizations of the antenna are set to make the measurement.
3. The EUT was placed on a turntable with 0.8 meter above ground.
4. The EUT was set 3 meters from the interference receiving antenna, which was mounted on the top of a variable height antenna tower.
5. Corrected Reading: Antenna Factor + Cable Loss + Read Level - Preamp Factor = Level
6. For measurement below 1GHz, the initial step in collecting conducted emission data is a spectrum analyzer peak detector mode pre-scanning the measurement frequency range. Significant peaks are then marked and then Quasi Peak detector mode re-measured. If the emission level of the EUT measured by the peak detector is 3 dB lower than the applicable limit, the peak emission level will be reported. Otherwise, the emission measurement will be repeated using the quasi-peak detector and reported.
7. For the actual test configuration, please refer to the related Item in this test report (Photographs of the Test Configuration)
- 8 For emissions below 1GHz, according explorer test, when change Tx mode and channel, have no distinct influence on emissions level, so for emissions below 1GHz, the final test was only performed with EUT working in GFSK, Tx 2441MHz mode.

ABOVE 1G

1. The testing follows the guidelines in ANSI C63.10-2013.
2. The EUT was arranged to its worst case and then tune the antenna tower (1.5 m) and turntable (from 0 degree to 360 degrees) to find the maximum reading. A pre-amp and a high pass filter are used for the test in order to get better signal level. Both horizontal and vertical polarizations of the antenna are set to make the measurement.
3. The EUT was placed on a turntable with 1.5 meter above ground.
4. The EUT was set 3 meters from the interference receiving antenna, which was mounted on the top of a variable height antenna tower.
5. Corrected Reading: Antenna Factor + Cable Loss + Read Level - Preamp Factor = Level
6. For measurement above 1GHz, the emission measurement will be measured by the peak detector and the AV detector.



7. For emissions above 1GHz, both Peak and Average level were measured with Spectrum Analyzer, and the RBW is set at 1MHz, VBW is set at 3MHz for Peak measure; RBW is set at 1MHz, VBW is set at 10Hz for Average measure.

8. According exploratory test no any obvious emission were detected from 9KHz to 30MHz and 18GHz to 25GHz, so the final test was performed with frequency range from 30MHz to 18GHz and recorded in below.

8.3. Limit

8.3.1 Please refer to FCC §15.205 and §15.209

Please refer to FCC §15.247 (a)(d)(e)

The field strength of emissions from intentional radiators operated within these frequency bands			
Frequency (MHz)	Field strength of Fundamental	Field strength of Harmonics	Distance (m)
902 - 928	50 mV/m (94dBuV/m)	500 uV/m (54dBuV/m)	3
2400 – 2483.5	50 mV/m (94dBuV/m)	500 uV/m (54dBuV/m)	3
5725 – 5875	50 mV/m (94dBuV/m)	500 uV/m (54dBuV/m)	3

Emissions radiated outside of the specified frequency bands			
Frequency Range (MHz)	Field Strength Limit (uV/m) at 3 m	Field Strength Limit (dBuV/m) at 3 m	
		Quasi-Peak	
30 - 88	100	40	
88 - 216	150	43.5	
216 - 960	200	46	
Above 960	500	54	
Above 1000	500	Peak	Average
		74	54

8.4. Test Data

Environmental Conditions

Temperature:	26 °C
Relative Humidity:	55 %
ATM Pressure:	101.0 kPa



Test Result: Compliant.

**SPURIOUS EMISSIONS BELOW 1 GHz
(TX mode, HORIZONTAL)**

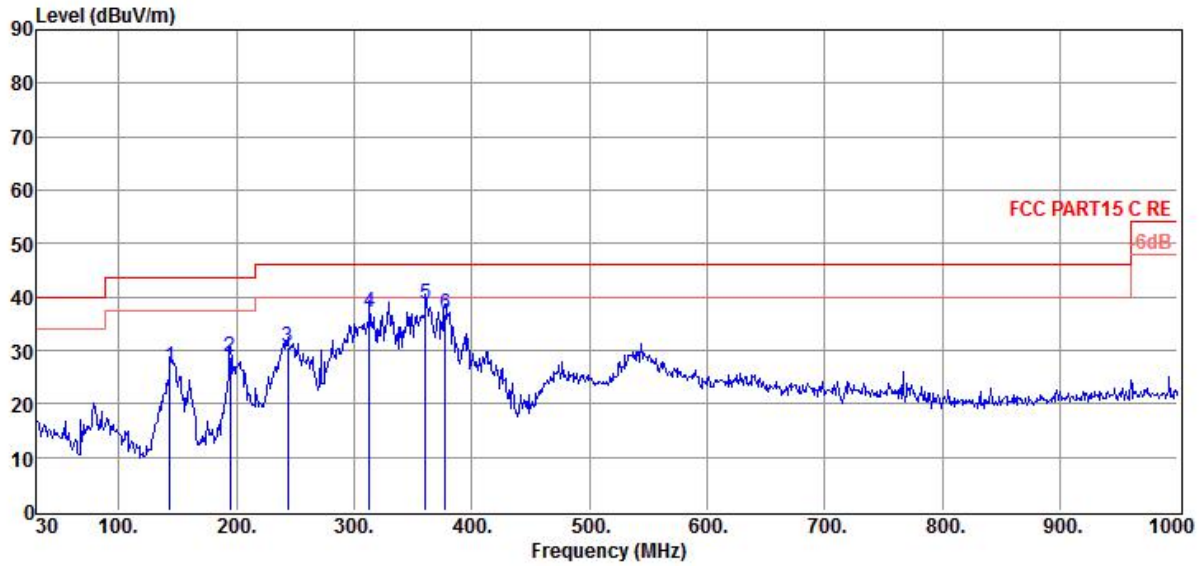

Item (Mark)	Freq (MHz)	Read Level (dBμV)	Antenna Factor (dB/m)	PRM Factor (dB)	Cable Loss (dB)	Result Level (dBμV/m)	Limit Line (dBμV/m)	Over Limit (dB)	Detector	Polarization
1	143.49	58.18	8.23	40.91	1.39	26.89	43.50	-16.61	QP	HORIZONTAL
2	194.90	57.94	10.57	41.49	1.74	28.76	43.50	-14.74	QP	HORIZONTAL
3	243.40	58.81	12.08	42.23	1.91	30.57	46.00	-15.43	QP	HORIZONTAL
4	313.24	64.05	13.28	42.40	2.23	37.16	46.00	-8.84	QP	HORIZONTAL
5	360.77	64.40	14.43	42.73	2.48	38.58	46.00	-7.42	QP	HORIZONTAL
6	377.26	62.36	14.59	42.73	2.54	36.76	46.00	-9.24	QP	HORIZONTAL

- Note: 1. Result Level = Read Level + Antenna Factor + Cable loss - PRM Factor
 2. If Peak Result comply with QP limit, QP Result is deemed to comply with QP limit



(TX mode, VERTICAL)

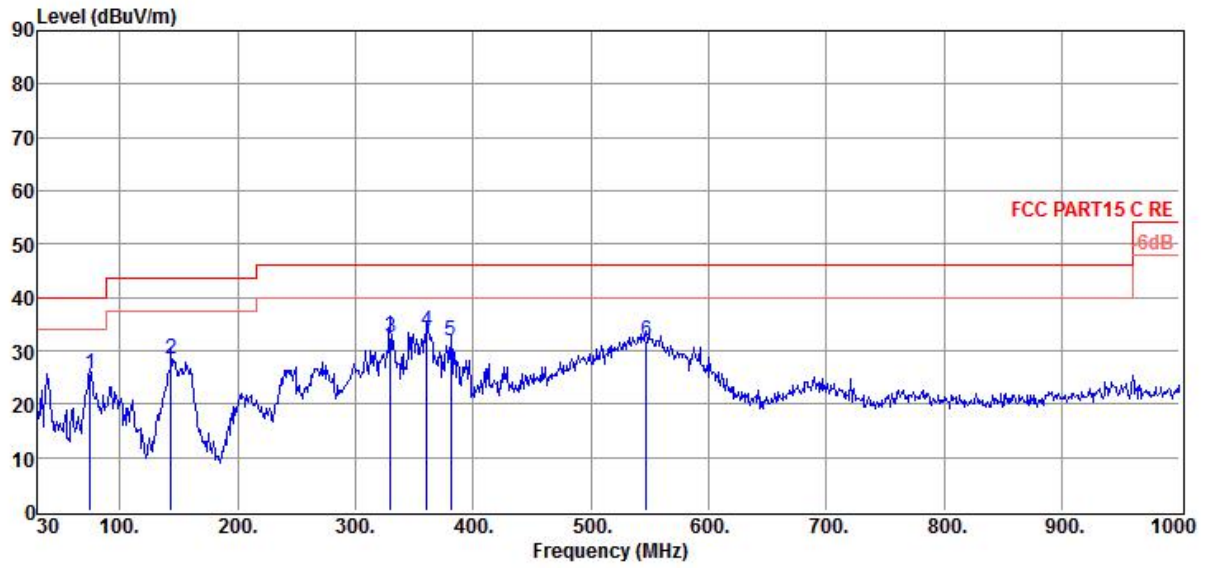

Item (Mark)	Freq (MHz)	Read Level (dBμV)	Antenna Factor (dB/m)	PRM Factor (dB)	Cable Loss (dB)	Result Level (dBμV/m)	Limit Line (dBμV/m)	Over Limit (dB)	Detector	Polarization
1	74.62	54.35	8.23	38.03	1.02	25.57	40.00	-14.43	QP	VERTICAL
2	143.49	59.69	8.23	40.91	1.39	28.40	43.50	-15.10	QP	VERTICAL
3	329.73	59.12	13.80	42.58	2.28	32.62	46.00	-13.38	QP	VERTICAL
4	360.77	59.51	14.43	42.73	2.48	33.69	46.00	-12.31	QP	VERTICAL
5	381.14	57.48	14.68	42.73	2.55	31.98	46.00	-14.02	QP	VERTICAL
6	547.01	54.42	17.44	43.10	3.10	31.86	46.00	-14.14	QP	VERTICAL

Note: 1. Result Level = Read Level + Antenna Factor + Cable loss - PRM Factor
 2. If Peak Result comply with QP limit, QP Result is deemed to comply with QP limit



SPURIOUS EMISSIONS (1~25GHz)

Freq (MHz)	Read Level (dBμV)	Antenna Factor (dB/m)	PRM Factor dB	Cable Loss dB	Result Level (dBμV/m)	Limit Line (dBμV/m)	Over Limit (dB)	Detector	Polarization
GFSK CH0 Tx Mode									
2402.00	98.03	28.93	43.49	6.47	89.94	74.00	15.94	Peak	VERTICAL
4804.00	49.99	34.01	44.06	9.32	49.26	74.00	-24.74	Peak	VERTICAL
17541.00	36.76	43.38	40.86	18.92	58.20	74.00	-15.80	Peak	VERTICAL
17541.00	26.67	43.38	40.86	18.92	48.11	54.00	-5.89	Average	VERTICAL
2402.00	100.55	28.93	43.49	6.47	92.46	74.00	18.46	Peak	HORIZONTAL
4808.00	53.85	34.01	44.06	9.32	53.12	74.00	-20.88	Peak	HORIZONTAL
17218.00	38.61	42.87	41.10	18.85	59.23	74.00	-14.77	Peak	HORIZONTAL
17218.00	25.89	42.87	41.10	18.85	46.51	54.00	-7.49	Average	HORIZONTAL
GFSK CH39 Tx Mode									
2440.00	98.02	29.03	43.49	6.53	90.09	74.00	16.09	Peak	VERTICAL
4880.00	51.57	34.29	44.03	9.41	51.24	74.00	-22.76	Peak	VERTICAL
17507.00	37.34	43.34	40.80	18.91	58.79	74.00	-15.21	Peak	VERTICAL
17507.00	28.26	43.34	40.80	18.91	49.71	54.00	-4.29	Average	VERTICAL
2440.00	101.26	29.03	43.49	6.53	93.33	74.00	19.33	Peak	HORIZONTAL
4880.00	53.13	34.29	44.03	9.41	52.80	74.00	-21.20	Peak	HORIZONTAL
17796.00	37.78	43.67	41.44	19.01	59.02	74.00	-14.98	Peak	HORIZONTAL
17796.00	27.36	43.67	41.44	19.01	48.60	54.00	-5.40	Average	HORIZONTAL
GFSK CH78 Tx Mode									
2480.00	104.19	29.18	43.50	6.57	96.44	74.00	22.44	Peak	HORIZONTAL
4960.00	60.58	34.34	44.01	9.48	60.39	74.00	-13.61	Peak	HORIZONTAL
4960.00	50.23	34.34	44.01	9.48	50.04	54.00	-3.96	Average	HORIZONTAL
17830.00	40.06	43.79	41.44	19.03	61.44	74.00	-12.56	Peak	HORIZONTAL
17830.00	28.19	43.79	41.44	19.03	49.57	54.00	-4.43	Average	HORIZONTAL
2480.00	98.37	29.18	43.50	6.57	90.62	74.00	16.62	Peak	VERTICAL
4960.00	48.67	34.34	44.01	9.48	48.48	74.00	-25.52	Peak	VERTICAL
17473.00	37.07	43.30	40.80	18.91	58.48	74.00	-15.52	Peak	VERTICAL
17473.00	28.95	43.30	40.80	18.91	50.36	54.00	-3.64	Average	VERTICAL

Note: 1.30MHz~18GHz: (Scan with GFSK CH0,39,78; π/4-DQPSK CH0,39,78; 8-DPSK CH0,39,78, the worst case is GFSK Tx Mode)

2. Result Level = Read Level + Antenna Factor + Cable loss - PRM Factor.

3. Test setup: RBW: 1 MHz, VBW: 3 MHz, Sweep time: auto.

Note2: According exploratory test no any obvious emission were detected from 9KHz to 30MHz and 18GHz to 25GHz, so the final test was performed with frequency range from 30MHz to 18GHz and recorded in below.

9. Band Edge Compliance

9.1. Test Requirement

According to FCC section 15.247(d), in any 100kHz bandwidth outside the frequency band in which the spread spectrum or digitally modulated intentional radiator is operating, the radio frequency power that is produced by the intentional radiator shall be at least 20dB below that in the 100kHz bandwidth within the band that contains the highest level of the desired power, based on either an RF conducted or a radiated measurement.

9.2. Block diagram of test setup

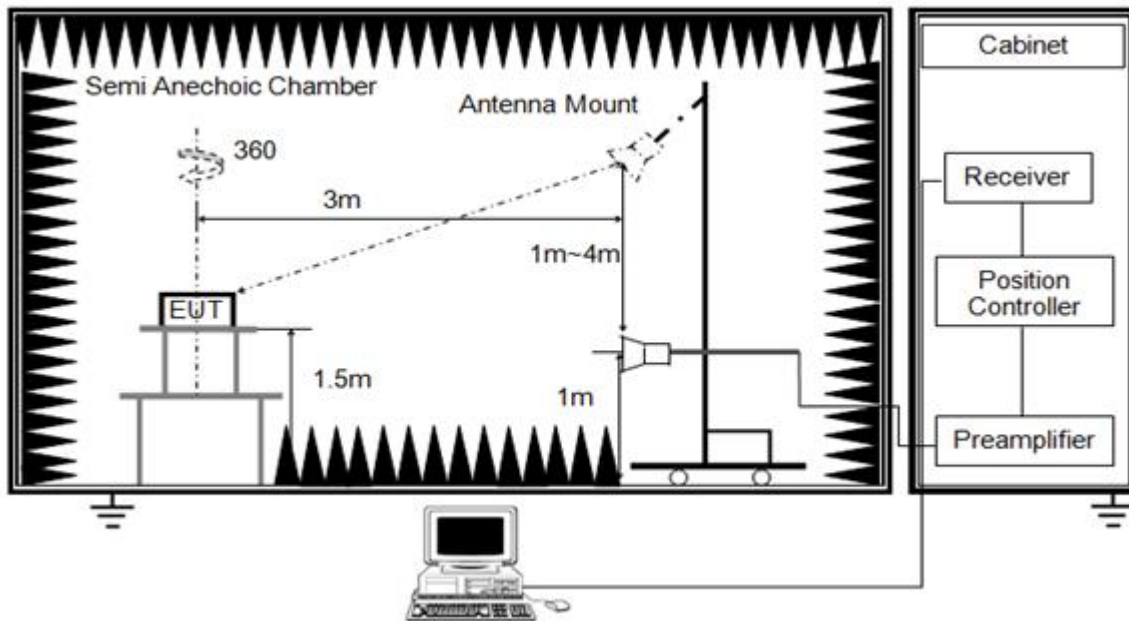

9.3. Limit

All the lower and upper band-edges emissions appearing within 2310MHz to 2390MHz and 2483.5MHz to 2500MHz restricted frequency bands shall not exceed the limits shown in 15.209, all the other emissions outside operation frequency band 2400MHz to 2483.5MHz and 5725MHz to 5850MHz shall be at least 20dB below the fundamental emissions, or comply with 15.209 limits.

9.4. Test Procedure

Same with clause 8.4 except change investigated frequency range from 2310MHz to 2415MHz and 2475MHz to 2500MHz.



Spectrum Parameter	Setting
Detector	Peak
Start/Stop Frequency	30 MHz to 10th carrier harmonic
RB / VB (emission in restricted band)	100 KHz/300 KHz
Trace-Mode:	Max hold

For Band edge

Spectrum Parameter	Setting
Detector	Peak
Start/Stop Frequency	Lower Band Edge: 2300 – 2403 MHz Upper Band Edge: 2479 – 2500 MHz
RB / VB (emission in restricted band)	100 KHz/300 KHz
Trace-Mode:	Max hold

9.5. Test Result and Data

Test Result: Compliant..

EUT: Amplifier Speaker		M/N: Party System Drum	
Mode	Freq (MHz)	Conclusion	
GFSK	Hopping off 2402	PASS	
	Hopping off 2480	PASS	
	Hopping on	PASS	
8-DPSK	Hopping off 2402	PASS	
	Hopping off 2480	PASS	
	Hopping on	PASS	

9.6. Original test data

Item (Mark)	Freq (MHz)	Read Level (dBμV)	Antenna Factor (dB/m)	PRM Factor (dB)	Cable Loss (dB)	Result Level (dBμV/m)	Limit Line (dBμV/m)	Over Limit (dB)	Detector	Polarization
GFSK CH0 Tx Mode										
1	2390.00	48.31	28.70	43.48	6.47	40.00	74.00	-34.00	Peak	HORIZONTAL
1	2390.00	49.33	28.70	43.48	6.47	41.02	74.00	-32.98	Peak	VERTICAL
GFSK CH78 Tx Mode										
1	2483.50	59.98	29.18	43.50	6.57	52.23	74.00	-21.77	Peak	HORIZONTAL
2	2492.05	54.66	29.18	43.50	6.57	46.91	74.00	-27.09	Peak	HORIZONTAL
1	2483.50	54.43	29.18	43.50	6.57	46.68	74.00	-27.32	Peak	VERTICAL
2	2494.13	51.32	29.18	43.50	6.59	43.59	74.00	-30.41	Peak	VERTICAL



Item (Mark)	Freq (MHz)	Read Level (dBμV)	Antenna Factor (dB/m)	PRM Factor dB	Cable Loss dB	Result Level (dBμV/m)	Limit Line (dBμV/m)	Over Limit (dB)	Detector	Polarization
8-DPSK CH 78 Tx										
1	2483.50	59.99	29.18	43.50	6.57	52.24	74.00	-21.76	Peak	HORIZONTAL
1	2483.50	54.72	29.18	43.50	6.57	46.97	74.00	-27.03	Peak	VERTICAL
8-DPSK CH 0 Tx										
1	2390.00	48.49	28.70	43.48	6.47	40.18	74.00	-33.82	Peak	VERTICAL
1	2390.00	48.94	28.70	43.48	6.47	40.63	74.00	-33.37	Peak	HORIZONTAL

10. Band Edge Compliance (conducted method)

10.1. Test Requirement

According to FCC section 15.247(d), in any 100kHz bandwidth outside the frequency band in which the spread spectrum or digitally modulated intentional radiator is operating, the radio frequency power that is produced by the intentional radiator shall be at least 20dB below that in the 100kHz bandwidth within the band that contains the highest level of the desired power, based on either an RF conducted or a radiated measurement

10.2. Block diagram of test setup

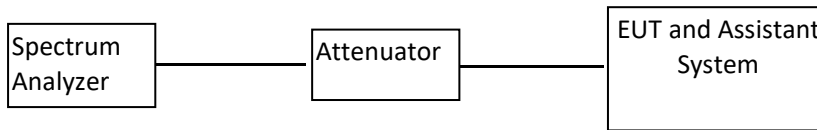

- 1.The transmitter output is connected to a spectrum analyzer. The resolution bandwidth is set to 100KHz. The video bandwidth is set to 300KHz.
- 2.The spectrum from 30MHz to 26 GHz is investigated with the transmitter set to the lowest, middle, and highest channels.
- 3.The EUT tested system was configured as the statements of 2.4 Unless otherwise a special operating condition is specified in the follows during the testing.

10.3. Limit

All restriction band should comply with 15.209, other emission should be at least 20dB blow the fundamental.

10.4. Test result

Mode	Freq (MHz)	Conclusion
GFSK	Hopping off 2402	PASS
	Hopping off 2480	PASS
	Hopping on	PASS
8-DPSK	Hopping off 2402	PASS
	Hopping off 2480	PASS
	Hopping on	PASS

10.5. Original test data

GFSK



*RBW 100 kHz Marker 2 [T1]
*VBW 300 kHz -40.66 dBm
SWT 5 ms 2.400000000 GHz

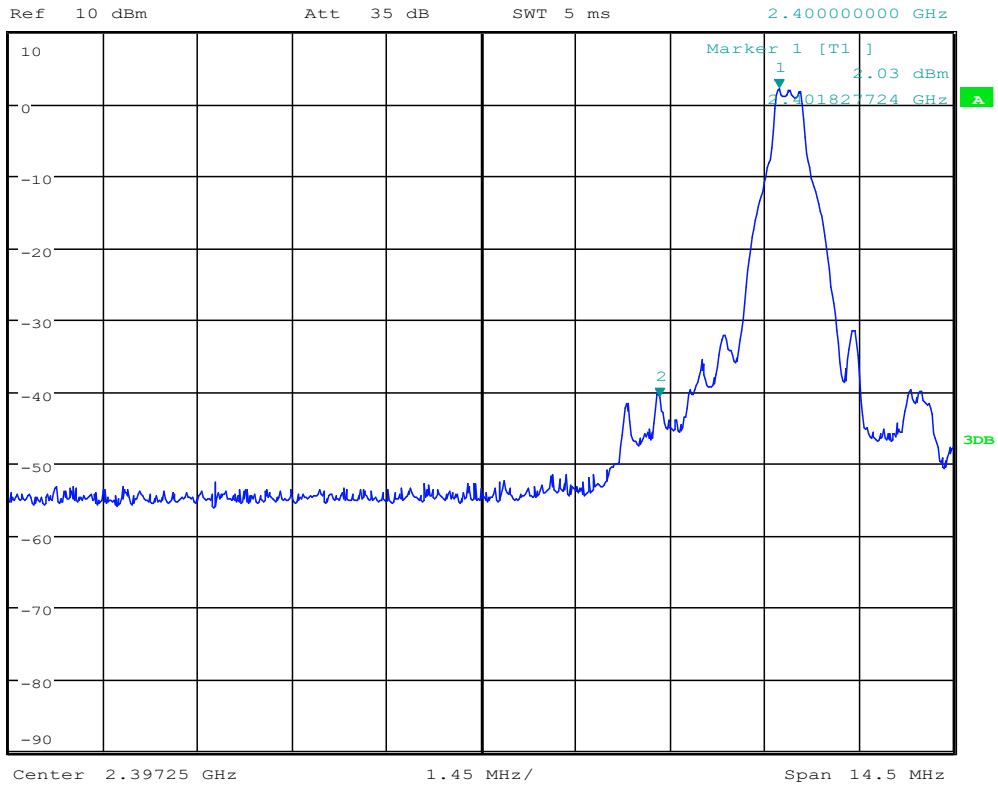

*RBW 100 kHz Marker 1 [T1]
*VBW 300 kHz 1.03 dBm
SWT 10 ms 2.479975962 GHz

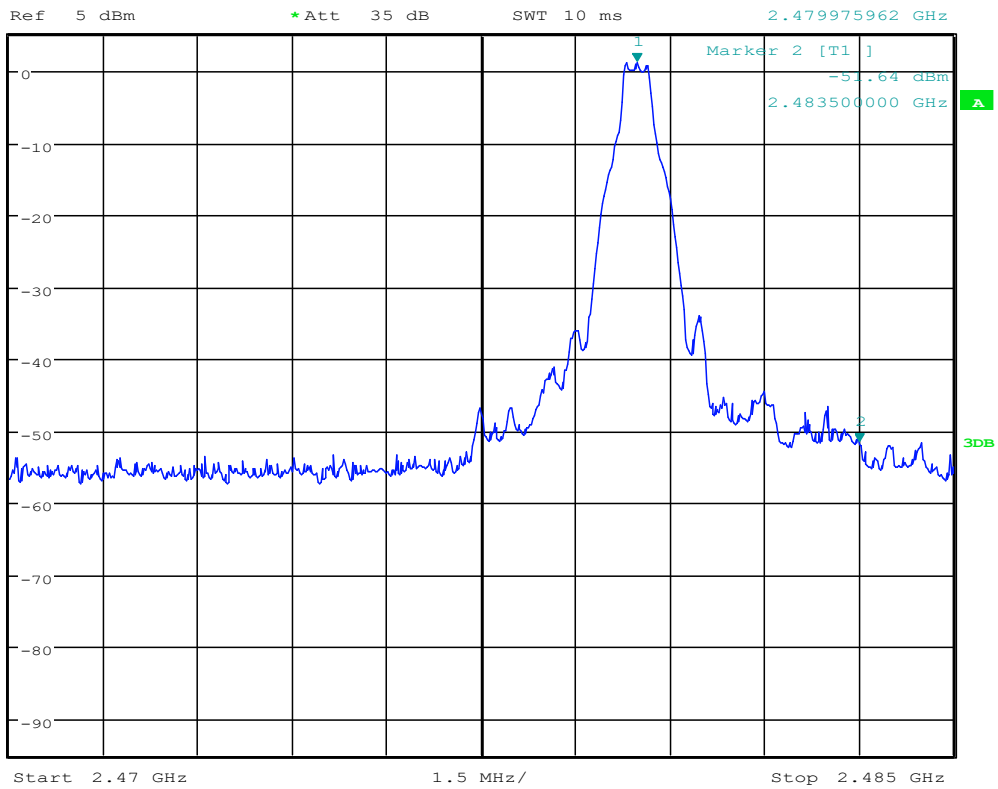

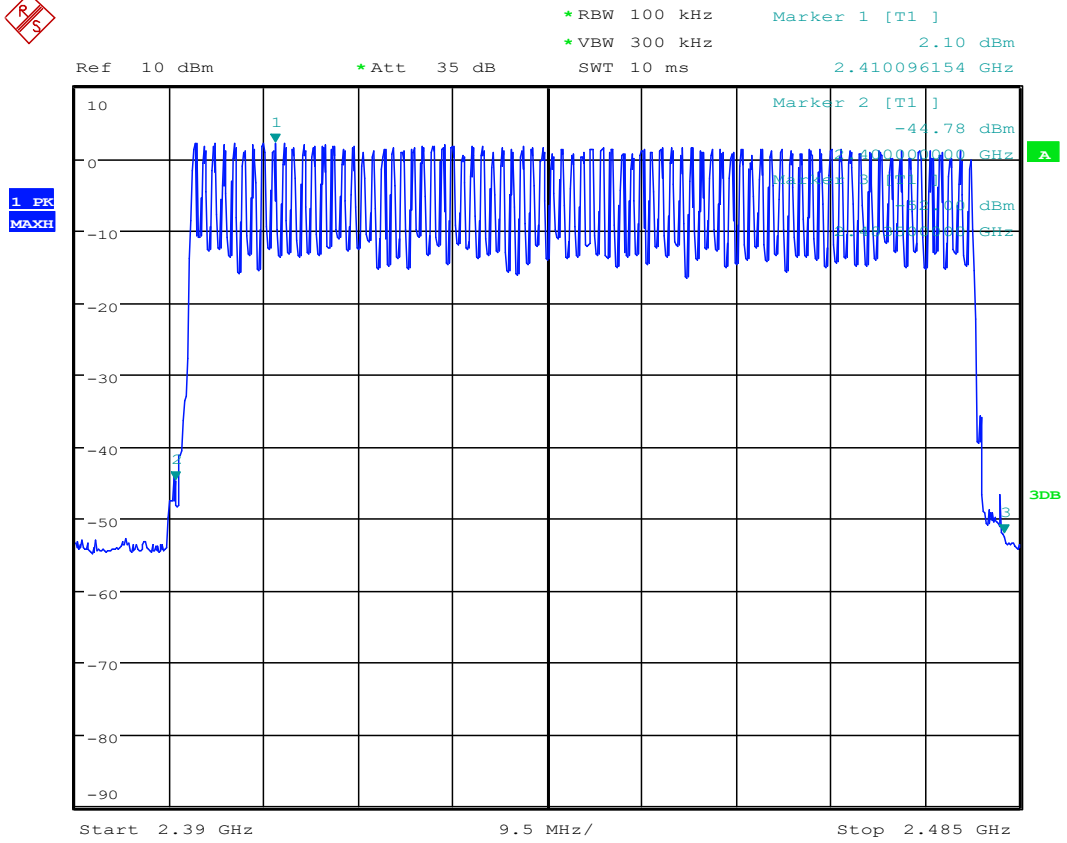

8-DPSK



*RBW 100 kHz Marker 1 [T1]
 *VBW 300 kHz 1.07 dBm
 Ref 10 dBm *Att 35 dB SWT 10 ms 2.401987179 GHz

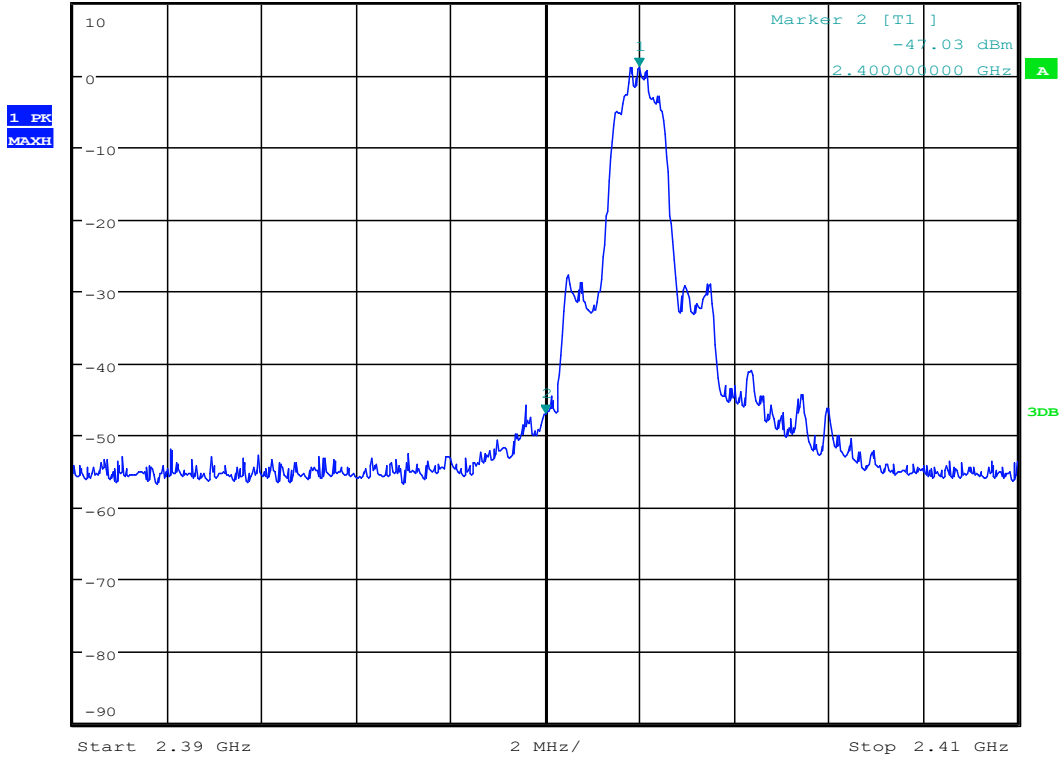

*RBW 100 kHz Marker 2 [T1]
 *VBW 300 kHz -48.41 dBm
 Ref 10 dBm *Att 35 dB SWT 10 ms 2.483500000 GHz

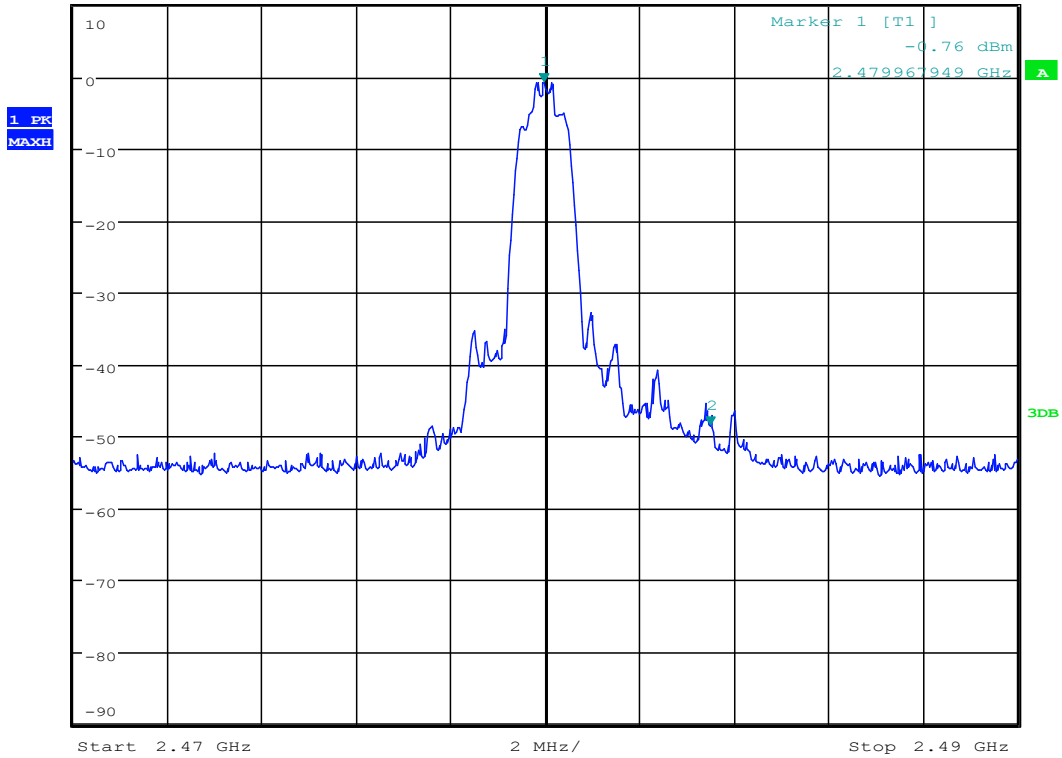



*RBW 100 kHz Marker 1 [T1]
*VBW 300 kHz 0.99 dBm
SWT 10 ms 2.402940705 GHz

Ref 10 dBm *Att 35 dB

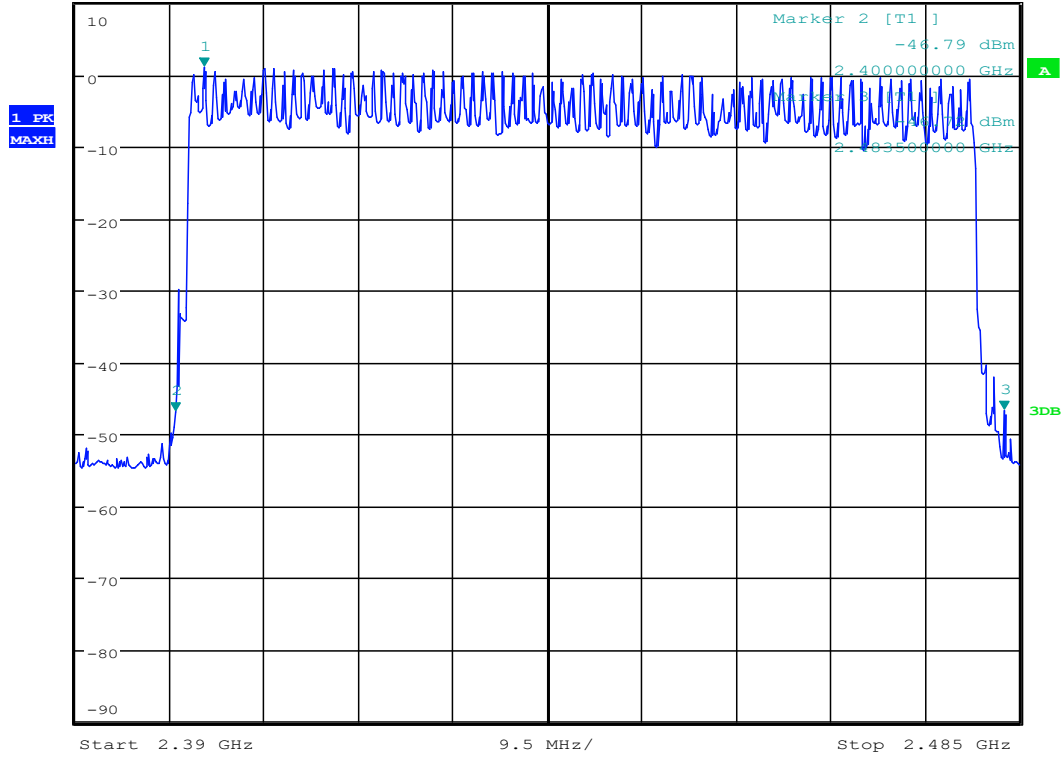

11. Power Line Conducted Emission

11.1. Test equipment

Test Requirement:	:	FCC CFR 47 Part 15 Section 15.207
Test Method:	:	ANSI C63.10:2013
Test Result:	:	PASS
Frequency Range:	:	150kHz to 30MHz
Class/Severity:	:	Class B
Detector:	:	Peak for pre-scan (9kHz Resolution Bandwidth)

11.2. Test setup and procedure

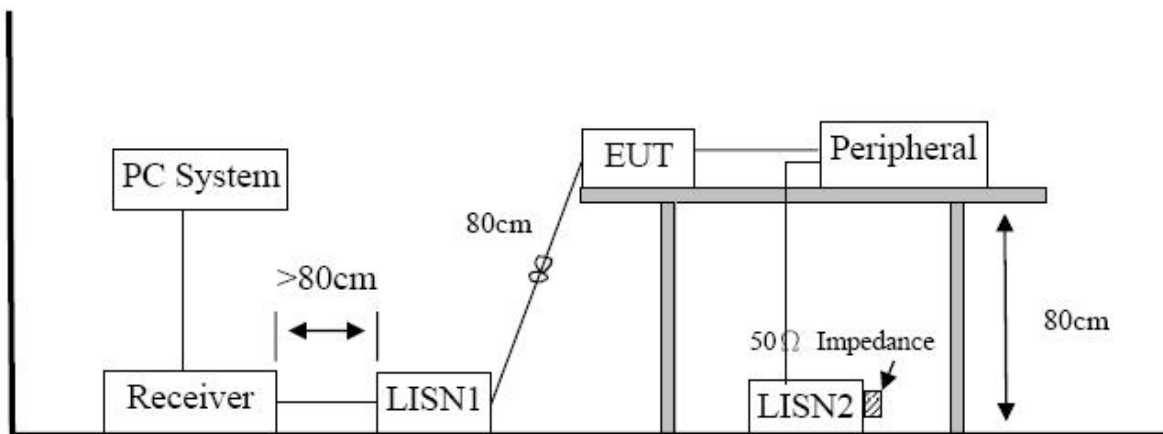

1. The EUT was placed on a table, which is 0.8m above ground plane.
2. Maximum procedure was performed on the six highest emissions to ensure EUT compliance.
3. Repeat above procedures until all frequency measured was complete.

11.3. Power Line Conducted Emission Limits(Class B)

Frequency	Quasi-Peak Level dB(μ V)	Average Level dB(μ V)
150kHz ~ 500kHz	66 ~ 56*	56 ~ 46*
500kHz ~ 5MHz	56	46
5MHz ~ 30MHz	60	50

Note 1: * Decreasing linearly with logarithm of frequency.

Note 2: The lower limit shall apply at the transition frequencies.



11.4. Test Data

Test Result: Compliant..

Note1: All emissions not reported below are too low against the prescribed limits.

Note2: “----” means average detection; “- - - -” mans peak detection

Note3: The maximised peak emissions from the EUT was scanned and measured for both the Live and Neutral Lines. Quasi-peak & average measurements were performed if peak emissions were within 6dB of the average limit line.



Conducted Emission Test Result

LINE

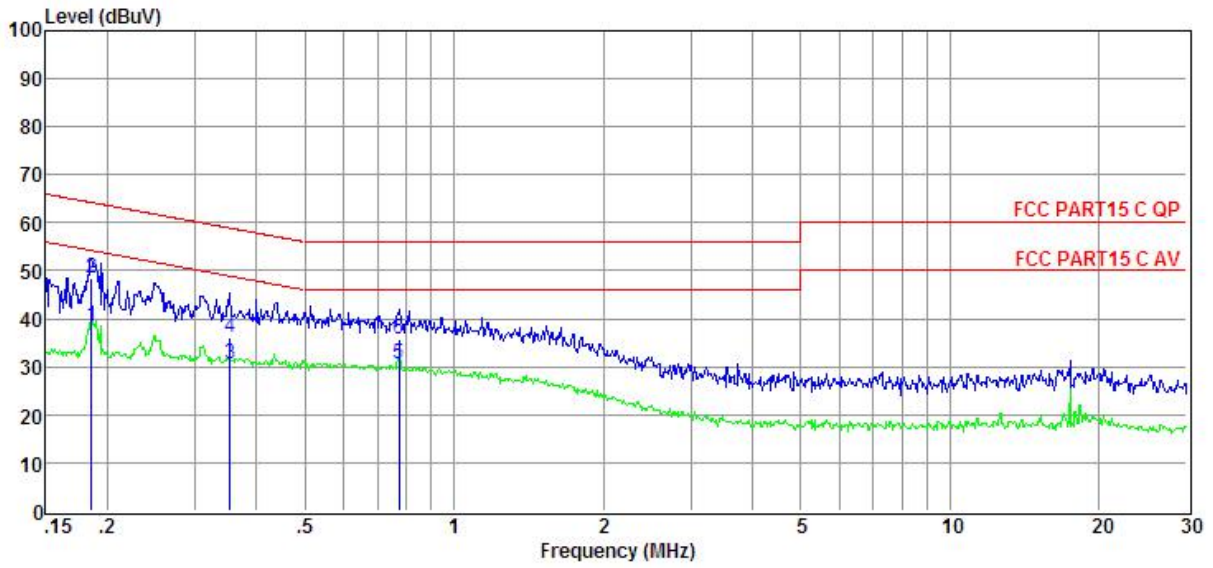

Item (Mark)	Freq (MHz)	Read Level (dBμV)	LISN Factor (dB)	Cable Loss (dB)	Result Level (dBμV)	Limit Line (dBμV)	Over Limit (dB)	Detector	Phase
1	0.19	28.90	9.59	0.10	38.59	54.24	-15.65	Average	LINE
2	0.19	38.88	9.59	0.10	48.57	64.24	-15.67	QP	LINE
3	0.35	20.97	9.61	0.10	30.68	48.87	-18.19	Average	LINE
4	0.35	26.30	9.61	0.10	36.01	58.87	-22.86	QP	LINE
5	0.78	20.66	9.62	0.20	30.48	46.00	-15.52	Average	LINE
6	0.78	25.86	9.62	0.20	35.68	56.00	-20.32	QP	LINE



Conducted Emission Test Result

NEUTRAL

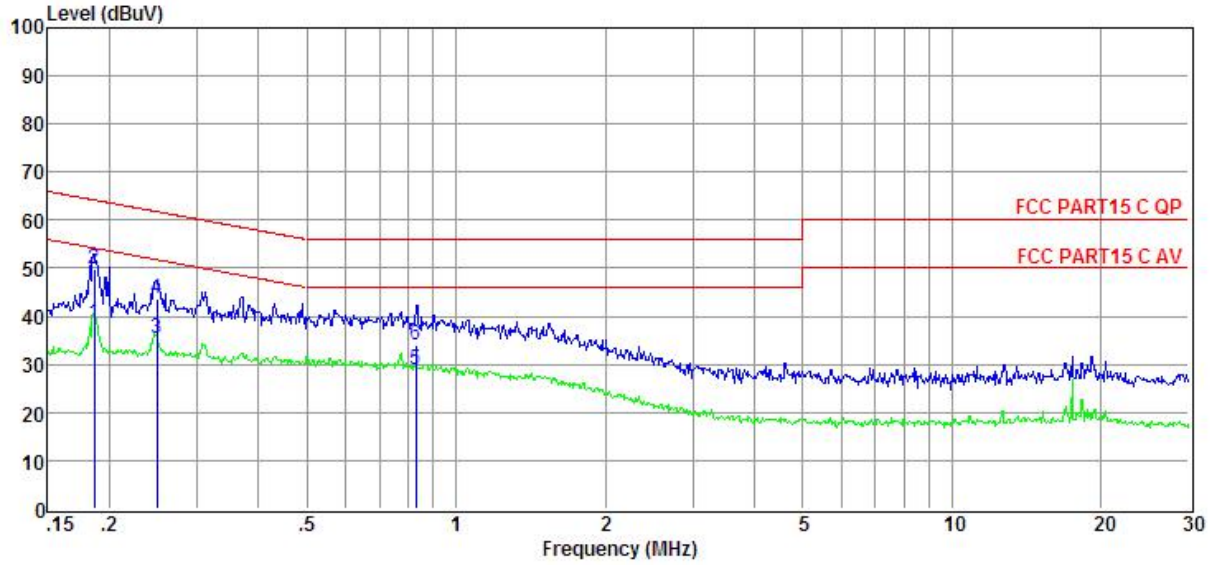

Item (Mark)	Freq (MHz)	Read Level (dBμV)	LISN Factor (dB)	Cable Loss (dB)	Result Level (dBμV)	Limit Line (dBμV)	Over Limit (dB)	Detector	Phase
1	0.19	28.86	9.66	0.10	38.62	54.20	-15.58	Average	NEUTRAL
2	0.19	40.09	9.66	0.10	49.85	64.20	-14.35	QP	NEUTRAL
3	0.25	25.68	9.66	0.10	35.44	51.78	-16.34	Average	NEUTRAL
4	0.25	33.73	9.66	0.10	43.49	61.78	-18.29	QP	NEUTRAL
5	0.83	19.01	9.64	0.20	28.85	46.00	-17.15	Average	NEUTRAL
6	0.83	24.28	9.64	0.20	34.12	56.00	-21.88	QP	NEUTRAL



12. Antenna Requirements

12.1. Limit

For intentional device, according to FCC 47 CFR Section 15.203, an intentional radiator shall be designed to ensure that no antenna other than that furnished by the responsible party shall be used with the device. And according to FCC 47 CFR Section 15.247 (b), if transmitting antennas of directional gain greater than 6dBi are used, the power shall be reduced by the amount in dB that the directional gain of the antenna exceeds 6dBi.

12.2. Result

The antenna used for this product is Integrated antenna and that no antenna other than that furnished by the responsible party shall be used with the device, the maximum peak gain of the transmit antenna is only 0dBi.

END OF REPORT