



FCC TEST REPORT

FCC ID: RSBIQ-8210DJDRM

Product Name	:	PROFESSIONAL DJ SPEAKER
Model Name	:	IQ-8210DJDRM, BK-361D10, BK-364D10, BK-341D10, BK-347D10, BK-380D10
Brand Name	:	IQ sound, SUPERSOINC, BOOK
Report No.	:	PTC18051737201E-FC01
Prepared for		
BK Pride Electronics Co.,Ltd.		
Book Digital Industry Park Meilin District, Dalingshan Town, Dongguan, China		
Prepared by		
Dongguan Precise Testing & Certification Corp., Ltd.		
Building D, Baoding Technology Park, Guangming Road 2, Guangming Community, Dongcheng District, Dongguan, Guangdong, China		



1 TEST RESULT CERTIFICATION

Applicant's name : BK Pride Electronics Co.,Ltd.
Address : Book Digital Industry Park Meilin District, Dalingshan Town, Dongguan, China
Manufacture's name : BK Pride Electronics Co.,Ltd.
Address : Book Digital Industry Park Meilin District, Dalingshan Town, Dongguan, China
Product name : PROFESSIONAL DJ SPEAKER
Model name : IQ-8210DJDRM, BK-361D10, BK-364D10, BK-341D10, BK-347D10, BK-380D10
Standards : FCC CFR47 Part 15 Section 15.247
Test procedure : ANSI C63.10:2013
Test Date : May 23, 2018 to June 08, 2018
Date of Issue : June 08, 2018
Test Result : Pass

This device described above has been tested by PTC, and the test results show that the equipment under test (EUT) is in compliance with the FCC requirements. And it is applicable only to the tested sample identified in the report.

This report shall not be reproduced except in full, without the written approval of PTC, this document may be altered or revised by PTC, personal only, and shall be noted in the revision of the document.

Test Engineer:

Leo Yang / Engineer

Technical Manager:

Chris Du / Manager



Contents

Page

1 TEST RESULT CERTIFICATION..... 2

2 TEST SUMMARY 5

3 TEST FACILITY..... 6

4 GENERAL INFORMATION 7

 4.1 GENERAL DESCRIPTION OF E.U.T..... 7

 4.2 TEST MODE 8

5 EQUIPMENT DURING TEST 10

 5.1 EQUIPMENTS LIST 10

 5.2 MEASUREMENT UNCERTAINTY 12

 5.3 DESCRIPTION OF SUPPORT UNITS..... 13

6 CONDUCTED EMISSION 14

 6.1 E.U.T. OPERATION 14

 6.2 EUT SETUP 14

 6.3 TEST SET-UP (BLOCK DIAGRAM OF CONFIGURATION) 15

 6.4 MEASUREMENT PROCEDURE:..... 15

 6.5 CONDUCTED EMISSION LIMIT..... 15

 6.6 MEASUREMENT DESCRIPTION 15

 6.7 CONDUCTED EMISSION TEST RESULT..... 15

7 RADIATED SPURIOUS EMISSIONS 18

 7.1 EUT OPERATION..... 18

 7.2 TEST SETUP 19

 7.3 SPECTRUM ANALYZER SETUP 20

 7.4 TEST PROCEDURE..... 21

 7.5 SUMMARY OF TEST RESULTS 22

8 CONDUCTED BAND EDGE EMISSION 27

 8.1 REQUIREMENT..... 27

 8.2 TEST PROCEDURE..... 27

 8.3 TEST SETUP 27

 8.4 EUT OPERATION CONDITIONS 28



8.5 TEST RESULTS..... 28

9 20 DB BANDWIDTH MEASUREMENT..... 35

9.1 TEST PROCEDURE..... 35

9.2 TEST RESULT 35

10 MAXIMUM PEAK OUTPUT POWER 41

10.1 TEST PROCEDURE..... 41

10.2 TEST RESULT 41

11 HOPPING CHANNEL SEPARATION..... 48

11.1 TEST PROCEDURE..... 48

11.2 TEST RESULT 49

12 NUMBER OF HOPPING FREQUENCY 55

12.1 TEST PROCEDURE..... 55

12.2 TEST RESULT 55

13 DWELL TIME..... 56

13.1 TEST PROCEDURE..... 56

13.2 TEST RESULT 56

14 ANTENNA REQUIREMENT..... 59

15 TEST PHOTOS..... 60

16 EUT PHOTOS..... 62



2 Test Summary

Test Items	Test Requirement	Result
Radiated Spurious Emissions	15.205(a) 15.209 15.247(d)	PASS
Band edge	15.247(d) 15.205(a)	PASS
Conduct Emission	15.207	PASS
20dB Bandwidth	15.247(a)(1)	PASS
Maximum Peak Output Power	15.247(b)(1)	PASS
Frequency Separation	15.247(a)(1)	PASS
Number of Hopping Frequency	15.247(a)(1)(iii)	PASS
Dwell time	15.247(a)(1)(iii)	PASS
Antenna Requirement	15.203	PASS



PRECISE TESTING

Report No.: PTC18051737201E-FC01

3 TEST FACILITY

Dongguan Precise Testing & Certification Corp., Ltd.

Address: Building D, Baoding Technology Park, Guangming Road2, Dongcheng District, Dongguan, Guangdong, China

FCC Registration Number: 790290

A2LA Certificate No.: 4408.01

IC Registration Number: 12191A-1

Test Lab: Shenzhen BCTC Testing Co., Ltd.

Address: BCTC Building & 1-2F, East of B Building, Pengzhou Industrial, Fuyuan 1st Road, Qiaotou Community, Fuyong Street, Bao'an District, Shenzhen, China

FCC Registered No.: 712850

Test items: Radiated Spurious Emission(18GHz to 25GHz)



4 General Information

4.1 General Description of E.U.T.

Product Name	:	PROFESSIONAL DJ SPEAKER
Model Name	:	IQ-8210DJDRM, BK-361D10, BK-364D10, BK-341D10, BK-347D10, BK-380D10 (Note: The samples are the same except appearance and model number. So IQ-8210DJDRM was selected for full tested.)
Bluetooth Version	:	BT 2.1+EDR
Operating frequency	:	2402-2480MHz
Numbers of Channel	:	79 channels
Antenna Type	:	Internal PCB Antenna
Antenna Gain	:	1.2 dBi
Type of Modulation	:	GFSK, $\pi/4$ -DQPSK, 8DPSK
Power supply	:	For Adapter: Model: RS-AE024J00 Input: AC 100-240V, 50/60Hz, 1.2A Output: DC 15V, 2.4A
Hardware Version	:	V1.0
Software Version	:	V1.0



4.2 Test Mode

The EUT has been tested under its typical operating condition. Pre-defined engineering program for regulatory testing used to control the EUT for staying in continuous transmitting. Only the worst case data were reported.

The EUT has been associated with peripherals pursuant to ANSI C63.10-2013 and configuration operated in a manner tended to maximize its emission characteristics in a typical application. Frequency range investigated: radiation (9 KHz to the 10th harmonics of the highest fundamental frequency or to 40 GHz, whichever is lower).

The EUT has been tested under TX operating condition.

This EUT is a FHSS system, were conducted to determine the final configuration from all possible combinations. We use software control the EUT, Let EUT hopping on and transmit with highest power, all the modes GFSK, $\pi/4$ -DQPSK, 8DPSK have been tested. 79 Channels are provided by EUT. The 3 channels of lower, medium and higher were chosen for test.



Channel List:

Channel	Frequency (MHz)	Channel	Frequency (MHz)	Channel	Frequency (MHz)	Channel	Frequency (MHz)
0	2402	1	2403	2	2404	3	2405
4	2406	5	2407	6	2408	7	2409
8	2410	9	2411	10	2412	11	2413
12	2414	13	2415	14	2416	15	2417
16	2418	17	2419	18	2420	19	2421
20	2422	21	2423	22	2424	23	2425
24	2426	25	2427	26	2428	27	2429
28	2430	29	2431	30	2432	31	2433
32	2434	33	2435	34	2436	35	2437
36	2438	37	2439	38	2440	39	2441
40	2442	41	2443	42	2444	43	2445
44	2446	45	2447	46	2448	47	2449
48	2450	49	2451	50	2452	51	2453
52	2454	53	2455	54	2456	55	2457
56	2458	57	2459	58	2460	59	2461
60	2462	61	2463	62	2464	63	2465
64	2466	65	2467	66	2468	67	2469
68	2470	69	2471	70	2472	71	2473
72	2474	73	2475	74	2476	75	2477
76	2478	77	2479	78	2480	-	-

Channel	Frequency(MHz)
0	2402
39	2441
78	2480



5 Equipment During Test

5.1 Equipments List

RF Conducted Test

Name of Equipment	Manufacturer	Model	Serial No.	Characteristics	Calibration Due
MXG Signal Analyzer	Agilent	N9020A	MY56070279	10Hz-30GHz	Apr 07, 2019
Coaxial Cable	CDS	79254	46107086	10Hz-30GHz	Oct 09, 2018
Antenna Connector	Florida RF Labs	N/A	RF01#	N/A	Aug. 26, 2018

Remark: The temporary antenna connector is soldered on the PCB board in order to perform conducted tests and this temporary antenna connector is listed in the equipment list.

Radiated Emissions(Test Frequency from 9KHz-18GHz)

Name of Equipment	Manufacturer	Model	Serial No.	Characteristics	Calibration Due
EMI Test Receiver	Rohde&Schwarz	ESCI	101417	9KHz-3GHz	Sep. 03, 2018
Loop Antenna	Schwarzbeck	FMZB 1519	012	9 KHz -30MHz	Aug 31, 2018
Bilog Antenna	SCHWARZBECK	VULB9160	9160-3355	25MHz-2GHz	Aug 31, 2018
Preamplifier (low frequency)	SCHWARZBECK	BBV 9475	9745-0013	1MHz-1GHz	Sep. 03, 2018
Cable	Schwarzbeck	PLF-100	549489	9KHz-3GHz	Sep. 03, 2018
Spectrum Analyzer	Agilent	E4407B	MY45109572	9KHz-40GHz	Oct. 13, 2018
Horn Antenna	SCHWARZBECK	9120D	9120D-1246	1GHz-18GHz	Aug. 31, 2018
Power Amplifier	LUNAR EM	LNA1G18-40	J10100000081	1GHz-26.5GHz	Aug. 31, 2018
Cable	H+S	CBL-26	N/A	1GHz-26.5GHz	Sep. 03, 2018



Radiated Emission (Test Frequency from 18GHz-25GHz)

Name of Equipment	Manufacturer	Model	Serial No.	Characteristics	Calibration Due
Spectrum Analyzer	Agilent	E4407B	MY45109572	9KHz-26.5GHz	2018.08.26
Test Receiver	R&S	ESPI	101396	9KHz-7GHz	2018.08.26
Horn Antenna	SCHWARZBECK	BBHA 9170	9170-181	14GHz-40GHz	2018.09.02
Amplifier	SCHWARZBECK	BBV 9721	9721-205	18GHz-40GHz	2018.08.26
RF Cable	R&S	R204	R21X	1GHz-40GHz	2018.08.26

Conducted Emissions

Name of Equipment	Manufacturer	Model	Serial No.	Characteristics	Calibration Due
EMI Test Receiver	Rohde&Schwarz	ESCI	101417	9KHz-3GHz	Sep. 03, 2018
Artificial Mains Network	Rohde&Schwarz	L2-16B	000WX31025	9KHz-300MHz	Sep. 03, 2018
Artificial Mains Network	Rohde&Schwarz	ENV216	101342	9KHz-300MHz	Sep. 03, 2018



5.2 Measurement Uncertainty

Parameter	Uncertainty
RF output power, conducted	±1.0dB
Power Spectral Density, conducted	±2.2dB
Radio Frequency	± 1 x 10 ⁻⁶
Bandwidth	± 1.5 x 10 ⁻⁶
Time	±2%
Duty Cycle	±2%
Temperature	±1°C
Humidity	±5%
DC and low frequency voltages	±3%
Conducted Emissions (150kHz~30MHz)	±3.64dB
Radiated Emission(30MHz~1GHz)	±5.03dB
Radiated Emission(1GHz~25GHz)	±4.74dB
Remark: The coverage Factor (k=2), and measurement Uncertainty for a level of Confidence of 95%	



5.3 Description of Support Units

Equipment	Model No.	Series No.
N/A	N/A	N/A



6 Conducted Emission

Test Requirement: : FCC CFR 47 Part 15 Section 15.207
Test Method: : ANSI C63.10:2013
Test Result: : PASS
Frequency Range: : 150kHz to 30MHz
Class/Severity: : Class B
Detector: : Peak for pre-scan (9kHz Resolution Bandwidth)

6.1 E.U.T. Operation

Operating Environment :

Temperature: : 25.5 °C
Humidity: : 51 % RH
Atmospheric Pressure: : 101.2kPa
Test Voltage : AC 120V/60Hz

6.2 EUT Setup

The conducted emission tests were performed using the setup accordance with the ANSI C63.10: 2013

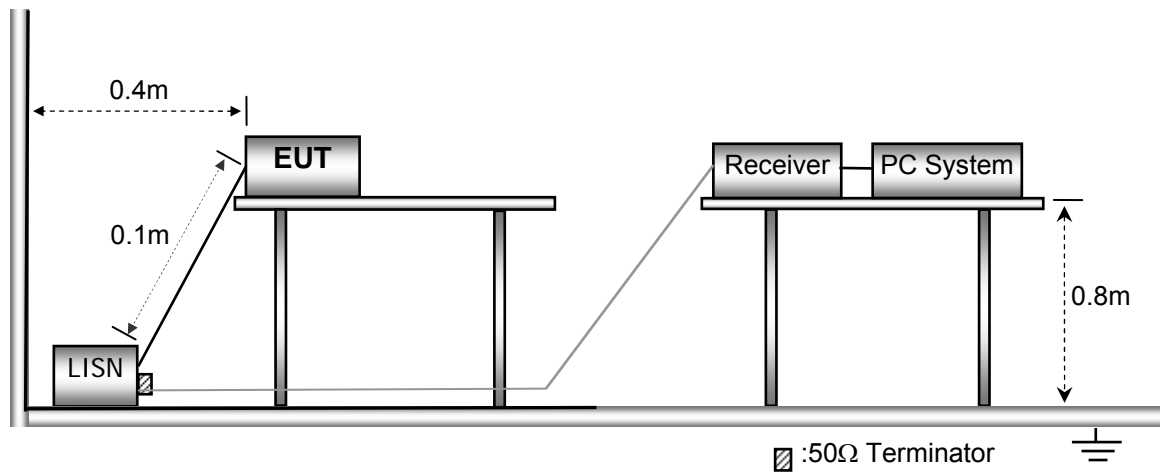



6.3 Test SET-UP (Block Diagram of Configuration)

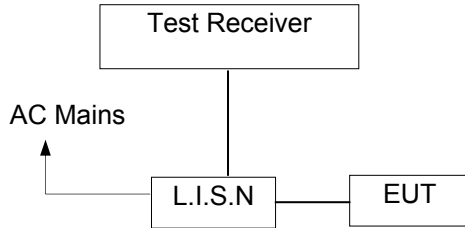

6.4 Measurement Procedure:

1. The EUT was placed on a table, which is 0.1m above ground plane.
2. Maximum procedure was performed on the six highest emissions to ensure EUT compliance.
3. Repeat above procedures until all frequency measured was complete.

6.5 Conducted Emission Limit

Conducted Emission

Frequency(MHz)	Quasi-peak	Average
0.15-0.5	66-56	56-46
0.5-5.0	56	46
5.0-30.0	60	50

Note:

1. The lower limit shall apply at the transition frequencies
2. The limit decreases in line with the logarithm of the frequency in the range of 0.15 to 0.50MHz.

6.6 Measurement Description

The maximised peak emissions from the EUT was scanned and measured for both the Live and Neutral Lines. Quasi-peak & average measurements were performed if peak emissions were within 6dB of the average limit line.

6.7 Conducted Emission Test Result

Pass.

All the modulation modes were tested the data of the worst mode (AC 120V/60Hz, GFSK TX 2402MHz) are recorded in the following pages and the others modulation methods do not exceed the limits.



Line -120V/60Hz:

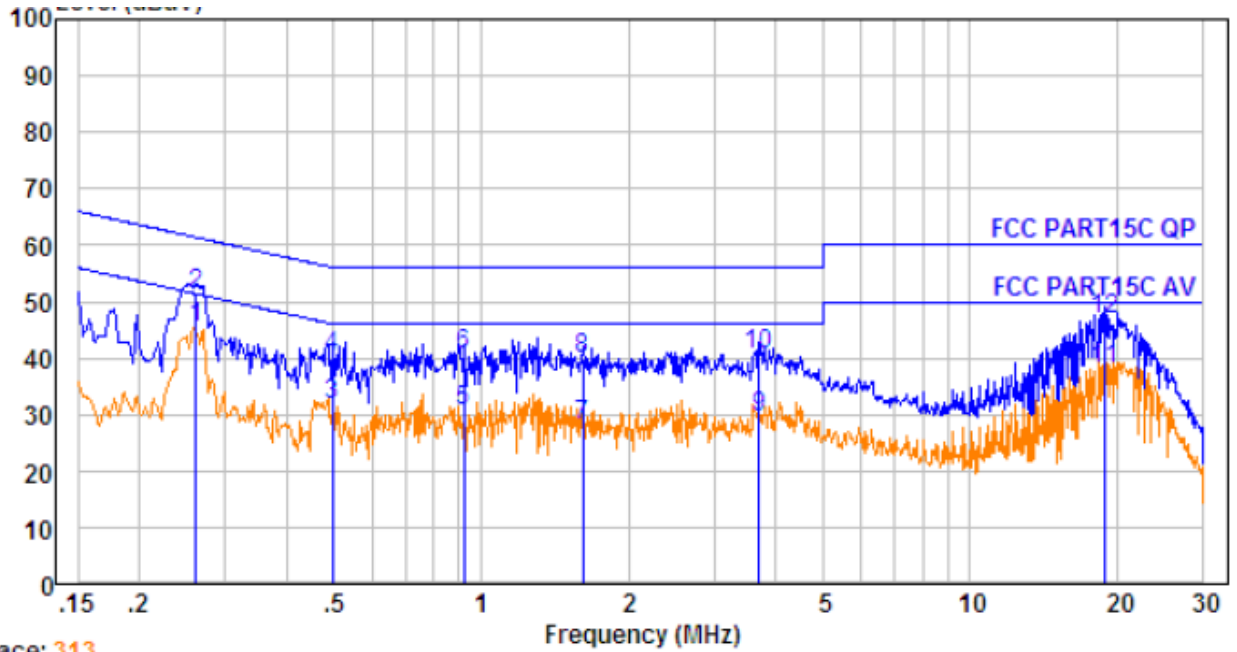

Trace: 313

No.	Freq MHz	Cable Loss dB	AMN Factor dB	Receiver Reading dBuV	Emission Level dBuV	Limit dBuV	Over Limit dB	Remark
1.	0.262	0.34	9.65	35.26	45.25	51.38	-6.13	Average
2.	0.262	0.34	9.65	41.41	51.40	61.38	-9.98	QP
3.	0.497	0.43	9.78	21.63	31.84	46.05	-14.21	Average
4.	0.497	0.43	9.78	30.15	40.36	56.05	-15.69	QP
5.	0.923	0.46	9.82	20.33	30.61	46.00	-15.39	Average
6.	0.923	0.46	9.82	30.41	40.69	56.00	-15.31	QP
7.	1.619	0.47	9.84	17.85	28.16	46.00	-17.84	Average
8.	1.619	0.47	9.84	29.51	39.82	56.00	-16.18	QP
9.	3.700	0.47	9.89	19.33	29.69	46.00	-16.31	Average
10.	3.700	0.47	9.89	30.14	40.50	56.00	-15.50	QP
11.	18.820	0.43	9.88	27.63	37.94	50.00	-12.06	Average
12.	18.820	0.43	9.88	36.41	46.72	60.00	-13.28	QP



Neutral -120V/60Hz:

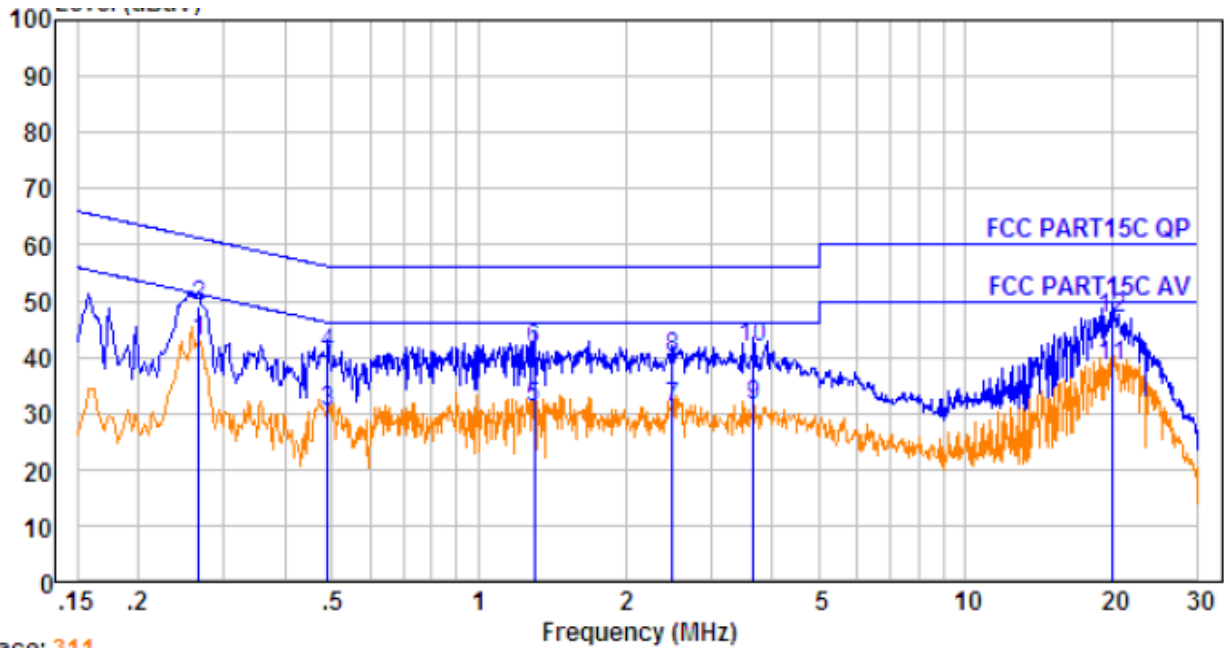

Trace: 311

No.	Freq MHz	Cable Loss dB	AMN Factor dB	Receiver Reading dBuV	Emission Level dBuV	Limit dBuV	Over Limit dB	Remark
1.	0.266	0.34	9.68	32.68	42.70	51.25	-8.55	Average
2.	0.266	0.34	9.68	39.22	49.24	61.25	-12.01	QP
3.	0.489	0.43	9.81	19.97	30.21	46.19	-15.98	Average
4.	0.489	0.43	9.81	30.53	40.77	56.19	-15.42	QP
5.	1.303	0.46	9.86	20.82	31.14	46.00	-14.86	Average
6.	1.303	0.46	9.86	31.15	41.47	56.00	-14.53	QP
7.	2.500	0.47	9.90	20.58	30.95	46.00	-15.05	Average
8.	2.500	0.47	9.90	29.35	39.72	56.00	-16.28	QP
9.	3.661	0.47	9.93	21.01	31.41	46.00	-14.59	Average
10.	3.661	0.47	9.93	31.14	41.54	56.00	-14.46	QP
11.	19.950	0.39	9.96	27.98	38.33	50.00	-11.67	Average
12.	19.950	0.39	9.96	36.42	46.77	60.00	-13.23	QP



7 Radiated Spurious Emissions

Test Requirement : FCC CFR47 Part 15 Section 15.209 & 15.247
 Test Method : ANSI C63.10:2013
 Test Result : PASS
 Measurement Distance : 3m
 Limit : See the follow table

Frequency (MHz)	Field Strength		Field Strength Limit at 3m Measurement Dist	
	uV/m	Distance (m)	uV/m	dBuV/m
0.009 ~ 0.490	$2400/F(\text{kHz})$	300	$10000 * 2400/F(\text{kHz})$	$20\log^{(2400/F(\text{kHz}))} + 80$
0.490 ~ 1.705	$24000/F(\text{kHz})$	30	$100 * 24000/F(\text{kHz})$	$20\log^{(24000/F(\text{kHz}))} + 40$
1.705 ~ 30	30	30	$100 * 30$	$20\log^{(30)} + 40$
30 ~ 88	100	3	100	$20\log^{(100)}$
88 ~ 216	150	3	150	$20\log^{(150)}$
216 ~ 960	200	3	200	$20\log^{(200)}$
Above 960	500	3	500	$20\log^{(500)}$

7.1 EUT Operation

Operating Environment :

Temperature : 23.5 °C
 Humidity : 51.1 % RH
 Atmospheric Pressure : 101.2kPa

7.2 Test Setup

The radiated emission tests were performed in the 3m Semi- Anechoic Chamber test site

The test setup for emission measurement below 30MHz.

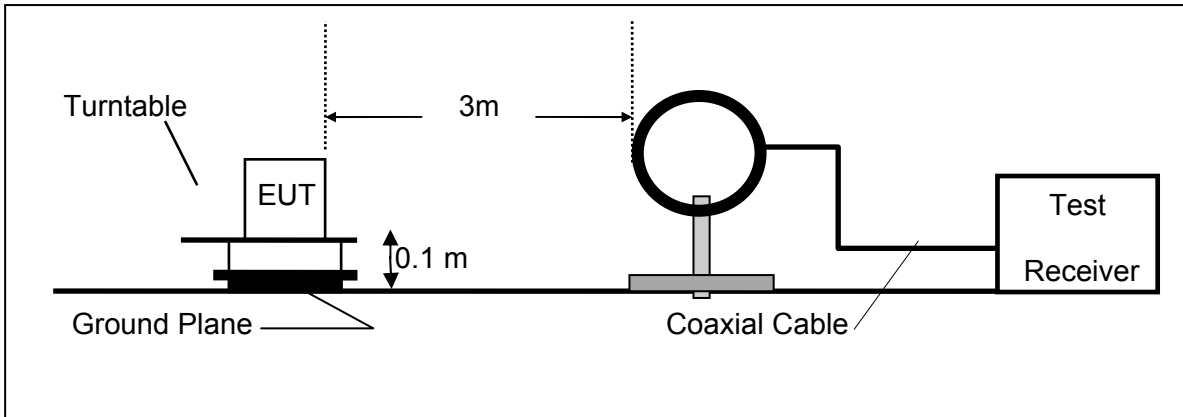

The test setup for emission measurement from 30 MHz to 1 GHz.

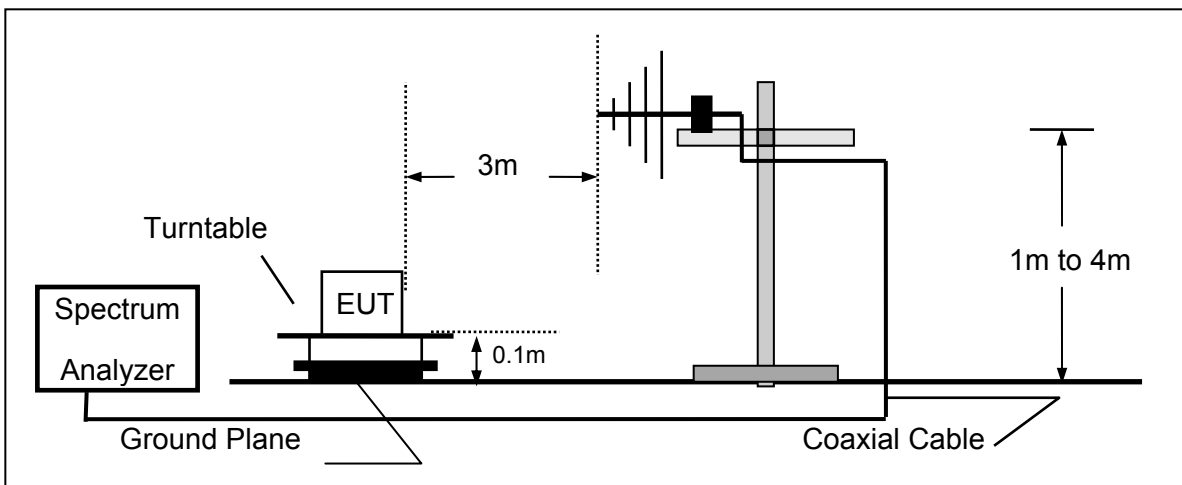

The test setup for emission measurement above 1 GHz.

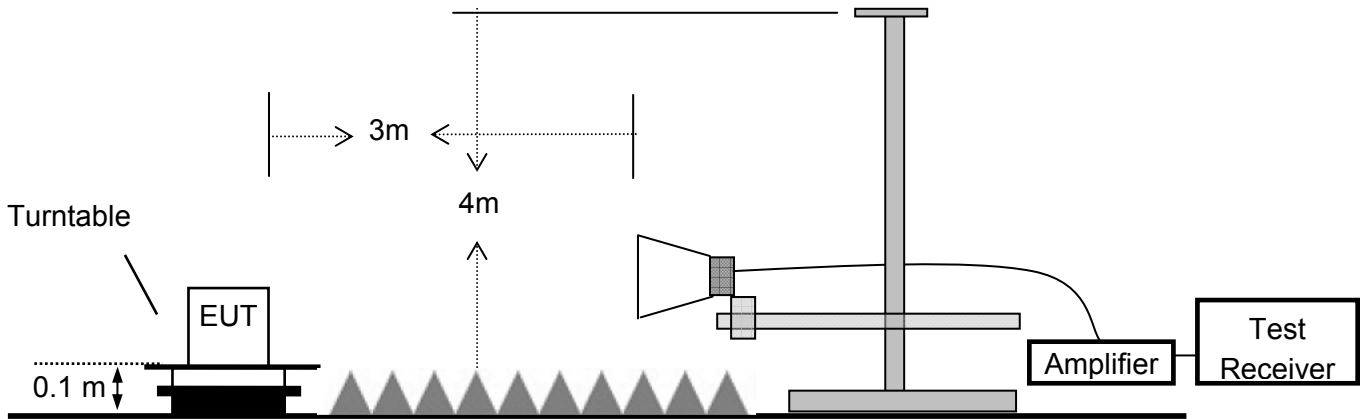

7.3 Spectrum Analyzer Setup

Spectrum Parameter	Setting
Attenuation	Auto
Start Frequency	1000 MHz
Stop Frequency	10th carrier harmonic
RB / VB (emission in restricted band)	1 MHz / 1 MHz for Peak, 1 MHz / 10Hz for Average

Receiver Parameter	Setting
Attenuation	Auto
Start ~ Stop Frequency	9kHz~150kHz / RB 200Hz for QP
Start ~ Stop Frequency	150kHz~30MHz / RB 9kHz for QP
Start ~ Stop Frequency	30MHz~1000MHz / RB 120kHz for QP



7.4 Test Procedure

1. The testing follows the guidelines in Spurious Radiated Emissions of ANSI C63.10-2013.
2. Below 1000MHz, The EUT was placed on a turn table which is 0.1m above ground plane. And above 1000MHz, The EUT was placed on a styrofoam table which is 0.1m above ground plane.
3. The EUT was set 3 meters from the interference receiving antenna, which was mounted on the top of a variable height antenna tower.
4. For each suspected emission, the EUT was arranged to its worst case and then tune the Antenna tower (From 1m to 4m) and turntable (from 0 degree to 360 degree) to find the maximum reading. A pre-amp and a high pass filter are used for the test in order to get better signal level to comply with the guidelines.
5. Set to the maximum power setting and enable the EUT transmit continuously.
6. Final measurement (Above 1GHz): The frequency range will be divided into different sub ranges depending of the frequency range of the used horn antenna. The EMI Receiver set to peak and average mode and a resolution bandwidth of 1MHz. The measurement will be performed in horizontal and vertical polarization of the measuring antenna and while rotating the EUT in its vertical axis in the range of 0 degree to 360 degree in order to have the antenna inside the cone of radiation.
7. Test Procedure of measurement (For Above 1GHz):
 - 1) Monitor the frequency range at horizontal polarization and move the antenna over all sides of the EUT(if necessary move the EUT to another orthogonal axis).
 - 2) Change the antenna polarization and repeat 1) with vertical polarization.
 - 3) Make a hardcopy of the spectrum.
 - 4) Measure the frequency of the detected emissions with a lower span and resolution bandwidth to increase the accuracy and note the frequency value.
 - 5) Change the analyser mode to Clear/ Write and found the cone of emission.
 - 6) Rotate and move the EUT, so that the measuring distance can be enlarged to 3m and the antenna will be still inside the cone of emission.
 - 7) Measure the level of the detected frequency with the correct resolution bandwidth, with the antenna polarization and azimuth and the peak and average detector, which causes the maximum emission.
 - 8) Repeat steps 1) to 7) for the next antenna spot if the EUT is larger than the antenna beamwidth.
7. The radiation measurements are tested under 3-axes(X,Y,Z) position(X denotes lying on the table, Y denotes side stand and Z denotes vertical stand), After pre-test, It was found that the worse radiation emission was get at the X position. So the data shown was the X position only.



7.5 Summary of Test Results

Test Frequency: 9KHz-30MHz

Freq. (MHz)	Ant.Pol. H/V	Emission Level (dBuV/m)	Limit 3m (dBuV/m)	Over (dB)
--	--	--	--	>20

Note:

The amplitude of spurious emission that is attenuated by more than 20dB below the permissible limit has no need to be reported.

Distance extrapolation factor = $40\log(\text{Specific distance/ test distance})$ (dB);
Limit line=Specific limits(dBuV) + distance extrapolation factor.

Test Frequency: 30MHz ~ 1GHz

Please refer to the following test plots:

All the modulation modes were tested the data of the worst mode (AC 120V/60Hz, GFSK TX 2402MHz) are recorded in the following pages and the others modulation methods do not exceed the limits.



Test plot for Horizontal: GFSK(2402MHz)

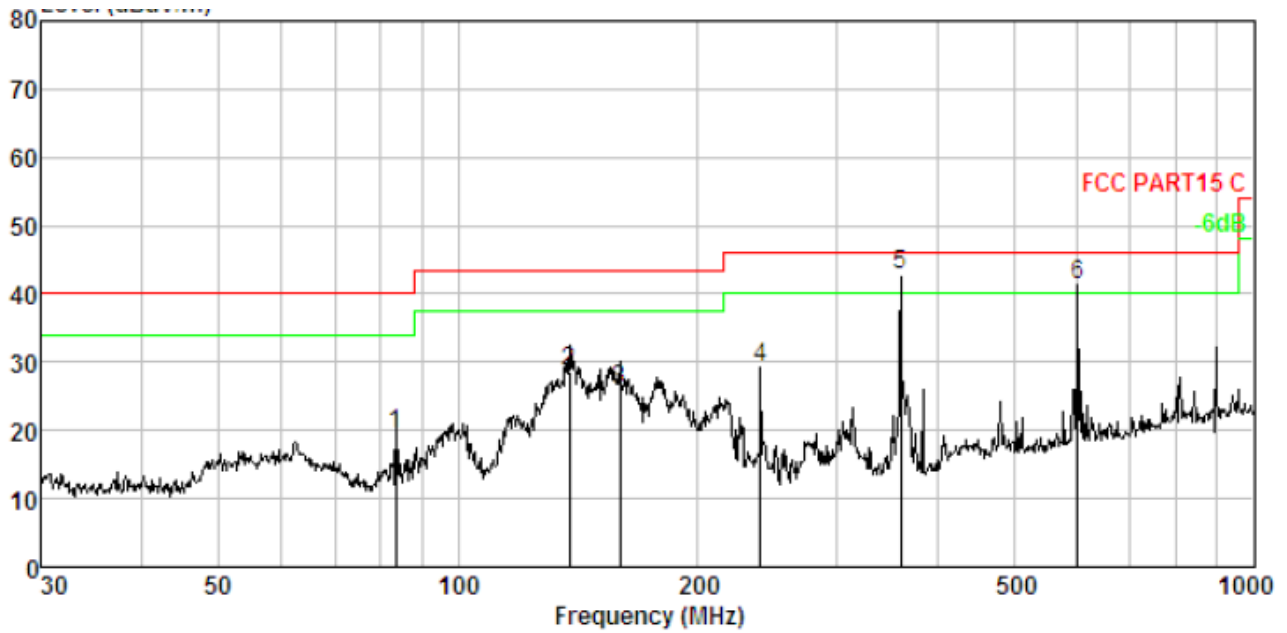

No.	Freq MHz	Cable Loss dB	ANT Factor dB/m	Receiver Reading dBuV	Preamp Factor dB	Emission Level dBuV/m	Limit dBuV/m	Over Limit dB	Remark
1.	83.522	1.98	8.71	38.99	30.33	19.35	40.00	-20.65	QP
2.	137.903	2.44	13.21	43.36	30.50	28.51	43.50	-14.99	QP
3.	159.784	2.57	13.88	40.08	30.55	25.98	43.50	-17.52	QP
4.	239.987	2.94	11.71	45.18	30.69	29.14	46.00	-16.86	QP
5.	360.448	3.31	14.40	55.89	30.83	42.77	46.00	-3.23	QP
6.	601.427	3.77	19.16	49.30	31.01	41.22	46.00	-4.78	QP



Test plot for Vertical: GFSK(2402MHz)

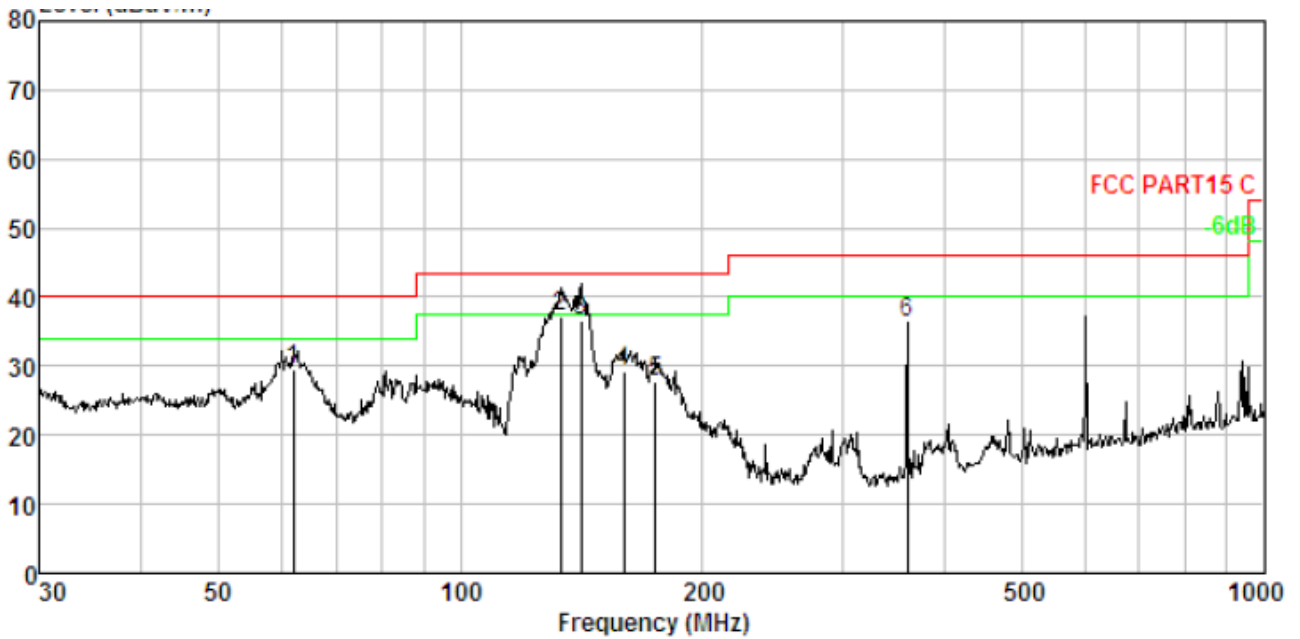

No.	Freq MHz	Cable Loss dB	ANT Factor dB/m	Receiver Reading dBuV	Preamp Factor dB	Emission Level dBuV/m	Limit dBuV/m	Over Limit dB	Remark
1.	61.995	1.71	12.04	45.86	30.22	29.39	40.00	-10.61	QP
2.	133.151	2.40	12.87	52.44	30.49	37.22	43.50	-6.28	QP
3.	141.330	2.46	13.43	51.10	30.51	36.48	43.50	-7.02	QP
4.	159.784	2.57	13.88	43.20	30.55	29.10	43.50	-14.40	QP
5.	175.037	2.65	12.88	42.91	30.58	27.86	43.50	-15.64	QP
6.	360.448	3.31	14.40	49.49	30.83	36.37	46.00	-9.63	QP



Test Frequency 1GHz-18GHz

Low Channel (2402MHz) Worst case GFSK

Frequency (MHz)	S.A Reading (dBuV)	Detector (PK/AV)	Polarity (H/V)	Ant. Factor (dB/m)	Cable Loss (dB)	Pre-Amp. Gain (dB)	Emission Level (dBuV/m)	Limit (dBuV/m)	Margin (dB)
4804	28.43	AV	V	7.69	10.13	10.43	35.82	54	-18.18
4804	29.05	AV	H	7.69	10.13	10.43	36.44	54	-17.56
4804	30.45	PK	V	7.69	10.13	10.43	37.84	74	-36.16
4804	31.29	PK	H	7.69	10.13	10.43	38.68	74	-35.32
15425	28.43	AV	V	8.26	12.48	8.29	40.88	54	-13.12
15425	29.57	AV	H	8.26	12.48	8.29	42.02	54	-11.98
15425	31.69	PK	V	8.26	12.48	8.29	44.14	74	-29.86
15425	32.48	PK	H	8.26	12.48	8.29	44.93	74	-29.07

Middle Channel (2441MHz) Worst case π/4-DQPSK

Frequency (MHz)	S.A Reading (dBuV)	Detector (PK/AV)	Polarity (H/V)	Ant. Factor (dB/m)	Cable Loss (dB)	Pre-Amp. Gain (dB)	Emission Level (dBuV/m)	Limit (dBuV/m)	Margin (dB)
4882	29.35	AV	V	8.45	9.24	8.13	38.91	54	-15.09
4882	30.11	AV	H	8.45	9.24	8.13	39.67	54	-14.33
4882	28.46	PK	V	8.45	9.24	8.13	38.02	74	-35.98
4882	31.26	PK	H	8.45	9.24	8.13	40.82	74	-33.18
16518	29.85	AV	V	7.96	9.55	10.27	37.09	54	-16.91
16518	30.45	AV	H	7.96	9.55	10.27	37.69	54	-16.31
16518	32.58	PK	V	7.96	9.55	10.27	39.82	74	-34.18
16518	31.69	PK	H	7.96	9.55	10.27	38.93	74	-35.07

High Channel (2480MHz) Worst case GFSK

Frequency (MHz)	S.A Reading (dBuV)	Detector (PK/AV)	Polarity (H/V)	Ant. Factor (dB/m)	Cable Loss (dB)	Pre-Amp. Gain (dB)	Emission Level (dBuV/m)	Limit (dBuV/m)	Margin (dB)
4960	31.26	AV	V	8.09	9.85	10.49	38.71	54	-15.29
4960	29.54	AV	H	8.09	9.85	10.49	36.99	54	-17.01
4960	28.04	PK	V	8.09	9.85	10.49	35.49	74	-38.51
4960	30.48	PK	H	8.09	9.85	10.49	37.93	74	-36.07
17125	32.65	AV	V	9.51	10.24	8.67	43.73	54	-10.27
17125	33.24	AV	H	9.51	10.24	8.67	44.32	54	-9.68
17125	31.26	PK	V	9.51	10.24	8.67	42.34	74	-31.66
17125	29.54	PK	H	9.51	10.24	8.67	40.62	74	-33.38

Note: 1. The testing has been conformed to 10*2480MHz=24800MHz.

- 2. All other emissions more than 30dB below the limit.
- 3. Factor = Antenna Factor + Cable Loss – Pre-amplifier.
 Emission Level = Reading + Factor
 Margin=Emission Level-Limit



Test Frequency: From 18GHz to 25GHz

The measurements were more than 20dB below the limit and not reported.

8 CONDUCTED BAND EDGE EMISSION

8.1 REQUIREMENT

According to FCC section 15.247(d), in any 100kHz bandwidth outside the frequency band in which the spread spectrum or digitally modulated intentional radiator is operating, the radio frequency power that is produced by the intentional radiator shall be at least 20dB below that in the 100kHz bandwidth within the band that contains the highest level of the desired power, based on either an RF conducted or a radiated measurement.

8.2 TEST PROCEDURE

Spectrum Parameter	Setting
Detector	Peak
Start/Stop Frequency	30 MHz to 10th carrier harmonic
RB / VB (emission in restricted band)	100 KHz/300 KHz
Trace-Mode:	Max hold

For Band edge

Spectrum Parameter	Setting
Detector	Peak
Start/Stop Frequency	Lower Band Edge: 2300 – 2403 MHz Upper Band Edge: 2479 – 2500 MHz
RB / VB (emission in restricted band)	100 KHz/300 KHz
Trace-Mode:	Max hold

8.3 TEST SETUP

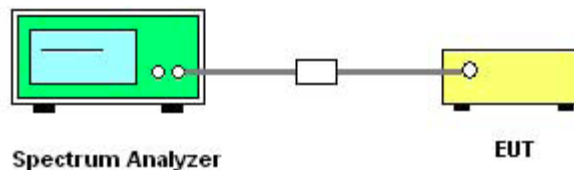

1. The transmitter output is connected to a spectrum analyzer. The resolution bandwidth is set to 100KHz. The video bandwidth is set to 300KHz.
2. The spectrum from 30MHz to 26 GHz is investigated with the transmitter set to the lowest, middle, and highest channels.



8.4 EUT OPERATION CONDITIONS

The EUT tested system was configured as the statements of 2.3 Unless otherwise a special operating condition is specified in the follows during the testing.

8.5 TEST RESULTS

For Non-Hopping Mode:

GFSK

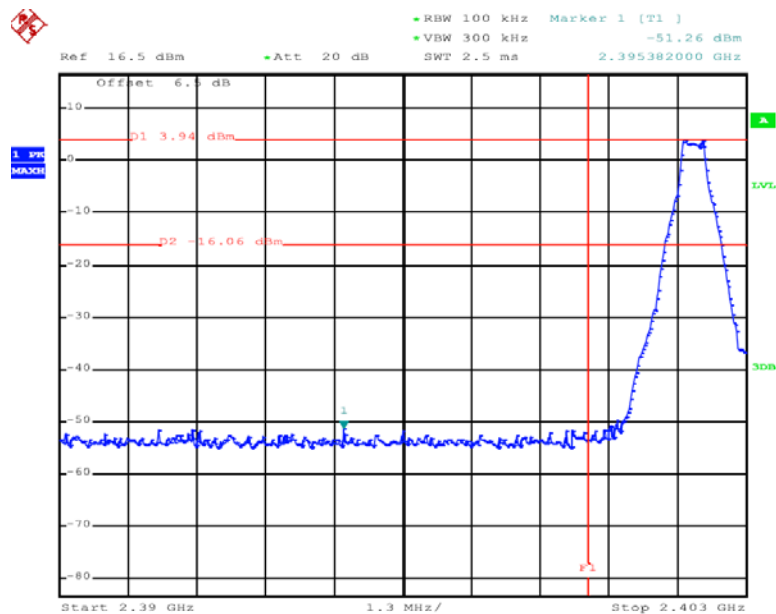

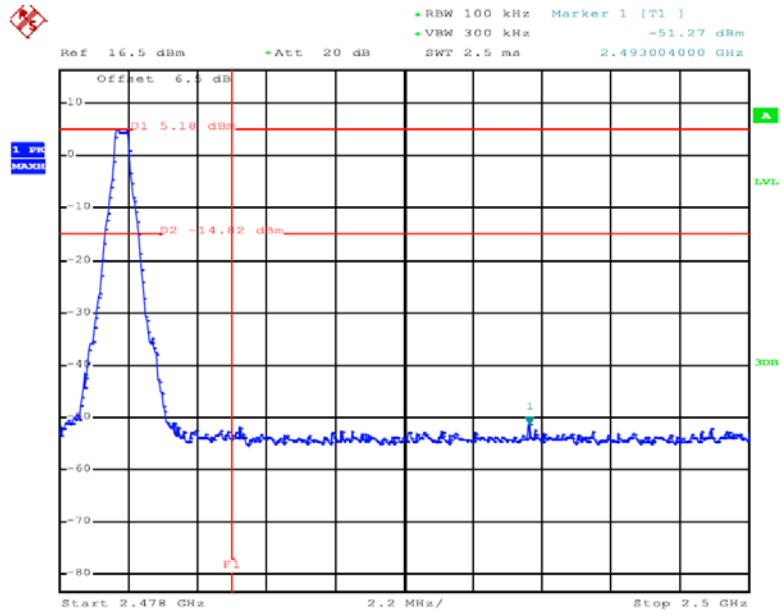

$\pi/4$ -DQPSK

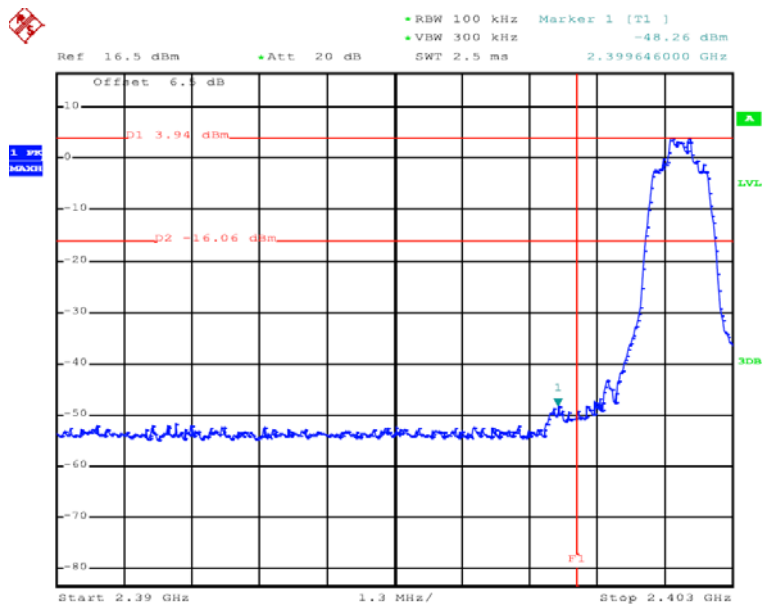

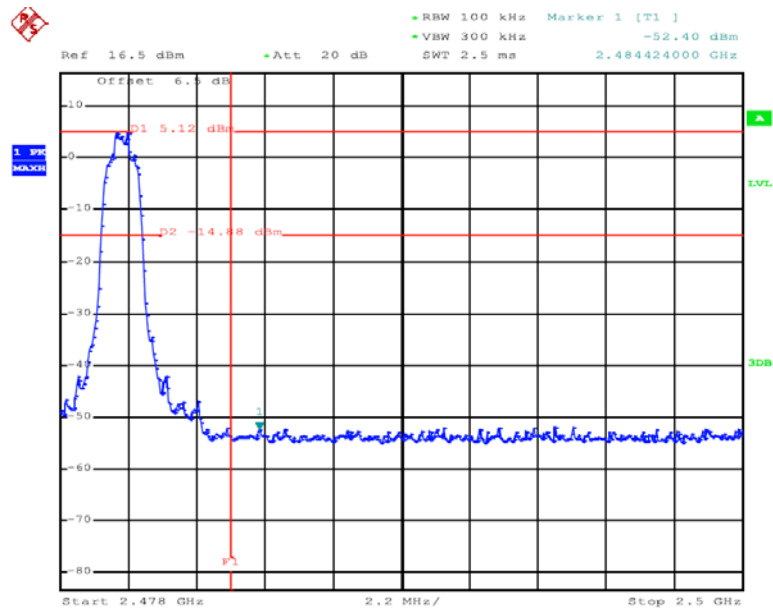

8DPSK

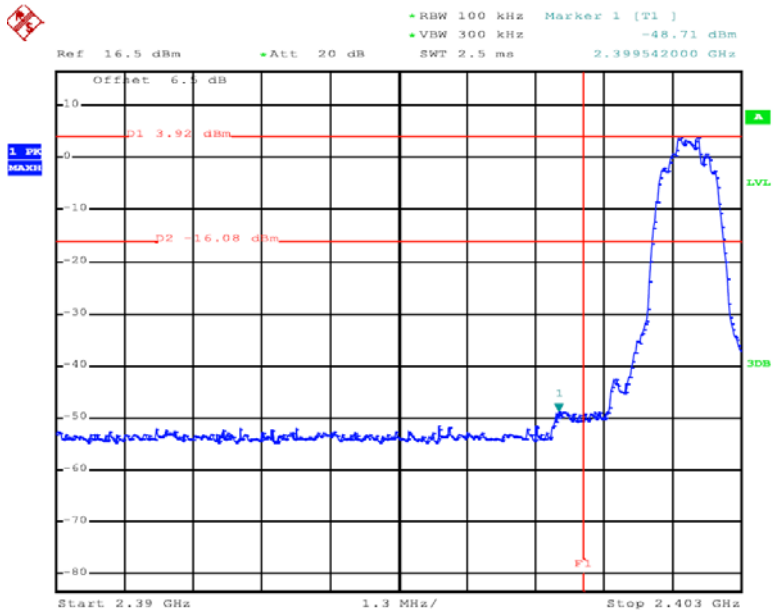

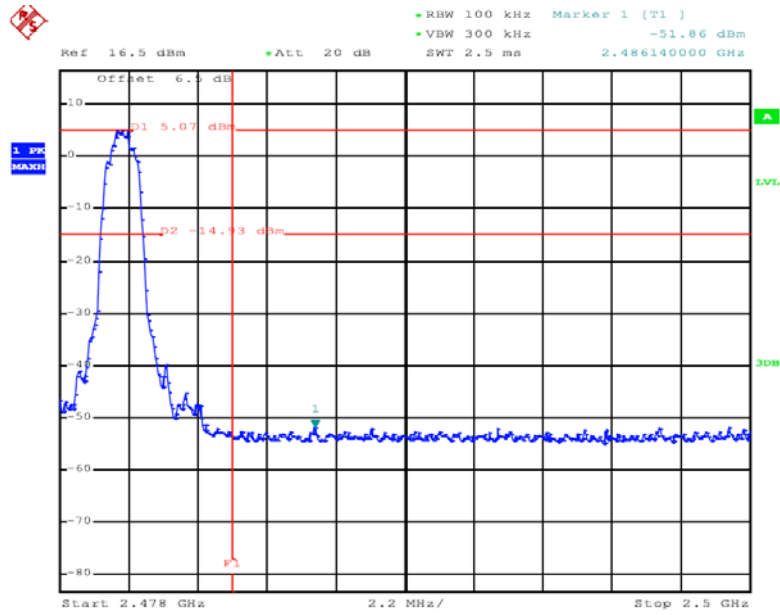

For Hopping Mode:

GFSK

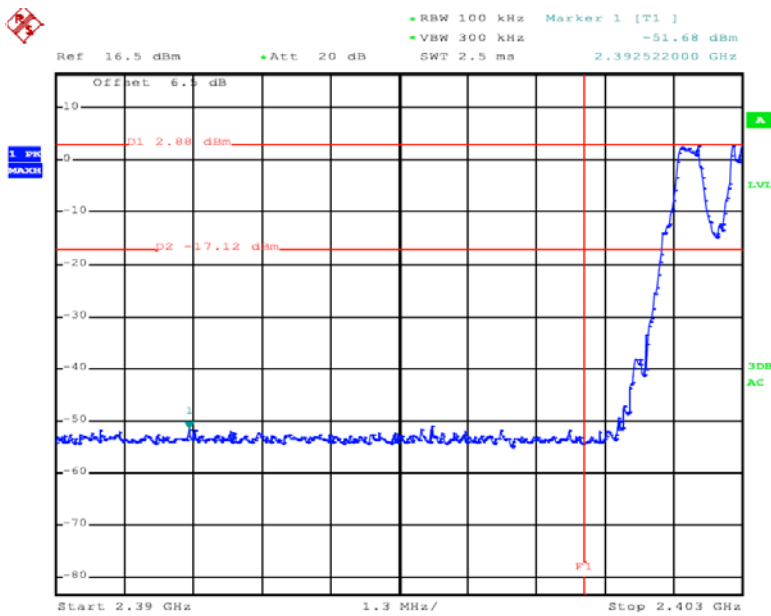

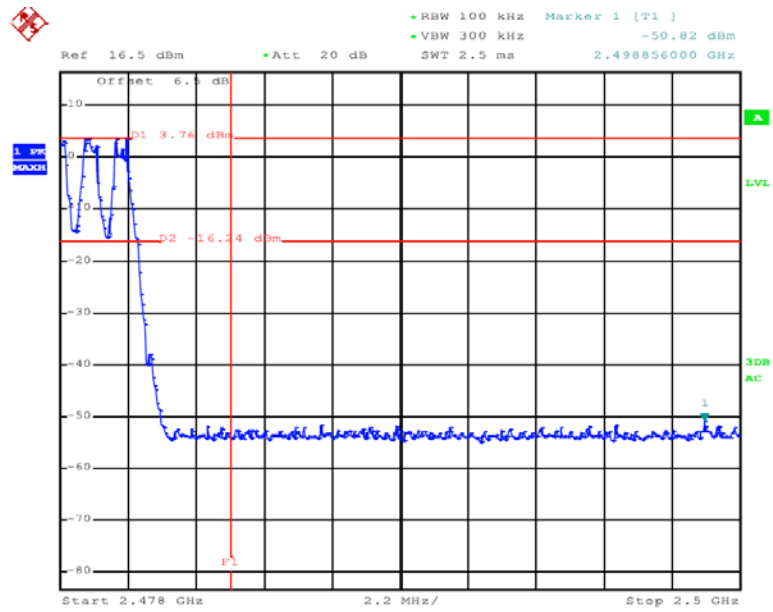

$\pi/4$ -DQPSK

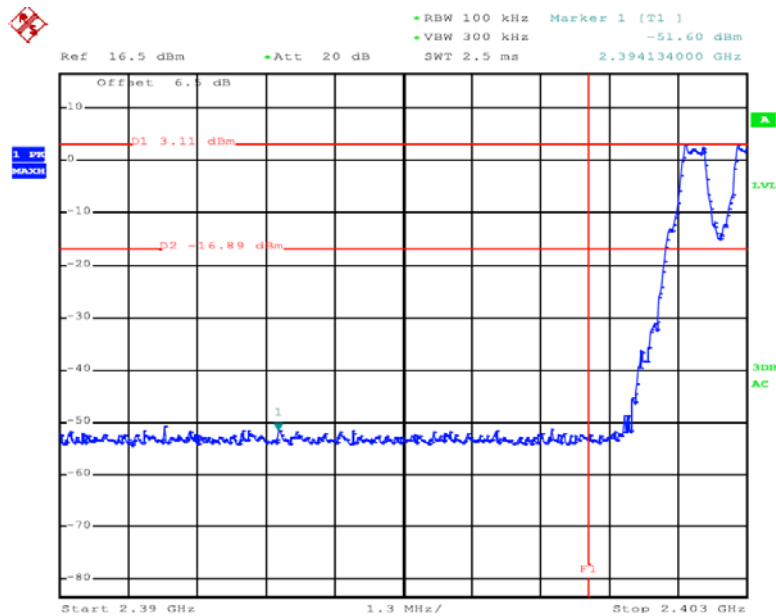

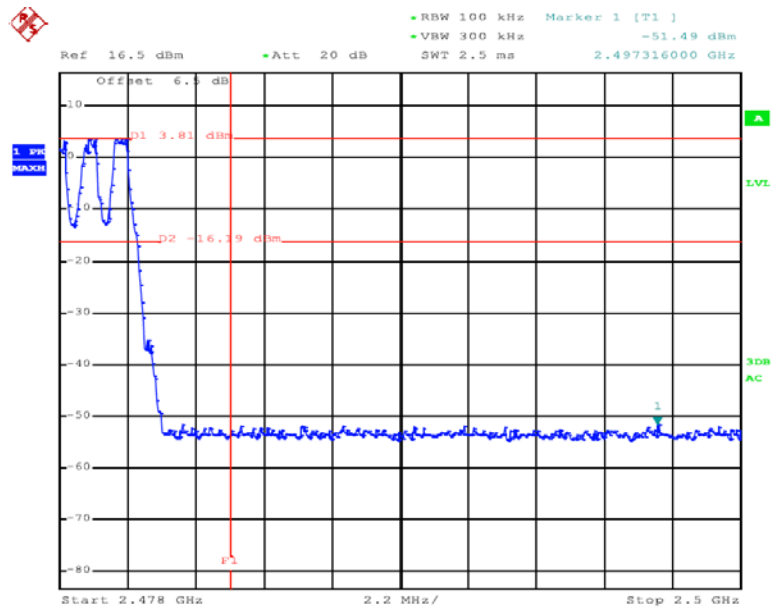

8DPSK

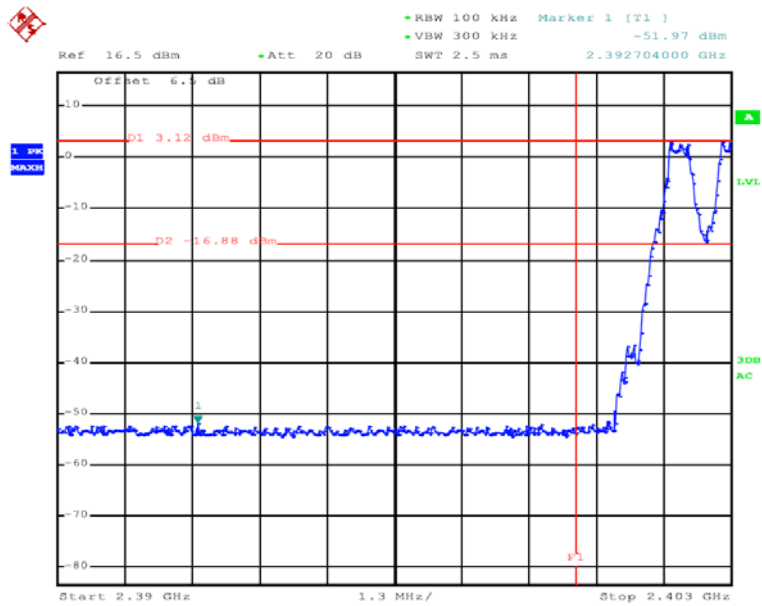

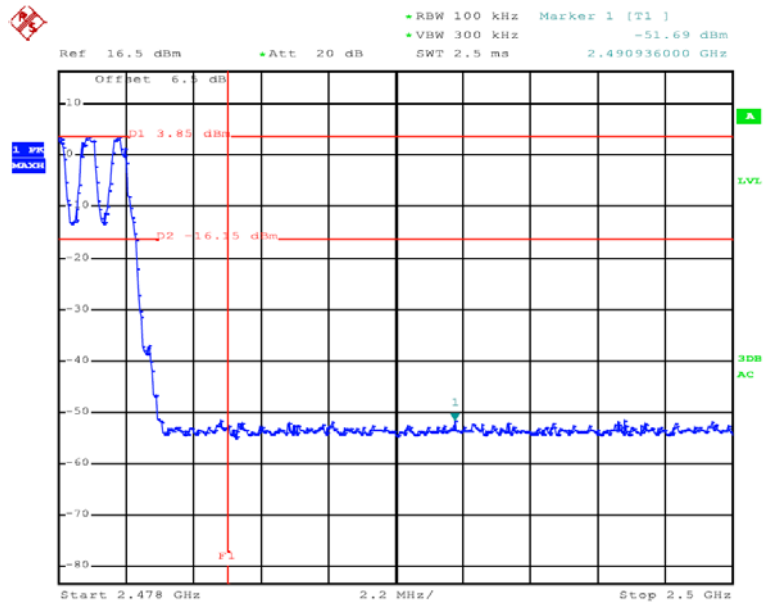



9 20 dB Bandwidth Measurement

Test Requirement : FCC CFR47 Part 15 Section 15.247

Test Method : ANSI C63.10:2013

9.1 Test Procedure

1. Remove the antenna from the EUT and then connect a low RF cable from the antenna port to the spectrum;
2. Set the spectrum analyzer: RBW =30kHz, VBW = 100kHz

9.2 Test Result

Test Mode: CH00 / CH39 / CH78 (GFSK/(1Mbps)Mode)

Channel number	Channel frequency (MHz)	20dB Down BW(kHz)
00	2402	932
39	2441	944
78	2480	944

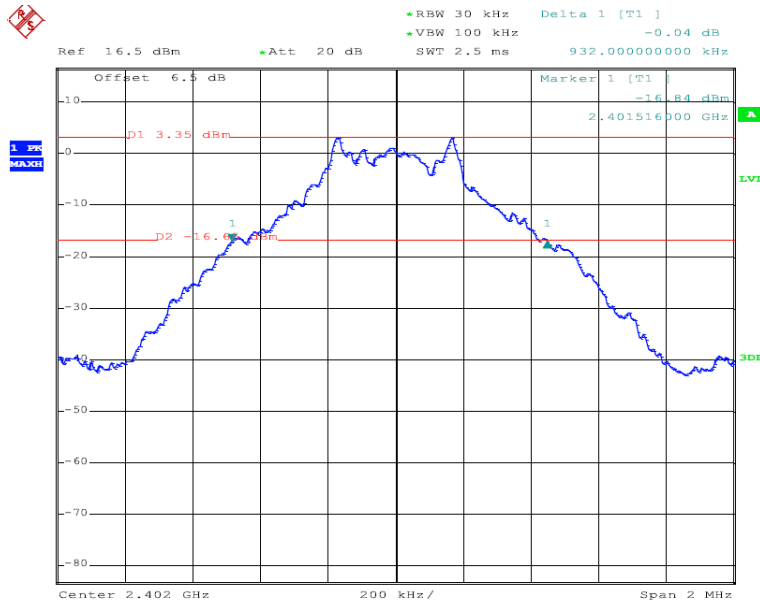

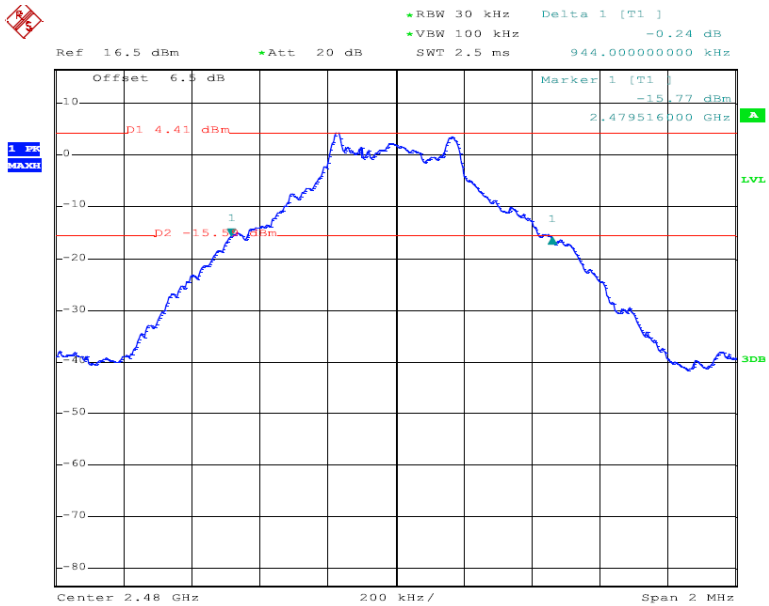
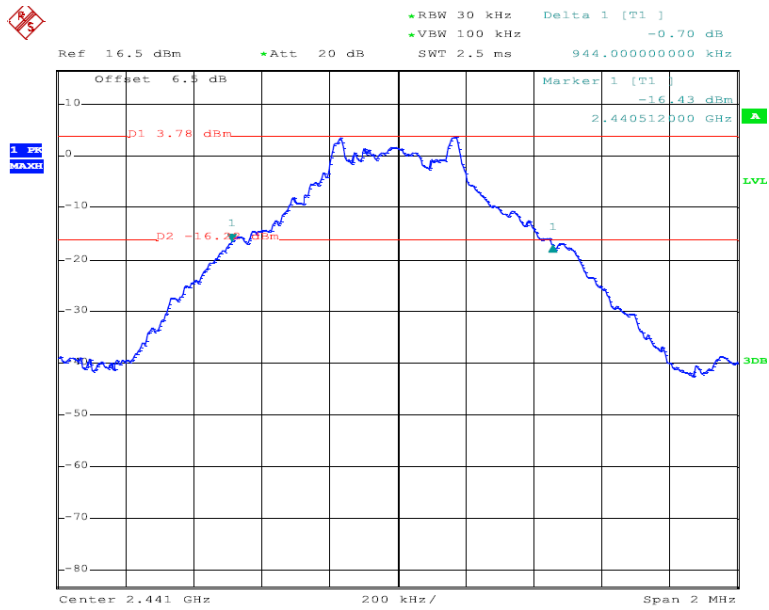



Test Mode: CH00 / CH39 / CH78 (Π/4-DQPSK /(2Mbps)Mode)

Channel number	Channel frequency (MHz)	20dB Down BW(kHz)
00	2402	1220
39	2441	1220
78	2480	1228

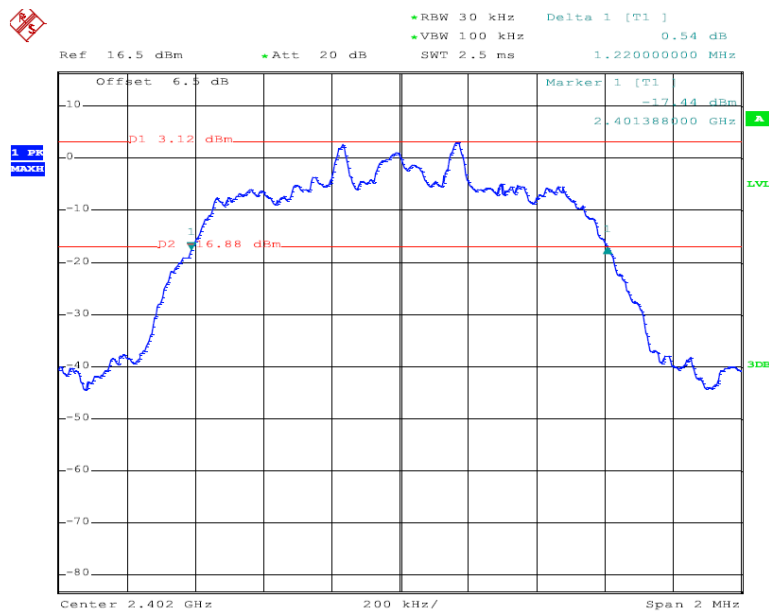

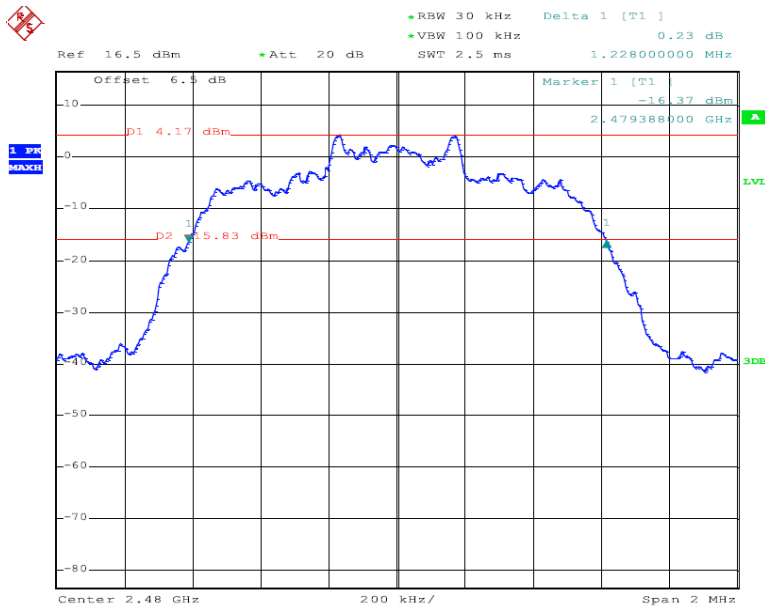
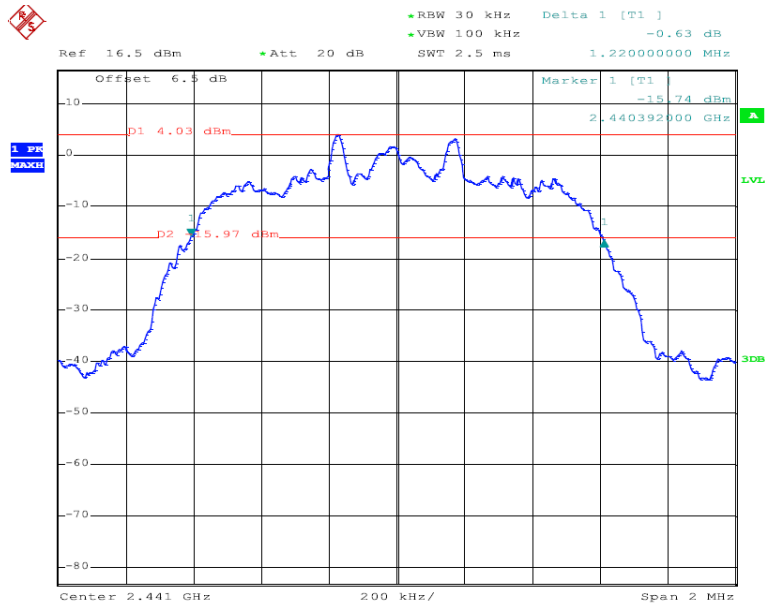



Test Mode: CH00 / CH39 / CH78 (8DPSK(3Mbps)Mode)

Channel number	Channel frequency (MHz)	20dB Down BW(kHz)
00	2402	1260
39	2441	1264
78	2480	1272

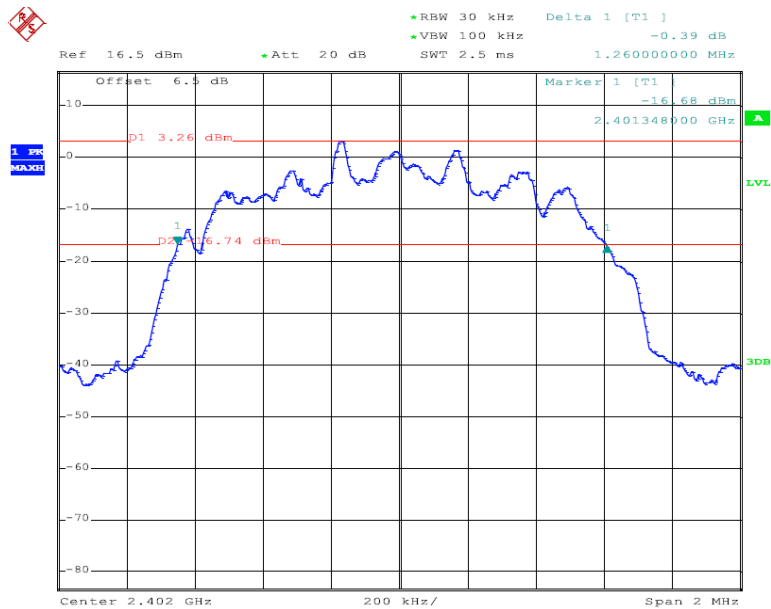

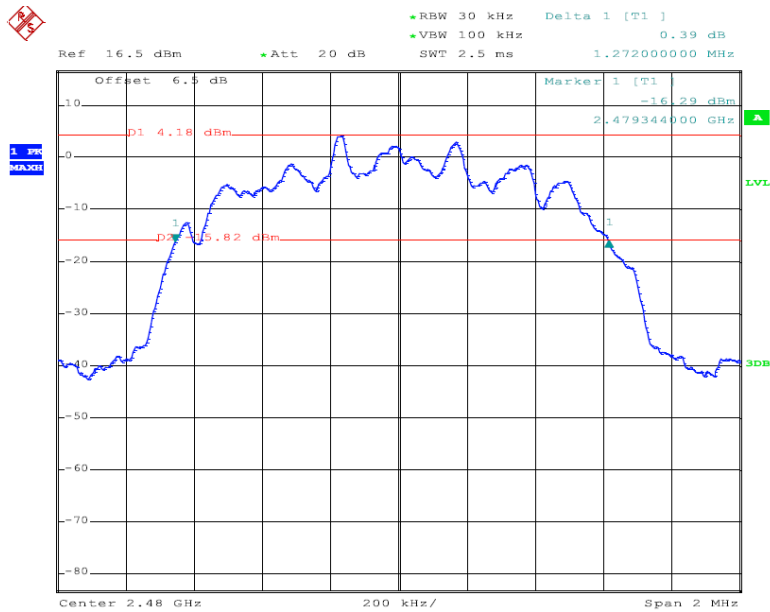
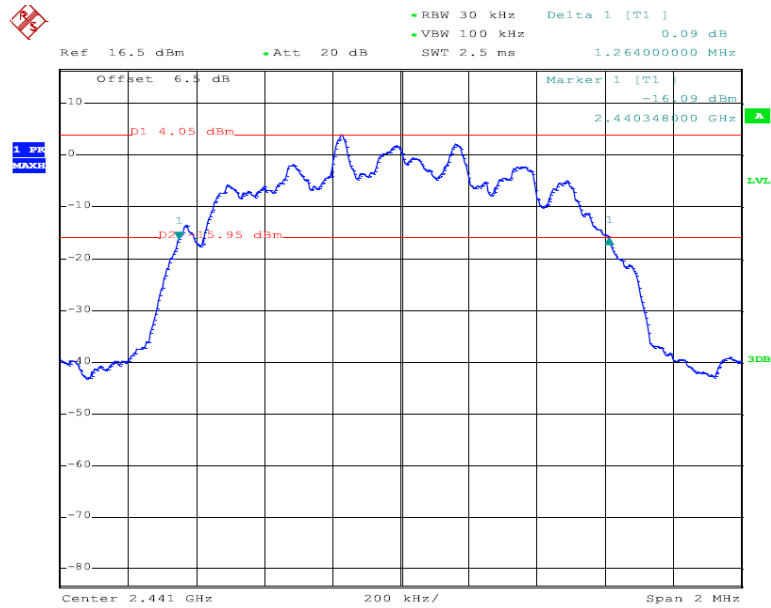



10 Maximum Peak Output Power

Test Requirement : FCC CFR47 Part 15 Section 15.247

Test Method : ANSI C63.10:2013

Test Limit : Regulation 15.247 (b)(1), For frequency hopping systems operating in the 2400-2483.5 MHz band employing at least 75 non-overlapping hopping channels, and all frequency hopping systems in the 5725-5850 MHz band: 1 watt (30dBm). For all other frequency hopping systems in the 2400-2483.5 MHz band: 0.125 watts.

Refer to the result "Number of Hopping Frequency" of this document. The 0.125watts (20.97 dBm) limit applies.

10.1 Test Procedure

1. Remove the antenna from the EUT and then connect a low RF cable from the antenna port to the spectrum.
2. Set the spectrum analyser: RBW = 3 MHz. VBW =10 MHz. Sweep = auto; Detector Function = Peak.
3. Keep the EUT in transmitting at lowest, medium and highest channel individually. Record the max value.

10.2 Test Result

GFSK(1Mbps)					
Test Channel	Frequency	Conducted Output Peak Power	Conducted Output Peak Power	LIMIT	Pass/Fail
	(MHz)	(dBm)	(W)	(W)	
CH00	2402	4.54	0.00284	1	Pass
CH39	2441	5.21	0.00332	1	Pass
CH78	2480	5.60	0.00363	1	Pass

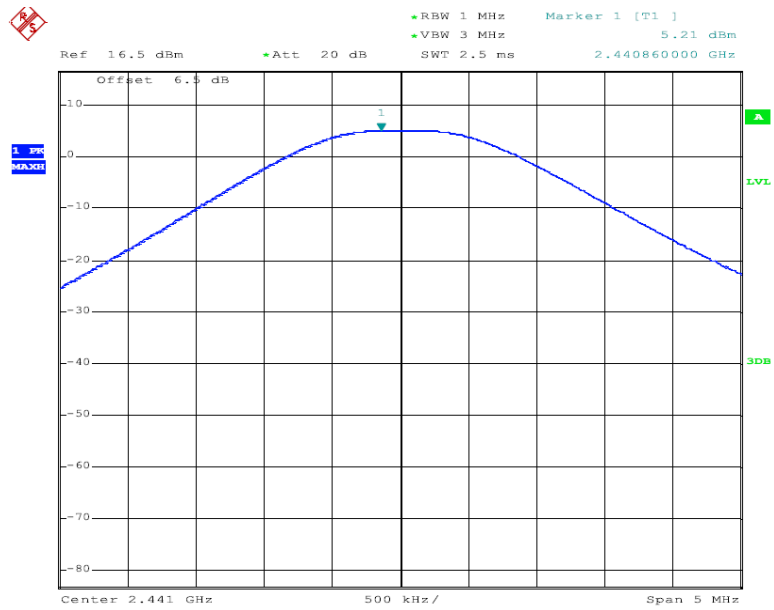
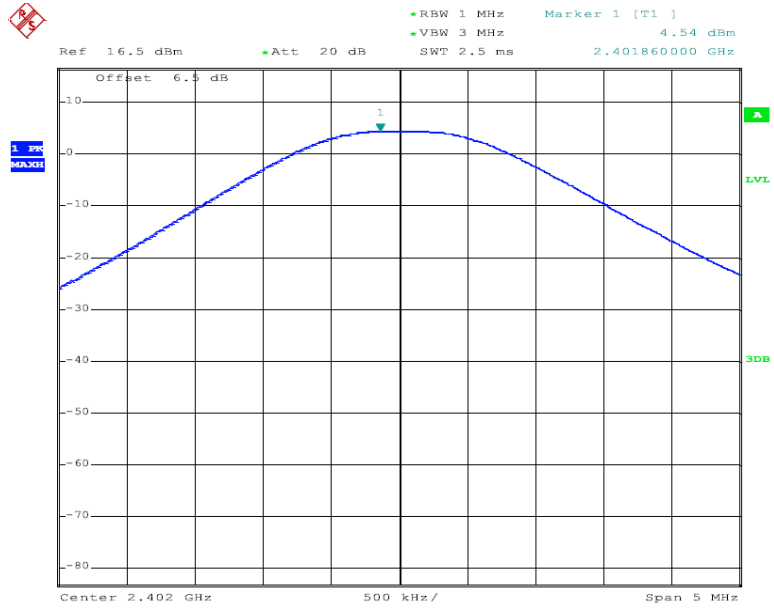

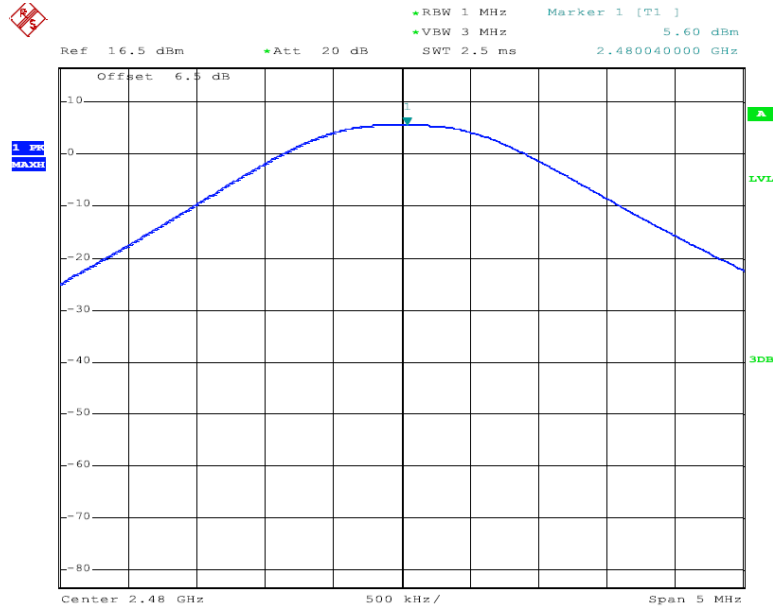

π/4QPSK(2Mbps)					
Test Channel	Frequency	Conducted Output Peak Power	Conducted Output Peak Power	LIMIT	Pass/Fail
	(MHz)	(dBm)	(W)	(W)	
CH00	2402	5.82	0.00382	0.125	Pass
CH39	2441	6.52	0.00449	0.125	Pass
CH78	2480	6.92	0.00492	0.125	Pass

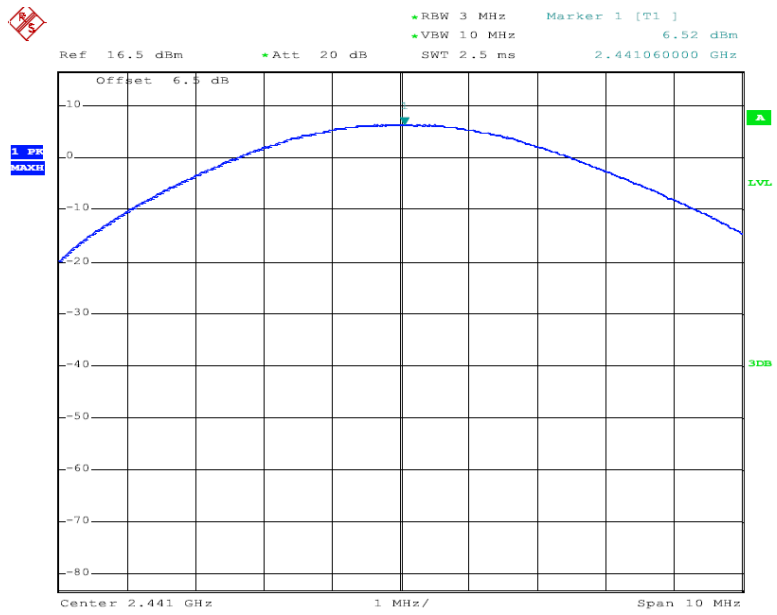
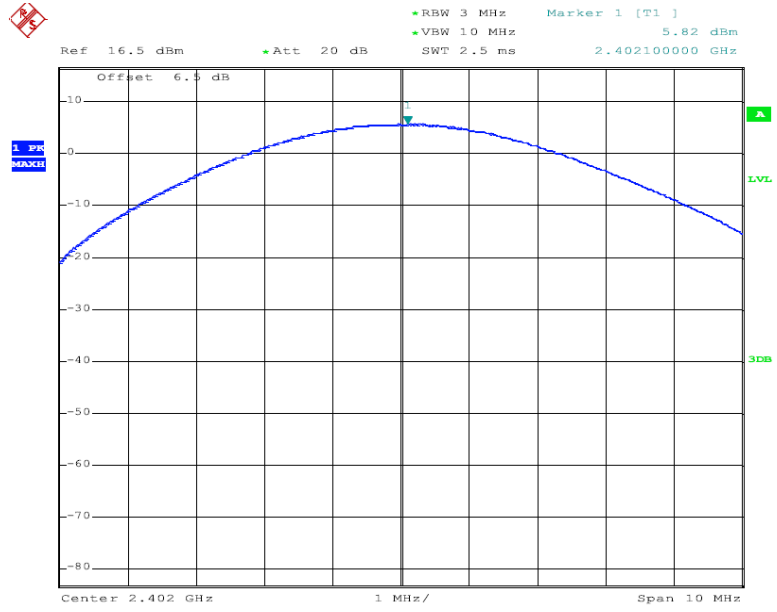

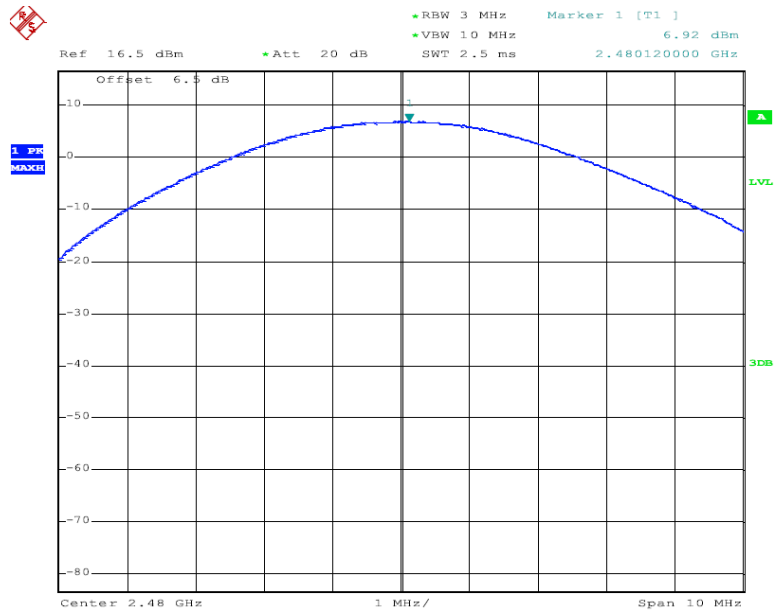

8DPSK(3Mbps)					
Test Channel	Frequency	Conducted Output Peak Power	Conducted Output Peak Power	LIMIT	Pass/Fail
	(MHz)	(dBm)	(W)	(W)	
CH00	2402	6.21	0.00418	0.125	Pass
CH39	2441	6.86	0.00485	0.125	Pass
CH78	2480	7.31	0.00538	0.125	Pass

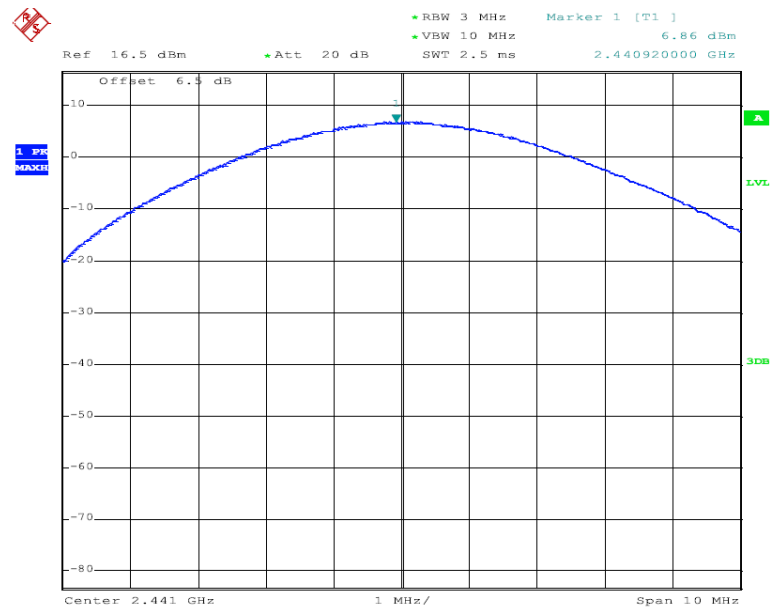
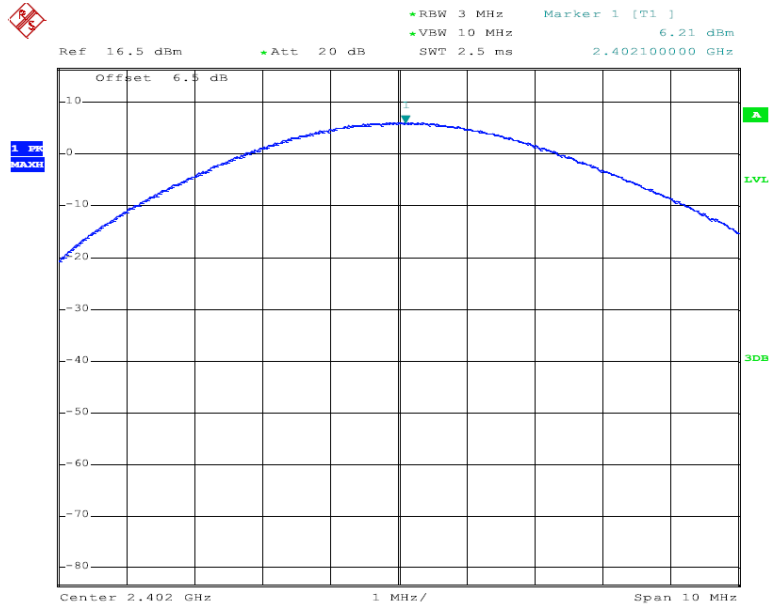

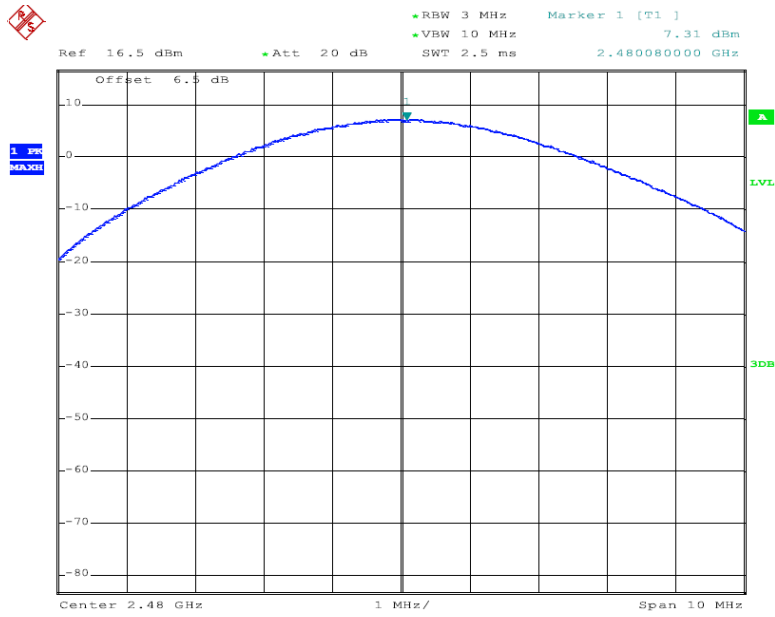



11 Hopping Channel Separation

Test Requirement	: FCC CFR47 Part 15 Section 15.247
Test Method	: ANSI C63.10:2013
Test Limit	: Regulation 15.247(a)(1) Frequency hopping systems shall have hopping channel carrier frequencies separated by a minimum of 25 kHz or the 20 dB bandwidth of the hopping channel, whichever is greater. Alternatively, frequency hopping systems operating in the 2400-2483.5MHz band may have hopping channel carrier frequencies that are separated by 25 kHz or two-thirds of the 20 dB bandwidth of the hopping channel, whichever is greater, provided the systems operate with an output power no greater than 1W.
Test Mode	: Hopping

11.1 Test Procedure

1. Remove the antenna from the EUT and then connect a low RF cable from the antenna port to the spectrum.
2. Set the spectrum analyzer: RBW = 100KHz. VBW = 300KHz, Span = 2.0MHz. Sweep = auto; Detector Function = Peak. Trace = Max hold.
3. Allow the trace to stabilize. Use the marker-delta function to determine the separation between the peaks of the adjacent channels. The limit is specified in one of the subparagraphs of this Section Submit this plot.

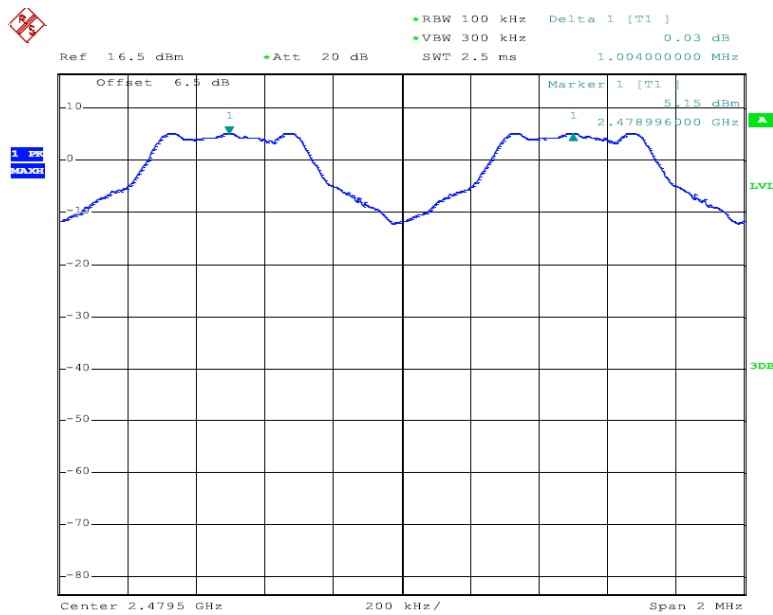
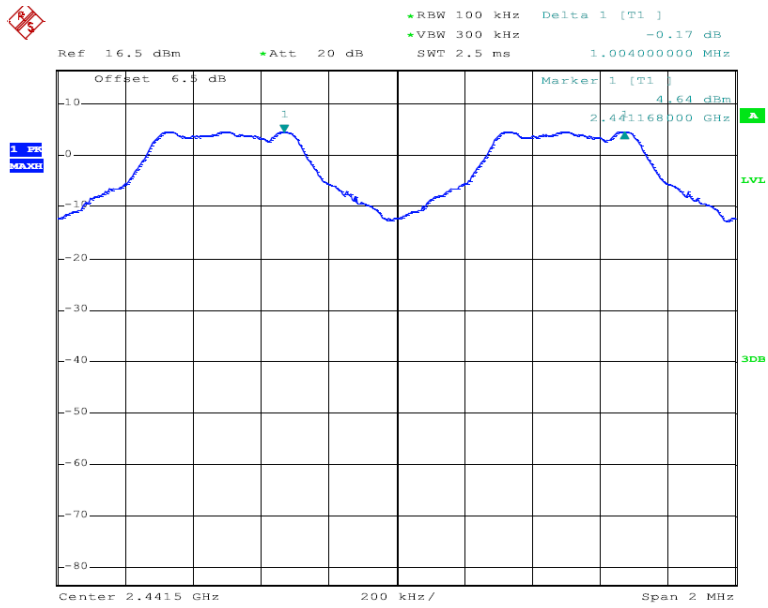



Test Mode:	CH00 / CH39 / CH78 ($\pi/4$ -DQPSK(2Mbps) Mode)
------------	--

Channel number	Channel frequency (MHz)	Separation Read Value (kHz)	Separation Limit 2/3 20dB Down BW(kHz)
00	2402	1004	>818.67
39	2441	1004	>818.67
78	2480	1004	>818.67

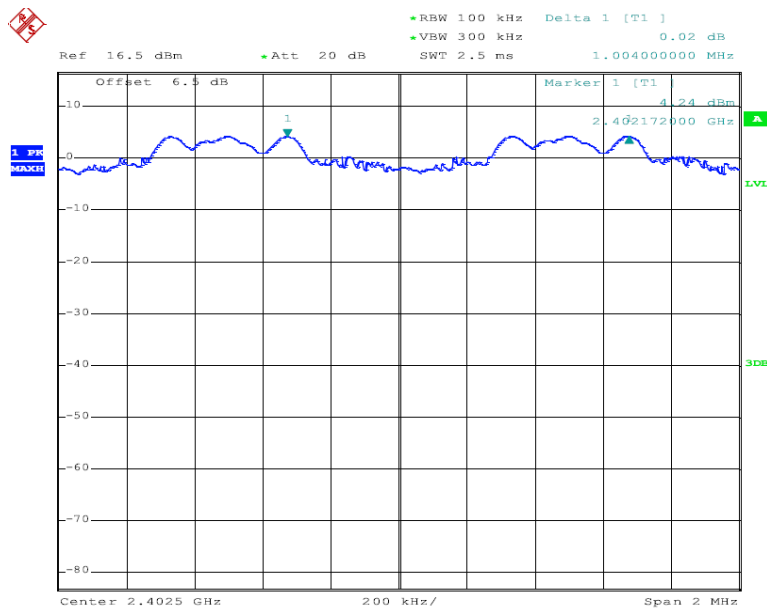

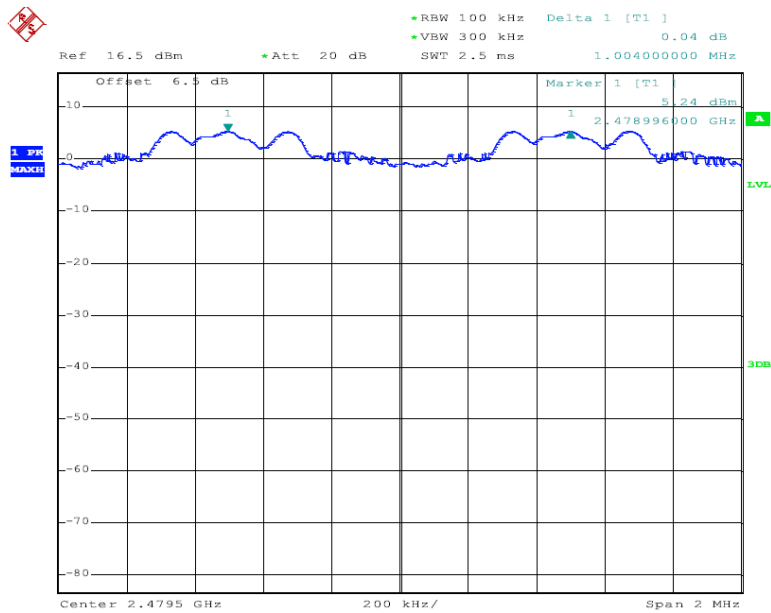
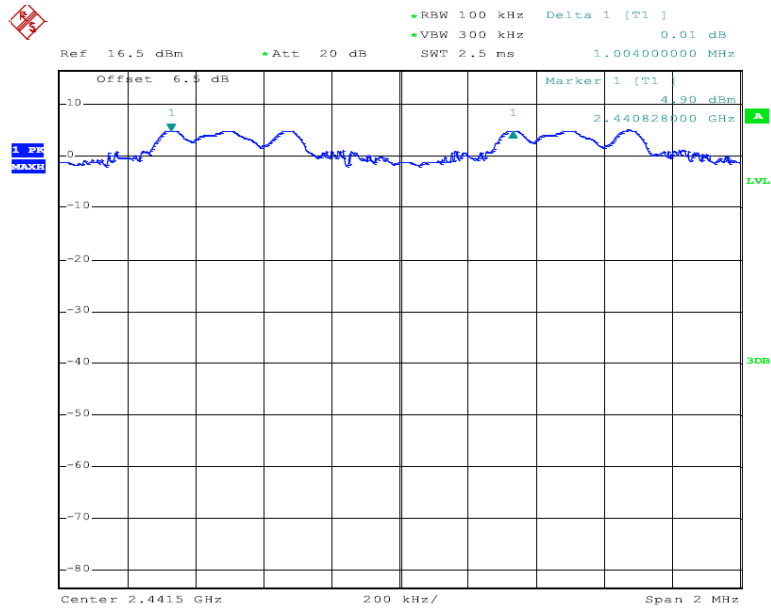



Test Mode:	CH00 / CH39 / CH78 (8DPSK(3Mbps)Mode)
------------	---------------------------------------

Channel number	Channel frequency (MHz)	Separation Read Value (kHz)	Separation Limit 2/3 20dB Down BW(kHz)
00	2402	1004	>848
39	2441	1004	>848
78	2480	1004	>848

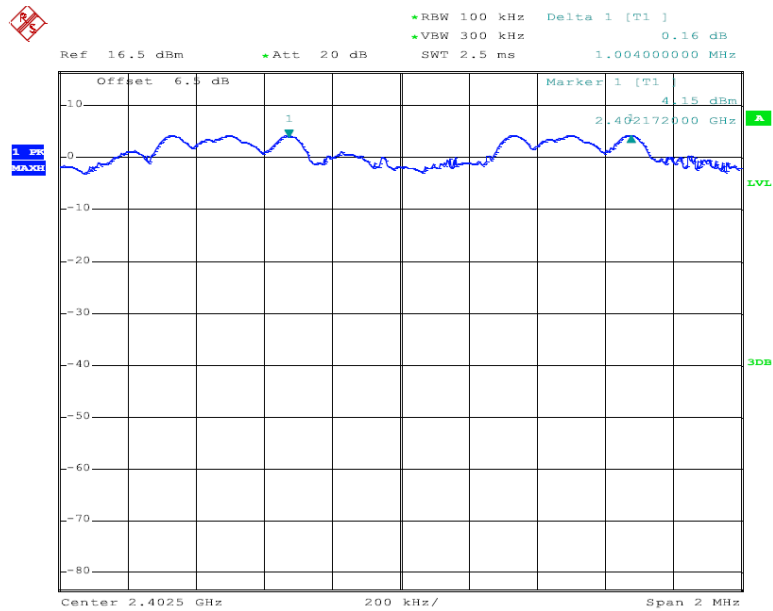

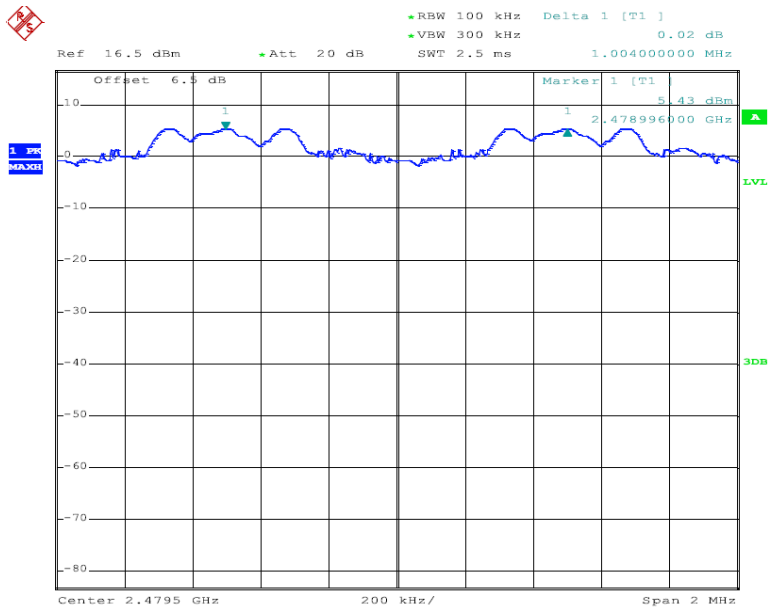
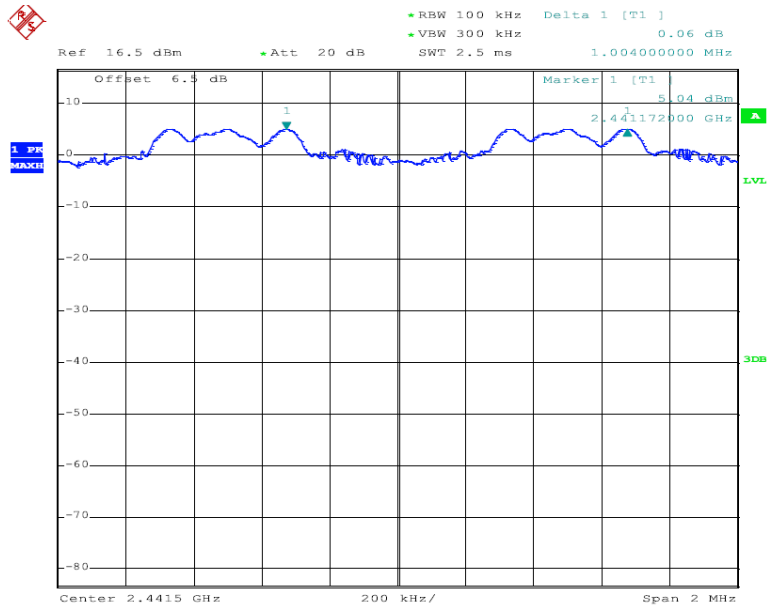



12 Number of Hopping Frequency

- Test Requirement : FCC CFR47 Part 15 Section 15.247
- Test Method : ANSI C63.10:2013
- Test Limit : Regulation 15.247 (a)(1)(iii) Frequency hopping systems in the 2400-2483.5 MHz band shall use at least 15 channels.
- Test Mode : Hopping(GFSK)

12.1 Test Procedure

1. Remove the antenna from the EUT and then connect a low RF cable from the antenna port to the spectrum.
2. Set the spectrum analyzer: RBW = 100KHz. VBW = 300KHz. Sweep = auto; Detector Function = Peak. Trace = Max hold.
3. Allow the trace to stabilize. It may prove necessary to break the span up to sections. in order to clearly show all of the hopping frequencies. The limit is specified in one of the subparagraphs of this Section.
4. Set the spectrum analyzer: Start Frequency = 2.4GHz, Stop Frequency = 2.483GHz. Sweep=auto;

12.2 Test Result

Channel Number	Limit
79	≥15

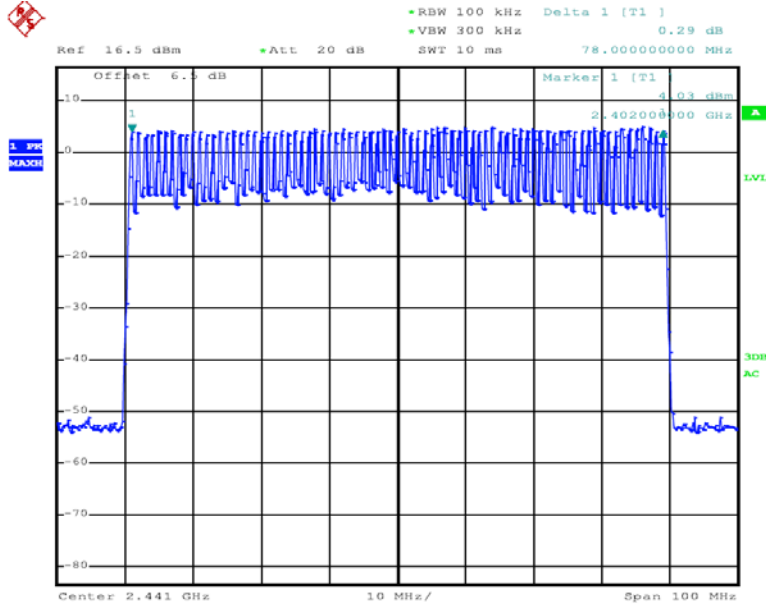



13 Dwell Time

- Test Requirement : FCC CFR47 Part 15 Section 15.247
- Test Method : ANSI C63.10:2013
- Test Limit : Regulation 15.247(a)(1)(iii) Frequency hopping systems in the 2400-2483.5 MHz band shall use at least 15 channels. The average time of occupancy on any channel shall not be greater than 0.4 seconds within a period of 0.4 seconds multiplied by the number of hopping channels employed.
- Test Mode : The worst case($\pi/4$ -DQPSK) was recorded

13.1 Test Procedure

1. Remove the antenna from the EUT and then connect a low RF cable from the antenna port to the spectrum.
2. Set spectrum analyzer span = 0. Centred on a hopping channel;
3. Set RBW = 1MHz and VBW = 3MHz. Sweep = as necessary to capture the entire dwell time per hopping channel. Set the EUT for DH5, DH3 and DH1 packet transmitting.
4. Use the marker-delta function to determine the dwell time. If this value varies with different modes of operation (e.g.. data rate. modulation format. etc.). repeat this test for each variation. The limit is specified in one of the subparagraphs of this Section. Submit this plot(s).

13.2 Test Result

Test Mode:	$\pi/4$ -DQPSK(2Mbps) –2DH1/2DH3/2DH5
------------	---------------------------------------

Mode	Number of transmission in a 31.6(79 Hopping*0.4)	Length of transmissions time(msec)	Result (msec)	Limit (msec)
2DH1	$1600/(2*79) \times 31.6 = 320$	0.400	128.0	400
2DH3	$1600/(4*79) \times 31.6 = 160$	1.662	266	400
2DH5	$1600/(6*79) \times 31.6 = 106.67$	2.930	313	400

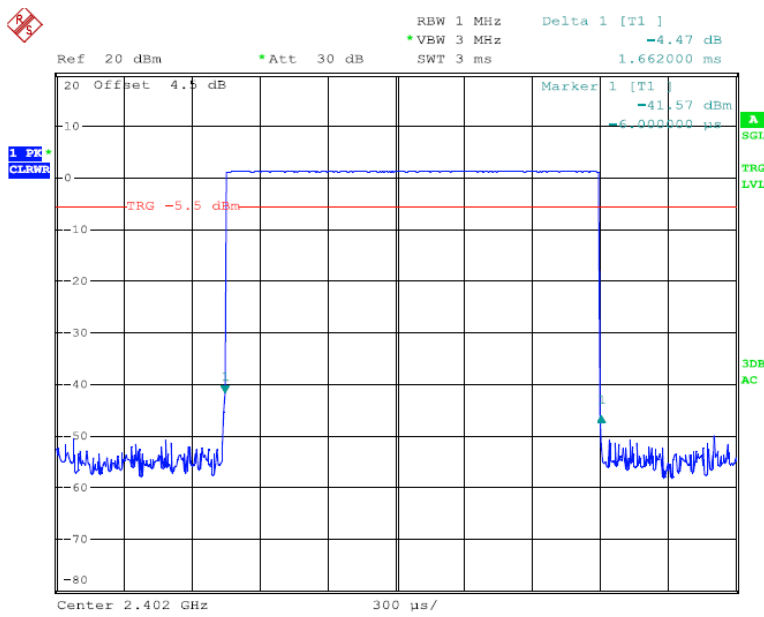
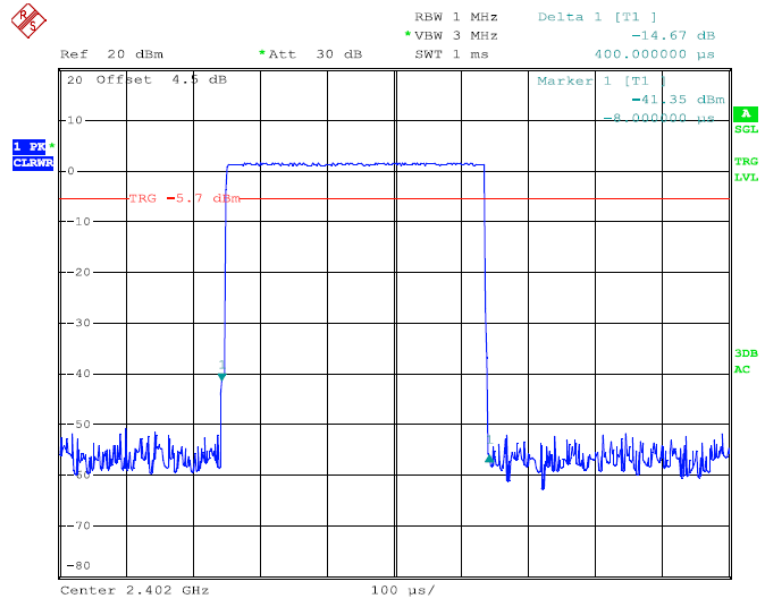

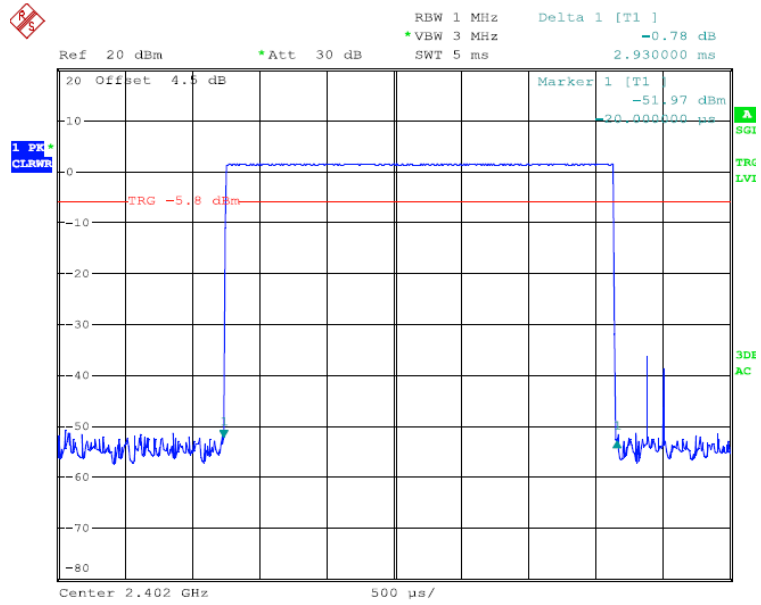



14 Antenna Requirement

14.1 Antenna Requirement

For intentional device, according to FCC 47 CFR Section 15.203, an intentional radiator shall be designed to ensure that no antenna other than that furnished by the responsible party shall be used with the device. And according to FCC 47 CFR Section 15.247 (b), if transmitting antennas of directional gain greater than 6dBi are used, the power shall be reduced by the amount in dB that the directional gain of the antenna exceeds 6dBi.

14.2 Result

The EUT'S antenna, permanent attached antenna, is Internal PCB Antenna. The antenna's gain is 1.2dBi and meets the requirement.



15 TEST PHOTOS

Conducted Emissions



Radiated Spurious Emissions
Test Frequency From 30MHz-1000MHz





Test frequency from 1GHz-18GHz

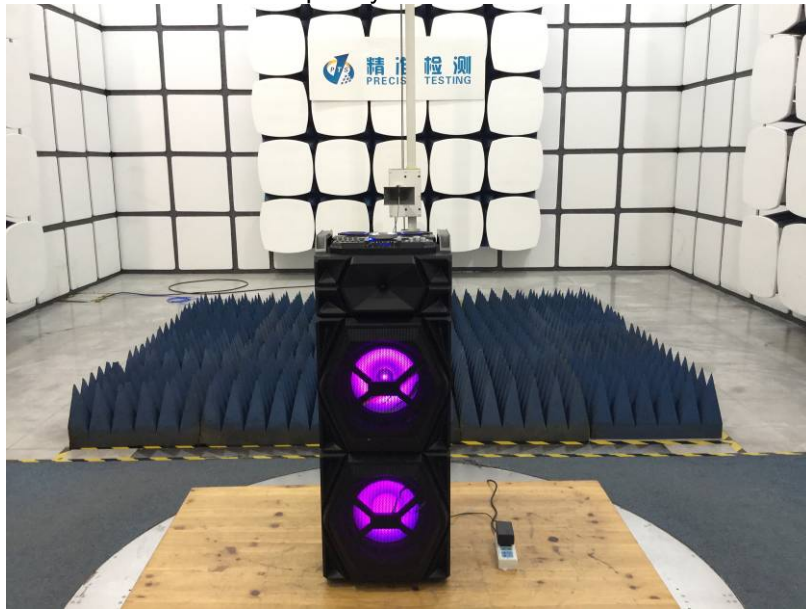

Test frequency from 18GHz-25GHz

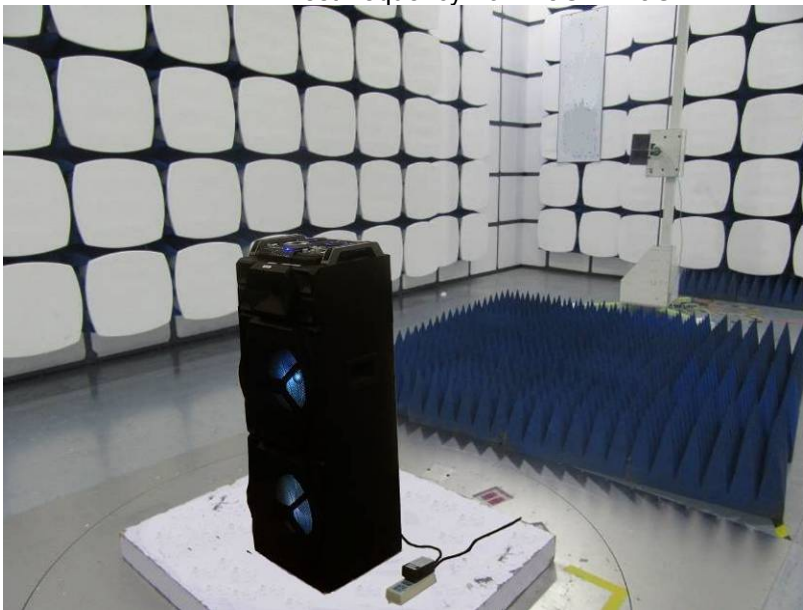



16 EUT PHOTOS



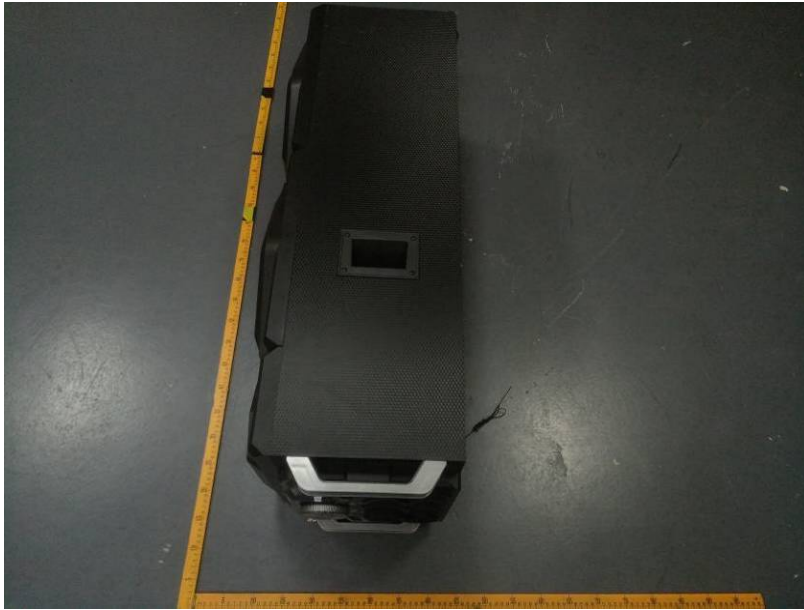







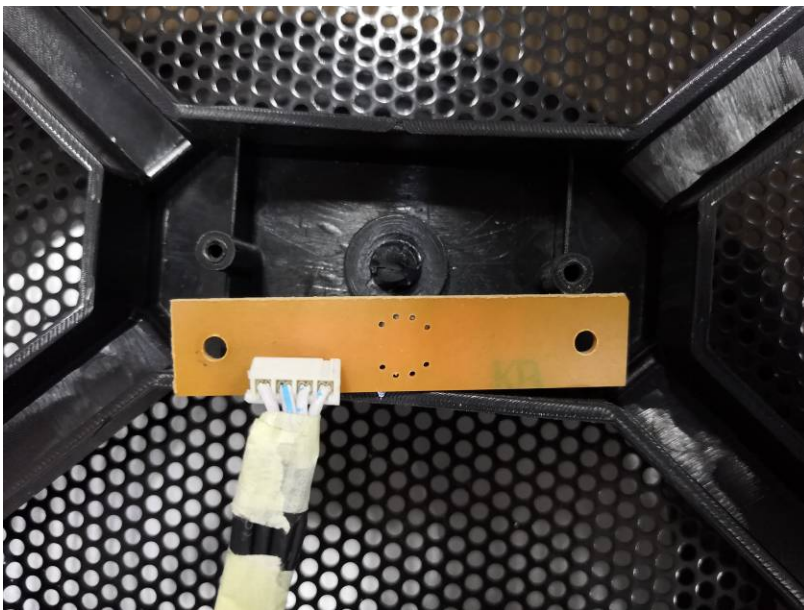
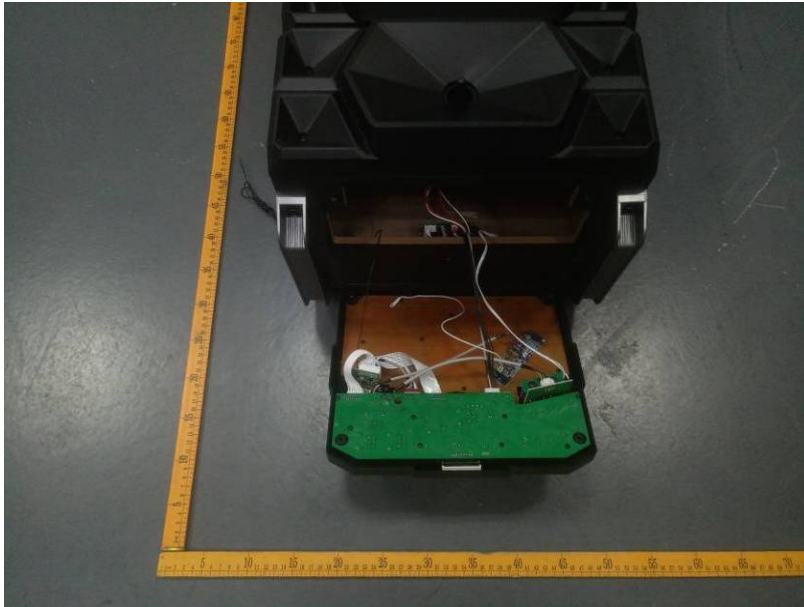

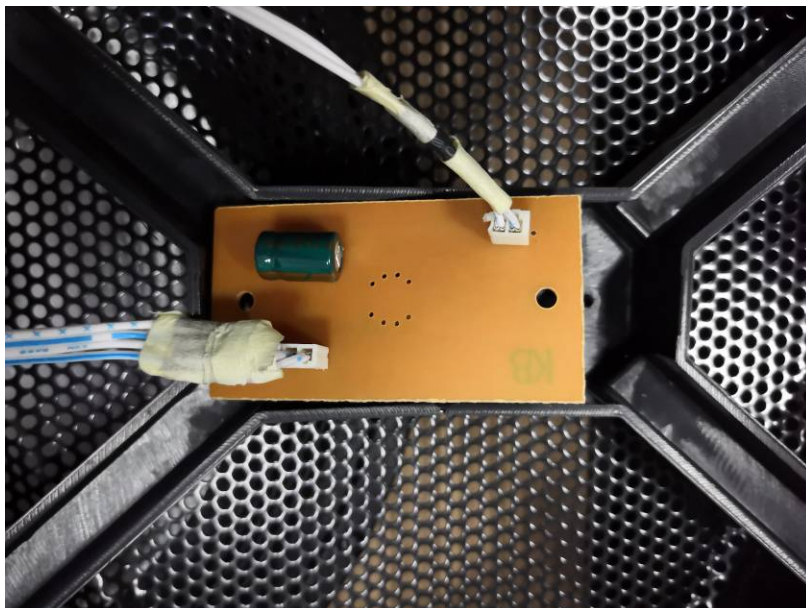

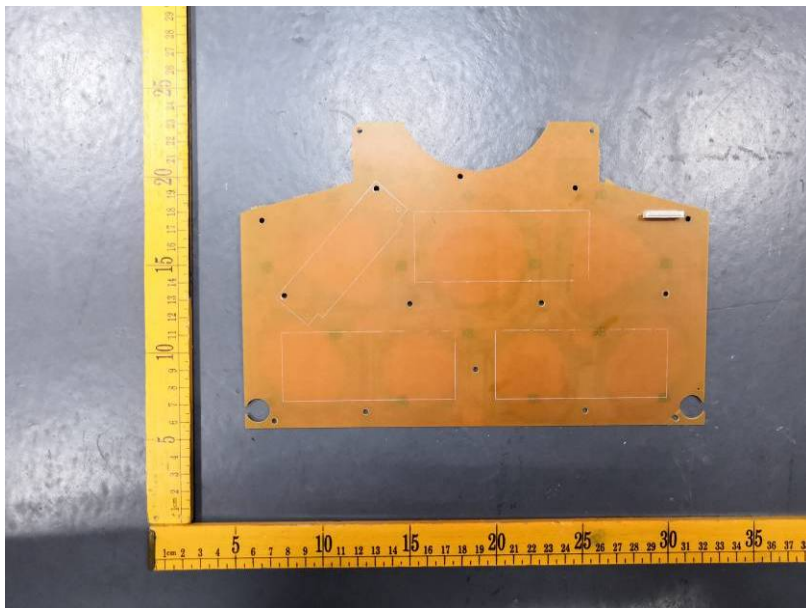
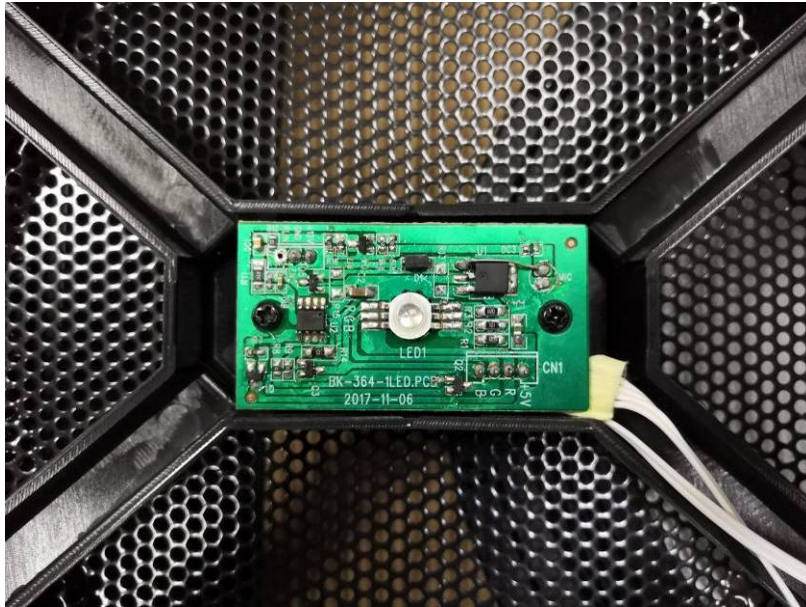

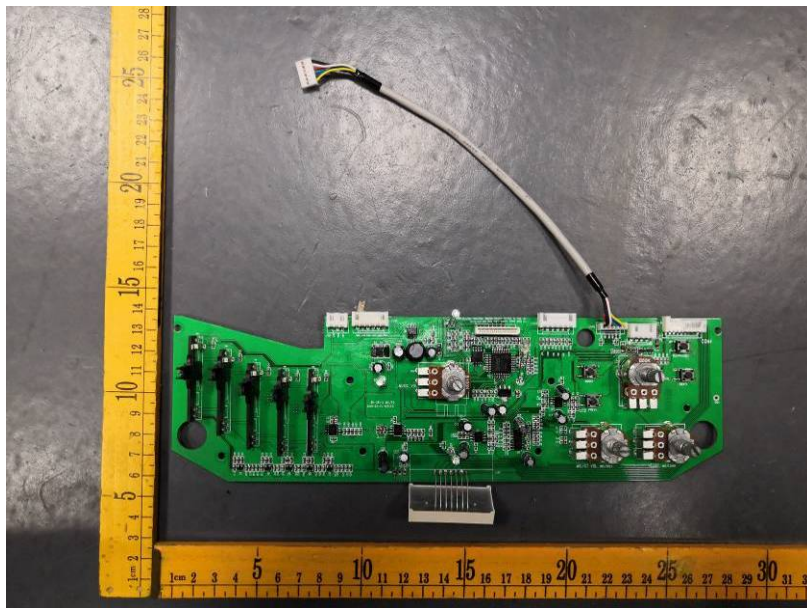
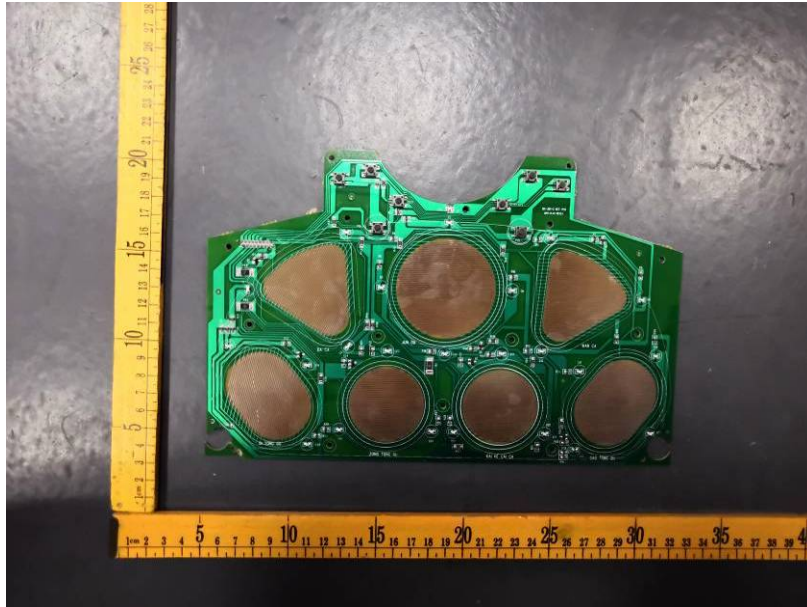

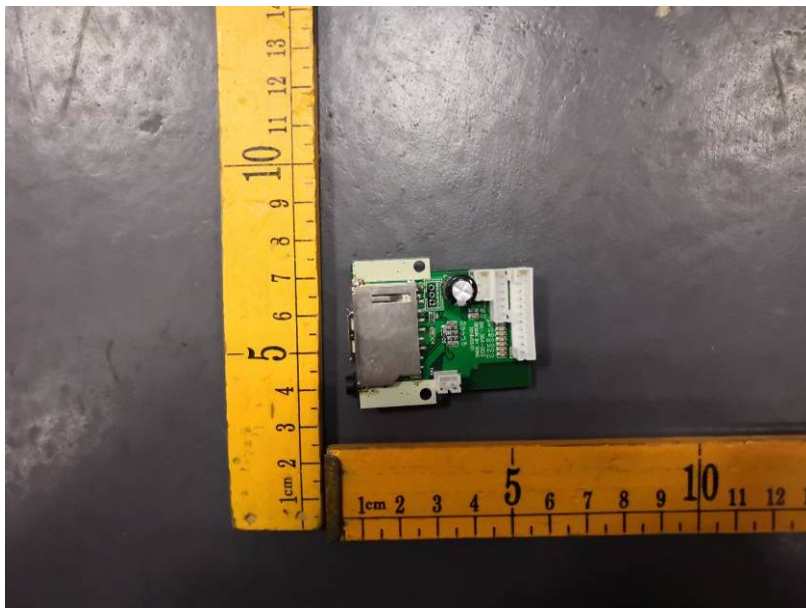
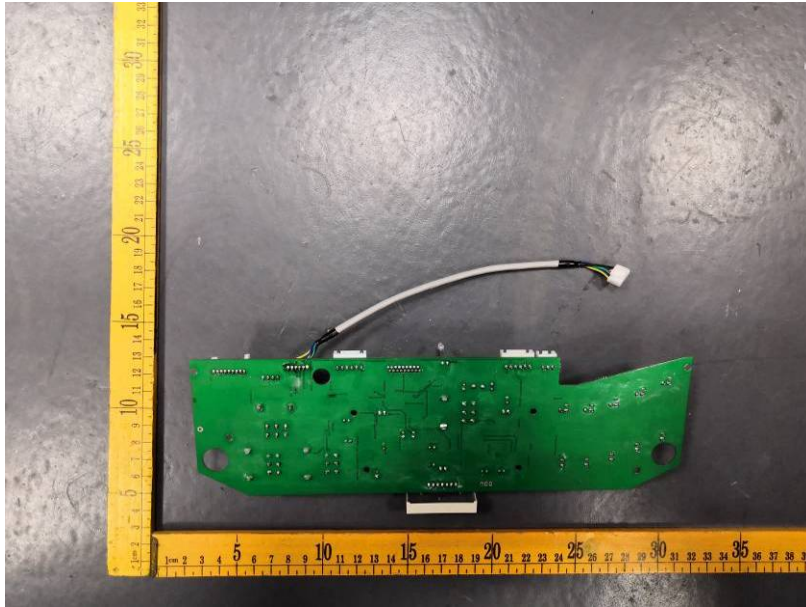

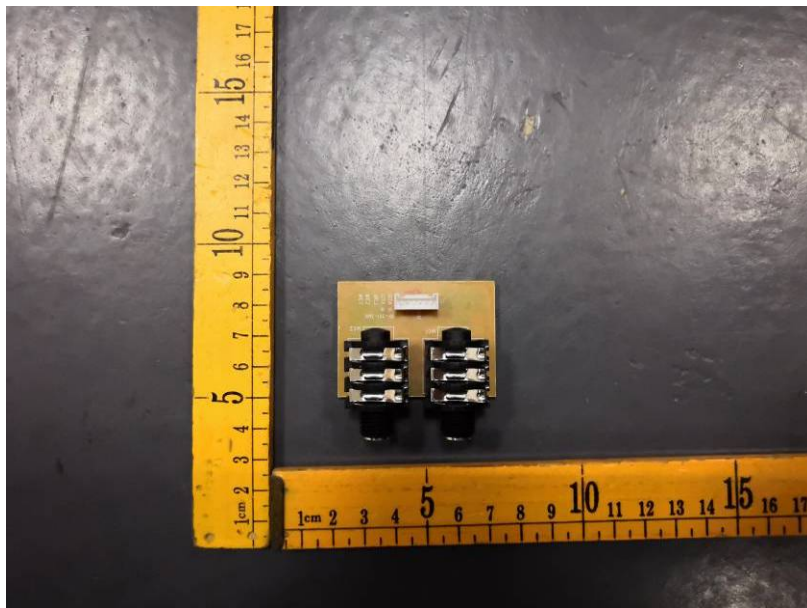
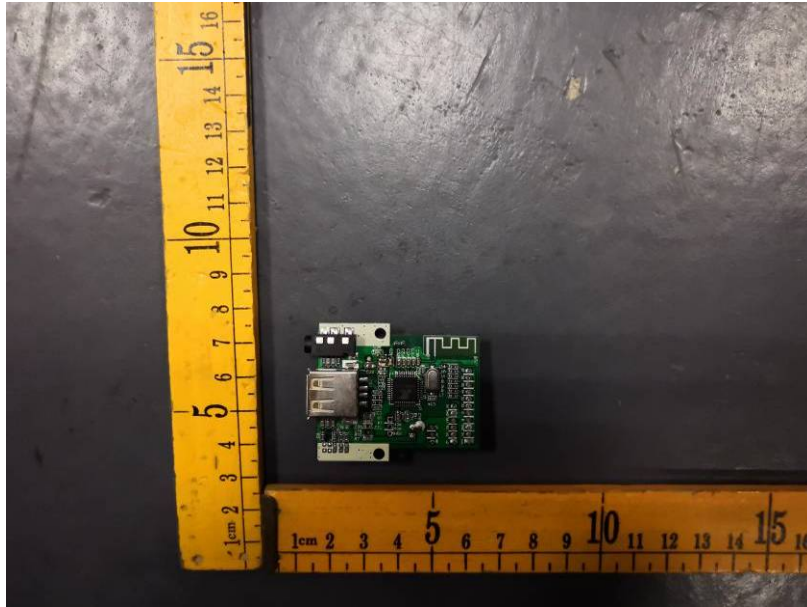

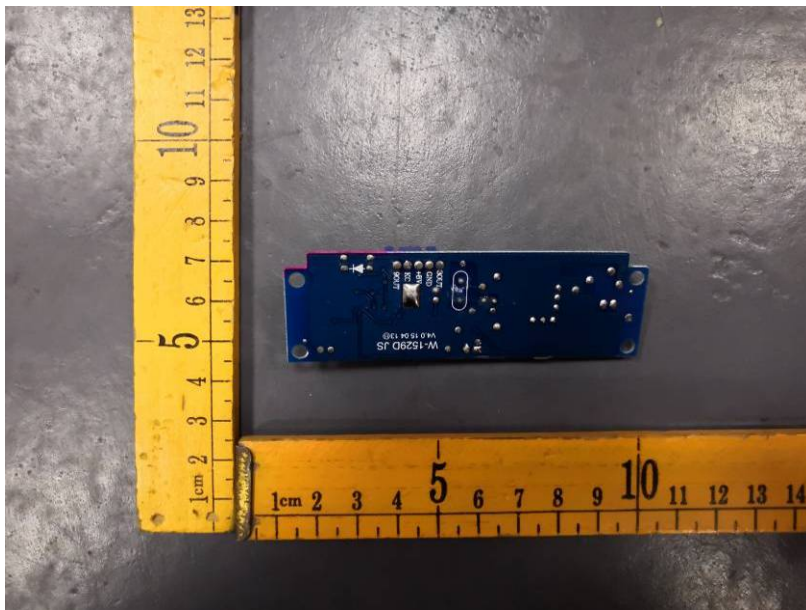
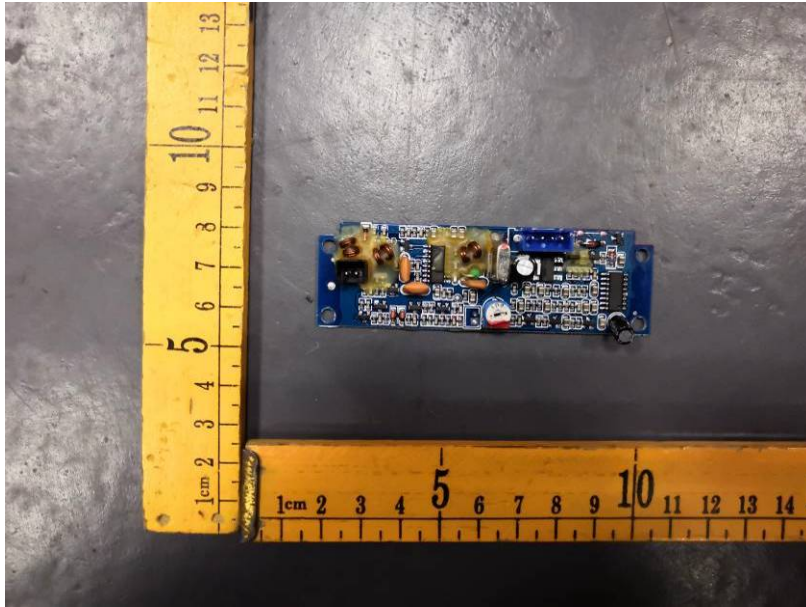

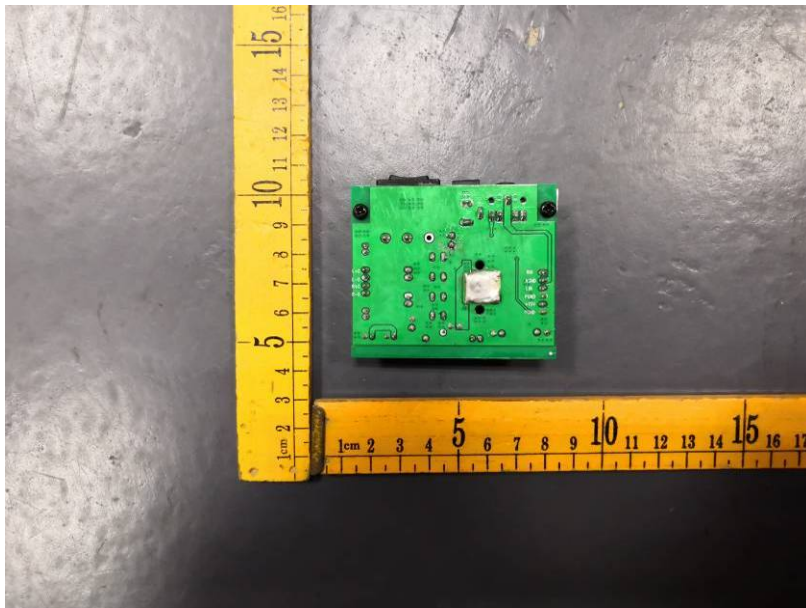
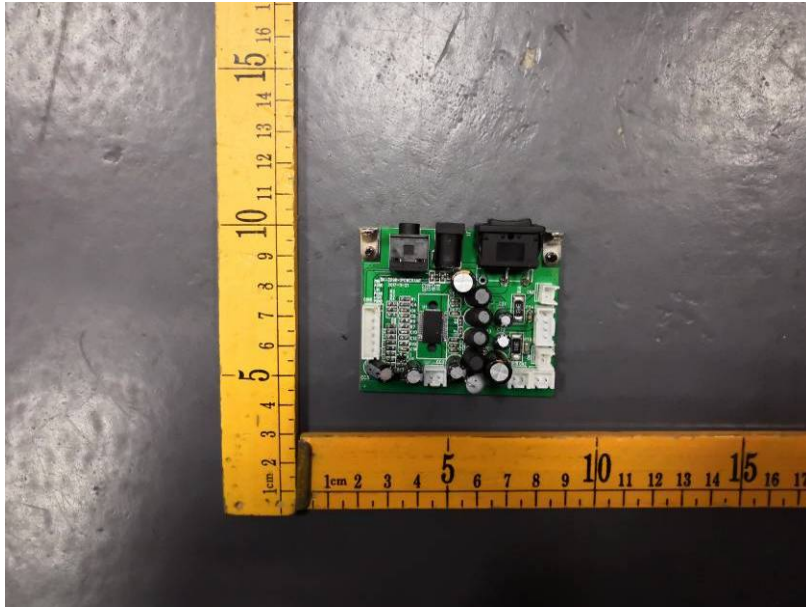

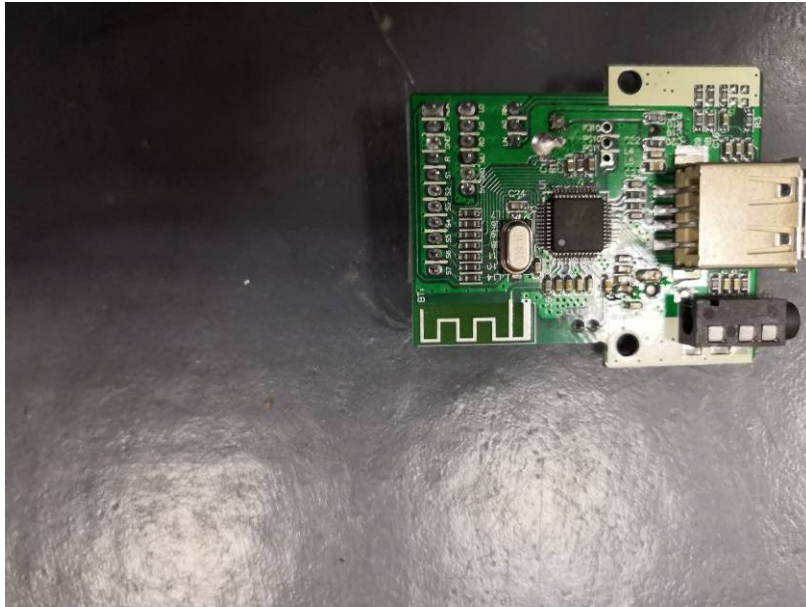



*****THE END REPORT*****