

Ke Mei Ou Laboratory Co., Ltd.

7A, Jiexiangge, JiahuiXincheng, No.3027, Shennan Rd., Futian,
Shenzhen, Guangdong, P.R.China. Zip Code: 518033
Tel: + 86 755 83642690 Fax: + 86 755 83297077
www.kmolab.com

FCC TEST REPORT

Under
FCC 15 Subpart C, Paragraph 15.247

Operating in 2400 ~ 2483.5 MHz Band

Prepared For :

Shanghai DareGlobal Technologies Co.,Ltd.

22F,Info Tech Building,No.1555,Kongjiang Road,Shanghai

FCC ID: RS36519A1A2
EUT: ADSL2+ 4 Port Router WIFI 802.11B/G/N 2X2
Model: 6519-A1-NA
August 26, 2011 Issue Date:
Original Report Report Type:
<i>Eric guo</i> Test Engineer: Eric guo
 Review By: Apollo Liu / Manager

The test report consists 57 pages in total. It may be duplicated completely for legal use with the allowance of the applicant. It shall not be reproduced except in full, without the written approval of Ke Mei Ou Laboratory Corporation. The test result in the report only applied to the tested sample.

TABLE OF CONTENTS

1. General Information 3
 1. 1 Notes 3
 1. 2 Testing Laboratory 3
 1. 3 Details of Applicant 3
 1. 4 Application Details 3
 1. 5 Test Item 3
 1. 6 Test Standards 3
 2. Technical Test 4
 2. 1 Summary of Test Results 4
 2. 2 Antenna Requirement 4
 3. EUT Modifications 4
 4. Conducted Power Line Test 5
 4. 1 Test Equipment 5
 4. 2 Test Procedure 5
 4. 3 Test Setup 5
 4. 4 Configuration of the EUT 6
 4. 5 EUT Operating Condition 8
 4. 6 Conducted Power Line Emission Limits 8
 4. 7 Conducted Power Line Test Result 9
 5. FCC Part 15.247 Requirements for 802.11b/g/n Systems 11
 5. 1 Test Equipment 11
 5. 2 Test Procedure 11
 5. 3 Test Setup 11
 5. 4 Configuration of the EUT 11
 5. 5 EUT Operating Condition 11
 5. 6 Limit 11
 5. 7 Test Result 12
 6. Transmitter Spurious Radiated Emission at 3 Meters 38
 6. 1 Test Equipment 38
 6. 2 Test Procedure 38
 6. 3 Test Setup 38
 6. 4 Configuration of the EUT 38
 6. 5 EUT Operating Condition 38
 6. 6 Limit 39
 6. 7 Test Result 40
 7. RF Exposure Requirements 47
 7. 1 Test Equipment 47
 7. 2 Limit 47
 7. 3 Test Result 47
 8. Photos of Testing 48
 8. 1 EUT Test Photographs 48
 8. 2 EUT Detailed Photographs 50
 9. FCC ID Label 56
 10. Test Equipment 57

1. General Information

1.1 Notes

The test results of this report relate exclusively to the test item specified in 1.5. The KMO Lab does not assume responsibility for any conclusions and generalizations drawn from the test results with regard to other specimens or samples of the type of the equipment represented by the test item. The test report may only be reproduced or published in full. Reproduction or publication of extracts from the report requires the prior written approval of the KMO Lab.

1.2 Testing Laboratory

Site on File with the Federal Communications Commission – United States
 Registration Number: 963441

Site Listed with Industry Canada of Ottawa, Canada
 Registration Number: 7353A

1.3 Details of Applicant

Name : Shanghai DareGlobal Technologies Co.,Ltd.
Address : 22F,Info Tech Building,No.1555,Kongjiang Road,Shanghai
Contact : Zhaiyingui
Tel : 021-65635566-8191
Fax : N/A

1.4 Application Details

Date of Receipt of Application : May 26, 2011
 Date of Receipt of Test Item : May 26, 2011
 Date of Test : June 1, 2011~August 26,2011

1.5 Test Item

Manufacturer : Zhone Technologies,Inc.
 Address : 7001 Oakport Street Oakland, CA 94621
 Trade Name : ZHONE
 Model No.(Base) : 6519-A1-NA
 Model No.(Extension) : 6519-A2-NA
 Description : ADSL2+ 4 Port Router WIFI 802.11B/G/N 2X2

Note: The engineer update information Ver01.

Additional Information

Product Type : WLAN (2TX, 2RX)
 Radio Type : Intentional Transceiver
 Power Type : DC12V/1A(Adapter_model: DY121-120010100)
 Modulation : see the below tables
 Data Modulation : IEEE 802.11b: DQPSK, DBPSK, DSSS, and CCK
 IEEE 802.11g: BPSK, QPSK, 16QAM, 64QAM
 IEEE 802.11n: HT20/HT40: OFDM (64QAM,16QAM, QPSK, BPSK)
 Date Rate (Mbps) : see the below table
 Frequency Range : 2412~2462MHz
 Channel Number : For 2.4GHz Band: 11 for 20MHz bandwidth; 7 for 40MHz bandwidth
 Antenna : Dipole 2dBi & 5dBi (MIMO Mode: 8.01 dBi(Numeric gain:6.32))

Antenna & Band Width

Antenna	Single (TX)		Two (TX)	
	20 MHz	40 MHz	20 MHz	40 MHz
Band width Mode				
802.11a	X	X	X	X
802.11b	√	X	X	X
802.11g	√	X	X	X
Draft n	X	X	√	√

1.6 Test Standards

FCC 15 Subpart C, Paragraph 15.247

Note: All radiated measurements were made in all three orthogonal planes. The values reported are the maximum values.

2. Technical Test

2.1 Summary of Test Results

The EUT has been tested according to the following specifications:

Standard	Test Type	Result	Notes
FCC Part 15, Paragraph 15.203	Antenna Requirement	PASS	Complies
FCC Part 15, Paragraph 15.107, 15.207	Conducted Test	PASS	Complies
FCC Part 15.205	Radiated Emission (Restricted Band Requirements)	PASS	Complies
FCC Part 15.109, 15.209	Radiated Emission (Spurious Emission)	PASS	Complies.
FCC Part 15 Subpart C Paragraph 15.247(a)(2)	Spectrum Bandwidth (6dB Bandwidth Measurement)	PASS	Complies.
FCC Part 15 Subpart C Paragraph 15.247(b)(3)	Maximum Peak Power	PASS	Complies
FCC Part 15 Subpart C Paragraph 15.247(c)	100kHz Bandwidth of Frequency Band Edges	PASS	Complies
FCC Part 15 Subpart C Paragraph 15.247(d)	Peak Power Spectral Density	PASS	Complies

* The digital circuit porting of the EUT has been tested and verified to comply with FCC Part 15, Subpart B., Class B Digital Devices and the associated Radio Receiver has also been tested and found to comply with FCC Part 15, Subpart B – Radio Receivers.

2.2 Antenna Requirement

A. Regulation

FCC section 15.203, An intentional radiator shall be designed to ensure that no antenna other than that furnished by the responsible party shall be used with the device. The use of a permanently attached antenna or of an antenna that uses a unique coupling to the intentional radiator shall be considered sufficient to comply with the provisions of Part 15C. The manufacturer may design the unit so that the user can replace a broken antenna, but the use of a standard antenna jack or electrical connector is prohibited. This requirement does not apply to carrier current devices or to devices operated under the provisions of Sections 15.211, 15.213, 15.217, 15.219, or 15.221. Further, this requirement does not apply to intentional radiators that must be professionally installed, such as perimeter protection systems and some field disturbance sensors, or to other intentional radiators which, in accordance with Section 15.31(d), must be measured at the installation site. However, the installer shall be responsible for ensuring that the proper antenna is employed so that the limits in this Part are not exceeded.

B. Result

The antenna type used in this product is Dipole Antenna and fixed in the EUT and without connector. That no antenna other than furnished by the responsible party shall be used with the device. The EUT as tested meets the criteria of this rule by being antenna being permanently attached and professionally installed. The EUT is compliant with Section 15.203.

3. EUT Modifications

No modification by test lab.

4. Conducted Power Line Test

4.1 Test Equipment

Please refer to Section 10 this report.

4.2 Test Procedure

The EUT and simulators are connected to the main power through a line impedance stabilization network (L.I.S.N.). This provides a 50 ohm/50uH coupling impedance for the measuring equipment. The peripheral devices are also connected to the main power through a LISN that provides a 50ohm/50uH coupling impedance with 50ohm termination.

Both sides of A.C. line are checked for maximum conducted interference. In order to find the maximum emission., the relative positions of equipment and all of the interface cables must be changed according to ANSI C63.4:2003 on conducted measurement. Conducted emissions were invested over the frequency range from 0.15MHz to 30MHz using a receiver bandwidth of 9kHz.

4.3 Test Setup

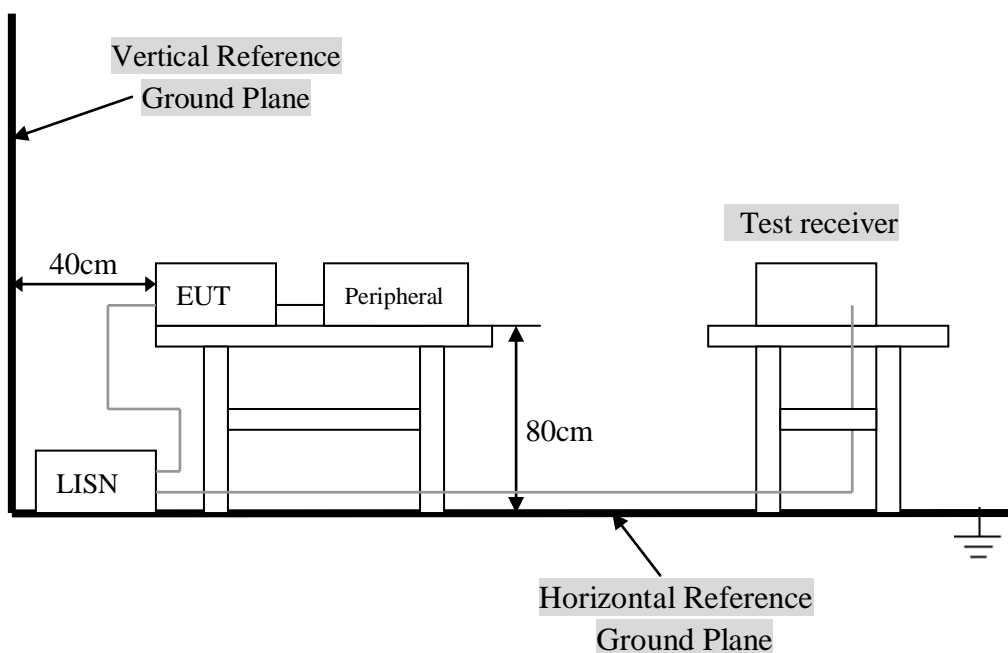

For the actual test configuration, Please refer to the related items – Photos of Testing.

4. 4 Configuration of the EUT

The EUT was configured according to ANSI C63.4-2003. EUT was used DC12V. The operation frequency is from 2400MHz~2483.5MHz. Enable the signal transmitted from the EUT to Notebook PC. All interface ports were connected to the appropriate peripherals. All peripherals and cables are listed below.

Note:

- 1) Operating Modes: Each of lowest, middle and highest channel frequencies transmits continuously for emissions measurements. The EUT operates in normal 802.11b/g/n for occupancy duration and frequency separation.
- 2) Special Test Software & Hardware: Special firmware and hardware provided by the Applicant are installed to allow the EUT to operate in 802.11b/g/n or at each channel frequency continuously. For example, the transmitter will be operated at each of lowest, middle and highest frequencies individually continuously during testing.
- 3) Transmitter Test Antenna: The EUT is tested with the antenna fitted in a manner typical of normal intended use as an integral / non-integral antenna equipment as describe with the test results.
- 4) Frequency(ies) Tested: 2412MHz, 2437MHz and 2462MHz were pre-tested, The worst case one, was chosen for conducted emission test.
- 5) Above 1GHz, the 2412MHz, 2437MHz and 2462MHz were tested individually.
- 6) Normal Test Modulation: 802.11b/g/n
- 7) Modulating Signal Source: Internal

* Associated Antenna Descriptions: The antenna used in this product is dipole antenna.

A. EUT

Device	Manufacturer	Model #	FCC ID
ADSL2+ 4 Port Router WIFI 802.11B/G/N 2X2	Zhone Technologies,Inc.	6519-A1-NA	RS36519A1A2

Field Antenna For 2.4GHz Band

Ant.	Brand	Model Name	Antenna Type	Connector	Gain (dBi)	Remark
0,1	Longju	N/A	Dipole	N/A	2.00	TX/RX
0,1	Boantong	N/A	Dipole	N/A	5.00	TX/RX

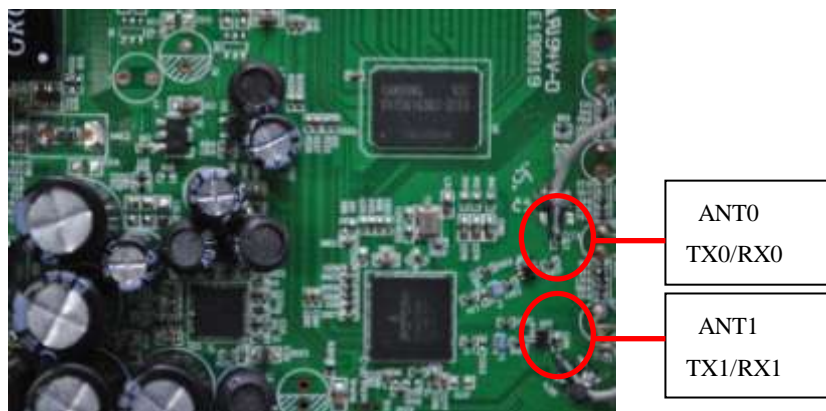

Note:

The EUT incorporates a MIMO function with 802.11b, 802.11g, and 802.11n. Physically, the EUT provides two completed transmit and two receivers. The device was tested in a MIMO type operation.

Carrier Frequencies For 2.4GHz Band

Frequency Band	Channel No.	Frequency	Channel No.	Frquency
2400~2483.5Mhz	1	2412MHz	7	2442MHz
	2	2417MHz	8	2447MHz
	3	2422MHz	9	2452MHz
	4	2427MHz	10	2457MHz
	5	2432MHz	11	2462MHz
	6	2437MHz		

Test Modes For 2.4GHz Band

Test Items	Mode	Data Rate	Channel	Antenna
AC Power Line Conducted Emissions	Normal Link	Auto	-	-
Maximum Peak Conducted Output Power	MCS8/20MHz	26 Mbps	1/6/11	0,1
	MCS8/40MHz	65 Mbps	3/6/9	0,1
Power Spectral Density 6dB Spectrum Bandwidth	MCS8/20MHz	26 Mbps	1/6/11	0,1
	MCS8/40MHz	65 Mbps	3/6/9	0,1
Radiated Emissions 9kHz~1GHz	Normal Link	Auto	-	-
Radiated Emissions 1GHz~10 th Harmonic	MCS8/20MHz	26 Mbps	1/6/11	0,1
	MCS8/40MHz	65 Mbps	3/6/9	0,1
Band Edge Emissions	MCS8/20MHz	26 Mbps	1/11	0,1
	MCS8/40MHz	65 Mbps	3/9	0,1

Note: During testing, Channel & Power Controlling Software provided by the customer was used to control the operating channel as well as the output power level, The RF output power selection is for the setting of RF output power expected by the customer and is going to be fixed on the firmware of the final end product.

B. Internal Devices

Device	Manufacturer	Model #	FCC ID
N/A			

C. Peripherals

Device	Manufacturer	Model # Serial #	FCC ID/ DoC	Cable
Printer	HP	HP930C	DoC	1.5m unshielded power cord 1.2m unshielded data cable.
PC	Dell	2400n	DoC	1.5m unshielded power cord

4. 5 EUT Operating Condition

Operating condition is according to ANSI C63.4 - 2003.

- A. Setup the EUT and simulators as shown on follow.
- B. Enable RF signal and confirm EUT active.
- C. Modulate output capacity of EUT up to specification.

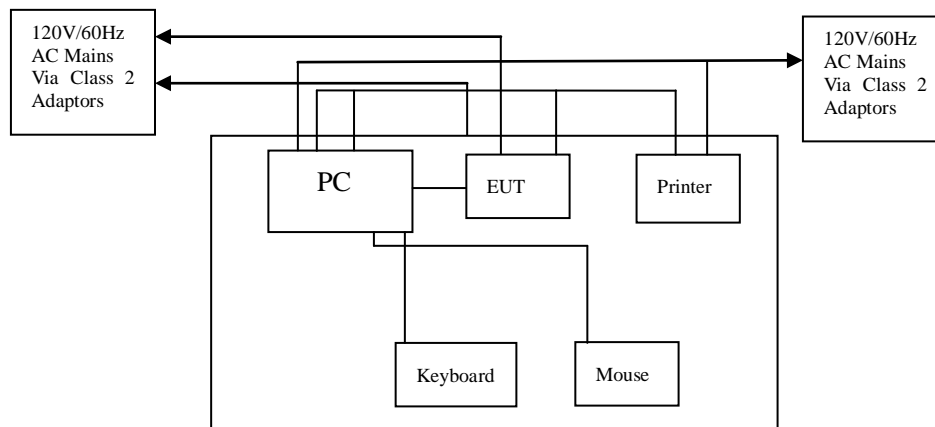

4. 6 Conducted Power Line Emission Limits

FCC Part 15 Paragraph 15.207 (dBuV)		
Frequency Range (MHz)	Class A QP/AV	Class B QP/AV
0.15 – 0.5	79/66	66-56/56-46
0.5 – 5.0	73/60	56/46
5.0 - 30	73/60	60/50

NOTE : In the above table, the tighter limit applies at the band edges.

4.7 Conducted Power Line Test Result

Product	: ADSL2+ 4 Port Router WIFI 802.11B/G/N 2X2	Test Mode	: 802.11b – CH Mid
Test Item	: Conducted Emission Data	Temperature	: 25 °C
Test Voltage	: DC 12V (by DC Power Supply)	Humidity	: 56%RH
Test Result	: PASS	Adapter Model	: DY121-120010100

The frequency spectrum from 0.15 MHz to 30 MHz was investigated. All readings are quasi -peak values with a resolution bandwidth of 9 KHz.

- Temperature : 26 °C
- Humidity : 53 % RH

Adapter Model: DY121-120010100

2dBi Antenna:

FCC Part 15 Paragraph 15.207							
Frequency (MHz)	Emission (dBuV)		LINE/NEUTRAL	Limit (dBuV)		Margin (dB)	
	QP	AV		QP	AV	QP	AV
0.166	43.06	25.90	Line	65.16	55.16	-22.10	-29.26
0.166	41.24	25.51	Neutral	65.16	55.16	-23.92	-29.65
0.182	40.21	28.91	Line	64.39	54.39	-24.18	-25.48
0.178	39.08	25.90	Neutral	64.58	54.58	-25.50	-28.68
0.210	40.07	29.85	Line	63.21	53.21	-33.36	-23.36
0.194	39.04	25.03	Neutral	63.86	53.86	-24.82	-28.83

5dBi Antenna:

FCC Part 15 Paragraph 15.207							
Frequency (MHz)	Emission (dBuV)		LINE/NEUTRAL	Limit (dBuV)		Margin (dB)	
	QP	AV		QP	AV	QP	AV
0.170	61.10	33.63	Line	64.96	54.96	-3.86	-21.33
0.166	59.87	31.59	Neutral	65.16	55.16	-5.29	-23.57
0.194	59.09	32.12	Line	63.86	53.86	-4.77	-21.74
0.170	60.18	33.46	Neutral	64.96	54.96	-4.78	-21.50
0.214	56.34	32.06	Line	63.05	53.05	-30.99	-20.99
0.190	58.36	31.05	Neutral	64.04	54.04	-5.68	-22.99

Note: NF = No Significant Peak was Found.

Note:

- 1.Uncertainty in conducted emission measured is <+/- 2dB.
- 2.The emission levels of other frequencies were very low against the limit.
- 3.All Reading Levels are Quasi-Peak and Average value.
- 4.Emission = Meter Reading + Factor; Factor = Insertion Loss + Cable Loss.
- 5.Margin Value = Emission Level - Limit Value.

Conducted Emission

EN55022

EUT: ADSL2+4Port Router WIFI 802.11B/G/N 2X2

M/N: 6519-A1-NA

Manufacturer: Zhong Technologies, Inc.

Operating Condition: Transmitter

Test Site: Normal

Operator: Joy peng

Test Specification: LINE&NEUTRAL

Comment:

2dB Antenna:

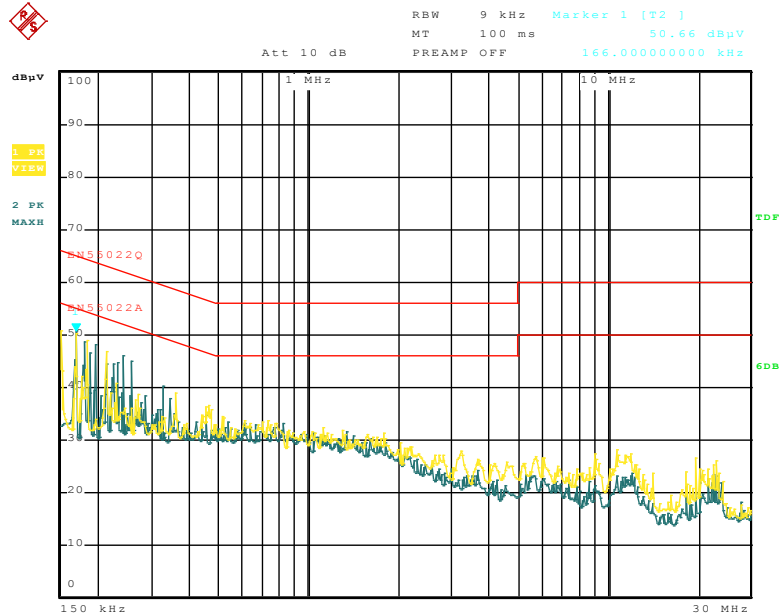

Date: 1.JUN.2011 14:51:10

5dB Antenna:

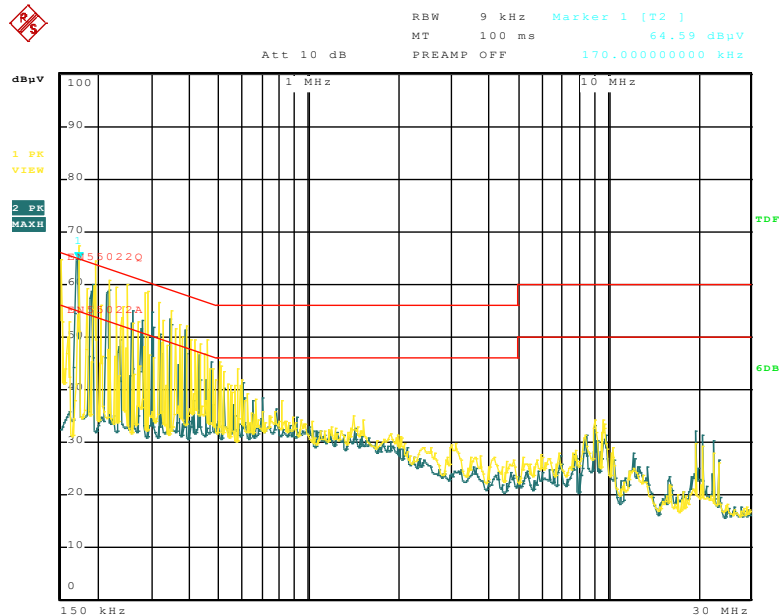

Date: 24.JUN.2011 17:58:19

5. FCC Part 15.247 Requirements for 802.11b/g/n Systems

5.1 Test Equipment

Please refer to Section 10 this report.

5.2 Test Procedure

Refer to FCC 15.247(a)(2), ANSI C63.4: 2003

6 dB Bandwidth:

- Place the EUT on the table and set it in the transmitting mode.
- Remove the antenna from the EUT and then connect a low loss RF cable from the antenna port to the spectrum analyzer.
- Set the spectrum analyzer as RBW = 100 kHz, VBW = RBW, Span = 50 MHz, Sweep = auto.
- Mark the peak frequency and -6dB (upper and lower) frequency.
- Repeat until all the rest channels are investigated.

Peak Power:

The transmitter output is connected to the test receiver. The test receiver is set to the peak power detection. The power is equal to the reading level on test receiver plus cable loss at the EUT RF output terminal.

Band Edges Measurement:

- The transmitter output was connected to the spectrum analyzer via a low lose cable.
- Set both RBW and VBW of spectrum analyzer to 100kHz with suitable frequency span including 100kHz bandwidth from band edge.
- The band edges was measured and recorded.

Peak Power Spectral Density:

- The transmitter output is connected to a test receiver, The spectrum analyzer's resolution bandwidth was set at 3kHz RBW and 30kHz VBW as that of the fundamental frequency. Set the sweep time=span/3kHz.
- The power spectral density was measured and recorded.
- The sweep time is allowed to be longer than span/3kHz for a full response of the mixer in the spectrum analyzer.

5.3 Test Setup

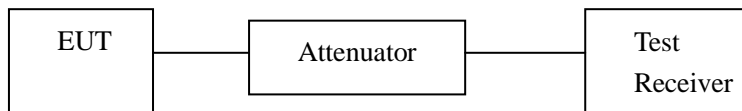

5.4 Configuration of the EUT

Same as section 4.4 of this report

5.5 EUT Operating Condition

Same as section 4.5 of this report.

5.6 Limit

According to §15.247(a)(2), systems using digital modulation techniques may operate in the 902 ~ 928 MHz, 2400 ~ 2483.5 MHz, and 5725 ~ 5850 MHz bands. The minimum 6dB bandwidth shall be at least 500 kHz.

According to §15.247(b)(3), for systems using digital modulation in the bands of 902-928 MHz, 2400-2483.5 MHz, and 5725-5850 MHz: 1 Watt.

According to §15.247(b)(4), the conducted output power limit specified in paragraph (b) of this section is based on the use of antennas with directional gains that do not exceed 6 dBi. Except as shown in paragraph (c) of this section, if transmitting antennas of directional gain greater than 6 dBi are used, the conducted output power from the intentional radiator shall be reduced below the stated values in paragraphs (b)(1), (b)(2), and (b)(3) of this section, as appropriate, by the amount in dB that the directional gain of the antenna exceeds 6 dBi.

According to §15.247(d), in any 100 kHz bandwidth outside the frequency bands in which the spread spectrum intentional radiator is operating, the radio frequency power that is produced by the intentional radiator shall be at least 20 dB below that in the 100 kHz bandwidth within the band that contains the highest level of the desired power, based on either an RF conducted or a radiated measurement, provided the transmitter demonstrates compliance with the peak conducted power limits. In addition, radiated emissions which fall in the restricted bands, as defined in §15.205(a), must also comply with the radiated emission limits specified in 15.209(a) (see Section 15.205(c)).

According to §15.247(e), for digitally modulated systems, the power spectral density conducted from the intentional radiator to the antenna shall not be greater than 8 dBm in any 3 kHz band during any time interval of continuous transmission.

According to §15.247(f), the digital modulation operation of the hybrid system, with the frequency hopping turned off, shall comply with the power density requirements of paragraph (d) of this section.

5.7 Test Result

A. 6 dB Bandwidth

Product	: ADSL2+ 4 Port Router WIFI 802.11B/G/N 2X2	Test Mode	: IEEE 802.11b/g/Draft n
Test Item	: 6 dB BW	Temperature	: 25 °C
Test Voltage	: DC 12V (Power by Adapter Supply)	Humidity	: 56%RH
Test Result	: PASS		

IEEE 802.11b

Channel	Frequency (MHz)	Bandwidth (MHz)	FCC Limit (kHz)	Result
Low	2412	7.68	>500 kHz	PASS
Mid	2437	8.04		PASS
High	2462	7.96		PASS

IEEE 802.11g

Channel	Frequency (MHz)	Bandwidth (MHz)	FCC Limit (kHz)	Result
Low	2412	16.32	>500 kHz	PASS
Mid	2437	16.32		PASS
High	2462	13.56		PASS

Draft n MCS8 20MHz Ant.0

Channel	Frequency (MHz)	Bandwidth (MHz)	FCC Limit (kHz)	Result
Low	2412	17.52	>500 kHz	PASS
Mid	2437	17.60		PASS
High	2462	17.52		PASS

Draft n MCS8 20MHz Ant.1

Channel	Frequency (MHz)	Bandwidth (MHz)	FCC Limit (kHz)	Result
Low	2412	17.24	>500 kHz	PASS
Mid	2437	17.16		PASS
High	2462	17.36		PASS

Draft n MCS8 40MHz Ant.0

Channel	Frequency (MHz)	Bandwidth (MHz)	FCC Limit (kHz)	Result
Low	2422	35.76	>500 kHz	PASS
Mid	2437	36.32		PASS
High	2452	35.68		PASS

Draft n MCS8 40MHz Ant.1

Channel	Frequency (MHz)	Bandwidth (MHz)	FCC Limit (kHz)	Result
Low	2422	35.68	>500 kHz	PASS
Mid	2437	35.56		PASS
High	2452	35.68		PASS

IEEE 802.11b

6dB Bandwidth (CH Low)

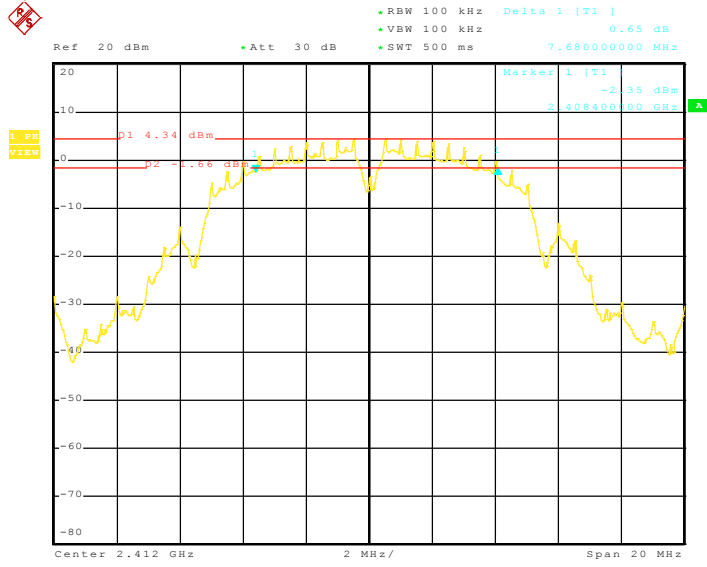

Date: 14.JUN.2011 18:48:56

6dB Bandwidth (CH Mid)

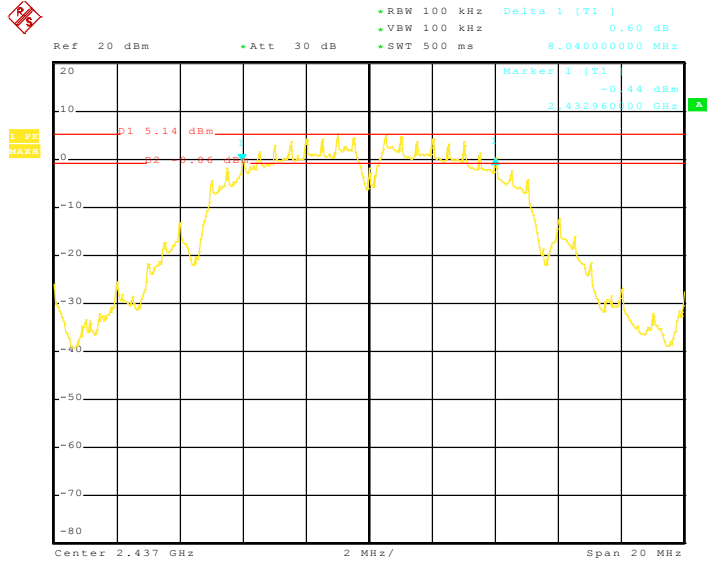

Date: 14.JUN.2011 19:10:02

6dB Bandwidth (CH High)

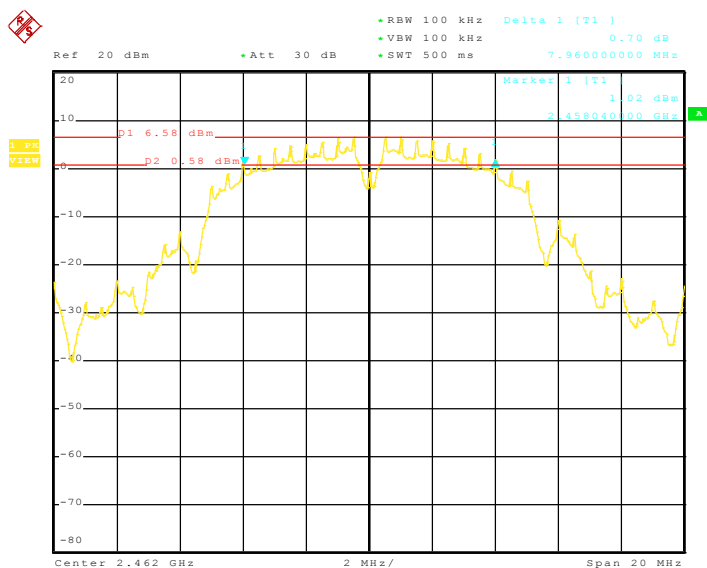

Date: 15.JUN.2011 10:10:22

IEEE 802.11g

6dB Bandwidth (CH Low)

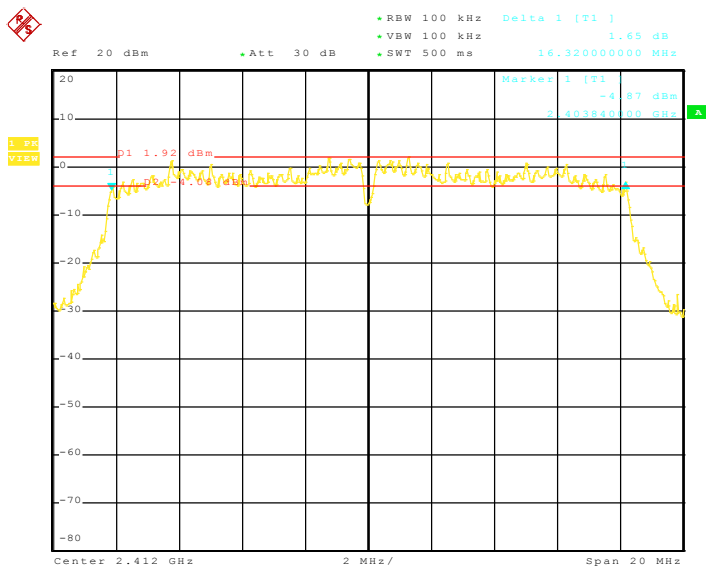

Date: 14.JUN.2011 17:12:38

6dB Bandwidth (CH Mid)

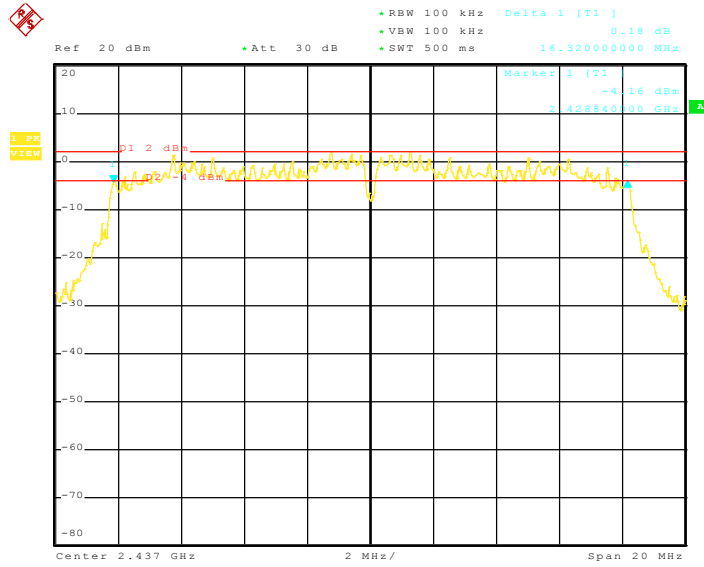

Date: 14.JUN.2011 17:50:14

6dB Bandwidth (CH High)

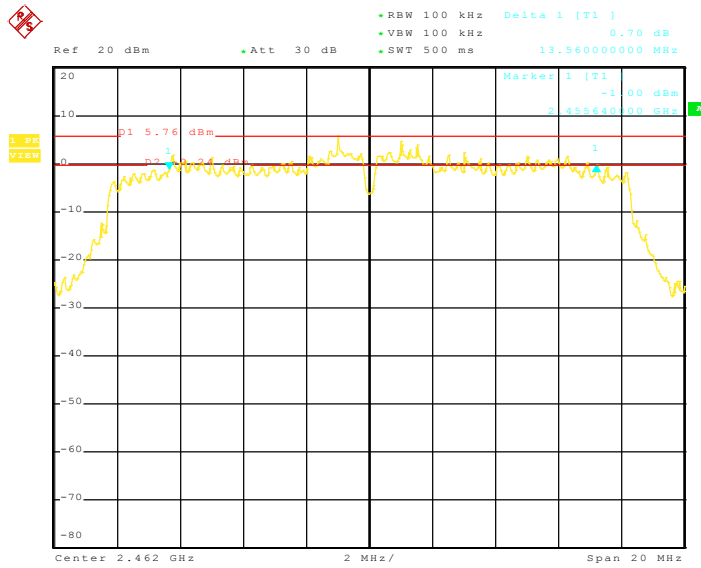

Date: 14.JUN.2011 18:07:06

IEEE 802.11n MCS8 20MHz Ant.0

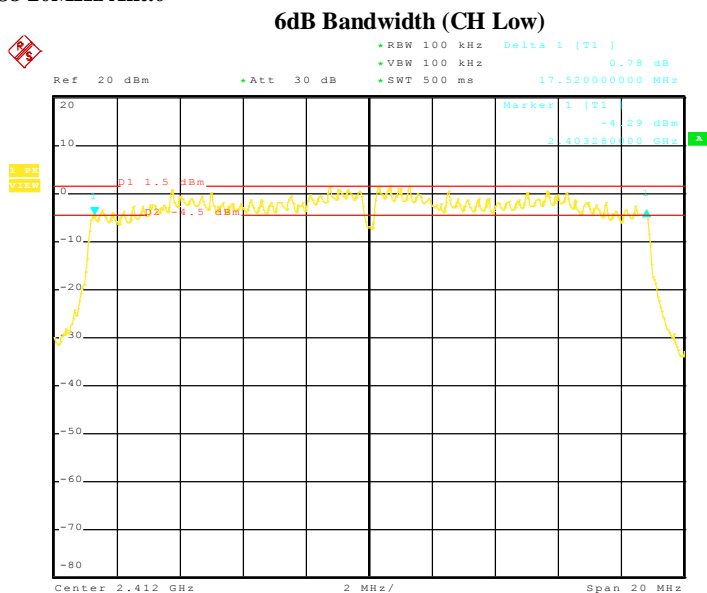

Date: 14.JUN.2011 10:38:29

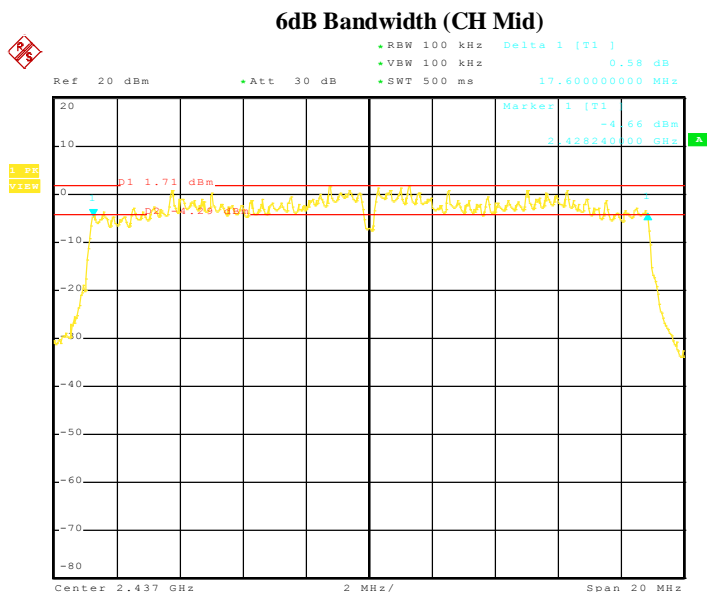

Date: 14.JUN.2011 10:53:32

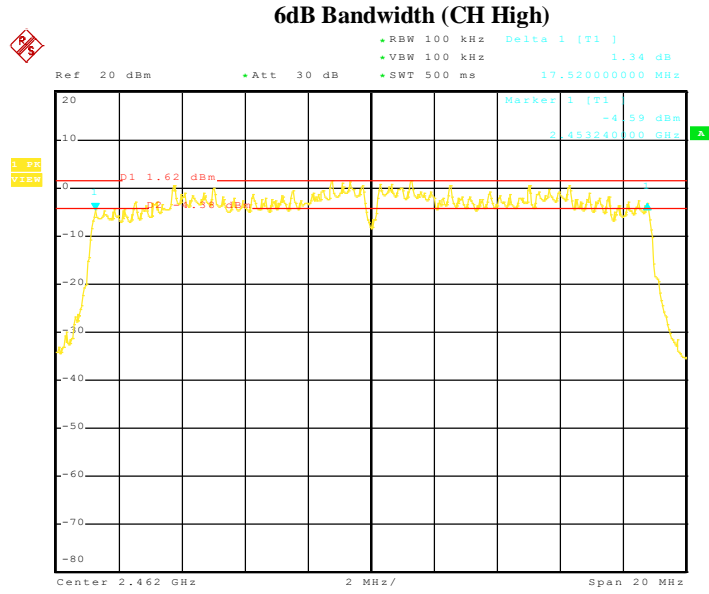

Date: 14.JUN.2011 11:02:41

IEEE 802.11n MCS8 20MHz ANT.1

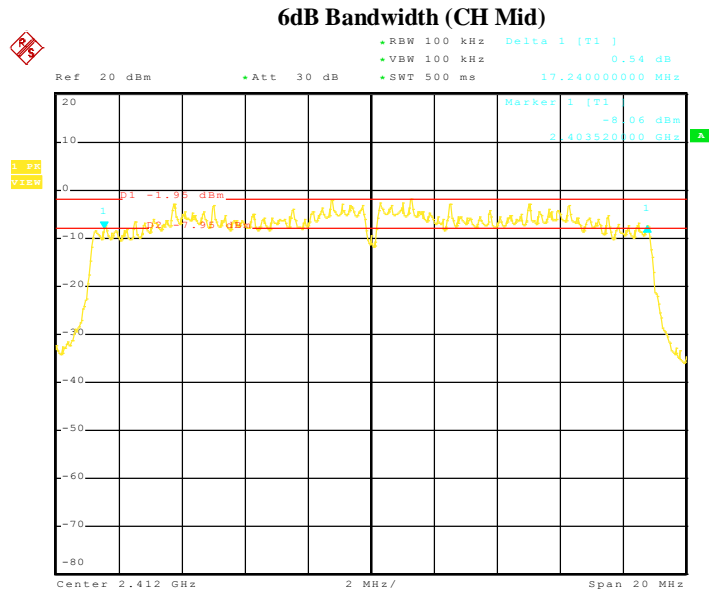

Date: 21.AUG.2011 15:16:12

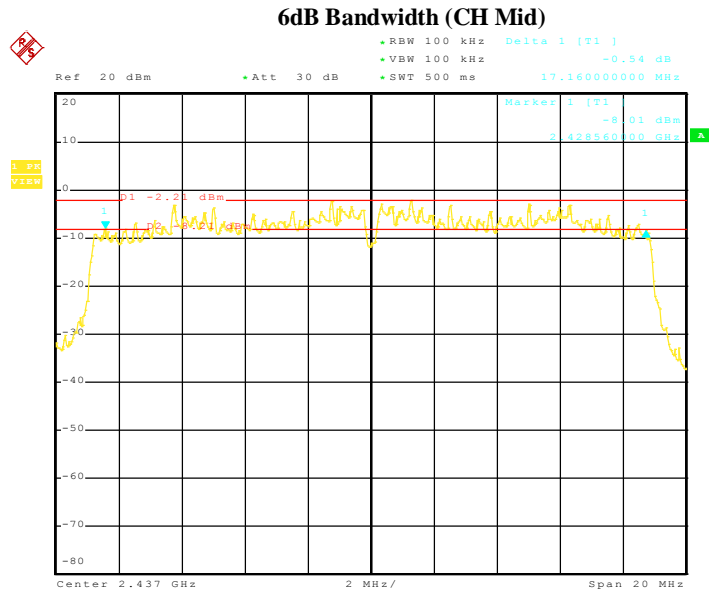

Date: 21.AUG.2011 15:24:17

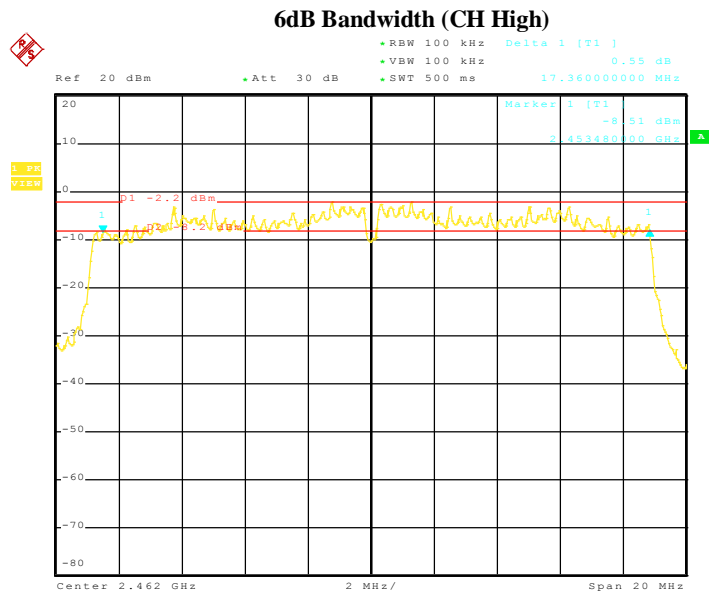

Date: 21.AUG.2011 15:29:21

IEEE 802.11n MCS8 40MHz Ant.0

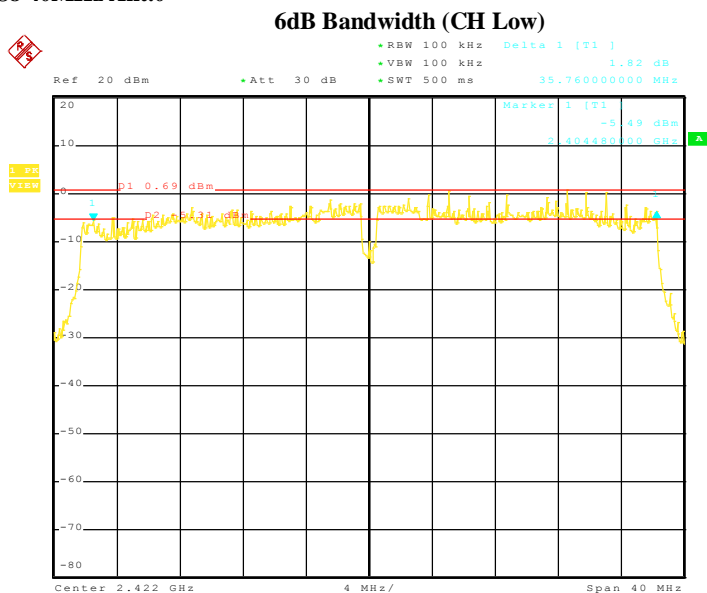

Date: 14.JUN.2011 11:15:17

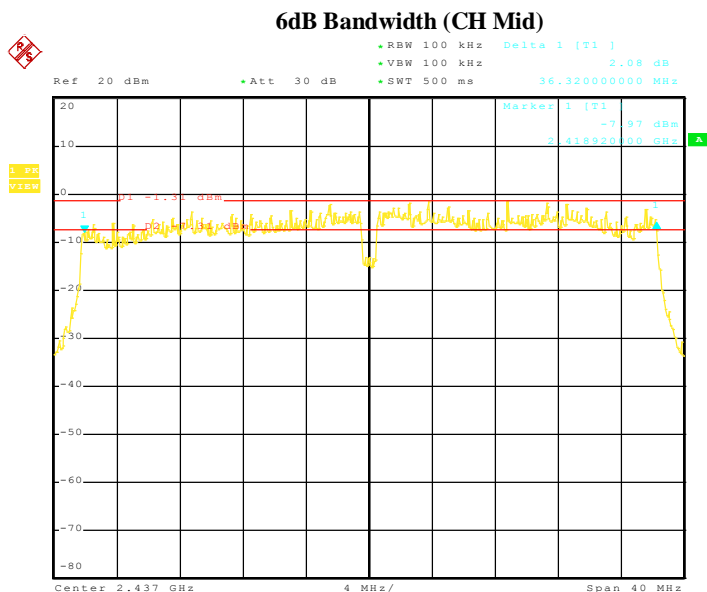

Date: 14.JUN.2011 11:28:30

6dB Bandwidth (CH High)

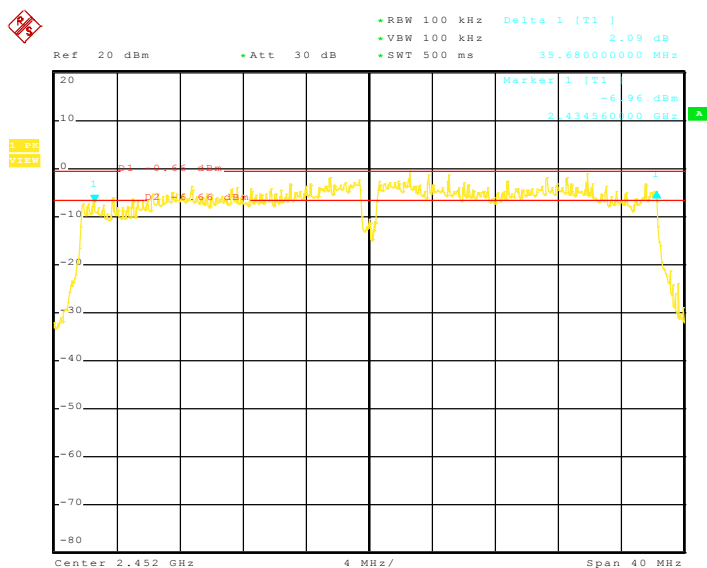

Date: 14.JUN.2011 11:47:03

IEEE 802.11n MCS8 40MHz Ant.1

6dB Bandwidth (CH Low)

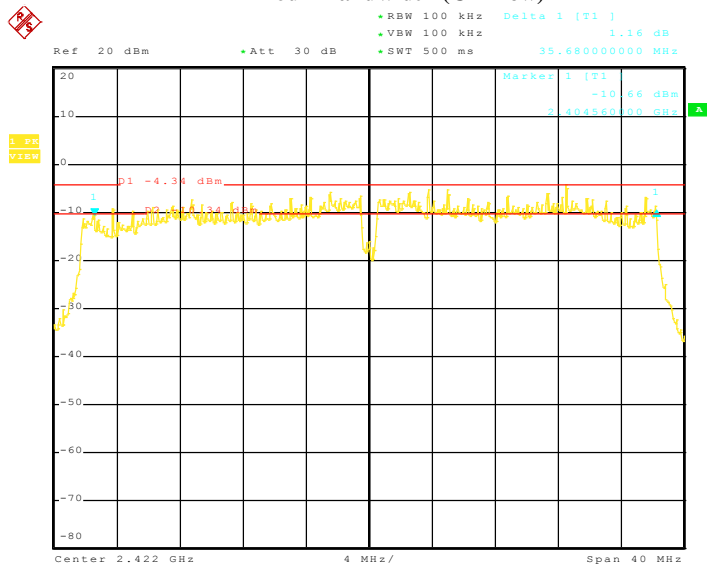

Date: 21.AUG.2011 15:32:48

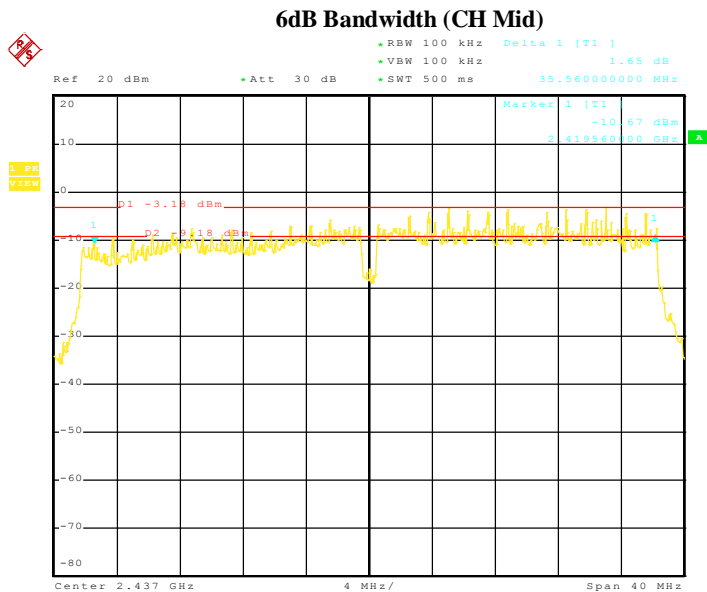

Date: 21.AUG.2011 15:52:15

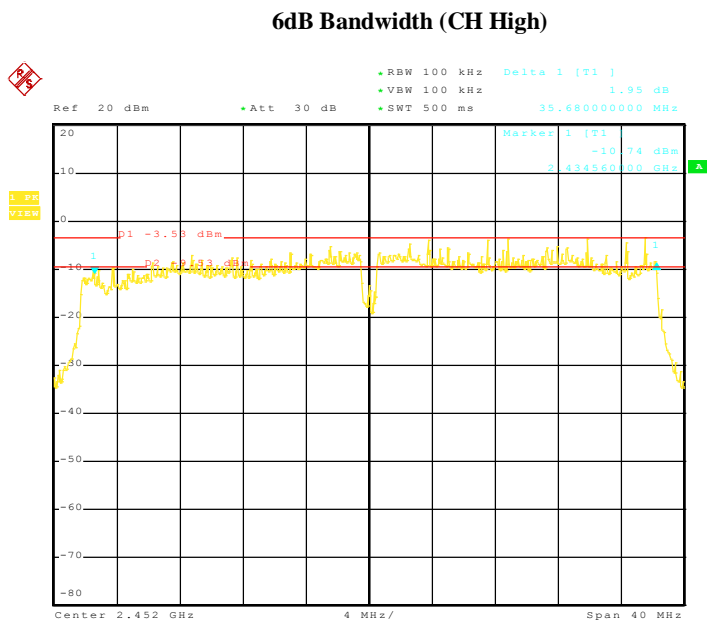

Date: 21.AUG.2011 15:55:43

B. Peak Power

Product	: ADSL2+ 4 Port Router WIFI 802.11B/G/N 2X2	Test Mode	: IEEE 802.11b/g/n
Test Item	: Peak Power	Temperature	: 25 °C
Test Voltage	: DC 12V (Power by Adapter Supply)	Humidity	: 56%RH
Test Result	: PASS		

IEEE 802.11b

Channel	Frequency (MHz)	Output Power (dBm)	FCC Limit (W/dBm)	Result
Low	2412	22.07	1.00/30.00	PASS
Mid	2437	21.48		PASS
High	2462	22.96		PASS

IEEE 802.11g

Channel	Frequency (MHz)	Output Power (dBm)	FCC Limit (W/dBm)	Result
Low	2412	16.36	1.00/30.00	PASS
Mid	2437	17.33		PASS
High	2462	18.09		PASS

IEEE 802.11n MCS8 20MHz Ant.0

Channel	Frequency (MHz)	Output Power (dBm)	FCC Limit (W/dBm)	Result
Low	2412	19.46	0.63/27.99	PASS
Mid	2437	18.66		PASS
High	2462	20.11		PASS

IEEE 802.11n MCS8 20MHz Ant.1

Channel	Frequency (MHz)	Output Power (dBm)	FCC Limit (W/dBm)	Result
Low	2412	21.78	0.63/27.99	PASS
Mid	2437	21.96		PASS
High	2462	22.02		PASS

IEEE 802.11n MCS8 20MHz Ant.0+Ant.1

Channel	Frequency (MHz)	Output Power (dBm)	FCC Limit (W/dBm)	Result
Low	2412	23.78	0.63/27.99	PASS
Mid	2437	23.63		PASS
High	2462	24.18		PASS

IEEE 802.11n MCS8 40MHz Ant.0

Channel	Frequency (MHz)	Output Power (dBm)	FCC Limit (W/dBm)	Result
Low	2422	19.15	0.63/27.99	PASS
Mid	2437	17.43		PASS
High	2452	19.46		PASS

IEEE 802.11n MCS8 40MHz Ant.1

Channel	Frequency (MHz)	Output Power (dBm)	FCC Limit (W/dBm)	Result
Low	2422	21.98	0.63/27.99	PASS
Mid	2437	21.91		PASS
High	2452	21.76		PASS

IEEE 802.11n MCS8 40MHz Ant.0+Ant.1

Channel	Frequency (MHz)	Output Power (dBm)	FCC Limit (W/dBm)	Result
Low	2422	23.80	0.63/27.99	PASS
Mid	2437	23.23		PASS
High	2452	23.77		PASS

Note:

- 1.Total Output Power (w) = Chain 0(10^(Output Power / 10)/1000)+Chain2 (10^(Output Power/10)/1000)
- 2.The maximum antenna gain is 8.01 dBi; therefore the reduction due to antenna gain is 2.01 dB, So that the limit is 27.99dBm/0.63W

C. Band Edges Measurement

Product : ADSL2+ 4 Port Router WIFI Test Mode : IEEE 802.11b/g/n
 802.11B/G/N 2X2
 Test Item : Band Edges Measurement Temperature : 25 °C
 Test Voltage : DC 12V (Power by Adapter Supply) Humidity : 56%RH
 Test Result : **PASS**

IEEE 802.11b-low

Freq. (MHz)	Emission (dBuV/m)		HORIZ / VERT	Limits (dBuV/m)		Margin (dB)	
	Peak	Average		Peak	Average		
2350.040	57.15	40.64	HORZ	74	54	-16.85	-13.36
2384.280	57.74	41.38	VERT	74	54	-16.26	-12.62
2390.460	62.19	42.22	HORZ	74	54	-11.81	-11.78
2390.640	60.57	41.55	VERT	74	54	-13.43	-12.45

IEEE 802.11b-High

Freq. (MHz)	Emission (dBuV/m)		HORIZ / VERT	Limits (dBuV/m)		Margin (dB)	
	Peak	Average		Peak	Average		
2483.540	60.18	44.27	HORZ	74	54	-13.82	-9.73
2484.460	57.64	42.49	VERT	74	54	-16.36	-11.51
2485.520	57.25	45.36	HORZ	74	54	-16.75	-8.64
2486.640	56.33	42.24	VERT	74	54	-17.67	-11.76

IEEE 802.11g-Low

Freq. (MHz)	Emission (dBuV/m)		HORIZ / VERT	Limits (dBuV/m)		Margin (dB)	
	Peak	Average		Peak	Average		
2352.140	64.42	46.92	HORZ	74	54	-9.58	-7.08
2385.260	61.36	43.65	VERT	74	54	-12.64	-10.35
2390.780	62.58	43.46	HORZ	74	54	-11.42	-10.54
2390.840	62.11	42.37	VERT	74	54	-11.89	-11.63

IEEE 802.11g-High

Freq. (MHz)	Emission (dBuV/m)		HORIZ / VERT	Limits (dBuV/m)		Margin (dB)	
	Peak	Average		Peak	Average		
2483.640	65.81	45.25	HORZ	74	54	-8.19	-8.75
2483.720	67.78	45.61	VERT	74	54	-6.22	-8.39
2485.420	68.35	48.74	HORZ	74	54	-5.65	-5.26
2486.560	67.54	47.15	VERT	74	54	-6.46	-6.85

IEEE 802.11n MCS8 20MHz Ant.0+Ant.1-Low

Freq. (MHz)	Emission (dBuV/m)		HORIZ / VERT	Limits (dBuV/m)		Margin (dB)	
	Peak	Average		Peak	Average		
2351.040	67.16	48.96	HORZ	74	54	-6.84	-5.04
2385.260	68.84	47.34	VERT	74	54	-5.16	-6.66
2390.540	66.38	45.17	HORZ	74	54	-7.62	-8.83
2390.720	64.14	44.53	VERT	74	54	-9.86	-9.47

IEEE 802.11n MCS8 20MHz Ant.0+Ant.1-High

Freq. (MHz)	Emission (dBuV/m)		HORIZ / VERT	Limits (dBuV/m)		Margin (dB)	
	Peak	Average		Peak	Average		
2484.840	65.26	44.15	HORZ	74	54	-8.74	-9.85
2485.144	66.79	45.62	VERT	74	54	-7.21	-8.38
2485.420	64.48	43.78	HORZ	74	54	-9.52	-10.22
2487.140	67.59	46.86	VERT	74	54	-6.41	-7.14

IEEE 802.11n MCS8 40MHz Ant.0+Ant.1-Low

Freq. (MHz)	Emission (dBuV/m)		HORIZ / VERT	Limits (dBuV/m)		Margin (dB)	
	Peak	Average		Peak	Average		
2351.340	67.75	46.38	HORZ	74	54	-6.25	-7.62
2384.120	66.85	45.57	VERT	74	54	-7.15	-8.43
2390.440	64.17	43.33	HORZ	74	54	-9.83	-10.67
2390.540	65.55	44.69	VERT	74	54	-8.45	-9.31

IEEE 802.11n MCS8 40MHz Ant.0+Ant.1-High

Freq. (MHz)	Emission (dBuV/m)		HORIZ / VERT	Limits (dBuV/m)		Margin (dB)	
	Peak	Average		Peak	Average		
2483.640	68.04	46.94	HORZ	74	54	-5.96	-7.06
2484.420	66.75	45.86	VERT	74	54	-7.25	-8.14
2485.260	65.27	44.39	HORZ	74	54	-8.73	-9.61
2485.640	68.31	47.16	VERT	74	54	-5.69	-6.84

IEEE 802.11b Channel: Low

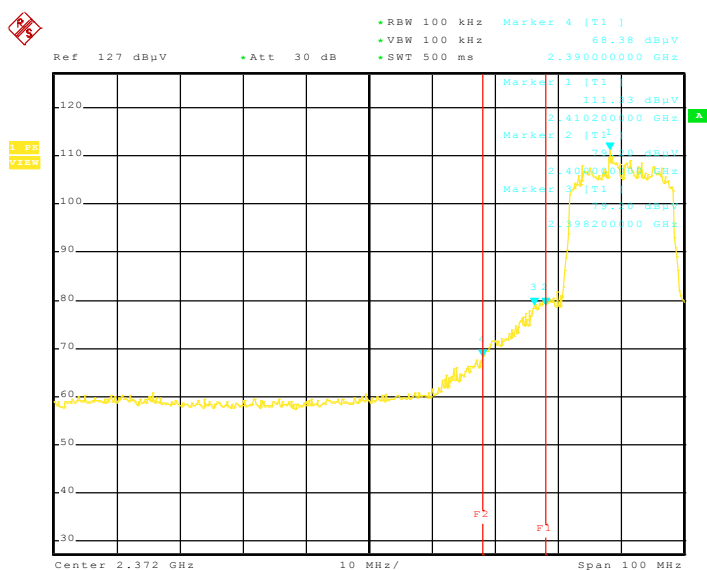

Date: 14.JUN.2011 17:19:20

IEEE 802.11b Channel: High

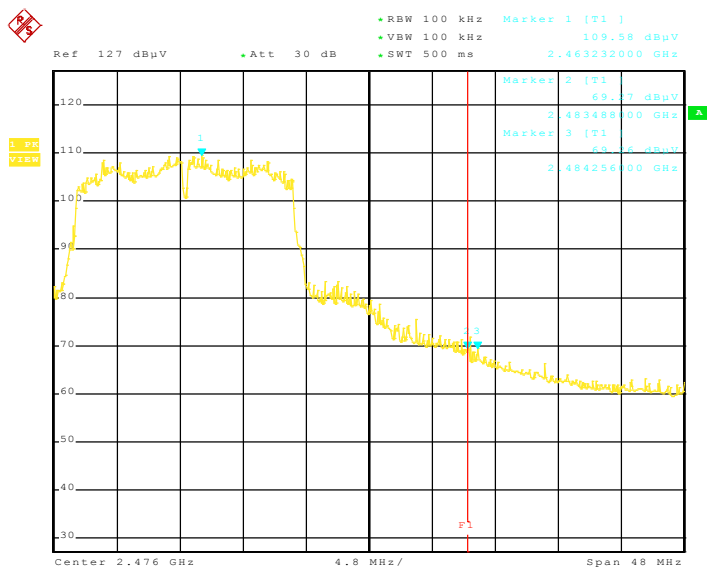

Date: 14.JUN.2011 18:10:53

IEEE 802.11g Channel: Low

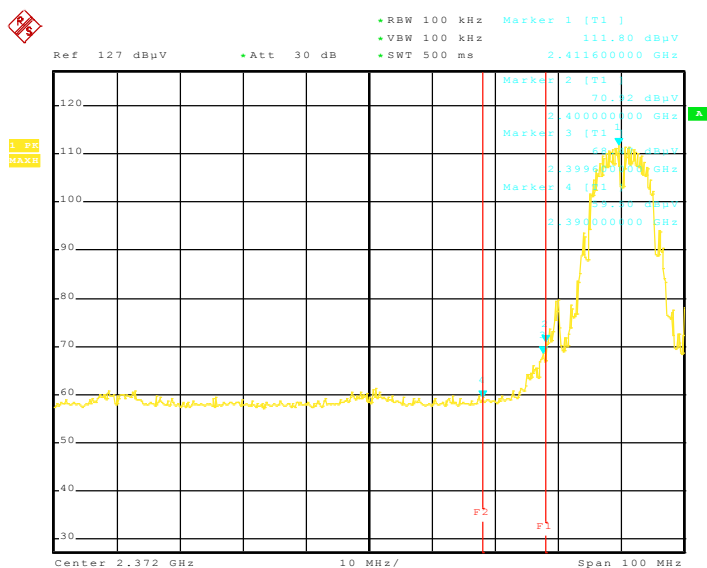

Date: 14.JUN.2011 18:53:29

IEEE 802.11g Channel: High

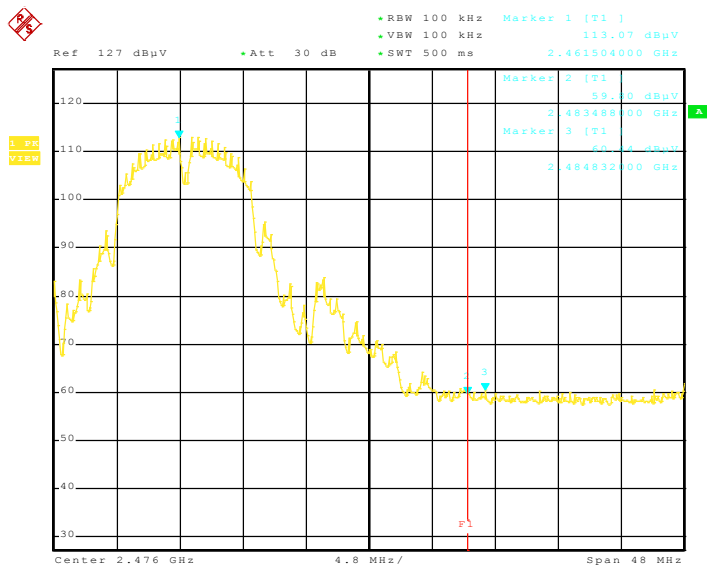

Date: 15.JUN.2011 10:16:09

IEEE 802.11n MCS8 20MHz Ant.0+Ant.1 Channel: Low

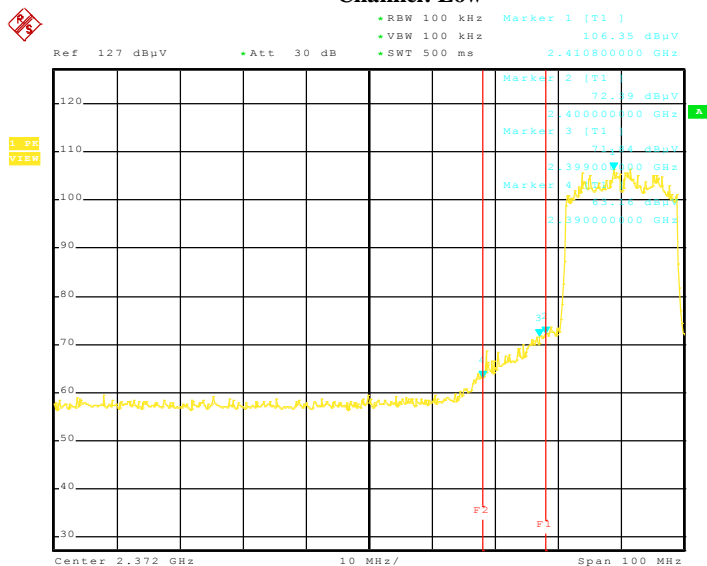

Date: 14.JUN.2011 12:14:10

IEEE 802.11n MCS8 20MHz Ant.0+Ant.1 Channel: High

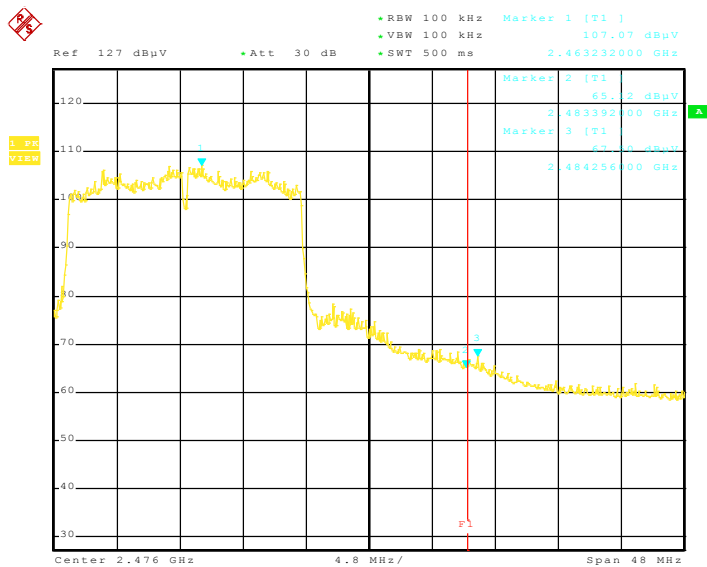

Date: 14.JUN.2011 12:26:45

IEEE 802.11n MCS8 40MHz Ant.0+Ant.1 Channel: Low

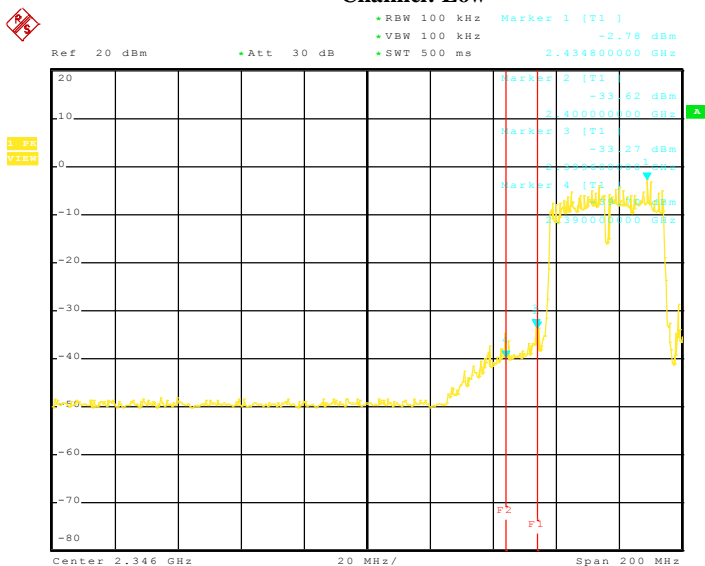

Date: 14.JUN.2011 12:38:47

IEEE 802.11n MCS8 40MHz Ant.0+Ant.1 Channel: High

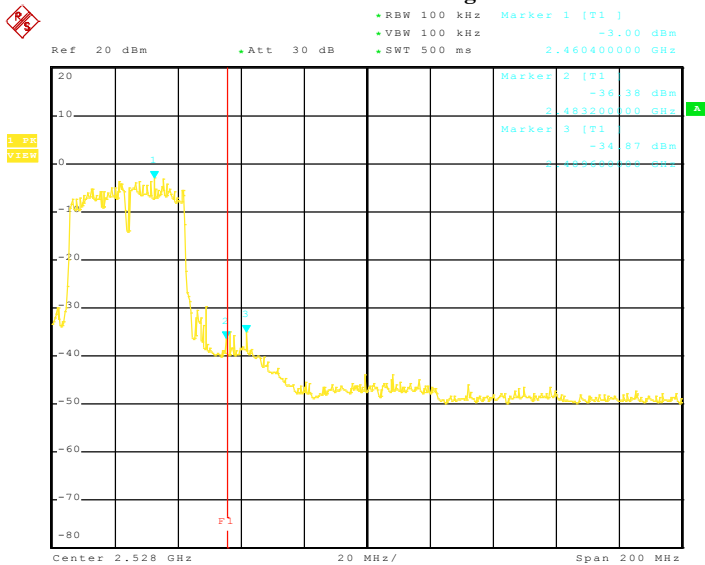

Date: 14.JUN.2011 12:53:24

D. Peak Power Spectral Density

Product : ADSL2+ 4 Port Router WIFI 802.11B/G/N 2X2 Test Mode : IEEE 802.11b/g/n
 Test Item : Peak Power Spectral Density Temperature : 25 °C
 Test Voltage : DC 12V (Power by Adapter Supply) Humidity : 56%RH
 Test Result : **PASS**

IEEE 802.11b

Channel	Frequency (MHz)	PPSD (dBm)	FCC Limit (dBm)	Result
Low	2412	-9.28	8.00	PASS
Mid	2437	-11.61		PASS
High	2462	-9.91		PASS

IEEE 802.11g

Channel	Frequency (MHz)	PPSD (dBm)	FCC Limit (dBm)	Result
Low	2412	-7.99	8.00	PASS
Mid	2437	-6.26		PASS
High	2462	-6.72		PASS

IEEE 802.11n MCS8 20MHz Ant.0

Channel	Frequency (MHz)	PPSD (dBm)	FCC Limit (dBm)	Result
Low	2412	-11.80	5.99	PASS
Mid	2437	-11.48		PASS
High	2462	-11.10		PASS

IEEE 802.11n MCS8 20MHz Ant.1

Channel	Frequency (MHz)	PPSD (dBm)	FCC Limit (dBm)	Result
Low	2412	-14.56	5.99	PASS
Mid	2437	-13.45		PASS
High	2462	-14.45		PASS

Draft n MCS8 20MHz Ant.0+Ant.1

Channel	Frequency (MHz)	PPSD (dBm)	FCC Limit (dBm)	Result
Low	2412	-9.95	5.99	PASS
Mid	2437	-9.34		PASS
High	2462	-9.45		PASS

IEEE 802.11n MCS8 40MHz Ant.0

Channel	Frequency (MHz)	PPSD (dBm)	FCC Limit (dBm)	Result
Low	2422	-18.13	5.99	PASS
Mid	2437	-15.86		PASS
High	2452	-17.75		PASS

IEEE 802.11n MCS8 40MHz Ant.1

Channel	Frequency (MHz)	PPSD (dBm)	FCC Limit (dBm)	Result
Low	2422	-18.75	5.99	PASS
Mid	2437	-18.64		PASS
High	2452	-17.12		PASS

Draft n MCS8 40MHz Ant.0+Ant.1

Channel	Frequency (MHz)	PPSD (dBm)	FCC Limit (dBm)	Result
Low	2412	-15.42	5.99	PASS
Mid	2437	-14.02		PASS
High	2462	-14.41		PASS

Note:

- Total PPSD (dBm) = 10*LOG(10^(Chain 0 PPSD / 10)+10^(Chain 1 PPSD / 10))
- The maximum antenna gain is 8.01 dBi; therefore the reduction due to antenna gain is 2.01dB, So that the limit is 5.99dBm

IEEE 802.11b Channel: Low

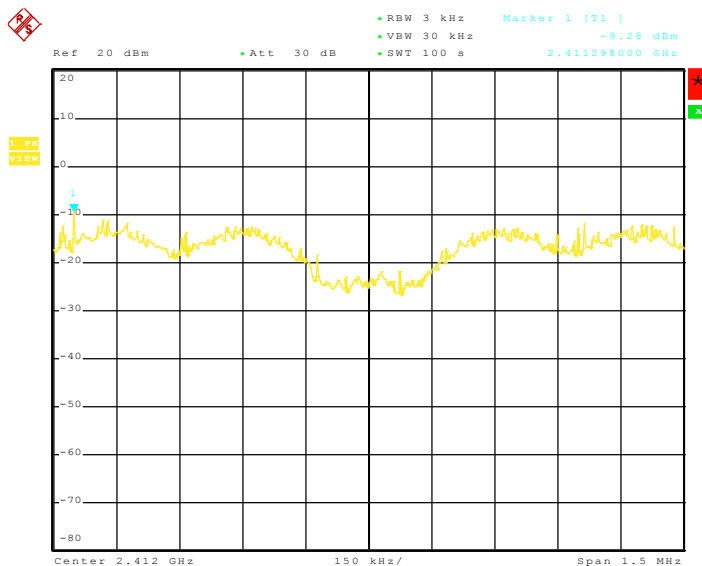

Date: 14.JUN.2011 17:26:53

IEEE 802.11b Channel: Mid

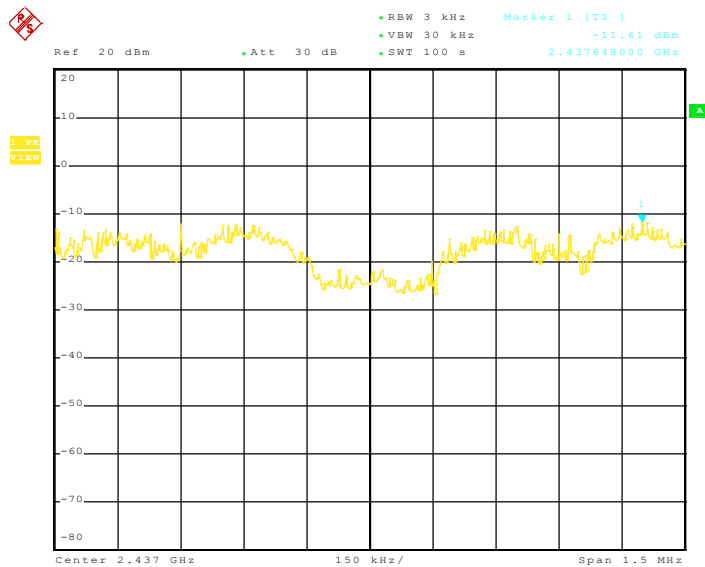

Date: 14.JUN.2011 18:00:31

IEEE 802.11b Channel: High

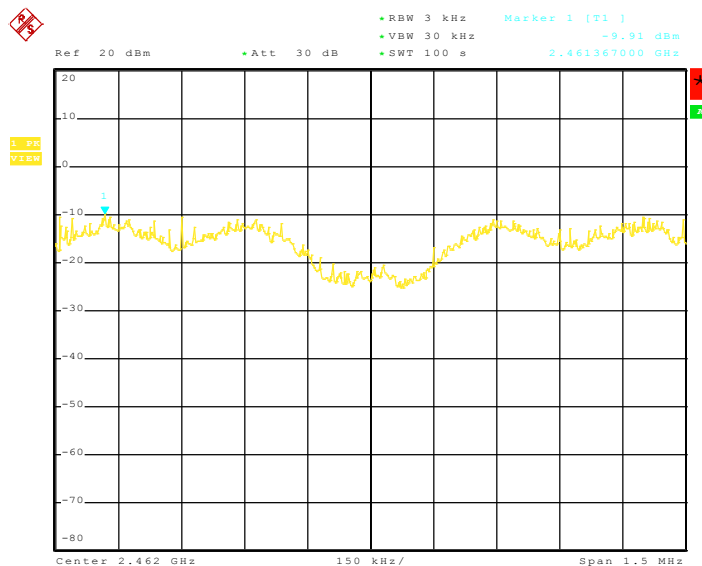

Date: 14.JUN.2011 18:44:20

IEEE 802.11g Channel: Low

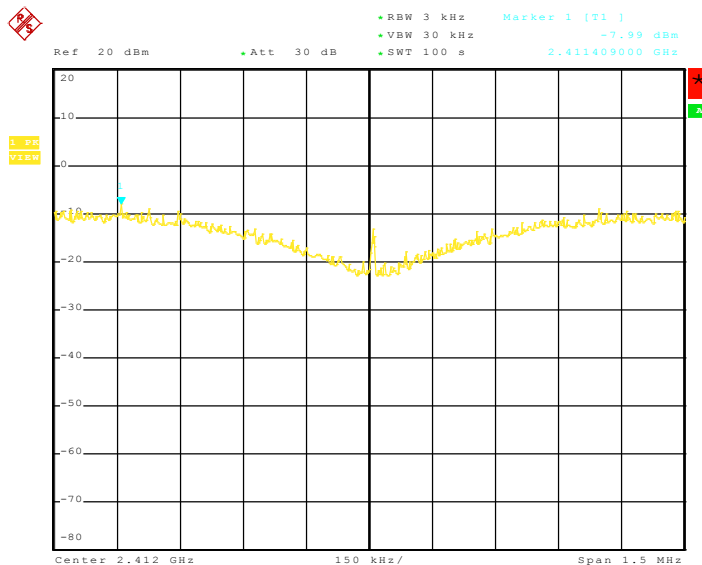

Date: 14.JUN.2011 19:04:04

IEEE 802.11g Channel: Mid

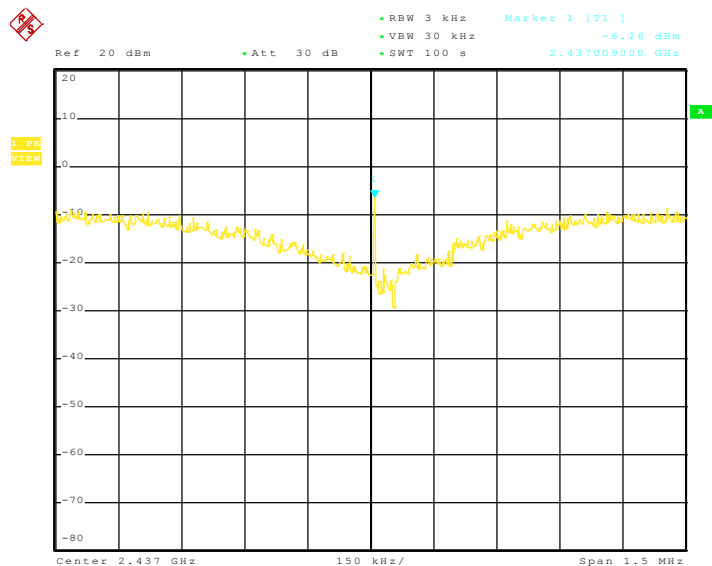

Date: 14.JUN.2011 19:18:23

IEEE 802.11g Channel: High

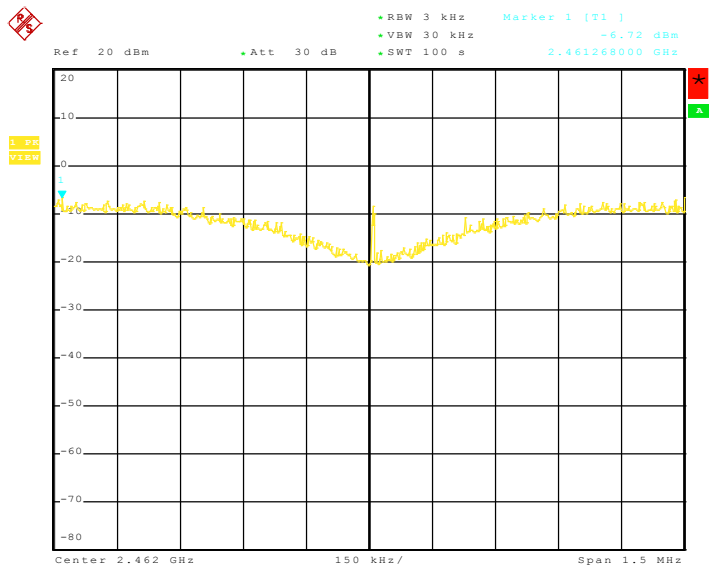

Date: 15.JUN.2011 10:20:51

IEEE 802.11n MCS8 20MHz Ant.0/2412MHZ
(Channel: Low)

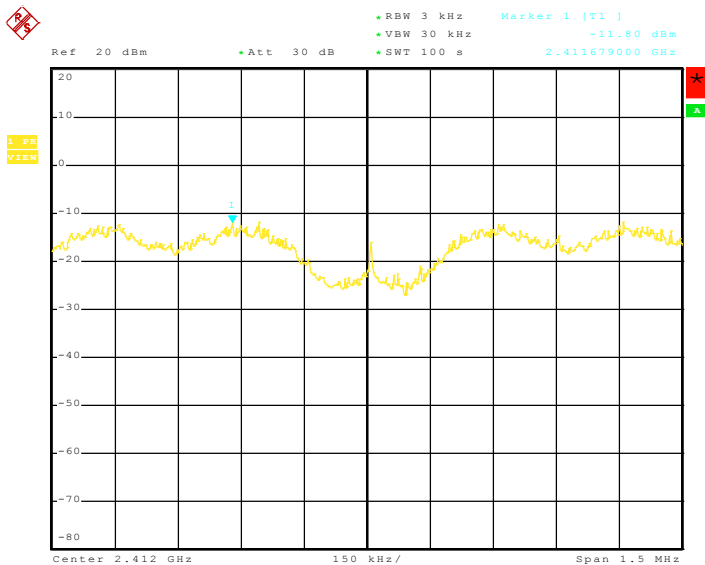

Date: 14.JUN.2011 10:49:42

IEEE 802.11n MCS8 20MHz Ant.1/2412MHZ
(Channel: Low)

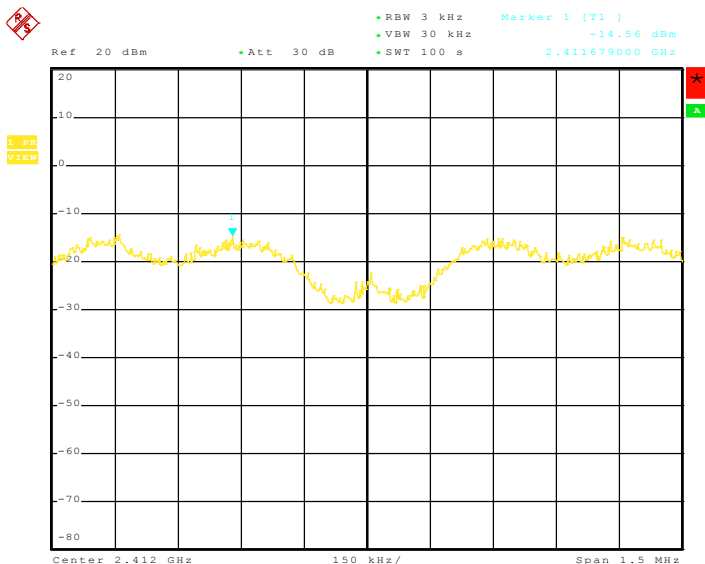

Date: 21.AUG.2011 11:44:07

IEEE 802.11n MCS8 20MHz Ant.0/2437MHZ (Channel: Mid)

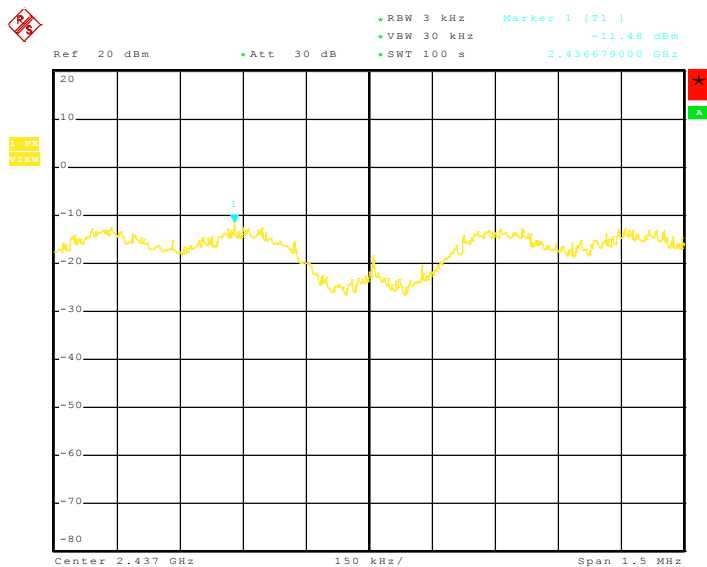

Date: 14.JUN.2011 10:58:56

IEEE 802.11n MCS8 20MHz Ant.1/2437MHZ (Channel: Mid)

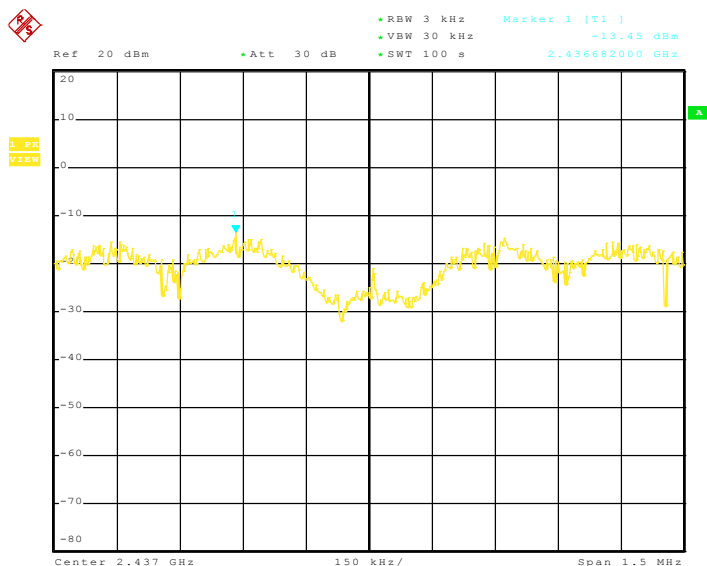

Date: 21.AUG.2011 12:07:57

IEEE 802.11n MCS8 20MHz Ant.0/2462MHZ
(Channel: High)

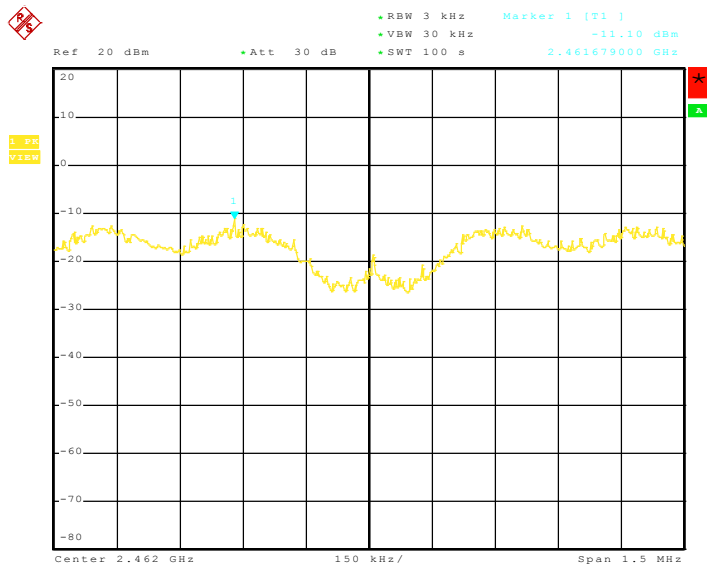

Date: 14.JUN.2011 11:10:06

IEEE 802.11n MCS8 20MHz Ant.1/2462MHZ
(Channel: High)

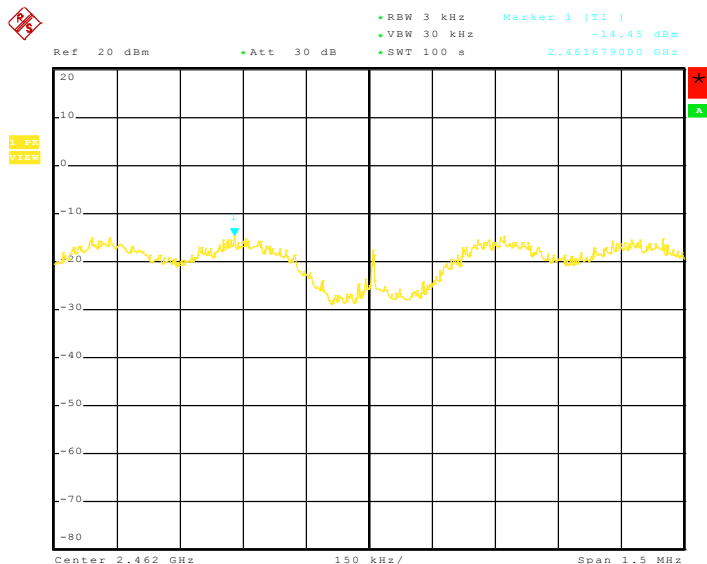

Date: 21.AUG.2011 12:12:23

IEEE 802.11n MCS8 40MHz Ant.0/2422MHZ
(Channel: Low)

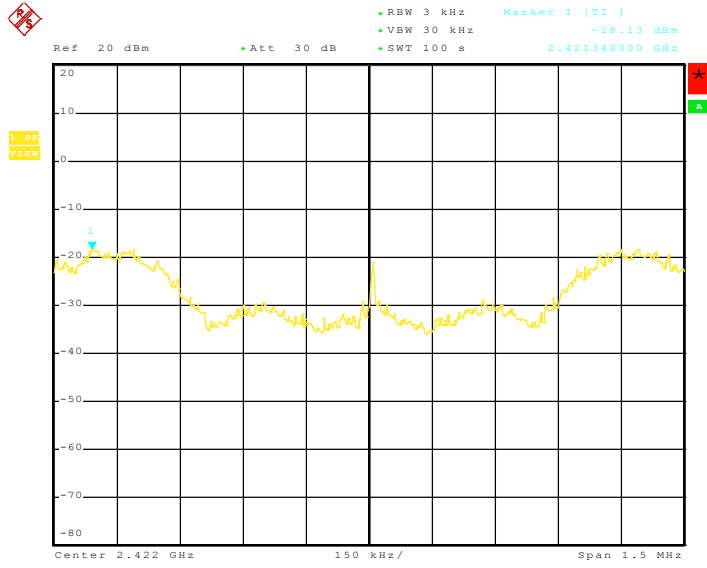

Date: 14.JUN.2011 11:25:06

IEEE 802.11n MCS8 40MHz Ant.1/2422MHZ
(Channel: Low)

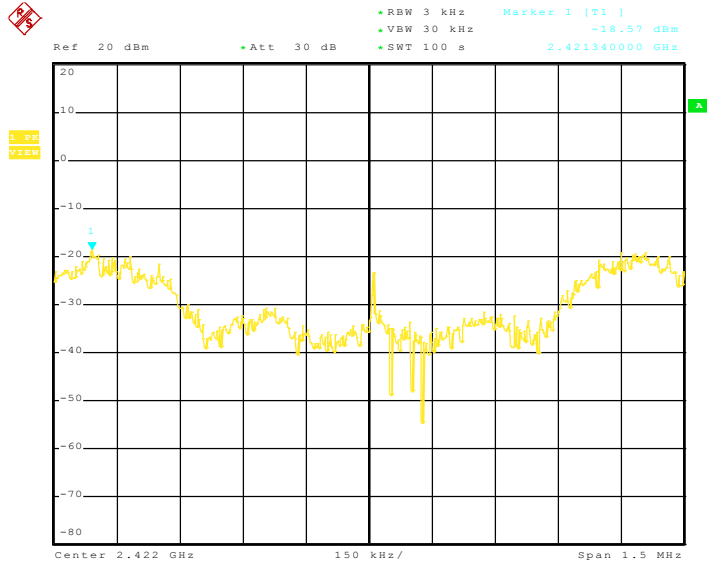

Date: 21.AUG.2011 12:26:11

IEEE 802.11n MCS8 40MHz Ant.0/2437MHZ
(Channel: Mid)

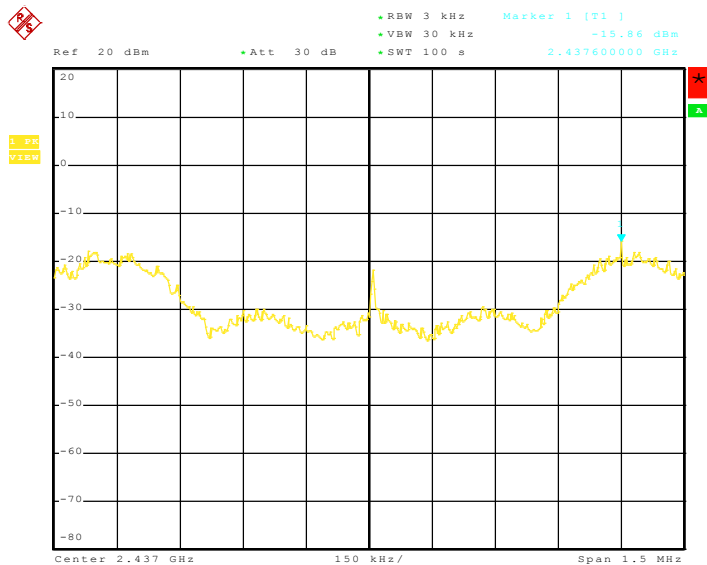

Date: 14.JUN.2011 11:33:20

IEEE 802.11n MCS8 40MHz Ant.1/2437MHZ
(Channel: Mid)

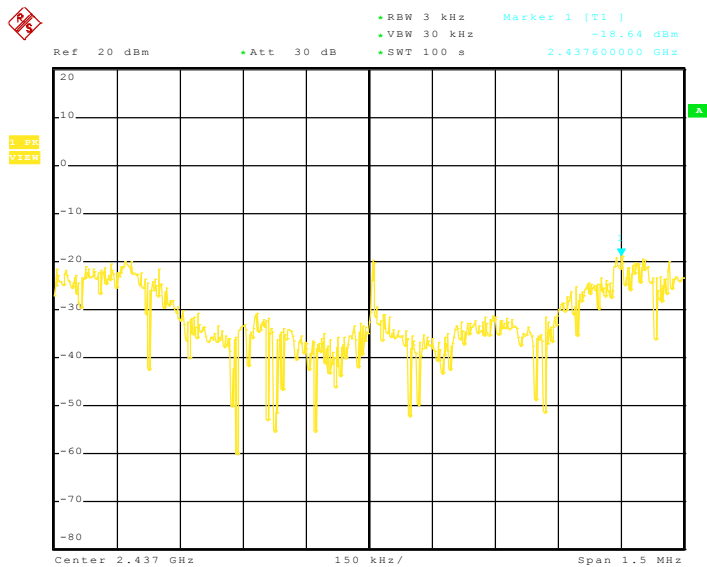

Date: 21.AUG.2011 12:55:02

IEEE 802.11n MCS8 40MHz Ant.0/2452MHZ
(Channel: High)

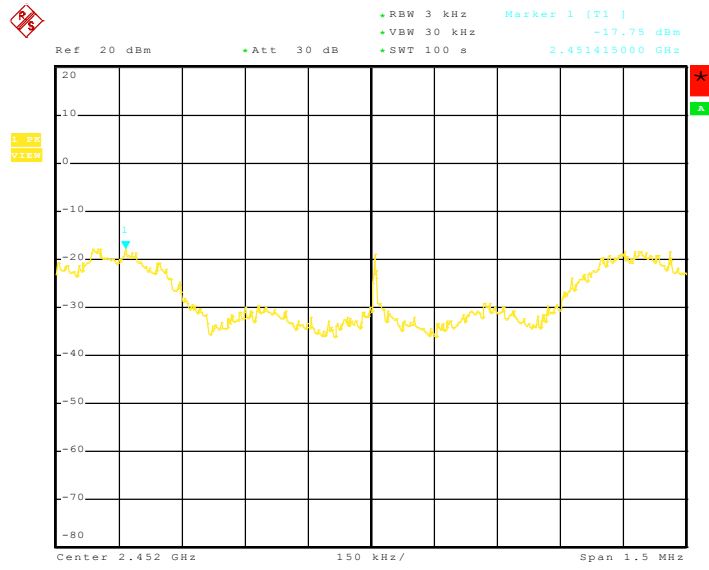

Date: 14.JUN.2011 11:37:16

IEEE 802.11n MCS8 40MHz Ant.1/2452MHZ
(Channel: High)

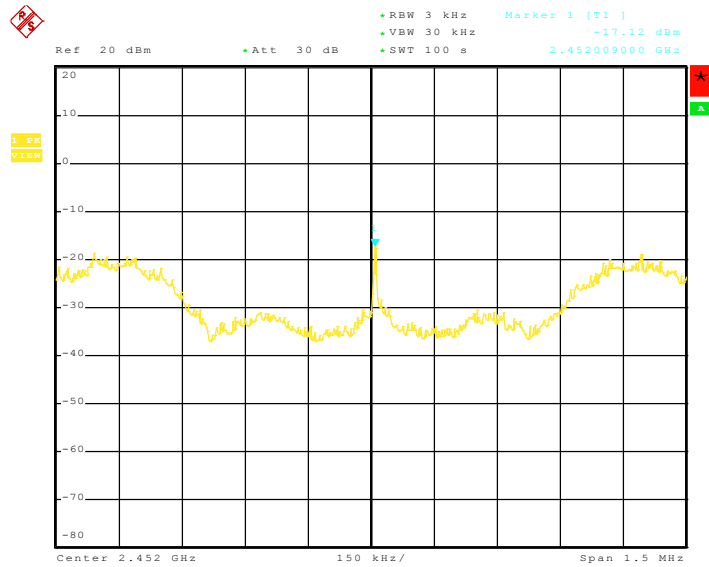

Date: 21.AUG.2011 12:59:43

6. Transmitter Spurious Radiated Emission at 3 Meters

6.1 Test Equipment

Please refer to Section 10 this report.

6.2 Test Procedure

1. The EUT was tested according to ANSI C63.4 - 2003.
2. The EUT, peripherals were put on the turntable which table size is 1m x 1.5 m, table high 0.8 m. All set up is according to ANSI C63.4-2003.
3. The frequency spectrum from 30 MHz to 1 GHz was investigated. All readings from 30 MHz to 1 GHz are quasi-peak values with a resolution bandwidth of 120 KHz. All readings are above 1 GHz , peak values with a resolution bandwidth of 1 MHz . Measurements were made at 3 meters.
4. The antenna high is varied from 1 m to 4 m high to find the maximum emission for each frequency.
5. Maximizing procedure was performed on the six (6) highest emissions to ensure EUT compliance is with all installation combinations. All data was recorded in the peak detection mode. Quasi-peak readings was performed only when an emission was found to be marginal (within -4 dB of specification limit), and are distinguished with a "QP" in the data table.
6. The antenna polarization: Vertical polarization and Horizontal polarization.

6.3 Test Setup

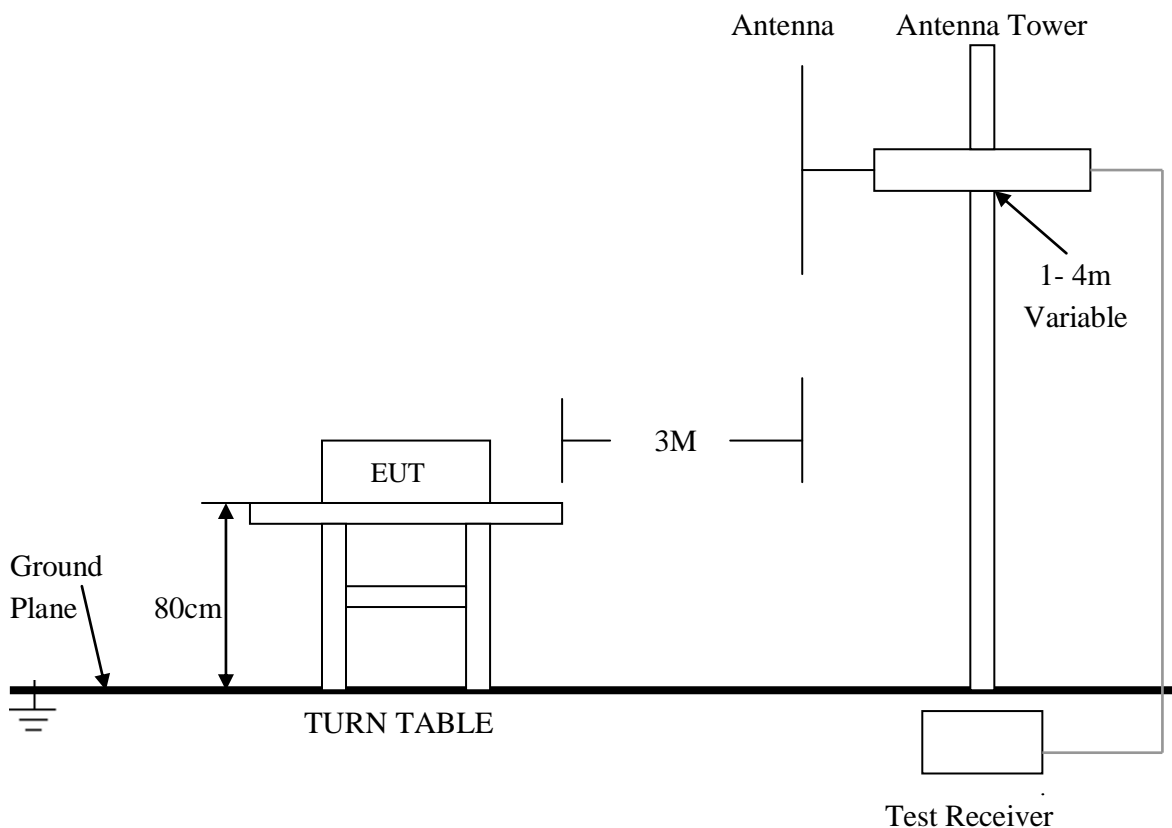

For the actual test configuration , please refer to the related items – Photos of Testing

6.4 Configuration of the EUT

Same as section 4.4 of this report

6.5 EUT Operating Condition

Same as section 4.5 of this report.

6.6 Limit

In any 100 KHz bandwidth outside the operating frequency band, the radio frequency power that is produced by modulation products of the spreading sequence, the information sequence and the carrier frequency shall be either at least 20 dB below that in any 100 KHz bandwidth within the band that contains the highest level of the desired power or shall not exceed the general levels specified in section 15.209(a), which lesser attenuation.

All other emissions inside restricted bands specified in section 15.205(a) shall not exceed the general radiated emission limits specified in section 15.209(a)

Note:

Applies to harmonics/spurious emissions that fall in the restricted bands listed in section 15.205. The maximum permitted average field strength is listed in section 15.209.

47 CFR § 15.237(c): The emission limits as specified above are based on measurement instrument employing an average detector. The provisions in section 15.35 for limiting peak emissions apply.

FCC CFR 47, Part 15, Subpart C, Para, 15.205(a) – Restricted Frequency Bands

MHz	MHz	MHz	GHz
0.090–0.110	16.42–16.423	399.9–410	4.5–5.15
10.495–0.505	16.69475–16.69525	608–614	5.35–5.46
2.1735–2.1905	16.80425–16.80475	960–1240	7.25–7.75
4.125–4.128	25.5–25.67	1300–1427	8.025–8.5
4.17725–4.17775	37.5–38.25	1435–1626.5	9.0–9.2
4.20725–4.20775	73–74.6	1645.5–1646.5	9.3–9.5
6.215–6.218	74.8–75.2	1660–1710	10.6–12.7
6.26775–6.26825	108–121.94	1718.8–1722.2	13.25–13.4
6.31175–6.31225	123–138	2200–2300	14.47–14.5
8.291–8.294	149.9–150.05	2310–2390	15.35–16.2
8.362–8.366	156.52475–156.52525	2483.5–2500	17.7–21.4
8.37625–8.38675	156.7–156.9	2655–2900	22.01–23.12
8.41425–8.41475	162.0125–167.17	3260–3267	23.6–24.0
12.29–12.293	167.72–173.2	3332–3339	31.2–31.8
12.51975–12.52025	240–285	3345.8–3358	36.43–36.5
12.57675–12.57725	322–335.4	3600–4400	(2)
13.36–13.41.			

¹ Until February 1, 1999, this restricted band shall be 0.490–0.510 MHz.

² Above 38.6

FCC 47 CFR, Part 15.209(a) – Field Strength Limits within Restricted Frequency Bands

Frequency (MHz)	Field strength (microvolts/meter)	Measurement distance (meters)
0.009–0.490	2400/F(kHz)	300
0.490–1.705	24000/F(kHz)	30
1.705–30.0	30	30
30–88	100**	3
88–216	150**	3
216–960	200**	3
Above 960	500	3

6. 7 Test Result

Product : ADSL2+ 4 Port Router WIFI Test Mode : IEEE 802.11b/g/Draftn
 802.11B/G/N 2X2
 Test Item : Spurious Radiated Emissions Temperature : 25 °C
 Test Voltage : DC 12V (Power by Adapter Supply) Humidity : 56%RH
 Test Result : **PASS**

2dBi Antenna:

IEEE 802.11b Channel: Low

Freq. (MHz)	Emission (dBuV/m) Peak Detector	HORIZ / VERT	Limits (dBuV/m) Peak / Average	Margin (dB)
4824.00	49.11	HORZ	74.0 / 54.0	-24.89
4824.00	48.21	VERT	74.0 / 54.0	-25.79
7236.00	49.65	HORZ	74.0 / 54.0	-24.35
7236.08	48.01	VERT	74.0 / 54.0	-25.99
9648.02	49.02	HORZ	74.0 / 54.0	-24.98
9648.10	47.86	VERT	74.0 / 54.0	-26.14
24120.04	-	HORZ	74.0 / 54.0	-
24120.20	-	VERT	74.0 / 54.0	-

IEEE 802.11b Channel: Mid

Freq. (MHz)	Emission (dBuV/m) Peak Detector	HORIZ / VERT	Limits (dBuV/m) Peak / Average	Margin (dB)
4874.00	49.23	HORZ	74.0 / 54.0	-24.77
4874.00	48.01	VERT	74.0 / 54.0	-25.99
7311.00	49.32	HORZ	74.0 / 54.0	-24.68
7311.02	48.53	VERT	74.0 / 54.0	-25.47
9748.10	49.34	HORZ	74.0 / 54.0	-24.66
9748.00	47.22	VERT	74.0 / 54.0	-26.78
24370.10	-	HORZ	74.0 / 54.0	-
24370.00	-	VERT	74.0 / 54.0	-

IEEE 802.11b Channel: High

Freq. (MHz)	Emission (dBuV/m) Peak Detector	HORIZ / VERT	Limits (dBuV/m) Peak / Average	Margin (dB)
4924.00	49.13	HORZ	74.0 / 54.0	-24.87
4924.00	48.55	VERT	74.0 / 54.0	-25.45
7386.12	49.61	HORZ	74.0 / 54.0	-24.39
7368.00	48.98	VERT	74.0 / 54.0	-25.02
9848.00	49.11	HORZ	74.0 / 54.0	-24.89
9848.00	47.52	VERT	74.0 / 54.0	-26.48
24620.11	-	HORZ	74.0 / 54.0	-
24620.00	-	VERT	74.0 / 54.0	-

5dBi Antenna:

IEEE 802.11b Channel: Low

Freq. (MHz)	Emission (dBuV/m) Peak Detector	HORIZ / VERT	Limits (dBuV/m) Peak / Average	Margin (dB)
4824.00	51.66	HORZ	74.0 / 54.0	-22.34
4824.00	51.15	VERT	74.0 / 54.0	-22.85
7236.00	51.34	HORZ	74.0 / 54.0	-22.66
7236.08	51.21	VERT	74.0 / 54.0	-22.79
9648.02	51.78	HORZ	74.0 / 54.0	-22.22
9648.10	51.12	VERT	74.0 / 54.0	-22.88
24120.04	-	HORZ	74.0 / 54.0	-
24120.20	-	VERT	74.0 / 54.0	-

IEEE 802.11b Channel: Mid

Freq. (MHz)	Emission (dBuV/m) Peak Detector	HORIZ / VERT	Limits (dBuV/m) Peak / Average	Margin (dB)
4874.00	52.06	HORZ	74.0 / 54.0	-21.94
4874.00	51.88	VERT	74.0 / 54.0	-22.12
7311.00	50.98	HORZ	74.0 / 54.0	-23.02
7311.02	51.45	VERT	74.0 / 54.0	-22.55
9748.10	52.1	HORZ	74.0 / 54.0	-21.90
9748.00	51.67	VERT	74.0 / 54.0	-22.33
24370.10	-	HORZ	74.0 / 54.0	-
24370.00	-	VERT	74.0 / 54.0	-

IEEE 802.11b Channel: High

Freq. (MHz)	Emission (dBuV/m) Peak Detector	HORIZ / VERT	Limits (dBuV/m) Peak / Average	Margin (dB)
4924.00	51.23	HORZ	74.0 / 54.0	-22.77
4924.00	50.12	VERT	74.0 / 54.0	-23.88
7386.12	51.86	HORZ	74.0 / 54.0	-22.14
7368.00	50.35	VERT	74.0 / 54.0	-23.65
9848.00	50.48	HORZ	74.0 / 54.0	-23.52
9848.00	49.19	VERT	74.0 / 54.0	-24.81
24620.11	-	HORZ	74.0 / 54.0	-
24620.00	-	VERT	74.0 / 54.0	-

- Note:**
- (1) All Reading Levels below 1GHz are Quasi-Peak, above are peak and average value.
 - (2) Emission Level = Reading Level + Probe Factor + Cable Loss.
 - (3) Receiver setting (Peak Detector) : RBW=1MHz; VBW=1MHz; Span=100MHz
 - (4) Receiver setting (AVG Detector): RBW=1MHz; VBW=30Hz; Span=20MHz
 - (5) The average measurement was not performed when the peak measured data under the limit of average detection. If the readings given are average, peak measurement should also be supplied.
 - (6) Where an emission level is indicated by a -, levels had a margin greater than 20 dB when compared to the limit.

2dBi Antenna:

IEEE 802.11g Channel: Low

Freq. (MHz)	Emission (dBuV/m) Peak	HORIZ / VERT	Limits (dBuV/m) Peak / Average	Margin (dB)
4824.00	49.44	HORZ	74.0 / 54.0	-24.56
4824.00	48.38	VERT	74.0 / 54.0	-25.62
7236.00	49.78	HORZ	74.0 / 54.0	-24.22
7236.08	47.36	VERT	74.0 / 54.0	-26.64
9648.02	48.88	HORZ	74.0 / 54.0	-25.12
9648.10	47.24	VERT	74.0 / 54.0	-26.76
24120.04	-	HORZ	74.0 / 54.0	-
24120.20	-	VERT	74.0 / 54.0	-

IEEE 802.11g Channel: Mid

Freq. (MHz)	Emission (dBuV/m) Peak	HORIZ / VERT	Limits (dBuV/m) Peak / Average	Margin (dB)
4874.00	50.14	HORZ	74.0 / 54.0	-23.86
4874.00	48.38	VERT	74.0 / 54.0	-25.62
7311.00	49.06	HORZ	74.0 / 54.0	-24.94
7311.02	47.65	VERT	74.0 / 54.0	-26.35
9748.10	48.48	HORZ	74.0 / 54.0	-25.52
9748.00	47.56	VERT	74.0 / 54.0	-26.44
24370.10	-	HORZ	74.0 / 54.0	-
24370.00	-	VERT	74.0 / 54.0	-

IEEE 802.11g Channel: High

Freq. (MHz)	Emission (dBuV/m) Peak	HORIZ / VERT	Limits (dBuV/m) Peak / Average	Margin (dB)
4924.00	49.77	HORZ	74.0 / 54.0	-24.23
4924.00	48.44	VERT	74.0 / 54.0	-25.56
7386.12	48.56	HORZ	74.0 / 54.0	-25.44
7368.00	47.18	VERT	74.0 / 54.0	-26.82
9848.00	48.87	HORZ	74.0 / 54.0	-25.13
9848.00	47.22	VERT	74.0 / 54.0	-26.78
24620.11	-	HORZ	74.0 / 54.0	-
24620.00	-	VERT	74.0 / 54.0	-

5dBi Antenna:

IEEE 802.11g Channel: Low

Freq. (MHz)	Emission (dBuV/m) Peak	HORIZ / VERT	Limits (dBuV/m) Peak / Average	Margin (dB)
4824.00	52.12	HORZ	74.0 / 54.0	-21.88
4824.00	51.54	VERT	74.0 / 54.0	-22.46
7236.00	51.22	HORZ	74.0 / 54.0	-22.78
7236.08	50.36	VERT	74.0 / 54.0	-23.64
9648.02	51.79	HORZ	74.0 / 54.0	-22.21
9648.10	50.18	VERT	74.0 / 54.0	-23.82
24120.04	-	HORZ	74.0 / 54.0	-
24120.20	-	VERT	74.0 / 54.0	-

IEEE 802.11g Channel: Mid

Freq. (MHz)	Emission (dBuV/m) Peak	HORIZ / VERT	Limits (dBuV/m) Peak / Average	Margin (dB)
4874.00	52.38	HORZ	74.0 / 54.0	-21.62
4874.00	51.44	VERT	74.0 / 54.0	-22.56
7311.00	50.94	HORZ	74.0 / 54.0	-23.06
7311.02	49.78	VERT	74.0 / 54.0	-24.22
9748.10	50.38	HORZ	74.0 / 54.0	-23.62
9748.00	50.14	VERT	74.0 / 54.0	-23.86
24370.10	-	HORZ	74.0 / 54.0	-
24370.00	-	VERT	74.0 / 54.0	-

IEEE 802.11g Channel: High

Freq. (MHz)	Emission (dBuV/m) Peak	HORIZ / VERT	Limits (dBuV/m) Peak / Average	Margin (dB)
4924.00	51.78	HORZ	74.0 / 54.0	-22.22
4924.00	50.44	VERT	74.0 / 54.0	-23.56
7386.12	51.38	HORZ	74.0 / 54.0	-22.62
7368.00	50.22	VERT	74.0 / 54.0	-23.78
9848.00	51.78	HORZ	74.0 / 54.0	-22.22
9848.00	50.14	VERT	74.0 / 54.0	-23.86
24620.11	-	HORZ	74.0 / 54.0	-
24620.00	-	VERT	74.0 / 54.0	-

- Note:**
- (1) All Reading Levels below 1GHz are Quasi-Peak, above are peak and average value.
 - (2) Emission Level = Reading Level + Probe Factor + Cable Loss.
 - (3) Receiver setting (Peak Detector) : RBW=1MHz; VBW=1MHz; Span=100MHz
 - (4) Receiver setting (AVG Detector): RBW=1MHz; VBW=30Hz; Span=20MHz
 - (5) The average measurement was not performed when the peak measured data under the limit of average detection. If the readings given are average, peak measurement should also be supplied.
 - (6) Where an emission level is indicated by a -, levels had a margin greater than 20 dB when compared to the limit.

2dBi Antenna:

Draft n MCS8 20MHz Ant.0+Ant.1 Channel: Low

Freq. (MHz)	Emission (dBuV/m) Peak /Av	HORIZ / VERT	Limits (dBuV/m) Peak / Average	Margin (dB)
4824.00	49.14	HORZ	74.0 / 54.0	-24.86
4824.00	48.78	VERT	74.0 / 54.0	-25.22
7236.00	49.14	HORZ	74.0 / 54.0	-24.86
7236.08	48.58	VERT	74.0 / 54.0	-25.42
9648.02	49.16	HORZ	74.0 / 54.0	-24.84
9648.10	47.52	VERT	74.0 / 54.0	-26.48
24120.04	-	HORZ	74.0 / 54.0	-
24120.20	-	VERT	74.0 / 54.0	-

Draft n MCS8 20MHz Ant.0+Ant.1 Channel: Mid

Freq. (MHz)	Emission (dBuV/m) Peak	HORIZ / VERT	Limits (dBuV/m) Peak / Average	Margin (dB)
4874.00	49.94	HORZ	74.0 / 54.0	-24.06
4874.00	48.37	VERT	74.0 / 54.0	-25.63
7311.00	49.78	HORZ	74.0 / 54.0	-24.22
7311.02	48.15	VERT	74.0 / 54.0	-25.85
9748.10	48.64	HORZ	74.0 / 54.0	-25.36
9748.00	48.13	VERT	74.0 / 54.0	-25.87
24370.10	-	HORZ	74.0 / 54.0	-
24370.00	-	VERT	74.0 / 54.0	-

Draft n MCS8 20MHz Ant.0+Ant.1 Channel: High

Freq. (MHz)	Emission (dBuV/m) Peak /Av	HORIZ / VERT	Limits (dBuV/m) Peak / Average	Margin (dB)
4824.00	49.69	HORZ	74.0 / 54.0	-24.31
4824.00	48.11	VERT	74.0 / 54.0	-25.89
7236.00	48.74	HORZ	74.0 / 54.0	-25.26
7236.08	47.18	VERT	74.0 / 54.0	-26.82
9648.02	48.78	HORZ	74.0 / 54.0	-25.22
9648.10	47.25	VERT	74.0 / 54.0	-26.75
24120.04	-	HORZ	74.0 / 54.0	-
24120.20	-	VERT	74.0 / 54.0	-

5dBi Antenna:

Draft n MCS8 20MHz Ant.0+Ant.1 Channel: Low

Freq. (MHz)	Emission (dBuV/m) Peak /Av	HORIZ / VERT	Limits (dBuV/m) Peak / Average	Margin (dB)
4824.00	51.66	HORZ	74.0 / 54.0	-22.34
4824.00	51.45	VERT	74.0 / 54.0	-22.55
7236.00	51.28	HORZ	74.0 / 54.0	-22.72
7236.08	51.44	VERT	74.0 / 54.0	-22.56
9648.02	51.78	HORZ	74.0 / 54.0	-22.22
9648.10	51.05	VERT	74.0 / 54.0	-22.95
24120.04	-	HORZ	74.0 / 54.0	-
24120.20	-	VERT	74.0 / 54.0	-

Draft n MCS8 20MHz Ant.0+Ant.1 Channel: Mid

Freq. (MHz)	Emission (dBuV/m) Peak	HORIZ / VERT	Limits (dBuV/m) Peak / Average	Margin (dB)
4874.00	51.78	HORZ	74.0 / 54.0	-22.22
4874.00	50.22	VERT	74.0 / 54.0	-23.78
7311.00	51.68	HORZ	74.0 / 54.0	-22.32
7311.02	50.74	VERT	74.0 / 54.0	-23.26
9748.10	50.48	HORZ	74.0 / 54.0	-23.52
9748.00	49.38	VERT	74.0 / 54.0	-24.62
24370.10	-	HORZ	74.0 / 54.0	-
24370.00	-	VERT	74.0 / 54.0	-

Draft n MCS8 20MHz Ant.0+Ant.1 Channel: High

Freq. (MHz)	Emission (dBuV/m) Peak /Av	HORIZ / VERT	Limits (dBuV/m) Peak / Average	Margin (dB)
4824.00	51.44	HORZ	74.0 / 54.0	-22.56
4824.00	50.83	VERT	74.0 / 54.0	-23.17
7236.00	50.98	HORZ	74.0 / 54.0	-23.02
7236.08	50.12	VERT	74.0 / 54.0	-23.88
9648.02	50.87	HORZ	74.0 / 54.0	-23.13
9648.10	50.66	VERT	74.0 / 54.0	-23.34
24120.04	-	HORZ	74.0 / 54.0	-
24120.20	-	VERT	74.0 / 54.0	-

- Note:**
- (1) All Reading Levels below 1GHz are Quasi-Peak, above are peak and average value.
 - (2) Emission Level = Reading Level + Probe Factor + Cable Loss.
 - (3) Receiver setting (Peak Detector) : RBW=1MHz; VBW=1MHz; Span=100MHz
 - (4) Receiver setting (AVG Detector): RBW=1MHz; VBW=30Hz; Span=20MHz
 - (5) The average measurement was not performed when the peak measured data under the limit of average detection. If the readings given are average, peak measurement should also be supplied.
 - (6) Where an emission level is indicated by a -, levels had a margin greater than 20 dB when compared to the limit.

2dBi Antenna:

Draft n MCS8 40MHz Ant.0+Ant.1 Channel: Low

Freq. (MHz)	Emission (dBuV/m) Peak /Av	HORIZ / VERT	Limits (dBuV/m) Peak / Average	Margin (dB)
4844.00	49.74	HORZ	74.0 / 54.0	-24.26
4844.00	48.66	VERT	74.0 / 54.0	-25.34
7266.00	49.38	HORZ	74.0 / 54.0	-24.62
7266.08	47.36	VERT	74.0 / 54.0	-26.64
9688.02	48.88	HORZ	74.0 / 54.0	-25.12
9688.10	47.34	VERT	74.0 / 54.0	-26.66
24220.04	-	HORZ	74.0 / 54.0	-
24220.20	-	VERT	74.0 / 54.0	-

Draft n MCS8 40MHz Ant.0+Ant.1 Channel: Mid

Freq. (MHz)	Emission (dBuV/m) Peak	HORIZ / VERT	Limits (dBuV/m) Peak / Average	Margin (dB)
4874.00	49.94	HORZ	74.0 / 54.0	-24.06
4874.00	48.38	VERT	74.0 / 54.0	-25.62
7311.00	48.91	HORZ	74.0 / 54.0	-25.09
7311.02	47.65	VERT	74.0 / 54.0	-26.35
9748.10	48.84	HORZ	74.0 / 54.0	-25.16
9748.00	47.44	VERT	74.0 / 54.0	-26.56
24370.10	-	HORZ	74.0 / 54.0	-
24370.00	-	VERT	74.0 / 54.0	-

Draft n MCS8 40MHz Ant.0+Ant.1 Channel: High

Freq. (MHz)	Emission (dBuV/m) Peak /Av	HORIZ / VERT	Limits (dBuV/m) Peak / Average	Margin (dB)
4904.00	49.78	HORZ	74.0 / 54.0	-24.22
4904.00	48.44	VERT	74.0 / 54.0	-25.56
7356.12	48.56	HORZ	74.0 / 54.0	-25.44
7356.00	47.18	VERT	74.0 / 54.0	-26.82
9808.00	48.87	HORZ	74.0 / 54.0	-25.13
9808.00	47.38	VERT	74.0 / 54.0	-26.62
24520.11	-	HORZ	74.0 / 54.0	-
24520.00	-	VERT	74.0 / 54.0	-

5dBi Antenna:

Draft n MCS8 40MHz Ant.0+Ant.1 Channel: Low

Freq. (MHz)	Emission (dBuV/m) Peak /Av	HORIZ / VERT	Limits (dBuV/m) Peak / Average	Margin (dB)
4844.00	52.14	HORZ	74.0 / 54.0	-21.86
4844.00	51.54	VERT	74.0 / 54.0	-22.46
7266.00	51.22	HORZ	74.0 / 54.0	-22.78
7266.08	50.36	VERT	74.0 / 54.0	-23.64
9688.02	51.78	HORZ	74.0 / 54.0	-22.22
9688.10	50.38	VERT	74.0 / 54.0	-23.62
24220.04	-	HORZ	74.0 / 54.0	-
24220.20	-	VERT	74.0 / 54.0	-

Draft n MCS8 40MHz Ant.0+Ant.1 Channel: Mid

Freq. (MHz)	Emission (dBuV/m) Peak	HORIZ / VERT	Limits (dBuV/m) Peak / Average	Margin (dB)
4874.00	52.34	HORZ	74.0 / 54.0	-21.66
4874.00	51.78	VERT	74.0 / 54.0	-22.22
7311.00	50.94	HORZ	74.0 / 54.0	-23.06
7311.02	49.87	VERT	74.0 / 54.0	-24.13
9748.10	50.76	HORZ	74.0 / 54.0	-23.24
9748.00	50.38	VERT	74.0 / 54.0	-23.62
24370.10	-	HORZ	74.0 / 54.0	-
24370.00	-	VERT	74.0 / 54.0	-

Draft n MCS8 40MHz Ant.0+Ant.1 Channel: High

Freq. (MHz)	Emission (dBuV/m) Peak /Av	HORIZ / VERT	Limits (dBuV/m) Peak / Average	Margin (dB)
4904.00	51.98	HORZ	74.0 / 54.0	-22.02
4904.00	50.26	VERT	74.0 / 54.0	-23.74
7356.12	51.44	HORZ	74.0 / 54.0	-22.56
7356.00	50.35	VERT	74.0 / 54.0	-23.65
9808.00	51.85	HORZ	74.0 / 54.0	-22.15
9808.00	50.18	VERT	74.0 / 54.0	-23.82
24520.11	-	HORZ	74.0 / 54.0	-
24520.00	-	VERT	74.0 / 54.0	-

- Note:**
- (1) All Reading Levels below 1GHz are Quasi-Peak, above are peak and average value.
 - (2) Emission Level = Reading Level + Probe Factor + Cable Loss.
 - (3) Receiver setting (Peak Detector) : RBW=1MHz; VBW=1MHz; Span=100MHz
 - (4) Receiver setting (AVG Detector): RBW=1MHz; VBW=30Hz; Span=20MHz
 - (5) The average measurement was not performed when the peak measured data under the limit of average detection. If the readings given are average, peak measurement should also be supplied.
 - (6) Where an emission level is indicated by a -, levels had a margin greater than 20 dB when compared to the limit.

General Radiated Emission Data

Product : ADSL2+ 4 Port Router WIFI Test Mode : 802.11b_CH Mid
 : 802.11B/G/N 2X2
 Test Item : Fundamental Radiated Emission Data Temperature : 25 °C
 Test Voltage : DC 12V(by DC Adapter) Humidity : 56%RH
 Test Result : **PASS** Model :

2dBi Antenna:

Freq. (MHz)	Emission (dBuV/m) QP Detector	HORIZ / VERT	Limits (dBuV/m)	Margin (dB)
280.800	38.01	HORZ	46.0	-7.99
53.040	30.01	VERT	40.0	-9.99
296.440	39.12	HORZ	46.0	-6.88
160.000	32.18	VERT	43.5	-11.32
640.000	34.51	HORZ	46.0	-11.49
296.040	36.15	VERT	46.0	-9.85

5dBi Antenna:

Freq. (MHz)	Emission (dBuV/m) QP Detector	HORIZ / VERT	Limits (dBuV/m)	Margin (dB)
282.280	37.79	HORZ	46.0	-8.21
52.600	28.94	VERT	40.0	-11.06
287.040	36.16	HORZ	46.0	-9.84
58.200	31.28	VERT	40.0	-8.72
500.000	42.69	HORZ	46.0	-3.31
284.360	34.47	VERT	46.0	-11.53

- Note:**
- (1) All Readings below 1GHz are Quasi-Peak, above are performed with peak and/or average measurements as necessary.
 - (2) Emission Level = Reading Level + Probe Factor + Cable Loss.

7. RF Exposure Requirements

7.1 Test Equipment

Please refer to Section 10 this report.

7.2 Limit

According to FCC 15.247(i), Systems operating under provisions of this section shall be operated in a manner that ensures that the public is not exposed to radio frequency energy levels in excess of the Commissions guidelines.

FCC 1.1310: The criteria listed in the following table shall be used to evaluate the environmental impact of human exposure to radio-frequency (RF) radiation as specified in 1.1307(b)(1) of this chapter.

TABLE 1—LIMITS FOR MAXIMUM PERMISSIBLE EXPOSURE (MPE)

Frequency range (MHz)	Electric field strength (V/m)	Magnetic field strength (A/m)	Power density (mW/cm ²)	Averaging time (minutes)
(A) Limits for Occupational/Controlled Exposures				
0.3–3.0	614	1.63	*(100)	6
3.0–30	1842/f	4.89/f	*(900/f ²)	6
30–300	61.4	0.163	1.0	6
300–1500			f/300	6
1500–100,000			5	6
(B) Limits for General Population/Uncontrolled Exposure				
0.3–1.34	614	1.63	*(100)	30
1.34–30	824/f	2.19/f	*(180/f ²)	30
30–300	27.5	0.073	0.2	30
300–1500			f/1500	30
1500–100,000			1.0	30

f = frequency in MHz

* = Plane-wave equivalent power density

NOTE 1 TO TABLE 1: Occupational/controlled limits apply in situations in which persons are exposed as a consequence of their employment provided those persons are fully aware of the potential for exposure and can exercise control over their exposure. Limits for occupational/controlled exposure also apply in situations when an individual is transient through a location where occupational/controlled limits apply provided he or she is made aware of the potential for exposure.

NOTE 2 TO TABLE 1: General population/uncontrolled exposures apply in situations in which the general public may be exposed, or in which persons that are exposed as a consequence of their employment may not be fully aware of the potential for exposure or can not exercise control over their exposure.

7.3 Test Result

Product	: ADSL2+ 4 Port Router WIFI 802.11B/G/N 2X2	Test Mode	: IEEE 802.11b/g
Test Item	: RF Exposure	Temperature	: 25 °C
Test Voltage	: DC 12V (Power by DC Power Supply)	Humidity	: 56% RH
Test Result	: PASS		

Evaluation of RF Exposure Compliance Requirements MPE Prediction of MPE according to equation from page 19 of OET Bulletin 65, Edition 97-01	
RF Exposure Requirements	Compliance with FCC Rules
S=PG/4πR ² Where: S=Power density P=Power input to antenna G=Power gain of the antenna relative to an isotropic radiator R=Distance to the center of radiation of the antenna	Maximum output power at antenna input terminal: 22.96 dBm =197.70 mW (802.11b/g, 2462MHz) 24.18 dBm = 261.79 mW (Draft n, 2462MHz,20MHz) 23.80 dBm = 239.99 mW (Draft n, 2422MHz,40MHz) Prediction distance: 20 cm Antenna gain : 802.11b/g(5.0 dBi); 802.11n(8.01 dBi) MPE limit for uncontrolled exposure at prediction frequency: 10 W/m ² Power density at 20 cm: 802.11b/g: 0.1244 mW/cm ² Draft n(20MHz) : 0.3294 mW/cm ² Draft n(40MHz) : 0.3019 mW/cm ²

8. Photos of Testing

8.1 EUT Test Photographs

Conducted emission test view



Radiated emission test view





8. 2 EUT Detailed Photographs

EUT top view



EUT bottom view





EUT inside whole view

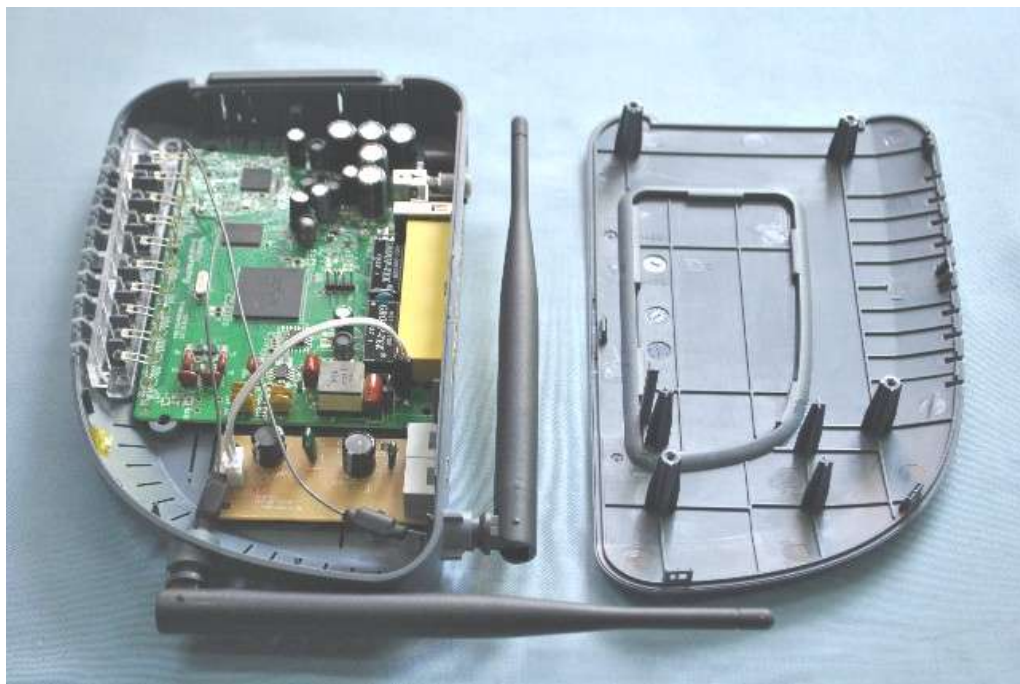

Main & RF board component side

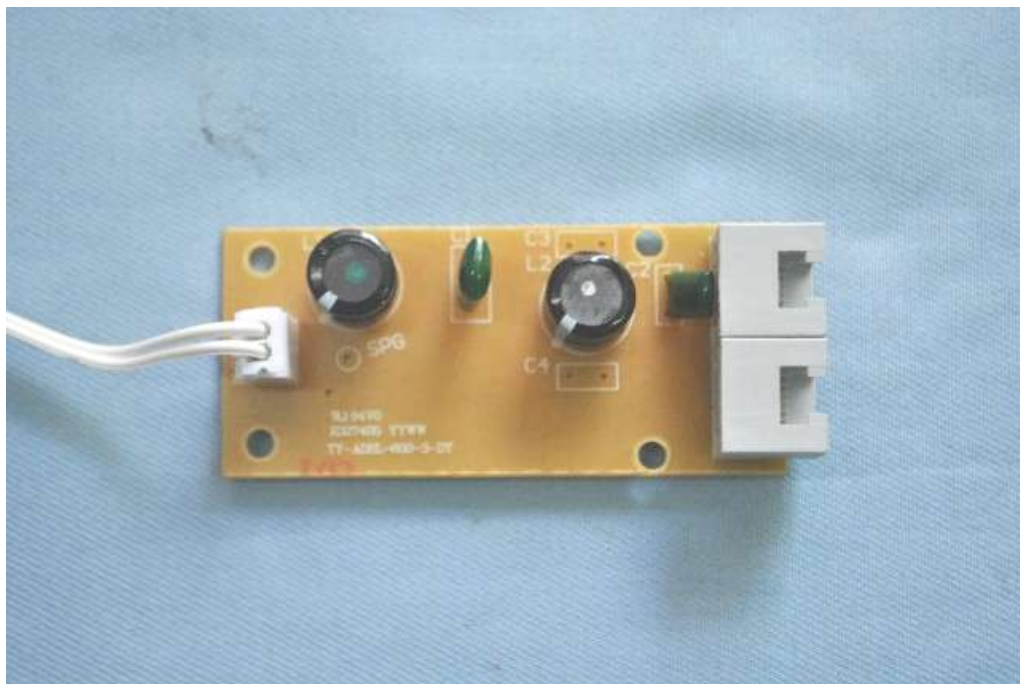
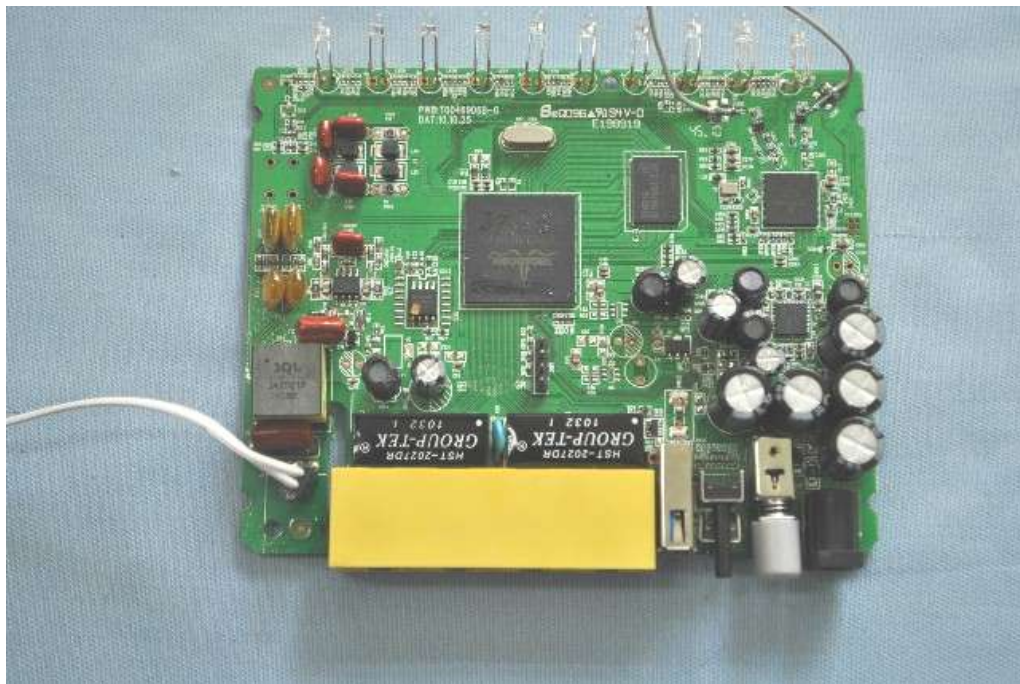

Main & RF board solder side

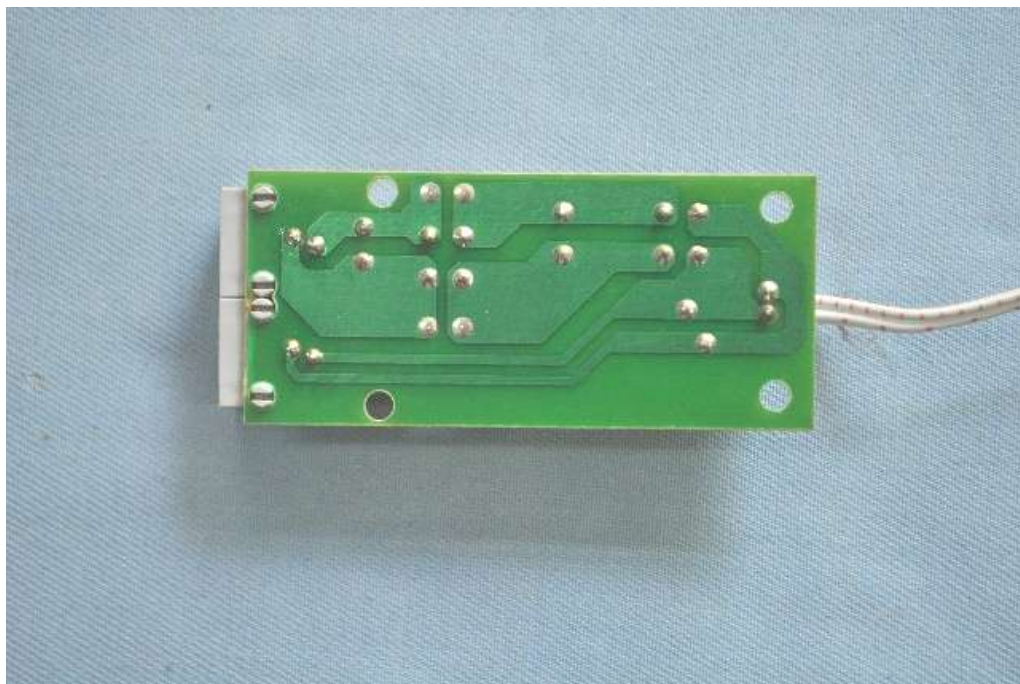

9. FCC ID Label

FCC ID: RS36519A1A2

This device complies with Part 15 of the FCC Rules. Operation is subject to the following two conditions: (1) this device may not cause harmful interference, and (2) this device must accept any interference received, including interference that may cause undesired operation.

The Label must not be a stick-on paper label. The Label on these products must be permanently affixed to the product and readily visible at the time of purchase and must last the expected lifetime of the equipment not be readily detachable.

Proposed Label Location on EUT

EUT Bottom View/Proposed FCC ID Label Location

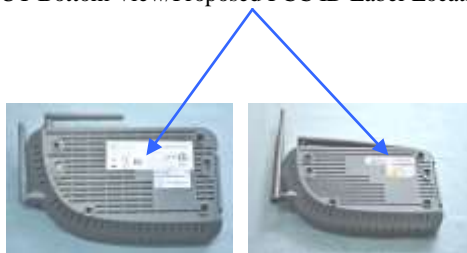

10. Test Equipment

The following test equipments were used during the radiated & conducted emission test:

Equipment/ Facilities	Manufacturer	Model #	Serial No.	Due Date
Turntable	SinTek	N/A	N/A	NCR
Antenna Tower	SinTek	N/A	N/A	NCR
OATS	SinTek	N/A	N/A	Oct. 9, 2011
Bilog Antenna	SCHAFFNER	CBL6111C	2775	June 12, 2012
Pre-Amplifier	HP	8449B	3008B00965	June 12, 2012
Horn Antenna	EMCO	3115	9602-4659	June 12, 2012
Horn Antenna	Rohde & Schwarz	AT4560	SB3435/03	May 4, 2012
EMI Test Receiver	Rohde & Schwarz	ESPI7	100013	June 01, 2012
Spectrum Analyzer	Rohde & Schwarz	FSP40	100273	May 27, 2012
Signal Generator	FLUKE	PM5418+Y/C	LO747012	May 27, 2012
Loop Antenna	Rohde & Schwarz	HFH2-Z2	872096/16	Jan. 30, 2012
Trilog-Super Broadband Antenna	SCHWARZBECK	VULB9161	9161-4079	Sep.18, 2011
Trilog-Super Broadband Antenna	SCHWARZBECK	VULB9161	9161-4080	Sep.18, 2011
Broad-Band Horn Antenna	SCHWARZBECK	BBHA 9120D	9120D-564	Sep.18, 2011
Broad-Band Horn Antenna	SCHWARZBECK	BBHA 9120D	9120D-565	Sep.18, 2011
AMN	Rohde & Schwarz	ESH3-Z5	100197	May 27, 2012
Pulse Limiter	SCHWARZBECK	VTSD 9561-F	9604	Nov.29, 2011
ISN	SCHWARZBECK	NTFM 8158 CAT3	CAT 3 8158-0010	Nov.19, 2011
ISN	SCHWARZBECK	NTFM 8158 CAT5	CAT 5 8158-0009	Nov.19, 2011
ISN	SCHWARZBECK	NTFM 8158 CAT6	CAT 6 8158-0012	Nov.19, 2011
KMO Shielded Room	KMO	KMO-001	N/A	N/A
Coaxial Cable with N-Connectors	SCHWARZBECK	AK9515H	95549	Sep.18, 2011
SOHO Telephone Switching System	IKE	2000-108C	N/A	NCR
3m Anechoic Chamber	Sintek	KMO-3AC	KMO-3AC-1	May 29, 2012
Temperature Chamber	TABAI	PSL-4GTW	N/A	Feb.10, 2012