



**SkyDock™**  
**Installation and User Guide**

# Table of Contents

# Table of Contents

## **Introduction . . . . . 4**

Features . . . . .	5
About XM Radio . . . . .	6
Safety and Care information . . . . .	7
What's in the box? . . . . .	9
SkyDock Features and Controls . . . . .	10
SkyDock Features and Connections . . . . .	11

## **Vehicle Installation . . . . . 12**

Installing SkyDock in Your Vehicle . . . . .	13
Docking the iPhone in the SkyDock . . . . .	18
Downloading the XM SkyDock App . . . . .	22
Launching the XM SkyDock App for the First Time . . . . .	23
Activating Your XM Subscription . . . . .	24
Setting-up the FM Transmitter . . . . .	26

## **Using Your SkyDock . . . . . 28**

Display Screen Information . . . . .	29
Channel List Screen . . . . .	31
Category List Screen . . . . .	32
Direct Tuning . . . . .	34
Setting Your Favorite Channels . . . . .	35
Song Tagging . . . . .	38
Sports Tagging . . . . .	40
Displaying the Sports and Stock Ticker . . . . .	42

## **Setting up Your SkyDock . . . . . 44**

The Settings Menu . . . . .	45
My Account . . . . .	46

FM Settings . . . . .	47
Alert Options . . . . .	50
Ticker Options . . . . .	50
Sports . . . . .	51
Stocks . . . . .	53
Traffic & Weather . . . . .	55
Preview Cards . . . . .	56
Parental Controls . . . . .	57
Sounds . . . . .	60
Disable Auto-Lock . . . . .	61

## **Appendix . . . . . 62**

Miscellaneous Pop-Up Alerts . . . . .	63
Incoming Phone Call Behavior . . . . .	64
Specifications . . . . .	65
Patent Information . . . . .	66
Environmental Information . . . . .	66
FCC Statement . . . . .	67
Copyrights and Trademarks . . . . .	68
Owner's Record . . . . .	69

# Introduction

# Introduction

## Features

### **Congratulations on your purchase of the SkyDock!**

The SkyDock™ has these exciting features to enhance your listening experience:

- Specialized Dock with built-in XM Radio tuner
- Compatible with iPhone and iPod touch (see page 6 for specific models)
- Controlled by XM SkyDock Application (downloadable free from App Store)
- Charges iPhone/iPod touch while docked
- All-in-one design allows for easy installation
- Rotates to view in portrait or landscape modes (automatic image orientation)
- Incorporates PowerConnect FM transmitter
- Audio Out connection (for AUX-IN ready vehicle audio systems)
- iTunes Song Tagging
- Artist/Song Alerts
- Game Alerts
- Stock and Sports Ticker

**To get the most from your new SkyDock, please read this entire user guide.**

# Introduction

## Compatibility

Your SkyDock will work with the following iPhone and iPod models *that have OS 3.0 or higher*:



iPhone 3GS  
16GB 32GB



iPhone 3G  
8GB 16GB



iPhone  
4GB 8GB 16GB



iPod touch  
1st generation  
8GB 16GB 32GB



iPod touch  
2nd generation  
8GB 16GB 32GB



iPod is a trademark of Apple Inc., registered in the U.S. and other countries. iPhone is a trademark of Apple, Inc. Apple is not responsible for the operation of this device, or its compliance with safety and regulatory standards.

## Safety and Care Information



**IMPORTANT:** Always read and understand all the instructions to avoid injury to yourself and/or damage to your radio. XM Radio claims no responsibility for damage from data loss due to breakdown, repair, or other causes.

- Do not expose to extreme temperatures (above 140°F or below -4°F, or above 60°C or below -20°C).
- Do not expose to moisture. Do not use device near or in water.
- Do not let any foreign matter spill into device.
- Do not store in dusty areas.
- Do not expose to chemicals such as benzene and thinners. Do not use liquid or aerosol cleaners. Clean with a soft damp cloth only.
- Do not expose to direct sunlight, fire, flame or other heat sources for a prolonged period.
- Do not try to disassemble and/or repair the device yourself.
- Do not drop the device or subject it to severe impact.
- Do not place heavy objects on the device.
- Do not subject the device to excessive pressure.

# Introduction



## WARNING

- Opening the case may result in electric shock.
- The uninsulated parts inside the SkyDock may cause electric shock or fire. For your safety, please do not open the SkyDock. Do not let metallic objects, such as necklaces or coins, come into contact with the SkyDock plug.
- To avoid electric shock, use the SkyDock only with a power outlet that matches the shape of its plug.
- Make sure that you insert the SkyDock all the way into the power socket.
- Do not plug several devices into the same power outlet.
- Use the SkyDock away from water sources to avoid fire or electric shock.
- Do not touch the device with wet hands.

When using this product it is always important to keep your eyes on the road and hands on the wheel. Not doing so could result in personal injury, death, and/or damage to your device, accessories, and/or to your vehicle or other property.

Your device should be placed in your vehicle where it will not interfere with the function of safety features, e.g., deployment of airbags. Failure to correctly place this device may result in injury to you or others if the unit becomes detached during an accident and/or obstructs the deployment of an airbag.



## What's in the Box?

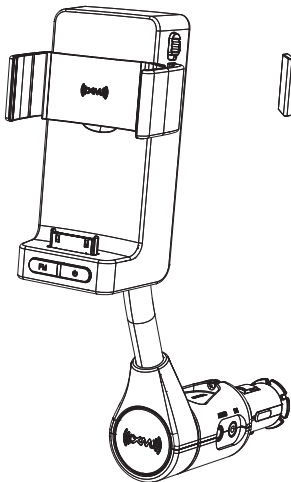

SkyDock  
(with Spacer 2  
Attached)



Spacer 1



Spacer 2  
(shipped attached  
to SkyDock)



Spacer 3

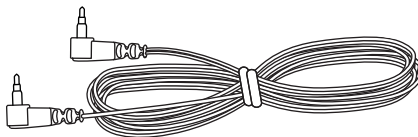

Audio Cable

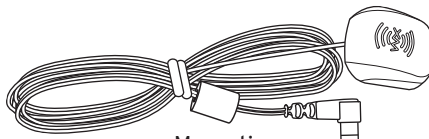

Magnetic  
Vehicle Antenna

# Introduction

## SkyDock Features and Controls

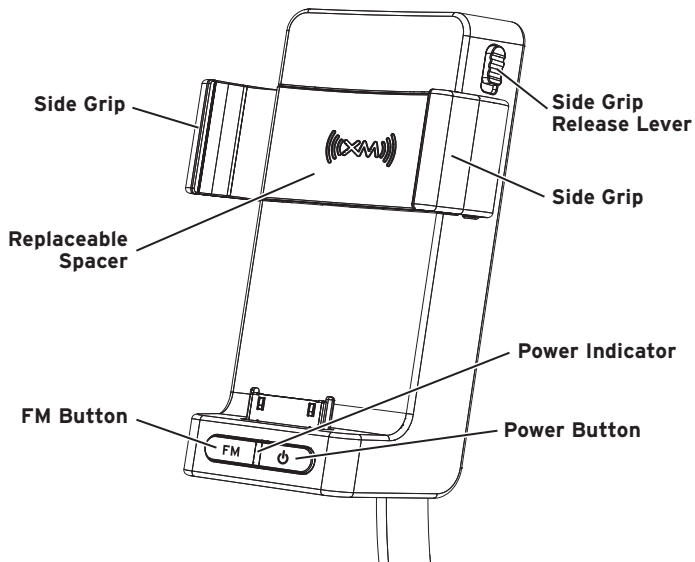

## SkyDock Features and Connections

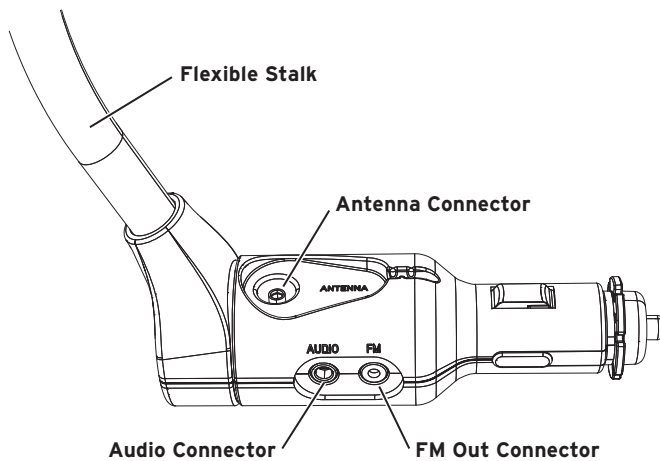

# Vehicle Installation

# Vehicle Installation



*NOTE: ALL REFERENCES TO iPhone IN THIS MANUAL ALSO APPLY TO THE iPod touch UNLESS OTHERWISE NOTED.*

## Installing the SkyDock in Your Vehicle

### Step 1: Finding a Location for the SkyDock

The SkyDock mounts into your vehicle's cigarette lighter or 12V power socket. If your vehicle has more than one 12V power socket, be sure to choose one that doesn't interfere with the driver's vision or access to driving controls, doesn't interfere with the deployment of airbags or other safety equipment, and makes the iPhone easily accessible for operation. Please see the safety warnings on page 8.

It will be easier to make connections to your SkyDock before you plug it into the power socket, so we recommend completing *Step 2* and *Step 3* first.

### Step 2: Mounting the Antenna and Routing the Cable

*IMPORTANT: THE SKYDOCK USES A UNIQUE ANTENNA. DO NOT SUBSTITUTE AN ANTENNA FROM ANY OTHER XM RADIO FOR THE SKYDOCK ANTENNA. REPLACEMENT SKYDOCK ANTENNAS ARE AVAILABLE FROM [WWW.XMRADIO.COM](http://WWW.XMRADIO.COM).*

- a) **Mount the antenna on the outside of your vehicle, on a horizontal surface that will always face the sky.** The antenna contains a strong magnet that will stick to any metal part of your vehicle. Leave at least 3" of metal around at least three sides of the antenna.

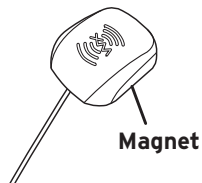

# Vehicle Installation

For most vehicles the best location is on the roof towards the front of the cab, above the front windshield, as close to centered between the left and right sides as the cable length will allow. For convertibles, locate the antenna on the trunk lid, at least 3" from any edge. (If the cable does not reach, locate the antenna on top of the front windshield frame.)

## Recommended Antenna Locations

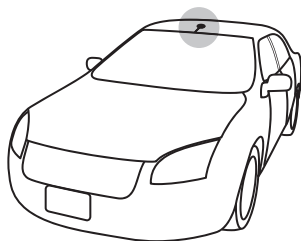

**Sedans and Coupes**

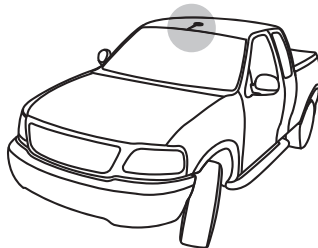

**Pickups and SUVs**

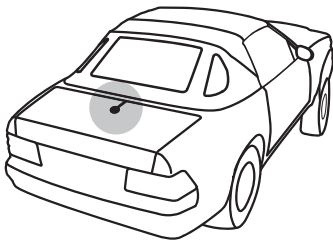

**Convertibles\***

\* If the antenna will not reach the trunk lid, mount it on the top of the front windshield frame.

**b)Route the antenna wire under the rubber molding around the front windshield to the nearest corner. Then route the cable out of the windshield molding and into the rubber weather stripping around the door opening. Lift the weather stripping from the opening and tuck the cable inside it, then replace the weather stripping. Run the cable inside of the weather stripping to the bottom of the door opening.**

**c) Recommended: Hide the antenna wire inside the cabin.** Pull the cable out of the weather stripping at the bottom of the door opening and route it under the carpet toward the 12V power socket. Coil any excess cable in a hidden location, such as under the carpet, keeping it away from any vehicle pedals or controls. Secure the excess cable with wire ties.

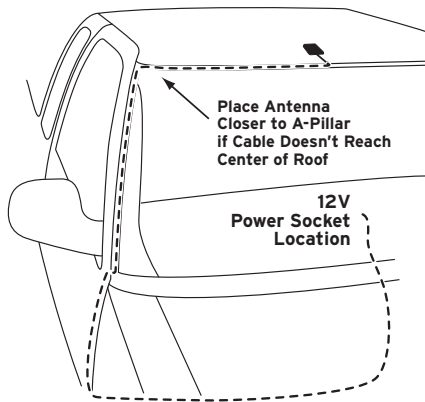

**TIP!** Always be careful to include enough slack in your routing to accommodate open doors or trunk lids. Use electrical tape to secure the cable in areas so that hinges do not pinch the cable with the door.

# Vehicle Installation

## 3. Connect the SkyDock to Your Audio System

- a) Plug the **Antenna** into the SkyDock's **ANTENNA CONNECTOR**. The antenna plug and cable will fit into the recess on the top of the SkyDock base.
- b) If your vehicle's audio system has an audio input (for MP3 players, etc), connect the included **Audio Cable** between it and the SkyDock's **AUDIO CONNECTOR**. This is the best quality and easiest audio connection for your SkyDock.

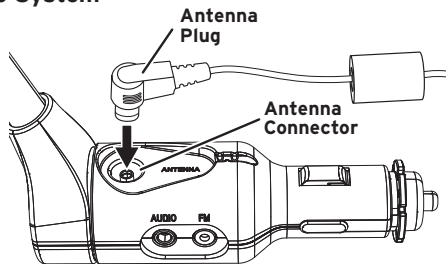

Connecting the Antenna

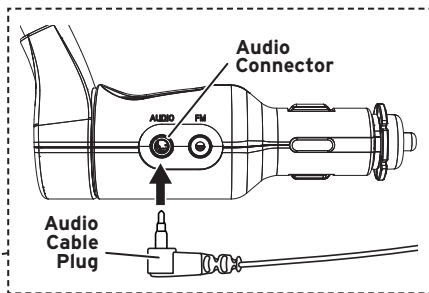
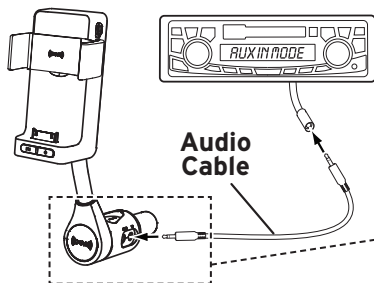

Connecting the Audio Cable



c) If your vehicle's audio system does not have an audio input, your SkyDock incorporates a special FM transmitter called PowerConnect that will 'broadcast' its audio to your vehicle's FM radio through your vehicle's power system. See *Setting-Up the FM Transmitter*, on page 26, for details.

#### 4. Plug the SkyDock Into the Vehicle's 12V Power Socket

Make sure the SkyDock is inserted all the way into the power socket.

 **NOTE:** AFTER PLUGGING THE SKYDOCK INTO THE POWER SOCKET, ALIGN THE CABLES SO THEY DO NOT INTERFERE WITH THE SAFE OPERATION OF THE VEHICLE.

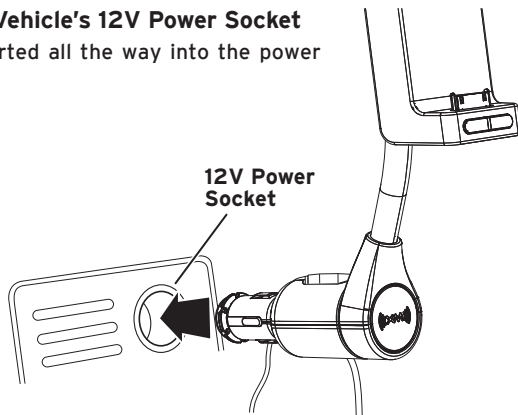

# Vehicle Installation

## Docking the iPhone in the SkyDock

### Inserting the Spacers

Your SkyDock comes with three numbered urethane spacers that assure a proper fit with different iPhone and iPod touch models, with and without aftermarket skins (thin cases that surround and protect the iPhone or iPod touch).

**IMPORTANT:** THE SKYDOCK WILL NOT ACCOMMODATE ALL TYPES OF AFTERMARKET SKINS. COMPATIBLE SKINS MUST NOT BE THICKER THAN 2MM IN ANY DIRECTION AND MUST HAVE A LARGE ENOUGH OPEN AREA AROUND THE CONNECTOR AT THE BOTTOM OF THE iPhone/iPod touch TO ALLOW IT TO SEAT PROPERLY IN THE SKYDOCK.

**Spacer 1:** For iPhone with compatible skin

**Spacer 2:** For iPhone without skin; for iPod touch with compatible skin

**Spacer 3:** For iPod touch without skin

Install the appropriate Spacer by inserting it all the way into the recess in the SkyDock (*top*).

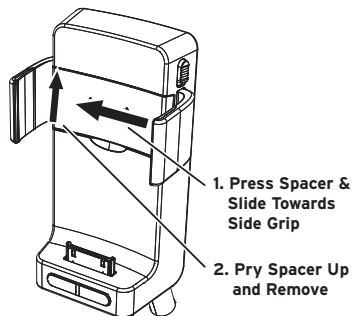
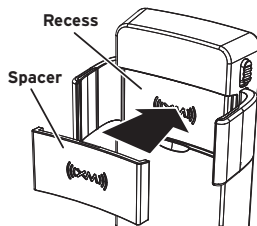

### Removing the Spacers

1. Use one finger to apply sliding pressure on the Spacer towards one of the Side Grip arms.
2. Using another finger, pry up under the edge of the Spacer to release it (*bottom*).

## Inserting and Removing the iPhone

**To insert the iPhone in the SkyDock:** Insert the bottom of the iPhone straight down onto the connector, making sure that the connection is solid. Gently squeeze the side grips against the iPhone to secure it. Squeeze towards the rear of both side grips, as shown in the diagram below.

### TO INSERT iPHONE

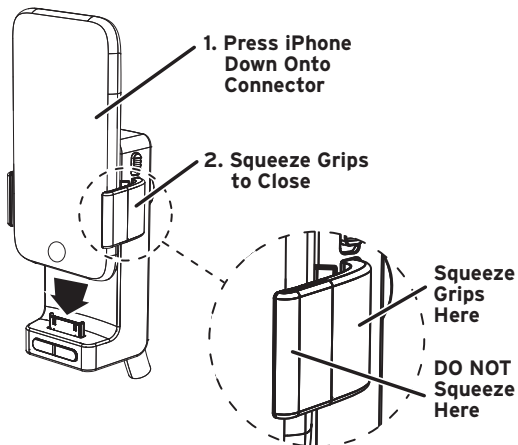

# Vehicle Installation

**To remove the iPhone:** Slide the Side Grip Release Lever **DOWN** to spread the grips apart. Then lift the iPhone off the connector and pull it straight up and out of the SkyDock.

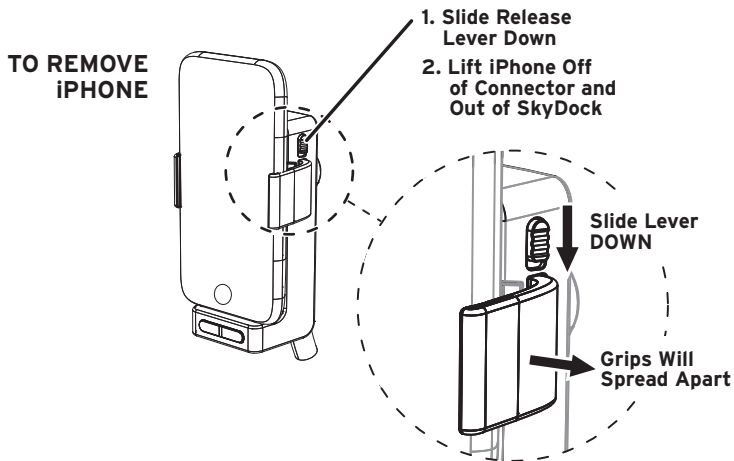

## Adjusting the Flexible Stalk

The SkyDock's flexible stalk gives you lots of freedom to position the iPhone so it is convenient for you to use. You can twist the stalk up to 90° in either direction (see illustration), and bend it to be clear of controls or other items.

 **CAUTION:** Do NOT OVER-ROTATE THE STALK — DOING SO COULD DAMAGE IT.

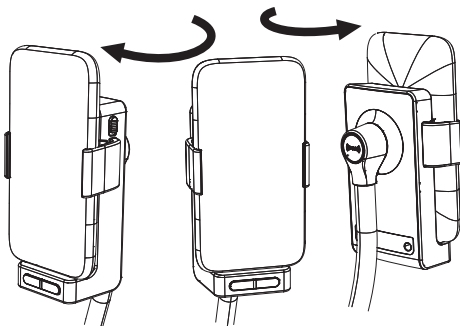

## Rotating the SkyDock

You can rotate the SkyDock up to 100° in either direction so that the iPhone is landscape-oriented instead of portrait oriented. The XM SkyDock app will automatically orient the screen image to match the SkyDock's orientation.

 **CAUTION:** Do NOT OVER-ROTATE PAST THE STOPPING POINT — DOING SO COULD DAMAGE THE SKYDOCK.

 **NOTE:** ENSURE THAT THE SKYDOCK AND IPHONE WILL NOT BLOCK AIRBAGS AS THEY DEPLOY, OR BLOCK ANY CONTROLS NEEDED FOR OPERATING THE VEHICLE.

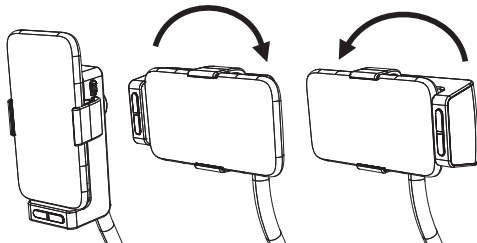

# Vehicle Installation

## Downloading the XM SkyDock Application

There are several ways to download the XM SkyDock app into your iPhone:

- A) You can use your iPhone to download the app directly from the app store.
- B) You can go to [www.xmradio.com/skydock](http://www.xmradio.com/skydock) and download the app into your computer. You will then need to synchronize your iPhone with iTunes to download the app to your iPhone.
- C) You can download the app directly from iTunes into your computer. You will then need to synchronize your iPhone with iTunes to download the app to your iPhone.

Once the XM SkyDock app has been successfully downloaded into your iPhone the Home Screen will display the XM SkyDock icon shown in the illustration. Tap the icon to launch the XM SkyDock app.



## Launching the XM SkyDock App for the First Time

1. Be sure that your SkyDock is correctly connected and installed, that the antenna is oriented to receive the XM signal, and that your iPhone is properly inserted in the SkyDock.



*NOTE: THE SKYDOCK AUTOMATICALLY TURNS ON WHENEVER THE IPHONE IS INSERTED, AND AUTOMATICALLY TURNS OFF WHENEVER THE IPHONE IS REMOVED.*

2. Launch the XM SkyDock app. The iPhone will display the *Welcome* screen.
3. Select *Start Satellite Radio*. The iPhone will display the *Continue/Activate Later* screen.

*NOTE: SELECTING LEARN MORE ABOUT THE XM SKYDOCK WILL LAUNCH THE SAFARI BROWSER AND TAKE YOU TO [WWW.XMRADIO.COM/SKYDOCK](http://WWW.XMRADIO.COM/SKYDOCK).*

4. Select *Continue*. The iPhone will begin the activation process.
5. Have your credit card handy and proceed to *Activating Your XM Subscription*, on page 24.



*NOTE: THE XM SKYDOCK APP WILL REMAIN ACTIVE ON YOUR IPHONE UNTIL YOU PRESS THE IPHONE'S HOME BUTTON.*

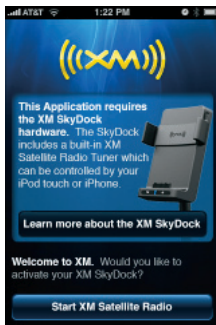

**Welcome Screen**

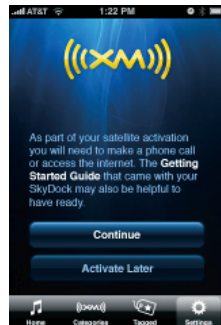

**Continue/Activate Later Screen**

# Vehicle Installation

## Activating your XM Subscription



*NOTE: THE ACTIVATION PROCEDURE SCREENS ARE ONLY DISPLAYED IN PORTRAIT ORIENTATION.*

1. If you're activating directly after launching the XM SkyDock app for the first time, your iPhone should be displaying either the *Acquiring Signal* screen or the *Signal Found* screen.
  - If the *Acquiring Signal* screen remains displayed, make sure that the antenna is properly connected to the SkyDock, and that it is properly mounted and has a clear view of the sky. See pages 13 - 16.
2. Once the *Signal Found* screen is displayed, tap *Continue*. The *To Complete Activation* screen will be displayed (next page).

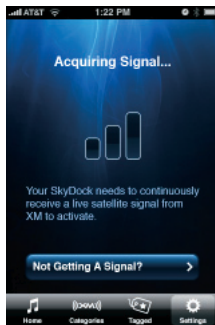

**Acquiring Signal  
Screen**

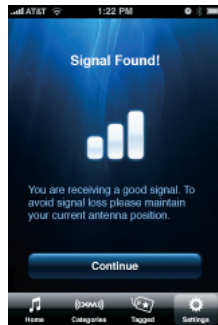

**Signal Found  
Screen**



3. Call the number or visit the URL displayed on the *To Complete Activation* screen to complete the activation process.
4. During the activation process the iPhone will display the *Activating Radio* screen.
5. Once the activation process is completed, tap the *Close* button. The iPhone will display the Home screen (tuned to *XM Preview* channel #1). You can now tune to any XM channel and enjoy XM Satellite Radio on your iPhone.

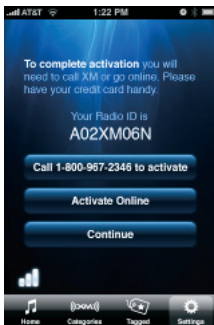

**To Complete  
Activation  
Screen**

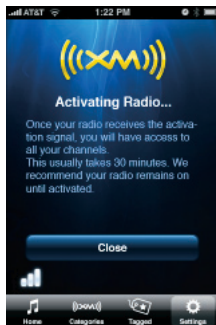

**Activating Radio  
Screen**



**Home Screen  
(on XM Preview  
Channel)**

# Vehicle Installation

## Setting-up the FM Transmitter

Your SkyDock has a PowerConnect FM transmitter that will 'broadcast' its audio to your vehicle's FM radio if you have not used the included audio cable to connect the SkyDock to your vehicle's audio system.



*NOTE: FOR COMPLETE DETAILS ABOUT SETTING THE FM TRANSMITTER, SEE FM TRANSMITTER, ON PAGE 48.*

1. Press-and-hold the SkyDock's FM button. The *FM Settings* screen will appear. Tap the *On/Off* button to turn the FM transmitter OFF.
2. Tune through your vehicle radio's FM channels to find an FM channel (between 87.9MHz and 107.9MHz) that is not broadcasting in your area. (If you use an FM channel that is being used by a local broadcaster, it will interfere with your SkyDock's performance.)
3. Once you have located an FM channel that is not broadcasting in your area, save it as a preset on your vehicle radio. This will become your SkyDock preset.
4. Tap the *On/Off* button on the SkyDock's *FM Settings* screen again to turn the FM transmitter ON. The first preset (factory-set to 88.1MHz) will be highlighted. This may not be the best frequency for your area.

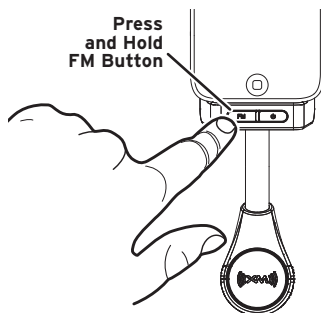

**SkyDock FM Button**

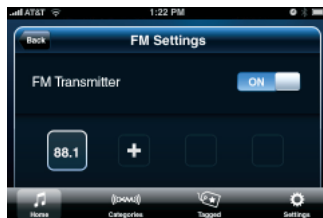

**FM Settings Screen**

5. Press-and-hold anywhere on the screen for 2 seconds. The *FM Settings* screen will change to the Edit Mode.
6. Tap the *Edit* button beneath the 88.1 preset. The *Set FM Preset* screen appears.
7. Tap the arrow buttons to select the FM frequency that matches the channel that you preset on your vehicle radio to in *Step 3*.
8. Tap the *Back* button to return to the *FM Settings* screen with the new FM preset frequency stored. To exit, tap the *Home* button.



**FM Settings Screen Edit Mode**



**Set FM Preset Screen**



**New FM Preset Stored**

To listen to your SkyDock, turn your vehicle's FM radio ON and press the SkyDock preset you set in *Step 3* on page 26.

# Using Your SkyDock

# Using Your SkyDock

## Getting Around the XM SkyDock Screens

You will be using the following basic actions to navigate all of the XM SkyDock app screens:

**Tap:** A touch of your fingertip on a button or item to select it.

**Press-and-Hold:** Holding your fingertip on a button or item for two seconds or longer, usually to enter a different screen mode.

**Swipe (up and down):** Sliding your finger up or down on the screen, to scroll-through a list or column.

**Swipe (side-to-side):** Sliding your finger across the screen, to change to different screens.



**Swiping Up/Down to Scroll-Through a List**



**Sweeping Sideways to Change Preview Cards**

# Using Your SkyDock

## Home Screen Information

When using the XM SkyDock app your iPhone's screen will display items such as the currently-tuned channel, the song or show being played, the artist's name, and other information. This screen is referred to as the *Home Screen* in this manual.

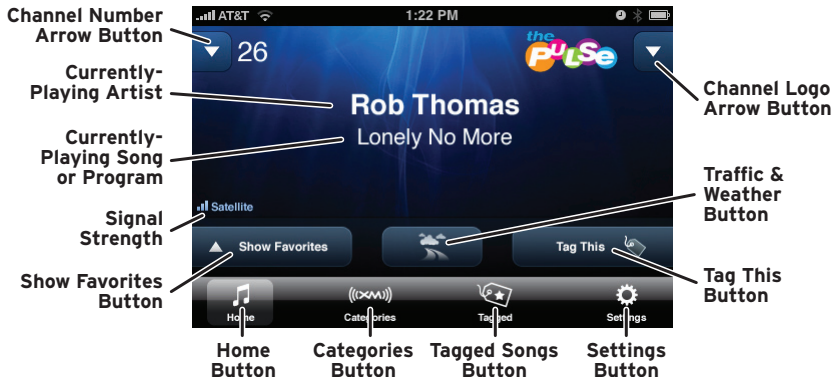

Whenever you launch the XM SkyDock app, the channel that was previously selected will automatically begin playing, and the currently-playing artist name and song or program title will be displayed.

**Channel Number Arrow Button:** Shows the number of the currently-playing XM channel. Tap the arrow to enter channel numbers for Direct Tuning. For details see page 34.

**Channel Logo Arrow Button:** Shows the name of the currently-playing XM channel. Tap the arrow to display the Channel List screen for the current category. Also lets you change channels or categories. For details see page 32.

**Traffic and Weather Button:** Tap to tune to your pre-selected traffic and weather channel; tap again to return to your original channel. Press-and-hold to set or change your traffic and weather channel. For details about setting the traffic & weather channel see page 55.

**Tag This Button:** Tap to tag the current song and artist (or sports teams, if you're listening to a sporting event). This places the song and artist or sports teams in the SkyDock's memory and gives you an opportunity to purchase the song from iTunes.

The XM SkyDock app continuously scans all available channels, and if a tagged song, artist, or sports team is playing on another channel, the screen will display an alert, giving you an opportunity to tune to that channel. For details on Tagging see page 38. For details on Sports Tagging see page 40.

**Show Favorites Button:** Tap to display the preset buttons for up to 12 of your Favorite channels. For details about setting your Favorites see page 35.

**Home Button:** Returns to the Home Screen.

**Categories Button:** Tap to display the Category List screen. See page 33 for details.

**Tagged Songs Button:** Tap to display and edit your tagged song list. For details see page 39.

**Settings Button:** Tap to open the Settings menu. For details see page 45.

# Using Your SkyDock

## Channel List Screen

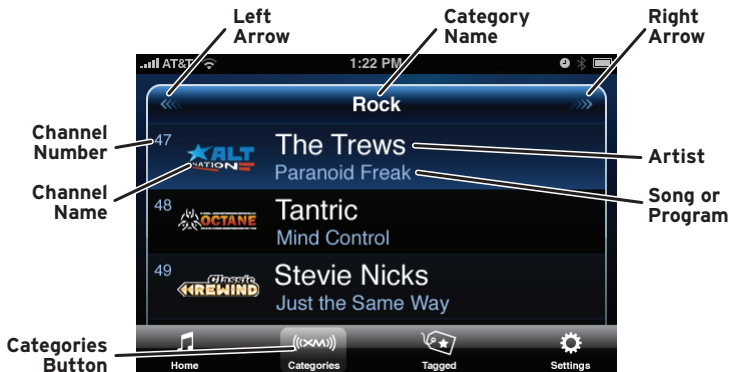

Tapping the Channel Logo on the Home Screen (see page 30) displays the channel list for the current category .

**To select a channel:** Tap the channel you want to listen to.

**To see more channels:** Sweep your finger up or down on the channel list to scroll through the list of available channels.

**To change to a new category:** Swipe your finger left or right across the channel list. The screen will change to a channel list in the next or previous category. You can also tap the left and right arrows to change to the next or previous category.



## Category List Screen

Tapping the *Categories* button on the Home Screen (see page 30) will display the *Categories* screen, containing a list of all categories (*top*).

**To scroll through the list of categories:** Swipe your finger up or down on the screen.

**To see a category's channel list:** Tap the category's arrow button. The screen will display a channel list in the new category. Tap a channel to listen to it.

**To scroll-through the list of channels:** Sweep your finger up or down on the channel list. Tap the channel you want to listen to.

**To change to a different category:** Sweep your finger across the channel list or tap the left or right arrows. The next category's channel list will appear.

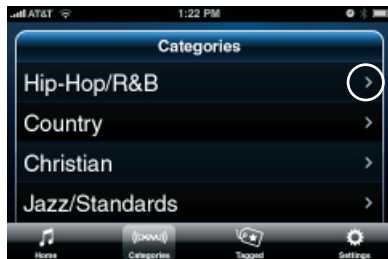

**Categories Screen, with Arrow Button Highlighted**



**Category Channel List Screen, with Left and Right Arrows Highlighted**

# Using Your SkyDock

## Direct Tuning

- 1 On the Home Screen, tap the channel number arrow button (A, below). The Direct Tuning keypad is displayed (B, below).
- 2 Use the keypad to enter a channel number (C, below).
- 3 When you finish entering the number you can tap the *OK* button or wait for SkyDock to automatically tune to the channel (D, below).

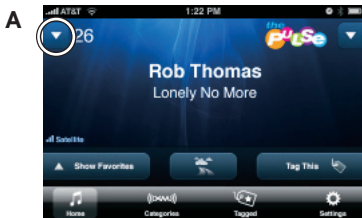

Tap Channel Number Arrow

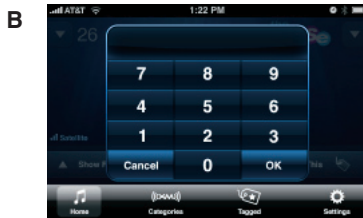

Keypad is Displayed

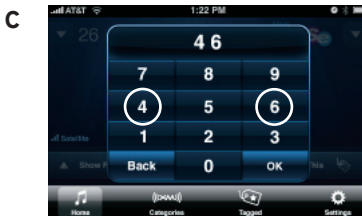

Enter New Channel Number



New Channel is Tuned

## Setting your Favorite Channels

You can save up to 12 of your favorite channels to Favorites buttons so you can quickly access them.

### To Save the Current Channel as a Favorite:

1. Tap the *Show Favorites* button on the Home Screen (see page 30). The Favorites panel will appear. (Note that when the Favorites panel appears for the very first time there will be no Favorites saved.)



*NOTE: THE FAVORITES VIEW WILL STAY OPEN UNTIL YOU A) PRESS THE HIDE FAVORITES BUTTON, B) PRESS THE CATEGORY BUTTON TO FIND A NEW CATEGORY OR CHANNEL, OR C) SWEEP ON THE ARTIST/SONG TITLE TO TUNE TO A NEW CHANNEL*

2. Tap the "+" to add the current channel to the list. The channel name and number will appear in the button and the next empty button will be indicated by the "+".
3. You can repeat Steps 1 - 2 to save up to 12 Favorite channels.



Favorites Panel (none saved)



Favorites Panel  
(current channel saved)

# Using Your SkyDock

## To Listen to a Favorite:

1. Tap the *Show Favorites* button on the Home Screen to display the Favorites panel.
2. Tap the Favorite button where you assigned the desired channel. The selected Favorite will be highlighted.

**To Edit Your Favorites:** Press-and-hold anywhere in the Favorites panel. The panel will enter the Favorites edit mode:

- You can change the Favorites order by dragging them from one location to another in the list.
- You can delete a Favorite by tapping its "X". A pop-up will appear, asking you to confirm the deletion. You can now save a new channel in the empty Favorite.



**NOTE:** YOU CANNOT DIRECTLY REPLACE A FAVORITE – YOU MUST DELETE IT AND CREATE A NEW ONE.

Tap the *Done* button to return to the Favorites panel.

To hide the Favorites panel, tap the *Hide Favorites* button. The Home Screen will return.



## Tap a Favorite Button to Listen

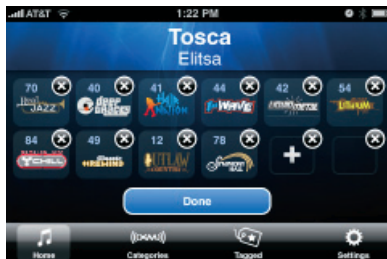

## Favorites Panel Edit Mode