

GIANT ELECTRONICS LTD.

PACKING METHOD

Model : XMTA0

Document No.: ENG-XMTA0-09	Signature	Name	Title
Revision No. A	Prepared by	JONY FENG	Engineer
Issue Date Feb.25,2005	Reviewed by	SW NG	A.Administrator
Page No./Total 1/15	Approved by	JAMES HO	A.Manager

Rev.	Date	Page	Revision Details	Prepared by	Checked by	Approved by
A	Feb.25,2005	15	1'ST ISSUE	JONY FENG	SW NG	JAMES HO

Note: The purpose of this packing method is just the tell-and-show of the assembly method of packing and the assembly sequence of product, accessories and printing matters, any P/Ns shown at the side of parts description are for easy reference only, for details, please refers to BOM.

GIANT ELECTRONICS LTD.

MODEL: XMTAO

TITLE: THE PROTECTOR

REV.	PRE.BY	DATE	CHK.BY	DATE	APP.BY	DATE
A	JONY FENG	2/25/05	SW NG	2/25/05	JAMES HO	2/25/05

PROTECTIVE
PAPER-DISPLAY
LENS

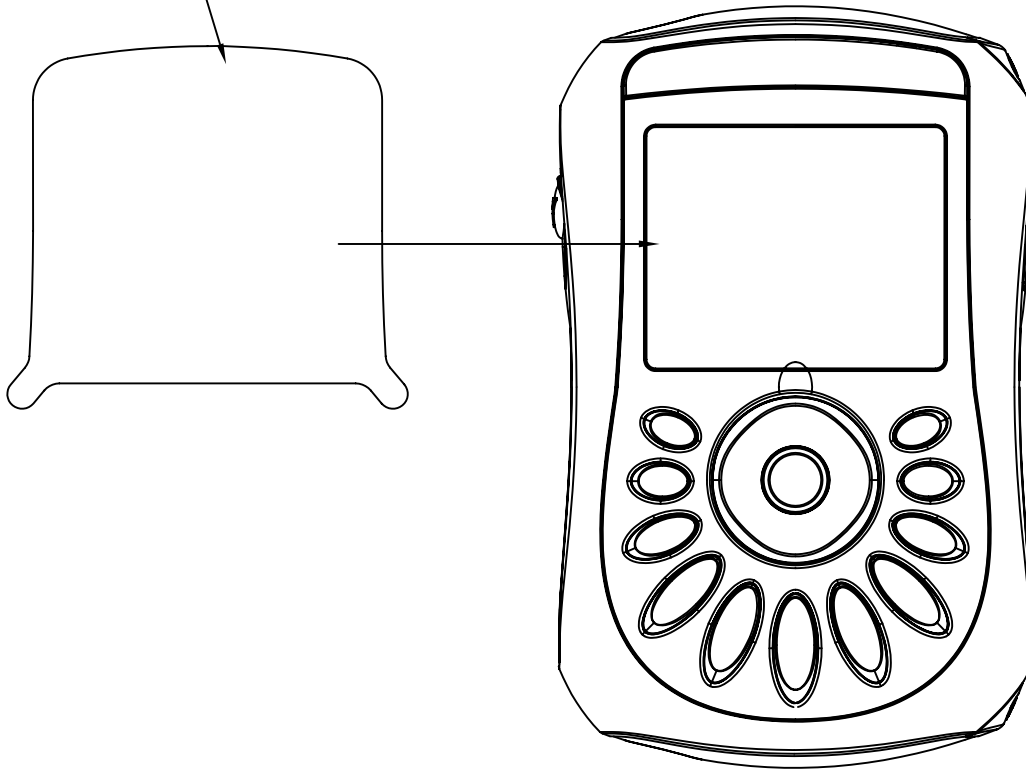

NOTES:

1. REMOVE THE OLD POLY-PROTECTION PAPER AND STICK THE PROTECTIVE PAPER TO LCD LENS

GIANT ELECTRONICS LTD.

MODEL: XMTA0

TITLE: RECEIVER LABEL ADDRESS FORMAT

REV.	PRE.BY	DATE	CHK.BY	DATE	APP.BY	DATE
A	JONY FENG	2/25/05	SW NG	2/25/05	JAMES HO	2/25/05

LABEL, RECEIVER
(KEM-PK17155)

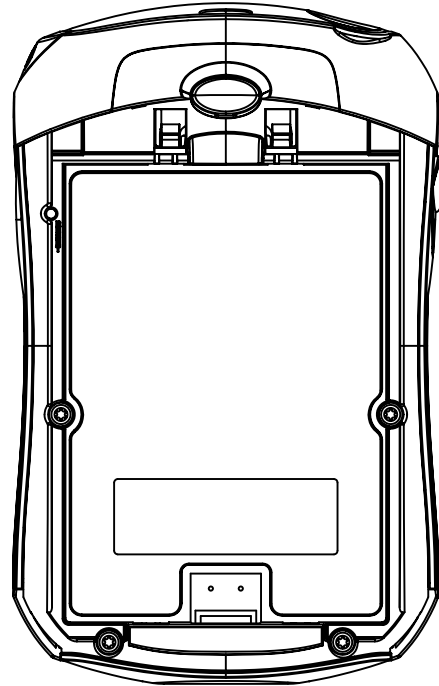
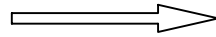
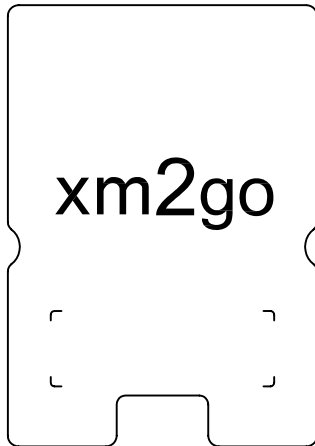

NOTES:

1. STICK THE RECEIVER LABEL INTO BATTERY BOX.

GIANT ELECTRONICS LTD.

MODEL: XMTA0

TITLE: LOT CODE LABEL ADDRESS FORMAT

REV.	PRE.BY	DATE	CHK.BY	DATE	APP.BY	DATE
A	JONY FENG	2/25/05	SW NG	2/25/05	JAMES HO	2/25/05

LABEL, LOT CODE
(KEM-PK17156)

RELATIVE INVARIABLE DATA

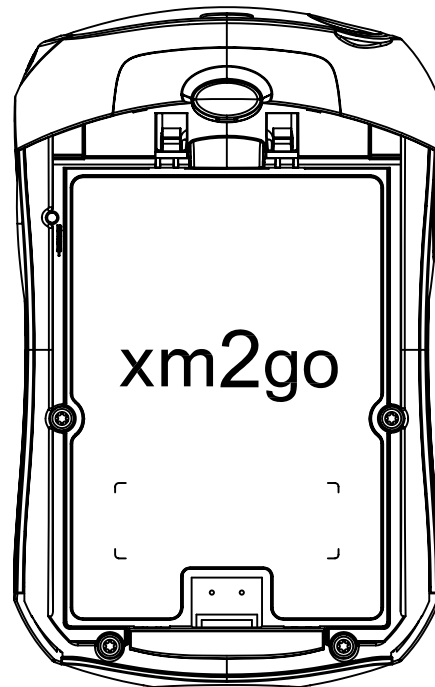
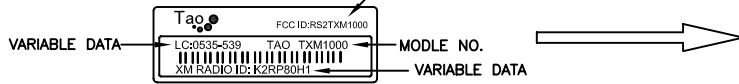

NOTES:

1. STICK THE LOT CODE LABEL INTO THE CASE LINE OF RECEIVER LABEL.

GIANT ELECTRONICS LTD.

MODEL: XMTA0

TITLE: RADIO I.D. LABEL ADDRESS FORMAT

REV.	PRE.BY	DATE	CHK.BY	DATE	APP.BY	DATE
A	JONY FENG	2/25/05	SW NG	2/25/05	JAMES HO	2/25/05

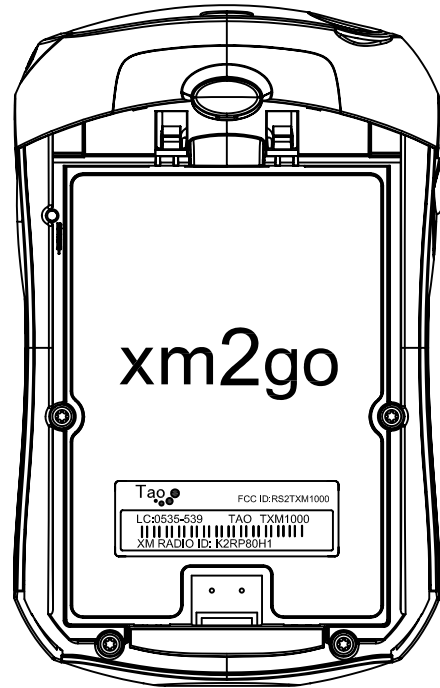

LABEL,RADIO I.D.
(XMTSK01533-00)

XM RADIO ID: K2RP80H1

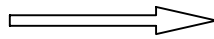

THE ID NO. NEED TO BE CORRESPOND
WITH THE ID OF LOT CODE LABEL

NOTES:

1. STICK THE RADIO I.D LABEL ONTO BOTTOM OF THE BACK HOUSING.

GIANT ELECTRONICS LTD.

MODEL: XMTAO			TITLE: STANDARD KIT PACKING METHORD			
REV.	PRE.BY	DATE	CHK.BY	DATE	APP.BY	DATE
A	JONY FENG	2/25/05	SW NG	2/25/05	JAMES HO	2/25/05

BELT CLIP/STAND
(KEM-P17173)



CUP HOME STAND
(KEM-P17170)



HOME STAND (KEM-P17172)

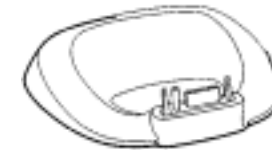

HOME ANTENNA(XMTSZ02033-00)



AC ADAPTER WALL CUBE,SWITCHING
(XMTSZ01318-00)



RCA STEREO CABLE
(XMTZ00244-01)



BATTERY(XMTSZ01322-02)

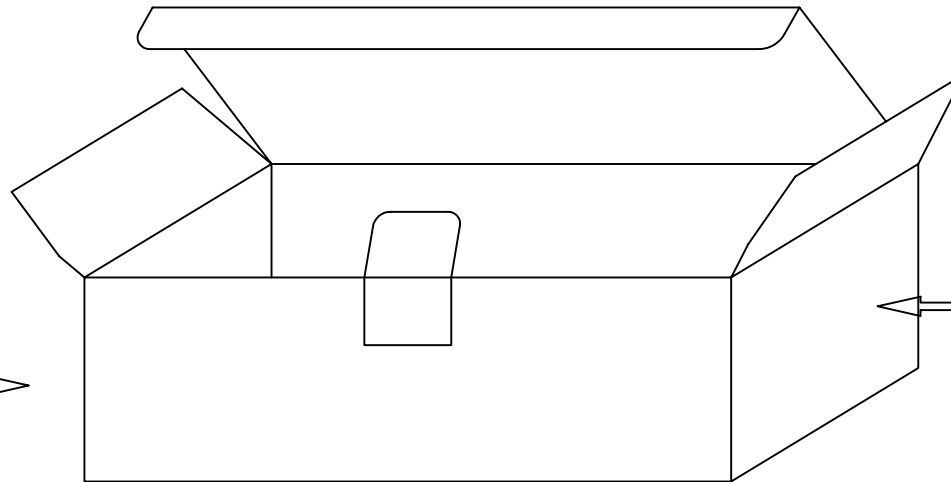
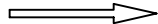

WHITE BOX FOR STANDARD KIT
(KEM-PK17177)

LABEL,STANDARD KIT CONTENTS
(KEM-PK17170)

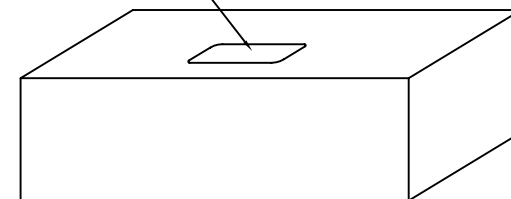

NOTES:

1. STICK 1PCS STANDARD KIT LABEL ONTO TOP OF THE WHITE BOX.

GIANT ELECTRONICS LTD.

MODEL: XMTAO		TITLE: SWIVEL ASM KIT PACKING METHORD			
REV.	PRE.BY	DATE	CHK.BY	DATE	APP.BY DATE
A	JONY FENG	2/25/05	SW NG	2/25/05	JAMES HO 2/25/05

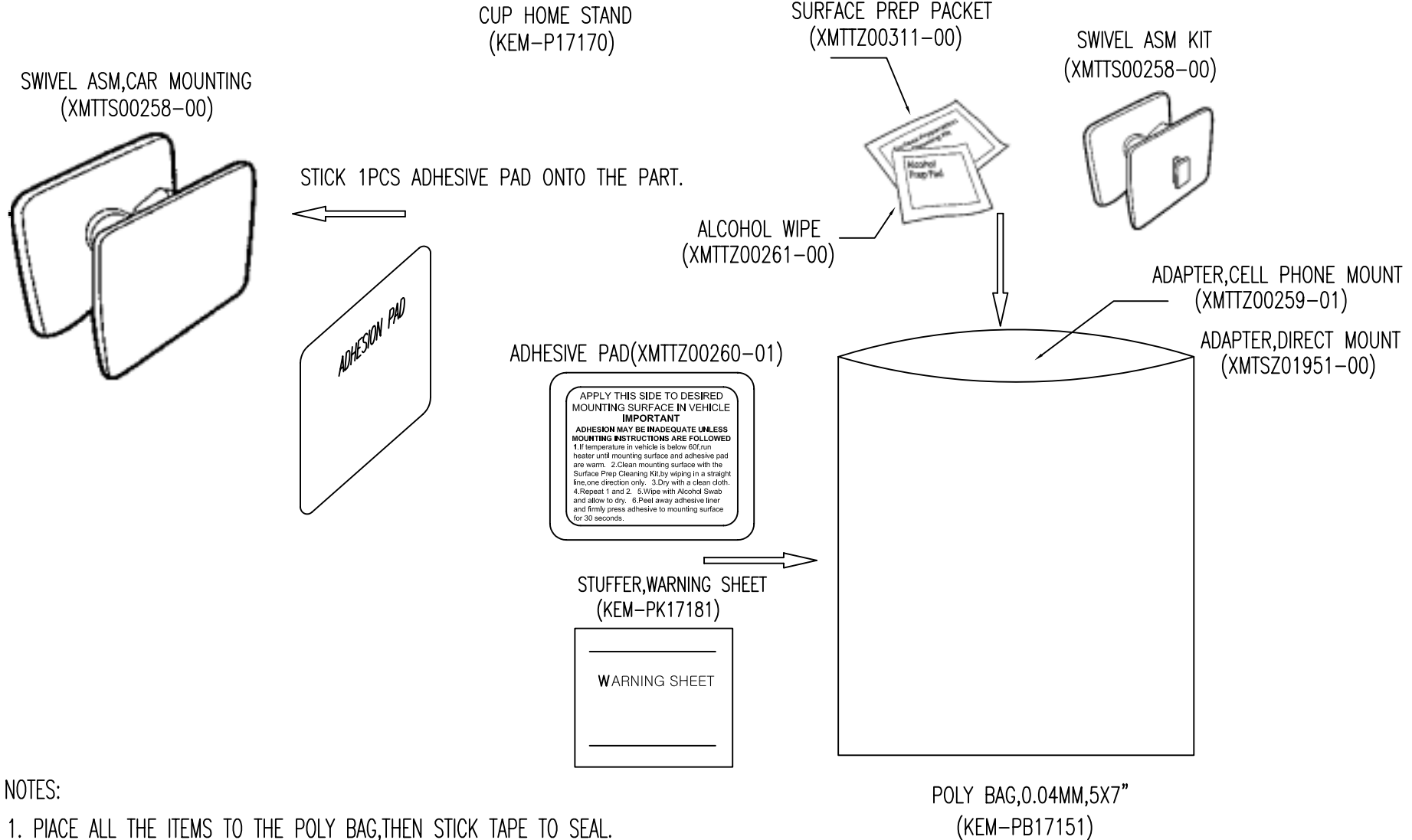

NOTES:

1. PLACE ALL THE ITEMS TO THE POLY BAG, THEN STICK TAPE TO SEAL.

GIANT ELECTRONICS LTD.

MODEL: XMTAO			TITLE: CAR KIT PACKING METHORD			
REV.	PRE.BY	DATE	CHK.BY	DATE	APP.BY	DATE
A	JONY FENG	2/25/05	SW NG	2/25/05	JAMES HO	2/25/05

CASSETTE ADAPTER
(XMTTZ00257-02)



POLY BAG KIT FOR SWIVEL ASM

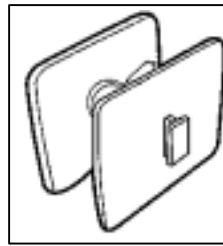

CAR KIT INSTALL GUIDE
(KEM-PK17180)



VENT MOUNT KIT(XMTSZ01071-00)



5.OVED CIGARETTE LIGHTER ADAPTER
(XMTSZ01393-00)

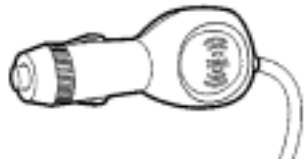

CAR CRADLE(KEM-P17174)



CAR ANTENNA,XM/FM
(XMTSZ02036-00)

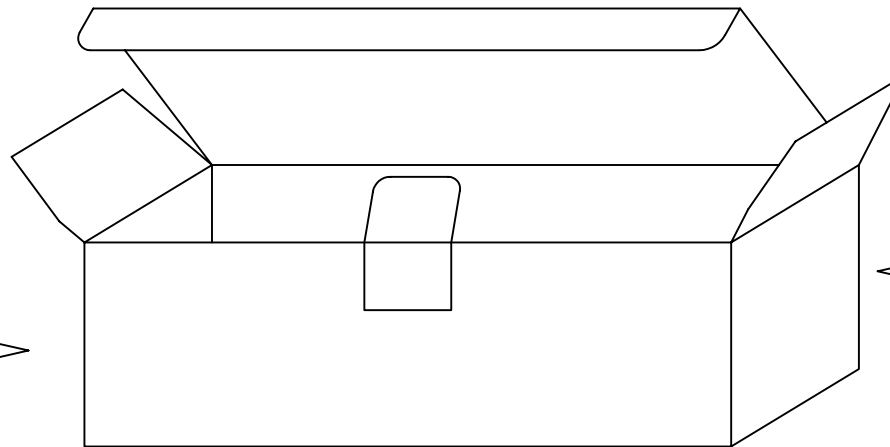

WHITE BOX FOR CAR KIT
(KEM-PK17176)

LABEL,CAR KIT CONTENTS
(KEM-PK17178)

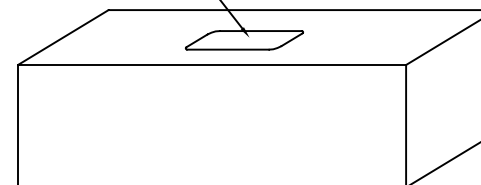

NOTES:

1. STICK 1PCS CAR KIT LABEL ONTO TOP OF THE WHITE BOX.

GIANT ELECTRONICS LTD.

MODEL: XMTAO			TITLE: BOTTOM TRAY PACKING METHORD			
REV.	PRE.BY	DATE	CHK.BY	DATE	APP.BY	DATE
A	JONY FENG	2/25/05	SW NG	2/25/05	JAMES HO	2/25/05

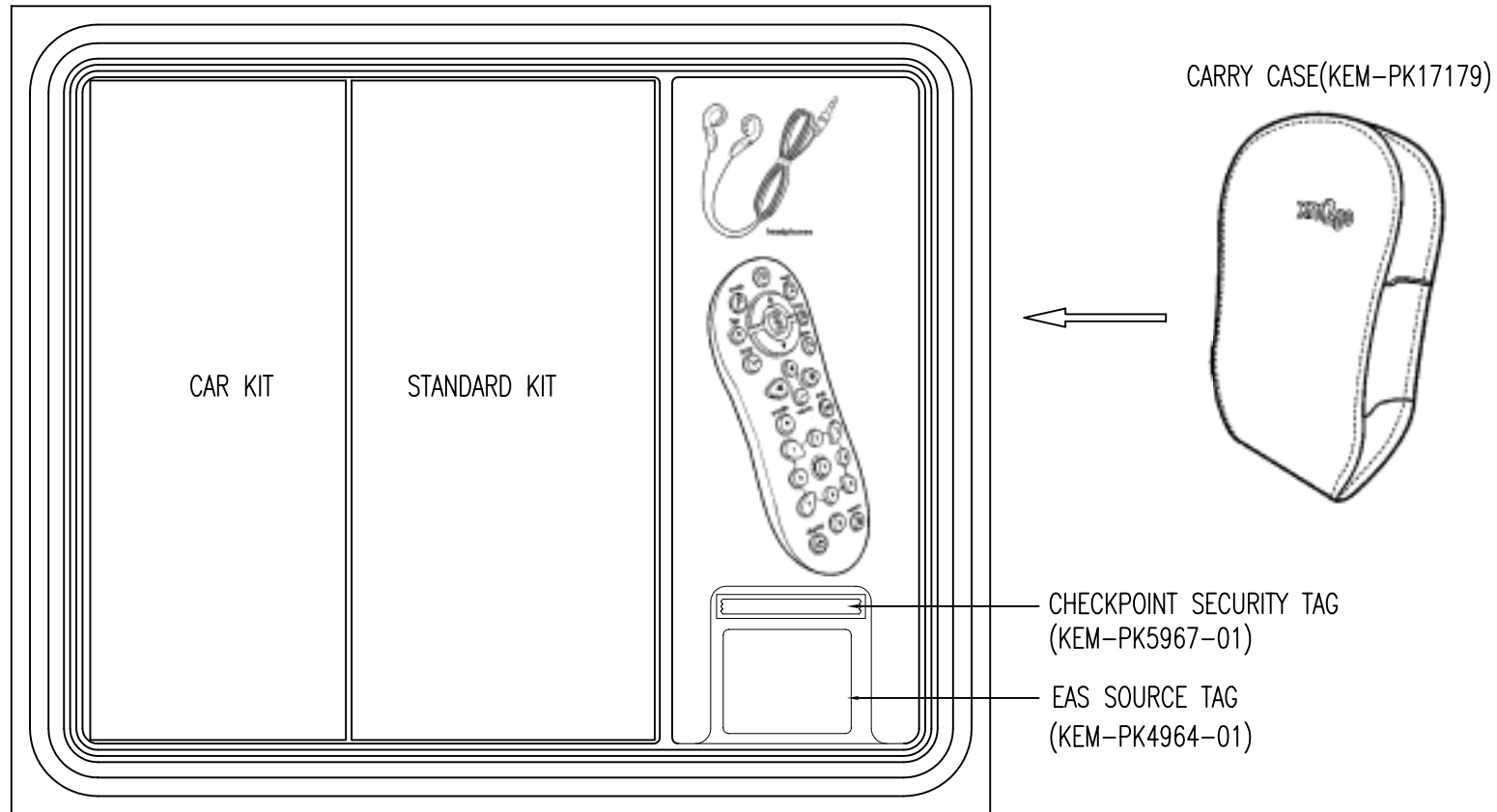

NOTES:

1. WRAPPED THE MAIN UNIT,CHARGER,ADAPTER WITH A OILPAPER PUT INTO THE PAPER PULP CARD.

GIANT ELECTRONICS LTD.

MODEL: XMTA0			TITLE: CLAMSHELL PACKING METHOD			
REV.	PRE.BY	DATE	CHK.BY	DATE	APP.BY	DATE
A	JONY FENG	2/25/05	SW NG	2/25/05	JAMES HO	2/25/05

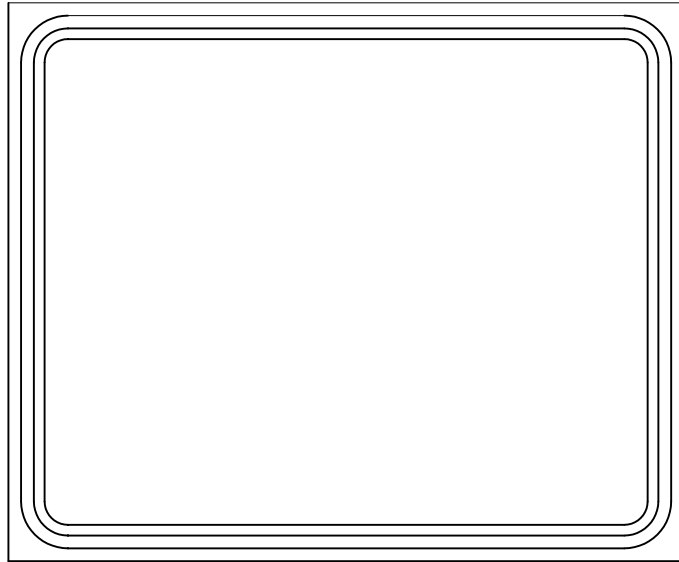

CLAMSHELL, TOP
(KEM-PK17152)



TAO xm2go RECEIVER(TXM1000)

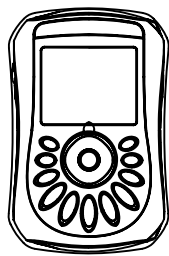

LITERATURE KIT(XM01LK)

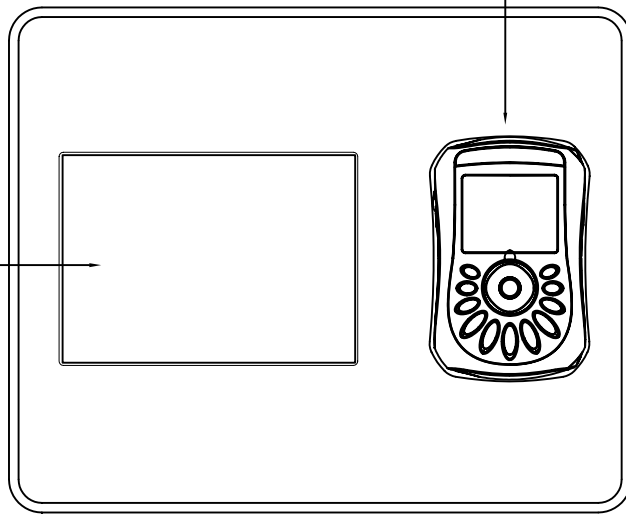

CLAMSHELL, INNER TRAY(KEM-PK17154)

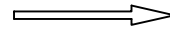

CLAMSHELL, BOTTOM(KEM-PK17153)

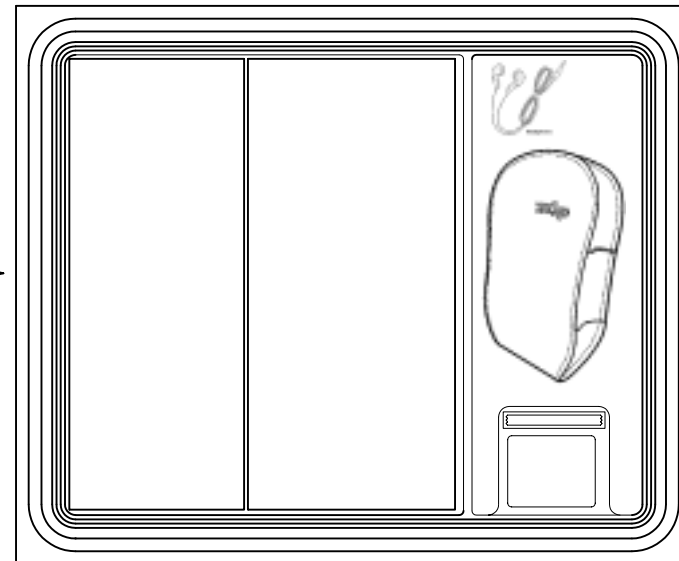

GIANT ELECTRONICS LTD.

MODEL: XMTA0

TITLE: CLAMSHELL PACKING METHORD

REV.	PRE.BY	DATE	CHK.BY	DATE	APP.BY	DATE
A	JONY FENG	2/25/05	SW NG	2/25/05	JAMES HO	2/25/05

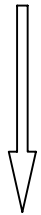
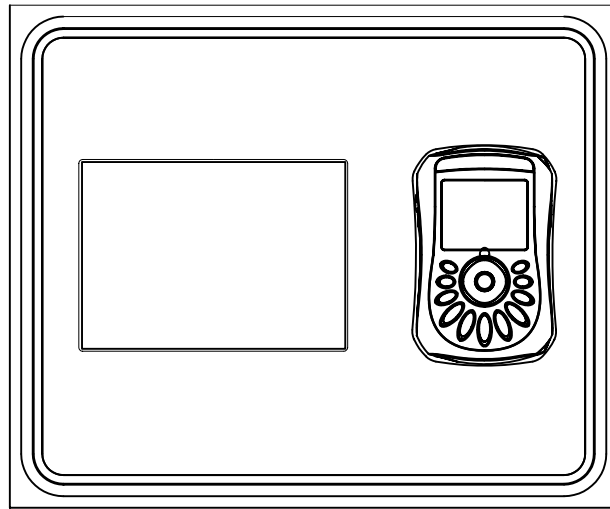

SEAL THE CLAMSHELL

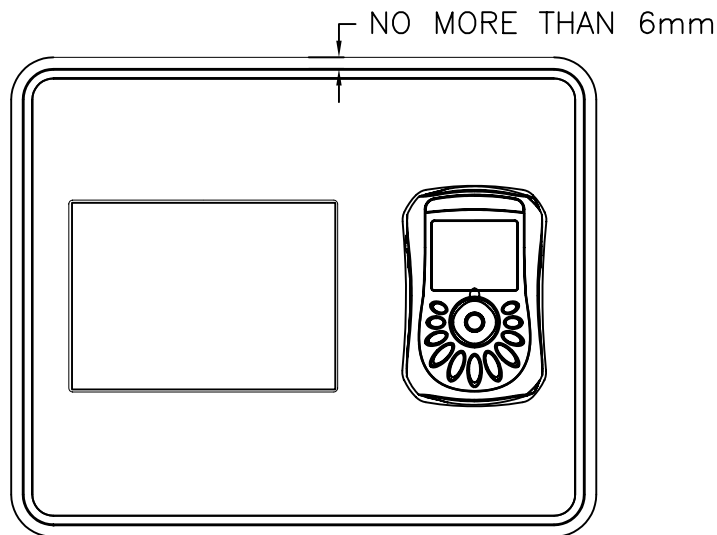

NOTES:

1. TOP EDGE OF THE CLAMSHELL IS NO MORE THAN 6MM, AFTER SEALING AND CUT OFF EDGE PROCESS ARE AS WILL.
2. THE COMPLETED CLSMSHELL BOX INCLUDETHE CALMSHELL TOP,THE CALMSHELL INNER TRAY,THE CLAMSHELL BOTTOM,THE LITERATURE KIT,THE MAIN UNIT,THE CAR KIT AND THE STANDARD KIT,THE DELUXE EARBUD,THE REMOTE CONTROL,THE CARRY CASE.

GIANT ELECTRONICS LTD.

MODEL: XMTA0

TITLE: MARKETING OUTER BOX PACKING METHOD

REV.	PRE.BY	DATE	CHK.BY	DATE	APP.BY	DATE
A	JONY FENG	2/25/05	SW NG	2/25/05	JAMES HO	2/25/05

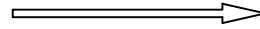

MARKETING OUTER BOX,DELUXE MODEL
(KEM-PK17175)

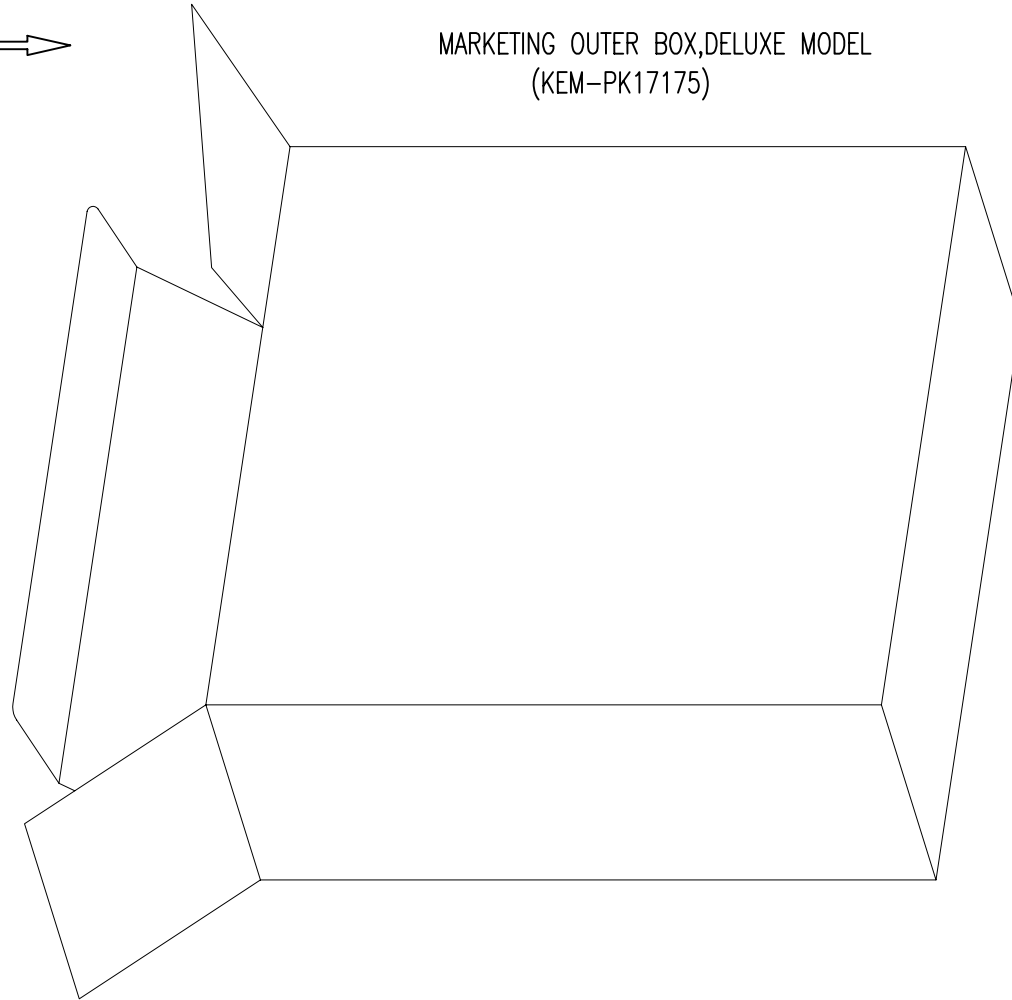
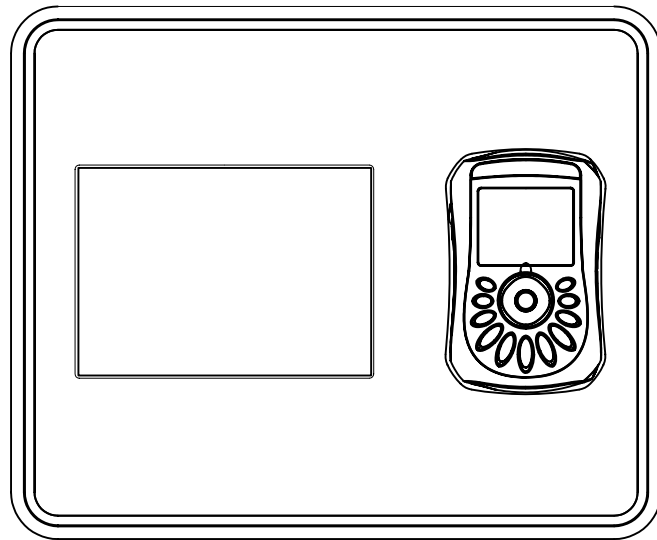

GIANT ELECTRONICS LTD.

MODEL: XMTA0

TITLE: SHIPPING CARTON PACKING METHORD

REV.	PRE.BY	DATE	CHK.BY	DATE	APP.BY	DATE
A	JONY FENG	2/25/05	SW NG	2/25/05	JAMES HO	2/25/05

LAYER PAD FOR CARTON(KEM-PK17169)

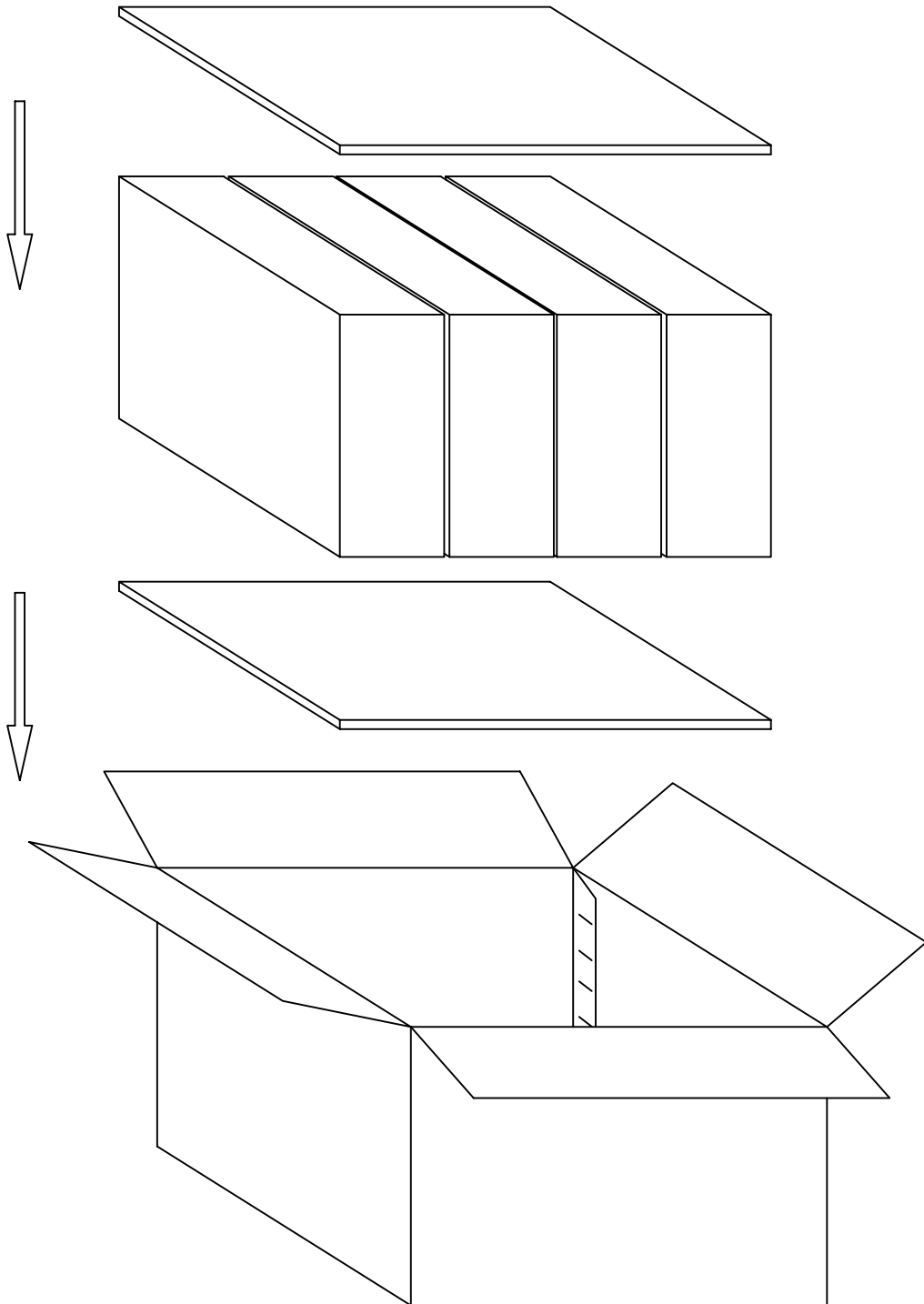

OVERPACK CARTON(KEM-PK17159)

GIANT ELECTRONICS LTD.

MODEL: XMTA0

TITLE: SHIPPING CARTON PACKING METHORD

REV.	PRE.BY	DATE	CHK.BY	DATE	APP.BY	DATE
A	JONY FENG	2/25/05	SW NG	2/25/05	JAMES HO	2/25/05

Security tape
for carton bottom
and carton top

General tape
for carton bottom
and carton top

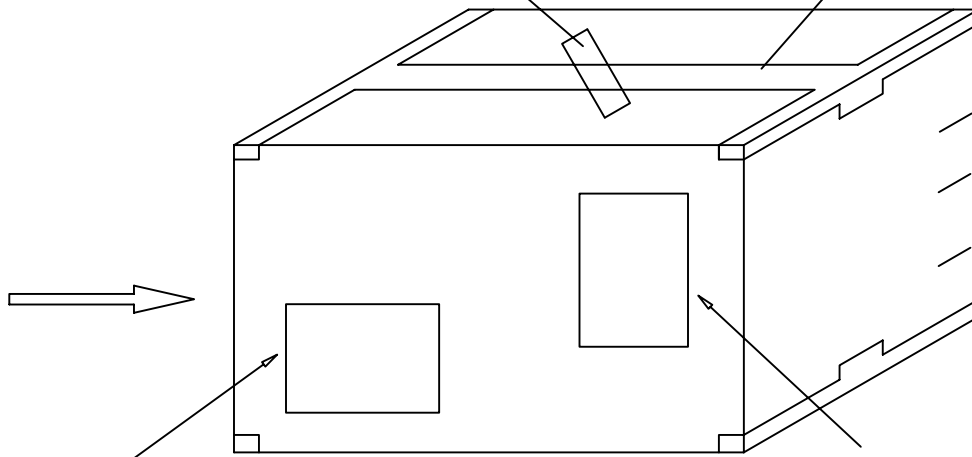

UCC14 LABEL(KEM-PK17173)

CARTON LABEL(KEM-PK17174)

VENDOR STK NO.	PACK/UNITS
TXM1000	4
DESCRIPTION	
COLOR BLACK	
10895593000066	

UCC14 LABEL

MODEL TXM1000	
NUMBER:	
MODEL TXM1000	
NAME: RECHARGEABLE	
TANAPA: GITXM1000	
FREQ.462.0-467.0MHz. 14 CHANNELS MAX.	Date packed: 8:59AM November 03 2005
(Q)Quantity: Q4	
Quantity: 4	
	RR55WEW000G
	RR55WEW000H
	RR55WEW000J
	RR55WEW000K
	RR55WEW000L
UPC#	
8	95593 00020 5

CARTON LABEL

NOTES:

1. STICK GENERAL TAPE AND SECURITY TAPE ON BOTH THE CARTON BOX TOP AND BOTTOM.
2. STICK 1PCS UCC14 LABEL AND 1PCS CARTON LABEL ONTO THE OUTSIDE OF CARTON.

GIANT ELECTRONICS LTD.

MODEL: XMTAO

TITLE: CONTAINER LOAD

REV.	PRE.BY	DATE	CHK.BY	DATE	APP.BY	DATE
A	JONY FENG	2/25/05	SW NG	2/25/05	JAMES HO	2/25/05

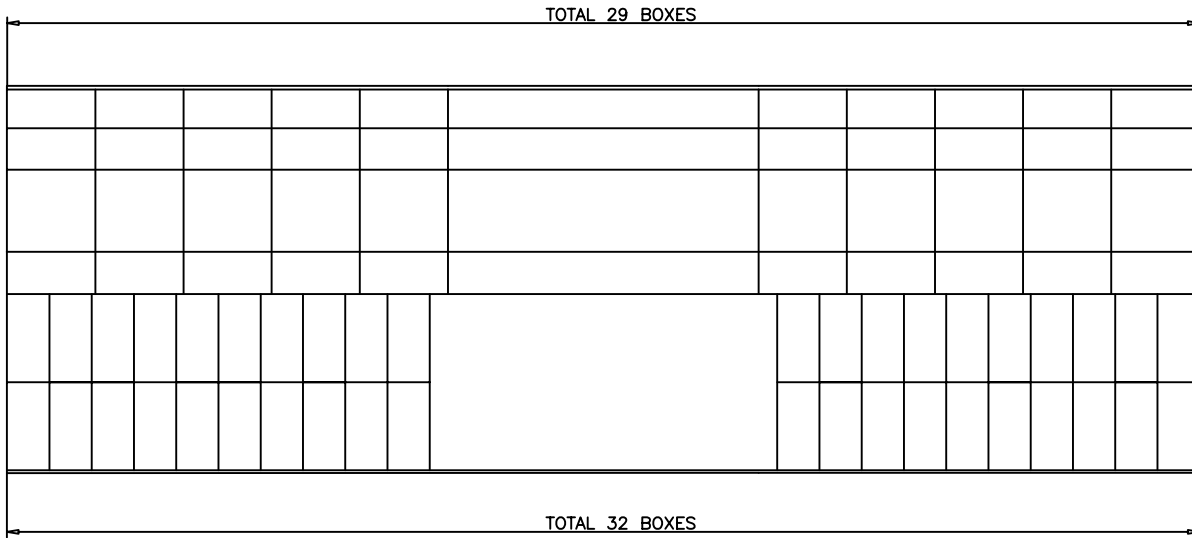

1. 40' CONTAINER CLUB PACKING GOODS LAYOUT(TOP VIEW)
2. 40' CONTAINER CONTAIN $(29 \times 4 + 32 \times 2) \times 8 = 1440$ CARTON BOXES MAX.

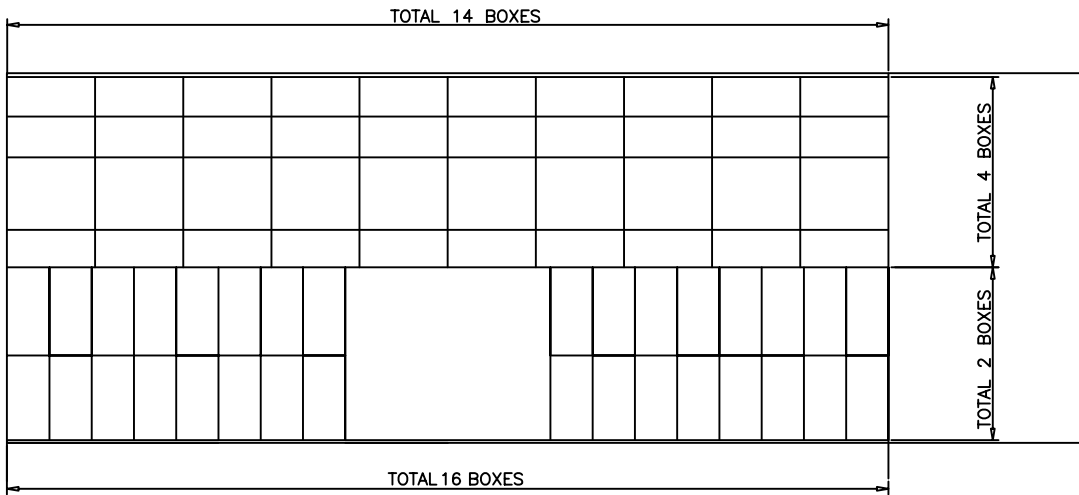

1. 20' CONTAINER CLUB PACKING GOODS LAYOUT(TOP VIEW)
2. 20' CONTAINER CONTAIN $(14 \times 4 + 16 \times 2) \times 8 = 704$ CARTON BOXS MAX.

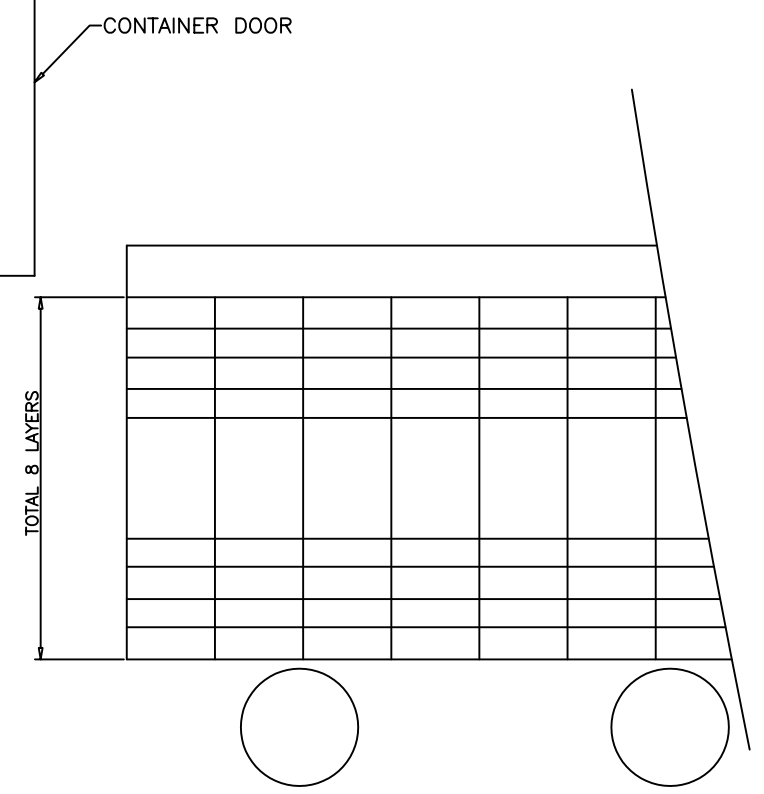

GIANT ELECTRONICS LTD.

MODEL: XMTAO

TITLE: PALLET ASS. DRAWING

REV. PRE.BY DATE

CHK.BY

DATE

APP.BY

DATE

A

JONY FENG

2/25/05

SW NG

2/25/05

JAMES HO

2/25/05

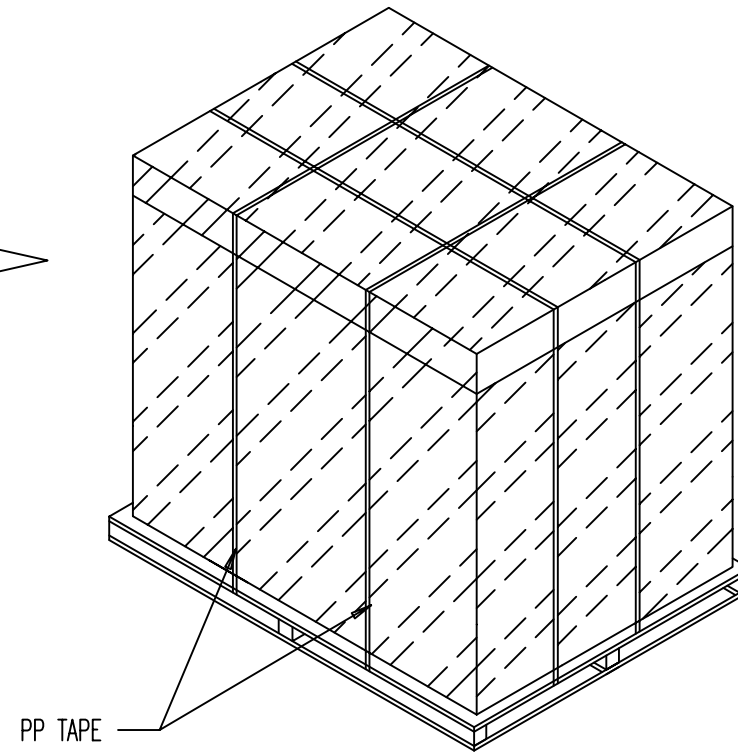
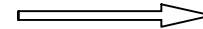
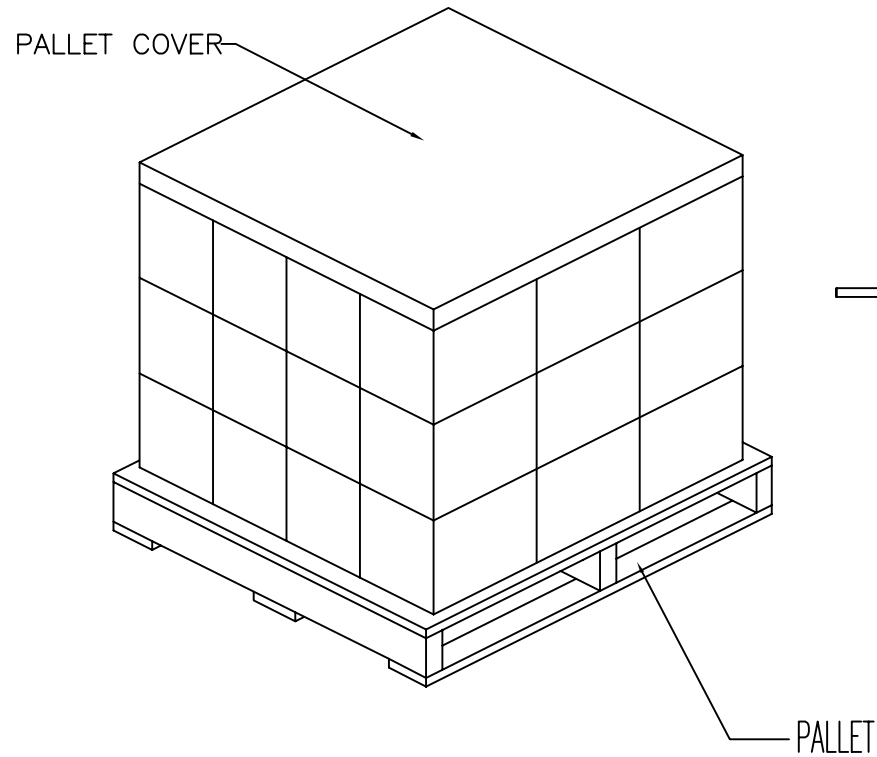

THE ASS. PALLET WRAPPED WITH PRESERVE FILM
AND THE PP TAPE.

NOTES:

1. 27 RABBIT CARTON PER PALLET(3 LAYER).
2. 4 PCS RABBIT PER CARTON.
3. COVERED WITH THE PALLET COVER ON TOP 9 CARTONS .
3. MUST WRAP THE PALLET WITH PRESERVE FILM