



PCTEST ENGINEERING LABORATORY, INC.

7185 Oakland Mills Road, Columbia, MD 21046 USA

Tel. 410.290.6652 / Fax 410.290.6654

http://www.pctest.com

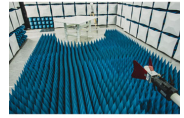

MEASUREMENT REPORT FCC Part 15B

Applicant Name:
Sirius XM Radio Inc.
1500 Eckington Place, NE
Washington, DC 20002
United States
Attn: Beejay Jolayemi

Date of Testing:
11/04 - 11/21/2019
Test Site/Location:
PCTEST Lab. Columbia, MD, USA
Test Report Serial No.:
1M1911040180-06.RS2

FCC ID:	RS2SXWB1
APPLICANT:	Sirius XM Radio Inc.

Application Type: Certification
Model: SXWB1
EUT Type: Satellite Radio with FM Transmitter
FCC Classification: Part 15 Class B Digital Device (JAB)
FCC Rule Part(s): FCC Part 15 Subpart B
Test Procedure(s): ANSI C63.4-2014

This equipment has been shown to be capable of compliance with the applicable technical standards as indicated in the measurement report and has been tested in accordance with the measurement procedures specified in ANSI C63.4-2014 (See Test Report). These measurements were performed with no deviation from the standards. Test results reported herein relate only to the item(s) tested.

I attest to the accuracy of data. All measurements reported herein were performed by me or were made under my supervision and are correct to the best of my knowledge and belief. I assume full responsibility for the completeness of these measurements and vouch for the qualifications of all persons taking them.



Randy Ortanez
President



FCC ID: RS2SXWB1		MEASUREMENT REPORT (CERTIFICATION)		Approved by: Quality Manager
Test Report S/N: 1M1911040180-06.RS2	Test Dates: 11/04 - 11/21/2019	EUT Type: Satellite Radio with FM Transmitter	Page 1 of 27	

TABLE OF CONTENTS

1.0	Introduction	3
1.1	Scope.....	3
1.2	PCTEST Test Location	3
1.3	Test Facility / Accreditations	3
2.0	PRODUCT INFORMATION	4
2.1	Equipment Description	4
2.2	Device Capabilities	4
2.3	Test Configuration	4
2.4	EMI Suppression Device(s)/Modifications.....	4
3.0	DESCRIPTION OF TESTS	5
3.1	Evaluation Procedure	5
3.2	AC Line Conducted Emissions	5
3.3	Radiated Emissions	6
3.4	Environmental Conditions	6
4.0	SAMPLE CALCULATIONS	7
4.1	Conducted Emission Measurement Sample Calculation	7
4.2	Radiated Emission Measurement Sample Calculation	7
5.0	Measurement Uncertainty	8
6.0	TEST EQUIPMENT CALIBRATION DATA.....	9
7.0	TEST DATA	10
7.1	Summary	10
7.2	Test Support Equipment	11
7.3	Radiated Measurement Data	12
7.4	Line Conducted Measurement Data	24
8.0	CONCLUSION	27

FCC ID: RS2SXWB1	 <small>ENGINEERING LABORATORY, INC.</small>	MEASUREMENT REPORT (CERTIFICATION)	 <small>SATELLITE RADIO</small>	Approved by: Quality Manager
Test Report S/N: 1M1911040180-06.RS2	Test Dates: 11/04 - 11/21/2019	EUT Type: Satellite Radio with FM Transmitter	Page 2 of 27	

1.0 INTRODUCTION

1.1 Scope

Measurement and determination of electromagnetic emissions (EMC) of radio frequency devices including intentional and/or unintentional radiators for compliance with the technical rules and regulations of the Federal Communications Commission and Innovation, Science and Economic Development Canada.



1.2 PCTEST Test Location

These measurement tests were conducted at the PCTEST Engineering Laboratory, Inc. facility located at 7185 Oakland Mills Road, Columbia, MD 21046. The measurement facility is compliant with the test site requirements specified in ANSI C63.4-2014.

1.3 Test Facility / Accreditations

Measurements were performed at PCTEST Engineering Lab located in Columbia, MD 21046, U.S.A.

- PCTEST is an ISO 17025-2005 accredited test facility under the American Association for Laboratory Accreditation (A2LA) with Certificate number 2041.01 for Specific Absorption Rate (SAR), Hearing Aid Compatibility (HAC) testing, where applicable, and Electromagnetic Compatibility (EMC) testing for FCC and Innovation, Science, and Economic Development Canada rules.
- PCTEST TCB is a Telecommunication Certification Body (TCB) accredited to ISO/IEC 17065-2012 by A2LA (Certificate number 2041.03) in all scopes of FCC Rules and ISED Standards (RSS).
- PCTEST facility is a registered (2451B) test laboratory with the site description on file with ISED.

FCC ID: RS2SXWB1		MEASUREMENT REPORT (CERTIFICATION)		Approved by: Quality Manager
Test Report S/N: 1M1911040180-06.RS2	Test Dates: 11/04 - 11/21/2019	EUT Type: Satellite Radio with FM Transmitter	Page 3 of 27	

2.0 PRODUCT INFORMATION

2.1 Equipment Description

The Equipment Under Test (EUT) is the **Sirius XM Satellite Radio with FM Transmitter FCC ID: RS2SXWB1**. The test data contained in this report pertains only to the emissions due to the digital circuitry of the EUT.

The radio also contains a previously certified Bluetooth, Bluetooth LE, and 2.4GHz/5GHz WiFi module (FCC ID: RS2LBEE5HY1MW). The emissions for the integration of that module is covered in the C2PC filings for those respective ID's. The EUT is placed on a representative Home Dock and is powered through a standard AC adapter.

Test Device Serial No.: 89337

2.2 Device Capabilities

This device contains the following capabilities:

FM Transmitter, 2.4GHz WiFi, 5GHz UNII, Bluetooth, Bluetooth LE,

2.3 Test Configuration

The EUT was tested with four different configurations. All equipment is placed on the test table top and arranged in a typical configuration in accordance with ANSI C63.4-2014 and manipulated to obtain worst case emissions. Below is a brief list of each configuration set-up.

Test Configuration #	Emissions Tested	Description
1	Unintentional	Receiver (EUT) under test with Home Cradle (Conducted Emissions)
2	Unintentional	Receiver (EUT) under test with Home Cradle (Radiated Emissions)
3	Unintentional	Receiver (EUT) under test with <i>FM Direct</i> adapter
4	Unintentional	Receiver (EUT) under test with Cassette adapter

Table 2-1. Test Configuration Description

For more information please see Section 7.0 for test data and the test setup photos document for the test setup photographs.

2.4 EMI Suppression Device(s)/Modifications

No EMI suppression device(s) were added and no modifications were made during testing.

FCC ID: RS2SXWB1		MEASUREMENT REPORT (CERTIFICATION)		Approved by: Quality Manager
Test Report S/N: 1M1911040180-06.RS2	Test Dates: 11/04 - 11/21/2019	EUT Type: Satellite Radio with FM Transmitter	Page 4 of 27	

3.0 DESCRIPTION OF TESTS

3.1 Evaluation Procedure

The measurement procedure described in the American National Standard for Methods of Measurement of Radio-Noise Emission from Low-Voltage Electrical and Electronic Equipment in the Range of 9kHz to 40GHz (ANSI C63.4-2014) was used in the measurement of the EUT.

Deviation from measurement procedure.....None

3.2 AC Line Conducted Emissions

The line-conducted facility is located inside a 10'x16'x9' shielded enclosure. The shielded enclosure is manufactured by ETS Lindgren RF Enclosures. The shielding effectiveness of the shielded room is in accordance with MIL-Std-285 or NSA 65-5. A 1m x 1.5m wooden table 80cm high is placed 40cm away from the vertical wall and 80cm away from the sidewall of the shielded room. Two 10kHz-30MHz, 50Ω/50μH Line-Impedance Stabilization Networks (LISNs) are bonded to the shielded room floor. Power to the LISNs is filtered by external high-current high-insertion loss power line filters. The external power line filter is an ETS Lindgren Model LPRX-4X30 (100dB Attenuation, 14kHz-18GHz) and the two EMI/RFI filters are ETS Lindgren Model LRW-2030-S1 (100dB Minimum Insertion Loss, 14kHz – 10GHz). These filters attenuate ambient signal noise from entering the measurement lines. These filters are also bonded to the shielded enclosure.

The EUT is powered from one LISN and the support equipment is powered from the second LISN. If the EUT is a DC-powered device, power will be derived from the source power supply it normally will be powered from and this supply line(s) will be connected to the second LISN. All interconnecting cables more than 1 meter were shortened to a 1 meter length by non-inductive bundling (serpentine fashion) and draped over the back edge of the test table. All cables were at least 40cm above the horizontal reference groundplane. Power cables for support equipment were routed down to the second LISN while ensuring that that cables were not draped over the second LISN.

Sufficient time for the EUT, support equipment, and test equipment was allowed in order for them to warm up to their normal operating condition. The RF output of the LISN was connected to the spectrum analyzer and exploratory measurements were made to determine the frequencies producing the maximum emission from the EUT. The spectrum was scanned from 150kHz to 30MHz with a spectrum analyzer. The detector function was set to peak mode for exploratory measurements while the bandwidth of the analyzer was set to 10kHz. The EUT, support equipment, and interconnecting cables were arranged and manipulated to maximize each emission. Once the worst case emissions have been identified, the one EUT cable configuration/arrangement and mode of operation that produced these emissions is used for final measurements on the same test site. The analyzer is set to CISPR quasi-peak and average detectors with a 9kHz resolution bandwidth for final measurements.

Line conducted emissions test results are shown in Section 7.4. The EMI Receiver mode of the Agilent MXE was used to perform AC line conducted emissions testing.

FCC ID: RS2SXWB1		MEASUREMENT REPORT (CERTIFICATION)		Approved by: Quality Manager
Test Report S/N: 1M1911040180-06.RS2	Test Dates: 11/04 - 11/21/2019	EUT Type: Satellite Radio with FM Transmitter	Page 5 of 27	

3.3 Radiated Emissions

The radiated test facilities consisted of an indoor 3 meter semi-anechoic chamber used for final measurements and exploratory measurements, when necessary. The measurement area is contained within the semi-anechoic chamber which is shielded from any ambient interference. The test site inside the chamber is a 6m x 5.2m elliptical, obstruction-free area in accordance with Clause 5, Figure 5.7 of ANSI C63.4-2014. A raised turntable is used for radiated measurement. It is a continuously rotatable, remote-controlled, metallic turntable and 2 meters (6.56 ft.) in diameter. The turn table is flush with the raised floor of the chamber in order to maintain its function as a ground plane. Absorbers are arranged on the floor between the turn table and the antenna mast in such a way so as to maximize the reduction of reflections for measurements above 1GHz. . An 80cm tall test table made of Styrodur is placed on top of the turn table. For measurements above 1GHz, an additional Styrodur pedestal is placed on top of the test table to bring the total table height to 1.5m.



For all measurements, the spectrum was scanned through all EUT azimuths and from 1 to 4 meter receive antenna height using a broadband antenna from 30MHz up to the upper frequency shown in 15.33(b)(1) depending on the highest frequency generated or used in the device or on which the device operates or tunes. For frequencies above 1GHz, linearly polarized double ridge horn antennas were used. For frequencies below 30MHz, a calibrated loop antenna was used. When exploratory measurements were necessary, they were performed at 1 meter test distance inside the semi-anechoic chamber using broadband antennas, broadband amplifiers, and spectrum analyzers to determine the frequencies and modes producing the maximum emissions. Sufficient time for the EUT, support equipment, and test equipment was allowed in order for them to warm up to their normal operating condition. The test set-up was placed on top of the 1 x 1.5 meter table. The EUT, support equipment, and interconnecting cables were arranged and manipulated to maximize each emission. Appropriate precaution was taken to ensure that all emissions from the EUT were maximized and investigated. The system configuration, mode of operation, turntable azimuth, and receive antenna height was noted for each frequency found.

Final measurements were made in the semi-anechoic chamber using calibrated, linearly polarized broadband and horn antennas. The test setup was configured to the setup that produced the worst case emissions. The spectrum analyzer was set to investigate all frequencies required for testing to compare the highest radiated disturbances with respect to the specified limits. The turntable containing the EUT was rotated through 360 degrees and the height of the receive antenna was varied 1 to 4 meters and stopped at the azimuth and height producing the maximum emission. Each emission was maximized by changing the orientation of the EUT through three orthogonal planes and changing the polarity of the receive antenna, whichever produced the worst-case emissions.

All radiated measurements are performed in a chamber that meets the site requirements per ANSI C63.4-2014. Additionally, radiated emissions below 30MHz are also validated on an Open Area Test Site to assert correlation with the chamber measurements per the requirements of KDB 474788 D01.

3.4 Environmental Conditions

The temperature is controlled within range of 15°C to 35°C. The relative humidity is controlled within range of 10% to 75%. The atmospheric pressure is monitored within the range 86-106kPa (860-1060mbar).

FCC ID: RS2SXWB1		MEASUREMENT REPORT (CERTIFICATION)		Approved by: Quality Manager
Test Report S/N: 1M1911040180-06.RS2	Test Dates: 11/04 - 11/21/2019	EUT Type: Satellite Radio with FM Transmitter	Page 6 of 27	

4.0 SAMPLE CALCULATIONS

4.1 Conducted Emission Measurement Sample Calculation

@ 20.3 MHz

Class B limit = 60.0 dB μ V (Quasi-peak limit)
 Reading = - 57.8 dBm (calibrated quasi-peak level)
 Convert to dB μ V = - 57.8 + 107 = 49.2 dB μ V

 Margin = 49.2 - 60.0 = - 10.8 dB
 = **10.8 dB below limit**

4.2 Radiated Emission Measurement Sample Calculation

@ 66.7 MHz



Class B limit = 100 μ V/m = 40.0 dB μ V/m
 Reading = - 76.0 dBm (calibrated level)
 Convert to dB μ V = - 76.0 + 107 = 31.0 dB μ V
 Antenna Factor + Cable Loss = 5.8 dB/m
 Total = 36.8 dB μ V/m

 Margin = 36.8 - 40.0 = - 3.2 dB
 = **3.2 dB below limit**

Note:

$$\text{Level [dB}\mu\text{V]} = 20 \log_{10} (\text{Level } [\mu\text{V/m}])$$



$$\text{Level [dB}\mu\text{V]} = \text{Level [dBm]} + 107$$

FCC ID: RS2SXWB1		MEASUREMENT REPORT (CERTIFICATION)		Approved by: Quality Manager
Test Report S/N: 1M1911040180-06.RS2	Test Dates: 11/04 - 11/21/2019	EUT Type: Satellite Radio with FM Transmitter	Page 7 of 27	

5.0 MEASUREMENT UNCERTAINTY

The measurement uncertainties shown below were calculated in accordance with the requirements of ANSI C63.4-2014. All measurement uncertainty values are shown with a coverage factor of $k = 2$ to indicate a 95% level of confidence. The measurement uncertainty shown below meets or exceeds the U_{CISPR} measurement uncertainty values specified in CISPR 16-4-2 and, thus, can be compared directly to specified limits to determine compliance.

Contribution	Expanded Uncertainty (\pm dB)
Conducted Disturbance	3.09
Radiated Disturbance (<1GHz)	4.98
Radiated Disturbance (>1GHz)	5.07



FCC ID: RS2SXWB1		MEASUREMENT REPORT (CERTIFICATION)		Approved by: Quality Manager
Test Report S/N: 1M1911040180-06.RS2	Test Dates: 11/04 - 11/21/2019	EUT Type: Satellite Radio with FM Transmitter	Page 8 of 27	

6.0 TEST EQUIPMENT CALIBRATION DATA

Test Equipment Calibration is traceable to the National Institute of Standards and Technology (NIST). Measurements antennas used during testing were calibrated in accordance to the requirements of ANSI C63.5-2017.

Manufacturer	Model	Description	Cal Date	Cal Interval	Cal Due	Serial Number
Keysight	N9030A	PXA Signal Analyzer (26.5GHz)	9/13/2019	Annual	9/13/2020	MY54490576
Emco	3115	Horn Antenna (1-18GHz)	3/28/2018	Biennial	3/28/2020	9704-5182
Rohde & Schwarz	ESU26	EMI Test Receiver (26.5GHz)	6/5/2019	Annual	6/5/2020	100342
Rohde & Schwarz	SFUNIT-Rx	Shielded Filter Unit	7/11/2019	Annual	7/11/2020	102134
Sunol	JB5	Bi-Log Antenna (30M - 5GHz)	4/19/2018	Biennial	4/19/2020	A051107

Table 6-1. Annual Test Equipment Calibration Schedule

FCC ID: RS2SXWB1		MEASUREMENT REPORT (CERTIFICATION)		Approved by: Quality Manager
Test Report S/N: 1M1911040180-06.RS2	Test Dates: 11/04 - 11/21/2019	EUT Type: Satellite Radio with FM Transmitter	Page 9 of 27	

7.0 TEST DATA

7.1 Summary

Test Date(s): 11/04 - 11/21/2019

Test Engineer: John Reidell

FCC Part 15 Section	Description	Result
15.107	Conducted Emissions	PASS
15.109	Radiated Emissions	PASS

Table 7-1. Summary of Test Results

FCC ID: RS2SXWB1		MEASUREMENT REPORT (CERTIFICATION)		Approved by: Quality Manager
Test Report S/N: 1M1911040180-06.RS2	Test Dates: 11/04 - 11/21/2019	EUT Type: Satellite Radio with FM Transmitter	Page 10 of 27	

7.2 Test Support Equipment

Manufacturer	Model	Description
Sirius XM	SXDH3	Dock & Play Home Kit
Sirius XM	XDPIV2	PowerConnect Car Dock
Sirius XM	SXDPIP1	PowerConnect Car Power Adapter
N/A	N/A	FM Whip Antenna
Sirius XM	XMC-10 (Cradle)	Xpress Car Dock
Sirius XM	OCT00256M	CLA Car Power Adapter
Sirius XM	NGVA3	Sirius XM Satellite Antenna
Sirius XM	N/A	5V PowerConnect iFMCLA
Sirius XM	XMSC-1	SureConnect Adapter
Sirius XM	N/A	Remote Control
Sirius XM	FMDA25	FM Direct Adapter
Sirius XM	XMFM1	FM Direct Adapter
Sirius XM	SA10007	Cassette Adapter
Sirius XM	FEA25A	FEA Adapter
Sirius XM	N/A	Cigarette Lighter Socket with Twisted Pair Cable
Exide	Classic Part#: 25C	12V Car Battery
JFW Industries	50BT-038	Bias-T

Table 7-2. Test Support Equipment Used

Note: See test setup photographs for actual system test setup.

FCC ID: RS2SXWB1		MEASUREMENT REPORT (CERTIFICATION)		Approved by: Quality Manager
Test Report S/N: 1M1911040180-06.RS2	Test Dates: 11/04 - 11/21/2019	EUT Type: Satellite Radio with FM Transmitter	Page 11 of 27	

7.3 Radiated Measurement Data

§15.109; ICES-003 (6.2)

Test Overview and Limit

All out of band radiated spurious emissions are measured with a spectrum analyzer connected to a receive antenna while the EUT is operating at maximum power and at the appropriate frequencies. Only the radiated emissions of the configuration that produced the worst case emissions are reported in this section.

All out of band emissions must not exceed the limits shown in Table 7-3 per Section 15.109 and ICES-003 (6.2).

Frequency [MHz]	Field Strength Limit [$\mu\text{V/m}$]
30 – 88	100
88 – 216	150
216 – 960	200
> 960	500

Table 7-3. 3-Meter Radiated Limits (Section 15.109)

Test Procedures Used

ANSI C63.4-2014



Test Settings

Quasi-Peak Field Strength Measurements

1. Analyzer frequency set to the frequency of the radiated spurious emission of interest
2. RBW = 120kHz (for emissions from 30MHz – 1GHz)
3. Detector = quasi-peak
4. Sweep time = auto couple
5. Trace mode = max hold
6. Trace was allowed to stabilize

Test Setup

The EUT and measurement equipment were set up as shown test setup photos provided.

FCC ID: RS2SXWB1		MEASUREMENT REPORT (CERTIFICATION)		Approved by: Quality Manager
Test Report S/N: 1M1911040180-06.RS2	Test Dates: 11/04 - 11/21/2019	EUT Type: Satellite Radio with FM Transmitter	Page 12 of 27	

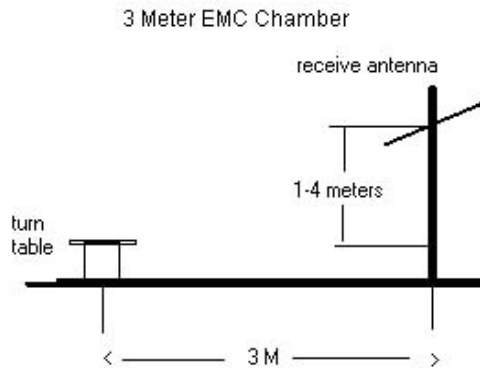

Table 7-4. Test Instrument & Measurements setup

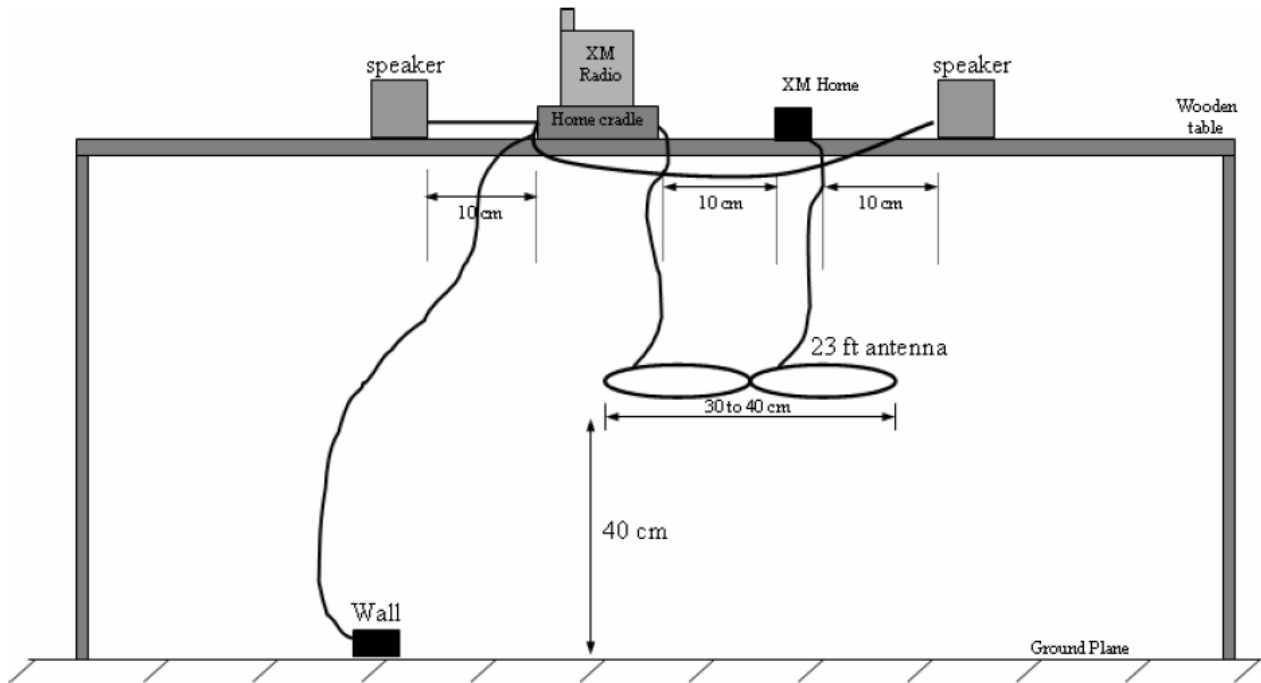

Figure 7-1. Test Instrument & Measurements setup (Configuration #2)

FCC ID: RS2SXWB1	PCTEST ENGINEERING LABORATORY, INC.	MEASUREMENT REPORT (CERTIFICATION)	SIRIUSXM SATELLITE RADIO	Approved by: Quality Manager
Test Report S/N: 1M1911040180-06.RS2	Test Dates: 11/04 - 11/21/2019	EUT Type: Satellite Radio with FM Transmitter	Page 13 of 27	

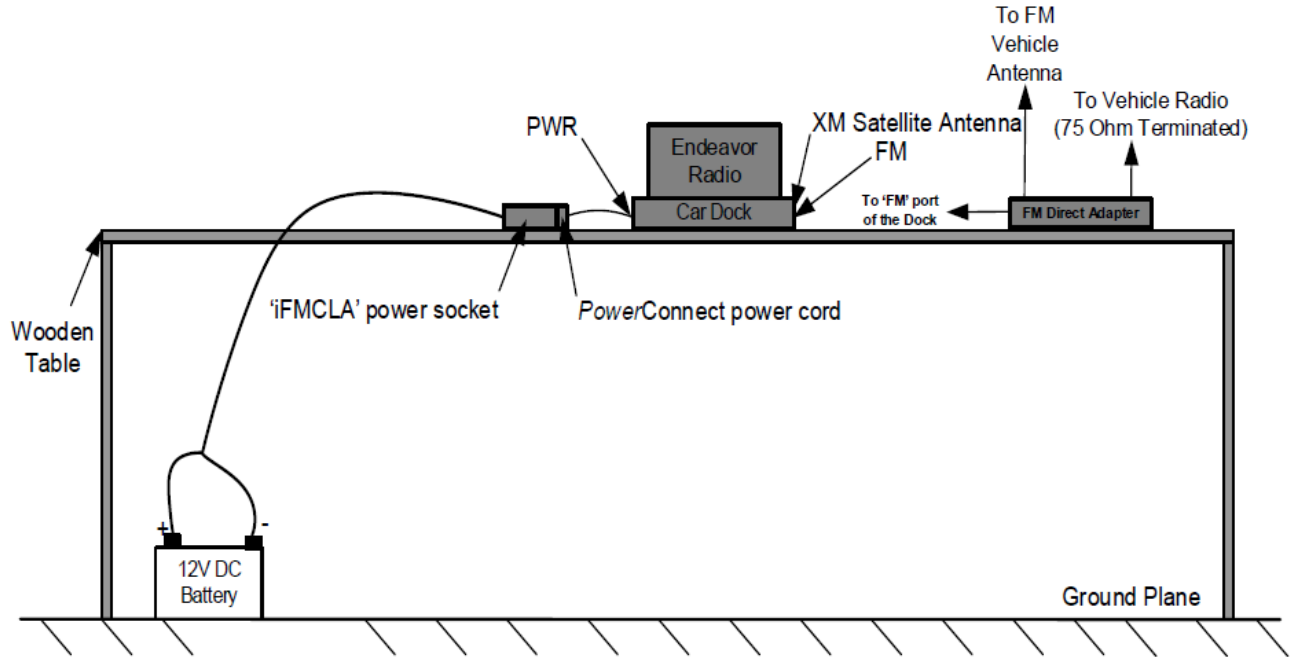

Figure 7-2. Test Instrument & Measurements setup (Configuration #3)

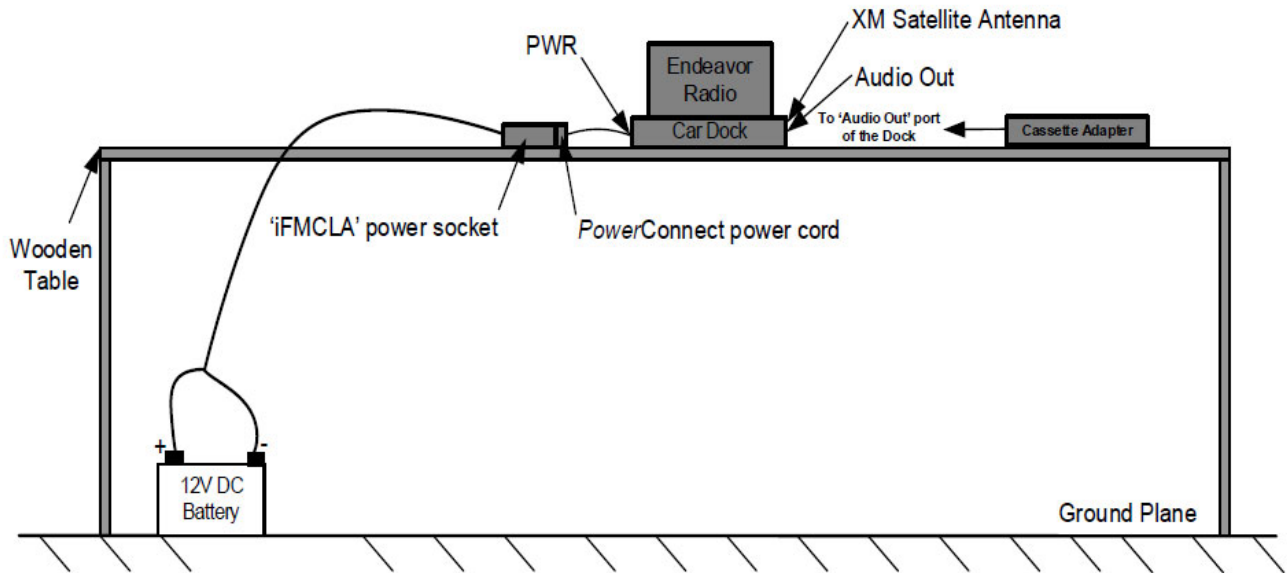





Figure 7-3. Test Instrument & Measurements setup (Configuration #4)

FCC ID: RS2SXWB1	 PCTEST ENGINEERING LABORATORY, INC.	MEASUREMENT REPORT (CERTIFICATION)	 SiriusXM SATELLITE RADIO	Approved by: Quality Manager
Test Report S/N: 1M1911040180-06.RS2	Test Dates: 11/04 - 11/21/2019	EUT Type: Satellite Radio with FM Transmitter		Page 14 of 27

Test Notes

1. All modes of operation were investigated and the worst-case emissions are reported.
2. Radiated emissions were measured from 30MHz – 1GHz to ensure that the provisions of 15.33(b)(1) are satisfied with respect to the upper frequency scanning range.
3. The radiated limits for unintentional radiators at a distance of 3 meters are used in the table above, as specified in 15.109(a).
4. All readings are calibrated by a signal generator with accuracy traceable to the National Institute of Standards and Technology (NIST).
5. AFCL (dB/m) = Antenna Factor (dB/m) + Cable Loss (dB)
6. Level (dB μ V/m) = Analyzer Reading (dBm) + AFCL (dB/m) + 107
7. Margin (dB) = Field strength (dB μ V/m) – Limit (dB μ V/m)
8. Measurements are made using a CISPR quasi-peak detector with a 120kHz resolution bandwidth. Above 1GHz, peak measurements are made using a peak detector with a resolution bandwidth of 1MHz and a video bandwidth of 3MHz and average measurements are made with a RMS detector using a resolution bandwidth of 1MHz and a video bandwidth of 3MHz.
9. Calibrated linearly polarized broadband and horn antennas were used for measurements below and above 1GHz, respectively. For measurements made below 1GHz, the results recorded using the broadband antenna are known to correlate with the results obtained by using a tuned dipole with an acceptable degree of accuracy. The VSWR for the measurement antennas was found to be less than 2:1.
10. Calibrated low-loss microwaves cables and broadband amplifiers are used.

FCC ID: RS2SXWB1	 MEASUREMENT REPORT (CERTIFICATION) 		Approved by: Quality Manager
Test Report S/N: 1M1911040180-06.RS2	Test Dates: 11/04 - 11/21/2019	EUT Type: Satellite Radio with FM Transmitter	Page 15 of 27

Radiated Measurement Data – Configuration #2

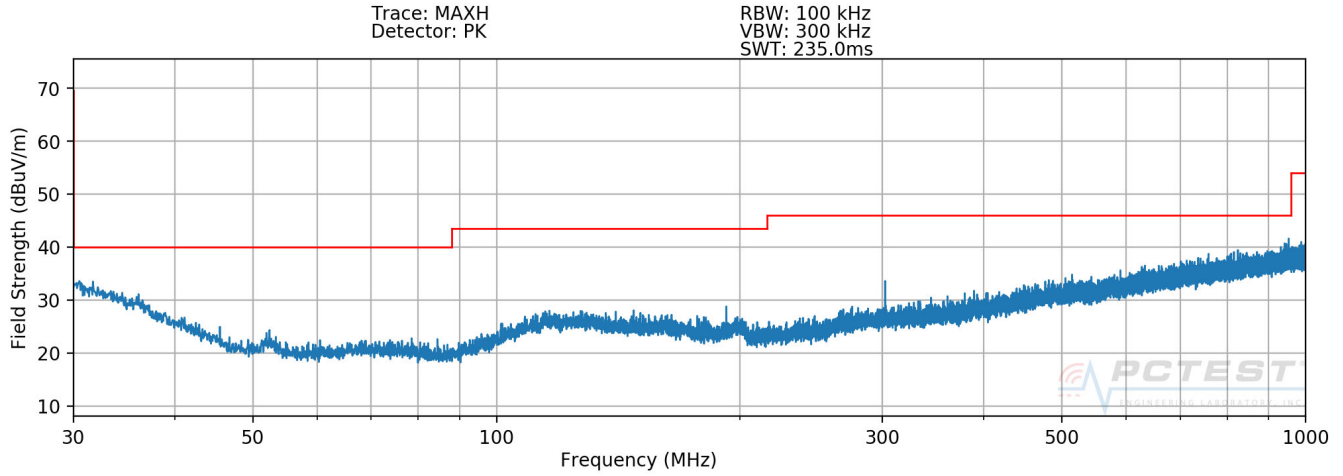

Plot 7-1. Radiated Spurious Plot below 1GHz (Configuration #2, Pol. H)

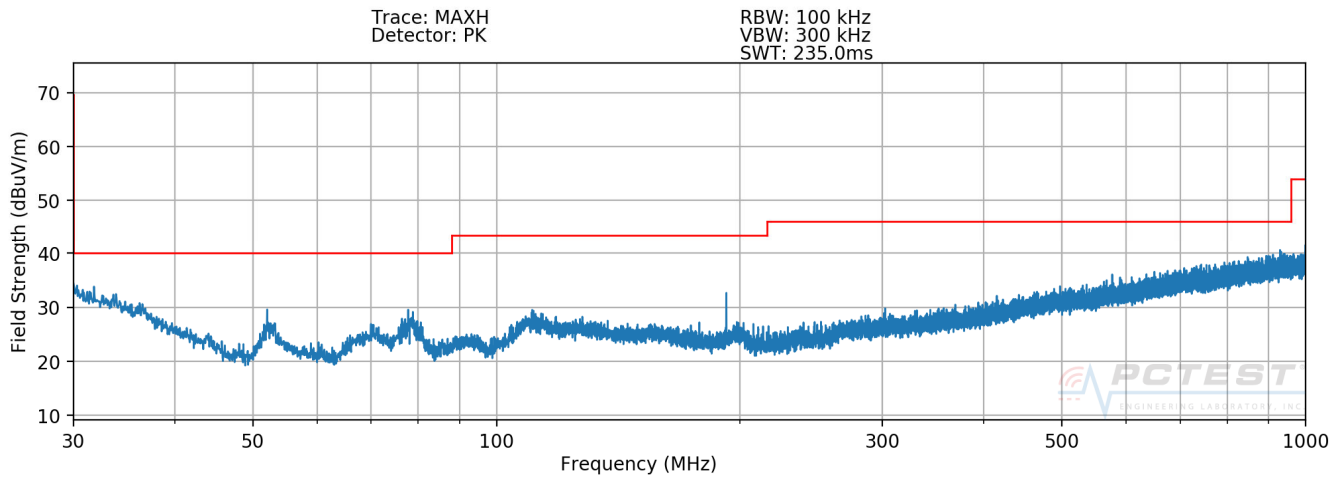

Plot 7-2. Radiated Spurious Plot below 1GHz (Configuration #2, Pol. V)

FCC ID: RS2SXWB1	PCTEST ENGINEERING LABORATORY, INC.	MEASUREMENT REPORT (CERTIFICATION)	SiriusXM SATELLITE RADIO	Approved by: Quality Manager
Test Report S/N: 1M1911040180-06.RS2	Test Dates: 11/04 - 11/21/2019	EUT Type: Satellite Radio with FM Transmitter	Page 16 of 27	

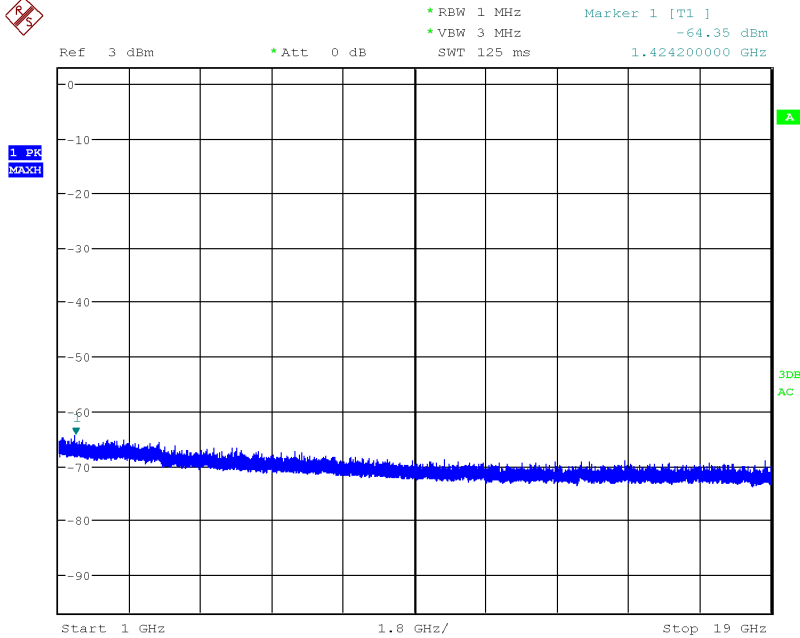

Date: 21.NOV.2019 10:30:57

Plot 7-3. Radiated Spurious Plot above 1GHz (Configuration #2, Pol. H)

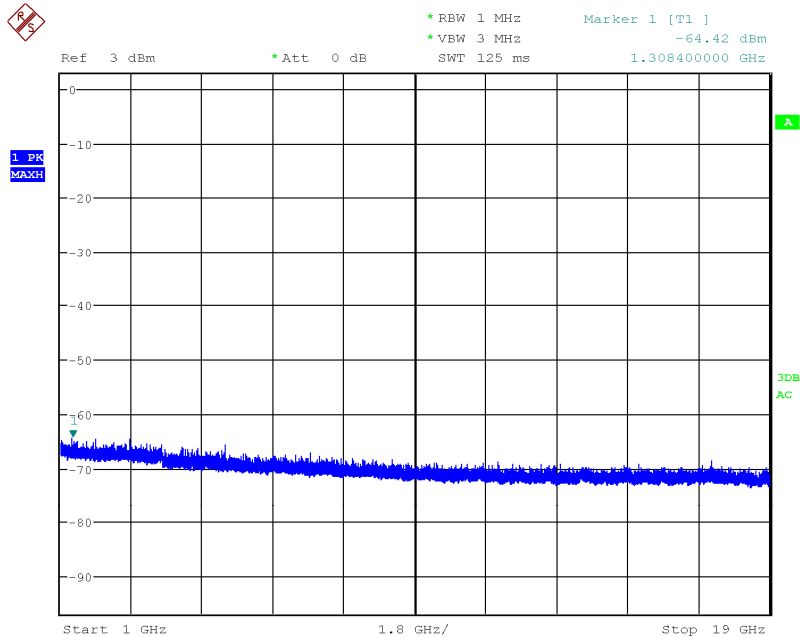

Date: 21.NOV.2019 10:37:36

Plot 7-4. Radiated Spurious Plot above 1GHz (Configuration #2, Pol. V)

FCC ID: RS2SXWB1	PCTEST ENGINEERING LABORATORY, INC.	MEASUREMENT REPORT (CERTIFICATION)	SiriusXM SATELLITE RADIO	Approved by: Quality Manager
Test Report S/N: 1M1911040180-06.RS2	Test Dates: 11/04 - 11/21/2019	EUT Type: Satellite Radio with FM Transmitter	Page 17 of 27	

Radiated Measurement Data – Configuration #3

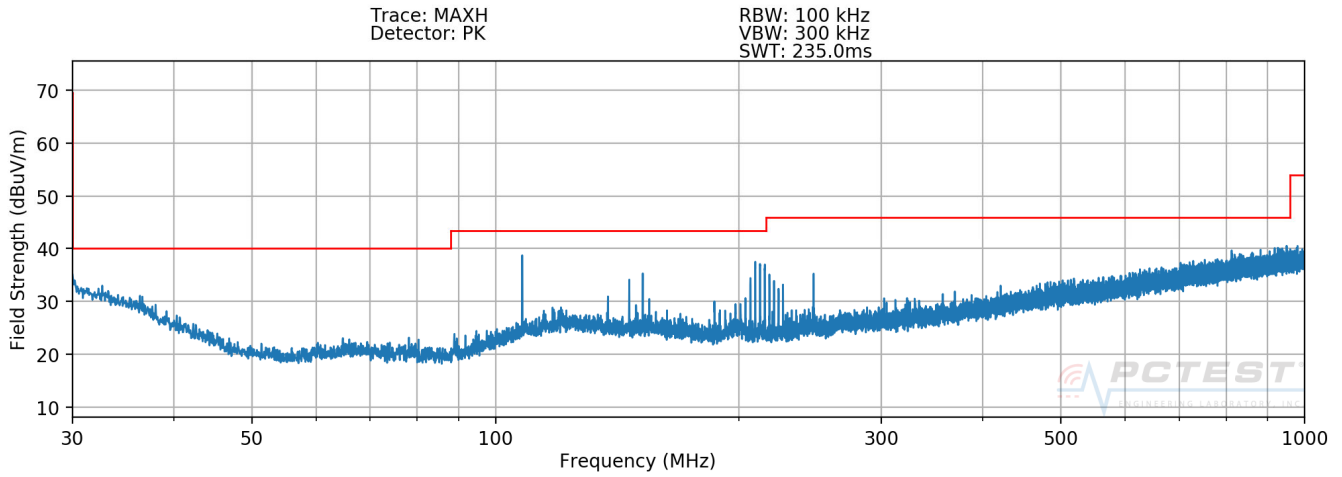

Plot 7-5. Radiated Spurious Plot below 1GHz (Configuration #3, Pol. H)

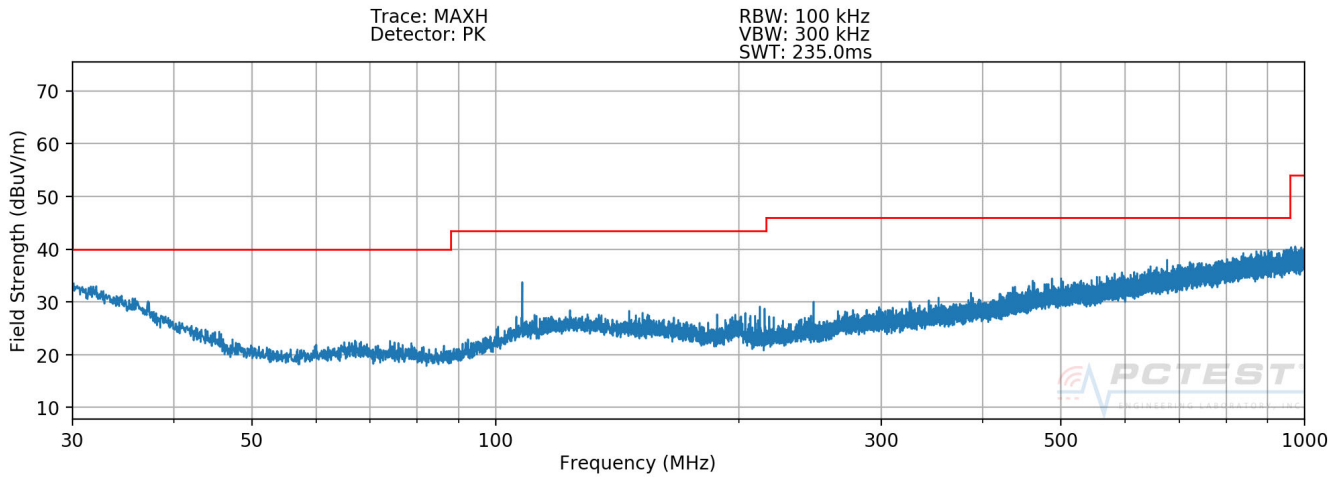

Plot 7-6. Radiated Spurious Plot below 1GHz (Configuration #3, Pol. V)

FCC ID: RS2SXWB1	PCTEST ENGINEERING LABORATORY, INC.	MEASUREMENT REPORT (CERTIFICATION)	SiriusXM SATELLITE RADIO	Approved by: Quality Manager
Test Report S/N: 1M1911040180-06.RS2	Test Dates: 11/04 - 11/21/2019	EUT Type: Satellite Radio with FM Transmitter	Page 18 of 27	

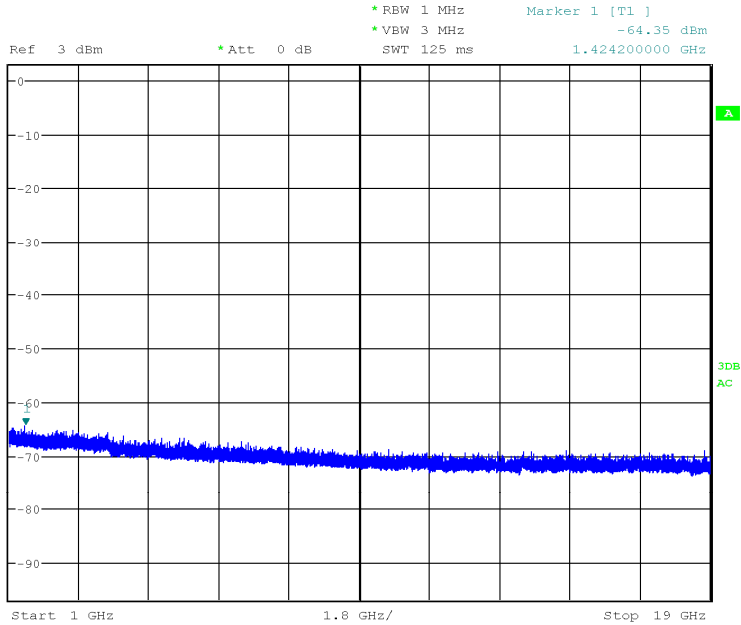

Date: 21.NOV.2019 10:30:57

Plot 7-7. Radiated Spurious Plot above 1GHz (Configuration #3, Pol. H)

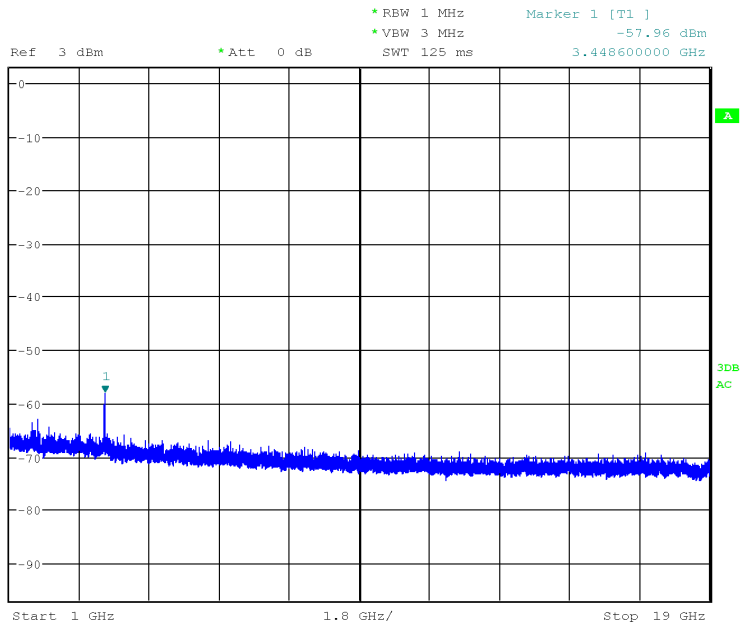

Date: 21.NOV.2019 11:28:35

Plot 7-8. Radiated Spurious Plot above 1GHz (Configuration #3, Pol. V)

FCC ID: RS2SXWB1	PCTEST ENGINEERING LABORATORY, INC.	MEASUREMENT REPORT (CERTIFICATION)	SIRIUSXM SATELLITE RADIO	Approved by: Quality Manager
Test Report S/N: 1M1911040180-06.RS2	Test Dates: 11/04 - 11/21/2019	EUT Type: Satellite Radio with FM Transmitter	Page 19 of 27	

Radiated Measurement Data – Configuration #4

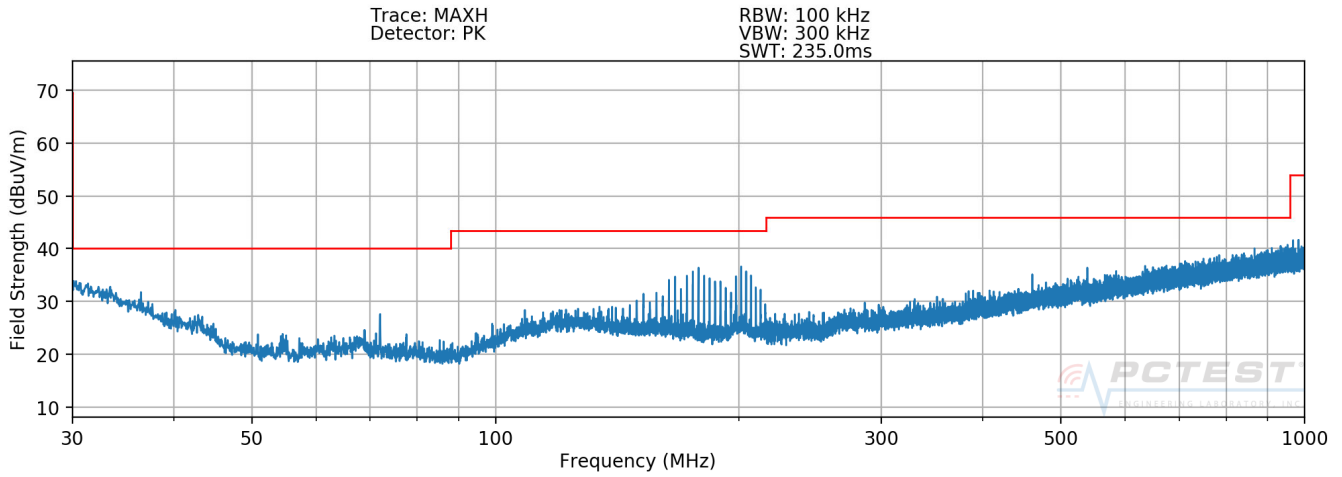

Plot 7-9. Radiated Spurious Plot below 1GHz (Configuration #4, Pol. H)

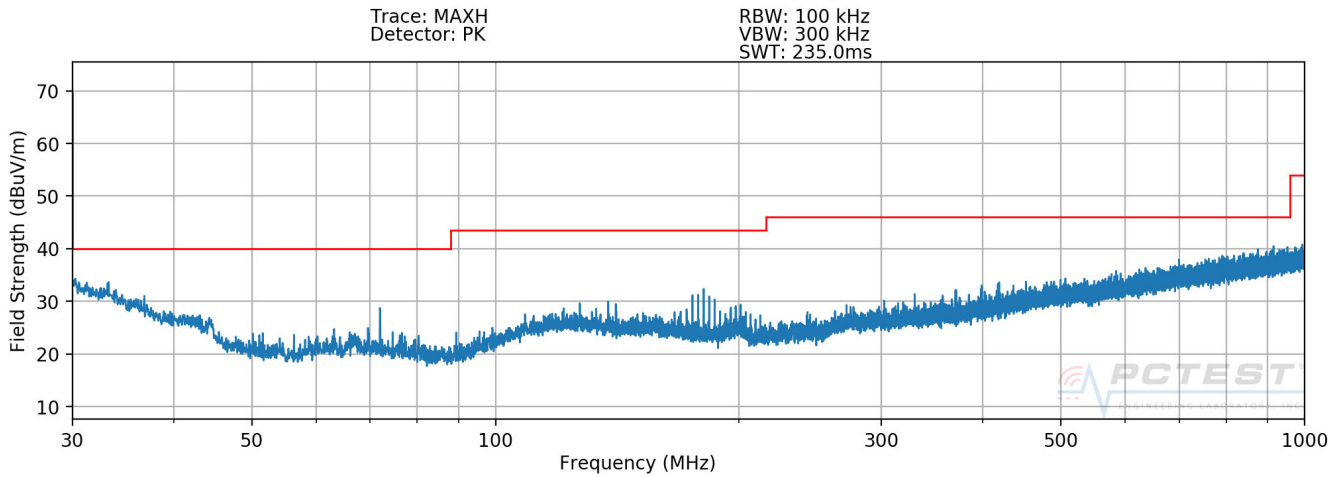

Plot 7-10. Radiated Spurious Plot below 1GHz (Configuration #4, Pol. V)

FCC ID: RS2SXWB1		MEASUREMENT REPORT (CERTIFICATION)		Approved by: Quality Manager
Test Report S/N: 1M1911040180-06.RS2	Test Dates: 11/04 - 11/21/2019	EUT Type: Satellite Radio with FM Transmitter	Page 20 of 27	

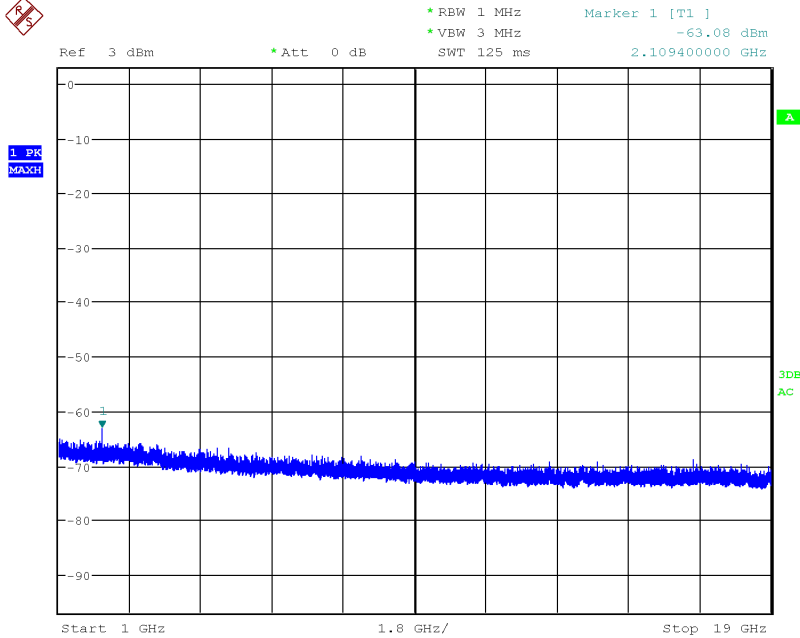

Date: 21.NOV.2019 10:56:17

Plot 7-11. Radiated Spurious Plot above 1GHz (Configuration #4, Pol. H)

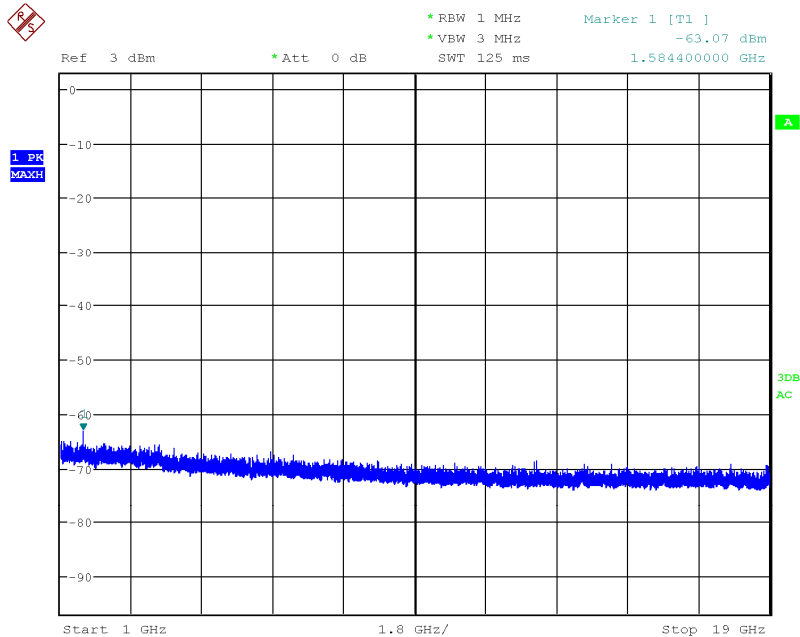

Date: 21.NOV.2019 10:53:46

Plot 7-12. Radiated Spurious Plot above 1GHz (Configuration #4, Pol. V)

FCC ID: RS2SXWB1	PCTEST ENGINEERING LABORATORY, INC.	MEASUREMENT REPORT (CERTIFICATION)	SiriusXM SATELLITE RADIO	Approved by: Quality Manager
Test Report S/N: 1M1911040180-06.RS2	Test Dates: 11/04 - 11/21/2019	EUT Type: Satellite Radio with FM Transmitter	Page 21 of 27	

Frequency [MHz]	Detector	Ant. Pol. [H/V]	Level [dBm]	AFCL [dB/m]	Field Strength [dB μ V/m]	Limit [dB μ V/m]	Margin [dB]
53.14	Peak	V	-91.22	13.69	29.47	40.00	-10.53
185.56	Peak	H	-96.84	18.20	28.36	43.52	-15.16
191.57	Peak	V	-91.18	18.20	34.02	43.52	-9.50
301.62	Peak	H	-91.19	21.23	37.04	46.02	-8.98

Table 7-5. Radiated Measurements at 3-meters (Configuration #2)

Frequency [MHz]	Detector	Ant. Pol. [H/V]	Level [dBm]	AFCL [dB/m]	Field Strength [dB μ V/m]	Limit [dB μ V/m]	Margin [dB]
44.27	Quasi-Peak	V	-89.3	17.28	34.98	40.00	-5.02
45.30	Quasi-Peak	V	-89.1	16.73	34.63	40.00	-5.37
49.95	Quasi-Peak	V	-96.79	18.44	28.65	40.00	-11.35
56.55	Quasi-Peak	V	-86.45	13.69	34.24	40.00	-5.76
57.80	Quasi-Peak	V	-93.8	18.01	31.21	40.00	-8.79
65.45	Quasi-Peak	V	-89.14	18.20	36.06	40.00	-3.94
72.27	Quasi-Peak	V	-91.35	14.95	30.60	40.00	-9.40
157.00	Quasi-Peak	H	-90.89	22.29	38.40	43.52	-5.12
206.30	Quasi-Peak	H	-90.96	21.23	37.27	43.52	-6.25
209.25	Quasi-Peak	H	-92.232	17.52	32.29	43.52	-11.24
209.30	Quasi-Peak	H	-88.88	22.29	40.41	43.52	-3.11

Table 7-6. Radiated Measurements at 3-meters (Configuration #3)

FCC ID: RS2SXWB1		MEASUREMENT REPORT (CERTIFICATION)		Approved by: Quality Manager
Test Report S/N: 1M1911040180-06.RS2	Test Dates: 11/04 - 11/21/2019	EUT Type: Satellite Radio with FM Transmitter		Page 22 of 27

Frequency [MHz]	Detector	Ant. Pol. [H/V]	Level [dBm]	AFCL [dB/m]	Field Strength [dB μ V/m]	Limit [dB μ V/m]	Margin [dB]
75.15	Quasi-Peak	V	-84.36	13.69	36.33	40.00	-3.67
129.35	Quasi-Peak	V	-88.34	18.20	36.86	43.52	-6.66
160.85	Quasi-Peak	H	-91.23	21.23	37.00	43.52	-6.52
186.90	Quasi-Peak	H	-92.89	21.23	35.34	43.52	-8.18
203.60	Quasi-Peak	H	-92.17	22.29	37.12	43.52	-6.40

Table 7-7. Radiated Measurements at 3-meters (Configuration #4)

FCC ID: RS2SXWB1		MEASUREMENT REPORT (CERTIFICATION)			Approved by: Quality Manager
Test Report S/N: 1M1911040180-06.RS2	Test Dates: 11/04 - 11/21/2019	EUT Type: Satellite Radio with FM Transmitter			Page 23 of 27

7.4 Line Conducted Measurement Data

§15.107; ICES-003 (6.1)

Test Overview and Limit

All AC line conducted spurious emissions are measured with a receiver connected to a grounded LISN while the EUT is operating at its maximum duty cycle, at maximum power, and at the appropriate frequencies. All data rates and modes were investigated for conducted spurious emissions. Only the conducted emissions of the configuration that produced the worst case emissions are reported in this section.

All conducted emissions must not exceed the limits shown in the table below, per Section 15.107 and ICES-003 (6.1).

Frequency of emission (MHz)	Conducted Limit (dBμV)	
	Quasi-peak	Average
0.15 – 0.5	66 to 56*	56 to 46*
0.5 – 5	56	46
5 – 30	60	50

Table 7-6. Conducted Limits

*Decreases with the logarithm of the frequency.

Test Procedures Used

ANSI C63.4-2014

Test Settings

Quasi-Peak Field Strength Measurements

1. Analyzer center frequency was set to the frequency of the spurious emission of interest
2. RBW = 9kHz (for emissions from 150kHz – 30MHz)
3. Detector = quasi-peak
4. Sweep time = auto couple
5. Trace mode = max hold
6. Trace was allowed to stabilize

Average Field Strength Measurements

1. Analyzer center frequency was set to the frequency of the spurious emission of interest
2. RBW = 9kHz (for emissions from 150kHz – 30MHz)
3. Detector = RMS
4. Sweep time = auto couple
5. Trace mode = max hold
6. Trace was allowed to stabilize

FCC ID: RS2SXWB1		MEASUREMENT REPORT (CERTIFICATION)		Approved by: Quality Manager
Test Report S/N: 1M1911040180-06.RS2	Test Dates: 11/04 - 11/21/2019	EUT Type: Satellite Radio with FM Transmitter	Page 24 of 27	

Test Setup

The EUT and measurement equipment were set up as shown in the test setup photos provided.

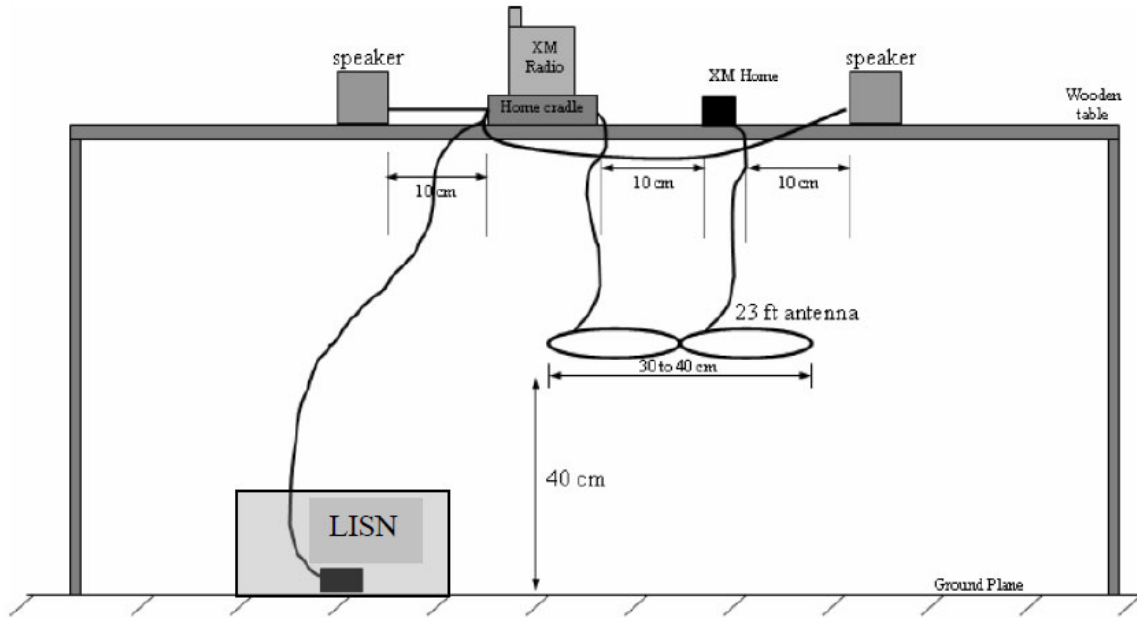
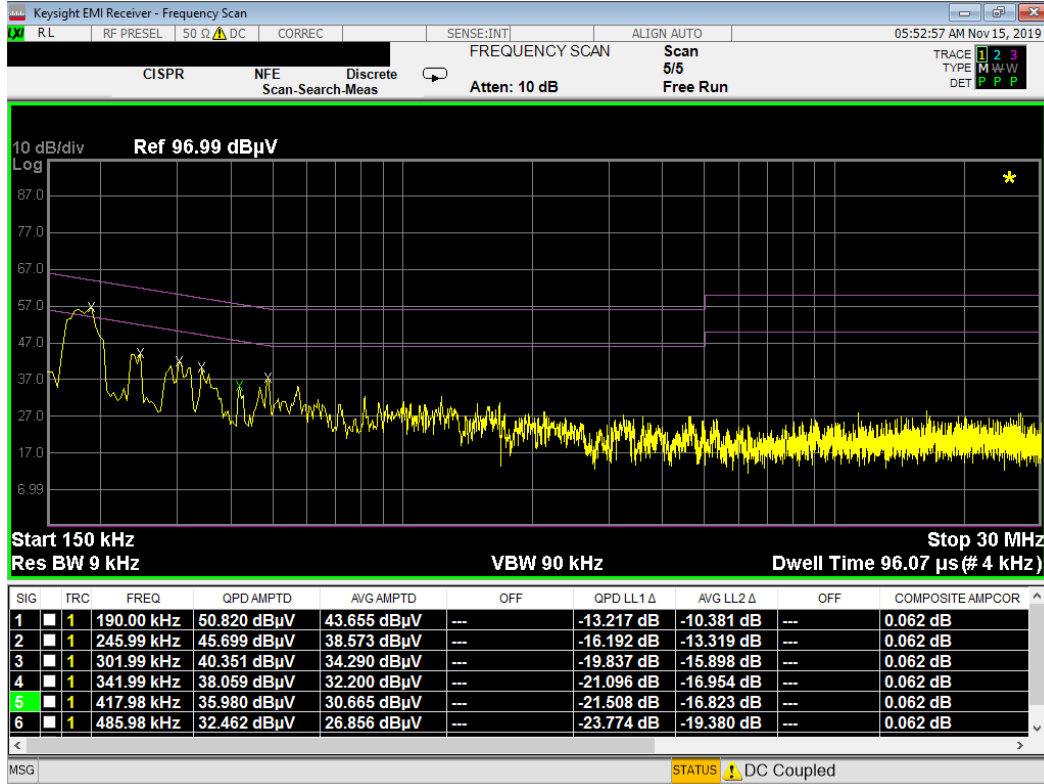

Figure 7-4. Test Instrument & Measurement Setup, Configuration #1

Test Notes

1. All Modes of operation were investigated and the worst-case emissions are reported.
2. The limit for Class B device(s) from 150kHz to 30MHz are specified in Section 15.107 and ICES-003.
3. L1 = Phase; N = Neutral
4. $Corr. (dB) = Cable\ loss (dB) + LISN\ insertion\ factor (dB)$
5. $QP/AV\ Level (dB\mu V) = QP/AV\ Reading (dB\mu V) + Factor (dB)$
6. $Margin (dB) = QP/AV\ Limit (dB\mu V) - QP/AV\ Level (dB\mu V)$
7. Traces shown in plot are made using a peak detector.
8. Deviations to the Specifications: None.

FCC ID: RS2SXWB1		MEASUREMENT REPORT (CERTIFICATION)		Approved by: Quality Manager
Test Report S/N: 1M1911040180-06.RS2	Test Dates: 11/04 - 11/21/2019	EUT Type: Satellite Radio with FM Transmitter	Page 25 of 27	



Plot 7-5. Line Conducted Plot (L1, Configuration #1)

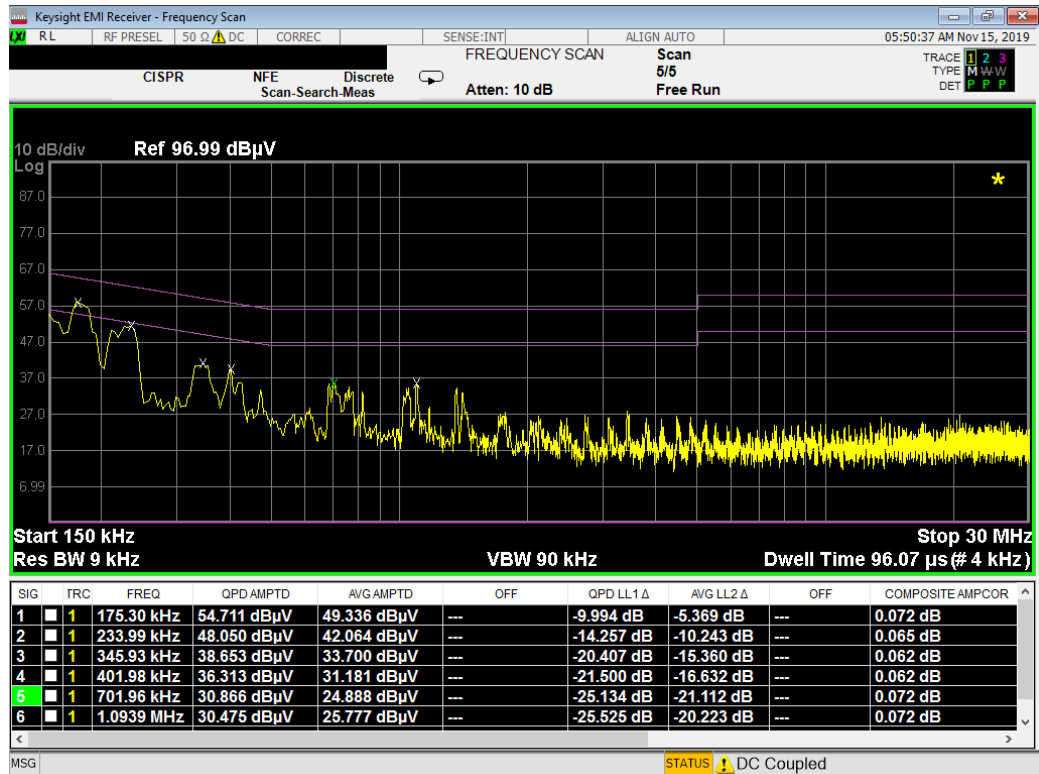

Plot 7-6. Line Conducted Plot (N, Configuration #1)

FCC ID: RS2SXWB1	PCTEST ENGINEERING LABORATORY, INC.	MEASUREMENT REPORT (CERTIFICATION)	SiriusXM SATELLITE RADIO	Approved by: Quality Manager
Test Report S/N: 1M1911040180-06.RS2	Test Dates: 11/04 - 11/21/2019	EUT Type: Satellite Radio with FM Transmitter		Page 26 of 27

8.0 CONCLUSION

The data collected relate only to the item(s) tested and show that the **Sirius XM Satellite Radio with FM Transmitter FCC ID: RS2SXWB1** has been tested to comply with the requirements specified in §15.107 and §15.109 of the FCC rules.

FCC ID: RS2SXWB1		MEASUREMENT REPORT (CERTIFICATION)		Approved by: Quality Manager
Test Report S/N: 1M1911040180-06.RS2	Test Dates: 11/04 - 11/21/2019	EUT Type: Satellite Radio with FM Transmitter		Page 27 of 27