

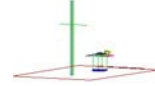

PCTEST ENGINEERING LABORATORY, INC.

7185 Oakland Mills Road, Columbia, MD 21046 USA
Tel. 410.290.6652 / Fax 410.290.6654
http://www.pctestlab.com



MEASUREMENT REPORT FCC Part 15B

Applicant Name:
Sirius XM Satellite Radio, Inc.
1500 Eckington Place, NE
Washington, DC 20002
United States

Date of Testing:
9/21 - 10/2/2015
Test Site/Location:
PCTEST Lab, Columbia, MD, USA
Test Report Serial No.:
0Y1509281849-R4.RS2

MODEL:	SXPL1 (Onyx PLUS (Gen 7.5))
APPLICANT:	Sirius XM Satellite Radio, Inc.

Application Type: Verification
EUT Type: Satellite Radio with FM Transmitter
Model(s): SXPL1 (Onyx PLUS (Gen 7.5))
FCC Rule Part(s): FCC Part 15 Subpart B, Part 2 (Verification)
FCC Classification: Part 15 Class B Digital Device
Test Procedure: ANSI C63.4-2009

This equipment has been shown to be capable of compliance with the applicable technical standards as indicated in the measurement report and has been tested in accordance with the measurement procedures specified in ANSI C63.4-2009 (See Test Report). The results shown herein are also deemed satisfactory evidence of compliance with Industry Canada Interference-Causing Equipment Standard ICES-003. These measurements were performed with no deviation from the standards. Test results reported herein relate only to the item(s) tested.

***This revised Test Report (S/N: 0Y1509281849-R4.RS2) supersedes and replaces the previously issued test report on the same subject EUT for the same type of testing as indicated. Please discard and destroy the previously issued test report (S/N: 0Y1509281849-R3.RS2) and dispose of it accordingly.**

I authorize and attest to the accuracy of data. All measurements reported herein were performed by me or were made under my supervision and are correct to the best of my knowledge and belief. I assume full responsibility for the completeness of these measurements and vouch for the qualifications of all persons taking them.

NVLAP accreditation does not constitute any product endorsement by NVLAP or any agency of the United States Government. This report must not be used by the customer to claim product certification, approval, or endorsement by NVLAP, NIST, or any agency of the Federal Government.

 Randy Ortanez
 President







MODEL: SXPL1 (Onyx PLUS (Gen 7.5))		FCC Pt. 15B MEASUREMENT REPORT (VERIFICATION)		Reviewed by: Quality Manager
Test Report S/N: 0Y1509281849-R4.RS2	Test Dates: 9/21 - 10/2/2015	EUT Type: Satellite Radio with FM Transmitter	Page 1 of 26	

TABLE OF CONTENTS

FCC Class B MEASUREMENT REPORT		3
1.0 INTRODUCTION		4
1.1 Scope		4
1.2 PCTEST Test Location		4
2.0 PRODUCT INFORMATION.....		5
2.1 Equipment Description.....		5
2.2 Test Configuration		5
2.3 EMI Suppression Device(s)/Modifications		5
3.0 DESCRIPTION OF TESTS		6
3.1 Evaluation Procedure		6
3.2 AC Line Conducted Emissions		6
3.3 Radiated Emissions		7
4.0 SAMPLE CALCULATIONS		8
4.1 Conducted Emission Measurement Sample Calculation		8
4.2 Radiated Emission Measurement Sample Calculation		8
5.0 TEST EQUIPMENT CALIBRATION DATA		9
6.0 ENVIRONMENTAL CONDITIONS		10
7.0 TEST DATA.....		11
7.1 Summary		11
7.2 Test Support Equipment.....		11
7.3 Radiated Measurement Data.....		12
7.4 Line Conducted Measurement Data		24
8.0 CONCLUSION.....		26

MODEL: SXPL1 (Onyx PLUS (Gen 7.5))		FCC Pt. 15B MEASUREMENT REPORT (VERIFICATION)		Reviewed by: Quality Manager
Test Report S/N: 0Y1509281849-R4.RS2	Test Dates: 9/21 - 10/2/2015	EUT Type: Satellite Radio with FM Transmitter		Page 2 of 26

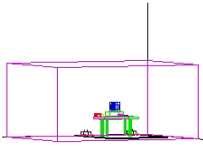

MEASUREMENT REPORT

FCC Part 15B – Unintentional Radiators

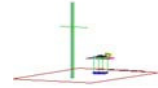

§ 2.1033 General Information

APPLICANT: Sirius XM Satellite Radio, Inc.

APPLICANT ADDRESS: 1500 Eckington Place, NE
Washington, DC 20002

TEST SITE: PCTEST ENGINEERING LABORATORY, INC.

TEST SITE ADDRESS: 7185 Oakland Mills Road, Columbia, MD 21046 USA

FCC RULE PART(S): FCC Part 15 Subpart B

MODEL: SXPL1 (Onyx PLUS (Gen 7.5))

Test Device Serial No.: UT230DH6 Production Pre-Production Engineering

FCC CLASSIFICATION: FCC Class B Scanning Receiver (CSR)

DATE(S) OF TEST: 9/21 - 10/2/2015



Test Methodology

Both conducted and radiated measurements were taken using the methods and procedures described in ANSI C63.4-2009. Radiated testing was performed at an antenna-to-EUT distance of 3 meters.

Test Facility / NVLAP Accreditation

Conducted and radiated tests were performed at PCTEST Engineering Lab in Columbia, MD 21046, U.S.A.

- PCTEST facility is an FCC registered (PCTEST Reg. No. 159966) test facility with the site description report on file and has met all the requirements specified in Section 2.948 of the FCC Rules and Industry Canada (2451B-1).
- PCTEST Lab is accredited by U.S. National Institute of Standards and Technology (NIST) under the National Voluntary Laboratory Accreditation Program (NVLAP) in EMC, Telecommunication, and FCC for satisfactory compliance with criteria established in Title 15, Part 285 Code of Federal Regulations. (NVLAP Lab code: 100431-0).
- PCTEST Lab is a recognized U.S. Conformity Assessment Body (CAB) in EMC and R&TTE (n.b. 0982) under the U.S.-EU Mutual Recognition Agreement (MRA).
- PCTEST TCB is a Telecommunication Certification Body (TCB) accredited to ISO/IEC Guide 65 by the American National Standards Institute (ANSI) in all scopes of FCC Rules and Industry Canada Standards (RSS).
- PCTEST facility is an IC registered (2451B-1) test laboratory with the site description on file at Industry Canada.

MODEL: SXPL1 (Onyx PLUS (Gen 7.5))		FCC Pt. 15B MEASUREMENT REPORT (VERIFICATION)		Reviewed by: Quality Manager
Test Report S/N: 0Y1509281849-R4.RS2	Test Dates: 9/21 - 10/2/2015	EUT Type: Satellite Radio with FM Transmitter	Page 3 of 26	

1.0 INTRODUCTION

1.1 Scope

Measurement and determination of electromagnetic emissions (EMC) of radio frequency devices including intentional and/or unintentional radiators for compliance with the technical rules and regulations of the Federal Communications Commission and the Industry Canada Certification and Engineering Bureau.

1.2 PCTEST Test Location

The map below shows the location of the PCTEST LABORATORY, its proximity to the FCC Laboratory, the Columbia vicinity, the Baltimore-Washington Intern'tl (BWI) airport, the city of Baltimore and the Washington, DC area. (See Figure 1-1).

These measurement tests were conducted at the PCTEST Engineering Laboratory, Inc. facility located at 7185 Oakland Mills Road, Columbia, MD 21046. The site coordinates are 39° 10'23" N latitude and 76° 49'50" W longitude. The facility is 0.4 miles North of the FCC laboratory, and the ambient signal and ambient signal strength are approximately equal to those of the FCC laboratory. The detailed description of the measurement facility was found to be in compliance with the requirements of § 2.948 according to ANSI C63.4-2014 on January 22, 2015.

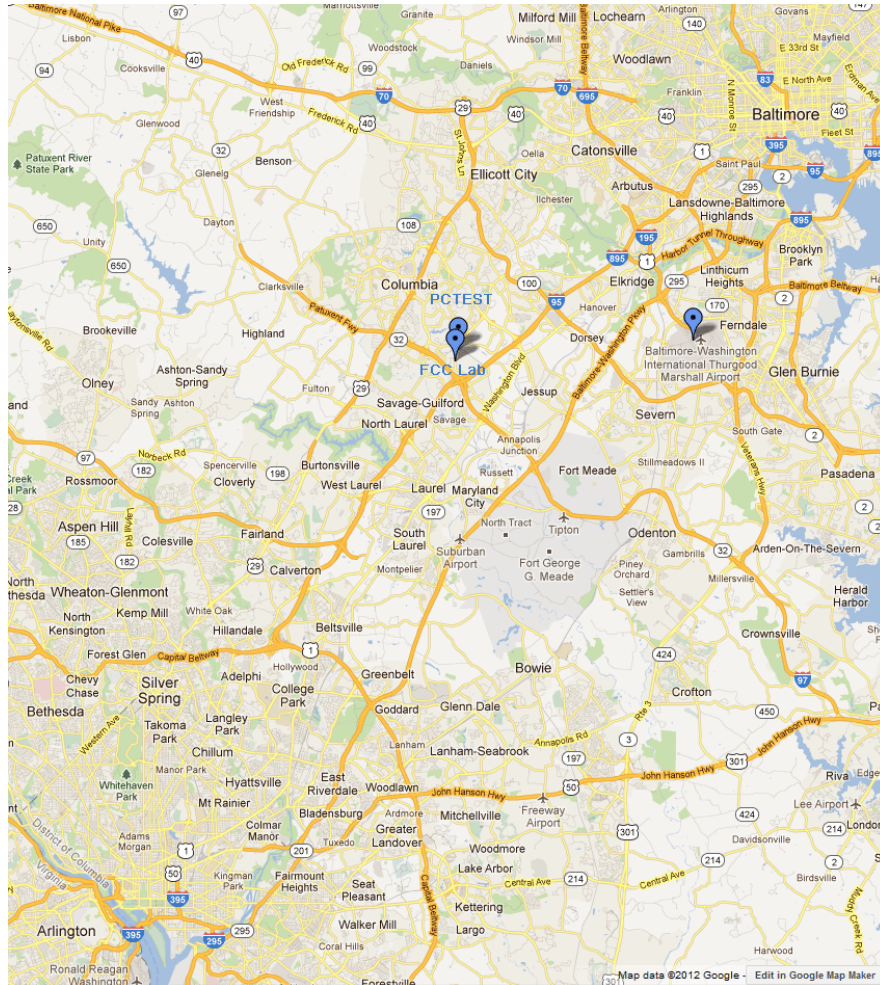

Figure 1-1. Map of the Greater Baltimore and Metropolitan Washington, D.C. area

MODEL: SXPL1 (Onyx PLUS (Gen 7.5))		FCC Pt. 15B MEASUREMENT REPORT (VERIFICATION)		Reviewed by: Quality Manager
Test Report S/N: 0Y1509281849-R4.RS2	Test Dates: 9/21 - 10/2/2015	EUT Type: Satellite Radio with FM Transmitter		Page 4 of 26

2.0 PRODUCT INFORMATION

2.1 Equipment Description

The Equipment Under Test (EUT) is the **Sirius XM Satellite Radio with FM Transmitter Model: SXPL1 (Onyx PLUS (Gen 7.5))**. The test data contained in this report pertains only to the emissions due to the digital circuitry of the EUT.

2.2 Test Configuration

The Sirius XM Satellite Radio with FM Transmitter Model: SXPL1 (Onyx PLUS (Gen 7.5)) was tested with four different configurations. All equipment is placed on the test table top and arranged in a typical configuration in accordance with ANSI C63.4-2009 and manipulated to obtain worst case emissions. Below is a brief list of each configuration set-up.



Test Configuration #	Emissions Tested	Description
1	Unintentional	Receiver (EUT) under test with Home Cradle (Conducted Emissions)
2	Unintentional	Receiver (EUT) under test with Home Cradle (Radiated Emissions)
3	Unintentional	Receiver (EUT) under test with <i>FM Direct</i> adapter
4	Unintentional	Receiver (EUT) under test with Cassette adapter

Table 2-1. Test Configuration Description

For more information please see Section 7.0 for test data and the test setup photos document for the test setup photographs.

2.3 EMI Suppression Device(s)/Modifications

No EMI suppression device(s) were added and no modifications were made during testing.

MODEL: SXPL1 (Onyx PLUS (Gen 7.5))		FCC Pt. 15B MEASUREMENT REPORT (VERIFICATION)		Reviewed by: Quality Manager
Test Report S/N: 0Y1509281849-R4.RS2	Test Dates: 9/21 - 10/2/2015	EUT Type: Satellite Radio with FM Transmitter	Page 5 of 26	

3.0 DESCRIPTION OF TESTS

3.1 Evaluation Procedure

The measurement procedure described in the American National Standard for Methods of Measurement of Radio-Noise Emission from Low-Voltage Electrical and Electronic Equipment in the Range of 9kHz to 40GHz (ANSI C63.4-2009) was used in the measurement of the **Sirius XM Satellite Radio with FM Transmitter Model: SXPL1 (Onyx PLUS (Gen 7.5))**.

Deviation from measurement procedure.....None



3.2 AC Line Conducted Emissions

The line-conducted facility is located inside a 10'x16'x9' shielded enclosure. The shielded enclosure is manufactured by ETS Lindgren RF Enclosures. The shielding effectiveness of the shielded room is in accordance with MIL-Std-285 or NSA 65-5. A 1m x 1.5m wooden table 80cm high is placed 40cm away from the vertical wall and 80cm away from the sidewall of the shielded room. Two 10kHz-30MHz, 50Ω/50μH Line-Impedance Stabilization Networks (LISNs) are bonded to the shielded room floor. Power to the LISNs is filtered by external high-current high-insertion loss power line filters. The external power line filter is an ETS Lindgren Model LPRX-4X30 (100dB Attenuation, 14kHz-18GHz) and the two EMI/RFI filters are ETS Lindgren Model LRW-2030-S1 (100dB Minimum Insertion Loss, 14kHz – 10GHz). These filters attenuate ambient signal noise from entering the measurement lines. These filters are also bonded to the shielded enclosure.

The EUT is powered from one LISN and the support equipment is powered from the second LISN. If the EUT is a DC-powered device, power will be derived from the source power supply it normally will be powered from and this supply line(s) will be connected to the second LISN. All interconnecting cables more than 1 meter were shortened to a 1 meter length by non-inductive bundling (serpentine fashion) and draped over the back edge of the test table. All cables were at least 40cm above the horizontal reference groundplane. Power cables for support equipment were routed down to the second LISN while ensuring that that cables were not draped over the second LISN.

Sufficient time for the EUT, support equipment, and test equipment was allowed in order for them to warm up to their normal operating condition. The RF output of the LISN was connected to the spectrum analyzer and exploratory measurements were made to determine the frequencies producing the maximum emission from the EUT. The spectrum was scanned from 150kHz to 30MHz with a spectrum analyzer. The detector function was set to peak mode for exploratory measurements while the bandwidth of the analyzer was set to 10kHz. The EUT, support equipment, and interconnecting cables were arranged and manipulated to maximize each emission. Each emission was also maximized by varying: power lines, the mode of operation or resolution, clock or data exchange speed, scrolling H pattern to the EUT and/or support equipment whichever determined the worst-case emission. Once the worst case emissions have been identified, the one EUT cable configuration/arrangement and mode of operation that produced these emissions is used for final measurements on the same test site. The analyzer is set to CISPR quasi-peak and average detectors with a 9kHz resolution bandwidth for final measurements.

Line conducted emissions test results are shown in Section 7.4. Automated test software was used to perform the AC line conducted emissions testing. Automated measurement software utilized is Rohde & Schwarz EMC32, Version 8.51.0.



MODEL: SXPL1 (Onyx PLUS (Gen 7.5))		FCC Pt. 15B MEASUREMENT REPORT (VERIFICATION)		Reviewed by: Quality Manager
Test Report S/N: 0Y1509281849-R4.RS2	Test Dates: 9/21 - 10/2/2015	EUT Type: Satellite Radio with FM Transmitter	Page 6 of 26	

3.3 Radiated Emissions

The radiated test facilities consisted of an indoor 3 meter semi-anechoic chamber used for final measurements and exploratory measurements, when necessary. The measurement area is contained within the semi-anechoic chamber which is shielded from any ambient interference. The test site inside the chamber is a 6m x 5.2m elliptical, obstruction-free area in accordance with Clause 5, Figure 5.7 of ANSI C63.4-2009. For measurements above 1GHz absorbers are arranged on the floor between the turn table and the antenna mast in such a way so as to maximize the reduction of reflections. For measurements below 1GHz, the absorbers are removed. An ETS Lindgren Model 2188 raised turntable is used for radiated measurement. It is a continuously rotatable, remote-controlled, metallic turntable and 2 meters (6.56 ft.) in diameter. The turn table is flush with the raised floor of the chamber in order to maintain its function as a ground plane. A 78cm high PVC support structure is placed on top of the turntable. A 72.4cm high PVC support structure is placed on top of the turntable. A 3" (~7.6cm) sheet of high density polystyrene is used as the table top and is placed on top of the PVC supports to bring the total height of the table to 80cm.

For all measurements, the spectrum was scanned through all EUT azimuths and from 1 to 4 meter receive antenna height using a broadband antenna from 30MHz up to the upper frequency shown in 15.33(b)(1) depending on the highest frequency generated or used in the device or on which the device operates or tunes. For frequencies above 1GHz, linearly polarized double ridge horn antennas were used. For frequencies below 30MHz, a calibrated loop antenna was used. When exploratory measurements were necessary, they were performed at 1 meter test distance inside the semi-anechoic chamber using broadband antennas, broadband amplifiers, and spectrum analyzers to determine the frequencies and modes producing the maximum emissions. Sufficient time for the EUT, support equipment, and test equipment was allowed in order for them to warm up to their normal operating condition. The test set-up was placed on top of the 0.8 meter high, 1 x 1.5 meter table. The EUT, support equipment, and interconnecting cables were arranged and manipulated to maximize each emission. Appropriate precaution was taken to ensure that all emissions from the EUT were maximized and investigated. The system configuration, clock speed, mode of operation or video resolution, if applicable, turntable azimuth, and receive antenna height was noted for each frequency found.

Final measurements were made in the semi-anechoic chamber using calibrated, linearly polarized broadband and horn antennas. The test setup was configured to the setup that produced the worst case emissions. The spectrum analyzer was set to investigate all frequencies required for testing to compare the highest radiated disturbances with respect to the specified limits. The turntable containing the EUT was rotated through 360 degrees and the height of the receive antenna was varied 1 to 4 meters and stopped at the azimuth and height producing the maximum emission. Each emission was maximized by varying: the mode of operation or resolution, clock or data rate, scrolling H pattern to the EUT and/or support equipment, and changing the polarity of the receive antenna, whichever produced the worst-case emissions. To record the final measurements, the analyzer detector function was set to CISPR quasi-peak mode and the bandwidth of the spectrum analyzer was set to 120kHz for frequencies below 1GHz or 1MHz for frequencies above 1GHz. For average measurements above 1GHz, the analyzer was set to RMS detector with RBW = 1MHz and VBW = 3MHz.

MODEL: SXPL1 (Onyx PLUS (Gen 7.5))		FCC Pt. 15B MEASUREMENT REPORT (VERIFICATION)		Reviewed by: Quality Manager
Test Report S/N: 0Y1509281849-R4.RS2	Test Dates: 9/21 - 10/2/2015	EUT Type: Satellite Radio with FM Transmitter	Page 7 of 26	

4.0 SAMPLE CALCULATIONS

4.1 Conducted Emission Measurement Sample Calculation

@ 20.3 MHz

Class B limit	= 60.0 dB μ V (Quasi-peak limit)
Reading	= - 57.8 dBm (calibrated quasi-peak level)
Convert to dB μ V	= - 57.8 + 107 = 49.2 dB μ V
Margin	= 49.2 - 60.0 = - 10.8 dB
	= 10.8 dB below limit

4.2 Radiated Emission Measurement Sample Calculation



@ 66.7 MHz

Class B limit	= 100 μ V/m = 40.0 dB μ V/m
Reading	= - 76.0 dBm (calibrated level)
Convert to dB μ V	= - 76.0 + 107 = 31.0 dB μ V
Antenna Factor + Cable Loss	= 5.8 dB/m
Total	= 36.8 dB μ V/m
Margin	= 36.8 - 40.0 = - 3.2 dB
	= 3.2 dB below limit

Note:

$$\text{Level [dB}\mu\text{V]} = 20 \log_{10} (\text{Level } [\mu\text{V/m}])$$

$$\text{Level [dB}\mu\text{V]} = \text{Level [dBm]} + 107$$



MODEL: SXPL1 (Onyx PLUS (Gen 7.5))		FCC Pt. 15B MEASUREMENT REPORT (VERIFICATION)		Reviewed by: Quality Manager
Test Report S/N: 0Y1509281849-R4.RS2	Test Dates: 9/21 - 10/2/2015	EUT Type: Satellite Radio with FM Transmitter	Page 8 of 26	

5.0 TEST EQUIPMENT CALIBRATION DATA

Test Equipment Calibration is traceable to the National Institute of Standards and Technology (NIST).

Manufacturer	Model	Description	Cal Date	Cal Interval	Cal Due	Serial Number
-	RE1	Radiated Emissions Cable Set (UHF/EHF)	4/28/2015	Annual	4/28/2016	N/A
Agilent	8447D	Broadband Amplifier	6/12/2015	Annual	6/12/2016	2443A01900
Agilent	N9038A	MXE EMI Receiver	3/24/2015	Annual	3/24/2016	MY51210133
Emco	3115	Horn Antenna (1-18GHz)	1/30/2014	Biennial	1/30/2016	9704-5182
ETS-Lindgren	3816/2NM	Line Impedance Stabilization Network	11/11/2014	Biennial	11/11/2016	114451
Pasternack	NMLC-1	Line Conducted Emissions Cable (NM)	4/28/2015	Annual	4/28/2016	N/A
Rohde & Schwarz	ESU26	EMI Test Receiver (26.5GHz)	3/12/2015	Annual	3/12/2016	100342
Rohde & Schwarz	TS-PR18	1-18 GHz Pre-Amplifier	3/5/2015	Annual	3/5/2016	100071
Seekonk	NC-100	Torque Wrench 5/16", 8" lbs	3/18/2014	Biennial	3/18/2016	N/A
Sunol	JB5	Bi-Log Antenna (30M - 5GHz)	1/28/2014	Biennial	1/28/2016	A051107

Table 5-1. Annual Test Equipment Calibration Schedule



MODEL: SXPL1 (Onyx PLUS (Gen 7.5))		FCC Pt. 15B MEASUREMENT REPORT (VERIFICATION)		Reviewed by: Quality Manager
Test Report S/N: 0Y1509281849-R4.RS2	Test Dates: 9/21 - 10/2/2015	EUT Type: Satellite Radio with FM Transmitter	Page 9 of 26	

6.0 ENVIRONMENTAL CONDITIONS

The temperature is controlled within range of 15°C to 35°C.

The relative humidity is controlled within range of 10% to 75%.

The atmospheric pressure is monitored within the range 86-106kPa (860-1060mbar).

MODEL: SXPL1 (Onyx PLUS (Gen 7.5))		FCC Pt. 15B MEASUREMENT REPORT (VERIFICATION)		Reviewed by: Quality Manager
Test Report S/N: 0Y1509281849-R4.RS2	Test Dates: 9/21 - 10/2/2015	EUT Type: Satellite Radio with FM Transmitter	Page 10 of 26	

7.0 TEST DATA

7.1 Summary

Test Date(s): 9/21 - 10/2/2015

Test Engineer: *Alvin Chung*

FCC Part 15 Section	Description	Result
15.107	Conducted Emissions	PASS
15.109	Radiated Emissions	PASS



Table 7-1. Summary of Test Results

7.2 Test Support Equipment

Manufacturer	Model	Description
Sirius XM	XDPID2	PowerConnect Dock
Sirius XM	SXHD1(A)	Home Cradle
Sirius XM	NGVA1	XM Vehicle Antenna
Sirius XM	NGHA1	XM Home Antenna
Sirius XM	SXDPIP1	5V iFMCLA Power Adapter
Sirius XM	PSAC05A-050	Home Power Adapter
Sirius XM	N/A	Cassette Adapter
Sirius XM	FMDA25	FM Direct Adapter
Exide	Classic Part#: 25C	12V Car Battery
Sirius XM	N/A	Cigarette Lighter Socket with Twisted Pair Cable
JFW Industries	50BT-038	Bias-T

Table 7-2. Test Support Equipment Used

Note: See test setup photographs for actual system test setup.

MODEL: SXPL1 (Onyx PLUS (Gen 7.5))		FCC Pt. 15B MEASUREMENT REPORT (VERIFICATION)		Reviewed by: Quality Manager
Test Report S/N: 0Y1509281849-R4.RS2	Test Dates: 9/21 - 10/2/2015	EUT Type: Satellite Radio with FM Transmitter	Page 11 of 26	

7.3 Radiated Measurement Data

§15.109

Test Overview and Limit

All radiated spurious emissions are measured with a spectrum analyzer connected to a receive Antenna. Only the radiated emissions of the configuration that produced the worst case emissions are reported in this section.

All radiated emissions from unintentional radiators shall not exceed the limits shown in Table 7-3 per Section 15.109.

Frequency	Field Strength [μV/m]	Measured Distance [Meters]
30 – 88 MHz	100	3
88 – 216 MHz	150	3
216 – 960 MHz	200	3
Above 960MHz	500	3

Table 7-3. Radiated Limits

Test Setup

The EUT and measurement equipment were set up as shown in the diagram below.

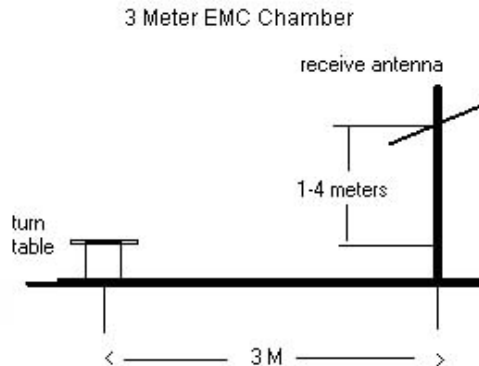



Figure 7-1. Test Instrument & Measurement Setup

MODEL: SXPL1 (Onyx PLUS (Gen 7.5))		FCC Pt. 15B MEASUREMENT REPORT (VERIFICATION)		Reviewed by: Quality Manager
Test Report S/N: 0Y1509281849-R4.RS2	Test Dates: 9/21 - 10/2/2015	EUT Type: Satellite Radio with FM Transmitter	Page 12 of 26	

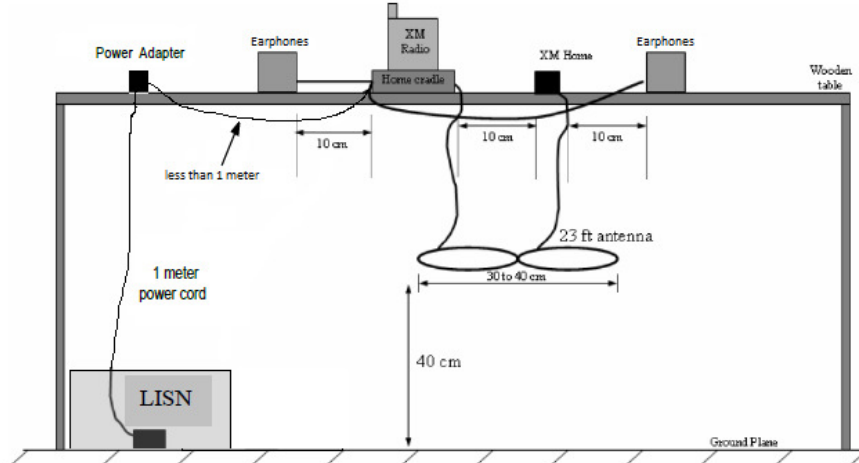

Figure 7-2. Test Instrument & Measurement Setup (Configuration #1)

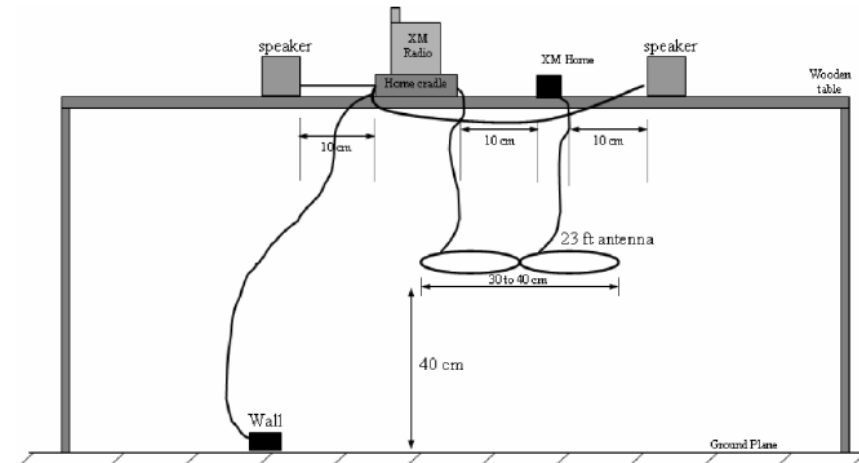

Figure 7-3. Test Instrument & Measurement Setup (Configuration #2)

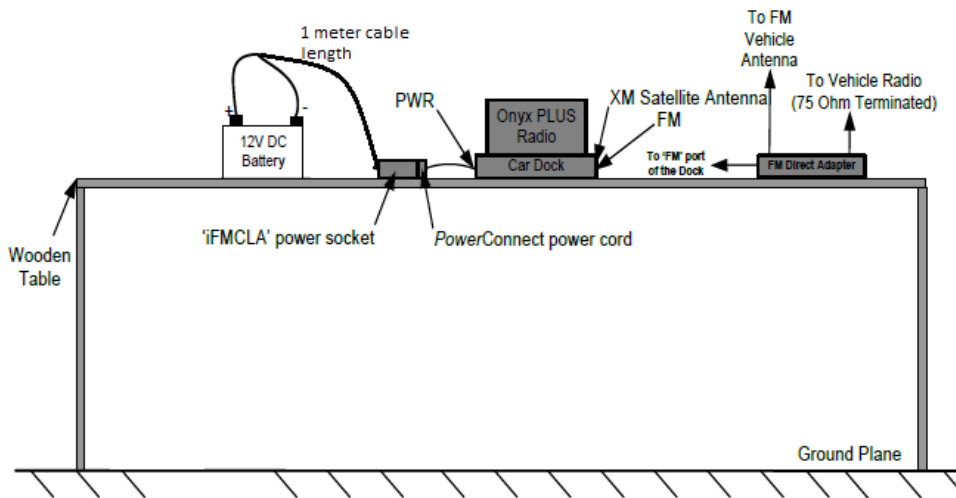



Figure 7-4. Test Instrument & Measurement Setup (Configuration #3)

MODEL: SXPL1 (Onyx PLUS (Gen 7.5))		FCC Pt. 15B MEASUREMENT REPORT (VERIFICATION)		Reviewed by: Quality Manager
Test Report S/N: 0Y1509281849-R4.RS2	Test Dates: 9/21 - 10/2/2015	EUT Type: Satellite Radio with FM Transmitter		Page 13 of 26

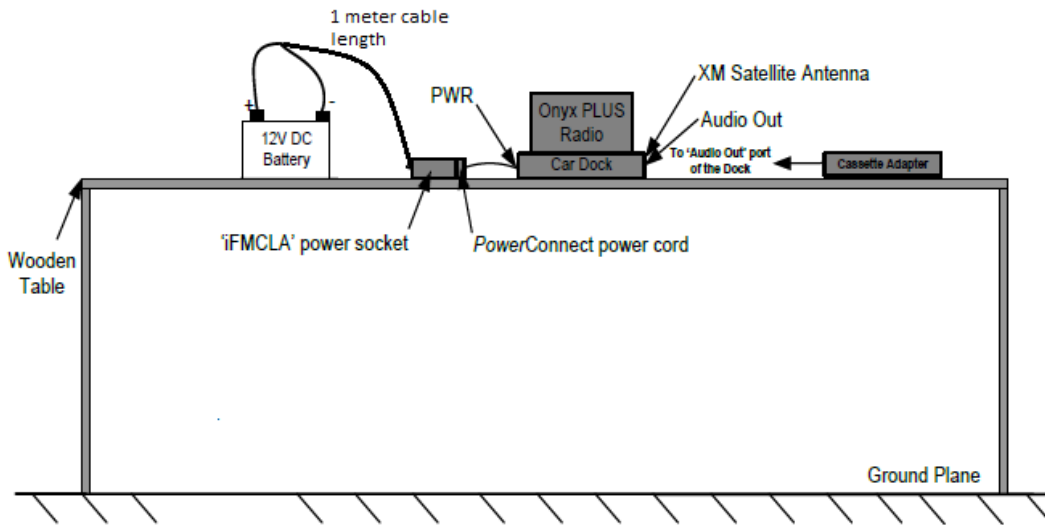



Figure 7-5. Test Instrument & Measurement Setup (Configuration #4)

Notes:

1. All modes of operation were investigated and the worst-case emissions are reported.
2. Radiated emissions were measured from 30MHz – 18GHz to ensure that the provisions of 15.33(b)(1) are satisfied with respect to the upper frequency scanning range.
3. The radiated limits for unintentional radiators at a distance of 3 meters are used in the tables in the section, as specified in 15.109(a).
4. All readings are calibrated by a signal generator with accuracy traceable to the National Institute of Standards and Technology (NIST).
5. $AFCL (dB/m) = Antenna\ Factor (dB/m) + Cable\ Loss (dB)$
6. $Level (dB\mu V/m) = Analyzer\ Reading (dBm) + AFCL (dB/m) + 107$
7. $Margin (dB) = Field\ strength (dB\mu V/m) - Limit (dB\mu V/m)$
8. Measurements are made using a peak detector with a 100kHz resolution bandwidth. Above 1GHz, peak measurements are made using a peak detector with a resolution bandwidth of 1MHz and a video bandwidth of 3MHz and average measurements are made with a RMS detector using a resolution bandwidth of 1MHz and a video bandwidth of 3MHz.
9. Calibrated linearly polarized broadband and horn antennas were used for measurements below and above 1GHz, respectively. For measurements made below 1GHz, the results recorded using the broadband antenna are known to correlate with the results obtained by using a tuned dipole with an acceptable degree of accuracy. The VSWR for the measurement antennas was found to be less than 2:1.
10. Calibrated low-loss microwaves cables and broadband amplifiers are used.

MODEL: SXPL1 (Onyx PLUS (Gen 7.5))		FCC Pt. 15B MEASUREMENT REPORT (VERIFICATION)		Reviewed by: Quality Manager
Test Report S/N: 0Y1509281849-R4.RS2	Test Dates: 9/21 - 10/2/2015	EUT Type: Satellite Radio with FM Transmitter		Page 14 of 26

7.3.1 Radiated Measurement Data – Configuration #2

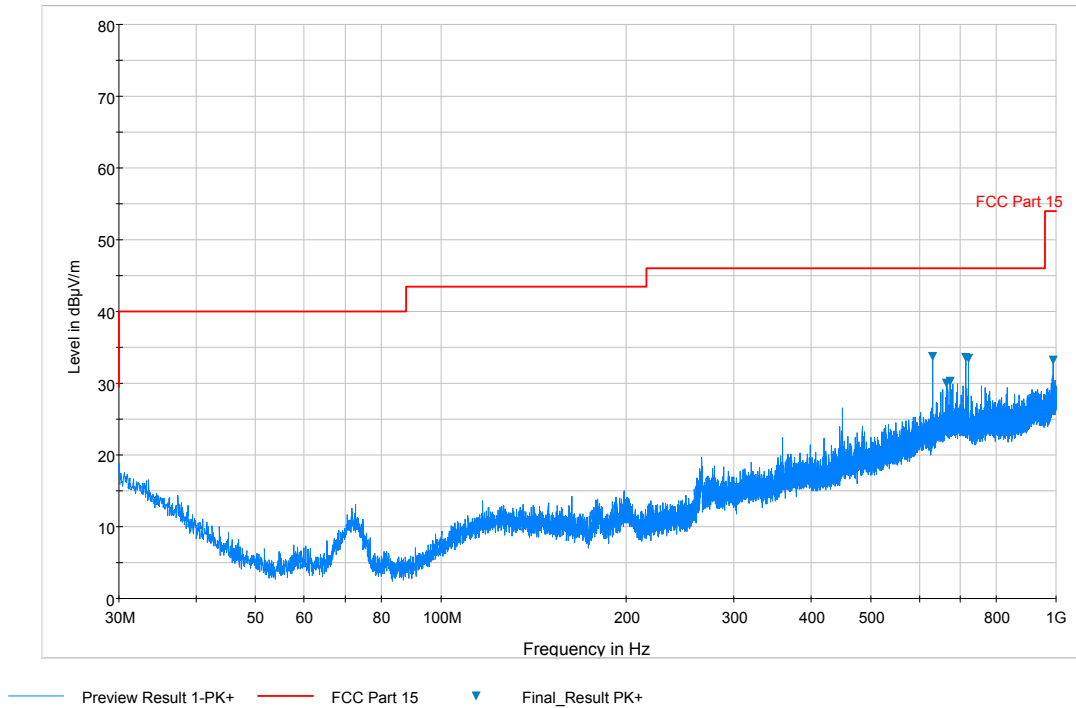

7-1. Radiated Spurious Plot below 1GHz (Configuration #2, Pol. H)

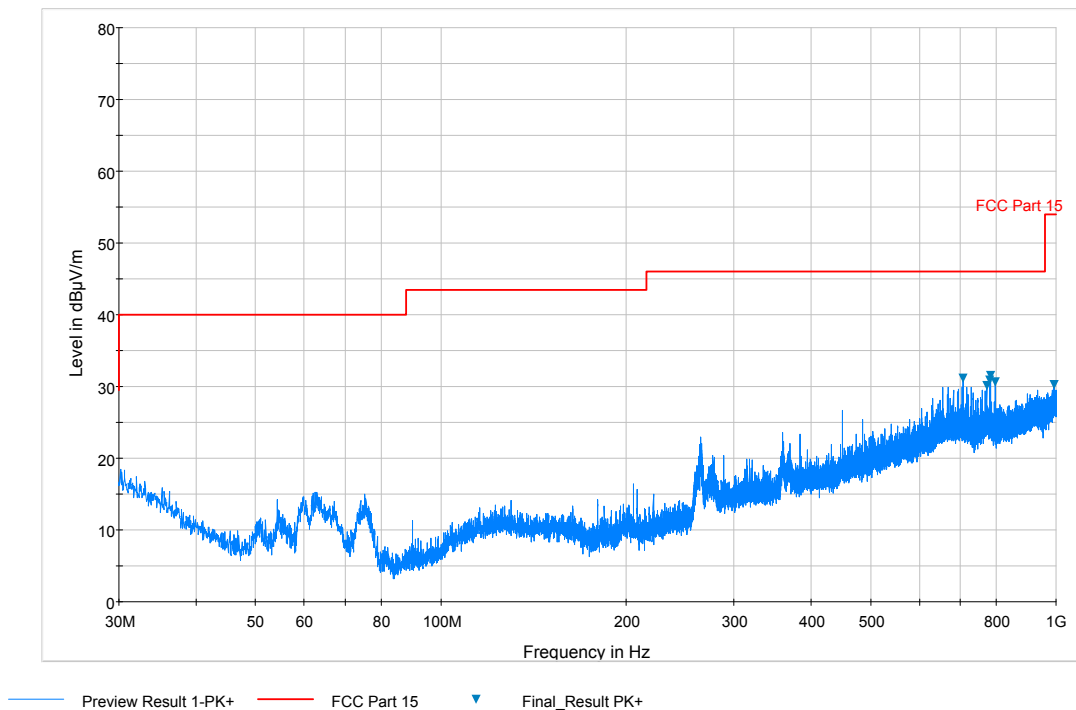

7-2. Radiated Spurious Plot below 1GHz (Configuration #2, Pol. V)

MODEL: SXPL1 (Onyx PLUS (Gen 7.5))		FCC Pt. 15B MEASUREMENT REPORT (VERIFICATION)		Reviewed by: Quality Manager
Test Report S/N: 0Y1509281849-R4.RS2	Test Dates: 9/21 - 10/2/2015	EUT Type: Satellite Radio with FM Transmitter		Page 15 of 26

Frequency [MHz]	Detector	Ant. Pol. [H/V]	Analyzer Level [dBm]	AFCL [dB/m]	Field Strength [dBμV/m]	Limit [dBμV/m]	Margin [dB]
54.87	Peak	V	-82.74	8.49	32.75	40.00	-7.25
73.52	Peak	H	-94.22	8.87	21.65	40.00	-18.35
179.23	Peak	H	-94.53	12.16	24.63	43.52	-18.89
277.16	Peak	H	-97.48	15.03	24.56	46.02	-21.46
777.71	Peak	V	-100.82	23.71	29.90	46.02	-16.12
841.44	Peak	V	-103.73	24.49	27.76	46.02	-18.27

Table 7-4. Radiated Spurious Emissions below 1GHz (Configuration #2)

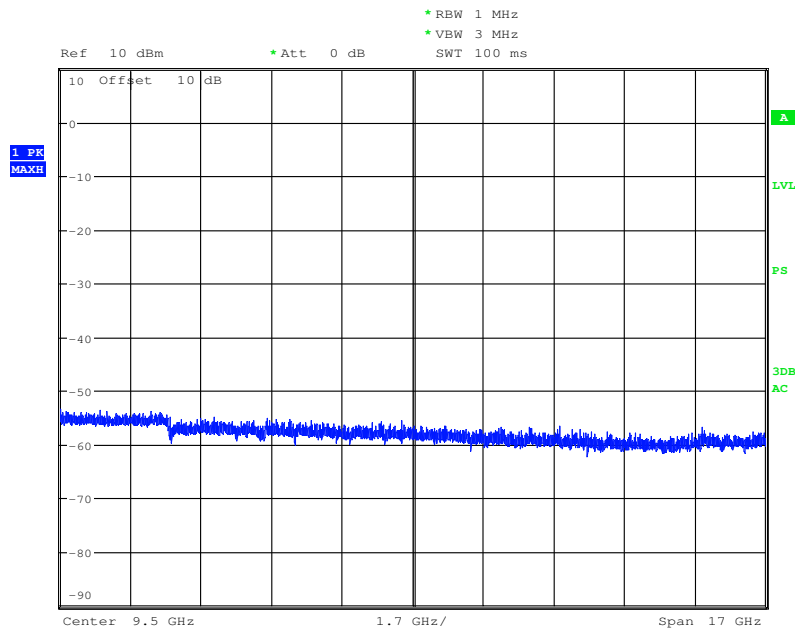

Date: 22.SEP.2015 15:22:41

7-3. Radiated Spurious Plot above 1GHz (Configuration #2, Pol. H)

MODEL: SXPL1 (Onyx PLUS (Gen 7.5))		FCC Pt. 15B MEASUREMENT REPORT (VERIFICATION)		Reviewed by: Quality Manager
Test Report S/N: 0Y1509281849-R4.RS2	Test Dates: 9/21 - 10/2/2015	EUT Type: Satellite Radio with FM Transmitter		Page 16 of 26

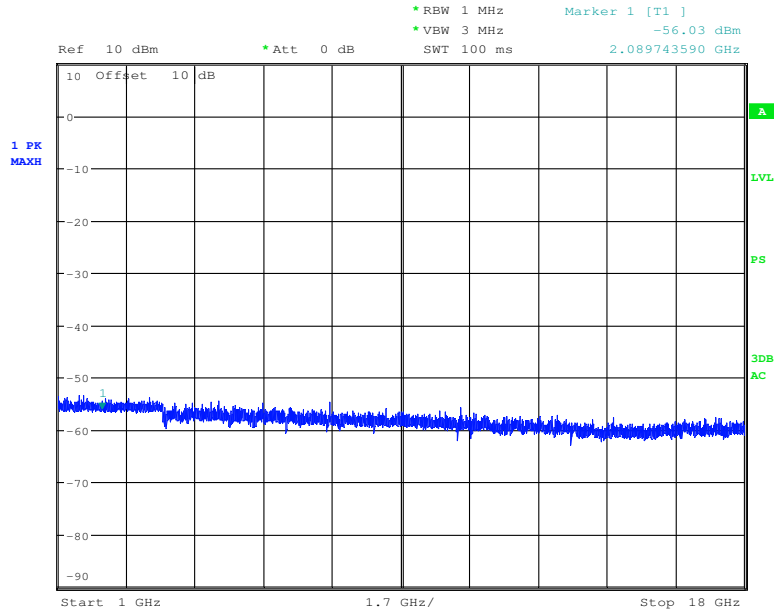

Date: 22.SEP.2015 14:48:20

7-4. Radiated Spurious Plot above 1GHz (Configuration #2, Pol. V)

Frequency [MHz]	Detector	Ant. Pol. [H/V]	Analyzer Level [dBm]	AFCL [dB/m]	Field Strength [dBμV/m]	Limit [dBμV/m]	Margin [dB]
1632.00	Avg	V	-108.64	28.50	26.85	53.98	-27.13
1632.00	Peak	V	-97.50	28.50	37.99	73.98	-35.99
4983.00	Avg	V	-110.28	38.36	35.07	53.98	-18.90
4983.00	Peak	V	-97.77	38.36	47.58	73.98	-26.40
7735.00	Avg	V	-110.79	43.32	39.53	53.98	-14.45
7735.00	Peak	V	-98.18	43.32	52.14	73.98	-21.84
10949.00	Avg	V	-110.74	46.07	42.33	53.98	-11.64
10949.00	Peak	V	-98.27	46.07	54.80	73.98	-19.18
12747.00	Avg	V	-110.75	47.52	43.77	53.98	-10.21
12747.00	Peak	V	-97.71	47.52	56.81	73.98	-17.17
16125.00	Avg	V	-111.17	47.92	43.75	53.98	-10.23
16125.00	Peak	V	-97.99	47.92	56.93	73.98	-17.05

Table 7-5. Radiated Spurious Emissions above 1GHz (Configuration #2)

MODEL: SXPL1 (Onyx PLUS (Gen 7.5))		FCC Pt. 15B MEASUREMENT REPORT (VERIFICATION)		Reviewed by: Quality Manager
Test Report S/N: 0Y1509281849-R4.RS2	Test Dates: 9/21 - 10/2/2015	EUT Type: Satellite Radio with FM Transmitter		Page 17 of 26

7.3.2 Radiated Measurement Data – Configuration #3

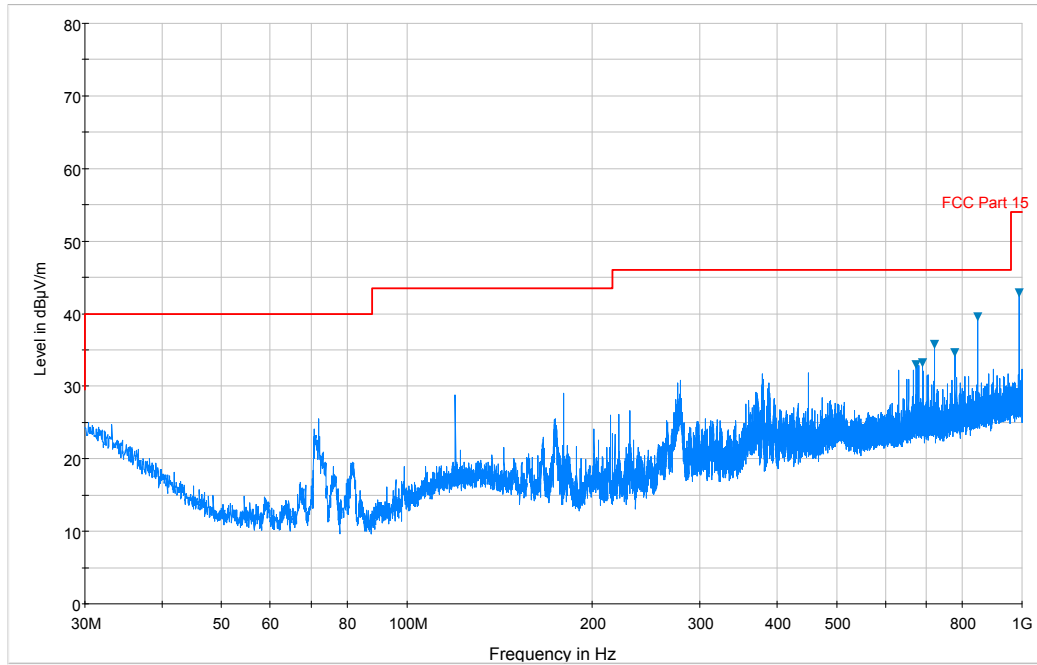

— Preview Result 1-PK+ — FCC Part 15 ▼ Final_Result PK+

7-5. Radiated Spurious Plot below 1GHz (Configuration #3, Pol. H)

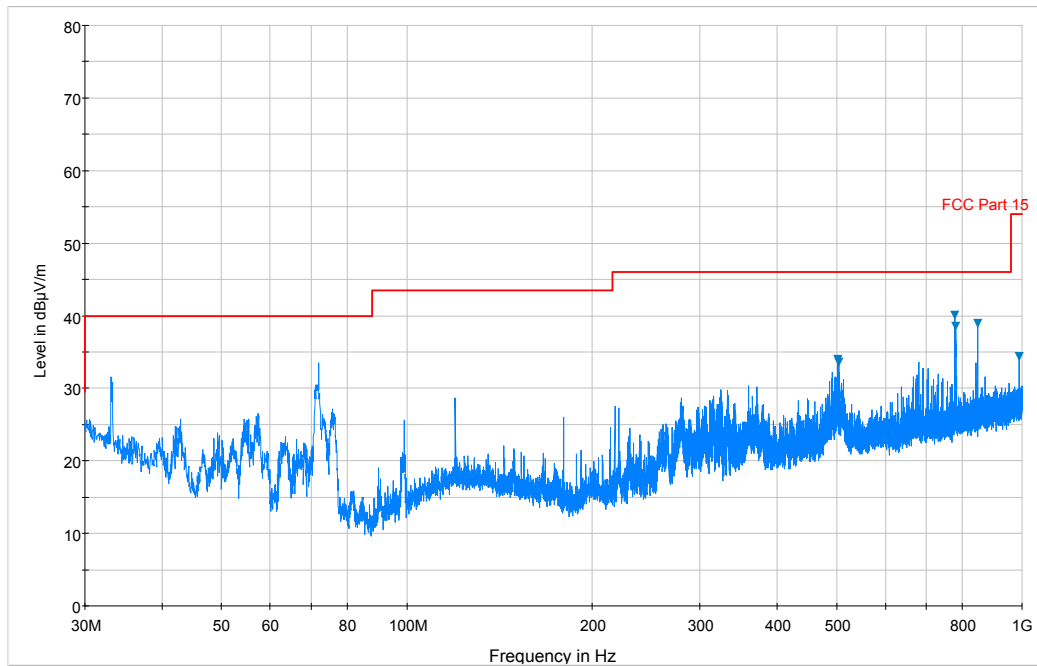

— Preview Result 1-PK+ — FCC Part 15 ▼ Final_Result PK+

7-6. Radiated Spurious Plot below 1GHz (Configuration #3, Pol. V)

MODEL: SXPL1 (Onyx PLUS (Gen 7.5))		FCC Pt. 15B MEASUREMENT REPORT (VERIFICATION)		Reviewed by: Quality Manager
Test Report S/N: 0Y1509281849-R4.RS2	Test Dates: 9/21 - 10/2/2015	EUT Type: Satellite Radio with FM Transmitter		Page 18 of 26

Frequency [MHz]	Detector	Ant. Pol. [H/V]	Analyzer Level [dBm]	AFCL [dB/m]	Field Strength [dBμV/m]	Limit [dBμV/m]	Margin [dB]
71.95	Peak	V	-87.17	8.56	28.39	40.00	-11.61
119.96	Peak	H	-97.78	14.53	23.74	43.52	-19.78
502.77	Peak	V	-100.75	19.38	25.64	46.02	-20.39
688.87	Peak	H	-101.07	22.44	28.38	46.02	-17.64
848.82	Peak	H	-106.58	24.57	24.99	46.02	-21.03
990.05	Peak	H	-95.22	25.77	37.55	53.98	-16.43

Table 7-6. Radiated Spurious Emissions below 1GHz (Configuration #3)

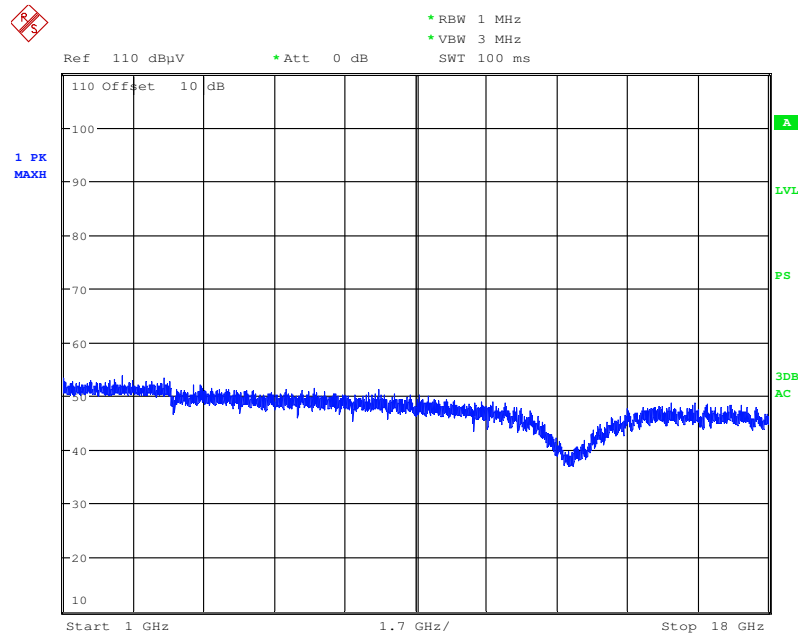

Date: 23.SEP.2015 14:07:04

7-7. Radiated Spurious Plot above 1GHz (Configuration #3, Pol. H)

MODEL: SXPL1 (Onyx PLUS (Gen 7.5))		FCC Pt. 15B MEASUREMENT REPORT (VERIFICATION)		Reviewed by: Quality Manager
Test Report S/N: 0Y1509281849-R4.RS2	Test Dates: 9/21 - 10/2/2015	EUT Type: Satellite Radio with FM Transmitter		Page 19 of 26

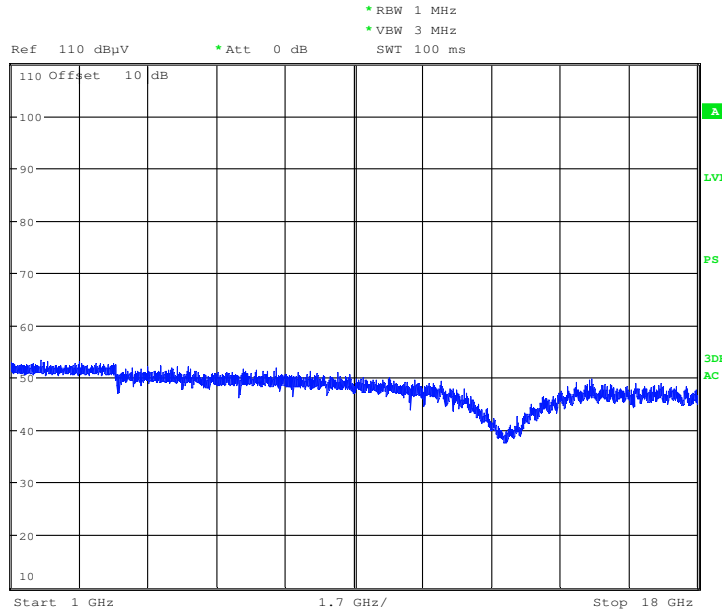

Date: 23.SEP.2015 14:15:53

7-8. Radiated Spurious Plot above 1GHz (Configuration #3, Pol. V)

Frequency [MHz]	Detector	Ant. Pol. [H/V]	Analyzer Level [dBm]	AFCL [dB/m]	Field Strength [dBμV/m]	Limit [dBμV/m]	Margin [dB]
1737.00	Avg	V	-109.57	29.24	26.67	53.98	-27.31
1737.00	Peak	V	-91.05	29.24	45.19	73.98	-28.79
5415.00	Avg	V	-110.96	39.72	35.75	53.98	-18.23
5415.00	Peak	V	-98.09	39.72	48.62	73.98	-25.36
7540.00	Avg	V	-111.17	43.28	39.11	53.98	-14.87
7540.00	Peak	V	-98.07	43.28	52.21	73.98	-21.77
9093.00	Avg	V	-111.29	45.28	40.99	53.98	-12.99
9093.00	Peak	V	-98.67	45.28	53.61	73.98	-20.37
11654.00	Avg	V	-111.90	47.36	42.47	53.98	-11.51
11654.00	Peak	V	-99.41	47.36	54.96	73.98	-19.02
15386.00	Avg	V	-112.00	48.44	43.44	53.98	-10.54
15386.00	Peak	V	-98.67	48.44	56.77	73.98	-17.21

Table 7-7. Radiated Spurious Emissions above 1GHz (Configuration #3)

MODEL: SXPL1 (Onyx PLUS (Gen 7.5))	PCTEST ENGINEERING LABORATORY, INC.	FCC Pt. 15B MEASUREMENT REPORT (VERIFICATION)	SIRIUSXM SATELLITE RADIO	Reviewed by: Quality Manager
Test Report S/N: 0Y1509281849-R4.RS2	Test Dates: 9/21 - 10/2/2015	EUT Type: Satellite Radio with FM Transmitter		Page 20 of 26

7.3.3 Radiated Measurement Data – Configuration #4

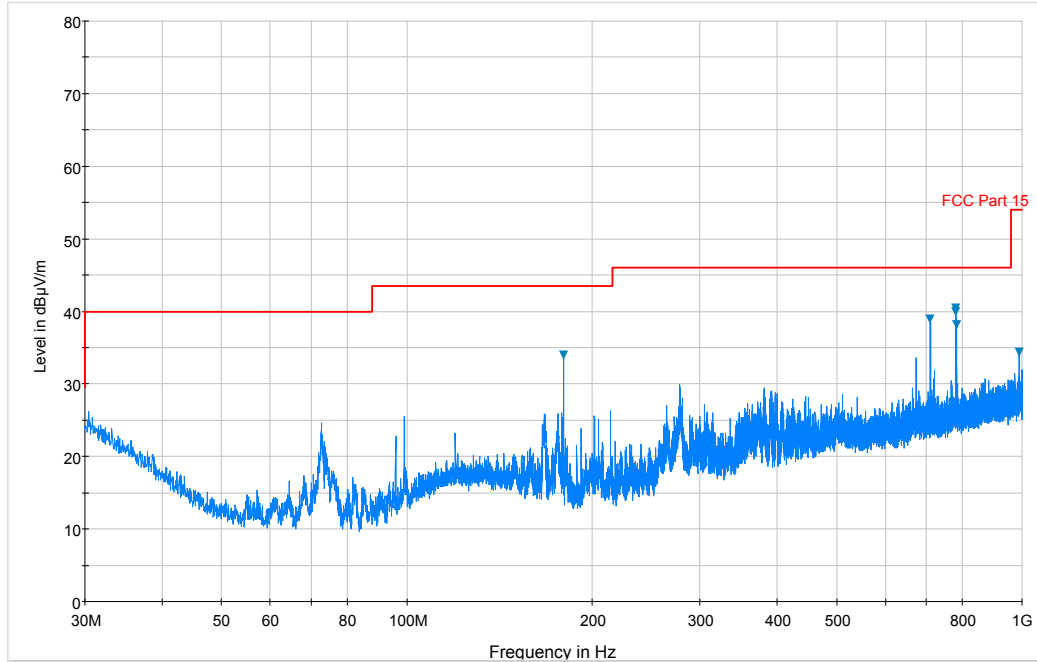

— Preview Result 1-PK+ — FCC Part 15 ▼ Final_Result PK+

7-9. Radiated Spurious Plot below 1GHz (Configuration #4, Pol. H)

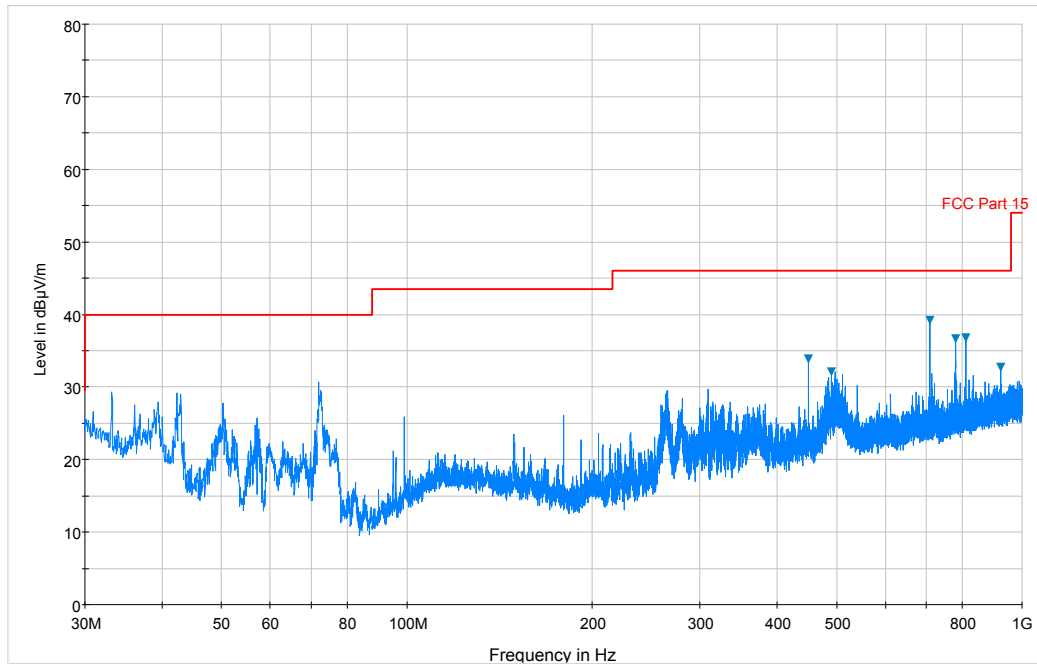

— Preview Result 1-PK+ — FCC Part 15 ▼ Final_Result PK+

7-10. Radiated Spurious Plot below 1GHz (Configuration #4, Pol. V)

MODEL: SXPL1 (Onyx PLUS (Gen 7.5))		FCC Pt. 15B MEASUREMENT REPORT (VERIFICATION)		Reviewed by: Quality Manager
Test Report S/N: 0Y1509281849-R4.RS2	Test Dates: 9/21 - 10/2/2015	EUT Type: Satellite Radio with FM Transmitter		Page 21 of 26

Frequency [MHz]	Detector	Ant. Pol. [H/V]	Analyzer Level [dBm]	AFCL [dB/m]	Field Strength [dBμV/m]	Limit [dBμV/m]	Margin [dB]
53.31	Peak	V	-87.12	8.71	28.59	40.00	-11.41
179.23	Peak	V	-87.36	12.16	31.80	43.52	-11.72
264.72	Peak	H	-92.52	14.68	29.16	46.02	-16.86
370.43	Peak	H	-90.58	17.00	33.42	46.02	-12.60
449.71	Peak	H	-93.77	18.81	32.04	46.02	-13.98
785.48	Peak	V	-104.82	23.67	25.85	46.02	-20.17

Table 7-8. Radiated Spurious Emissions below 1GHz (Configuration #4)

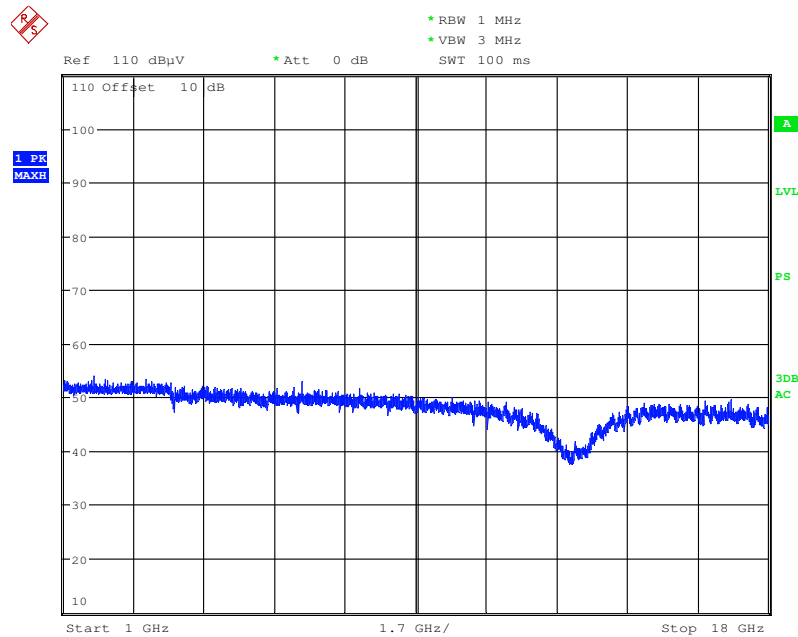

Date: 23.SEP.2015 11:27:05

7-11. Radiated Spurious Plot above 1GHz (Configuration #4, Pol. H)

MODEL: SXPL1 (Onyx PLUS (Gen 7.5))		FCC Pt. 15B MEASUREMENT REPORT (VERIFICATION)		Reviewed by: Quality Manager
Test Report S/N: 0Y1509281849-R4.RS2	Test Dates: 9/21 - 10/2/2015	EUT Type: Satellite Radio with FM Transmitter	Page 22 of 26	

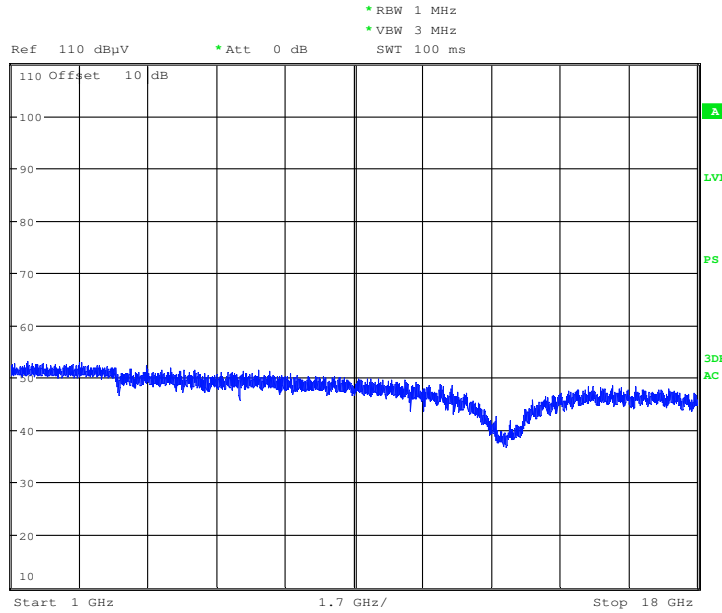

Date: 23.SEP.2015 11:32:16

7-12. Radiated Spurious Plot above 1GHz (Configuration #4, Pol. V)

Frequency [MHz]	Detector	Ant. Pol. [H/V]	Analyzer Level [dBm]	AFCL [dB/m]	Field Strength [dBμV/m]	Limit [dBμV/m]	Margin [dB]
1742.00	Avg	V	-109.40	29.27	26.87	53.98	-27.11
1742.00	Peak	V	-95.75	29.27	40.52	73.98	-33.46
4249.00	Avg	V	-110.21	38.90	35.70	53.98	-18.28
4249.00	Peak	V	-97.87	38.90	48.04	73.98	-25.94
7355.00	Avg	V	-110.94	43.16	39.22	53.98	-14.76
7355.00	Peak	V	-98.11	43.16	52.05	73.98	-21.93
9207.00	Avg	V	-111.17	45.33	41.16	53.98	-12.82
9207.00	Peak	V	-98.67	45.33	53.66	73.98	-20.32
15364.00	Avg	V	-111.76	48.54	43.78	53.98	-10.20
15364.00	Peak	V	-99.68	48.54	55.86	73.98	-18.12
16508.00	Avg	V	-112.26	49.30	44.04	53.98	-9.94
16508.00	Peak	V	-99.16	49.30	57.14	73.98	-16.84

Table 7-9. Radiated Spurious Emissions above 1GHz (Configuration #4)

MODEL: SXPL1 (Onyx PLUS (Gen 7.5))	PCTEST ENGINEERING LABORATORY, INC.	FCC Pt. 15B MEASUREMENT REPORT (VERIFICATION)	SIRIUSXM SATELLITE RADIO	Reviewed by: Quality Manager
Test Report S/N: 0Y1509281849-R4.RS2	Test Dates: 9/21 - 10/2/2015	EUT Type: Satellite Radio with FM Transmitter		Page 23 of 26

7.4 Line Conducted Measurement Data

§15.107

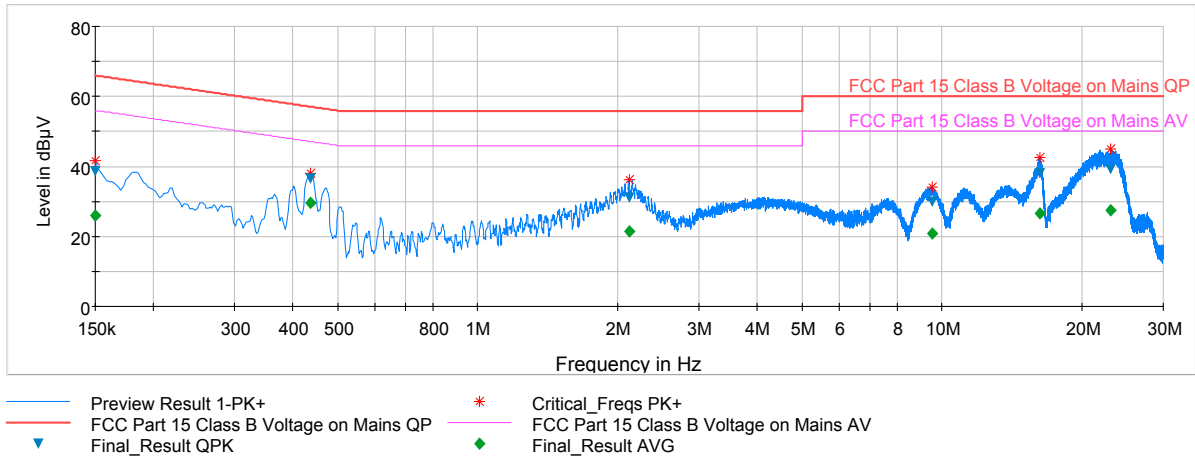

Plot 7-13. Line Conducted Plot (L1, Configuration #1)

Frequency MHz	Line	Corr. dB	QuasiPeak dBµV	Limit dBµV	Margin dB	Average dBµV	Limit dBµV	Margin dB
0.150	L1	-0.2	38.79	66.00	27.21	25.98	56.00	30.02
0.436	L1	0.0	36.60	57.14	20.54	29.53	47.14	17.61
2.117	L1	0.0	31.10	56.00	24.90	21.29	46.00	24.71
9.551	L1	0.2	29.78	60.00	30.22	20.96	50.00	29.04
16.258	L1	0.2	38.04	60.00	21.96	26.55	50.00	23.45
23.145	L1	0.2	39.24	60.00	20.76	27.55	50.00	22.45

Table 7-10. Line Conducted Data (L1, Configuration #1)

Notes:

- All Modes of operation were investigated and the worst-case emissions are reported.
- The limit for Class B device(s) from 150kHz to 30MHz are specified in Section 15.107 of the Title 47 CFR.
- L1 = Phase; N = Neutral
- Corr. (dB) = Cable loss (dB) + LISN insertion factor (dB)
- QP/AV Level (dBµV) = QP/AV Reading (dBµV) + Factor (dB)
- Margin (dB) = QP/AV Limit (dBµV) – QP/AV Level (dBµV)
- Traces shown in plot are made using a peak detector.
- Deviations to the Specifications: None.

MODEL: SXPL1 (Onyx PLUS (Gen 7.5))		FCC Pt. 15B MEASUREMENT REPORT (VERIFICATION)		Reviewed by: Quality Manager
Test Report S/N: 0Y1509281849-R4.RS2	Test Dates: 9/21 - 10/2/2015	EUT Type: Satellite Radio with FM Transmitter		Page 24 of 26

Line Conducted Measurement Data (Cont'd)

§15.107

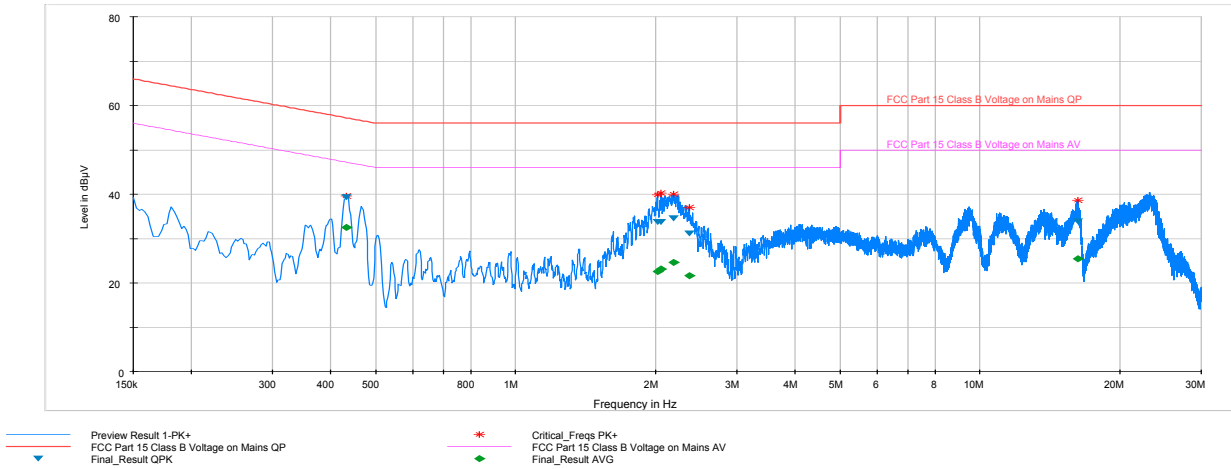

Plot 7-14. Line Conducted Plot (LN, Configuration #1)

Frequency	Line	Corr.	QuasiPeak	Limit	Margin	Average	Limit	Margin
MHz		dB	dBµV	dBµV	dB	dBµV	dBµV	dB
0.431	N	-0.1	39.26	57.23	17.97	32.47	47.23	14.76
2.022	N	0.0	33.69	56.00	22.31	22.54	46.00	23.46
2.058	N	0.0	33.69	56.00	22.31	23.16	46.00	22.84
2.184	N	0.0	34.55	56.00	21.45	24.57	46.00	21.43
2.371	N	0.0	31.13	56.00	24.87	21.58	46.00	24.42
16.258	N	0.1	33.91	60.00	26.09	25.44	50.00	24.56

Table 7-11. Line Conducted Data (LN, Configuration #1)



Notes:

- All Modes of operation were investigated and the worst-case emissions are reported.
- The limit for Class B device(s) from 150kHz to 30MHz are specified in Section 15.107 of the Title 47 CFR.
- L1 = Phase; N = Neutral
- Corr. (dB) = Cable loss (dB) + LISN insertion factor (dB)
- QP/AV Level (dBµV) = QP/AV Reading (dBµV) + Factor (dB)
- Margin (dB) = QP/AV Limit (dBµV) – QP/AV Level (dBµV)
- Traces shown in plot are made using a peak detector.
- Deviations to the Specifications: None.

MODEL: SXPL1 (Onyx PLUS (Gen 7.5))		FCC Pt. 15B MEASUREMENT REPORT (VERIFICATION)		Reviewed by: Quality Manager
Test Report S/N: 0Y1509281849-R4.RS2	Test Dates: 9/21 - 10/2/2015	EUT Type: Satellite Radio with FM Transmitter		Page 25 of 26

8.0 CONCLUSION

The data collected relate only to the item(s) tested and show that the **Sirius XM Satellite Radio with FM Transmitter Model: SXPL1 (Onyx PLUS (Gen 7.5))** has been tested to comply with the requirements specified in §15.107 and §15.109 of the FCC Rules and Industry Canada Standard ICES-003.

MODEL: SXPL1 (Onyx PLUS (Gen 7.5))		FCC Pt. 15B MEASUREMENT REPORT (VERIFICATION)		Reviewed by: Quality Manager
Test Report S/N: 0Y1509281849-R4.RS2	Test Dates: 9/21 - 10/2/2015	EUT Type: Satellite Radio with FM Transmitter		Page 26 of 26