

SIRIUS STARMATE 8

Dock & Play Radio + Vehicle Kit
User Guide

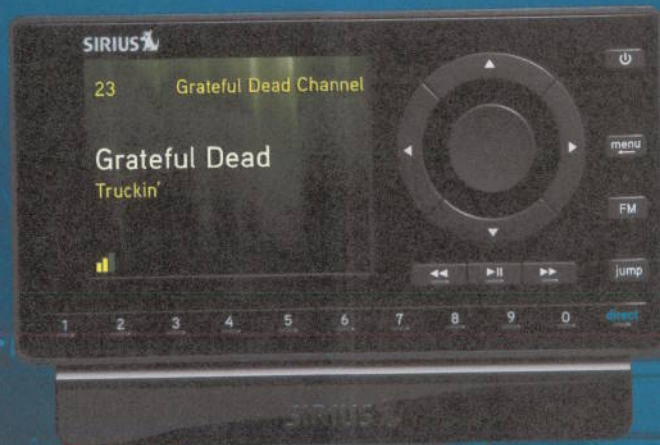

SiriusXM
SATELLITE RADIO



If you experience problems with the operation
or performance of your SiriusXM product,

DO NOT RETURN THIS PRODUCT TO YOUR RETAILER.

Call SiriusXM Listener Care at 1-800-869-5364
and speak to one of our service representatives.



Table of Contents

Introduction	5	Color Themes.....	66
Features	6	Trim Rings	67
Safety and Care Information.....	7	Parental Controls	70
What's in the Box?	9	Where Else Can You Use Your	
Starmate 8 Functions.....	10	Starmate 8?.....	75
PowerConnect Vehicle Dock	11	Configuring Your Starmate 8	77
Vehicle Installation	13	Sirius ID	78
Step 1: Choose a Location for Your		Find Available FM Channels in Your	
Radio	14	Area	79
Step 2: Install the Vent or Dash Mount	16	Turning the FM Transmitter On or Off	82
Step 3: Mount the Magnetic Mount		Set and Select an FM Channel.....	84
Antenna.....	20	Jump Settings	87
Step 4: Route the Magnetic Mount		Set Brightness.....	88
Antenna Cable	27	Set Audio Level	89
Sedan/Coupe With Antenna Placed		Signal Indicator.....	90
at the Rear of the Roof:.....	32	Auto Shut Off.....	91
Step 5: Connect the Magnetic Mount		Factory Settings	92
Antenna and PowerConnect Power		Demo Mode	93
Adapter	38	Troubleshooting	95
Step 6: Connect the Audio.....	39	Product Specifications	101
Subscribe	49	Patent Information	103
Using Your Starmate 8	53	Environmental Information	103
The Main Display.....	54	SiriusXM 90-Day Limited	
Navigation Basics	55	Warranty.....	107
Listening to Satellite Radio.....	57		
FM Presets	62		
Special Features	63		
Pause & Replay	64		

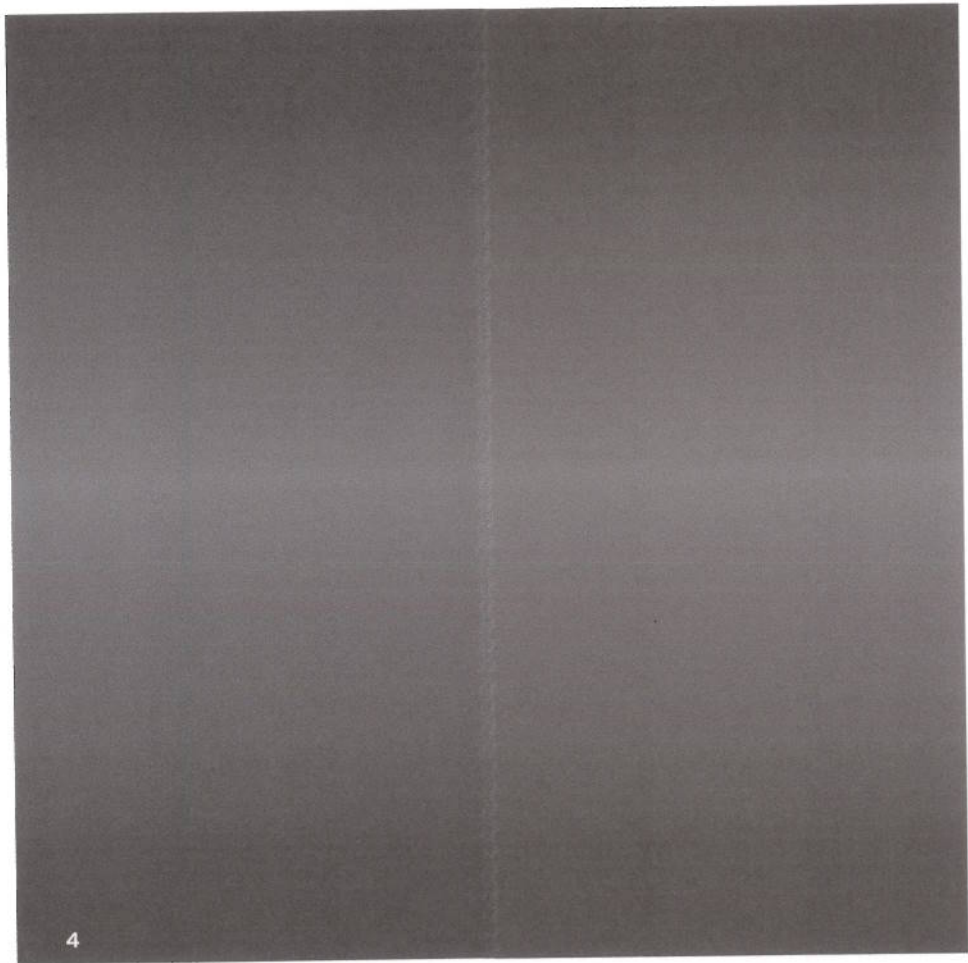

Introduction

Introduction

Features

Thank you for purchasing the Sirius Starmate 8 with Vehicle Kit!

Sirius Starmate 8 has these exciting features to enhance your overall experience:

- Choose from six different display colors to match your dash lights, and personalize with the trim rings.
- Pause, rewind and replay live Satellite Radio.
- Hear SiriusXM through your existing vehicle radio with easy, do-it-yourself installation.
- Browse other channels while listening to the current one.
- View artist name, song title, and channel information on the large color display.
- Store your favorite channels for one touch access.
- Easily lock and unlock channels with mature content.
- One-Touch Jump™ to traffic and weather for the city of your choice, or to the previous channel to which you were listening.
- Listen in multiple vehicles, at home, in the office or outdoors - all with just one subscription.
- Vehicle Kit included – add accessories for your home, office, or other vehicles.

Please read through this User Guide before using your Starmate 8!

Safety and Care Information



IMPORTANT! Self installation instructions and tips are provided for your convenience. It is your responsibility to determine if you have the knowledge, skills, and physical ability required to properly perform an installation. SiriusXM shall have no liability for damage or injury resulting from the installation or use of any SiriusXM or third party products. It is your responsibility to ensure that all products are installed in adherence with local laws and regulations and in such a manner as to allow a vehicle to be operated safely and without distraction. SiriusXM product warranties do not cover the installation, removal or reinstallation of any product.

- Do not expose to extreme temperatures (above 140°F or below -4°F, or above 60°C or below -20°C).
- Do not expose to moisture. Do not use device near or in water. Do not touch the device with wet hands.
- Do not let any foreign matter spill into device.
- Do not store in dusty areas.
- Do not expose to chemicals such as benzene and thinners. Do not use liquid or aerosol cleaners. Clean with a soft damp cloth only.
- Do not expose to direct sunlight for a prolonged period of time, and do not expose to fire, flame, or other heat sources.
- Do not try to disassemble and/or repair device yourself.
- Do not drop your device or subject it to severe impact.
- Do not place heavy objects on device.
- Do not subject device to excessive pressure.
- If the LCD screen is damaged, do not touch the liquid crystal fluid.

Introduction

Warning!

- Opening the case may result in electric shock.
- If the liquid crystal fluid comes in contact with your skin, wipe the skin area with a cloth and then wash the skin thoroughly with soap and running water. If the liquid crystal fluid comes into contact with your eyes, flush the eyes with clean water for at least 15 minutes and seek medical care. If the liquid crystal fluid is ingested, flush your mouth thoroughly with water. Drink large quantities of water, and induce vomiting. Seek medical care.
- Make sure that you insert the *PowerConnect*[™] Power Adapter all the way into the vehicle's cigarette lighter or power adapter socket.
- If you are using *PowerConnect* as your audio connection option, it is advisable not to insert a multi-outlet adapter into the same vehicle cigarette lighter or power adapter socket to simultaneously power other devices. Some multi-outlet adapters can prevent the *PowerConnect* feature from working properly.
- When using this product, it is always important to keep your eyes on the road and hands on the steering wheel. Not doing so could result in personal injury, death, and/or damage to your device, accessories, and/or to your vehicle or other property.
- Vehicle installation, service activation, and Radio configuration functions should not be performed while driving. Park your vehicle in a safe location before beginning installation.
- This product contains chemicals known to the State of California to cause cancer and birth defects or other reproductive harm.

Your device should be placed in your vehicle where it will not interfere with the function of safety features, e.g., deployment of airbags. Failure to correctly place device may result in injury to you or others, if the unit becomes detached during an accident and/or obstructs the deployment of an airbag.

What's in the Box?

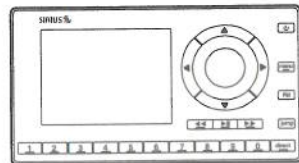

Starmate 8 Radio

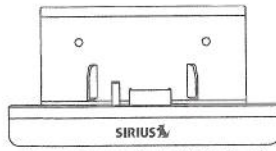

PowerConnect Vehicle Dock

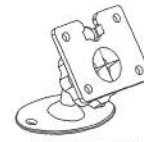

Dash Mount

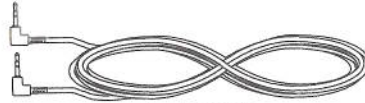

Aux In Cable



Trim Rings



Trim Ring Removal Tool

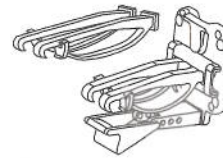

Vent Mount
and Extended
Vent Clamps

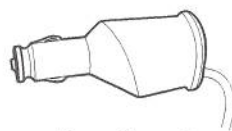

PowerConnect
Power Adapter



Magnetic Mount
Antenna & Tail



Screws



Antenna & Dash Mount
Alcohol Preparation Pads

Introduction

Starmate 8 Functions

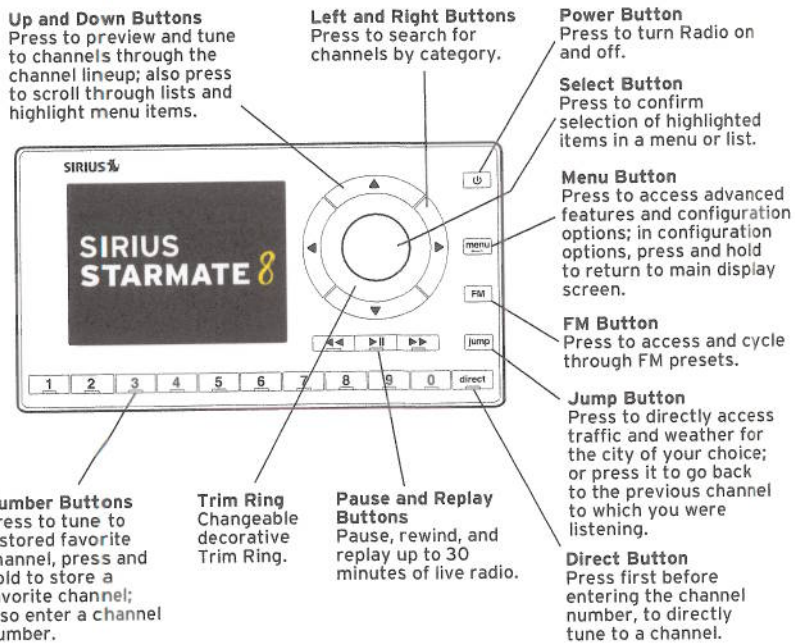

PowerConnect Vehicle Dock

Color-Coded Connections

The color-coded *PowerConnect* Vehicle Dock makes it simple to connect. Just match the colors on the cable ends to the colors on the dock to see what goes where.

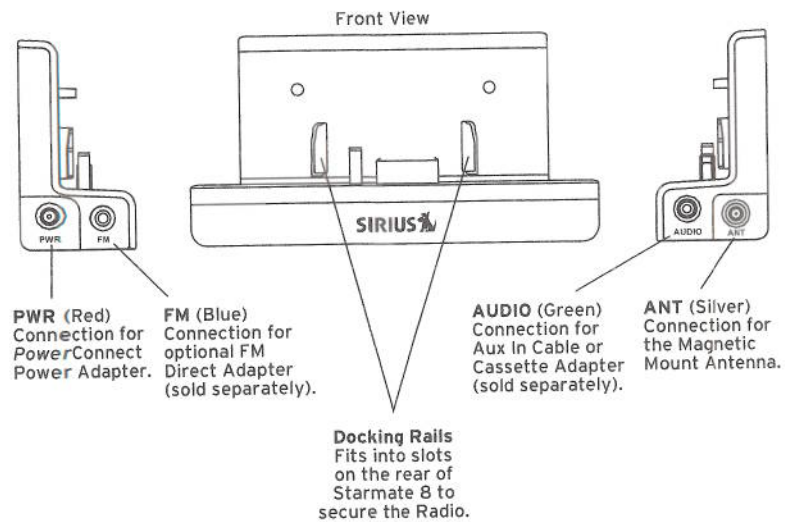

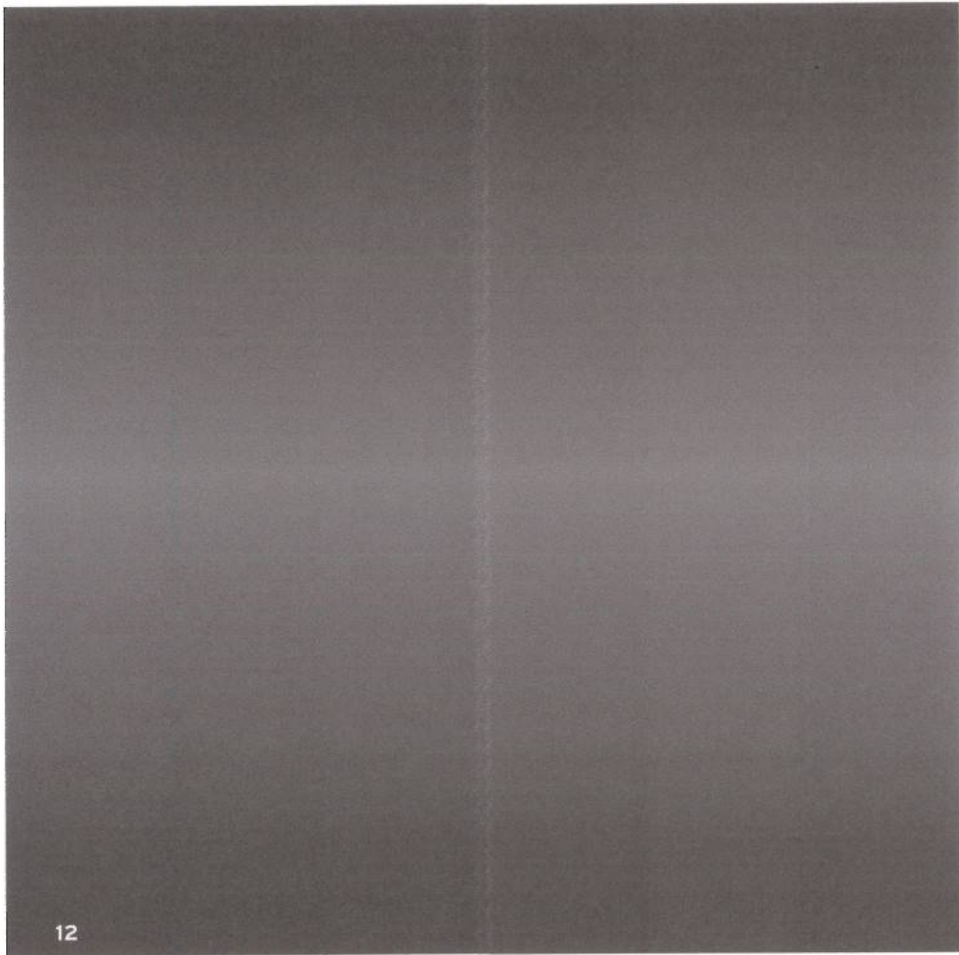

Vehicle Installation

Vehicle Installation



WARNING! DO NOT attempt to install Starmate 8 while driving. Park your vehicle in a safe location before beginning installation.

Step 1: Choose a Location for Your Radio

When installing Starmate 8 in your vehicle, choose a location where it will not block your vision, interfere with the controls, or obstruct the air bag. The location should be easily accessible and provide good visibility of the display, and should not be located where it will be in direct sunlight, which will affect the visibility of the display screen.

Several examples of Starmate 8 mounted in a vehicle are shown: **A** is the on dash method using the Dash Mount, and **B** is the vent clip method using the Vent Mount.

Option 1

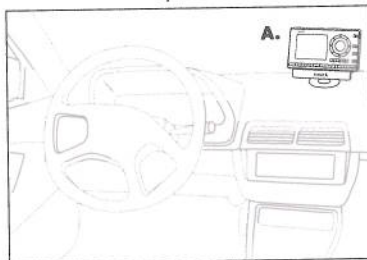

Option 2

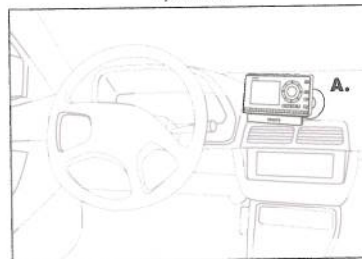



Option 3

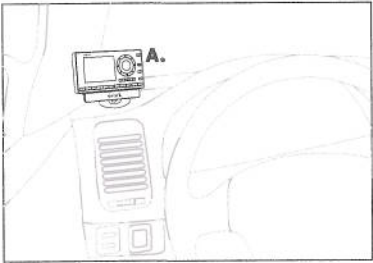

Option 4

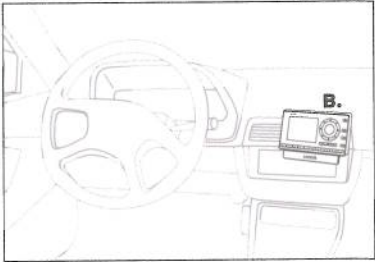

Option 5

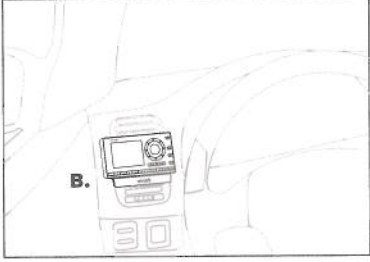

Vehicle Installation

Step 2: Install the Vent or Dash Mount

Depending on your situation, you can either choose to use the Dash Mount or the Vent Mount.

Installing the Dash Mount:



CAUTION! The adhesive used on the Dash Mount may be difficult to remove. Do not install this mount on leather surfaces (contact your vehicle dealer if you are unsure about your dash surface), and make sure the air temperature is at least 60°F (15°C) during installation. If it's not at least 60°F, turn on the heater in your vehicle to bring the temperature up to 60°F.

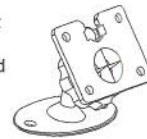

- 1 Locate a flat surface for the Dash Mount. Make sure there is ample room for the *PowerConnect Vehicle Dock* and *Starmate 8* when installed.
- 2 Set the orientation of the Dash Mount before adhering it. Loosen the knob and adjust the adhesive foot for the location you selected in "Step 1: Choose a Location for Your Radio" on page 14:
 - Option 1 & Option 3 should be oriented as **I**.
 - Option 2 should be oriented as **II**.
- 3 Attach the Dash Mount to the *PowerConnect Vehicle Dock* using the provided screws.
- 4 Clean the surface with the alcohol preparation pad and let it dry thoroughly.

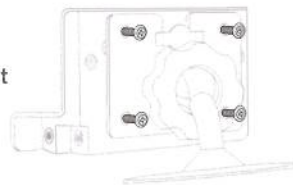
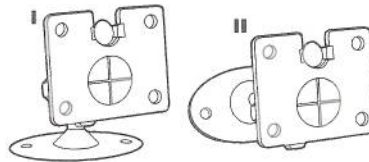

- 5** Peel off the adhesive liner. Position, press, and hold the Dash Mount and PowerConnect Vehicle Dock in place for 30 seconds.



IMPORTANT! Allow the Dash Mount adhesive to cure (dry) for a minimum of 2-4 hours before using the mount. The best adhesion occurs after 24 hours.

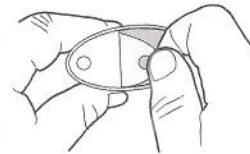

- 6** The dock mounting plate can be tilted in different directions. Adjust as necessary for your particular vehicle. When the orientation is correct, tighten the knob.

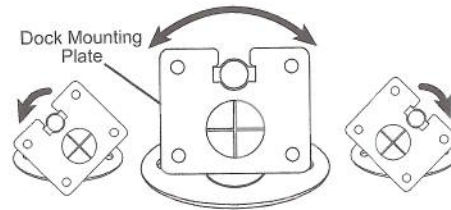
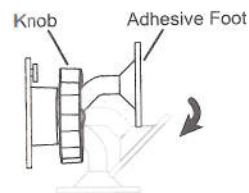

TIP! To remove, carefully lift the adhesive pad with your fingers or a spoon. Warming the pad with a hair dryer for several minutes will help soften the adhesive.

Vehicle Installation

Installing the Vent Mount:

- 1 Locate a vent with horizontal louvers sturdy enough to hold your PowerConnect Vehicle Dock and radio.
- 2 If the vent louvers in your vehicle are recessed, you may need to use the longer vent clamps with the Vent Mount. If so, Remove the shorter vent clamps and install the longer ones into the Vent Mount. Be sure to observe the orientation of the vent clamps as shown.

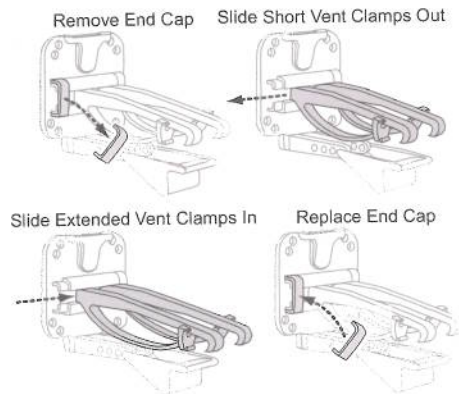
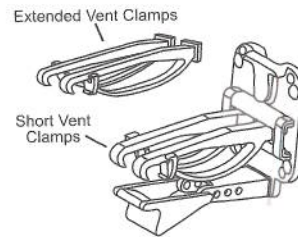

- 3 Attach the Vent Mount to the PowerConnect Vehicle Dock using the provided screws.
- 4 Push the Vent Mount onto the vehicle vent as shown (1) until it hooks on the rear of the vent louver (2).
- 5 Rest the foot against the bottom of the vent (2), and adjust the tilt of the Vent Mount by repositioning the foot to a different adjustment hole (3).

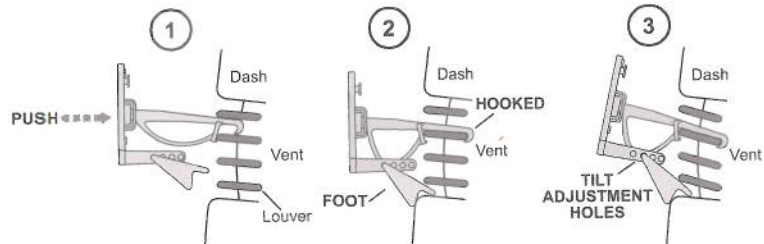
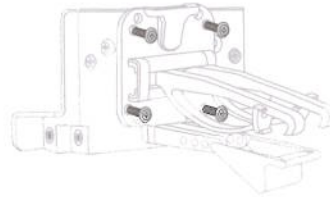

To remove the Vent Mount, push the mount into the vent. Then lift up until disengaged from the rear of the vent louver, and remove the Vent Mount.

Vehicle Installation

Step 3: Mount the Magnetic Mount Antenna

The Magnetic Mount Antenna contains a strong magnet which will stick to any metal part of your vehicle, but will not damage the vehicle.

To install the Magnetic Mount Antenna:

- 1 Choose the best location for your antenna considering your own personal situation. Pay particular attention to any accessories that you may have like luggage racks and how frequently you may use them.

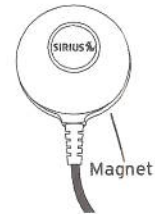

Sedan/Coupe: We recommend mounting the antenna above either the front windshield or the back window as shown.

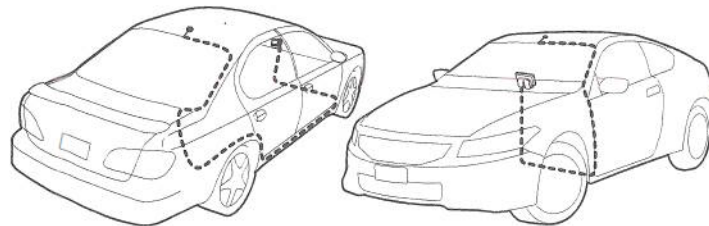

SUV: We recommend mounting the antenna at the rear of the roof as shown.

Convertible: We recommend mounting the antenna at the leading edge of the trunk as shown.

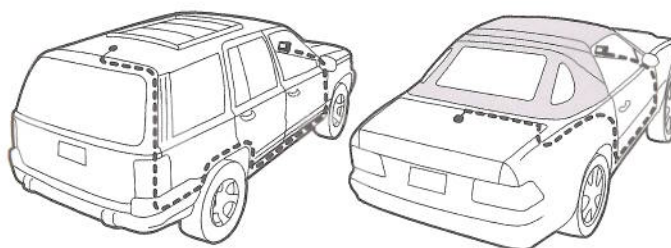

Pickup Truck: We recommend mounting the antenna above the front windshield as shown.

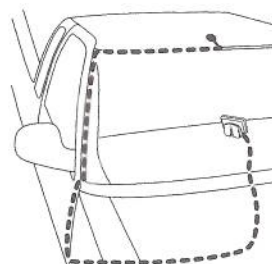

Vehicle Installation

- 2 Attach the Rubber Tail to the antenna and press the antenna cable into the Rubber Tail. The Rubber Tail will help to position the antenna the correct distance from the edge of the roof or trunk lid.
- 3 Clean the surface of the selected mounting location using the alcohol preparation pad and let it dry thoroughly.
- 4 Follow the Tips and Cautions shown on the next several pages, and place the antenna in the location you selected. Peel the protective material from the adhesive strips and press the Rubber Tail firmly into place on the vehicle.
- 5 Continue to press firmly down on the Rubber Tail for another 30 seconds. At room temperature (68°F), maximum adhesion usually occurs within 72 hours. During this period, avoid car washes and other contact with the antenna and the Rubber Tail.

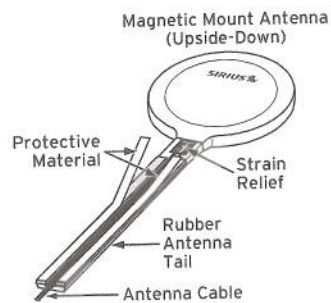

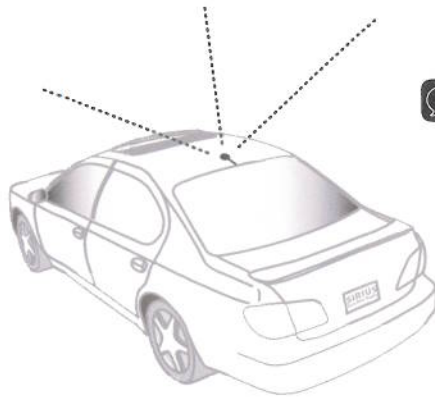

TIP! Mount the antenna on the roof (for most vehicles) or trunk (for convertibles) where it has a clear view of the sky in all directions.

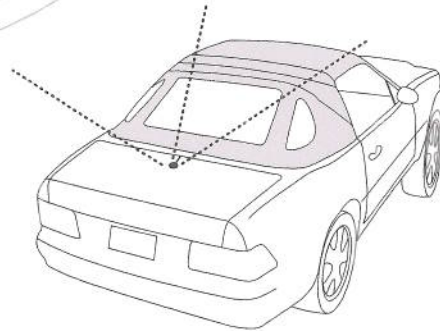

Vehicle Installation



TIP! Mount the antenna on the roof where it has at least 3 inches of clear space around it.

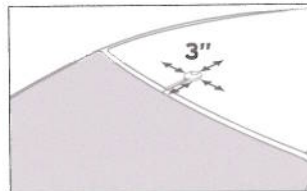

TIP! Use the supplied Rubber Tail to cover and protect the antenna cable.

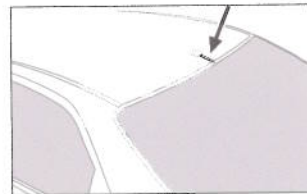

CAUTION! Don't mount the antenna closer than 3 inches from the edge of the roof. Use the supplied Rubber Tail as a guide for judging proper length and correct positioning.

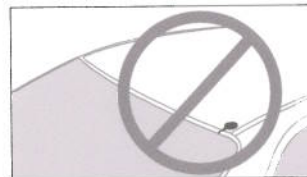



CAUTION! Don't mount the antenna inside the vehicle, for example, on the dashboard.



CAUTION! Don't mount the antenna on any of the vehicle's front, back or side pillars.

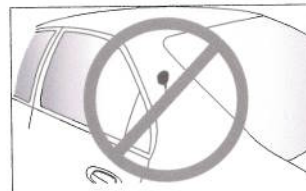

CAUTION! Don't mount the antenna close to a roof rack. Adjust the rack so it's further away from the antenna or move the antenna closer to the center of the roof.

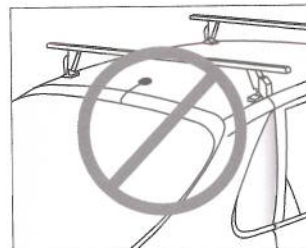

Vehicle Installation



CAUTION! Don't mount the Magnetic Mount Antenna close to another antenna. Mount it at least 3 inches away.

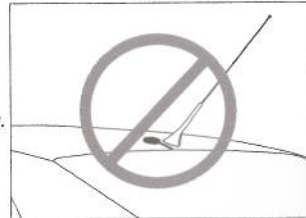

TIP! Always be careful to include enough slack in your cable to accommodate open doors or trunk lids. Use things typically found around the home, like electrical tape, to secure cables in areas so that hinges do not pinch the cable with the door. Hide any excess cable in the trim.

Step 4: Route the Magnetic Mount Antenna Cable

Before you begin routing the antenna cable, read these general instructions for how to route and hide the antenna cable. Then route your antenna cable according to the instructions which follow for your specific type of vehicle.

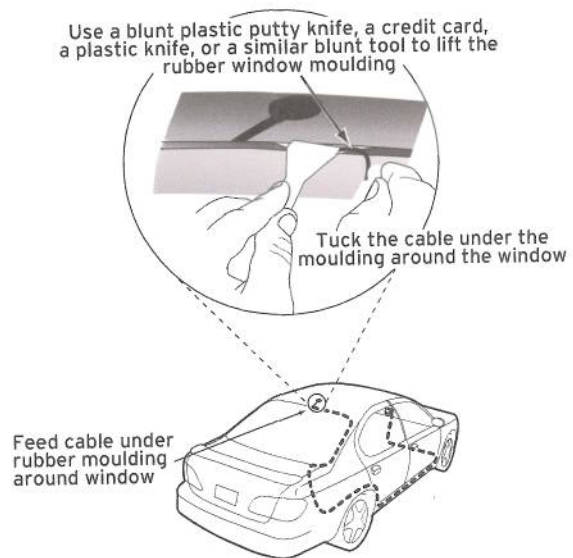

Vehicle Installation

Route cable out from under rear windshield moulding and tuck into weatherstripping around trunk opening

Avoid sharp bends by running cable through weatherstripping for several inches

Pull weatherstripping from trunk opening

Tuck cable into weatherstripping. Route cable through weatherstripping several inches to avoid sharp bends

Pull cable out of weatherstripping and route through trunk to cabin

Route cable out of window moulding and into weatherstripping around trunk opening

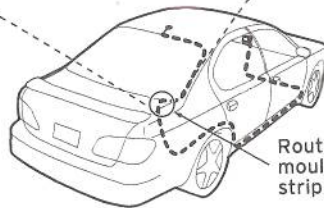
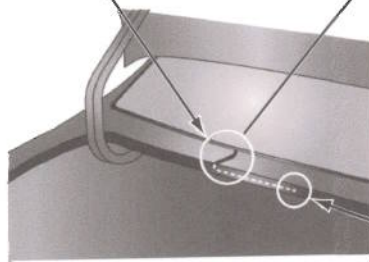



Bring cable out of weatherstripping and into trunk

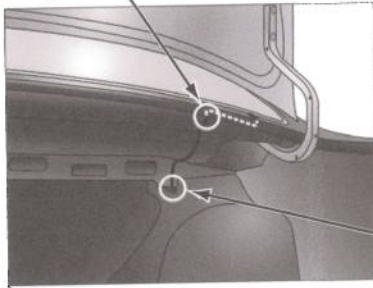

Route cable along trunk wall and into cabin through gap or conduit, along existing wiring harness

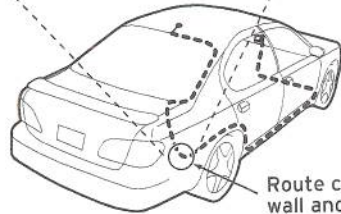

Route cable along trunk wall and into cabin

Vehicle Installation

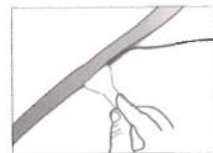

Use a blunt plastic putty knife or similar blunt tool trim and tuck cable under trim. Continue towards front of vehicle

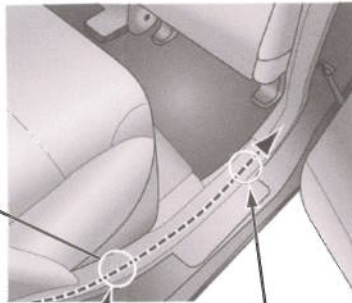

Route cable under trim or upholstery

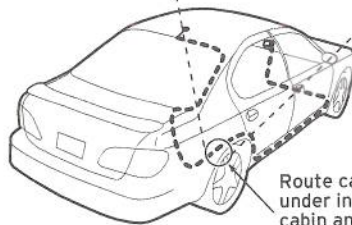

Route cable from trunk under interior trim, into cabin and towards front of vehicle

Continue routing cable under trim or carpet towards front of vehicle

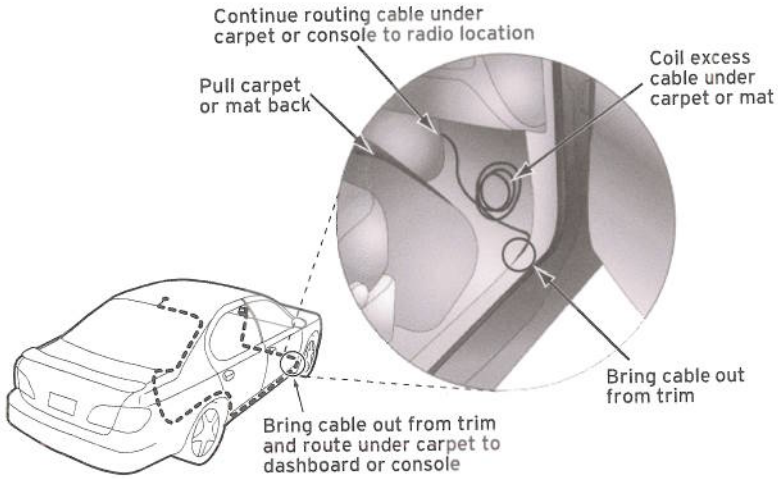

TIP! Always be careful to include enough slack in your cable to accommodate open doors or trunk lids. Use things typically found around the home, like electrical tape, to secure cables in areas so that hinges do not pinch the cable with the door. Hide any excess cable in the trim.

Vehicle Installation

Sedan/Coupe With Antenna Placed at the Rear of the Roof:

- 1** Feed the antenna cable from the antenna underneath the rubber molding around the rear window. Use a blunt plastic putty knife or similar blunt tool to lift the rubber molding around the rear window and tuck the antenna cable underneath the molding. Route the antenna cable around and down the window to the lowest point. If your rear window does not have rubber molding, we recommend consulting a professional installer.
- 2** Route the antenna cable out of the window molding and into the rubber weather stripping around the trunk opening. Lift the weather stripping from the opening and tuck the cable inside it, then replace the weather stripping. To avoid sharp bends in the cable, run the cable inside the weather stripping for a few inches, then remove the cable from the weather stripping inside the trunk. Keep the cable away from hinges, gears, etc., that could damage it.
- 3** Route the cable out from the rubber weather stripping and along the trunk wall. Continue routing the cable into the vehicle cabin through a conduit or along an existing wiring harness.
- 4** Route the cable through the main cabin area under the interior trim, towards the front of the vehicle. Use a blunt plastic putty knife or similar blunt tool to lift the plastic trim just enough to tuck the cable under underneath. Avoid side airbag locations on back pillars and above the doors. Airbag locations are marked with "SRS" logos. Be careful not to crimp or cut the cable.

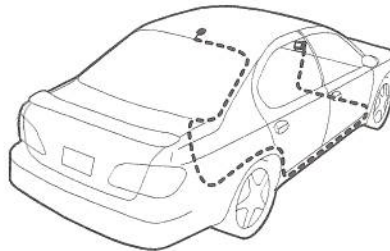

- 5 Bring the cable out from the trim near the front of the cabin and route it under the carpet toward the dashboard or console. Coil any excess cable in a hidden location, such as under the carpet, keeping it away from any vehicle pedals or controls. Secure the excess cable with wire ties (purchased separately).
- 6 Bring the end of the cable out at the *PowerConnect* Vehicle Dock location. Leave yourself enough cable so you can easily connect it to the antenna connector of the dock.
- 7 Continue with "Step 5: Connect the Magnetic Mount Antenna and *PowerConnect* Power Adapter" on page 38.

Sedan/Coupe With Antenna Placed at the Front of the Roof

- 1 Feed the antenna cable from the antenna underneath the rubber molding around the windshield. Use a blunt plastic putty knife or similar blunt tool to lift the rubber molding around the windshield and tuck the antenna cable underneath the molding. Route the antenna cable around and down the windshield to the lowest point.
- 2 At the lowest corner of the windshield, route the cable out of the windshield molding and into the rubber weather stripping around the door opening. Lift the weather stripping from the opening and tuck the cable inside it, then replace the weather stripping. Run the cable inside of the weather stripping to the bottom of the door opening.
- 3 Pull the cable out of the weather stripping at the bottom

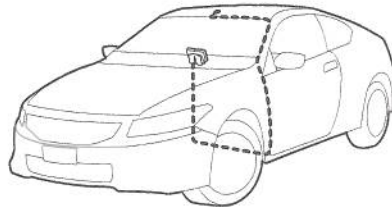

Vehicle Installation

of the door opening and route it under the carpet toward the dashboard. Coil any excess cable in a hidden location, such as under the carpet, keeping it away from any vehicle pedals or controls. Secure the excess cable with wire ties.

- 4 Bring the end of the cable out at the *PowerConnect* Vehicle Dock location. Leave yourself enough cable so you can easily connect it to the antenna connector of the dock.
- 5 Continue with "Step 5: Connect the Magnetic Mount Antenna and *PowerConnect* Power Adapter" on page 38.

Sport Utility Vehicle (SUV)

- 1 Feed the antenna cable underneath the rubber weather stripping of the rear tailgate window/door and route the cable along the rear hatch. Lift the weather stripping from the opening and tuck the cable inside it, then replace the weather stripping. Pull the cable out from weather stripping and route it into the cabin under the interior trim. Avoid hinges or gears that could crimp or cut the cable.
- 2 Route the cable through the SUV's main cabin area under the interior trim, towards the front of the vehicle. Use a blunt plastic putty knife or similar blunt tool to lift the plastic trim just enough to tuck the cable under underneath. Avoid side airbag locations on back pillars and above the doors. Airbag locations are marked with "SRS"

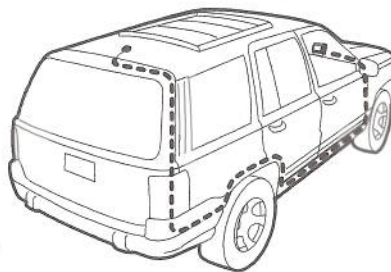

logos. Be careful not to crimp or cut the cable.

- 3** Bring the cable out from the trim near the front of the cabin and route it under the carpet toward the dashboard or console. Coil any excess cable in a hidden location, such as under the carpet, keeping it away from any vehicle pedals or controls. Secure the excess cable with wire ties (purchased separately).
- 4** Bring the end of the cable out at the *PowerConnect Vehicle Dock* location. Leave yourself enough cable so you can easily connect it to the antenna connector of the dock.
- 5** Continue with "Step 5: Connect the Magnetic Mount Antenna and *PowerConnect Power Adapter*" on page 38.

Convertible

- 1** Bring the antenna cable from the antenna into the trunk at the front edge of the trunk lid. Keep any bends in the cable loose. Tape or tie the cable along the inside of the trunk lid to the trunk lid hinge strut.
- 2** Allow enough slack in the cable so the trunk lid can easily open and close and keep the cable away from hinges, gears, etc., that could crimp or cut it. Route the cable along the trunk wall and into the cabin through a conduit or along an existing wiring harness.
- 3** Route the cable through the main cabin area under the interior trim, towards the front of the vehicle. Use a blunt plastic putty knife or similar blunt tool to lift the plastic trim just enough to tuck the cable under

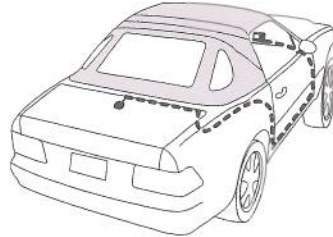

Vehicle Installation

underneath. Avoid side airbag locations on back pillars and above the doors. Airbag locations are marked with "SRS" logos. Be careful not to crimp or cut the cable.

- 4 Bring the cable out from the trim near the front of the cabin and route it under the carpet toward the dashboard or console. Coil any excess cable in a hidden location, such as under the carpet, keeping it away from any vehicle pedals or controls. Secure the excess cable with wire ties (purchased separately).
- 5 Bring the end of the cable out at the *PowerConnect* Vehicle Dock location. Leave yourself enough cable so you can easily connect it to the antenna connector of the dock.
- 6 Continue with "Step 5: Connect the Magnetic Mount Antenna and *PowerConnect* Power Adapter" on page 38.

Pickup Truck

- 1 Use a blunt plastic putty knife or similar blunt tool to lift the rubber molding around the windshield and tuck the antenna cable underneath it.
- 2 Continue tucking the cable underneath the windshield molding around the windshield to the lowest corner.
- 3 At the lowest corner of the windshield, route the cable out of the windshield molding and into the rubber weather stripping around the door opening. Lift the weather stripping from the opening and tuck the cable inside it, then replace

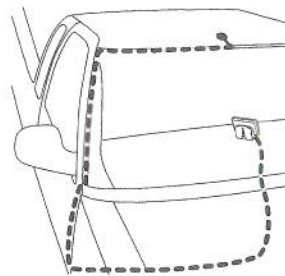

the weather stripping. Run the cable inside of the weather stripping to the bottom of the door opening.

- 4** Pull the cable out of the weather stripping at the bottom of the door opening and route it under the carpet toward the dashboard. Coil any excess cable in a hidden location, such as under the carpet, keeping it away from any vehicle pedals or controls. Secure the excess cable with wire ties.
- 5** Bring the end of the cable out at the *PowerConnect Vehicle Dock* location. Leave yourself enough cable so you can easily connect it to the antenna connector of the dock.
- 6** Continue with "Step 5: Connect the Magnetic Mount Antenna and *PowerConnect Power Adapter*" on page 38.

Vehicle Installation

Step 5: Connect the Magnetic Mount Antenna and PowerConnect Power Adapter

- 1 Plug the Magnetic Mount Antenna into the silver ANT connector on the PowerConnect Vehicle Dock.

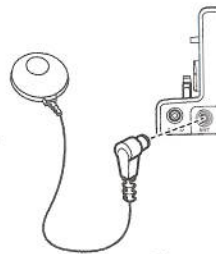

- 2 Insert the PowerConnect Power Adapter into your vehicle's cigarette lighter or power adapter socket.



- 3 Plug the PowerConnect Power Adapter into the red PWR connector on the dock.

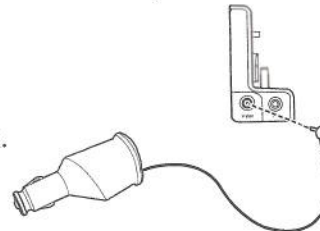

Step 6: Connect the Audio

To play Sirius audio through your vehicle's stereo or FM radio, decide on one of the following audio connection options:

- **Option 1: Best:** Use the provided **Aux In Cable** if your vehicle's stereo system has an auxiliary input connection or jack. Refer to your vehicle's owners manual to find the location of the auxiliary input jack, or consult the vehicle dealer.



TIP! The auxiliary input jack may be located on the face plate of the vehicle radio, on the back of the radio, anywhere on the front dash panel, inside the glove compartment, or inside the center console in between the front seats.

- **Option 2: Better:** Use a **Cassette Adapter** if your vehicle has a built-in cassette player. Cassette Adapters are sold separately and can be purchased from an electronics retailer, or go to www.siriusxm.com/accessories.
- **Option 3: Good:** Use the **PowerConnect** feature of Starmate 8. **PowerConnect** plays the audio through your vehicle's FM radio.
- **Option 4: Best:** Use the **FM Direct Adapter**. If none of the previous three audio connection options will work in your vehicle, then you will need to use the **FM Direct Adapter (FMDA)** (sold separately). The FMDA needs to be installed by a professional installer and directly connects Starmate 8 to your vehicle's FM radio. To learn more, check with the retailer where you bought your Radio, or go to www.siriusxm.com/accessories.

Follow the installation instructions in the next several sections for the audio connection option that you have selected.

Vehicle Installation

Option 1: Aux In Cable Installation Instructions

- 1 Plug one end of the Aux In Cable into the **green AUDIO** connector on the dock.
- 2 Plug the other end into the auxiliary input jack of your vehicle's stereo system.



- 3 Insert Starmate 8 into the dock, aligning the radio against the rear of the dock so that the rails on the dock fit into the mounting slots in the back of the radio.

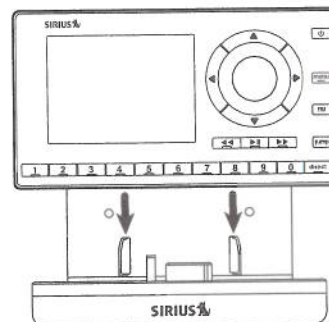

- 4 Power on your Starmate 8 by pressing the **Power button**.
- 5 Be sure the vehicle is outside and the antenna has a clear view of the sky. Verify that you are receiving the Sirius signal. There should at least be one bar on the lower left corner of the main display screen that

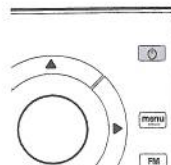

denotes antenna signal strength. You can also press **menu** and then press **▼** to scroll to and highlight **Signal Indicator**. Press the **Select** button. The Satellite and Terrestrial bars show the strength of the signal being received. If the signal reception is good, press and hold **menu** to return to the main display screen.

- 6 Ensure Starmate 8 is tuned to Sirius Preview channel 184. Upon power up, Starmate 8 should tune to channel 184 by default, when it's not yet activated. If it's not on channel 184, refer to "Listening to Satellite Radio" on page 57 to learn about how to tune a channel.
- 7 Turn on your vehicle's stereo system. Set it to play from the auxiliary input source. You should hear channel 184 through your vehicle's stereo system. You are now ready to activate your Starmate 8.
- 8 The audio level output of Starmate 8 can be increased or decreased as necessary to match the audio levels of other sources in your vehicle. Refer to "Set Audio Level" on page 89.

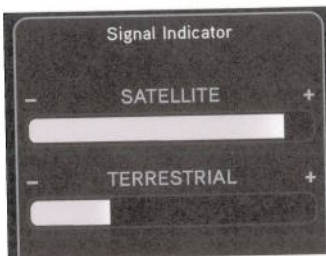

If the signal reception is good, showing at least one bar in the lower left corner of the display, but there is no Sirius audio, be sure the vehicle's stereo system is set to the auxiliary input source (step 7). Also be sure that the audio level is set high enough to be heard (step 8). Refer to "Troubleshooting" on page 96 for additional help.

Vehicle Installation

Option 2: Cassette Adapter Installation Instructions

- 1 Plug the Cassette Adapter into the green AUDIO connector on the dock.
- 2 Insert the Cassette Adapter into the vehicle's cassette deck. You may need to turn on your vehicle's stereo in order to do so.

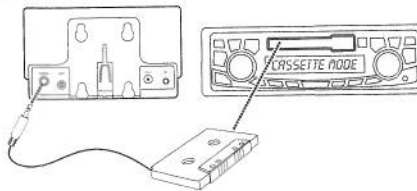

- 3 Insert your Sarmate 8 into the dock.

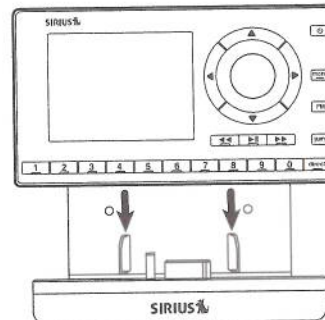

- 4 Power on your Sarmate 8 by pressing the Power button.
- 5 Be sure the vehicle is outside and the antenna has a clear view of the sky. Verify that you are receiving the Sirius signal. There should at least be one bar on the lower left corner of the main display screen that denotes

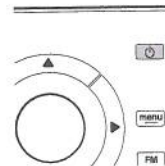

antenna signal strength. You can also press **menu** and then press **▼** to scroll to and highlight **Signal Indicator**. Press the **Select** button. The Satellite and Terrestrial bars show the strength of the signal being received. If the signal reception is good, press and hold **menu** to return to the main display screen.

- 6** Ensure Starmate 8 is tuned to Sirius Preview channel 184. Upon power up, Starmate 8 should tune to channel 184 by default, when it's not yet activated. If it's not on channel 184, refer to "Listening to Satellite Radio" on page 57 to learn about how to tune a channel.
- 7** Turn on your vehicle's stereo system. Set it to play from the cassette source. You should hear channel 184 through your vehicle's stereo system. You are now ready to activate your Starmate 8.
- 8** The audio level output of Starmate 8 can be increased or decreased as necessary to match the audio levels of other sources in your vehicle. Refer to "Set Audio Level" on page 89.

If the signal reception is good, showing at least one bar in the lower left corner of the display, but there is no Sirius audio, be sure the vehicle's stereo system is set to the cassette source (step 7). Also be sure that the audio level is set high enough to be heard (step 8). Refer to "Troubleshooting" on page 96 for additional help.

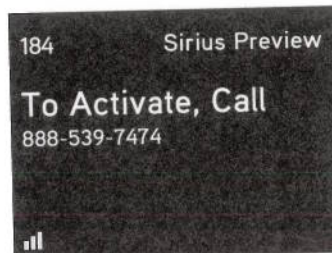
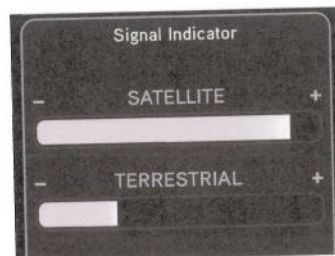

Vehicle Installation

Option 3: *PowerConnect* Installation Instructions

- 1 Insert your Starmate 8 into the dock.

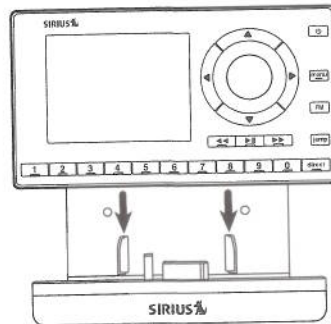

- 2 Power on your Starmate 8 by pressing the **Power** button.

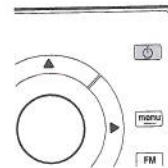

- 3 Be **sure** the vehicle is outside and the antenna has a clear view of the sky. Verify that you are receiving the Sirius signal. There should at least be one **bar** on the lower left corner of the main display screen that denotes antenna signal strength. You can also press **menu** and then press **▼** to scroll to and highlight **Signal Indicator**. Press the **Select** button. The

Satellite and Terrestrial bars show the strength of the signal being received. If the signal reception is good, press and hold **menu** to return to the main display screen.

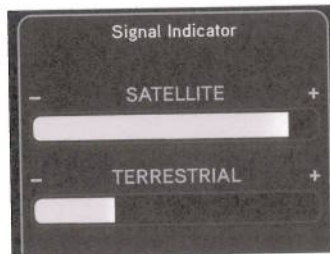

- 4 You'll first need to find an available FM channel. An available FM channel is one that's not being used by an FM radio station in your area. When you tune your FM radio to an available channel, you should only hear static or silence - not talk or music. We recommend one of the following methods to find an available FM channel:
 - a. Use the SiriusXM FM Channel Finder at www.siriusxm.com/fmchannel. Go to the website and enter your zip code. The Channel Finder will suggest a list of available FM channels in your area. For convenience, write down or print out the list.

OR
 - b. Manually tune through your local FM channels on your vehicle's FM radio. Locate and create a list of channels that aren't being used by any FM radio station. Write down the list. Once you have created your list of available FM channels, you will need to find the one that provides the best match for Starmate 8.

 **TIP!** You'll need to use the 'Manual' tune function on your vehicle's FM radio to tune through every FM channel one-by-one. Turn on your vehicle's FM radio. Start at 88.1 and use the 'Manual' tune function on your vehicle's FM radio to tune through each FM channel one-by-one (88.1 followed by 88.3 etc.) to locate channels that aren't being used by a local FM radio station. Write down each FM channel that has only static or silence on it, until you reach 107.9.

Vehicle Installation

- 5 Ensure Starmate 8 is tuned to Sirius Preview channel 184. Upon power up, Starmate 8 should tune to channel 184 by default, when it's not yet activated. If it's not on channel 184, refer to "Listening to Satellite Radio" on page 57 to learn about how to tune a channel.
- 6 Pick the first FM channel on your list from step 4. Turn on your vehicle's FM radio (if you have not already done so) and tune it to this FM channel.

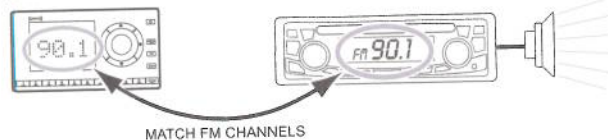
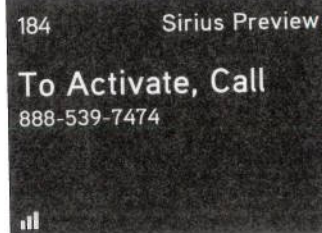

- 7 Set your Starmate 8 to transmit on the same FM channel that you have selected in step 4:
 - i. Press **menu**.
 - ii. Press **▼** to scroll to and highlight **FM Settings** and press the **Select** button.
 - iii. Press **▼** to scroll to and highlight **FM Channels**. Press the **Select** button.
 - iv. Press **▼** to scroll to and highlight the storage location **FM 2** and press the **Select** button.

FM Channels		
FM 1	97.9	current
FM 2	---	
FM 3	---	
FM 4	---	
FM 5	---	

- v. Tune to the available FM channel you choose in step 4. Press ◀ and ▶ to tune in steps of .2, i.e., 99.3 to 99.5. Press ▼ and ▲ to tune in steps of 1, i.e., 99.3 to 100.3. Press the **Select button** to select the FM channel.
- vi. **Start Using** is highlighted. Press the **Select button**.
- vii. The FM channel you selected will be confirmed on the display screen. Starmate 8 will tune to the FM channel.



- 8 You should hear channel 184 through your vehicle's stereo system. If you are satisfied with the sound quality, the installation is complete. You are now ready to activate your Starmate 8.
- 9 If the selected FM channel doesn't work well for you, work down the list of FM channels until you find one with which you are satisfied. Each time, you will need to tune your vehicle's FM radio to the FM channel and then set your Starmate 8 to transmit on the same FM channel (steps 6 & 7).

If the signal reception is good, showing at least one bar in the lower left corner of the display, but there is no Sirius audio, verify that both Starmate 8 and your vehicle's FM radio are tuned to the same FM channel (steps 6 & 7). Also ensure the chosen FM channel is a suitable one to use in your area (step 4). Verify that nothing is plugged into the **AUDIO** connector on the PowerConnect Vehicle Dock. Refer to "Troubleshooting" on page 96 for additional help.

Vehicle Installation

Option 4: FM Direct Adapter (FMDA) Installation

The FMDA needs to be installed by a professional installer. Professional installation can help improve your Radio's reception and significantly reduce the visibility of wires. To learn more, check with the retailer where you bought your Radio, or go to www.siriusxm.com/accessories.

Subscribe

Subscribe

You can subscribe to the Sirius service by using the Activate Radio feature where the Radio will guide you step-by-step through the subscription process, or by following the alternate method described below.

To use the Activate Radio step-by-step subscription guide:

- 1 When you first turn on Starmate 8, after the startup sequence, the Sirius channel lineup may update. Wait until any channel updates have completed before pressing any buttons. Once the channels have been updated, the Radio will automatically tune to channel 184.
- 2 Press menu.
- 3 **Activate Radio** will be highlighted. Press the **Select** button.
- 4 Follow the directions on each successive screen until you complete the subscription process.



Alternate subscription method:

- 1 Make sure your Starmate 8 is turned on, tuned to Sirius Preview channel 184, and receiving the Sirius signal so that you can hear the Sirius audio.
- 2 When you first turn on Starmate 8, after the startup sequence, the Sirius channel lineup may update. Wait until any channel updates have completed before pressing any buttons. Once the channels have been updated, the Radio will automatically tune to channel 184.
- 3 Make a note of the Sirius ID. You can find it:
 - on channel 0 (zero)

