

SIRIUS STRATUS 6

User Guide



SIRIUS | ((XM))
S A T E L L I T E R A D I O

Table of Contents

Introduction	5	FM Presets	66
Features	6	Special Features	67
Safety and Care Information	7	Parental Lock	68
What's in the Box?	9	Where Else Can You Use Your Stratus 6?	71
Stratus 6 Functions	10	Configuring Your Stratus 6	73
PowerConnect Vehicle Dock	11	Sirius ID	74
Vehicle Installation	13	Find Available FM Channels in Your Area	75
Step 1: Choose a Location for Your Radio	14	Turn FM Transmitter On/Off	78
Step 2: Install the Vent or Dash Mount	16	Set and Select an FM Channel	79
Step 3: Mount the Magnetic Mount Antenna	20	Jump Settings	81
Step 4: Route the Magnetic Mount Antenna Cable	27	Display	82
Step 5: Connect the Magnetic Mount Antenna and PowerConnect Power Adapter	39	Audio Level	84
Step 6: Connect the Audio	40	Signal	85
Activation	53	Factory Default	86
Using Your Stratus 6	57	Troubleshooting	87
The Main Display	58	Product Specifications	91
My Channels	59	Patent Information	93
Navigation Basics	60	Environmental Information	93
Listening to Satellite Radio	62	Owner's Record	96

Introduction

Features

Congratulations, on your purchase of the Stratus 6!

The Stratus 6 has these exciting features to enhance your overall experience:

- **Easy to read blue display:** View artist name, song title, and channel information on an easy to read display.
- **A La Carte programming capability:** Make individual channel selection.
- **Channel guide:** View your individual channel lineup by category.
- **Improved audio connection options:** Use either the included Aux In Cable, or the new *PowerConnect* technology to listen to the audio through your vehicle's stereo system.
- **Favorite channel presets:** Save and enjoy fast access to up to 10 of your favorite channels.
- **FM preset button:** Store and quickly access FM channels that give you the best audio reception when using *PowerConnect*.
- **One-Touch Jump™:** Directly access traffic and weather of the 20 most congested cities.
- **Parental controls:** Easily lock and unlock channels with mature content.

Please read the entire User Guide before using your Stratus 6!

Safety and Care Information



IMPORTANT! Always read and understand all the instructions to avoid injury to yourself and/or damage to your device. SIRIUS | XM Radio Inc. disclaims all responsibility for damage from data loss due to breakdown, repair, or other causes.

- Do not expose to extreme temperatures (above 140°F or below -4°F, or above 60°C or below -20°C).
- Do not expose to moisture. Do not use device near or in water.
- Do not let any foreign matter spill into device.
- Do not store in dusty areas.
- Do not expose to chemicals such as benzene and thinners. Do not use liquid or aerosol cleaners. Clean with a soft damp cloth only.
- Do not expose to direct sunlight for a prolonged period of time, and do not expose to fire, flame, or other heat sources.
- Do not try to disassemble and/or repair device yourself.
- Do not drop your device or subject it to severe impact.
- Do not place heavy objects on device.
- Do not subject device to excessive pressure.
- If the LCD screen is damaged, do not touch the liquid crystal fluid.

Introduction

WARNING!

- Opening the case may result in electric shock.
- If the liquid crystal fluid comes in contact with your skin, wipe the skin area with a cloth and then wash the skin thoroughly with soap and running water. If the liquid crystal fluid comes into contact with your eyes, flush the eyes with clean water for at least 15 minutes and seek medical care. If the liquid crystal fluid is ingested, flush your mouth thoroughly with water. Drink large quantities of water, and induce vomiting. Seek medical care.
- Make sure that you insert the *PowerConnect* Power Adapter all the way into the vehicle's cigarette lighter or power adapter socket.
- Do not insert several devices into the same power socket.
- Use the *PowerConnect* Power Adapter and Vehicle Dock away from water sources to avoid fire or electric shock.
- Do not touch the device with wet hands.
- When using this product, it is always important to keep your eyes on the road and hands on the wheel. Not doing so could result in personal injury, death, and/or damage to your device, accessories, and/or to your vehicle or other property.
- This product contains chemicals known to the State of California to cause cancer and birth defects or other reproductive harm.
- Vehicle installation and radio configuration functions should not be performed while driving. Park your vehicle in a safe location before beginning installation.

Your device should be placed in your vehicle where it will not interfere with the function of safety features, e.g., deployment of airbags. Failure to correctly place device may result in injury to you or others, if the unit becomes detached during an accident and/or obstructs the deployment of an airbag.

What's in the Box?

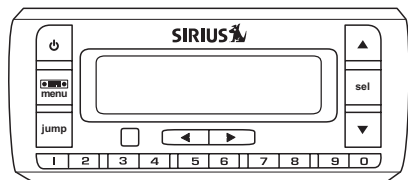

Stratus 6 Radio

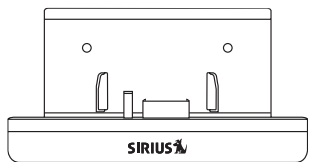

PowerConnect Vehicle Dock



Aux In Cable

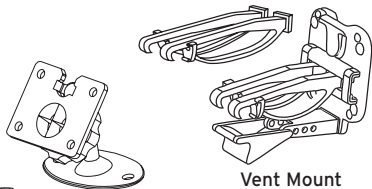

Dash Mount

Vent Mount
and Extended
Vent Clamps

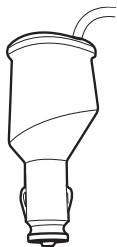

PowerConnect
Power Adapter

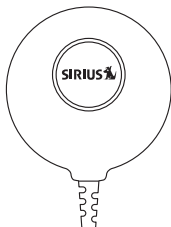

Magnetic Mount Antenna
and Rubber Tail



Screws



Antenna & Dash Mount
Alcohol Preparation Pads

Introduction

Stratus 6 Functions

Power Button

Turn radio on and off.

FM / Menu Button

FM: Press to access and cycle through FM presets.

Menu: Press and hold to access advanced features and configuration options; also when in configuration options, press and hold to return to main display screen.

Up and Down Arrows

Scroll through lists and preview channels; also highlight menu options.

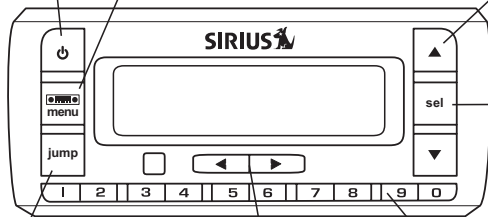

Select Button

Press to confirm selection for channel and menu items; also press first before entering the channel number, to directly tune to a channel. Press and hold to go back to the previous channel to which you were listening.

Jump

Directly access traffic and weather of the 20 most congested cities.

Left and Right Arrows

Search for channels by category.

Number Buttons

Select your favorite channels; also enter a channel number.

PowerConnect Vehicle Dock

Color-Coded Connections

The *PowerConnect* Vehicle Dock has color-coded connectors to assist you in connecting the cables to the correct connector.

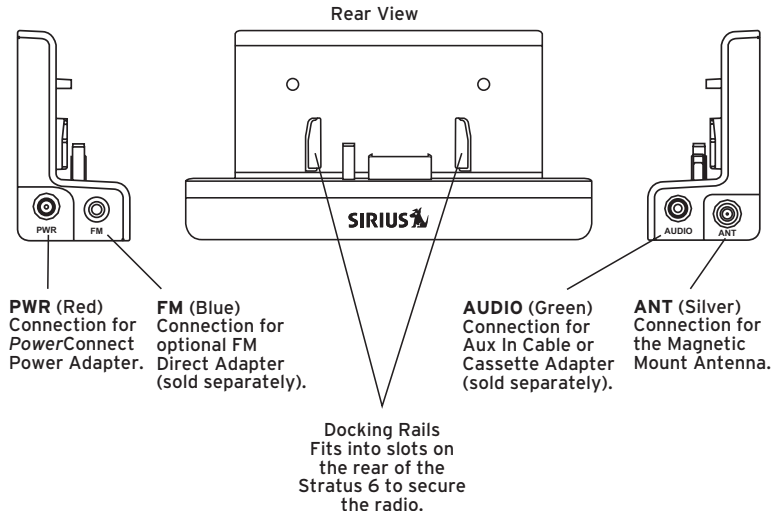

Vehicle Installation

Vehicle Installation

Step 1: Choose a Location for Your Radio

When installing the Stratus 6 in your vehicle, choose a location where it will not block your vision, interfere with the controls, or obstruct any air bags. The location should be easily accessible and provide good visibility of the display, and should not be located where it will be in direct sunlight, which will affect the visibility of the display screen.

Several examples of the Stratus 6 mounted in a vehicle are shown: **A** is the on dash method using the Dash Mount, and **B** is the vent clip method using the Vent Mount.

Option 1

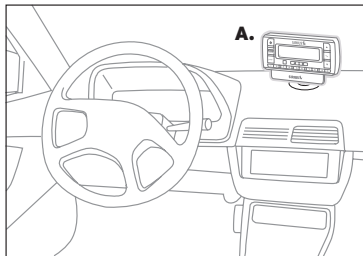

Option 2

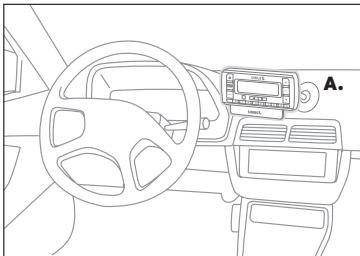

Option 3

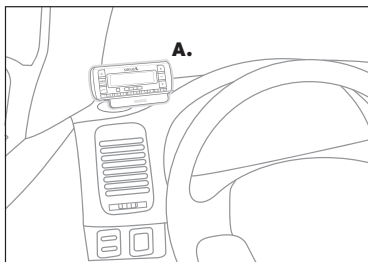

Option 4

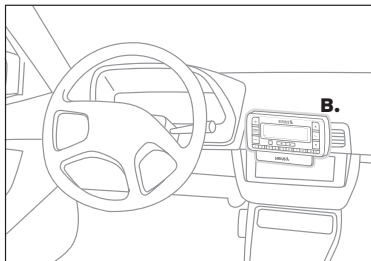

Option 5

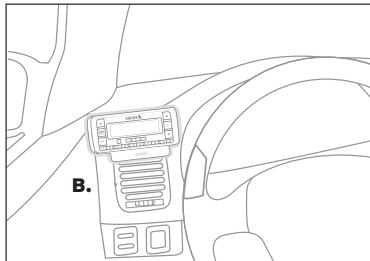

Vehicle Installation

Step 2: Install the Vent or Dash Mount

Depending on your situation, you can either choose to use the Dash Mount or the Vent Mount.

Installing the Dash Mount:



CAUTION! The adhesive used on the Dash Mount may be difficult to remove. Do not install this mount on leather surfaces and make sure the air temperature is at least 60°F (15°C) during installation.

- 1 Locate a flat surface for the Dash Mount. Make sure there is ample room for the *PowerConnect Vehicle Dock* and *Stratus 6* when installed.
- 2 Set the orientation of the Dash Mount before adhering it. Loosen the knob and adjust the adhesive foot for the location you selected in "Step 1: Choose a Location for Your Radio" on page 14:
 - Option 1 & 3 should be oriented as **I**.
 - Option 2 should be oriented as **II**.
- 3 Attach the Dash Mount to the *PowerConnect Vehicle Dock* using the provided screws.

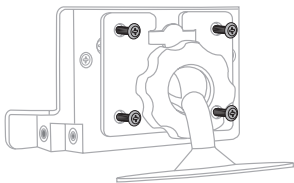
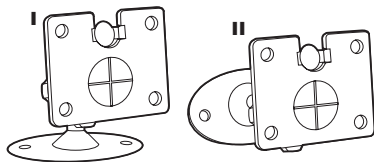
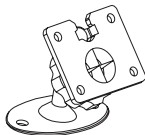

- 4 Clean the surface with the alcohol preparation pad and let it dry thoroughly.
- 5 Peel off the adhesive liner. Position, press, and hold the Dash Mount and PowerConnect Vehicle Dock in place for 30 seconds.

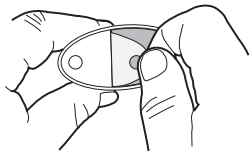

IMPORTANT! Allow the Dash Mount adhesive to cure (dry) for a minimum of 2-4 hours before using the mount. The best adhesion occurs after 24 hours.

- 6 The dock mounting plate can be tilted in different directions. Adjust as necessary for your particular vehicle. When the orientation is correct, tighten the knob.

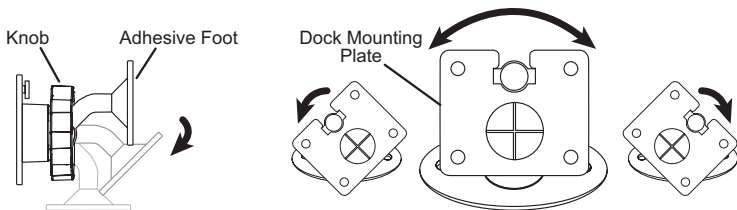

TIP! To remove, carefully lift the adhesive pad with your fingers or a spoon. Warming the pad with a hair dryer for several minutes will help soften the adhesive.

Vehicle Installation

Installing the Vent Mount:

- 1** Locate a vent with horizontal louvers sturdy enough to hold your PowerConnect Vehicle Dock and radio.
- 2** If the vent louvers in your vehicle are recessed, you may need to use the longer vent clamps with the Vent Mount. If so, Remove the shorter vent clamps and install the longer ones into the Vent Mount. Be sure to observe the orientation of the vent clamps as shown.

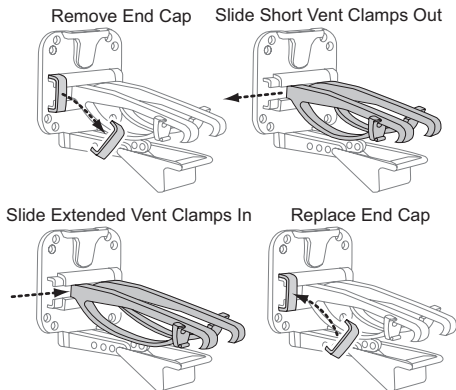
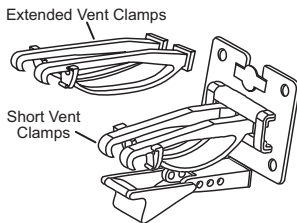

- 3 Attach the Vent Mount to the PowerConnect Vehicle Dock using the provided screws.
- 4 Push the Vent Mount onto the vehicle vent as shown (1) until it hooks on the rear of the vent louver (2).
- 5 Rest the foot against the bottom of the vent (2), and adjust the tilt of the Vent Mount by repositioning the foot to a different adjustment hole (3).

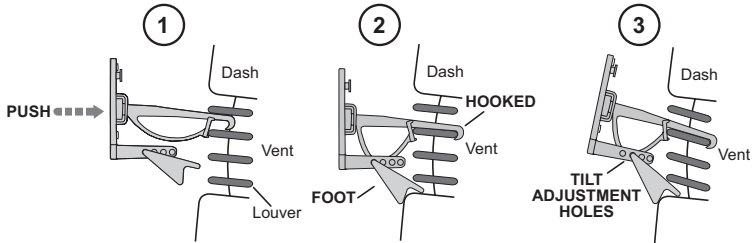
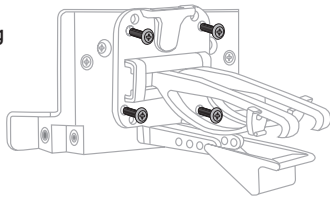

To remove the Vent Mount, push the mount into the vent. Then lift up until disengaged from the rear of the vent louver, and remove the Vent Mount.

Vehicle Installation

Step 3: Mount the Magnetic Mount Antenna

The Magnetic Mount Antenna contains a strong magnet which will stick to any metal part of your vehicle, but will not damage the vehicle.

To install the Magnetic Mount Antenna:

- 1 Choose the best location for your antenna considering your own personal situation. Pay particular attention to any accessories that you may have like luggage racks and how frequently you may use them.

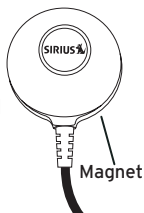

Sedan/Coupe: We recommend mounting the antenna above either the front windshield or the back window as shown.

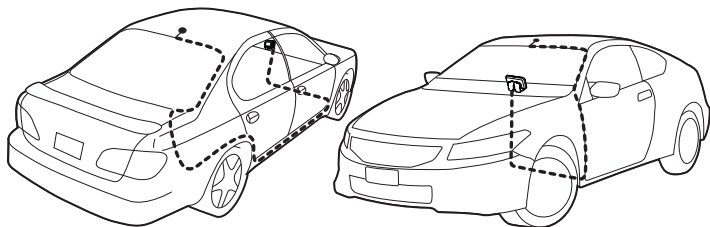

SUV: We recommend mounting the antenna at the rear of the roof as shown.

Convertible: We recommend mounting the antenna at the leading edge of the trunk as shown.

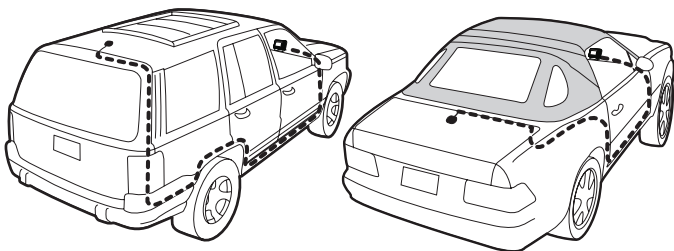

Pickup Truck: We recommend mounting the antenna above the front windshield as shown.

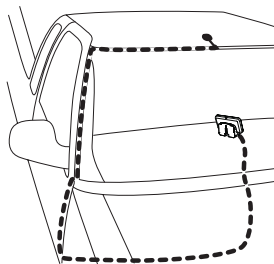

Vehicle Installation

- 2 Attach the Rubber Tail to the antenna and press the antenna cable into the Rubber Tail. The Rubber Tail will help to position the antenna the correct distance from the edge of the roof or trunk lid.
- 3 Clean the surface of the selected mounting location using the alcohol preparation pad and let it dry thoroughly.
- 4 Follow the Tips and Cautions shown on the next several pages, and place the antenna in the location you selected. Peel the protective material from the adhesive strips and press the Rubber Tail firmly into place on the vehicle.
- 5 Continue to press firmly down on the Rubber Tail for another 30 seconds. At room temperature (68° F), maximum adhesion usually occurs within 72 hours. During this period, avoid car washes and other contact with the antenna and the Rubber Tail.

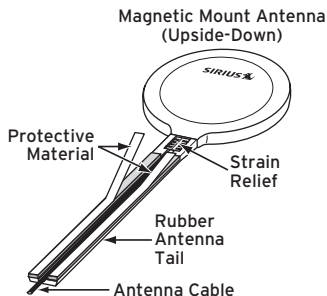

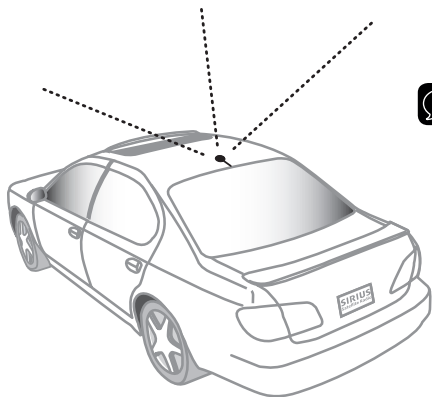

TIP! Mount the antenna on the roof (for most vehicles) or trunk (for convertibles) where it has a clear view of the sky in all directions.

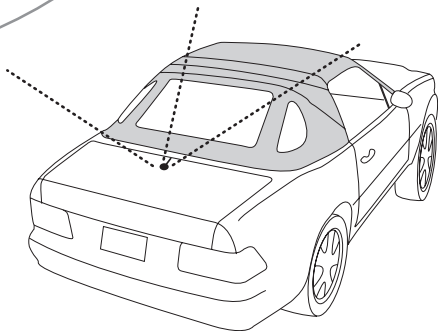



TIP! Mount the antenna on the roof where it has at least 3 inches of clear space around it.

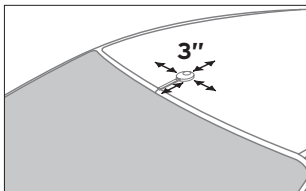

TIP! Use the supplied Rubber Tail to cover and protect the antenna cable.

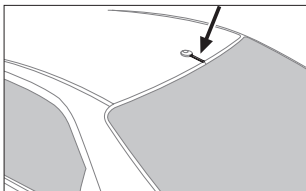

CAUTION! Don't mount the antenna closer than 3 inches from the edge of the roof. Use the supplied Rubber Tail as a guide for judging proper length and correct positioning.

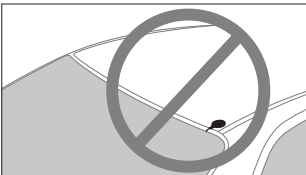



CAUTION! Don't mount the antenna inside the vehicle, for example, on the dashboard.

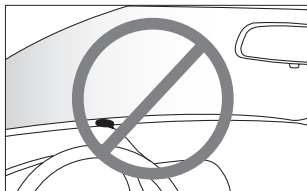

CAUTION! Don't mount the antenna on any of the vehicle's front, back or side pillars.

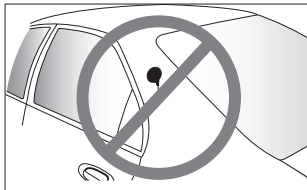

CAUTION! Don't mount the antenna close to a roof rack. Adjust the rack so it's further away from the antenna or move the antenna closer to the center of the roof.

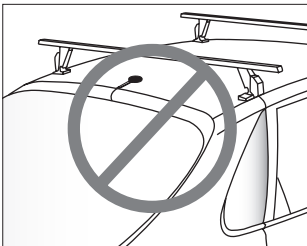

Vehicle Installation



CAUTION! Don't mount the Magnetic Mount Antenna close to another antenna. Mount it at least 3 inches away.

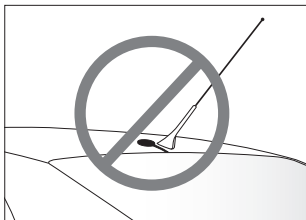

TIP! Always be careful to include enough slack in your cable to accommodate open doors or trunk lids. Use things typically found around the home, like electrical tape, to secure cables in areas so that hinges do not pinch the cable with the door. Hide any excess cable in the trim.

Step 4: Route the Magnetic Mount Antenna Cable

Before you begin routing the antenna cable, read these general instructions for how to route and hide the antenna cable. Then route your antenna cable according to the instructions which follow for your specific type of vehicle.

Use a blunt plastic putty knife, a credit card, a plastic knife, or a similar blunt tool to lift the rubber window moulding

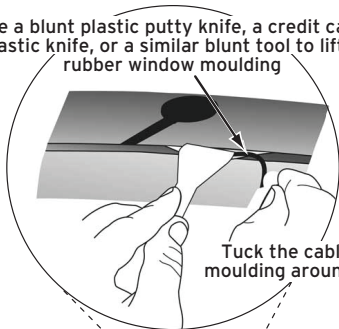

Tuck the cable under the moulding around the window

Feed cable under rubber moulding around window

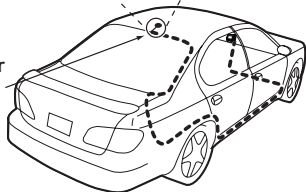

Vehicle Installation

Route cable out from under rear windshield moulding and tuck into weatherstripping around trunk opening

Avoid sharp bends by running cable through weatherstripping for several inches



Pull weatherstripping from trunk opening



Tuck cable into weatherstripping. Route cable through weatherstripping several inches to avoid sharp bends

Pull cable out of weatherstripping and route through trunk to cabin

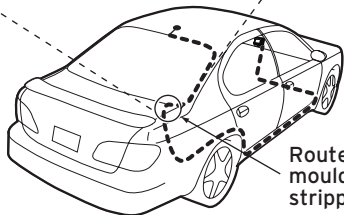
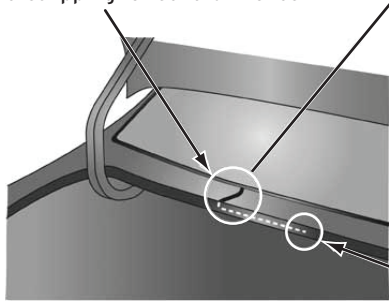

Route cable out of window moulding and into weatherstripping around trunk opening

Bring cable out of weatherstripping and into trunk

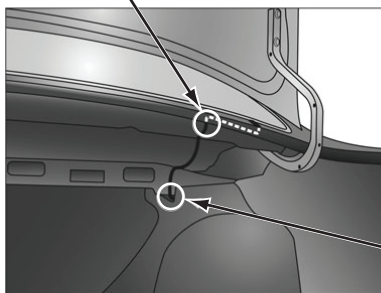

Route cable along trunk wall and into cabin through gap or conduit, along existing wiring harness

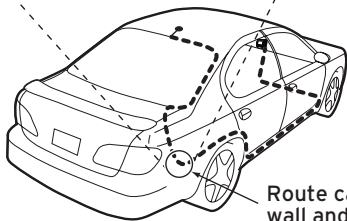

Route cable along trunk wall and into cabin

Vehicle Installation

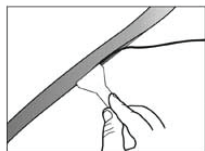

Use a blunt plastic putty knife or similar blunt tool trim and tuck cable under trim. Continue towards front of vehicle

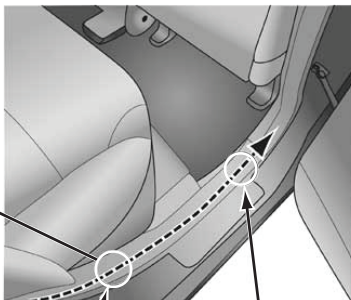

Route cable under trim or upholstery

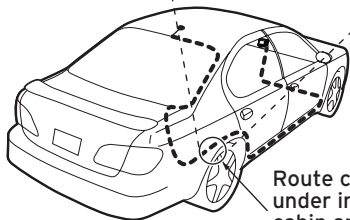

Route cable from trunk under interior trim, into cabin and towards front of vehicle

Continue routing cable under trim or carpet towards front of vehicle

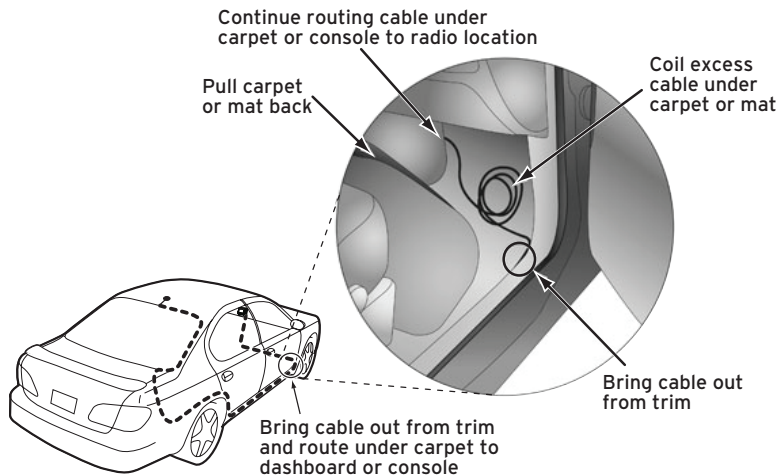

TIP! Always be careful to include enough slack in your cable to accommodate open doors or trunk lids. Use things typically found around the home, like electrical tape, to secure cables in areas so that hinges do not pinch the cable with the door. Hide any excess cable in the trim.

Vehicle Installation

- **Sedan/Coupe With Antenna Placed at the Rear of the Roof:**

1. Feed the antenna cable from the antenna underneath the rubber molding around the rear window. Use a blunt plastic putty knife or similar blunt tool to lift the rubber molding around the rear window and tuck the antenna cable underneath the molding. Route the antenna cable around and down the window to the lowest point. If your rear window does not have rubber molding, we recommend consulting a professional installer.
2. Route the antenna cable out of the window molding and into the rubber weather stripping around the trunk opening. Lift the weather stripping from the opening and tuck the cable inside it, then replace the weather stripping. To avoid sharp bends in the cable, run the cable inside the weather stripping for a few inches, then remove the cable from the weather stripping inside the trunk. Keep the cable away from hinges, gears, etc., that could damage it.
3. Route the cable out from the rubber weather stripping and along the trunk wall. Continue routing the cable into the vehicle cabin through a conduit or along an existing wiring harness.
4. Route the cable through the main cabin

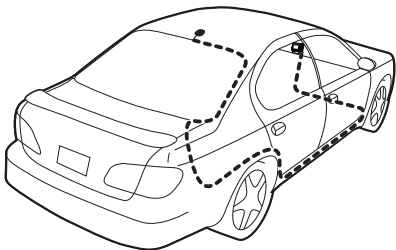

area under the interior trim, towards the front of the vehicle. Use a blunt plastic putty knife or similar blunt tool to lift the plastic trim just enough to tuck the cable under underneath. Avoid side airbag locations on back pillars and above the doors. Airbag locations are marked with "SRS" logos. Be careful not to crimp or cut the cable.

5. Bring the cable out from the trim near the front of the cabin and route it under the carpet toward the dashboard or console. Coil any excess cable in a hidden location, such as under the carpet, keeping it away from any vehicle pedals or controls. Secure the excess cable with wire ties (purchased separately).
6. Bring the end of the cable out at the *PowerConnect* Vehicle Dock location. Leave yourself enough cable so you can easily connect it to the antenna connector of the dock.
7. Continue with "Step 5: Connect the Magnetic Mount Antenna and *PowerConnect* Power Adapter" on page 39.

Vehicle Installation

- **Sedan/Coupe With Antenna Placed at the Front of the Roof:**

1. Feed the antenna cable from the antenna underneath the rubber molding around the windshield. Use a blunt plastic putty knife or similar blunt tool to lift the rubber molding around the windshield and tuck the antenna cable underneath the molding. Route the antenna cable around and down the windshield to the lowest point.
2. At the lowest corner of the windshield, route the cable out of the windshield molding and into the rubber weather stripping around the door opening. Lift the weather stripping from the opening and tuck the cable inside it, then replace the weather stripping. Run the cable inside of the weather stripping to the bottom of the door opening.
3. Pull the cable out of the weather stripping at the bottom of the door opening and route it under the carpet toward the dashboard. Coil any excess cable in a hidden location, such as under the carpet, keeping it away from any vehicle pedals or controls. Secure the excess cable with wire ties.
4. Bring the end of the cable out at the *PowerConnect Vehicle Dock* location. Leave yourself enough cable so you can easily connect it to the antenna connector of the dock.
5. Continue with "Step 5: Connect the Magnetic Mount Antenna and *PowerConnect Power Adapter*" on page 39.

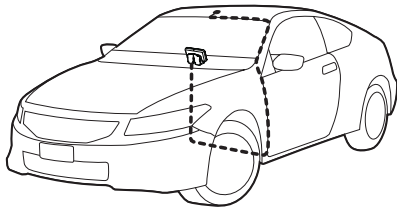

• SUV:

1. Feed the antenna cable underneath the rubber weather stripping of the rear tailgate window/door and route the cable along the rear hatch. Lift the weather stripping from the opening and tuck the cable inside it, then replace the weather stripping. Pull the cable out from weather stripping and route it into the cabin under the interior trim. Avoid hinges or gears that could crimp or cut the cable.
2. Route the cable through the SUV's main cabin area under the interior trim, towards the front of the vehicle. Use a blunt plastic putty knife or similar blunt tool to lift the plastic trim just enough to tuck the cable under underneath. Avoid side airbag locations on back pillars and above the doors. Airbag locations are marked with "SRS" logos. Be careful not to crimp or cut the cable.
3. Bring the cable out from the trim near the front of the cabin and route it under the carpet toward the dashboard or console. Coil any excess cable in a hidden location, such as under the carpet, keeping it away from any vehicle pedals

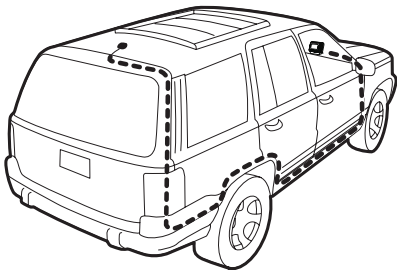

Vehicle Installation

or controls. Secure the excess cable with wire ties (purchased separately).

4. Bring the end of the cable out at the *PowerConnect* Vehicle Dock location. Leave yourself enough cable so you can easily connect it to the antenna connector of the dock.
5. Continue with "Step 5: Connect the Magnetic Mount Antenna and *PowerConnect* Power Adapter" on page 39.

• Convertible:

1. Bring the antenna cable from the antenna into the trunk at the front edge of the trunk lid. Keep any bends in the cable loose. Tape or tie the cable along the inside of the trunk lid to the trunk lid hinge strut.
2. Allow enough slack in the cable so the trunk lid can easily open and close and keep the cable away from hinges, gears, etc., that could crimp or cut it. Route the cable along the trunk wall and into the cabin through a conduit or along an existing wiring harness.
3. Route the cable through the main cabin area under the interior trim, towards the front of the vehicle. Use a blunt plastic putty knife or similar blunt tool to lift the plastic trim just enough to tuck the cable under underneath. Avoid side airbag locations on back pillars and above the doors.

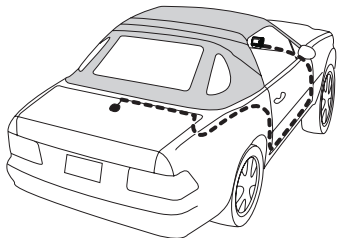

Airbag locations are marked with “SRS” logos. Be careful not to crimp or cut the cable.

4. Bring the cable out from the trim near the front of the cabin and route it under the carpet toward the dashboard or console. Coil any excess cable in a hidden location, such as under the carpet, keeping it away from any vehicle pedals or controls. Secure the excess cable with wire ties (purchased separately).
5. Bring the end of the cable out at the *PowerConnect Vehicle Dock* location. Leave yourself enough cable so you can easily connect it to the antenna connector of the dock.
6. Continue with “Step 5: Connect the Magnetic Mount Antenna and *PowerConnect Power Adapter*” on page 39.

Vehicle Installation

- **Pickup Truck:**

1. Use a blunt plastic putty knife or similar blunt tool to lift the rubber molding around the windshield and tuck the antenna cable underneath it.
2. Continue tucking the cable underneath the windshield molding around the windshield to the lowest corner.
3. At the lowest corner of the windshield, route the cable out of the windshield molding and into the rubber weather stripping around the door opening. Lift the weather stripping from the opening and tuck the cable inside it, then replace the weather stripping. Run the cable inside of the weather stripping to the bottom of the door opening.
4. Pull the cable out of the weather stripping at the bottom of the door opening and route it under the carpet toward the dashboard. Coil any excess cable in a hidden location, such as under the carpet, keeping it away from any vehicle pedals or controls. Secure the excess cable with wire ties.
5. Bring the end of the cable out at the *PowerConnect Vehicle Dock* location. Leave yourself enough cable so you can easily connect it to the antenna connector of dock.
6. Continue with "Step 5: Connect the Magnetic Mount Antenna and *PowerConnect Power Adapter*" on page 39.

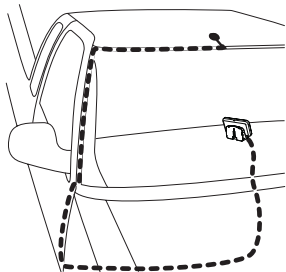

Step 5: Connect the Magnetic Mount Antenna and PowerConnect Power Adapter

- 1 Plug the Magnetic Mount Antenna into the **silver ANT** connector on the *PowerConnect* Vehicle Dock.

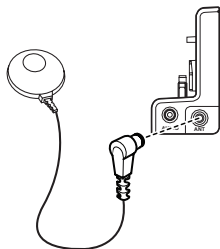

- 2 Insert the *PowerConnect* Power Adapter into your vehicle's cigarette lighter or power adapter socket.

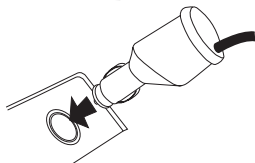

- 3 Plug the *PowerConnect* Power Adapter into the **red PWR** connector on the dock.

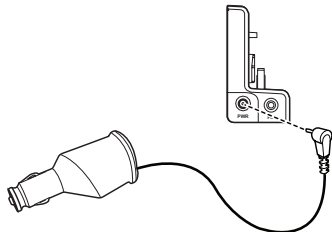

Vehicle Installation

Step 6: Connect the Audio

To play audio through your vehicle's stereo or FM radio, decide on one of the following audio connection options:

- **Option 1: Best:** Use the included **Aux In Cable** if your vehicle's stereo system has an auxiliary input connection. Refer to your vehicle's owners manual to find the location of the auxiliary input jack, or consult the vehicle dealer.



TIP! The auxiliary input jack may be located on the face plate of the vehicle radio, on the back of the radio, anywhere on the front dash panel, inside the glove compartment, or inside the center console in between the front seats.

- **Option 2: Better:** Use a **Cassette Adapter** if your vehicle has a built-in cassette player. Cassette Adapters are sold separately and can be purchased from an electronics retailer, or go to sirius.com/accessories.
- **Option 3: Good:** Use the **PowerConnect** feature in the Stratus 6. *PowerConnect* plays the audio through your vehicle's FM radio.
- **Option 4: Best:** Use the **FM Direct Adapter**. If none of the previous three audio connection options will work in your vehicle, then you will need to use the FM Direct Adapter (FMDA) (sold separately). The FMDA needs to be installed by a professional installer and directly connects your radio to your vehicle's FM radio. To learn more, check with the retailer where you bought your radio, or go to sirius.com/accessories.

Follow the installation instructions in the next several sections for the audio connection option that you have selected.