

**AGS2128G/AGS2128XG/
AGS2128G-2/AGS2128XG-2
Installation Guide**

February 2023

Contents

About this Guide.....	5
Chapter 1 AGS2128G/AGS2128XG/AGS2128G-2/ AGS2128XG-2 Overview.....	7
Site Preparation	12
Before you Begin.....	13
Introduction.....	14
Chapter 2 Installation.....	15
Installation Tips	15
Installation Variables.....	17
Unpacking the AGS2128G/AGS2128XG/AGS2128G-2/AGS2128XG-2.....	18
Tabletop Mounting Dimensions	19
Tabletop Mounting the AGS2128G/AGS2128XG/AGS2128G-2/AGS2128XG-2....	20
Routing the Fiber Pigtail	21
Wall Mounting Dimensions.....	22
Wall Mounting the AGS2128G/AGS2128XG/AGS2128G-2/AGS2128XG-2.....	23
Additional Mounting Considerations	25
Chapter 3 Final Set-up and Testing	27
AGS2128G/AGS2128XG/AGS2128G-2/AGS2128XG-2 Reset Behavior	28
Powering up the AGS2128G/AGS2128XG/AGS2128G-2/AGS2128XG-2.....	30
Connecting to the Internet - AGS2128G/AGS2128XG/AGS2128G-2/AGS2128XG-2.....	31

Appendix A.....32
LED States - Power Off and Reboot.....32
Agency Listings.....34
Specifications37
Wall Mount Drilling Template38
statement39

About this Guide

This document provides general installation practices for the AGS2128G/AGS2128XG/AGS2128G-2/AGS2128XG-2.

This document also provides a general description of the products, and guidance for planning, site preparation, power installation, splicing to the outside plant, and basic troubleshooting.

Intended Audiences

This document is intended for use by network planning engineers, outside plant engineers, field support personnel, and craft personnel responsible for installation and maintenance of premises equipment.

Federal Communications Commission (FCC) Statement

This equipment has been tested and found to comply with the limits for a Class B digital device, pursuant to part 15 of the FCC Rules. These limits are designed to provide reasonable protection against harmful interference in a residential installation. This equipment generates, uses and can radiate radio frequency energy and, if not installed and used in accordance with the instructions, may cause harmful interference to radio communications. However, there is no guarantee that interference will not occur

in a particular installation. If this equipment does cause harmful interference to radio or television reception, which can be determined by turning the equipment off and on, the user is encouraged to try to correct the interference by one or more of the following measures:

- Reorient or relocate the receiving antenna.
- Increase the separation between the equipment and receiver.
- Connect the equipment into an outlet on a circuit different from that to which the receiver is connected.
- Consult the dealer or an experienced radio/TV technician for help.

Safety Notices

This document uses the following safety notice conventions.



DANGER! Danger indicates the presence of a hazard that will cause severe personal injury or death if not avoided.



WARNING! Warning indicates the presence of a hazard that can cause severe personal injury if not avoided.



CAUTION! Caution indicates the presence of a hazard that can cause minor to moderate personal injury if not avoided.



ALERT! Alert indicates the presence of a hazard that can cause damage to equipment or software, loss of data, or service interruption if not avoided.



DANGER! Class 1 Consumer Laser Product. INVISIBLE LASER RADIATION MAY BE PRESENT. Fiber optic radiation can cause severe eye damage or blindness. Do not look into the open end of an optical fiber.

IMPORTANT SAFETY INSTRUCTIONS

When using your equipment, basic safety precautions must always be followed to reduce the risk of fire, electric shock, and injury to persons, including the following:

- Do not use this product near water. For example, near a bathtub, washbowl, kitchen sink, or laundry tub, in a wet basement, or near a swimming pool.
 - Use only the power cord indicated in this manual.
 - For external power supplies, the external power supply used in this device is to be Class II or a Limited Power Source (LPS) power supply.
-

AGS2128G/AGS2128XG/ AGS2128G-2/AGS2128XG-2 Overview

The AGS2128G/AGS2128XG/AGS2128G-2/AGS2128XG-2 is a new generation smart home system that integrates GPON or XGS ONT and residential gateway functionality into a single system. It supports GPON or XGS WAN, while providing the ultimate Wi-Fi experience. Besides supporting broadband connectivity of data and video services, this intelligent, high-performance system offers the latest 802.11ax ‘Wi-Fi 6’ technology. The AGS2128G/AGS2128XG/AGS2128G-2/AGS2128XG-2 provides switching and routing functions that support multi-Gigabit throughput for IPTV video and data services.

The AGS2128G/AGS2128XG/AGS2128G-2/AGS2128XG-2 is a premium smart home integrated system that delivers the latest Wi-Fi 6 certified technology (802.11ax). The AGS2128G/AGS2128XG/AGS2128G-2/AGS2128XG-2 integrates a GPON or XGS ONT to provide carrier-class WAN. On the LAN side, Wi-Fi and two (2) Gigabit Ethernet interfaces are available for customer multi-media devices. The AGS2128G/AGS2128XG/AGS2128G-2/AGS2128XG-2 enables residential subscribers to receive broadband data, Internet Protocol (IP) video, and voice (POTS) services. Using the latest 802.11ax technology in both the 2.4 and 5 GHz radios, the AGS2128G/AGS2128XG/AGS2128G-2/AGS2128XG-2 incorporates 4x4 streams of Wi-Fi delivery (2x2 @ 2.4 GHz and 2x2 @ 5 GHz). In addition, with multi-user multiple-input and multiple-output (MU-MIMO) and beamforming, the AGS2128G/AGS2128XG/AGS2128G-2/AGS2128XG-2 allows service providers to extend the access network inside the home and establish a strategic location for the delivery and control of broadband services.

With Wi-Fi being the de facto wireless data communication technology of choice for consumers, The AGS2128G/AGS2128XG/AGS2128G-2/AGS2128XG-2 was engineered for optimal whole-home coverage with simultaneous dual-band 2.4 GHz and 5 GHz operation and dynamic beamforming in both spectrums. Leveraging the latest Wi-Fi 6 features, the AGS2128G/AGS2128XG/AGS2128G-2/AGS2128XG-2 provides longer range, higher efficiency, and less interference compared to earlier generations of Wi-Fi technology. The AGS2128G/AGS2128XG/AGS2128G-2/AGS2128XG-2 easily delivers HD and UHD (ultra-HD) video and data throughout a subscriber’s home in an increasingly video-rich and mobile broadband environment.

With the AGS2128G/AGS2128XG/AGS2128G-2/AGS2128XG-2 integrated system, the installation and activation of services at a subscriber's premises was redefined. Using the CommandIQ® app, and a phone or laptop, a field technician can install and apply the subscriber's service profile without special equipment or assistance from the central office. Support Cloud is also provided, which allows the service provider to configure, activate and upgrade the AGS2128G/AGS2128XG/AGS2128G-2/AGS2128XG-2 quickly from a remote location using in-band management or TR-069.

Extensive troubleshooting capabilities, remote software downloads, and easy-to-use service activation features ensure that services are delivered and maintained without needless truck rolls and hardware upgrades. Deploying AGS2128G/AGS2128XG/AGS2128G-2/AGS2128XG-2 systems allows service providers to reduce their operational expenses while effectively delivering the Gigabit experience to their subscribers. GPON or XGS configuration and management is done via the OMCI protocol.

All device systems are powered by the Innovation Experience Platform. This container-based platform allows service providers to quickly change and adapt their services to embrace new technologies and offer new, value-added services. This approach can generate recurring revenue and increase subscriber satisfaction.



Key Attributes - AGS2128G/AGS2128XG/AGS2128G-2/AGS2128XG-2

Home Gateway

- Layer 2 bridge and Layer 3 routing for High Speed Internet (HSI) data and IPTV video services
- DHCP server options
- DHCP (IPoE) and PPPoE network connections
- Network Access Translation (NAT), public to private IP addressing
- Configurable IP address schemes, subnets, static-IP addresses
- DNS server
- Bridge port assignment and data traffic mappings
- Port forwarding
- Firewall and security
- Application and website filtering
- Selectable forwarding and blocking policies
- DMZ hosting
- Parental controls, time of day usage
- Denial of service (DoS) protection
- MAC filtering

- Time/Zone support
- Universal Plug-and-Play (UPnP)

WI-FI

- 2.4 GHz and 5 GHz, simultaneous dual-band
- 2.4 GHz and 5 GHz 802.11ax (Wi-Fi 6) certified, 802.11a/n/ac compatible
- 4x4 streams (2x2 @ 2.4 GHz and 2x2 @ 5 GHz)
- 2.4 GHz 802.11ax (Wi-Fi 6) certified, 802.11b/g/ac compatible
- WPA/WPA2/WPA3; WEP 64/128 bit encryption
- PuF (Physical Unclonable Functions)
- WPS push-button
- 2x2 DL/UL MU-MIMO with beamforming
- 1024 QAM; OFDMA; BSS Coloring
- DCM (Dual Carrier Modulation)
- TWT (Target Wake Time) for IoT clients

GPON or XGS WAN Interface

- Optical SC/APC connector

Gigabit Ethernet (GE) LAN interfaces:

- Two (2) ports of Multi-rate 10/100/1000 BASE-T Ethernet, auto-negotiating for residential IPTV and data services

Single Voice Line

- Carrier grade SIP, H.248 (aka Megaco)

USB port

- USB 2.0 - Type A host interface

Supports multiple data service profiles

Traffic Management and Quality of Service (QoS)

- 802.1Q VLANs
 - 802.1p service prioritization
 - Q-in-Q tagging
 - Multiple VLANs
 - DiffServ
 - Pre-defined QoS on service type
 - LAG of GE ports
 - MAP-T
-

IPTV, IGMPv2 (future support of IGMPv3)

- IGMP Snooping and Proxy
- IGMP Fast Leaves

Gateway Management

- Support Cloud
- TR-069
- Local Home Gateway GUI, access provisionable
- Remote WAN side GUI access
- Default username/password

AC to 12 VDC power adapter

Site Preparation

Before you install any device, you need to consider the routing of the power adapter cord, incoming fiber pigtail, and Ethernet or Voice cable(s) that may be in use.

Note: It is critical that you maintain the proper airflow in and around the unit. These devices are designed for surface mounting only. Do not install cabinetry or other building material around the outside of the unit.

Power Cords

In order to complete the installation, a power cord is required:

- Connectorized Power and Signal Cable - A 2-pin barrel connector to the local AC power receptacle (Type A).

Coaxial Cables

- Note that Coaxial cable connections are to be internal connections only. Outdoor connections fail to meet agency requirements.
-

Before you Begin

Before starting the installation process, check that the following conditions are met:

- Ensure the site preparation steps are complete based on the model being installed.
- Ensure that all components are on-site or readily available to complete the installation.

The customer is aware of your planned visit and will provide access to the inside of the home.

Introduction

This document describes the installation of the following:

- AGS2128G/AGS2128XG/AGS2128G-2/AGS2128XG-2

The AGS2128G/AGS2128XG/AGS2128G-2/AGS2128XG-2 is designed to be placed flat on a table-top or wall mounted using the built in mounting components as a guide.

Powering Options

- By attaching to any 110/220 VAC power outlet using the supplied 12 VDC wall transformer.

Note: The power cord configuration must be appropriate for use in the country where the AGS2128G/AGS2128XG/AGS2128G-2/AGS2128XG-2 is being deployed.

Note: Only We provided and approved power cords or voltage adapters should be used to connect to this product(s).

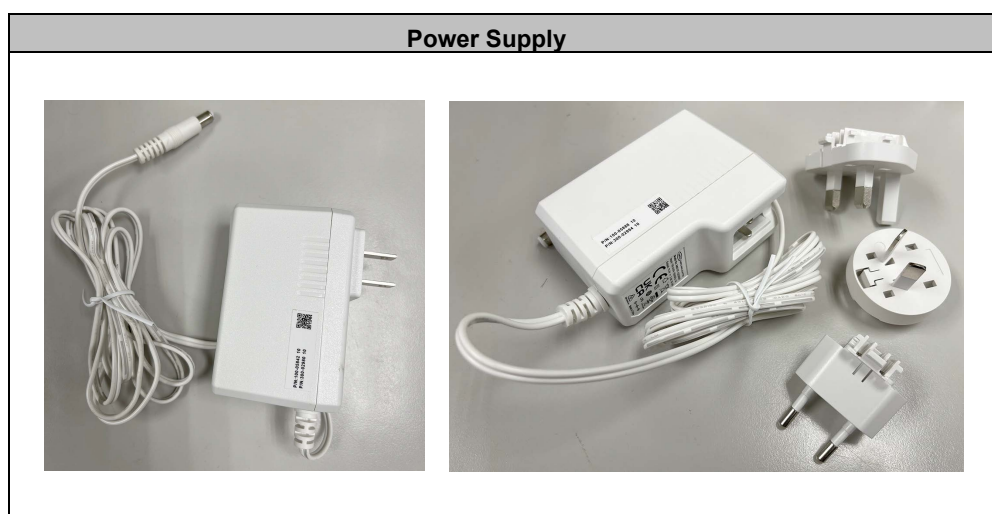
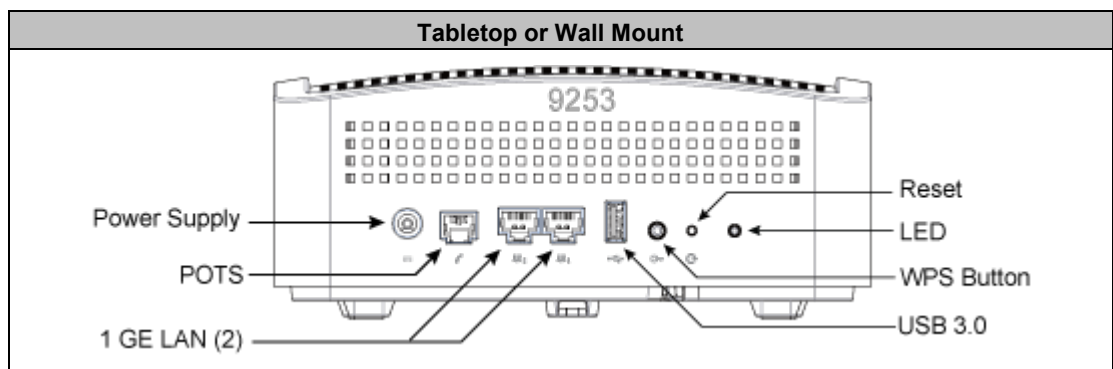

Chapter 2

Installation

Installation Tips



CAUTION! Use of controls or adjustments or performance of procedures other than those specified here may result in hazardous radiation exposure.

Follow these tips when installing a AGS2128G/AGS2128XG/AGS2128G-2/AGS2128XG-2 device:

- For subscribers using data services, all data wiring inside the home must be CAT5 cable or better.
- Make sure subscriber connections are tightened properly.
- Check the contents of each box carefully as you receive them. Components may not be located where you might expect them due to certain items being tested immediately before shipment.

About Wi-Fi Placement

Certain building materials are particularly effective at blocking Wi-Fi signals (see table below) and should be taken into consideration when locating the AGS2128G/AGS2128XG/AGS2128G-2/AGS2128XG-2. Line of sight is not necessary since MIMO technology takes advantage of reflections in the over-the-air path to carry additional data. However, it is recommended that when possible, the device should be placed in a centralized location within the home to yield the best possible results for Wi-Fi coverage.

For reference, the construction materials listed below vary in the amount of attenuation that exists:

Building Materials and Their Effect on Wi-Fi Signals	
Material	Wi-Fi Attenuation
Wood, Drywall, Particle Board, Tile	Low
Glass	Low
Water	Medium
Bricks, Cinder Block	Medium
Plaster, Stucco	High
Concrete	High
Tinted or Low-E Glass (metalized)	Very High
Metal	Very High
Note: The lower the attenuation, the better the performance.	

Installation Variables

Before installing a AGS2128G/AGS2128XG/AGS2128G-2/AGS2128XG-2, consider what additional services may be implemented. Various access points are available on the back or the bottom of the unit which may or may not be used. Prior to determining the unit's final location, you need to account for the following variables:

- Optional: Where will any Ethernet cables be routed?
- Where will the fiber pigtail be routed.
- What type of building material is used in this facility? Make sure you have the appropriate drills, drill bits and fasteners for routing Ethernet or power cables as they pass through walls and the like.

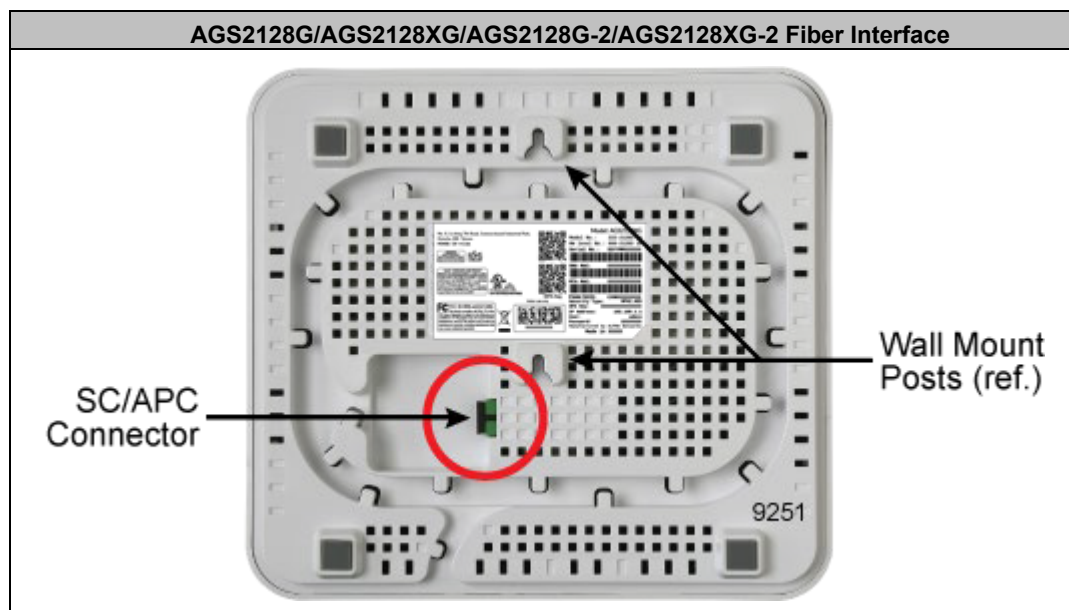
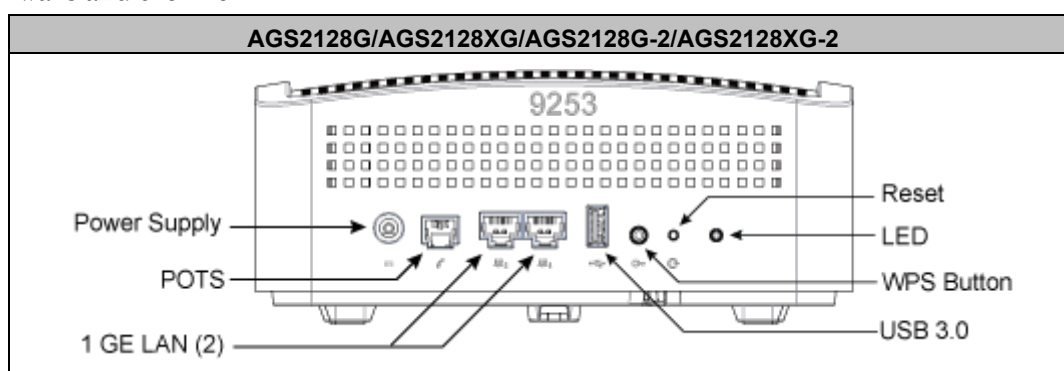

Unpacking the AGS2128G/AGS2128XG/ AGS2128G-2/AGS2128XG-2

Each device is shipped individually in its own carton and contains the following:

- (1) AGS2128G/AGS2128XG/AGS2128G-2/AGS2128XG-2
- (1) Power Adapter interface cord (wall wart)
- (1) Safety and Regulatory Statements Guide
- (2) Product Identification Labels with Login Credentials
- Wall Mount Drilling Template

After opening the carton, remove the protective packaging, ensure all components above are present, and prepare for mounting the unit.

Tabletop Mounting Dimensions

Dimensions are shown here for your reference.

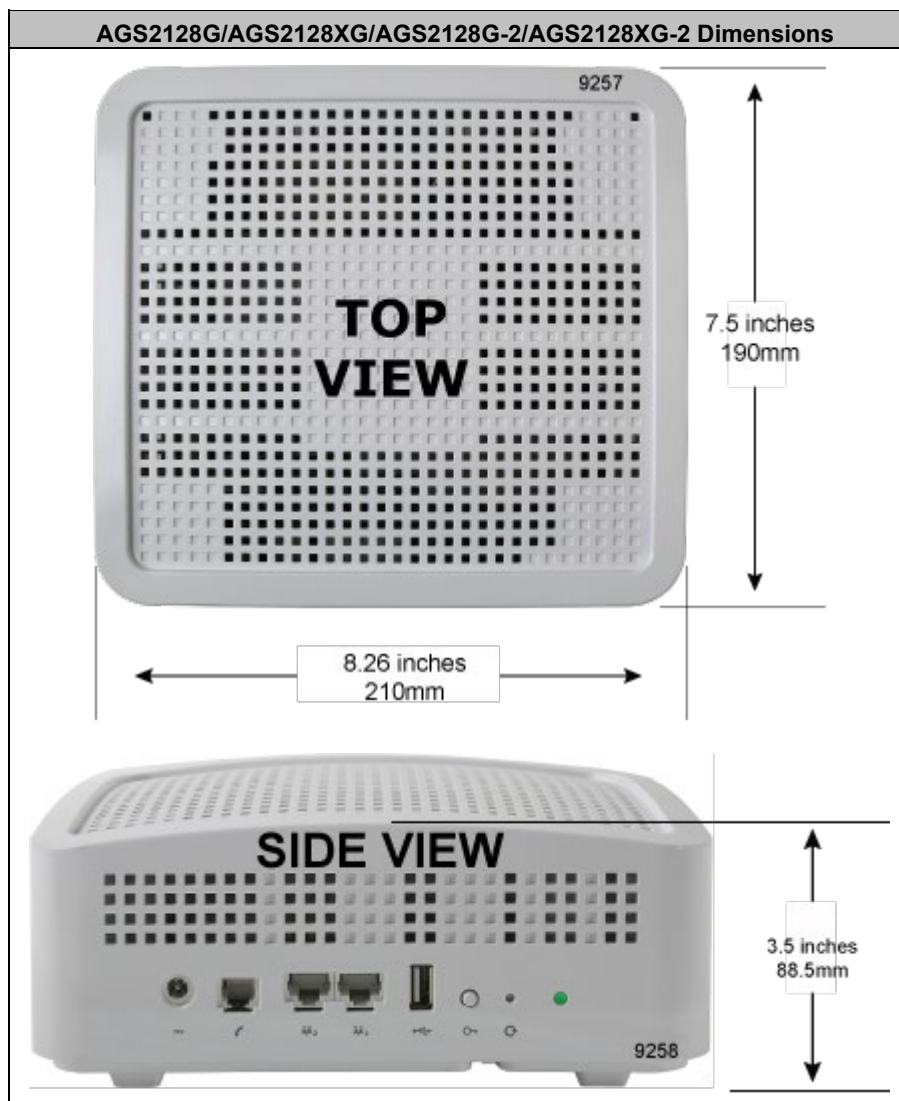

Tabletop Mounting the AGS2128G/AGS2128XG/ AGS2128G-2/AGS2128XG-2

Any AGS2128G/AGS2128XG/AGS2128G-2/AGS2128XG-2 can be mounted flat on a tabletop. Four (4) rubberized feet are pre-installed on the bottom of the unit to provide a non-skid surface when placing the unit on a table or shelf.

Keep the following information in mind when considering tabletop mounting:

- Due to component placement inside the chassis and under the AGS2128G/AGS2128XG/AGS2128G-2/AGS2128XG-2, do not remove the rubber feet that are installed on the bottom of the unit. Locate the device on the desktop in a location that is unlikely to be bumped or jostled.
- Make sure that the Ethernet cable[s] (if used), POTS line, fiber pigtail, and power supply wiring attached to the device are secured properly and out of harms way.

Note: Once the unit is connected and turned up, Wi-Fi network parameters are persisted in memory. For this reason, if power is lost to the device, it will be re-discovered on the network automatically, without operator intervention.

Routing the Fiber Pigtail

The fiber interface for the AGS2128G/AGS2128XG/AGS2128G-2/AGS2128XG-2 is located on the bottom of the unit. The SC/APC connector is embedded (but visible) within an alcove with fiber raceways built in to assist in routing the fiber safely.

The illustration below shows the preferred routing for the AGS2128G/AGS2128XG/AGS2128G-2/AGS2128XG-2.

Critical Variables

- Allow for two complete wraps of fiber around the fiber raceway. Storing extra fiber as shown ensures that the pigtail selected for deployment has enough slack without having to deal with extra fiber.
- Make sure excessive bends in the fiber are not present. Refer to the fiber manufacturer's bend radius standards for specific information.
- Ensure that any wall mounting fasteners do not interfere with fiber routing.

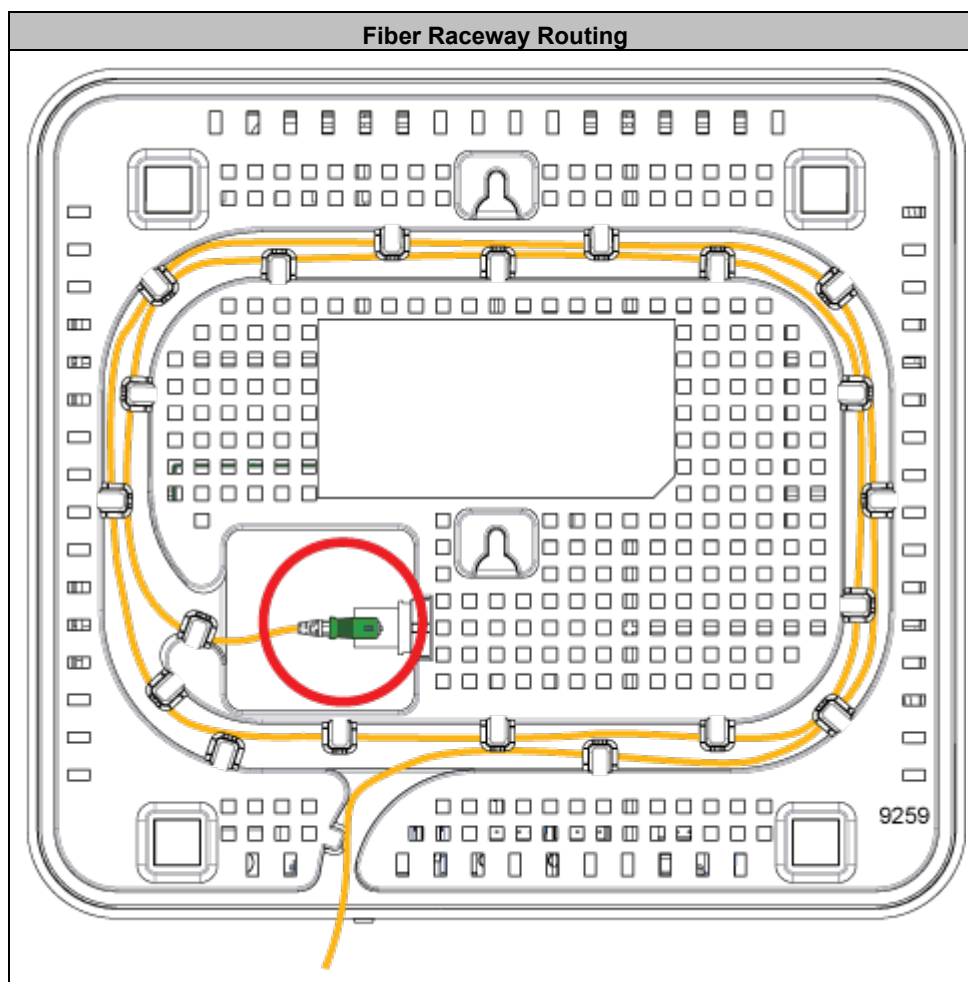

Wall Mounting Dimensions

Dimensions for wall mounting of a AGS2128G/AGS2128XG/AGS2128G-2/AGS2128XG-2 are included here for reference.

Note: There is no wall mount bracket necessary to mount this device. The bottom chassis itself includes appropriate cut-outs and hanger posts to facilitate wall mounting.

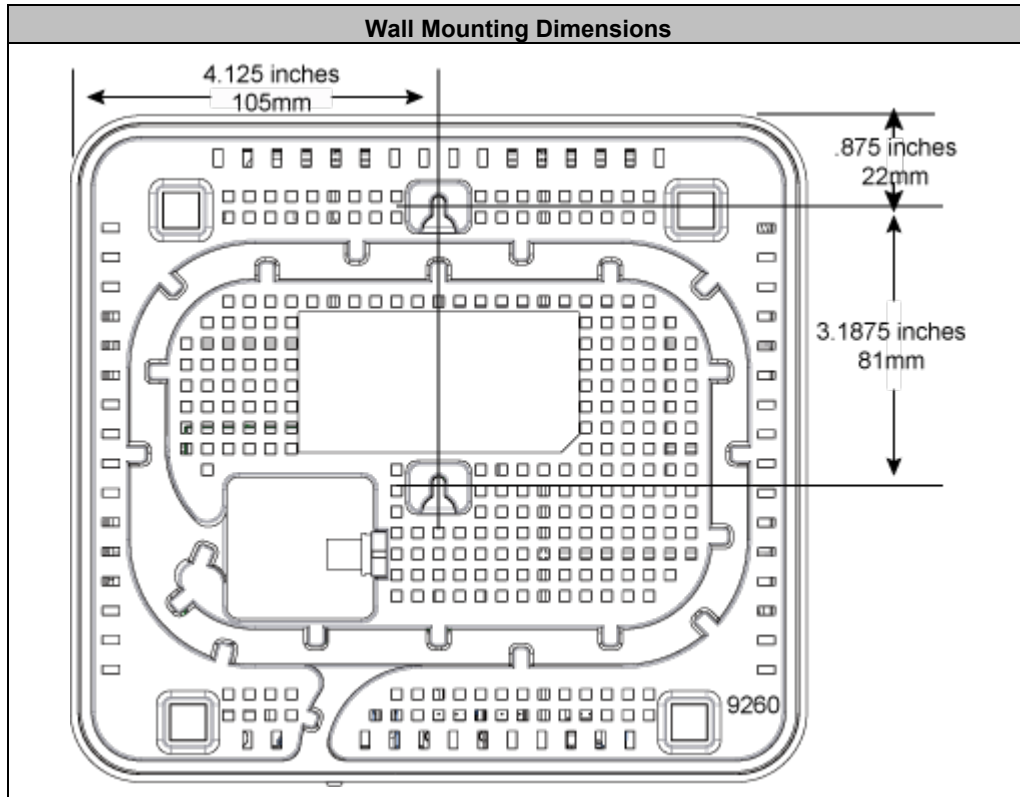

Wall Mounting the AGS2128G/AGS2128XG/ AGS2128G-2/AGS2128XG-2

The AGS2128G/AGS2128XG/AGS2128G-2/AGS2128XG-2 can be wall mounted. Keep the following information in mind when considering wall mounting:

- Locate the device on the wall in a location that is unlikely to be bumped or jostled.
- Make sure that the Ethernet cable(s) (if used) and power supply wiring attached to the device are secured properly and out of harms way.

Note: Once the device is connected and turned up, Wi-Fi network parameters are persisted in memory. For this reason, if power is lost to the device, it will be re-discovered on the network automatically, without operator intervention.

To wall mount the AGS2128G/AGS2128XG/AGS2128G-2/AGS2128XG-2

1. Find a suitable location for attaching the unit to the wall. Be mindful of the power source and Ethernet cable requirements when determining a mounting location.
2. Using the template included in the back of this guide, mark the two screw locations on the wall, making sure the device will remain level after mounting.

Note: If attaching to sheet rock or gypsum board, a wall anchoring system is recommended to ensure the bracket is securely attached to the wall. For wood attachment, wall anchors are not required.

3. Drill holes in the wall and install appropriate wall anchors if required.
 4. Thread the screws into the wall anchors and tighten leaving a gap of about 1/8" between the screw head and the back of the unit. This allow you to slip the AGS2128G/AGS2128XG/AGS2128G-2/AGS2128XG-2 over the mounting screws and pulling down to secure it to the wall.
-

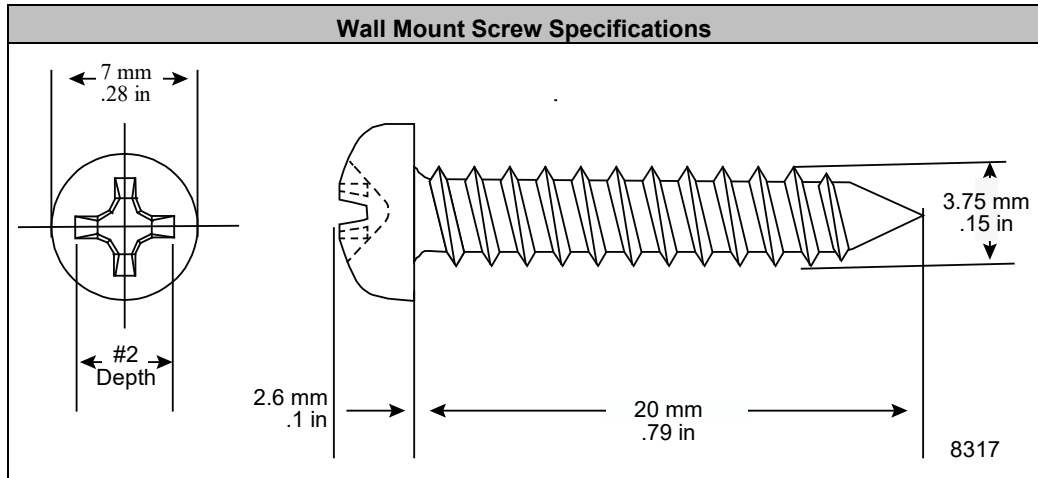

Mounting Screws

Depending on the material you are attaching to, use a screw of sufficient length and strength to support the device once attached to the bracket. See below for specifications on what type of screw is recommended.

The two mounting holes on the back of the unit are designed to accommodate the following screw type:

- Larger than 7mm wide (.28") and less than 14mm wide (.55")
- Screw shaft < 3mm in diameter (.12")
- Screw length > 6mm (.24") and less than 20mm long (.79")

Additional Mounting Considerations

The options for mounting a device system are many. From a best practice's standpoint, keep the following in mind:

- Recommendation is to mount the device as high as possible for Wi-Fi performance reasons. However, this deployment scenario still mandates that an AC power outlet is located within the power cord distance of the Wi-Fi source. If installing in a greenfield environment (initial installation), plan on placing the device within 4 feet of the power supply. As an alternative, longer power cords are available to extend the distance between the device and the power supply.
 - It is also recommended to keep cabling neat and well secured. A tidy installation allows for increased safety and an overall neater appearance. Common tools used for this purpose include cable ties and velcro straps for routing cable out of the way. Also, custom made wall plates are often used where the majority of cabling is hidden behind a wall.
 - It is also recommended to install the device at least 6 inches away from the upstream network equipment (DSL modem, cable modem, ONT, and the like).
-

Chapter 3

Final Set-up and Testing



AGS2128G/AGS2128XG/AGS2128G-2/AGS2128XG-2

Reset Behavior

EDGE systems support a variety of system reset functions and provide multiple methods for invoking each of these functions, as described in this topic.

These functions and behaviors are defined as follows:

- 1. Basic reset (reboot):** Restarts the unit.
- 2. Configuration reset:** Resets the RG configuration settings (those visible to the subscriber/Admin user in the EWI, such as SSIDs, LAN IP scope, etc.) to defaults, but retains operator-configured management settings (those visible only to the Support user in the EWI, such as ACS URL and SPID).
- 3. Factory reset:** Resets the router to factory default settings. A factory reset also removes devices from network management systems such as Support Cloud and the Smart Home Admin Dashboard, where applicable.

These reset functions can be used as troubleshooting and/or operations tools for reset/removal scenarios, whether the device is deployed as a Residential Gateway or as a subtended WAP. Hardware-invoked resets behave differently depending on how long the reset button is pressed, as described below.

Function	Where Performed
Basic Reset ¹	Hardware: Press Reset button once for 1 second
	Software: EWI > Utilities > Reboot
Configuration Reset ²	Hardware: Press and hold Reset button for 15+ seconds
	Software: EWI > Utilities > Restore Defaults
Factory Reset	Hardware: no option
	Software (for support user only): EWI > Support > Tools > Smart Activate > Factory Reset
<p>Note: For operators with cloud based network management systems, remote resets can be invoked as follows:</p> <p>1 (https://www.calix.com/content/calix/en/site-prod/library-html/software-products/cloud/nm/support/help/index.htm#88688.htm) System Tools > Reboot (https://www.calix.com/content/dam/calix/mycalix-misc/lib/cloud/help/csc-e/106206.htm)</p> <p>2 System Tools > Factory Reset (https://www.calix.com/content/dam/calix/mycalix-misc/lib/cloud/help/csc-e/106206.htm) option actually performs just a configuration reset</p>	

The table below provides additional notes for each Reset event:

AGS2128G/AGS2128XG/AGS2128G-2/AGS2128XG-2 Reset Behavior			
Reset Type	How Invoked	Expected Behavior	Notes
Basic Reset - Hardware	Press Reset button	<ul style="list-style-type: none"> Router or satellite reboots RG configuration and subscriber's custom settings persist 	Pressing the Reset button performs a standard power cycle. All configuration information persists. Device goes off-line for 2-3 minutes while it completes the reboot process.
Basic Reset - Software	EWI > Utilities > Reboot	<ul style="list-style-type: none"> Router reboots RG configuration and subscriber's custom settings persist 	Subscriber (Admin user) has access to the EWI to invoke a soft reset. All configuration information persists. Device goes off-line for 2-3 minutes while reboot process completes.
Configuration Reset - Hardware	Press and hold Reset button (10+ seconds)	<ul style="list-style-type: none"> Router or satellite reboots RG configuration and subscriber's custom settings reset to defaults Service provider applied management settings persist 	Reset button must be pressed and held until LEDs flash (after about 10 seconds). Device goes off-line while it completes the reboot process. Residential Gateway (RG) configuration settings include all subscriber-configurable information such as login credentials for Admin user, SSIDs, LAN IP scope, etc., all of which reset to defaults.
Configuration Reset - Software	EWI > Utilities > Restore Defaults	<ul style="list-style-type: none"> Router reboots RG configuration and subscriber's custom settings reset to defaults Service provider applied management settings persist 	Subscriber (Admin user) has access to the EWI to invoke a configuration reset. Device goes off-line while it completes the reboot process. Residential Gateway (RG) configuration settings include all subscriber-configurable information such as login credentials for Admin user, SSIDs, LAN IP scope, etc., all of which reset to defaults.
Factory Reset - Software	EWI > Support Menu > Tools > Smart Activate > Factory Reset	<ul style="list-style-type: none"> Router reboots RG configuration settings reset to factory defaults Service provider applied management settings reset to factory defaults 	Function available only to operators via EWI Support user (not available to subscriber/Admin user). Service provider management settings include all information visible on the EWI Support tab, such as login credentials for Support user, TR-69 ACS URL and login credentials, SPID, etc., all of which reset to defaults.

Powering up the AGS2128G/AGS2128XG/ AGS2128G-2/AGS2128XG-2

To power up the AGS2128G/AGS2128XG/AGS2128G-2/AGS2128XG-2

- 1.** Locate the 12 VDC Power Adapter inside the packaging of the AGS2128G/AGS2128XG/AGS2128G-2/AGS2128XG-2
 - 2.** Attach one end (8-pin (2 x 4) connector) to the rear of the AGS2128G/AGS2128XG/AGS2128G-2/AGS2128XG-2.
 - 3.** Plug the other end into any available 110/220 VAC wall outlet.
 - 4.** Depress the power on/off toggle switch - the AGS2128G/AGS2128XG/AGS2128G-2/AGS2128XG-2 begins the power-up sequence.
-

Connecting to the Internet - AGS2128G/AGS2128XG/ AGS2128G-2/AGS2128XG-2

The method by which the AGS2128G/AGS2128XG/AGS2128G-2/AGS2128XG-2 is deployed will impact the internet connection. With power applied to the device, perform the following steps based on the role the device plays in the network.

Connecting to a residential gateway

If the unit is configured as a Residential Gateway, connect an Ethernet Cable to its WAN port from the WAN modem (ONU, cable modem, or DSL modem).

Additional Comments



- Once your units LED turns BLUE, you are connected to the upstream WAN modem.
 - At start-up, Wi-Fi radios are defaulted to on.
 - To configure your device, connect an Ethernet cable between your PC and the LAN port of your unit and enter the default IP Address of the device (192.168.1.1) into your browser.
 - Wi-Fi radios can be configured using the default settings:
 - SSID: Printed on the product label in the gift box. (xxxxxxxxxxxx)
 - Number of radios: 2 (2.4 GHz and 5 GHz)
 - Wi-Fi Protocol supported: 802.11a/b/n/g/ac/ax
 - Credentials: Login and password printed on the product label in the gift box.
-

Appendix

LED States - Power Off and Reboot

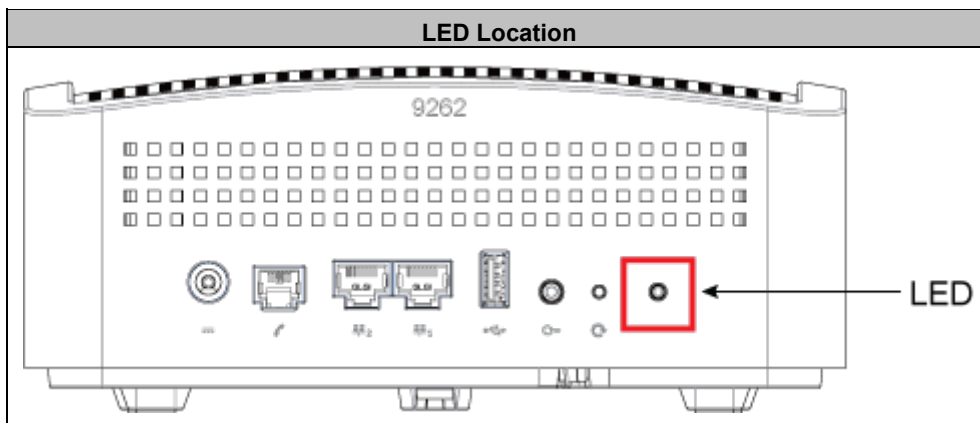
Note: For all LED sequences, the AGS2128G/AGS2128XG/AGS2128G-2/AGS2128XG-2 interface side of the unit.

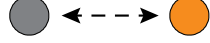
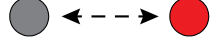

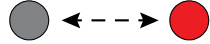
Power Off and Boot-up - RG Mode		
Description	Colors	Indication
<p>OFF</p> <ul style="list-style-type: none"> Power is Off The unit has not been turned on <p>or</p> <ul style="list-style-type: none"> There is no power to the unit <p>or</p> <ul style="list-style-type: none"> Any auxiliary battery has been discharged and can no longer power the unit. 	Off	
<p>Boot-up, SW Upgrade in Process</p> <ul style="list-style-type: none"> Unit is in the process of booting up or services/software is being upgraded Flashing amber every 1 second assuming software can control the LED 	Off & Amber Cycles @ 1000 msec	
<ul style="list-style-type: none"> Boot-up Failure Unit boot-up has failed (assuming software can control the LED). 	Off & Red Cycles @ 800 msec	
<ul style="list-style-type: none"> Connected to the Internet Unit has successfully booted up, local services are up, and connected to Internet 	Green	
<ul style="list-style-type: none"> Service Failure - No Internet No service, no internet access 	Off & Red Cycles @ 1600 msec	

Agency Listings

FCC WARNING: These devices comply with Part 15 of the FCC Rules and Regulations. Operation is subject to the following conditions.

This device may not cause harmful interference, and, this device must accept any interference received, including interference that may cause undesired operation.

This equipment has been tested and found to comply with the limits for a Class B digital device, pursuant to part 15 of the FCC Rules. These limits are designed to provide reasonable protection against harmful interference in a residential installation. This equipment generates, uses and can radiate radio frequency energy and, if not installed and used in accordance with the instructions, may cause harmful interference to radio communications. However, there is no guarantee that interference will not occur

in a particular installation. If this equipment does cause harmful interference to radio or television reception, which can be determined by turning the equipment off and on, the user is encouraged to try to correct the interference by one or more of the following measures:

- Reorient or relocate the receiving antenna.
- Increase the separation between the equipment and receiver.
- Connect the equipment into an outlet on a circuit different from that to which the receiver is connected.
- Consult the dealer or an experienced radio/TV technician for help.

Hazardous Materials

There are no hazardous materials identified for the AGS2128G/AGS2128XG/
AGS2128G-2/AGS2128XG-2.

Application Standards

Following is a list of standards that apply to this product:

Standards		
FCC Part 15, Sub Part B, class B	UL 62368-1	EN 300 328
CAN ICES-003 Class B	CSA C22.2 No. 62368-1	EN 301 893
ANSI C63.4	IEC 62368-1, IEC 60825-1 EN 60825-1: 2014/ A11:2021 + EN 50689:2021 & IEC 60825-1: 2014	EN 301 489-1
FCC Part 15.247	ITU-T K21	EN 301 489-17
FCC Part 15.203	ITU-T K44	EN 55032 Class B
FCC Part 15.207	EN 62368-1	EN 61000-3-2
FCC Part 15. 209	IC: 4833A-AGS2128G	EN 61000-3-3
FCC ID: RRK-AGS2128G	EN 62311	EN 50581
RSS 102	CE / RED, RoHS, WEEE, Energy	USB 2.0 Type A
RSS 247	Telcordia GR-63	EN 50564
FCC Part 15.407	Telcordia-GR-1089	CISPR 32 Class B
NEC(National Electrical Code)	Telcordia GR-950	IEEE: 802.3, 802.3AB, 302.3U, 802.11p, 802.11Q
Telcordia GR-909	Telcordia GR-1244	RCM
Telcordia GR-49		Telcordia GR-2890
Wi-Fi Alliance Certified 802.11ax		CISPR-22
 Industry Canada	 ™	 I.T.E. E164374

Product Labeling
<p>CLASS 1 CONSUMER LASER PRODUCT PRODUIT DE CONSOMMATION À LASER CLASSE 1</p> <p>Complies with 21 CFR 1040.10 and 1040.11 except for conformance with IEC60825-1 Ed. 3., as described in Laser Notice No. 56, dated May 8, 2019. Conforme au 21 CFR 1040.10 et au 1040.11, à l'exception de la conformité au IEC60825 3e éd., comme décrit dans « Laser Notice No. 56 » du 8 mai 2019.</p>

Radiated Emissions

- This Class-B digital device complies with radiated emissions requirements as defined in Canadian ICES-003.

Power Supply

Note: When using the standard power adapter, units will be inoperable after loss of main power.

- The unit must be powered by a listed power adapter or DC power source marked "LPS" (Limited Power Source) and rated output between 12 VDC, 2 A minimum, TMA = 40°C minimum. If additional help is needed on implementing a power supply, please contact your local service professional.

An external power supply is included with the following



rating: **AGS2128G/AGS2128XG/AGS2128G-2/AGS2128XG-2**

- Input voltage: 100 - 240 VAC (nominal)
- Output voltage: 10 VDC (min.), 15 VDC (max), 12 VDC (nominal)
- External Power Adapter: 12 VDC, 2.5 A



DANGER! Using non-approved or incorrect power adapters can result in injury.

Specifications

AGS2128G/AGS2128XG/AGS2128G-2/AGS2128XG-2 Specifications		
Dimensions	Wireless	Certification and Compliance
<ul style="list-style-type: none"> Width: 8.3 inches (210 mm) 	<ul style="list-style-type: none"> 2.4 GHz 802.11 b/g/n/ac/ax 2x2 UL/DL MU-MIMO 	<ul style="list-style-type: none"> Emissions: FCC Part 15 Class B, IC ICES-003 Class B, CISPR-22
<ul style="list-style-type: none"> Height: 3.3 inches (83 mm) 	<ul style="list-style-type: none"> 5 GHz 802.11 a/n/ac/ax 2x2 UL/ DL MU-MIMO, Explicit high power, dynamic beamforming 	<ul style="list-style-type: none"> Safety: UL 62368 and UL 1697 approved
<ul style="list-style-type: none"> Depth: 7.5 inches (191 mm) 	<ul style="list-style-type: none"> 2.4 GHz and 5 GHz simultaneous DCM, TWT, extended GI 	<ul style="list-style-type: none"> IEEE: 802.3, 802.3AB, 802.3U, 802.11p, 802.11Q
<ul style="list-style-type: none"> Weight: 4.4 pounds (2 kg) 	<ul style="list-style-type: none"> Auto channel selecting and interference detection 	<ul style="list-style-type: none"> Wi-Fi Alliance Certified 802.11ax (Wi-Fi 6)
WAN Interface	<ul style="list-style-type: none"> WPS, WPS push button 	
<ul style="list-style-type: none"> Interface: GPON or XGS SC/APC 	<ul style="list-style-type: none"> Wi-Fi multimedia (WMM) 	USB-IF Compliance USB 2.0
Interfaces	<ul style="list-style-type: none"> 802.11k, 802.11v, 802.11r 	
<ul style="list-style-type: none"> Wireless: 2.4 GHz 2x2 and 5 GHz 2x2 internal antennas 	<ul style="list-style-type: none"> Supports up to 200 wireless clients 	Powering and Alarms
<ul style="list-style-type: none"> LAN Data/IPTV: Two (2) 10/100/1000 BASE-T Ethernet ports, RJ 45 connectors 	<ul style="list-style-type: none"> US Wi-Fi Output Power: 30 dBm EU: ETSI Wi-Fi Output Power compliant 	<ul style="list-style-type: none"> Single pin
<ul style="list-style-type: none"> WAN: GPON or XGS SC/APC 	Remote Management	<ul style="list-style-type: none"> Input voltage: 12 VDC (nominal)
<ul style="list-style-type: none"> USB: USB 2.0 Type A 	<ul style="list-style-type: none"> TR-069 remote management 	<ul style="list-style-type: none"> External Power Adapter: 12 V DC, 3A
<ul style="list-style-type: none"> Voice: One port supporting Metaswitch and Genband; C15; C20 SIP; H.248 	<ul style="list-style-type: none"> TR-098 Internet Gateway Device Data Model 	
<ul style="list-style-type: none"> Power: Single-pin barrel connector 	Environmental	
<ul style="list-style-type: none"> WPS Switch: Push-button actuator 	<ul style="list-style-type: none"> Operating temperature: Indoor ambient temperature, 0° to 40°C (32° to 104° F) 	
<ul style="list-style-type: none"> Reset button for factory default 	<ul style="list-style-type: none"> Operating and storage relative humidity: 10 to 90 % and 5 to 95% non-condensing respectively 	
Data		
<ul style="list-style-type: none"> Drop length: 328 feet (100 m) maximum using CAT5/6 cable for GigE 		
<ul style="list-style-type: none"> Auto MDI/MDIX crossover for 1000BASE-TX, 100BASE-TX 		
<ul style="list-style-type: none"> Traffic Management and QoS: 802.11Q VLAN; 802.11p voice, video, data and management priorities; Q-in-Q tagging 		

Wall Mount Drilling Template

Shipped inside the giftbox of the AGS2128G/AGS2128XG/AGS2128G-2/AGS2128XG-2, a wall mount drilling template has been inserted. This same size template is designed for use when pre-drilling of the mounting screws is desired. The image below is a mock-up of the drilling template and must not be used when pre-drilling the mounting holes.

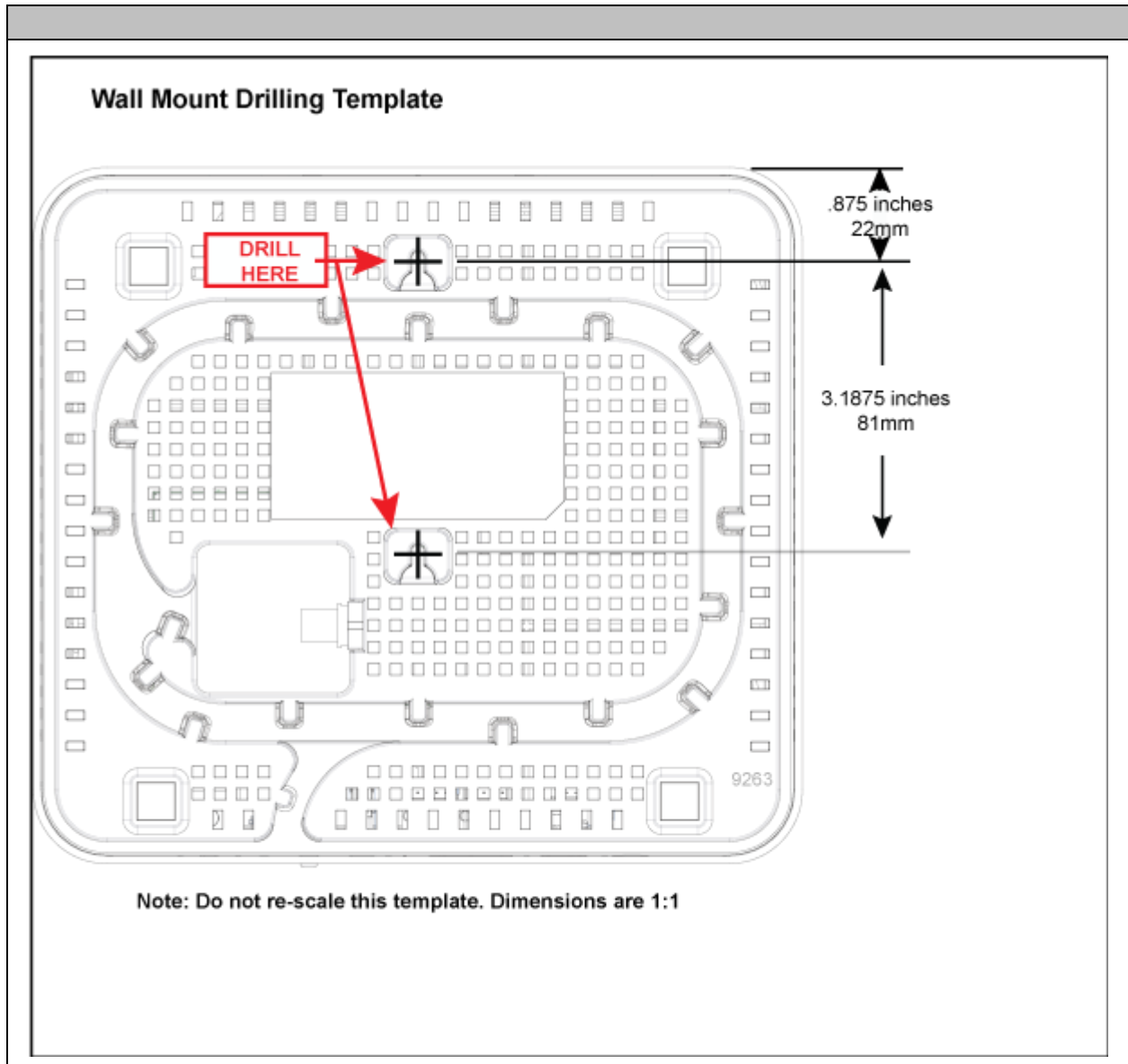

statement

Federal Communications Commission (FCC)

INTERFERENCE STATEMENT

This device complies with Part 15 of the FCC Rules. Operation is subject to the following two conditions: (1) This device may not cause harmful interference, and (2) this device must accept any interference received, including interference that may cause undesired operation.

This equipment has been tested and found to comply with the limits for a Class B digital device, pursuant to Part 15 of the FCC Rules. These limits are designed to provide reasonable protection against harmful interference in a residential installation. This equipment generates, uses and can radiate radio frequency energy and, if not installed and used in accordance with the instructions, may cause harmful interference to radio communications. However, there is no guarantee that interference will not occur in a particular installation. If this equipment does cause harmful interference to radio or television reception, which can be determined by turning the equipment off and on, the user is encouraged to try to correct the interference by one of the following measures:

- Reorient or relocate the receiving antenna.
- Increase the separation between the equipment and receiver.
- Connect the equipment into an outlet on a circuit different from that to which the receiver is connected.
- Consult the dealer or an experienced radio/TV technician for help.

FCC CAUTION: Any changes or modifications not expressly approved by the party responsible for compliance could void the user's authority to operate this equipment.

This transmitter must not be co-located or operating in conjunction with any other antenna or transmitter.

FCC regulations restrict the operation of this device to indoor use only.

FCC RADIATION EXPOSURE STATEMENT

This equipment complies with FCC radiation exposure limits set forth for an uncontrolled environment. This equipment should be installed and operated with minimum distance 20 cm between the radiator & your body.

Innovation, Science, and Economic Development Canada

This device contains licence-exempt transmitter(s)/receiver(s) that comply with Innovation, Science and Economic Development Canada's licence-exempt RSS(s). Operation is subject to the following two conditions:

- (1) This device may not cause interference.
- (2) This device must accept any interference, including interference that may cause undesired operation of the device.

L'émetteur/récepteur exempt de licence contenu dans le présent appareil est conforme aux CNR d'Innovation, Sciences et Développement économique Canada applicables aux appareils radio exempts de licence. L'exploitation est autorisée aux deux conditions suivantes:

- (1) *L'appareil ne doit pas produire de brouillage*
- (2) *L'appareil doit accepter tout brouillage radioélectrique subi, même si le brouillage est susceptible d'en compromettre le fonctionnement*

CAUTION:

- (i) The device for operation in the band 5150–5250 MHz is only for indoor use to reduce the potential for harmful interference to co-channel mobile satellite systems;
- (ii) where applicable, antenna type(s), antenna models(s), and worst-case tilt angle(s) necessary to remain compliant with the e.i.r.p. elevation mask requirement set forth in section 6.2.2.3 shall be clearly indicated.

AVERTISSEMENT:

- (i) *les dispositifs fonctionnant dans la bande de 5150 à 5250 MHz sont réservés uniquement pour une utilisation à l'intérieur afin de réduire les risques de brouillage préjudiciable aux systèmes de satellites mobiles utilisant les mêmes canaux Note de bas de;*
- (ii) *lorsqu'il y a lieu, les types d'antennes (s'il y en a plusieurs), les numéros de modèle de l'antenne et les pires angles d'inclinaison nécessaires pour rester conforme à l'exigence de la p.i.r.e. applicable au masque d'élévation, énoncée à la section 6.2.2.3, doivent être clairement indiqués.*

Radiation Exposure Statement

This equipment complies with ISED radiation exposure limits set forth for an uncontrolled environment. This equipment should be installed and operated with greater than 28 cm between the radiator and your body.

Déclaration d'exposition aux radiations:

Cet équipement est conforme aux limites d'exposition aux rayonnements ISDE établies pour un environnement non contrôlé. Cet équipement doit être installé et utilisé à plus de 28 cm entre le radiateur et votre corps.