

Panasonic®

User's Guide Wireless LAN Access Point

Model No. **EA-7HW02AP1**
EA-7HW03AP1

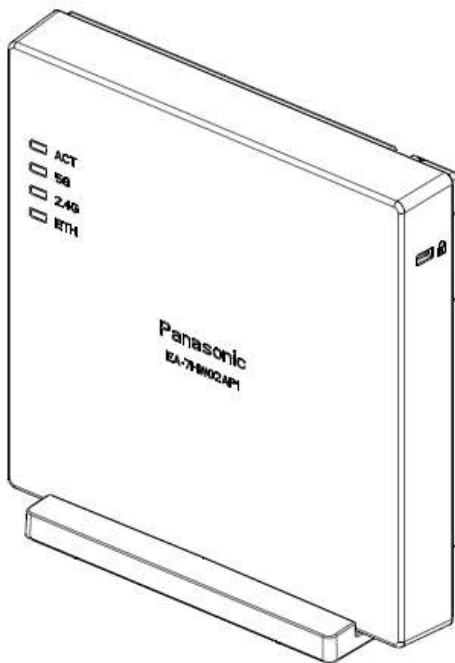

Wireless LAN Access Point (wave1)
EA-7HW02AP1

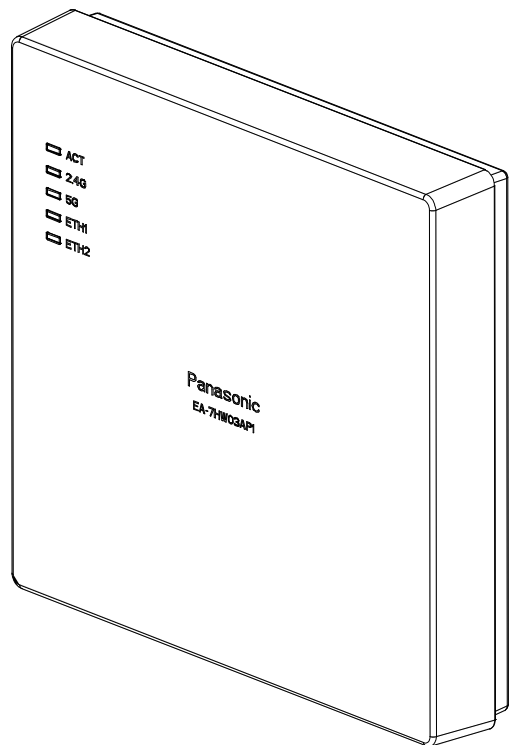

Wireless LAN Access Point (wave2)
EA-7HW03AP1

Before operating this product, please read the instructions carefully and save this manual for future use.

Introduction

Thank you for purchasing the Panasonic Enterprise Wireless LAN Access Point.

This User's Guide described the instructions for the Enterprise Wireless LAN Access Point.

Before connecting, operating or adjusting this product, please read these instructions completely, and save this manual for future use.

■ Trademarks and registered trademarks

- Wi-Fi is a trademark of the Wi-Fi Alliance.
- Ethernet is a trademark of Fuji Xerox Co.,Ltd.
- All other company names and product names in this document are trademarks or registered trademarks of their respective companies.

■ Notice

- The content of this document is subject to change without notice to improve.
- All of "Access point", "AP", "Wireless unit", "EA-7HW02AP1" and "EA-7HW03AP1" indicate Wi-Fi base station for business use.
- "PoE injector" indicates the option item "EA-7HW00PWR1".
- "PoE power feeding device" indicates the option item "EA-7HW00PWR1" or a PoE injector/power feeding hub on the market.

■ Disclaimers

- Panasonic shall have no liability for any economic damage resulting from communication loss or recording failure caused by a fault, malfunction, failure of this product or by external factors upon power outage.
- Panasonic shall have no liability for any damage caused by disaster such as earthquakes, lightnings, storm and floods, fire, actions by a third party, other incidents, accidents arising from customers' intentional or negligent misuse and use under abnormal conditions, and for any incidental loss arising from availability or unavailability of this product.
- This product is not intended to be used with any medical equipments, life-support systems, air traffic control devices and any other device, equipments and systems involving human lives. Panasonic shall have no liability for any damage and loss caused by using this product with these devices, equipments and systems.

Safety Precautions

To prevent severe injury and loss of life/property, read this section carefully before using the unit to ensure proper and safe operation of your unit.

WARNING:

- Changes or modifications not expressly approved by the party responsible for compliance could void the user's authority to operate this equipment.
- To prevent injury, this apparatus must be securely attached to the wall/ceiling in accordance with the installation instructions.
- All work related to the installation of this product should be made by qualified service personnel or system installers.
- The installation shall be carried out in accordance with all applicable installation rules.
- The connections should comply with local electrical code.

CAUTION:

Compliance with FCC requirement 15.407(c)

Data transmission is always initiated by software, which is then passed down through the MAC, through the digital and analog baseband, and finally to the RF chip. Several special packets are initiated by the MAC. These are the only ways the digital baseband portion will turn on the RF transmitter, which it then turns off at the end of the packet. Therefore, the transmitter will be on only while one of the aforementioned packets is being transmitted. In other words, this device automatically discontinues transmission in case of either absence of information to transmit or operational failure.

- AC adaptor with ferrite core must be used for RF interference suppression.

Frequency Tolerance: ± 20 ppm

This device is restricted for indoor use.

This device and its antenna(s) must not be co-located or operating in conjunction with any other antenna or transmitter except in accordance with FCC multi-transmitter product procedures.

This equipment complies with FCC radiation exposure limits set forth for an uncontrolled environment. This equipment should be installed and operated with minimum distance 20 cm between the radiator & your body.

Federal Communication Commission Interference Statement

This equipment has been tested and found to comply with the limits for a Class B digital device, pursuant to Part 15 of the FCC Rules. These limits are designed to provide reasonable protection against harmful interference in a residential installation. This equipment generates, uses and can radiate radio frequency energy and, if not installed and used in accordance with the instructions, may cause harmful interference to radio communications. However, there is no guarantee that interference will not occur in a particular installation. If this equipment does cause harmful interference to radio or television reception, which can be determined by turning the equipment off and on, the user is encouraged to try to correct the interference by one of the following measures:

- Reorient or relocate the receiving antenna.
- Increase the separation between the equipment and receiver.
- Connect the equipment into an outlet on a circuit different from that to which the receiver is connected.
- Consult the dealer or an experienced radio/TV technician for help.

FCC Caution: Any changes or modifications not expressly approved by the party responsible for compliance could void the user's authority to operate this equipment.

This device complies with Part 15 of the FCC Rules. Operation is subject to the following two conditions: (1) This device may not cause harmful interference, and (2) this device must accept any interference received, including interference that may cause undesired operation.

For product available in the USA/Canada market, only channel 1~11 can be operated. Selection of other channels is not possible.





Contents

1. Specifications	13
1.1. Equipment specifications	14
1.2. Appearance/Dimensions(Specifications of this product are subject to change without notice)	16
1.3. Major Operating Controls and Their Functions	23
1.4. Power feeding method	31
1.5. Interface specifications	32
2. EA-7HW02AP1 installation work	35
2.1. Installations and Connections	36
2.2. Determine the installation place of wireless unit	37
2.3. Installation work of wireless unit	38
2.4. Connections	40
2.5. Initialization	42
2.6. Alarm display by self-test	43
3. EA-7HW03AP1 installation work	44
3.1. Installations and Connections	45
3.2. Determine the installation place of wireless unit	46
3.3. Installation work of wireless unit	47
3.4. Connections	50
3.5. Initialization	52
3.6. Alarm display by self-test	53
4. Setting method	54
4.1. Setting of PC for Web console use	55
5. Response to error occurrence	60
5.1. Troubleshooting	61





Main unit and accessories

The main unit and the following accessories are contained in the package box.
Make sure that all of them are contained when opened the package.

EA-7HW02AP1

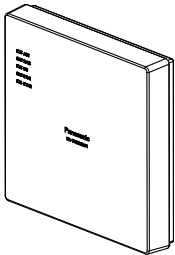
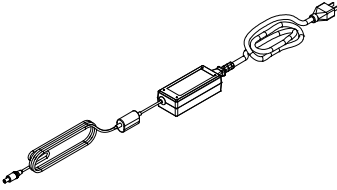
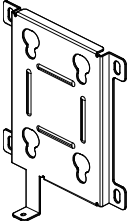
Product name	Illustration	Total number	Remarks
Main unit		1	
AC adapter		1	
AC cable		1	
Stand		1	
Mounter		1	
Safety guide		1	

EA-7HW03AP1

Product name	Illustration	Total number	Remarks
Main unit		1	
AC adapter		1	
AC cable		1	
Mounter		1	
M6 screw		4	
M3 screw		1	
Rubber foot		4	Shipped after attaching to the main unit
Safety guide		1	

Important

- In addition to the above, the following are required to perform the installation work. The following are not provided with this product. Please procure separately.
 - Ethernet cable (Category 5e or better, with RJ-45 modular plugs on both ends)
- This product (EA-7HW02AP1/ EA-7HW03AP1) is water-resistant (JIS C 0920 Protection grade 2, drip-proof type II). Avoid direct water jet and do not submerge this product in water when performing the installation work. When installing in a place where water can splash onto this product, to protect the product from water, make sure to install the product upright with the LED on the left side. (Do not lay the product on its side when installing and do not install the product in any way other than the above when installing it upright.)

To run a radio station of the second generation low-power data communication system as an outdoor fixed station, it is required to display both the name the owner of the corresponding radio station (or the name of the service provider) and the contact address. The following are the content to be displayed.

- Display of radio station: Radio station of 2.4 GHz band low-power data communication system
- Name of owner or of service provider
- Contact address: Phone number or E-mail address (or home page address, etc.)
- Other useful information such as information to avoid radio wave interference, etc.

As for method of display, use a sticker or a plate, print or handwrite on a place where no special operation is required to see such as on the radio station or on the housing case.

Option (Sold separately)

■ PoE injector

The following options are available to use EA-7HW02AP1 more conveniently.
Contact your dealer from whom you purchased this product for purchasing.

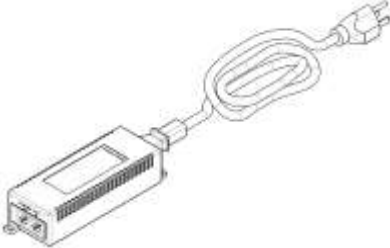
Product name <Model no.>	Illustration	Total number
PoE injector <EA-7HW00PWR1>	 A technical illustration of a PoE injector. It consists of a rectangular metal housing with a BNC connector on the left side and a standard RJ45 Ethernet port on the right side. A white Ethernet cable is plugged into the RJ45 port and is coiled.	1

Precautions for use

- **The installation work must be carried out by a professional installer.**
Incorrect installation may cause tip-over resulting in accidents.
- **Turn the power off when cleaning this product. Use a soft cloth to clean this product.**
When dust is hard to remove, use a soft cloth soaked in diluted detergent and squeezed hard to wipe it, and then wipe with a dry soft cloth.
- **Do not use any of alcohol, petroleum, thinner, benzene, boiling water, polishing powder and soap powder for cleaning and maintenance.**
When using a chemical cloth for cleaning, read the caution provided with the chemical cloth product.
- **Do not place this product in a place where temperature is high such as a place near a heating equipment or a boiler.**
Failure to observe this may result in deformation/deterioration of the surface/parts of the product or cause a failure.
- **Do not bring fire close to the product.**
Failure to observe this may result in deformation/deterioration of the surface/parts of the product or cause a failure.
- **Do not place this product in a place where hydrogen sulfide, phosphorus, ammonia, sulfur, carbon, acid, dust or noxious gas can exist.**
Failure to do so may result in failure or shorten the life of the product.
- **Do not place this product near a source of electromagnetic wave or a magnetized object. (High-frequency sewing machine, electric welder, magnet, etc.)**
Failure to observe this may result in generation of noise or cause a failure.
- **Do not apply a strong impact or vibration to this product.**
If a strong impact caused by a fall or a strike is applied, it may result in a failure or a damage.
- **When disposing of this product, handle it as an industrial waste and follow laws and regulations appropriately.**

Notes on radio waves

- This product is certified to radio equipment technical standards based on Radio Act (2.4 GHz ISM band low-power data communication system and 5 GHz band low-power data communication system). Therefore, no license of a radio station is necessary for use of this product.
- Since this product is certified to the technical standards, the following actions are punishable by law.
 - Taking apart or modifying this product. (Alteration of frequency and antenna is prohibited.)
 - Removing the certification label from the bottom of this product.
- 5 GHz band (IEEE802.11 a/n/ac) in outdoor use is limited in usable frequency by Radio Act.
 - Applicable channels of 5 GHz (IEEE802.11 a/n/ac) band are ch36 - ch48 (W52), ch52 - ch64 (W53) and ch100 - ch140 (W56).
 - W52 and W53 are only for indoor use. W56 is usable for outdoor use. Do not select W52 and W53 when configuring the settings in case of using this product outdoor.
 - To support W53 and W56, DFS (Dynamic Frequency Selection) and TPC (Transmit Power Control) are used as the radio wave control function.
 - It is impossible to communicate with a wireless LAN equipment using the channel (J52) which was released before the ordinance was revised in May 2005 due to channel mismatch.
- In the use frequency band of 2.4 GHz band (IEEE802.11 b/g/n), in addition to industrial/scientific/medical equipments including microwave ovens, private branch radio stations (license required) for mobile object identification that are used in manufacturing lines at factories, specified low-power radio stations (no license required) and amateur radio stations (license required) are being operated.
 - Before using this product, make sure that any of private branch radio station for mobile object identification, specified low-power radio station and amateur radio station is not being operated.
 - If harmful radio wave interference against a private branch radio station for mobile object identification caused by this product occur, immediately change the use frequency of this product and eliminate the radio wave interference.
 - When operating this product in 2.4 GHz band, it is recommended to select CH1, CH6 or CH11 for the channel setting to reduce interference and to improve frequency utilization efficiency.
 - If you need any assistance to deal with a trouble such as harmful radio wave interference against a private branch radio station for mobile object identification or a specified low-power radio station caused by this product, contact your dealer from whom you purchased this product.
 - Use frequency band: 2.4 GHz
 - Modulation system: DS-SS/OFDM
 - Estimated interference distance: Less than 40 m
 - Frequency change availability: It is possible to avoid band for private branch radio station for mobile object identification and specified low-power radio station while using the entire band.
 - The following marks indicating these are labeled on the product.

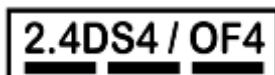

Security-related notice on use of wireless LAN products

- In a wireless LAN, information is transmitted/received between a PC and this product using radio wave instead of a LAN cable. Therefore, it has an advantage that the LAN connection is always available in a range which radio waves reach.

On the other hand, since radio waves get over obstacles (wall, etc.) and reach any place within a certain range, the following problems can occur if settings relating to security are not configured.

- Content of communication can be peeped
 - There is a possibility that a third person with malicious intention may intentionally pick up radio waves and monitor content of communication including personal information such as ID, password, credit card number and content of E-mails.
- Illegal intrusion
 - There is a possibility that the following may be brought by illegal intrusion.
A third person with malicious intention may invade and access a personal or a corporate network to steal personal information or classified information (information leakage).
 - Communicate by impersonating a specific person and spread illegal information (Spoofing)
 - Edit monitored content of communication and transmit (Alteration)
 - Spread computer virus and destroy data or a system (Attack)

Since a wireless LAN card and this product originally have security countermeasures against these problems, the possibility of occurrence of these problems may be reduced if wireless LAN products are used after configuring the security-related settings of the products.

Fully understand problems that may occur if using the product without configuring the security-related settings. It is recommended to use this product after configuring the security-related settings on your own judgement and responsibility while taking other countermeasures (use of physical security countermeasure against theft or use of VPN function to prevent data eavesdropping) according to your use environment.

Chapter 1. Specifications

The following are descriptions about specifications of Wi-Fi base station for business use.

1.1. Equipment specifications

Wi-Fi base station for business use EA-7HW02AP1

Item		EA-7HW02AP1
External interface	Wireless	IEEE802.11b/g/n, IEEE802.11a/n/ac (wave1) (Simultaneous use is possible.)
	Wired	10/100/1000BASE-T 1 port
Frequency	2.4 GHz	2412-2462MHz
	5 GHz	5180-5240, 5260-5320, 5500-5700, 5745-5825 MHz.
Transmission power		Maximum 2.4GHz: 28.23 dBm / Maximum 5GHz: 27.82 dBm.
Antenna		Planar inverted F antenna
Antenna gain		2.4 GHz: 3.88 dBi/ 5 GHz: Less than 5 dBi
Wireless LAN function		Multi-SSID (16), WEP/WPA2 (Personal/Enterprise), MAC authentication, WMM
Network Interface		L2 bridge, L2/L3/L4 filtering, VLAN, PPPoE, IPsec
Maintenance function		Telnet, SSH, Web, FTP/SFTP, SNMP/TRAP, NTP, syslog
Power source		12 V DC PoE(IEEE802.3af)
Power consumption		12.95 W or less
Required operating environment		Temperature: 0 °C- 40 °C Humidity: 5 % - 95 % (non condensing)
Water-/dust-resistance		IP42 (except the rear panel)
Outer dimensions (excluding tolerance and projections)/Weight		W159 mm x H159 mm x D29 mm / Approx. 360 g

Wi-Fi base station for business use EA-7HW03AP1

Item		EA-7HW03AP1
External interface	Wireless	IEEE802.11b/g/n, IEEE802.11a/n/ac (wave2) (Simultaneous use is possible.)
	Wired	10/100/1000BASE-T 2 ports
	USB	USB 3.0 2 ports
	Maintenance	Console interface 1 port
Frequency	2.4 GHz	1ch - 13ch
	5 GHz	W52, W53, W56 (Outdoor use of W52 and W53 is prohibited by the ordinance)
Transmission power		2.4 GHz: 17 dBm/ 5 GHz: 15 dBm (W52/53), 18 dBm (W56)
Antenna		Planar inverted F antenna
Antenna gain		2.4 GHz: 4 dBi/ 5 GHz: Less than 5 dBi
Wireless LAN function		Multi-SSID (16), WEP/WPA2 (Personal/Enterprise), MAC/ authentication, WMM
Network Interface		L2 bridge, L2/L3/L4 filtering, VLAN, PPPoE, L2TPv3, IPsec
Maintenance function		Telnet, SSH, Web, FTP/STFTP, SNMP/TRAP, NTP, syslog
Power source		24 V DC PoE (IEEE802.3af, IEEE802.3at) <ul style="list-style-type: none"> • When using IEEE802.3af Use of USB and 2.4 GHz band becomes unavailable. • When using IEEE802.3at Use of USB becomes unavailable.
Power consumption		25.5 W or less
Required operating environment		Temperature: 0 °C - 40 °C (0 °C - 50 °C Only when installing on a wall) Humidity: 5 % RH - 95 % RH (non condensing)
Water-/dust-resistance		IP42 (except the rear panel)
Outer dimensions		W201.7 mm×H201.7 mm×D38.5 mm (excluding tolerance and projections)
Weight		Approx. 990 g

AC adapter

Item	Specifications
Input voltage	100 V - 240 V AC However, the provided power cord is only for 100 V AC. Prepare a power cord separately when using 200 V AC power supply.
Output voltage/power	24 V DC/36 W
Required operating environment	Temperature: 0 °C - 40 °C (0 °C - 50°C Only when 1 USB port of this product is not being used) Humidity: 5 % RH - 90 % RH (non condensing)
Dimensions	W 48 mm×H 109 mm×D 34 mm (Excluding tolerance and projections)
Weight	Approx. 300 g

1.2. Appearance/Dimensions

(Specifications of this product are subject to change without notice)

EA-7HW02AP1

- Main unit Outline view

(Unit: mm)

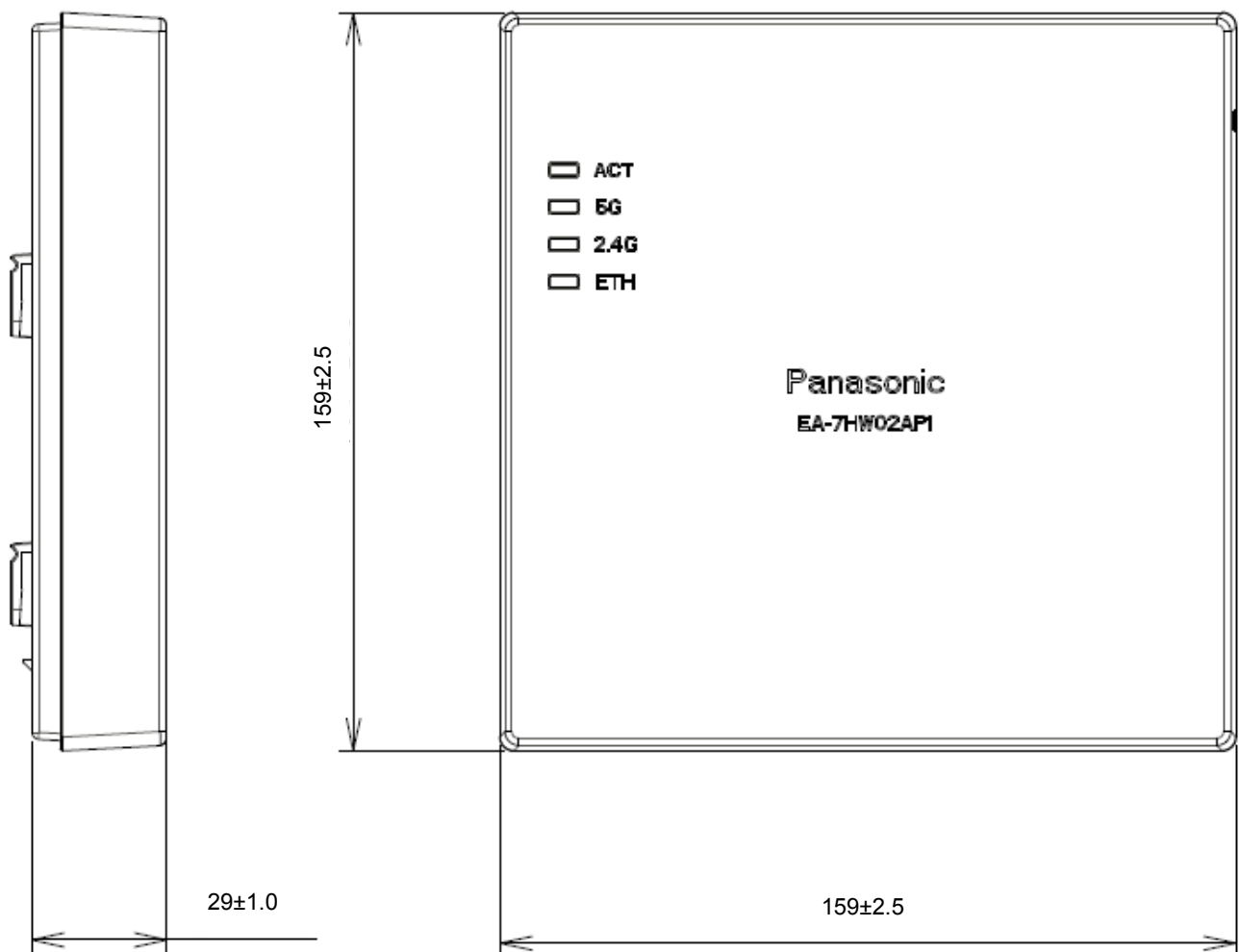
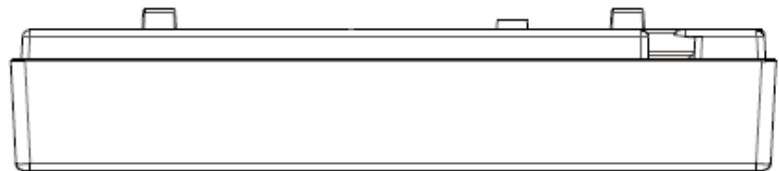

● Mounter Outline view

(Unit: mm)

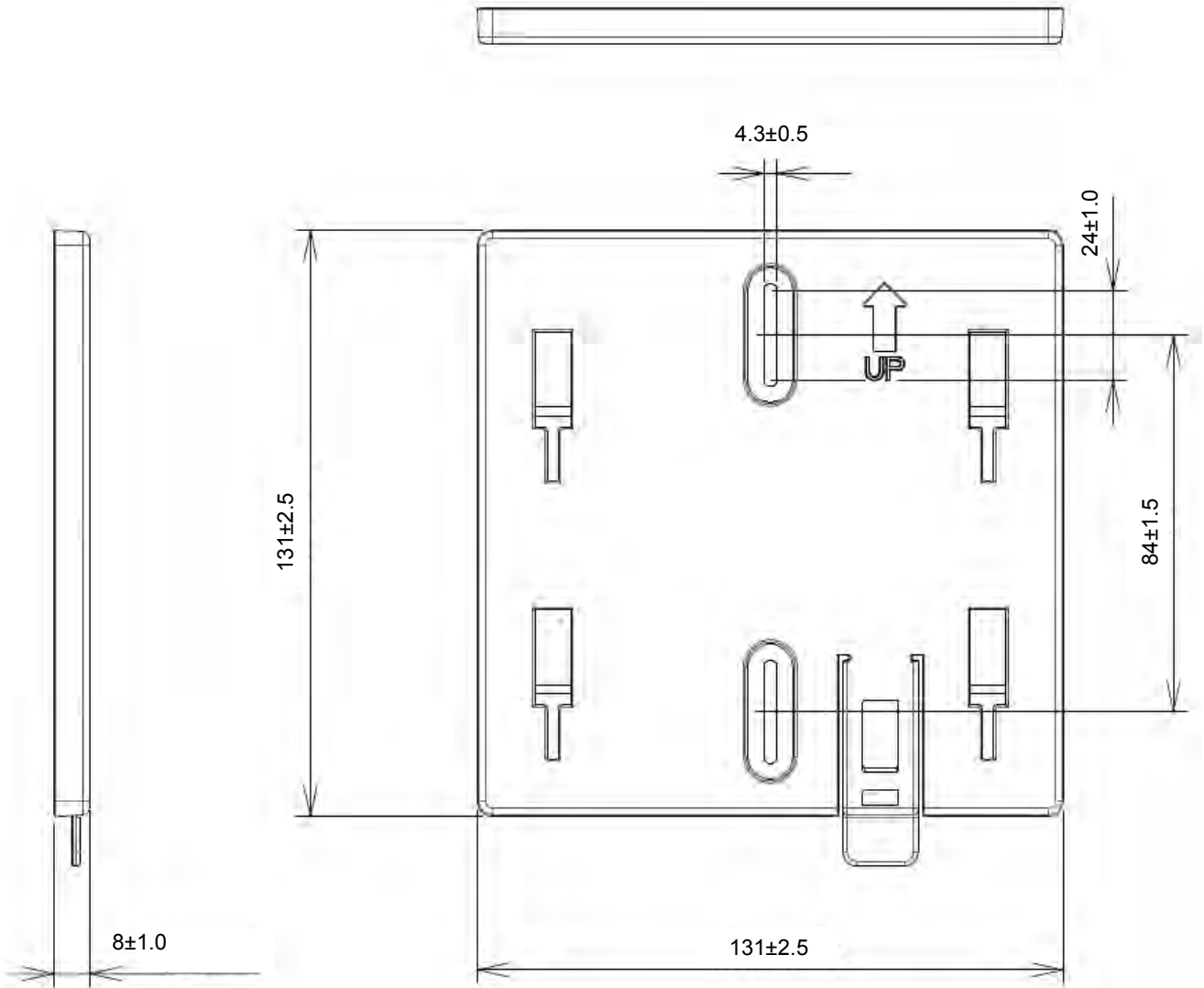

● Stand Outline view

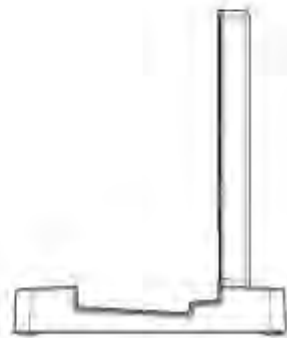
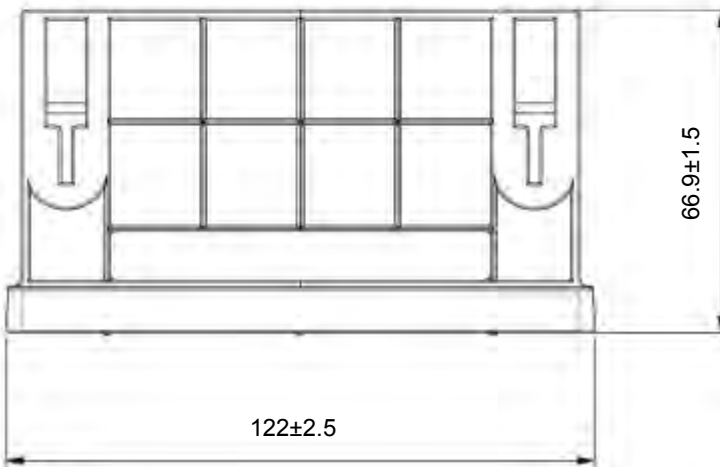
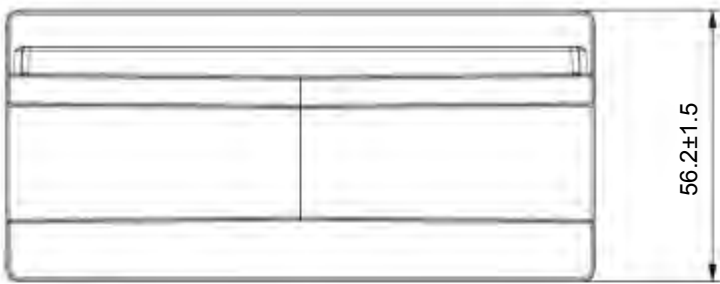

● AC adapter Outline view

(Unit: mm)

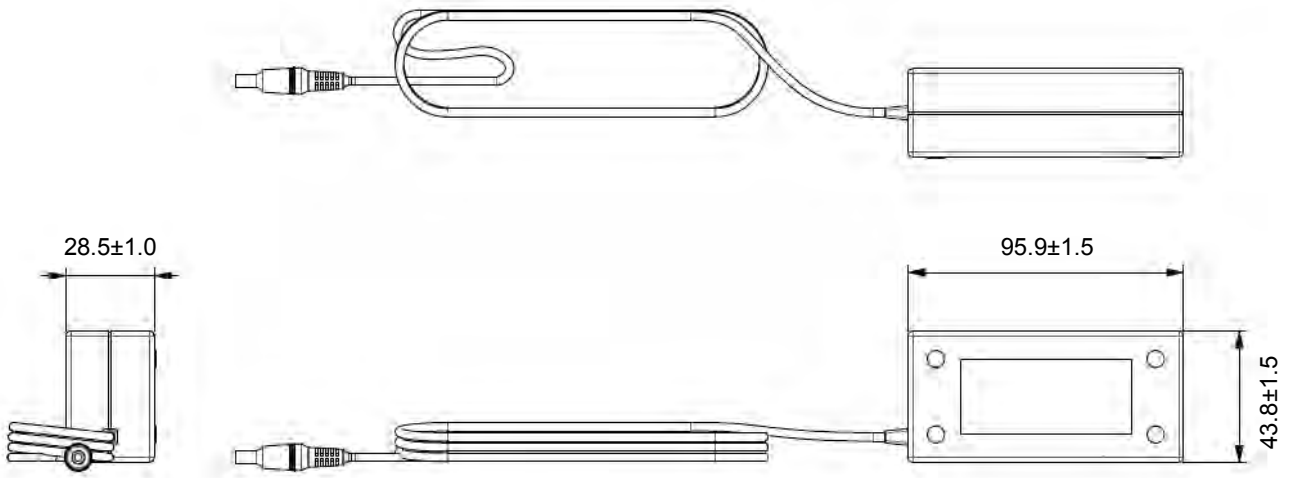

EA-7HW03AP1

- Main unit Outline view

(Unit: mm)

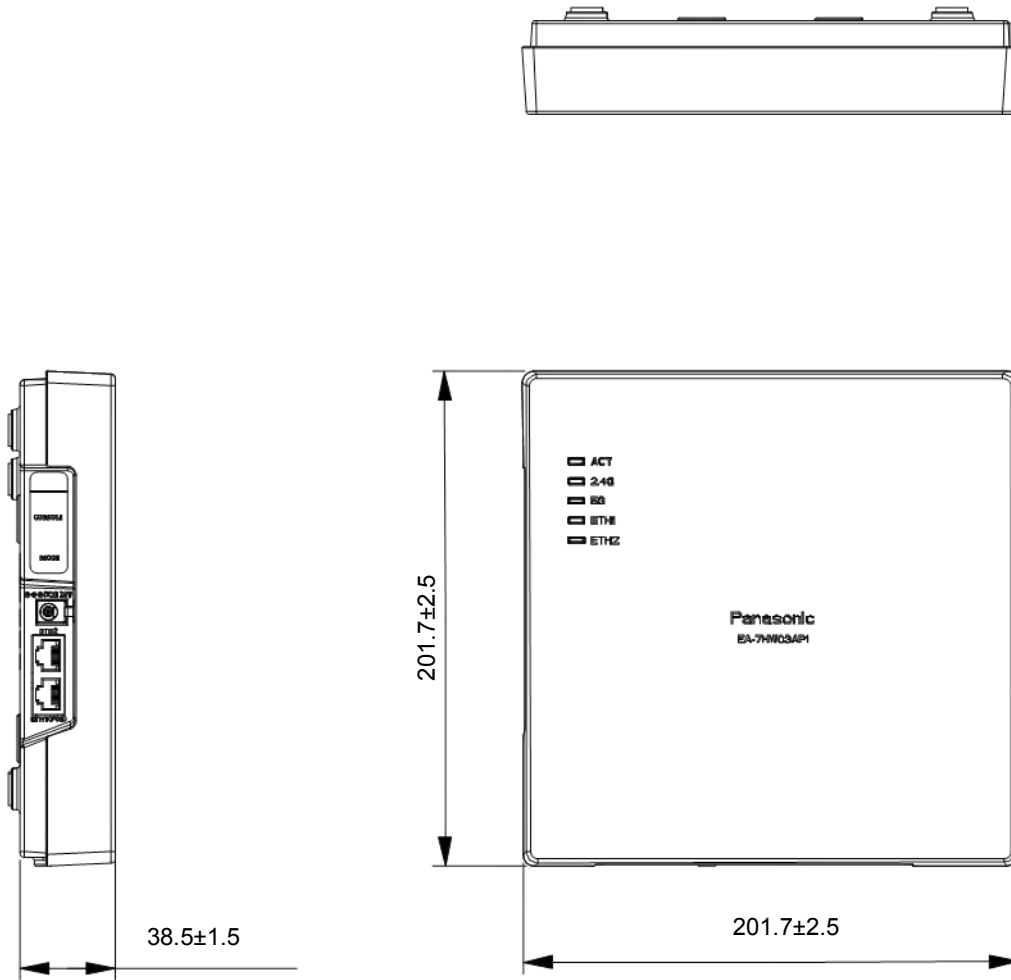

● Mounter Outline view

(Unit: mm)

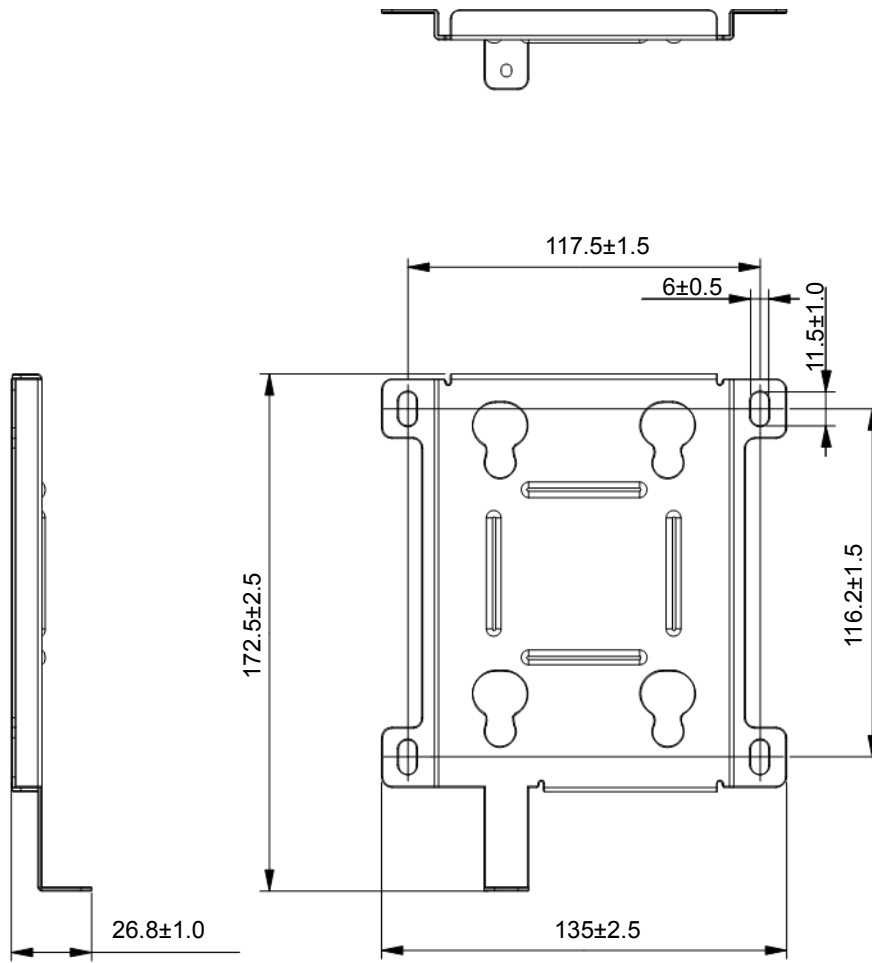

● AC adapter Outline view

(Unit: mm)

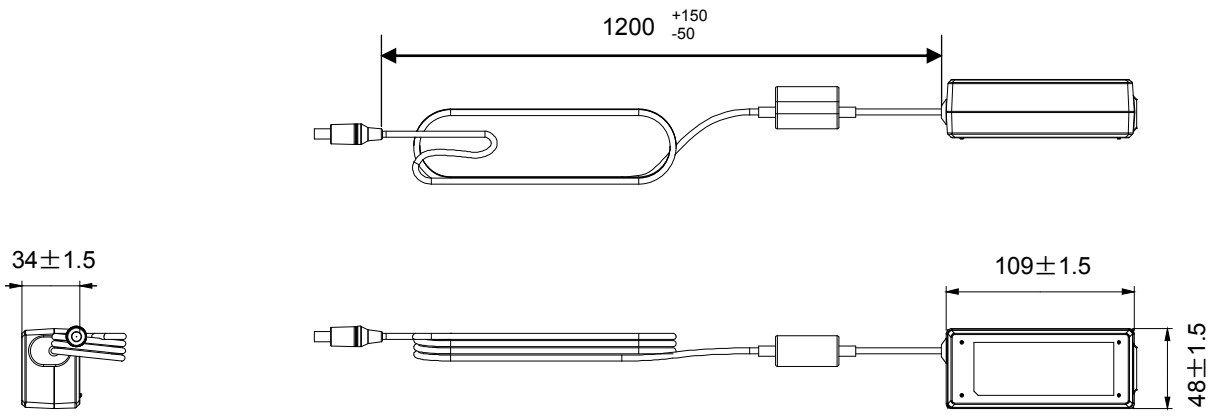

● Power cord Outline view

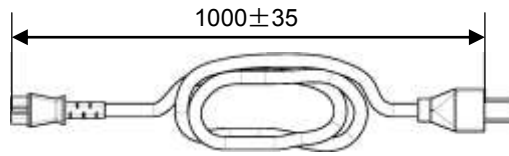

1.3. Major Operating Controls and Their Functions

Wi-Fi base station EA-7HW02AP1

The following are descriptions about the appearance of this product and names/functions of each operating control.

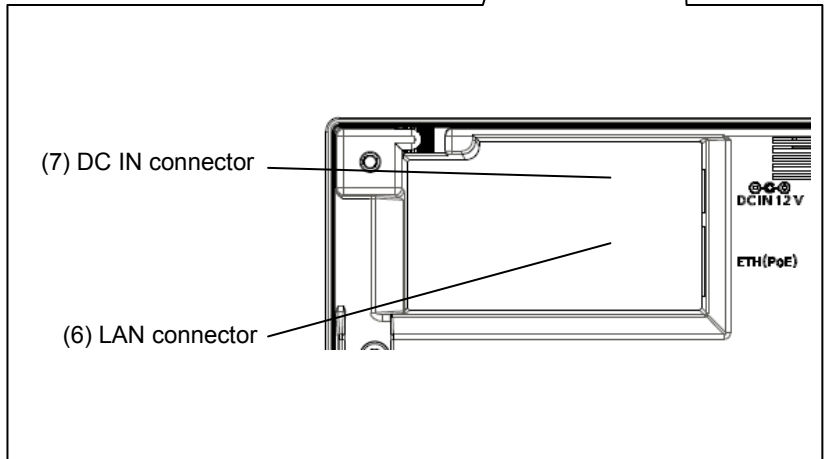
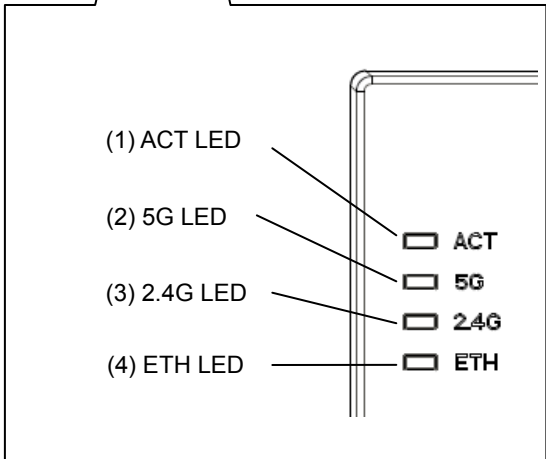
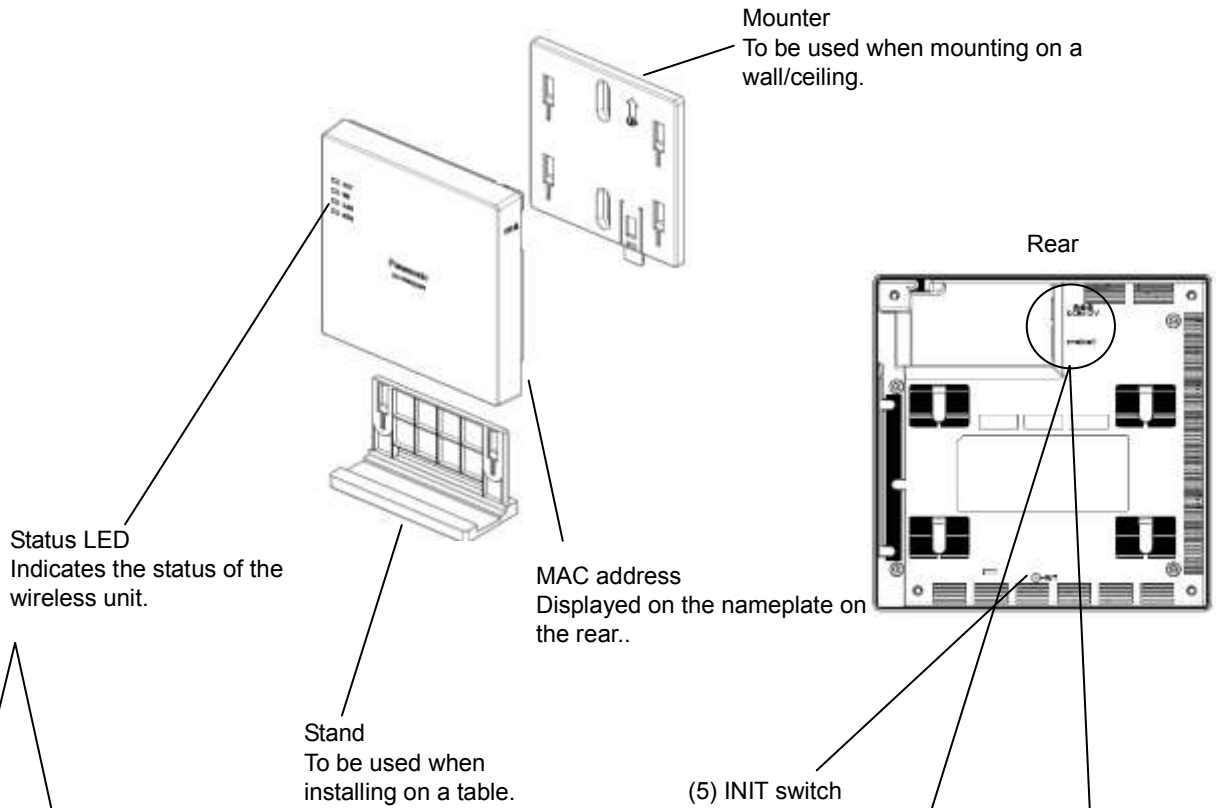

Descriptions about each LED, switch and connector are in the following table.

No.	Signal	Function	
(1)	ACT LED	Indicates the operational/error status of the unit.	
		Lights red	Error detection during operation
		Lights green	In operation
(2)	5G LED	Displays the status of wireless IF 5 GHz	
		Lights green	In normal operation
		Off	In the process of start-up
(3)	2.4G LED	Displays the status of wireless IF 2.4 GHz	
		Lights green	In normal operation
		Off	In the process of start-up
(4)	ETH LED	Indicates the link status of the Ethernet port.	
		Blinks green	In the process of frame transmission/reception
		Lights green	Link established
		Off	Link disconnected
(5)	INIT switch (Push switch)	Initializes configuration data and log data.	
(6)	Ethernet IF ETH (RJ-45 modular jack)	Connect an Ethernet cable. The ETH port supports power supply from a PoE power feeding equipment.	
(7)	DC IN jack	Connect the DC plug of the provided AC adapter.	

- **AC adapter (standard accessory)**
Connect to the AC outlet to supply power to the wireless unit.

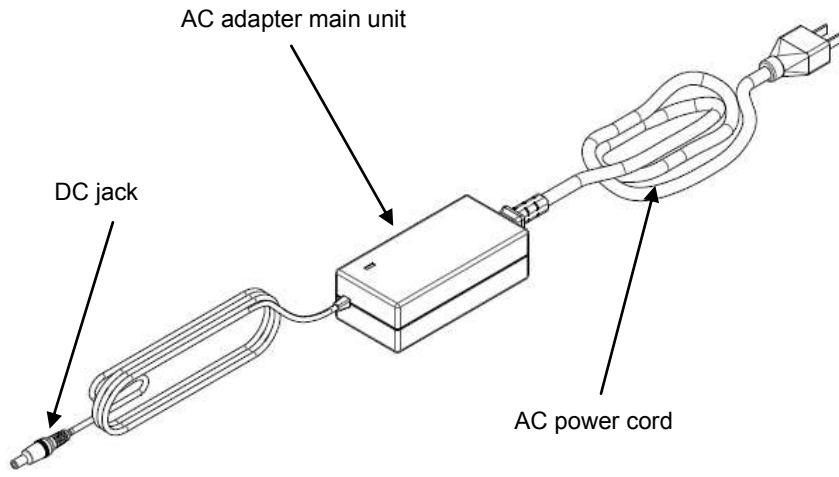

AC IN terminal
Connect the provided AC power cord.

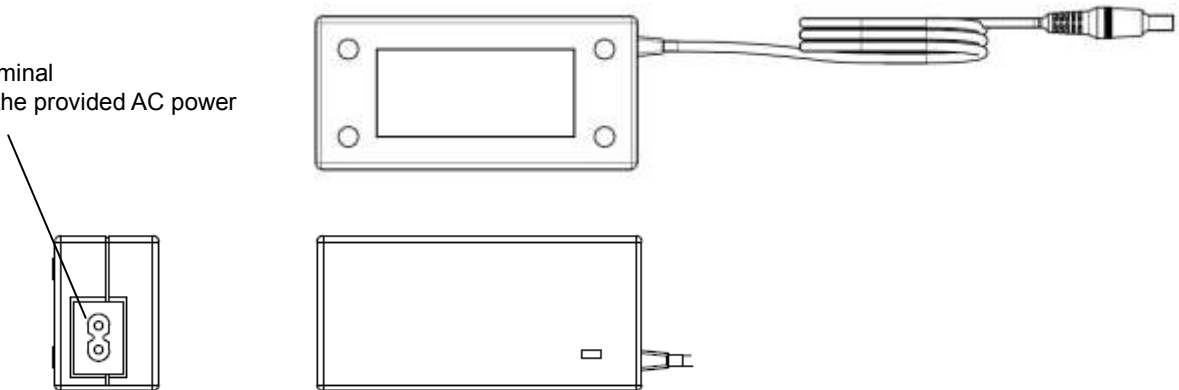

Wi-Fi base station for business use EA-7HW03AP1

The following are descriptions about the appearance of this product and names/functions of each operating control.

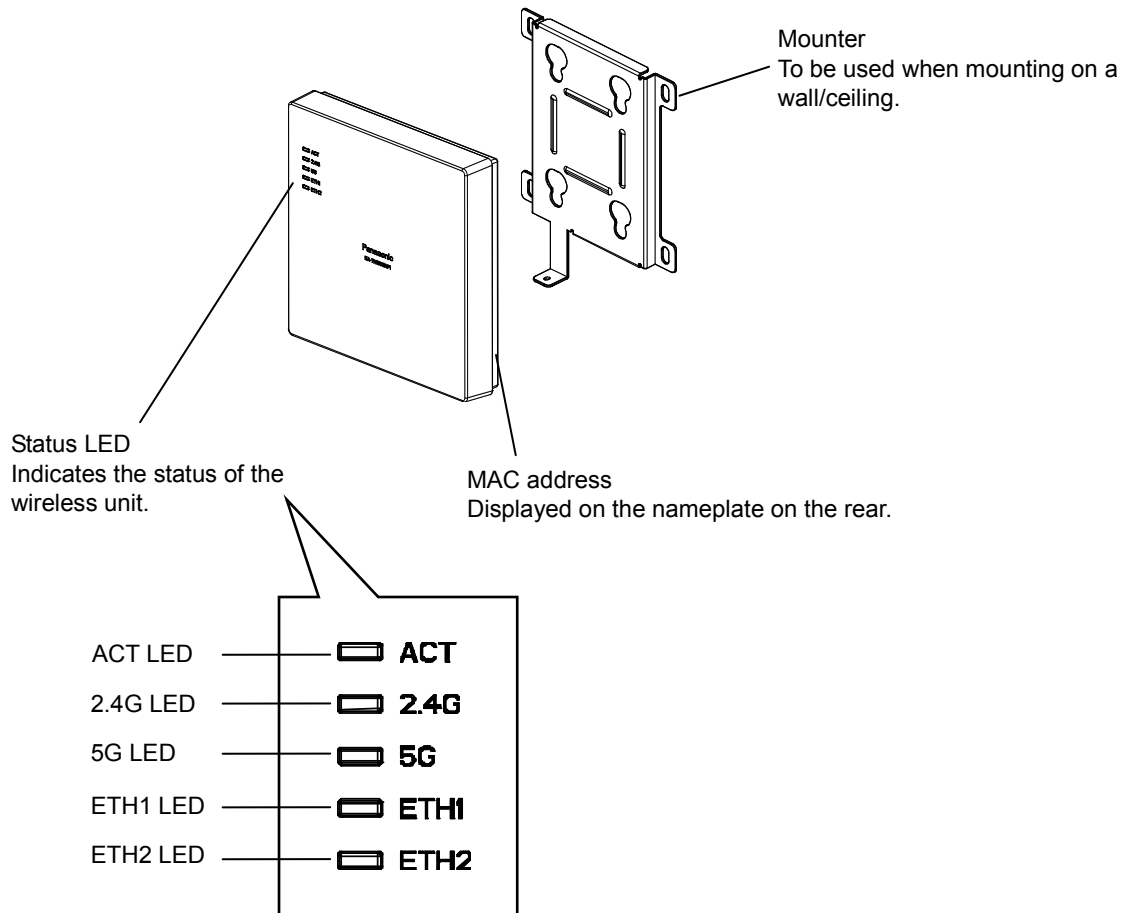

● Front

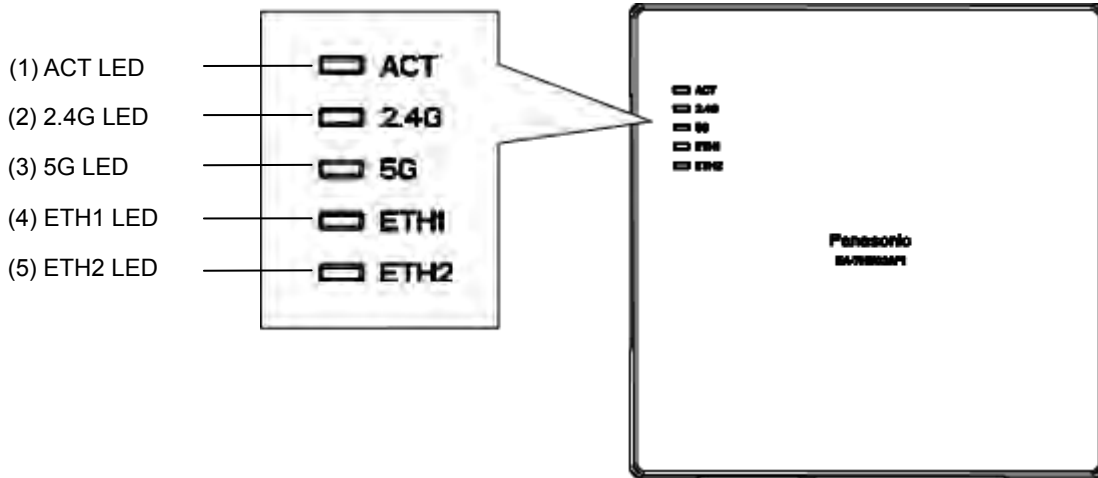

No.	Signal	Function	
(1)	ACT LED	Indicates the operational/error status of the unit.	
		Lights green	In operation
		Blinks green	In the process of start-up
		Blinks red	In the process of upgrade
		Lights red	Error detection during operation
(2)	2.4G LED	Displays the status of wireless IF 2.4 GHz	
		Lights green	In normal operation
		Off	In the process of start-up
(3)	5G LED	Displays the status of wireless IF 5 GHz	
		Lights green	In normal operation
		Off	In the process of start-up
(4)	ETH1 LED	Indicates the link status of the Ethernet port.	
		Blinks green	In the process of frame transmission/reception
		Lights green	Link established
		Off	Link disconnected
(5)	ETH2 LED	Indicates the link status of the Ethernet port.	
		Blinks green	In the process of frame transmission/reception
		Lights green	Link established
		Off	Link disconnected

● Rear/Left side

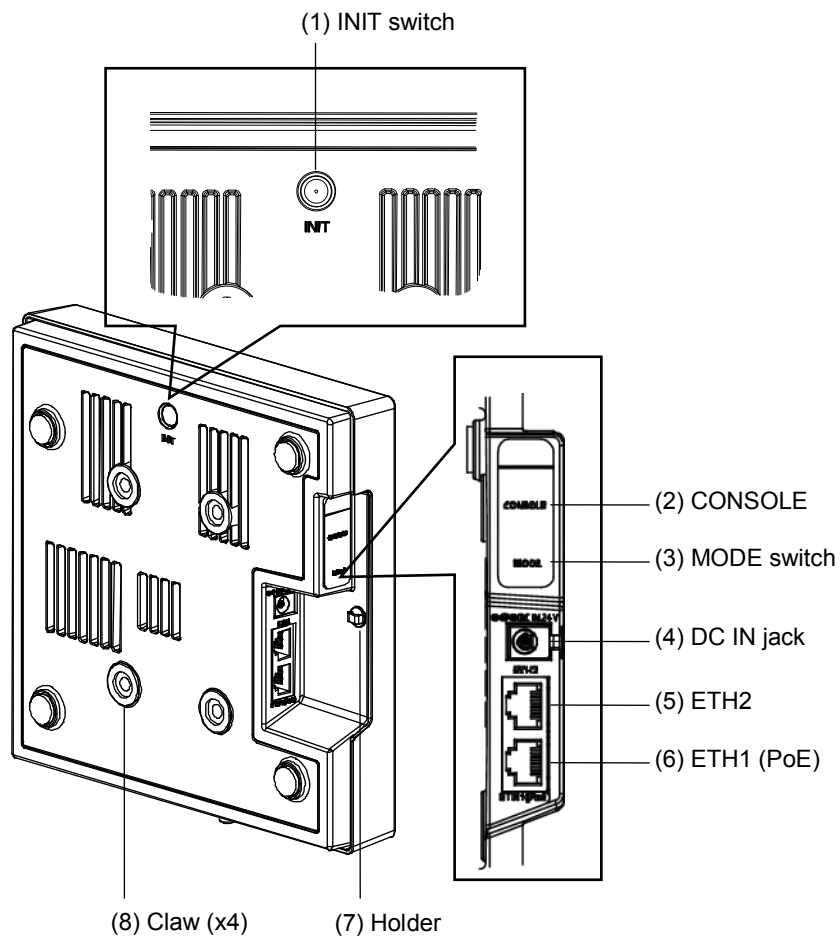

No.	Signal	Function
(1)	INIT switch (Push switch)	Initializes configuration data and log data.
(2)	CONSOLE (RJ-45 connector)	Connect the console for maintenance, such as a PC.
(3)	MODE 1, 2 (Slide switch)	Not be used. Do not change the default.
(4)	DC IN jack	Connect the DC plug of the provided AC adapter.
(5)	ETH2 (RJ-45 connector)	Connect an Ethernet cable.
(6)	ETH1(PoE) connector (RJ-45 connector)	Connect an Ethernet cable and start power feeding from a PoE power feeding equipment.
(7)	Holder	Use this with a cable tie to prevent disconnection of the AC adapter.
(8)	Claw (x4)	Attach by tightening the provided M6 screw when installing on a wall.

- **Bottom side**

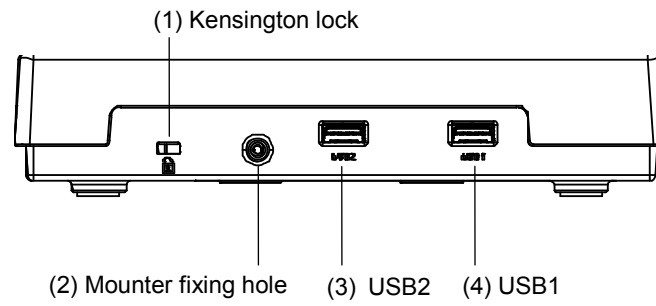

No.	Signal	Function
(1)	Kensington lock	Use for theft prevention.
(2)	Mounter fixing hole	Attach the mounter.
(3)	USB2 (USB3.0 Type A)	Connect a USB device.
(4)	USB1 (USB3.0 Type A)	Connect a USB device.

AC adapter (standard accessory)

Connect to the AC outlet to supply power to the wireless unit.

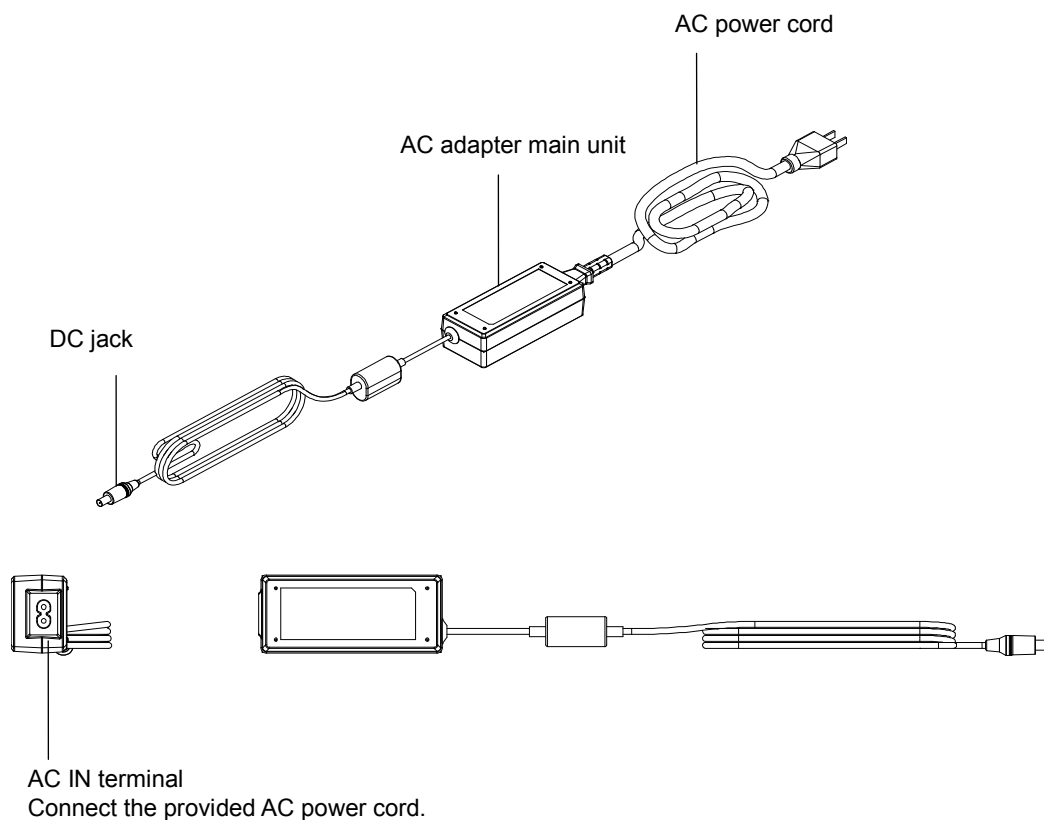

1.4. Power feeding method

Power feeding method

The power feeding method of the wireless unit is as follows.

Access point	Available power feeding method
EA-7HW02AP1	<ul style="list-style-type: none">• Power feeding from AC adapter (Use the supplied AC adaptor.)• Power feeding from PoE power feeding equipment compliant with IEEE802.3af or IEEE802.3at.
EA-7HW03AP1	<ul style="list-style-type: none">• Power feeding from AC adapter (Use the supplied AC adaptor.)• Power feeding from PoE power feeding equipment compliant with IEEE802.3af or IEEE802.3at. <p>* However, there are following restrictions when using PoE power feeding for EA-7HW03AP1.</p> <ul style="list-style-type: none">■ When using IEEE802.3af Use of USB and 2.4 GHz band becomes unavailable.■ When using IEEE802.3at Use of USB becomes unavailable. <p>If these conditions are not fulfilled, this product may sometimes be reset.</p>

Refer to "2.4.2 Connection with power supply" for power feeding.

1.5. Interface specifications

Ethernet interface specifications

- Interface specifications

Network interface	Type of connector	Type of cable	Transmission distance
10BASE-T/100BASE-TX	RJ-45	Category 5	100 m
1 000Base-T	RJ-45	Enhanced category 5	100 m

- LAN (RJ-45) connector

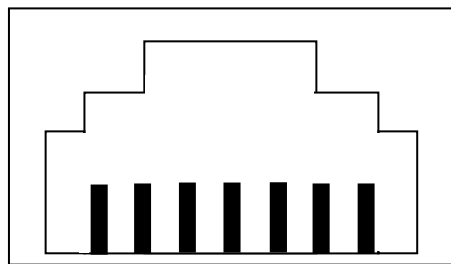

1 2 3 4 5 6 7 8
(Connector on the main unit side)

Table 1.6 LAN (RJ-45) connector

Pin No.	10/100Base Main unit side (MDI)	10/100Base Main unit side (MDI-X)	1000Base-T Main unit side (MDI)	1000Base-T Main unit side (MDI-X)
1	Tx +	Rx +	BI_DA +	BI_DB +
2	Tx -	Rx -	BI_DA -	BI_DB -
3	Rx +	Tx +	BI_DB +	BI_DA +
4	Not used	Not used	BI_DC +	BI_DD +
5	Not used	Not used	BI_DC -	BI_DD -
6	Rx -	Tx -	BI_DB -	BI_DA -
7	Not used	Not used	BI_DD +	BI_DC +
8	Not used	Not used	BI_DD -	BI_DC -

Console interface specifications (EA-7HE03AP1 only)

- Console (RJ-45) connector

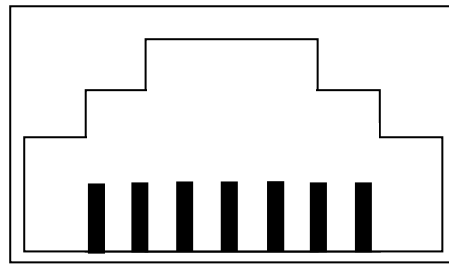

1 2 3 4 5 6 7 8
(Connector on the main unit side)

Table 1.6 LAN (RJ-45) connector

Pin No.	Main unit side (DTE)
1	RTS
2	DTR
3	TxD
4	GND
5	GND
6	RxD
7	Not used
8	Not used

USB interface specifications (EA-7HE03AP1 only)

- Interface specifications

Network interface	Type of connector	Transmission distance
USB 3.0	Type-A	3 m

- USB connector

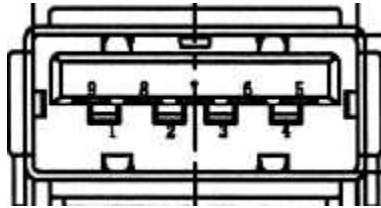

USB connector

Pin No.	Signal name
1	V BUS
2	D -
3	D +
4	GND
5	TX +
6	TX -
7	GND
8	RX +
9	RX -

Chapter 2. EA-7HW02AP1 installation work

The following are descriptions about installation work of EA-7HW02AP1 and connection method of each interface.

2.1. Installations and Connections

Follow the procedures below to install and connect EA-7HW02AP1.

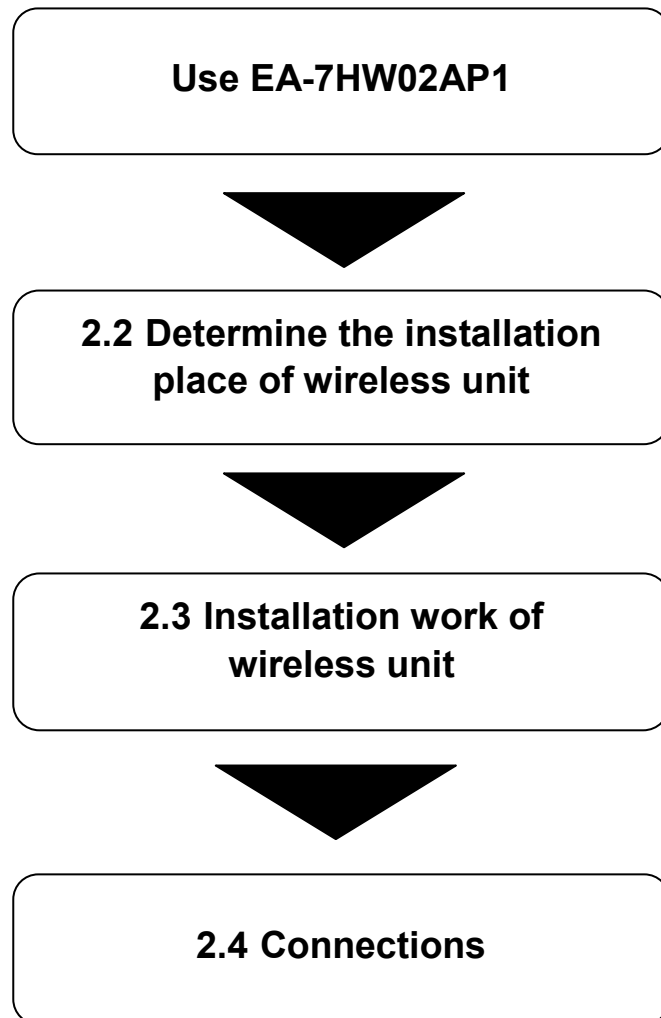

2.2. Determine the installation place of wireless unit

- EA-7HW02AP1 can be installed on a wall, on a ceiling, at back of ceiling and on a desktop using the provided mounter.
- The wireless unit shall be installed on a place having an enough strength to hold the unit and flat surface. Weight of the main unit of the wireless unit is approx.360 g.
- The wireless unit shall be installed firmly not to loosen up and fall off due vibration and anything in future.
- Make sure that there is no factor that can affect performance of the antenna, such as a metallic or concrete obstacle, near the wireless unit.
- Read "Safety precautions" and "Precautions" carefully and determine the installation place.

2.3. Installation work of wireless unit

Refer to "1.2 Appearance/Dimensions" for the size of the wireless unit and the mounter.

1. Wall mounting

(1) Fixing of the mounter

Fix the mounter after making sure that the installation place has an enough strength and flat surface of concrete, metal, wood, mortar, etc.

- Fasten a screw (x1) temporarily on the installation surface.
- Make sure that the mounter can be installed in parallel, and then fix it firmly with 2 screws located at the upper and the lower sides.
(Recommended tightening torque: $0.85 \text{ N}\cdot\text{m} \pm 0.12 \text{ N}\cdot\text{m}$)

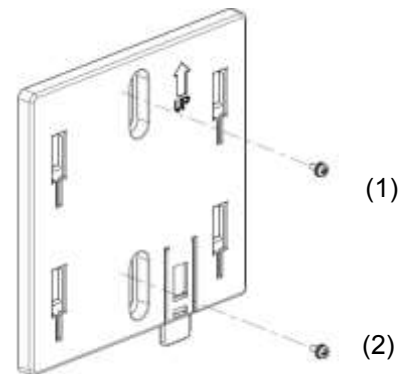

Note

Use a screw whose nominal diameter is 4mm to fix on the installation surface.

This screw shall be prepared by the installer according to the material of the installation surface.

(2) Installation of the wireless unit

Fix the main unit onto the mounter fixed on the wall.

- Hook the claws (x4) of the wireless unit into the hook holes on the mounter.
 - Align the side of the mounter and the dent in the wiring groove of the wireless unit.
- (3) Slide the wireless unit downward until the "click" sound is heard.
- To remove the wireless unit from the mounter, slide the wireless unit upward while holding down the lever to the wall side.

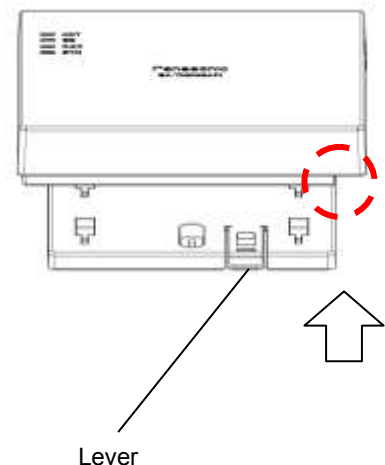
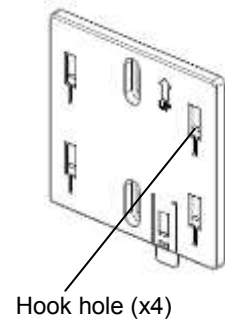
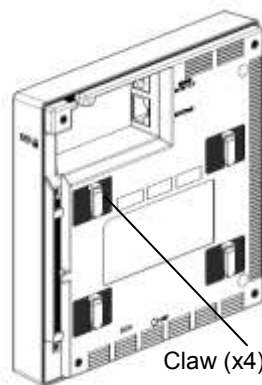

Important

- When installing the wireless unit, make sure that the LED is not hidden from your view and it is easy to check. Secure a space of 30 mm or more above the product to secure a space allowing you to hook.

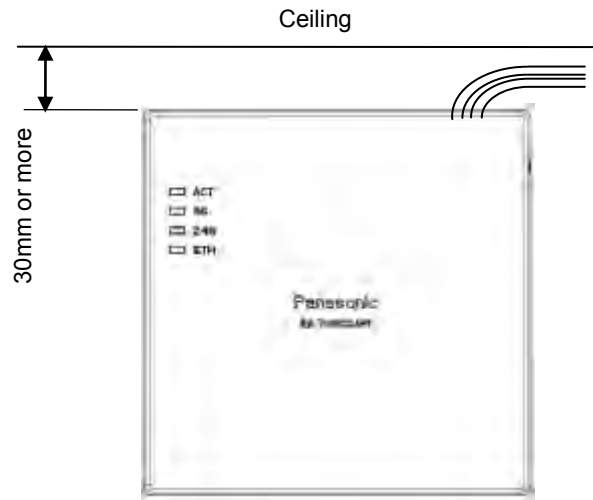

2. Installation on a desktop

(1) Fix the wireless unit onto the stand.

- Hook the claws (x2) on the rear of the wireless unit into the hook hole on the stand.

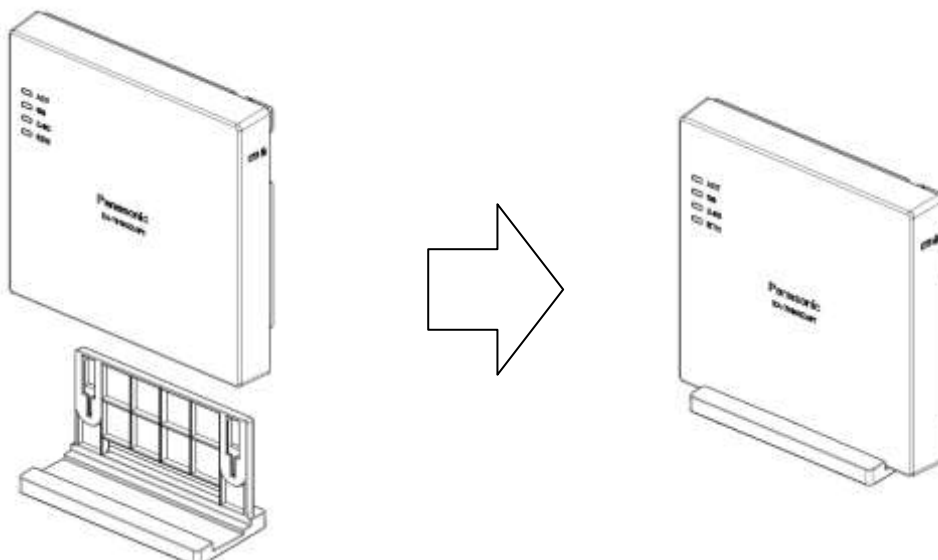
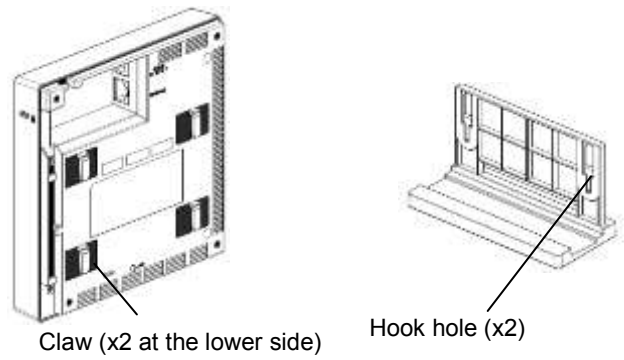

2.4. Connections

2.4.1. Connection to network

1. In case of LAN connection

Connect an Ethernet cable (enhanced category 5 or better) to the LAN connector on the right side of the main unit.

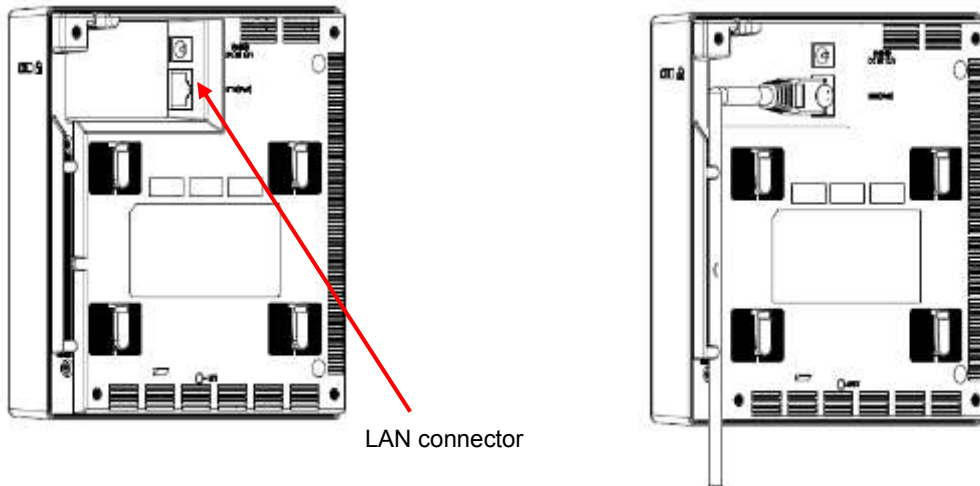

2.4.2. Connection with power supply

1. Power feeding from AC adapter

Firmly connect the DC plug of the provided AC adapter to the DC IN connector in the external interface section of the main unit.

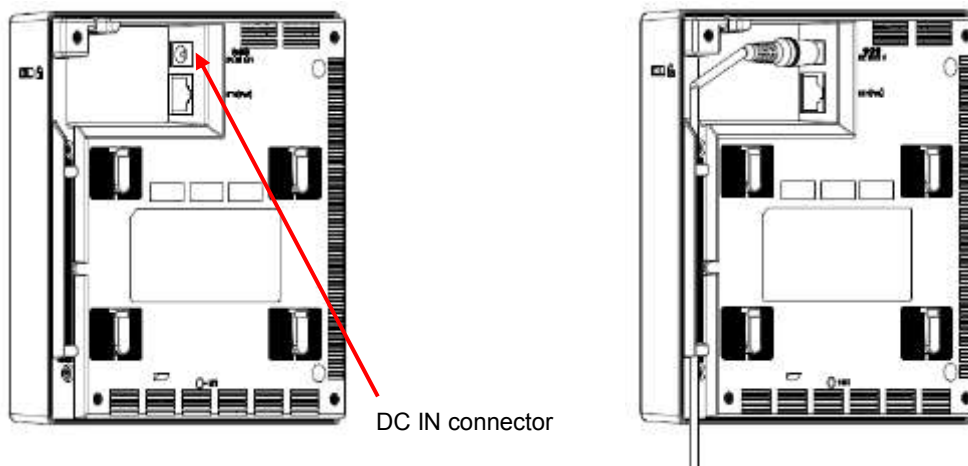

2. Power feeding from PoE unit

Power will be fed from PoE power feeding equipment compliant with IEEE802.3af or IEEE802.3at. In this section, descriptions of how to feed power from PoE injector are provided.

By following the procedures below, connect the PoE injector and other cables.

- (1) Insert the plug of the Ethernet cable connected with the wireless unit to the "DATA & POWER OUT" port of the PoE injector until the "click" sound is heard.
- (2) Connect the provided power cable to the PoE injector.
- (3) Insert the power plug of the PoE injector to an outlet of 100 V AC. (The POWER LED will light yellow and then turn to green.)
- (4) Insert the plug of the Ethernet cable connected with a host network device to the "DATA IN" port of the PoE injector until the "click" sound is heard.

Important

- The wiring length from the wireless unit to the host network device shall be up to 100 m (total).
- Do not pull the connected cables with a strong force.
- Do not place a heavy object on the PoE injector.
- Do not perform wiring of the connection cables and the Ethernet cable connection section in a place where water can damage them.

2.5. Initialization

It is possible to initialize (reset the setting data and the log data to the default) the wireless unit directly without using the initialization command.

- (1) Hold down the INIT switch using something that has a needle-like tip such as a skewer.
* Start working after removing static electricity.
- (2) Connect the AC adapter and the PoE injector, and then turn on the power.
- (3) Wait until the ACT LED starts blinking red.
- (4) When the ACT LED blinking red turns to blinking green, release the INIT switch.

Default of each interface after the initialization

Network interface	Default	Remarks
Wi-Fi interface (2.4G)	Off	Default after validating the interface 2.4 GHz, 1ch, HT40
Wi-Fi interface (5G)	Off	Default after validating the interface 5.2 GHz, 36ch, HT80
Ethernet (ETH)	-	Default fixed IP (192.168.0.3/24) (Access will become available after approx. 150 seconds from the start-up.)

2.6. Alarm display by self-test

This product will automatically perform self-test upon the start-up. If an error is detected, the detected alarm will be indicated by the LED display on the product. When an error is detected on the self-test, turn off the power and contact the dealer from whom you purchased this product.

EA-7HW02AP1 Self-test alarm display

Alarm type	ACT	2.4G	5G	ETH
FROM check error	Lights red	Off	Off	—
RAM check error	Lights red	Off	Off	—
Manufacturing number error	Blinks red	Off	Off	—
MAC address error	Blinks red	Off	Off	—

Notice

- As the test of LED, all LEDs except the LINK LED will light. After that, all LEDs except the LINK LED will be off until the self-test finishes. Refer to "1.3 Major operating controls and their functions" for descriptions of LED display when the self-test completed correctly.
- When started up by turning on the INIT switch (initialized state), the ACT LED will start blinking.
- The status of ETH LED will change according to the connection status of Ethernet (power supply state).

Chapter 3. EA-7HW03AP1 installation work

The following are descriptions about installation work of EA-7HW03AP1 and connection method of each interface.

3.1. Installations and Connections

Follow the procedures below to install and connect EA-7HW03AP1.

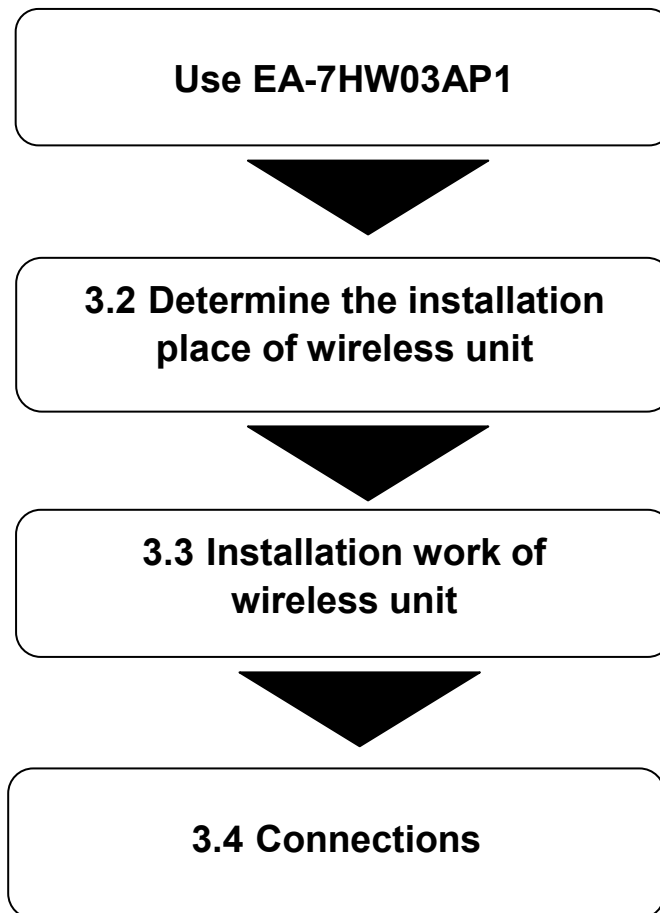

3.2. Determine the installation place of wireless unit

- EA-7HW03AP1 can be installed on a wall, on a ceiling and at back of ceiling using the provided mounter.
- The wireless unit shall be installed on a place having an enough strength to hold the unit and flat surface. Weight of the main unit of the wireless unit is approx.990 g.
- The wireless unit shall be installed firmly not to loosen up and fall off due vibration and anything in future.
- Make sure that there is no factor that can affect performance of the antenna, such as a metallic or concrete obstacle, near the wireless unit.
- Read "Safety precautions" and "Precautions" carefully and determine the installation place.

3.3. Installation work of wireless unit

Refer to "1.2 Appearance/Dimensions" for the size of the wireless unit and the mounter.

1. Wall mounting

- (1) Attach the M6 screws (x4) to the rear of this product. (Recommended tightening torque: $3.0\text{N} \cdot \text{m} \pm 0.4 \text{N} \cdot \text{m}$)

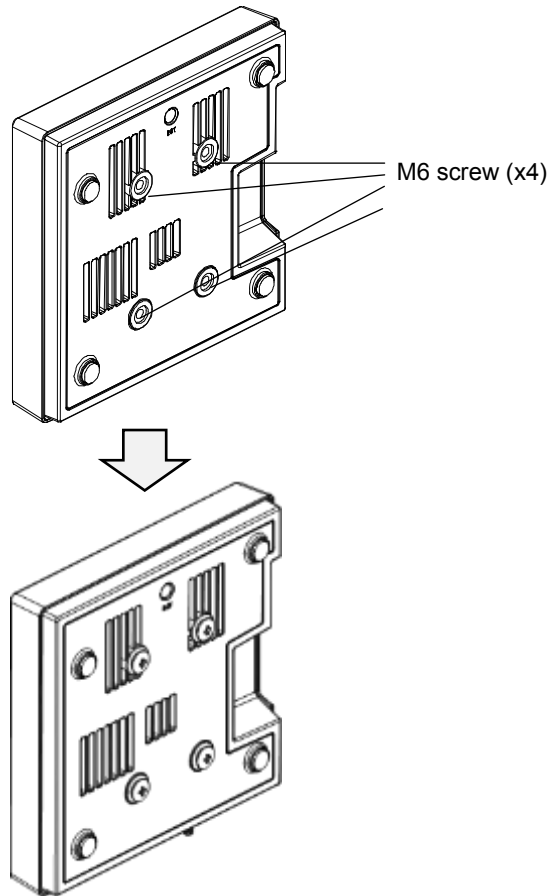

- (2) Fix the mounter after making sure that the installation place has an enough strength and flat surface of concrete, metal, wood, mortar, etc.
Fasten screws (x2) temporarily on the installation surface.
Make sure that the mounter can be installed in parallel, and then fix it firmly with 4 screws located at the upper and the lower sides.
(Recommended tightening torque: $3.0 \text{N} \cdot \text{m} \pm 0.4 \text{N} \cdot \text{m}$)

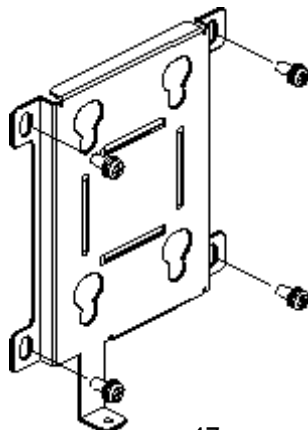

Important

Use a screw whose nominal diameter is 5 mm to fix on the installation surface.
This screw shall be prepared by the installer according to the material of the installation surface.

- (3) Fix this product onto the mouter fixed on the wall.
Hook the M6 screws (x4) on the rear into the hook holes on the mouter.

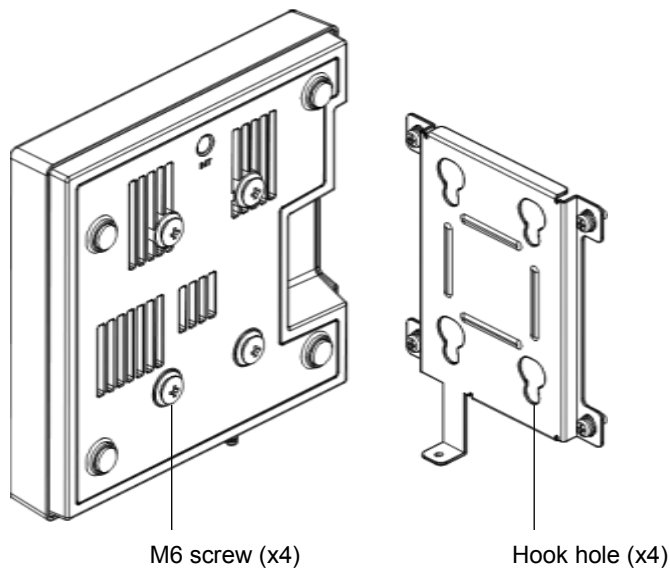

- (4) Align the hook hole on the front of the mouter and the M6 screw on the rear of this product.
- (5) Hold the both sides of this product and slide it downward.
- (6) Thread the M3 screw into the fixing hole firmly. (Recommended tightening torque: $0.6 \text{ N}\cdot\text{m} \pm 0.1 \text{ N}\cdot\text{m}$)

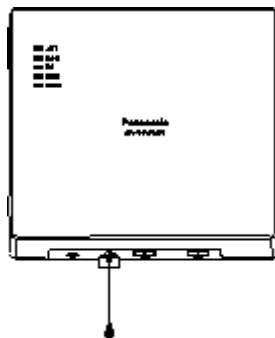

* To remove the mounter, hold the both sides of this product and slide it upward.

2. Flat installation

Install on a flat place.

3.4. Connections

3.4.1. Connection to network

Connect an Ethernet cable (enhanced category 5 or better) to the ETH1 (PoE) connector or the ETH2 connector on the left side of this product.

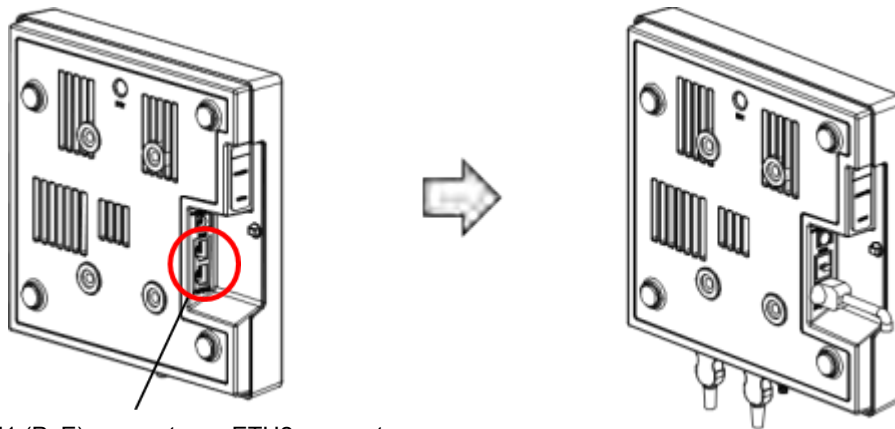

ETH1 (PoE) connector or ETH2 connector

3.4.2. Power feeding from AC adapter

Firmly connect the DC plug of the provided AC adapter to the DC IN connector in the external interface section of this product.

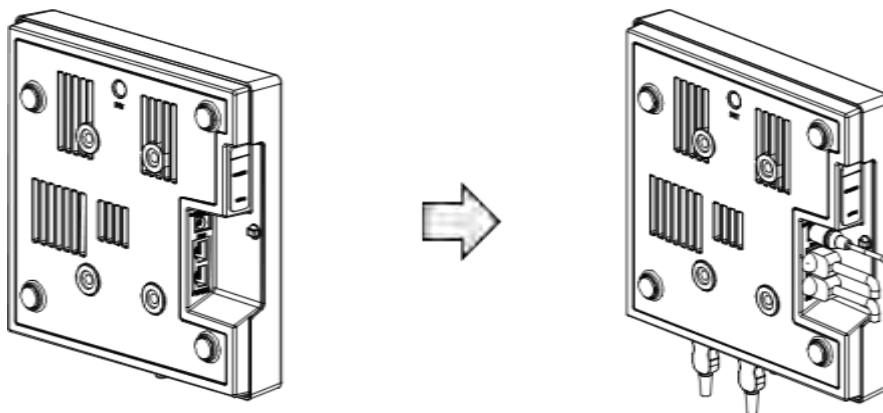

1. Power feeding from PoE unit

Power will be fed from PoE power feeding equipment compliant with IEEE802.3af or IEEE802.3at. In this section, descriptions of how to feed power from PoE injector are provided.

By following the procedures below, connect the PoE injector and other cables.

- (1) Insert the plug of the Ethernet cable connected with the ETH1 (PoE) connector of the wireless unit to the "DATA & POWER OUT" port of the PoE injector until the "click" sound is heard.
- (2) Connect the provided power cable to the PoE injector.
- (3) Insert the power plug of the PoE injector to an outlet of 100 V AC. (The POWER LED will light yellow and then turn to green.)
- (4) Insert the plug of the Ethernet cable connected with a host network device to the "DATA IN" port of the PoE injector until the "click" sound is heard.

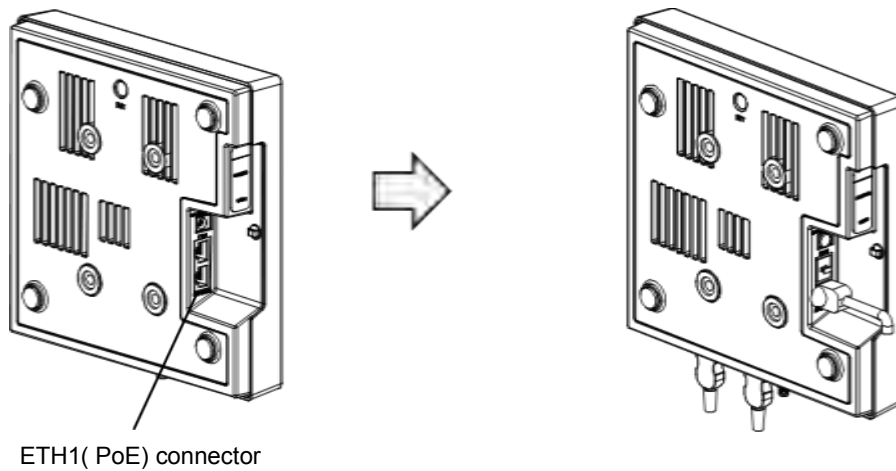

Important

- The wiring length from the wireless unit to the host network device shall be up to 100 m (total).
- Do not pull the connected cables with a strong force.
- Do not place a heavy object on the PoE injector.
- Do not perform wiring of the connection cables and the Ethernet cable connection section in a place where water can damage them.

3.5. Initialization

It is possible to initialize (reset the setting data and the log data to the default) the wireless unit directly without using the initialization command.

1. Hold down the INIT switch using something that has a needle-like tip such as a skewer.
* Start working after removing static electricity.
2. Connect the AC adapter and the PoE injector, and then turn on the power.
3. Wait until the ACT LED starts blinking red.
4. When the ACT LED blinking red turns to blinking green, release the INIT switch.

Default of each interface after the initialization

Network interface	Default	Remarks
Wi-Fi interface (2.4G)	Off	Default after validating the interface 2412MHz, HT40
Wi-Fi interface (5G)	Off	Default after validating the interface 5180MHz, HT80
Ethernet1 (ETH1)	-	Default fixed IP (192.168.0.3/24) (Access will become available after approx. 90 seconds from the start-up.)
Ethernet2 (ETH2)	-	Default fixed IP (192.168.0.3/24) (Access will become available after approx. 90 seconds from the start-up.)

3.6. Alarm display by self-test

This product will automatically perform self-test upon the start-up. If an error is detected, the detected alarm will be indicated by the LED display on the product. When an error is detected on the self-test, turn off the power and contact the dealer from whom you purchased this product.

EA-7HW03AP1 Self-test alarm display

Alarm type	ACT	2.4G	5G	ETH1	ETH2
FROM check error	Lights red	Off	Off	-	-
RAM check error	Lights red	Off	Off	-	-
Manufacturing number error	Blinks red	Off	Off	-	-
MAC address error	Blinks red	Off	Off	-	-

Notice

- As the test of LED, all LEDs except the LINK LED will light. After that, all LEDs except the LINK LED will be off until the self-test finishes. Refer to "1.3 Major operating controls and their functions" for descriptions of LED display when the self-test completed correctly.
- When started up by turning on the INIT switch (initialized state), the ACT LED will start blinking.
- The status of ETH1 LED/ETH2 LED will change according to the connection status of Ethernet (power supply state),

Chapter 4. Setting method

4.1. Setting of PC for Web console use

The following are descriptions of how to connect a PC for web console use and of how to configure the setting of this product.

Recommended environment of PC for Web console use

OS and TCP/IP software	Microsoft® Windows® 7 Microsoft® Windows® 8.1 TCP/IP software is provided with OS. It is unnecessary to prepare separately.
Resolution	1024 x 768 pixels or more
LAN card	An Ethernet port is required on the PC in use to connect this product to the PC. When using a LAN card, prepare one that can be installed on your PC.
Web browser	When using web console to configure the settings of this product, prepare the following web browser. Microsoft® Internet Explorer® 11 or later * Access to the same AP from multiple web browsers is not supported.

■ Preparation of LAN card

Make sure that the PC for web console use has an Ethernet port. No Ethernet port is found.

It is required to install a LAN card on the PC. When newly installing a LAN card, installation of software for LAN card (network driver) is required. Configure the settings correctly by following the manuals provided with the PC and the LAN card.

■ TCP/IP protocol setting

When using the web console, it is required to complete the IP address and the subnet mask setting using the PC for web console use.

The setting procedure varies depending on OS of the PC. On this document, descriptions are provided supposing Microsoft® Windows® 8.1 is installed on the PC.

Configure the TCP/IP setting of the PC.

- **Setup procedure**

Step 1

Open the "Control Panel" window and click [Network and Sharing Center].

Step 2

Click [Change adapter settings]. The "Network Connections" window will be displayed.

Step 3

Double click [Local Area Connection]. The "Local Area Connection Status" window will be displayed.

Step 4

Check if "Internet Protocol Version 4 (TCP/IPv4)" is included in the displayed list.

If "Internet Protocol Version 4 (TCP/IPv4)" is not in the list, it is necessary to install TCP/IP. Install it by referring to the manual of Microsoft® Windows® 8.1.

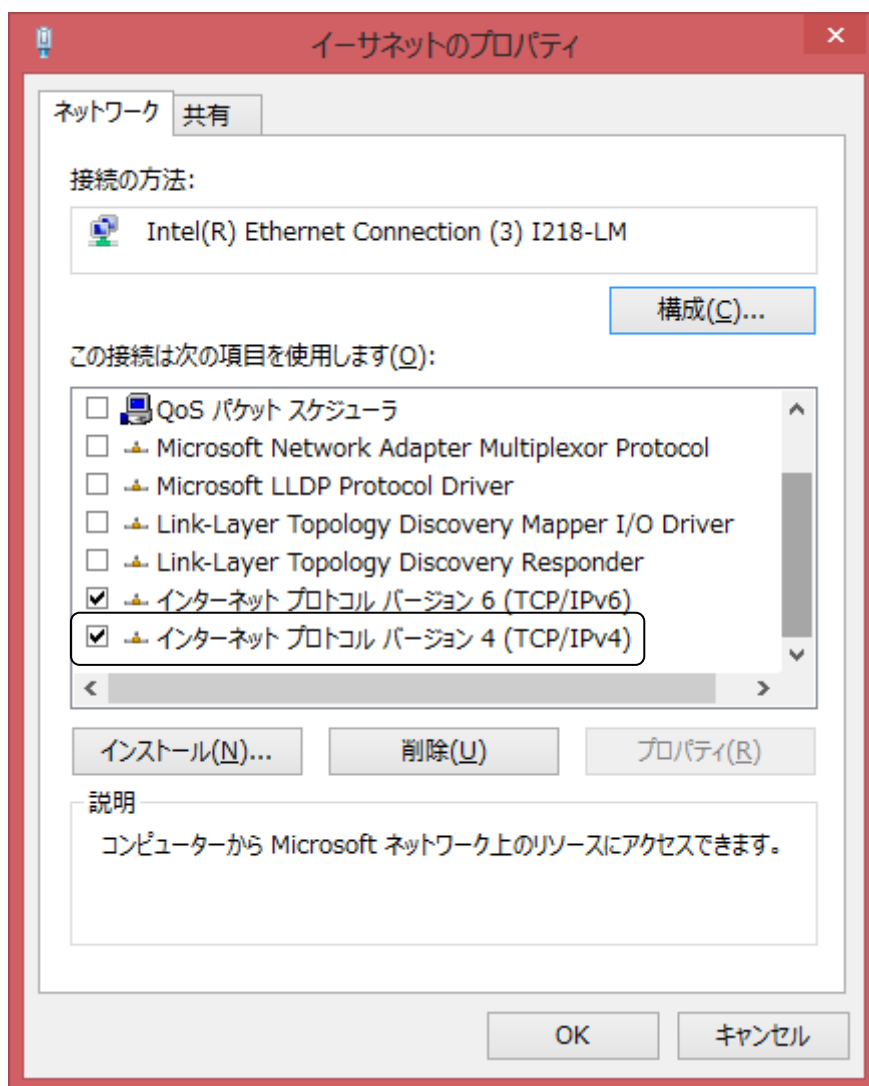

Step 5

Click to select "Internet Protocol Version4 (TCP/IPv4)", and then click [Properties].

Step 6

Set the IP address of the PC. The IP address and the subnet mask shall be matched with the IP address and the subnet mask set for this product. Refer to the following for the default IP address of this product.

IP address	192.168.0.3
Subnet mask	255.255.255.0
Default gateway	192.168.0.1

The following are examples to explain how to configure the settings.

- Select "Use the following IP address".
- Enter "192.168.0.253" for the IP address.
- Enter "255.255.255.0" for the subnet mask.
- No entry is needed for the default gateway.

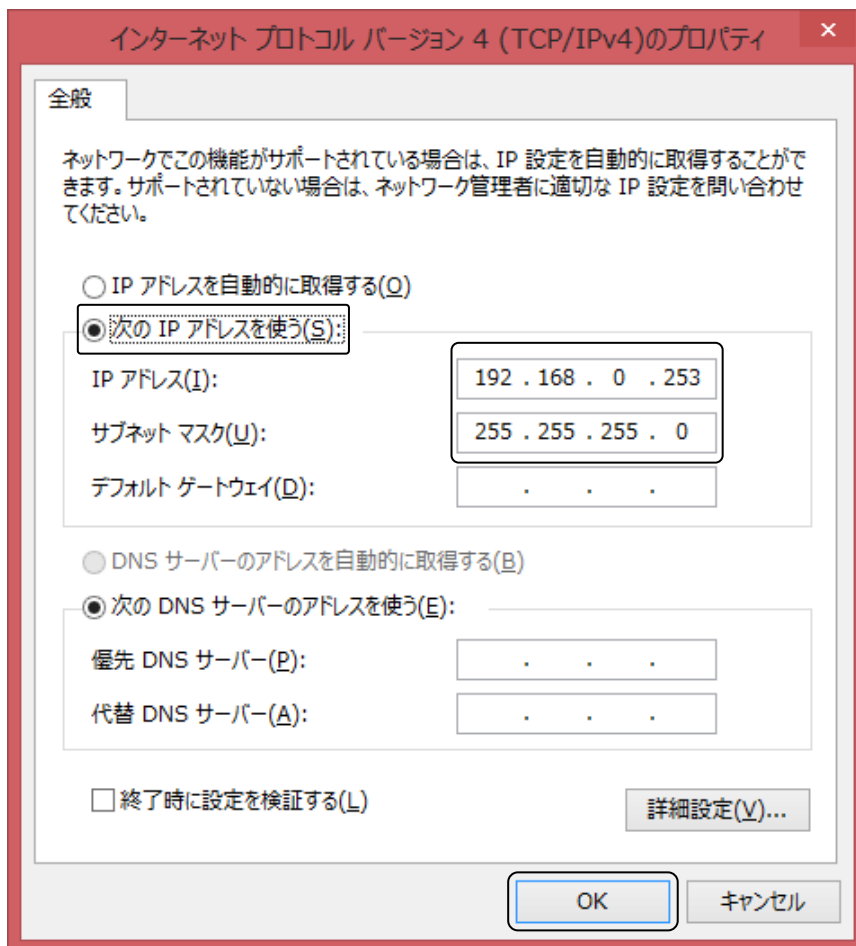

Step 7

Click [OK] and return to "Properties".

Step 8

Click the [Close] button to return to "Local Area Connection Status".

Step 9

Click the [Close] button.

Preparation of web browser

The setting procedure varies depending on OS of the PC. On this document, descriptions are provided supposing Microsoft® Windows® 8.1 is installed on the PC.

Setup procedure

Step 1

Open the "Control Panel" window and click [Internet Options]. The "Internet Properties" window will be displayed.

Step 2

Select the [Connections] tab and click [LAN settings].

Step 3

Confirm that the "Use a proxy server for your LAN" check box is unchecked.

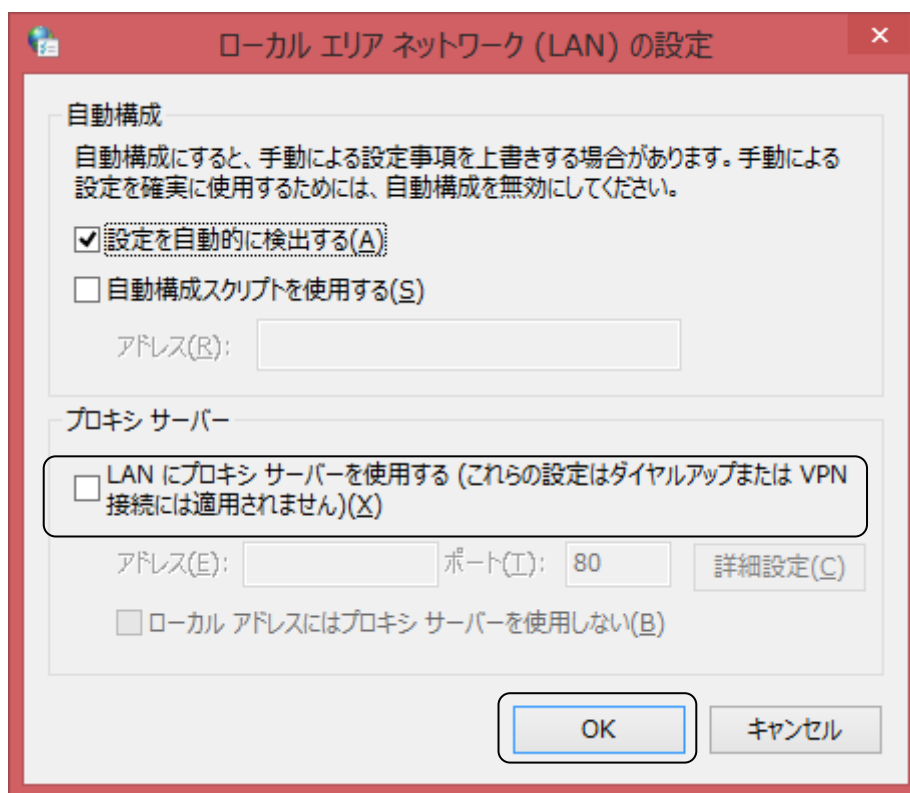

Local Area Network (LAN) Settings

When using a proxy server, configure not to use the proxy server for this product.

Step 4

Open the "Control Panel" window and click [Internet Options]. The "Internet Properties" window will be displayed.

Step 5

Select the [Connections] tab and click [LAN settings].

Step 6

Check the "Use a proxy server for your LAN" check box and click [Advanced].

Step 7

Enter the IP address of this product to the "Do not use proxy for addresses beginning with" box under "Exceptions".

Step 8

Click the [OK] button to return to "Local Area Network (LAN) Settings".

Step 9

Click the [OK] button and return to "Internet Properties".

Step 10

Click the [OK] button.

Chapter 5. Response to error occurrence

5.1. Troubleshooting

The following are descriptions of how to connect a PC for web console use and of how to configure the setting of this product.

Refer to the following descriptions when an error occurred in this product.

Symptom		Inspection	Solution
The ACT LED does not light.		Isn't the Ethernet cable detached?	Connect ETH to the "DATA & POWER OUT" port of the PoE injector when feeding power from PoE. (Connect to the power feeding port of the PoE power feeding equipment.)
		Isn't the DC plug of the AC adapter detached?	Connect the DC plug to the DC IN port.
		Isn't the power cord detached from of the AC adapter/PoE injector ?	Connect the power cord to the AC adapter/PoE injector.
Cannot establish the communication.	Cannot transmit/receive data.	Isn't the Ethernet cable detached?	Connect the Ethernet cable correctly.
		Doesn't the Ethernet cable have a breakage?	Check if the Ethernet cable works correctly, or replace it.
		Isn't there any obstacle blocking communication between the wireless unit and the terminal?	Remove the obstacle or change the installation place of the wireless unit.
	Cannot search this product from the Wi-Fi terminal.	Isn't the setting configured to hide SSID?	Follow Use's Guide to cancel the setting to hide SSID or configure the settings to make possible to connect with the Wi-Fi terminal in advance.
		Isn't power supplied to the wireless unit?	Make sure that the power of the PoE power feeding equipment or the DC power supply unit is turned on.
Others	Cannot log in from the console.	Is the setting of the communication software of the console correctly configured?	Follow Use's Guide and configure the setting of the communication software.
		Are the login name and password correct?	Retry to log in using the correct login name and password.
	The setting is not applied to this product.	Check if the settings are appropriate.	Follow Use's Guide and apply the corresponding setting data using the reset command.

Panasonic System Networks Co.,Ltd

1-62, 4-chome, Minoshima, Hakata-ku, Fukuoka 812-8531, Japan

©Panasonic System Networks Co., Ltd. 2015

xxxx-xxxx